

# FCC TEST REPORT

For

USA Wholesale Suppliers

MINI PC

Model No.: Q3, Q1, Q2

Prepared For : USA Wholesale Suppliers

Address : 16410 ne 19th ave North Miami beach fl. 33162 USA

Prepared By : Shenzhen Anbotek Compliance Laboratory Limited

Address : 1/F., Building 1, SEC Industrial Park, No.0409 Qianhai Road, Nanshan District, Shenzhen, Guangdong, China

Tel: (86) 755-26066544 Fax: (86) 755-26014772

Report Number : R0217060035W2

Date of Test : Aug. 30~Sept. 06, 2017

Date of Report : Sept. 06, 2017

# Contents

1. General Information.....	5
1.1. Client Information.....	5
1.2. Description of Device (EUT).....	5
1.3. Auxiliary Equipment Used During Test.....	5
1.4. Description of Test Modes.....	6
1.5. List of channels.....	7
1.6. Description Of Test Setup.....	8
1.7. Test Equipment List.....	9
1.8. Measurement Uncertainty.....	9
1.9. Description of Test Facility.....	10
2. Summary of Test Results.....	11
3. Conducted Emission Test.....	12
3.1. Test Standard and Limit.....	12
3.2. Test Setup.....	12
3.3. Test Procedure.....	12
3.4. Test Data.....	12
4. Radiation Spurious Emission and Band Edge.....	17
4.1. Test Standard and Limit.....	17
4.2. Test Setup.....	17
4.3. Test Procedure.....	18
4.4. Test Data.....	19
5. Maximum Peak Output Power Test.....	29
5.1. Test Standard and Limit.....	29
5.2. Test Setup.....	29
5.3. Test Procedure.....	29
5.4. Test Data.....	29
6. 6DB Occupy Bandwidth Test.....	33
6.1. Test Standard and Limit.....	33
6.2. Test Setup.....	33
6.3. Test Procedure.....	33
6.4. Test Data.....	33
7. Power Spectral Density Test.....	41
7.1. Test Standard and Limit.....	41
7.2. Test Setup.....	41
7.3. Test Procedure.....	41
7.4. Test Data.....	41
8. 100kHz Bandwidth of Frequency Band Edge Requirement.....	48
8.1. Test Standard and Limit.....	48
8.2. Test Setup.....	48
8.3. Test Procedure.....	48
8.4. Test Data.....	48
9. Antenna Requirement.....	60

9.1. Test Standard and Requirement..... 60  
9.2. Antenna Connected Construction..... 60  
APPENDIX I -- TEST SETUP PHOTOGRAPH..... 61  
APPENDIX II -- EXTERNAL PHOTOGRAPH..... 62  
APPENDIX III -- INTERNAL PHOTOGRAPH..... 63



# TEST REPORT

Applicant : USA Wholesale Suppliers  
Manufacturer : Shenzhen Shiningworth Technology Co., Ltd.  
Product Name : MINI PC  
Model No. : Q3, Q1, Q2  
Trade Mark : Matricom  
Rating(s) : Input: AC 100-240V~50/60Hz 0.5A  
: Output: DC 5V 2A

**Test Standard(s) : FCC Part15 Subpart C 2016, Section 15.247**

**Test Method(s) : ANSI C63.10: 2013, KDB558074 D01 DTS Meas Guidance v04**

The device described above is tested by Shenzhen Anbotek Compliance Laboratory Limited to determine the maximum emission levels emanating from the device and the severe levels of the device can endure and its performance criterion. The measurement results are contained in this test report and Shenzhen Anbotek Compliance Laboratory Limited is assumed full of responsibility for the accuracy and completeness of these measurements. Also, this report shows that the EUT (Equipment Under Test) is technically compliant with the FCC Part 15 Subpart C requirements.

This report applies to above tested sample only and shall not be reproduced in part without written approval of Shenzhen Anbotek Compliance Laboratory Limited.

Date of Test : Aug. 30~Sept. 06, 2017

Prepared by :



*Winkey Wang*

(Tested Engineer / Winkey Wang)

Reviewer :

*Tangcy. T.*

(Project Manager /Tangcy. T)

Approved & Authorized Signer :

*Tom Chen*

(Manager / Tom Chen)

## 1. General Information

### 1.1. Client Information

Applicant	:	USA Wholesale Suppliers
Address	:	16410 ne 19th ave North Miami beach fl. 33162 USA
Manufacturer	:	USA Wholesale Suppliers
Address	:	16410 ne 19th ave North Miami beach fl. 33162 USA

### 1.2. Description of Device (EUT)

Product Name	:	MINI PC	
Model No.	:	Q3, Q1, Q2 (Note: All samples are the same except the model number, color and screen size, so we prepare “Q3” for test only.)	
Trade Mark	:	Matricom	
Test Power Supply	:	AC 120V, 60Hz via adapter/AC 240V, 60Hz via adapter	
Product Description	:	Operation Frequency:	WiFi 2.4G 802.11b/ g/ n(HT20) 2412-2462MHz WiFi 2.4G 802.11n(HT40) 2422-2452MHz BT 4.1: 2402MHz~2480MHz
		Number of Channel:	WiFi 2.4G: 11 Channels for 802.11b/ g/ n(HT20) WiFi 2.4G: 7 Channels for 802.11n(HT40) BT 4.1: 79 Channels
		Modulation Type:	WiFi 2.4G: 802.11b CCK; 802.11g/n OFDM BT 4.1: GFSK, $\pi/4$ -DQPSK, 8-DPSK
		Antenna Type:	PIFA Antenna
		Antenna Gain(Peak):	2.0 dBi
<p><b>Remark:</b> 1)For a more detailed features description, please refer to the manufacturer’s specifications or the User’s Manual.          2)This report is for WiFi 2.4G</p>			

### 1.3. Auxiliary Equipment Used During Test

TV	:	Manufacturer: SONY
		M/N: KDL-26EX550 S/N: 1012240 CE , FCC: DOC
Adapter	:	Manufacturer: ZTE
		M/N: STC-A2050I1000USBA-C S/N: 201202102100876 Input: 100-240V~50/60Hz 0.3A Output: DC 5V, 1000mA

### 1.4. Description of Test Modes

To investigate the maximum EMI emission characteristics generated from EUT, the test system was pre-scanning tested based on the consideration of following EUT operation mode or test configuration mode which possibly have effect on EMI emission level. Each of these EUT operation mode(s) or test configuration mode(s) mentioned above was evaluated respectively.

#### **RADIATED EMISSION TEST (BELOW 1GHz):**

Pre-Scan has been conducted to determine the worst-case mode from all possible combinations between available modulations, data rates, XYZ axis and antenna ports (if EUT with antenna diversity architecture). Following channel(s) was (were) selected for the final test as listed below.

Mode	Available Channel	Test Channel	Modulation Tech.	Modulation Type	Data Rate (Mbps)
802.11b	1 to 11	1	CCK	DBPSK	1.0

For the test results, only the worst case was shown in test report.

#### **RADIATED EMISSION TEST (ABOVE 1GHz):**

Pre-Scan has been conducted to determine the worst-case mode from all possible combinations between available modulations, data rates, XYZ axis and antenna ports (if EUT with antenna diversity architecture). Following channel(s) was (were) selected for the final test as listed below.

Mode	Available Channel	Test Channel	Modulation Tech.	Modulation Type	Data Rate (Mbps)
802.11b	1 to 11	1, 6, 11	CCK	DBPSK	1.0
802.11g	1 to 11	1, 6, 11	OFDM	BPSK	6.0
802.11n HT20	1 to 11	1, 6, 11	OFDM	BPSK	6.5
802.11n HT40	3 to 9	3, 6, 9	OFDM	BPSK	13.5

#### **POWER LINE CONDUCTED EMISSION TEST:**

The EUT was tested with the following mode

EUT configure mode	Test Mode
-	Keeping TX mode

#### **BANDEDGE MEASUREMENT:**

Pre-Scan has been conducted to determine the worst-case mode from all possible combinations between available modulations, data rates and antenna ports (if EUT with antenna diversity architecture). Following channel(s) was (were) selected for the final test as listed below.

Mode	Available Channel	Test Channel	Modulation Tech.	Modulation Type	Data Rate (Mbps)
802.11b	1 to 11	1, 11	CCK	DBPSK	1.0
802.11g	1 to 11	1, 11	OFDM	BPSK	6.0
802.11n HT20	1 to 11	1, 11	OFDM	BPSK	6.5
802.11n HT40	3 to 9	3, 9	OFDM	BPSK	13.5

**ANTENNA PORT CONDUCTED MEASUREMENT:**

This item includes all test value of each mode, but only includes spectrum plot of worst value of each mode.

Pre-Scan has been conducted to determine the worst-case mode from all possible combinations between available modulations, data rates and antenna ports (if EUT with antenna diversity architecture).

Following channel(s) was (were) selected for the final test as listed below.

Mode	Available Channel	Test Channel	Modulation Tech.	Modulation Type	Data Rate (Mbps)
802.11b	1 to 11	1, 6, 11	CCK	DBPSK	1.0
802.11g	1 to 11	1, 6, 11	OFDM	BPSK	6.0
802.11n HT20	1 to 11	1, 6, 11	OFDM	BPSK	6.5
802.11n HT40	3 to 9	3,6, 9	OFDM	BPSK	13.5

**1.5. List of channels**

Channel	Freq. (MHz)	Channel	Freq. (MHz)	Channel	Freq. (MHz)	Channel	Freq. (MHz)
01	2412	04	2427	07	2442	10	2457
02	2417	05	2432	08	2447	11	2462
03	2422	06	2437	09	2452		

### 1.6. Description Of Test Setup

CE

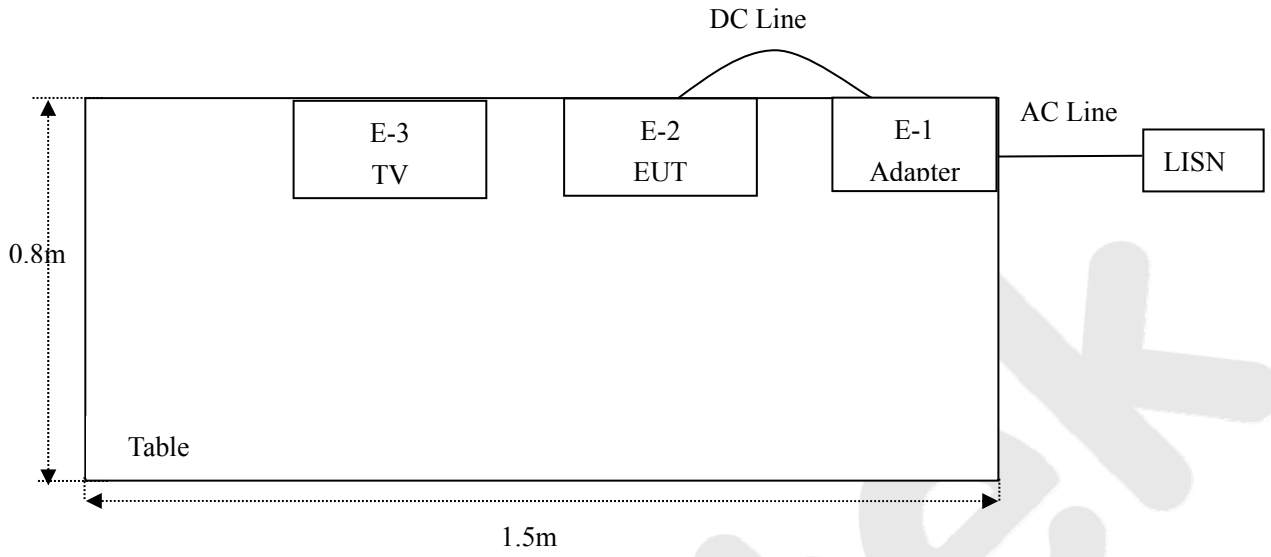

RE

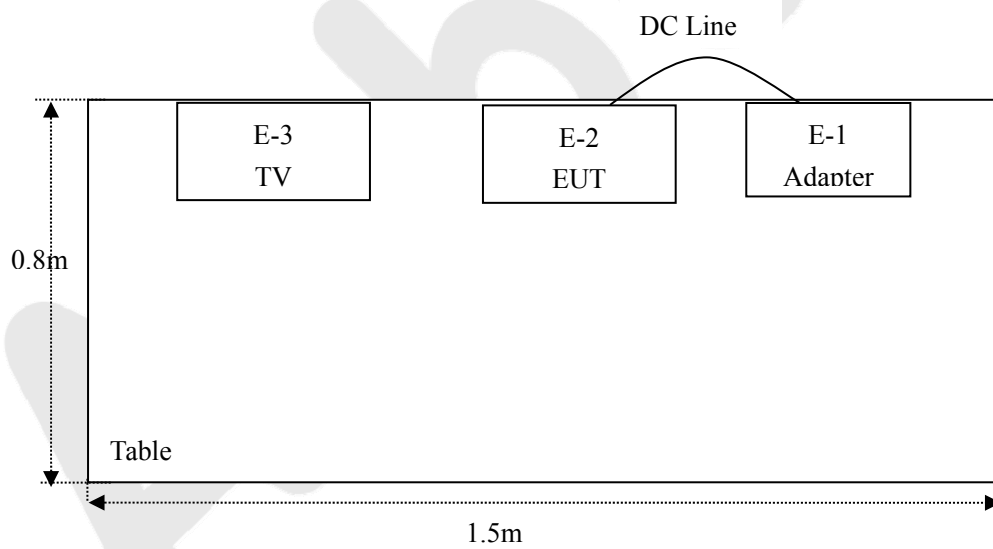



### 1.7. Test Equipment List

Item	Equipment	Manufacturer	Model No.	Serial No.	Last Cal.	Cal. Interval
1.	L.I.S.N. Artificial Mains Network	Rohde & Schwarz	ENV216	100055	May 27, 2017	1 Year
2.	EMI Test Receiver	Rohde & Schwarz	ESCI	100627	May 27, 2017	1 Year
3.	RF Switching Unit	Compliance Direction	RSU-M2	38303	May 27, 2017	1 Year
4.	Spectrum Analysis	Agilent	E4407B	US39390582	May 27, 2017	1 Year
5.	Preamplifier	SKET Electronic	BK1G18G30 D	KD17503	May 27, 2017	1 Year
6.	EMI Test Receiver	Rohde & Schwarz	ESPI	101604	May 27, 2017	1 Year
7.	Double Ridged Horn Antenna	Instruments corporation	GTH-0118	351600	May 31, 2017	1 Year
8.	Bilog Broadband Antenna	Schwarzbeck	VULB9163	VULB 9163-289	May 31, 2017	1 Year
9.	Loop Antenna	Schwarzbeck	HFH2-Z2	100047	Apr. 03, 2017	1 Year
10.	Pre-amplifier	SONOMA	310N	186860	May 27, 2017	1 Year
11.	EMI Test Software EZ-EMC	SHURPLE	N/A	N/A	N/A	N/A
12.	Power Sensor	DAER	RPR3006W	15100041SN045	May 27, 2017	1 Year
13.	Power Sensor	DAER	RPR3006W	15100041SN046	May 27, 2017	1 Year
14.	MXA Spectrum Analysis	Agilent	N9020A	MY51170037	May 27, 2017	1 Year
15.	MXG RF Vector Signal Generator	Agilent	N5182A	MY48180656	May 27, 2017	1 Year
16.	Signal Generator	Agilent	E4421B	MY41000743	May 27, 2017	1 Year
17.	DC Power supply	IVYTECH	IV6003	1601D6030007	May 26, 2017	1 Year
18.	TEMP&HUMI PROGRAMMABLE CHAMBER	Sertep	ZJ-HWHS80 B	ZJ-17042804	Mar. 03, 2017	1 Year

### 1.8. Measurement Uncertainty

Radiation Uncertainty	:	Ur = 4.1 dB (Horizontal)
		Ur = 4.3 dB (Vertical)
Conduction Uncertainty	:	Uc = 3.4dB

## 1.9. Description of Test Facility

The test facility is recognized, certified, or accredited by the following organizations:

### **FCC-Designation No.: CN5023**

Shenzhen Anbotek Compliance Laboratory Limited, EMC Laboratory has been registered and fully described in a report filed with the (FCC) Federal Communications Commission. The acceptance letter from the FCC is maintained in our files. Designation CN5023, July 31, 2017.

### **ISED-Registration No.: 8058A-1**

Shenzhen Anbotek Compliance Laboratory Limited, EMC Laboratory has been registered and fully described in a report filed with the (ISED) Innovation, Science and Economic Development Canada. The acceptance letter from the ISED is maintained in our files. Registration 8058A-1, June 13, 2016.

### **Test Location**

All Emissions tests were performed at

Shenzhen Anbotek Compliance Laboratory Limited. at 1/F., Building 1, SEC Industrial Park, No.0409 Qianhai Road, Nanshan District, Shenzhen, Guangdong, China

All Emissions tests (Above 18GHz) were performed at  
MRT Technology (Suzhou) Co., Ltd.

D8 Building, Youxin Industrial Park, No. 2 Tina'ed Wuzhong Economic Development Zone, Suzhou, Jiangsu, China

Designation Number: CN1166

Test Firm Registration Number: 893164

## 2. Summary of Test Results

Standard Section	Test Item	Result
15.203/15.247(c)	Antenna Requirement	PASS
15.207	Conducted Emission	PASS
15.205/15.209	Spurious Emission	PASS
15.247(b)(3)	Conducted Peak Output Power	PASS
15.247(a)(2)	6dB Occupied Bandwidth	PASS
15.247(e)	Power Spectral Density	PASS
15.247(d)	Band Edge	PASS
<b>Remark:</b> "N/A" is an abbreviation for Not Applicable.		

### 3. Conducted Emission Test

#### 3.1. Test Standard and Limit

Test Standard	FCC Part15 Section 15.207		
Test Limit	Frequency	Maximum RF Line Voltage (dBuV)	
		Quasi-peak Level	Average Level
	150kHz~500kHz	66 ~ 56 *	56 ~ 46 *
	500kHz~5MHz	56	46
5MHz~30MHz	60	50	

**Remark:** (1) \*Decreasing linearly with logarithm of the frequency.  
(2) The lower limit shall apply at the transition frequency.

#### 3.2. Test Setup

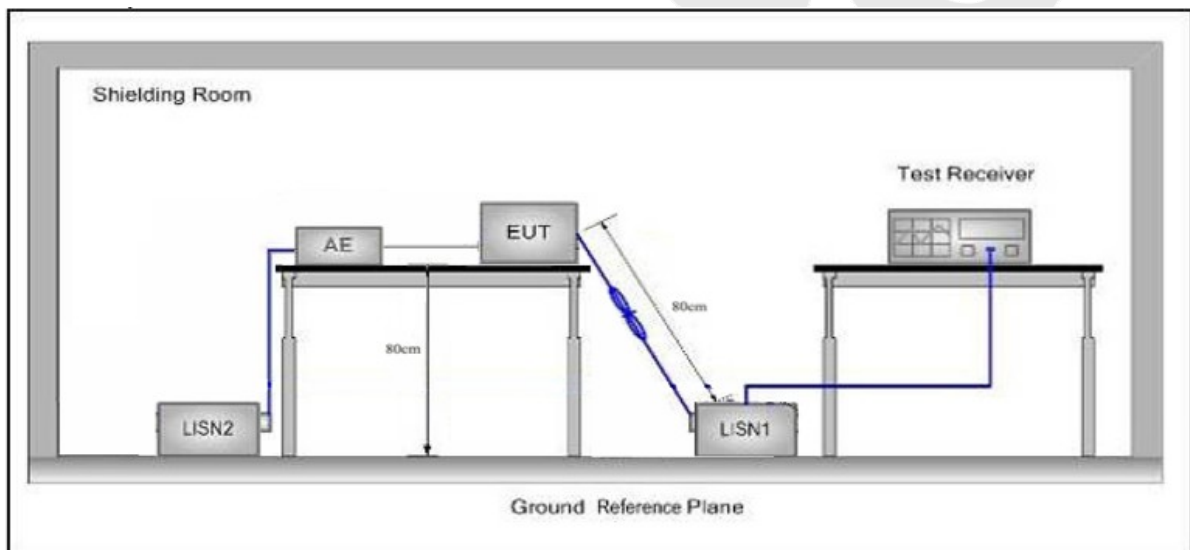

#### 3.3. Test Procedure

The EUT system is connected to the power mains through a line impedance stabilization network (L.I.S.N.). This provides a 50ohm coupling impedance for the EUT system. Please refer the block diagram of the test setup and photographs. Both sides of AC line are checked to find out the maximum conducted emission. In order to find the maximum emission levels, the relative positions of equipment and all of the interface cables shall be changed according to FCC ANSI C63.10-2013 on Conducted Emission Measurement.

The bandwidth of test receiver (ESCI) set at 9kHz.

The frequency range from 150kHz to 30MHz is checked.

#### 3.4. Test Data

Please to see the following pages

**Conducted Emission Test Data**

Test Site: 1# Shielded Room  
 Operating Condition: Keeping TX mode  
 Test Specification: AC 120V, 60Hz via adapter  
 Comment: Live Line  
 Tem.:25°C Hum.:50%

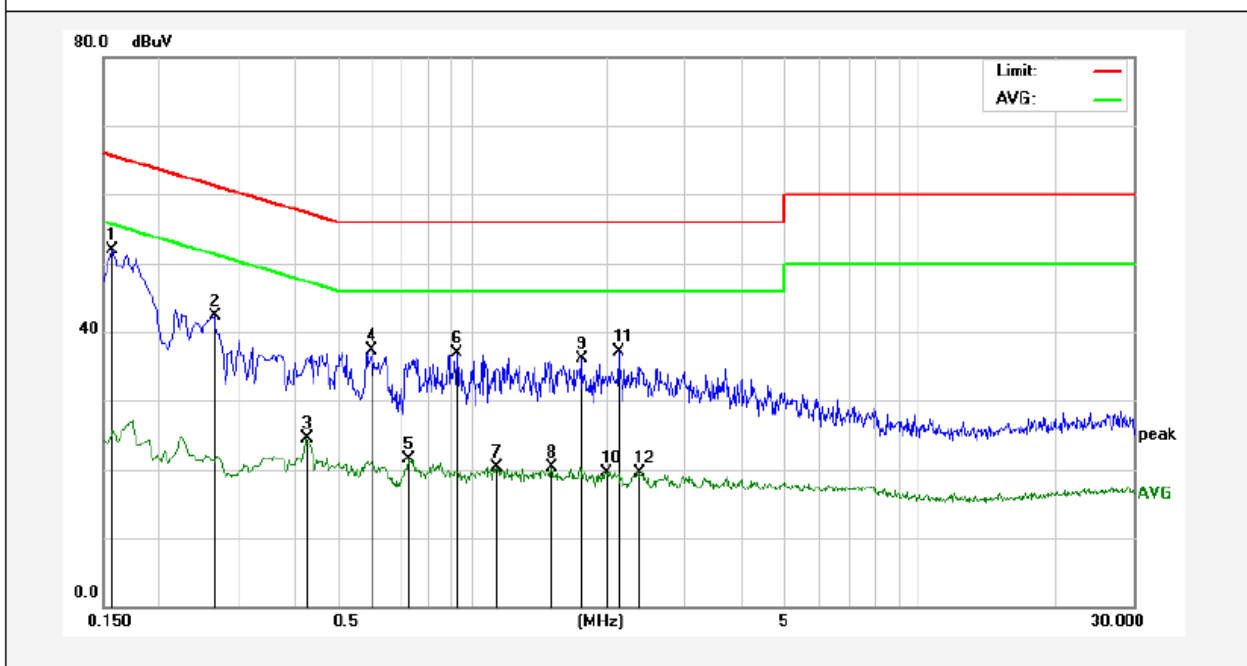

No.	Freq. (MHz)	Reading (dBuV)	Factor (dB)	Result (dBuV)	Limit dBuV	Over Limit (dB)	Detector	Remark
1	0.1580	32.02	19.90	51.92	65.56	-13.64	QP	
2	0.2660	22.39	19.89	42.28	61.24	-18.96	QP	
3	0.4260	4.46	19.95	24.41	47.33	-22.92	AVG	
4	0.5980	17.22	20.01	37.23	56.00	-18.77	QP	
5	0.7220	1.37	20.05	21.42	46.00	-24.58	AVG	
6	0.9260	16.75	20.10	36.85	56.00	-19.15	QP	
7	1.1380	0.27	20.12	20.39	46.00	-25.61	AVG	
8	1.5100	0.17	20.13	20.30	46.00	-25.70	AVG	
9	1.7620	15.95	20.14	36.09	56.00	-19.91	QP	
10	1.9940	-0.59	20.14	19.55	46.00	-26.45	AVG	
11	2.1260	17.06	20.14	37.20	56.00	-18.80	QP	
12	2.3780	-0.65	20.15	19.50	46.00	-26.50	AVG	

**Conducted Emission Test Data**

Test Site: 1# Shielded Room  
 Operating Condition: Keeping TX mode  
 Test Specification: AC 120V, 60Hz via adapter  
 Comment: Neutral Line  
 Tem.:25°C Hum.:50%

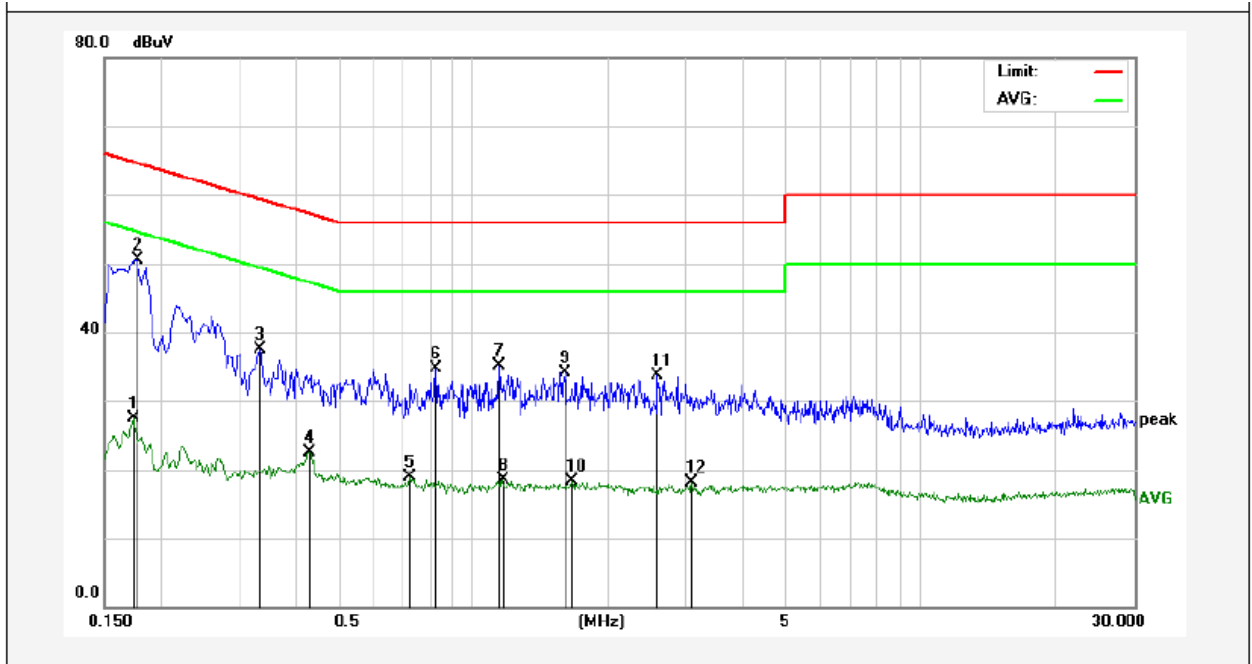

No.	Freq. (MHz)	Reading (dBuV)	Factor (dB)	Result (dBuV)	Limit dBuV	Over Limit (dB)	Detector	Remark
1	0.1740	7.60	19.90	27.50	54.76	-27.26	AVG	
2	0.1780	30.66	19.90	50.56	64.57	-14.01	QP	
3	0.3339	17.50	19.91	37.41	59.35	-21.94	QP	
4	0.4300	2.58	19.95	22.53	47.25	-24.72	AVG	
5	0.7260	-1.20	20.05	18.85	46.00	-27.15	AVG	
6	0.8300	14.71	20.07	34.78	56.00	-21.22	QP	
7	1.1460	15.04	20.12	35.16	56.00	-20.84	QP	
8	1.1620	-1.57	20.12	18.55	46.00	-27.45	AVG	
9	1.6019	14.04	20.13	34.17	56.00	-21.83	QP	
10	1.6700	-1.80	20.13	18.33	46.00	-27.67	AVG	
11	2.5900	13.53	20.15	33.68	56.00	-22.32	QP	
12	3.0860	-2.14	20.16	18.02	46.00	-27.98	AVG	

**Conducted Emission Test Data**

Test Site: 1# Shielded Room  
 Operating Condition: Keeping TX mode  
 Test Specification: AC 240V, 60Hz via adapter  
 Comment: Live Line  
 Tem.:25°C Hum.:50%

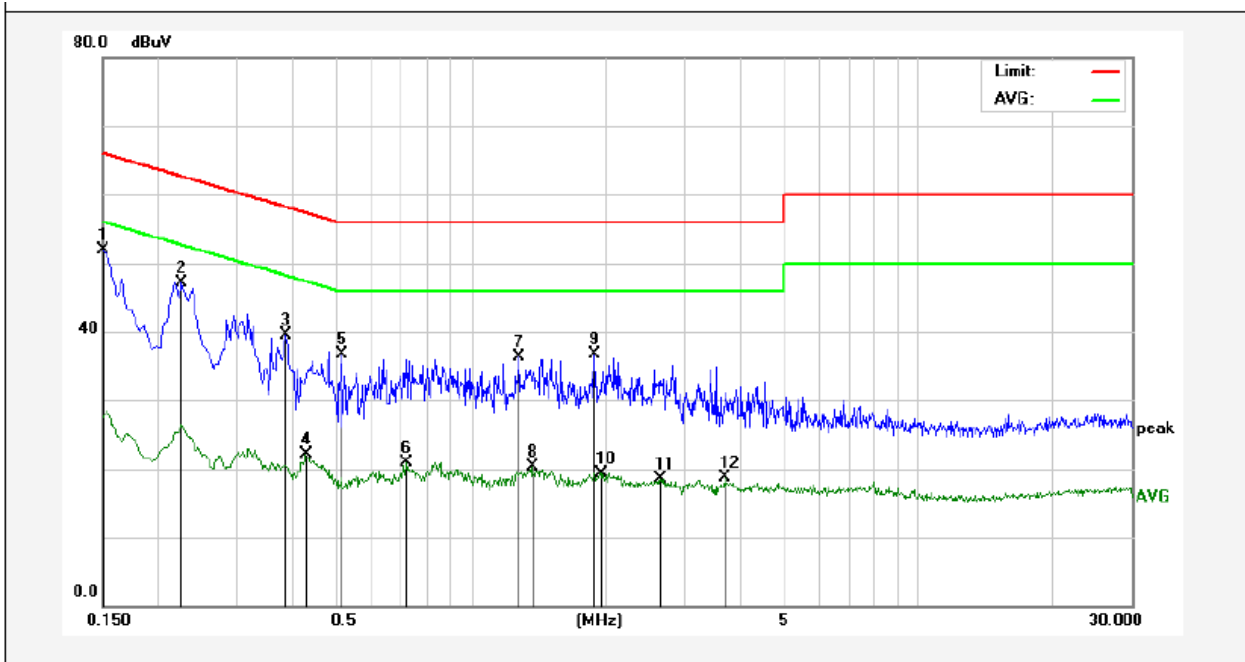

No.	Freq. (MHz)	Reading (dBuV)	Factor (dB)	Result (dBuV)	Limit dBuV	Over Limit (dB)	Detector	Remark
1	0.1500	31.96	19.90	51.86	65.99	-14.13	QP	
2	0.2260	27.17	19.89	47.06	62.59	-15.53	QP	
3	0.3860	19.52	19.93	39.45	58.15	-18.70	QP	
4	0.4260	2.20	19.95	22.15	47.33	-25.18	AVG	
5	0.5140	16.73	19.98	36.71	56.00	-19.29	QP	
6	0.7180	0.90	20.04	20.94	46.00	-25.06	AVG	
7	1.2860	16.09	20.13	36.22	56.00	-19.78	QP	
8	1.3700	0.14	20.13	20.27	46.00	-25.73	AVG	
9	1.8900	16.47	20.14	36.61	56.00	-19.39	QP	
10	1.9540	-0.76	20.14	19.38	46.00	-26.62	AVG	
11	2.6619	-1.61	20.15	18.54	46.00	-27.46	AVG	
12	3.6980	-1.39	20.17	18.78	46.00	-27.22	AVG	

**Conducted Emission Test Data**

Test Site: 1# Shielded Room  
 Operating Condition: Keeping TX mode  
 Test Specification: AC 240V, 60Hz via adapter  
 Comment: Neutral Line  
 Tem.:25°C Hum.:50%

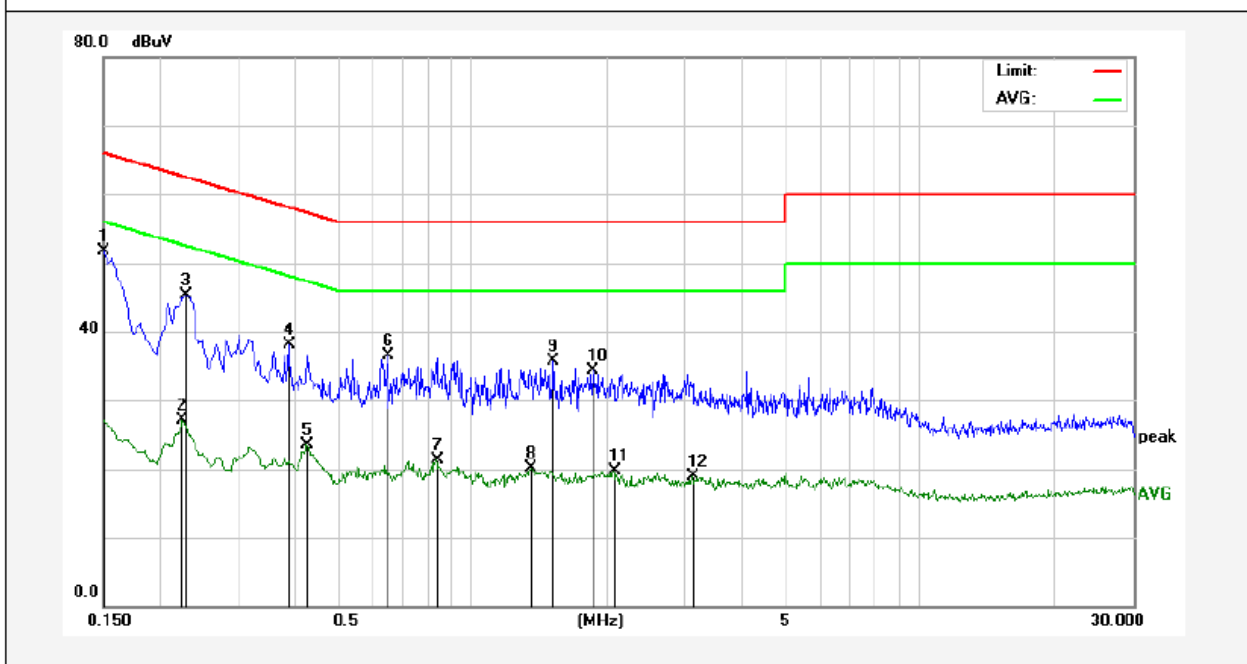

No.	Freq. (MHz)	Reading (dBuV)	Factor (dB)	Result (dBuV)	Limit dBuV	Over Limit (dB)	Detector	Remark
1	0.1500	31.86	19.90	51.76	65.99	-14.23	QP	
2	0.2260	7.13	19.89	27.02	52.59	-25.57	AVG	
3	0.2300	25.37	19.89	45.26	62.45	-17.19	QP	
4	0.3899	18.19	19.93	38.12	58.06	-19.94	QP	
5	0.4260	3.50	19.95	23.45	47.33	-23.88	AVG	
6	0.6500	16.57	20.02	36.59	56.00	-19.41	QP	
7	0.8340	1.21	20.08	21.29	46.00	-24.71	AVG	
8	1.3580	-0.02	20.13	20.11	46.00	-25.89	AVG	
9	1.5220	15.67	20.13	35.80	56.00	-20.20	QP	
10	1.8660	14.13	20.14	34.27	56.00	-21.73	QP	
11	2.0700	-0.51	20.14	19.63	46.00	-26.37	AVG	
12	3.0940	-1.21	20.16	18.95	46.00	-27.05	AVG	



## 4. Radiation Spurious Emission and Band Edge

### 4.1. Test Standard and Limit

Test Standard	FCC Part15 C Section 15.209 and 15.205				
Test Limit	Frequency (MHz)	Field strength (microvolt/meter)	Limit (dBuV/m)	Remark	Measurement distance (m)
	0.009MHz~0.490MHz	2400/F(kHz)	-	-	300
	0.490MHz-1.705MHz	24000/F(kHz)	-	-	30
	1.705MHz-30MHz	30	-	-	30
	30MHz~88MHz	100	40.0	Quasi-peak	3
	88MHz~216MHz	150	43.5	Quasi-peak	3
	216MHz~960MHz	200	46.0	Quasi-peak	3
	Above 1000MHz	500	54.0	Average	3
		-	74.0	Peak	3

**Remark:**

(1)The lower limit shall apply at the transition frequency.

(2) 15.35(b), Unless otherwise specified, the limit on peak radio frequency emissions is 20dB above the maximum permitted average emission limit applicable to the equipment under test. This peak limit applies to the total peak emission level radiated by the device.

### 4.2. Test Setup

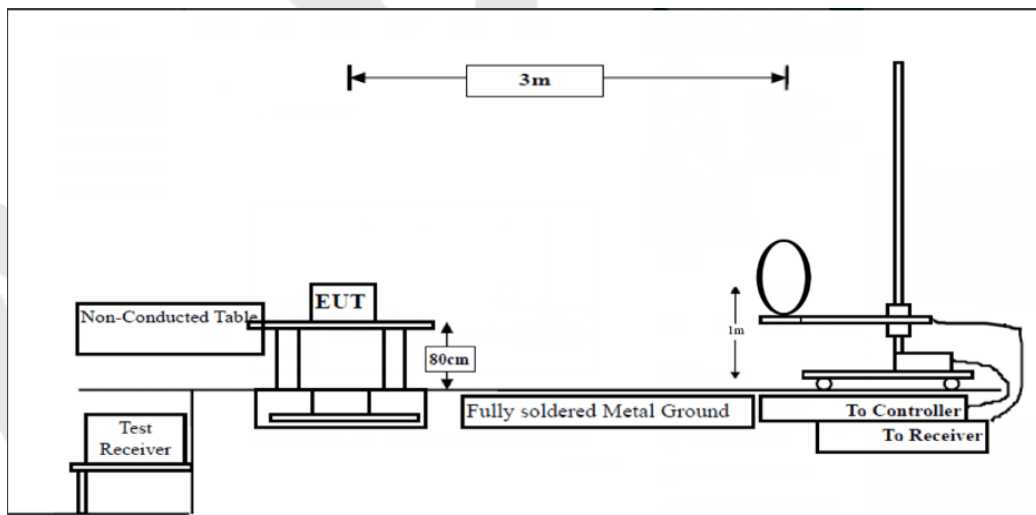

Figure 1. Below 30MHz

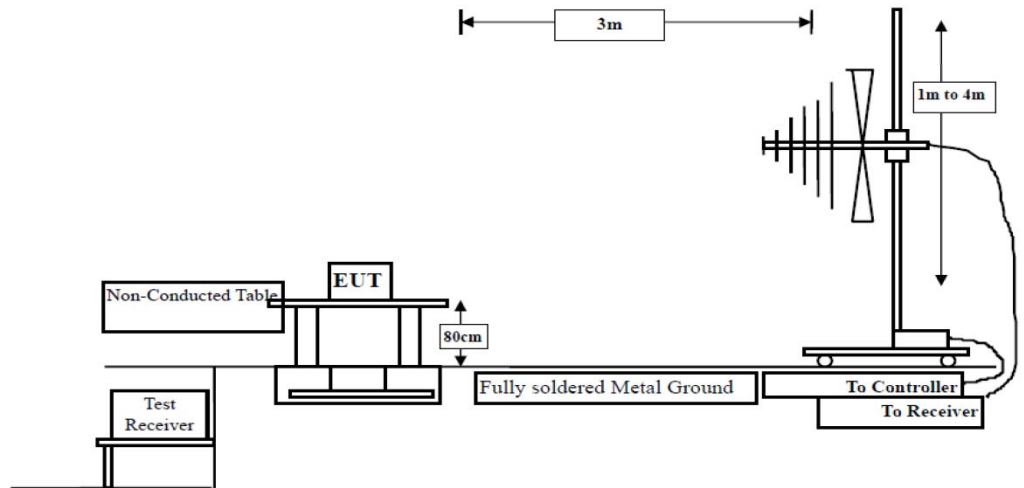

Figure 2. 30MHz to 1GHz

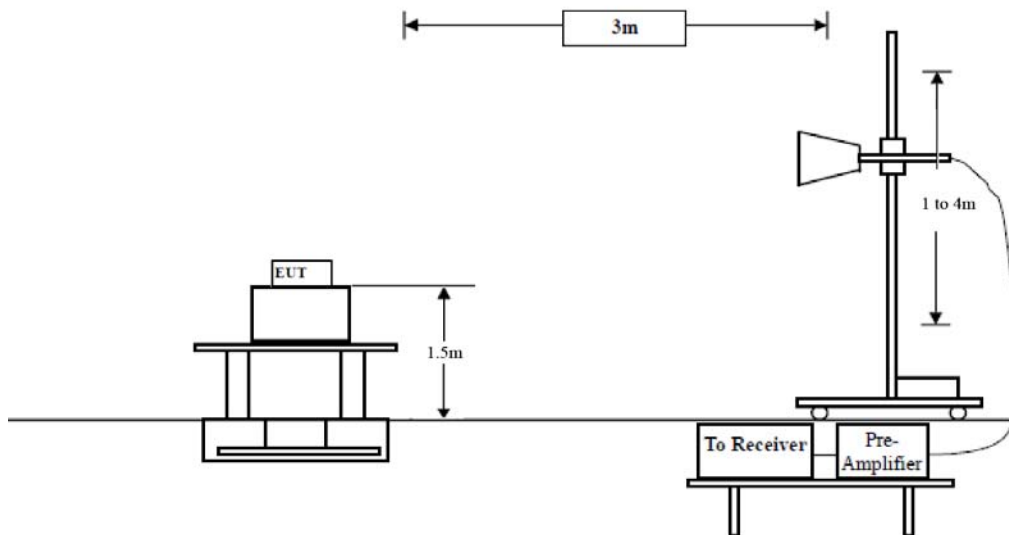

Figure 3. Above 1 GHz

### 4.3. Test Procedure

For below 1GHz: The EUT is placed on a turntable, which is 0.8m above the ground plane.

For above 1GHz: The EUT is placed on a turntable, which is 1.5m above the ground plane.

The turn table can rotate 360 degrees to determine the position of the maximum emission level. The EUT is set 3 meters away from the receiving antenna which is mounted on a antenna tower. The antenna can be moved up and down from 1 to 4 meters to find out the maximum emission level. Rotated the EUT through three orthogonal axes to determine the maximum emissions, both horizontal and vertical polarization of the antenna are set on test. The EUT is tested in 9\*6\*6 Chamber. The device is evaluated in xyz orientation.

For 9kHz to 150kHz, Set the spectrum analyzer as:

RBW = 200Hz, VBW =1kHz, Detector= Quasi-Peak, Trace mode= Max hold, Sweep- auto couple.

For 150kHz to 30MHz, Set the spectrum analyzer as:

RBW = 9KHz, VBW =30kHz, Detector= Quasi-Peak, Trace mode= Max hold, Sweep- auto couple.

For 30MHz to 1000MHz, Set the spectrum analyzer as:

RBW = 100kHz, VBW =300kHz, Detector= Quasi-Peak, Trace mode= Max hold, Sweep- auto couple.

For above 1GHz,Set the spectrum analyzer as:

RBW =1MHz, VBW =1MHz, Detector= Peak, Trace mode= Max hold, Sweep- auto couple.

RBW =1MHz, VBW =10Hz, Detector= Average, Trace mode= Max hold, Sweep- auto couple.

#### **4.4. Test Data**

##### **PASS**

During the test, Pre-scan all kind of the place mode (X-axis, Y-axis, Z-axis), and found the X-axis is the worst case.

The test results of 9kHz-30MHz and above 18000MHz are attenuated more than 20dB below the permissible limits, so the results don't record in the report.

**Test Results (30~1000MHz)**

Job No.: 0217060035W Temp.(°C)/Hum.(%RH): 24.3°C/55%RH  
 Standard: FCC PART 15C Power Source: AC 120V/60Hz  
 Test Mode: TX Mode Polarization: Horizontal

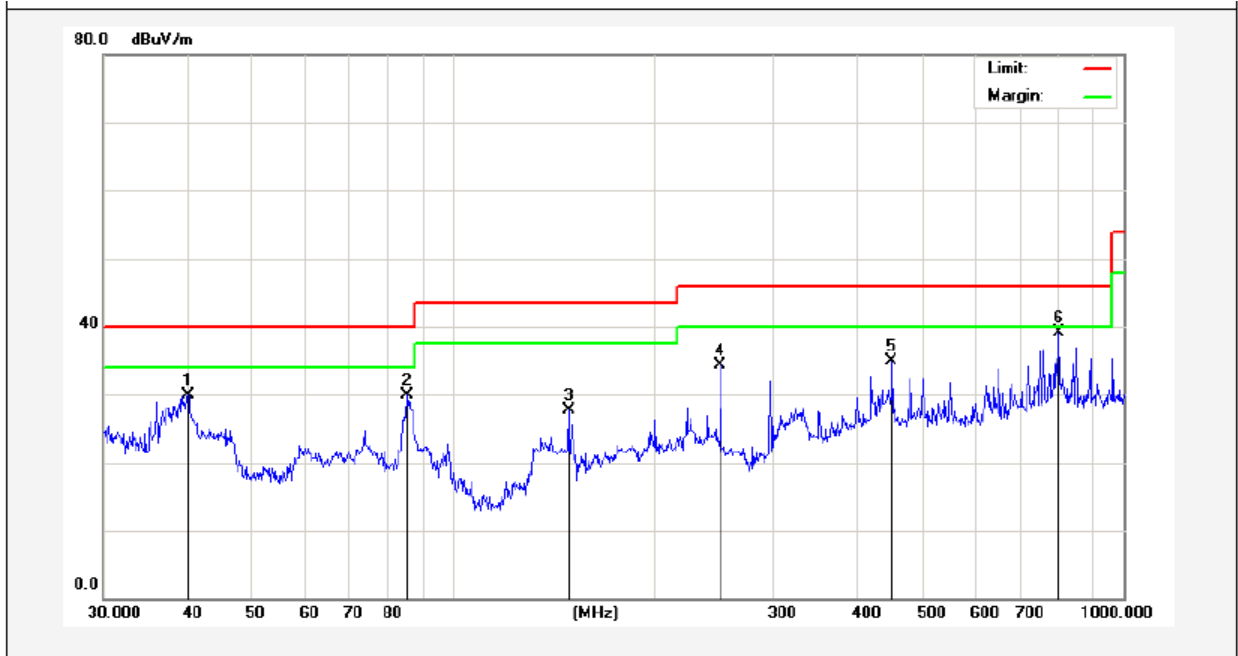

No.	Freq. (MHz)	Reading (dBuV/m)	Factor (dB/m)	Result (dBuV/m)	Limit (dBuV/)	Over Limit (dB)	Detector	Height (cm)	degree (deg)	Remark
1	40.1347	40.28	-10.42	29.86	40.00	-10.14	QP	300	33	
2	85.2980	50.38	-20.49	29.89	40.00	-10.11	QP	300	85	
3	148.4410	51.00	-23.36	27.64	43.50	-15.86	QP	300	342	
4	250.3011	52.95	-18.56	34.39	46.00	-11.61	QP	300	241	
5	451.1349	47.15	-12.15	35.00	46.00	-11.00	QP	300	168	
6	801.7862	45.72	-6.54	39.18	46.00	-6.82	QP	300	53	

**Test Results (30~1000MHz)**

Job No.: 0217060035W Temp.(°C)/Hum.(%RH): 24.3°C/55%RH  
 Standard: FCC PART 15C Power Source: AC 120V/60Hz  
 Test Mode: TX Mode Polarization: Vertical

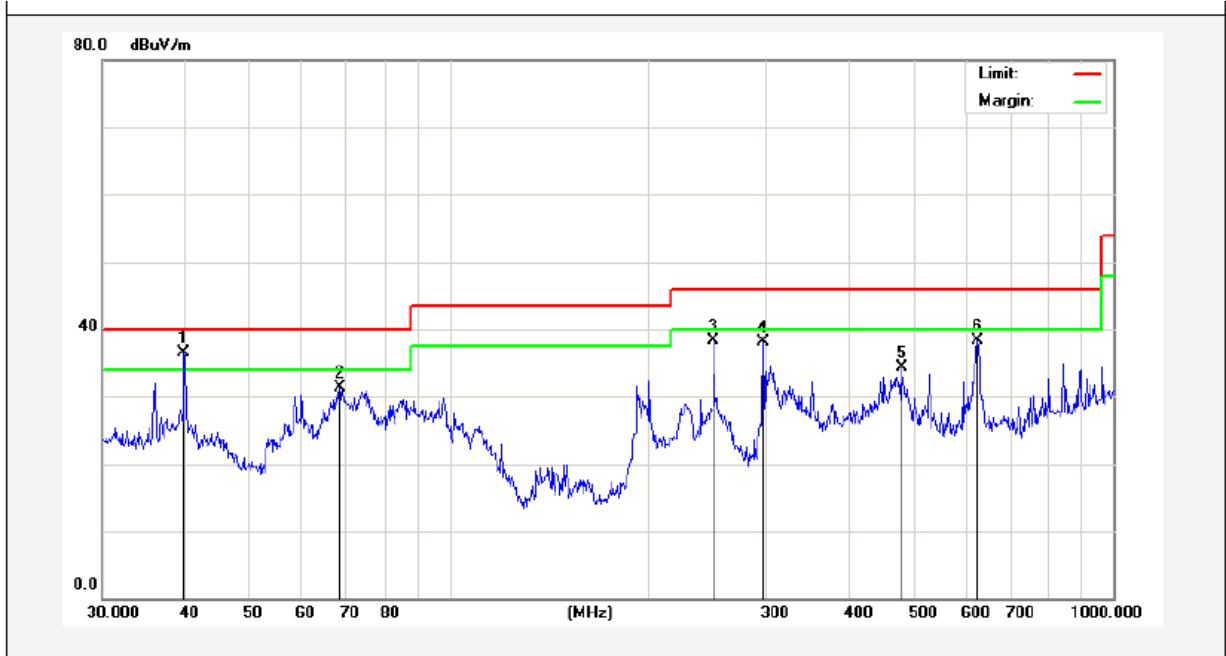

No.	Freq. (MHz)	Reading (dBuV/m)	Factor (dB/m)	Result (dBuV/m)	Limit (dBuV/)	Over Limit (dB)	Detector	Height (cm)	degree (deg)	Remark
1	39.8541	46.97	-10.49	36.48	40.00	-3.52	QP	300	0	
2	68.3907	50.21	-18.93	31.28	40.00	-8.72	QP	300	35	
3	250.3011	52.43	-14.04	38.39	46.00	-7.61	QP	300	88	
4	297.2241	52.81	-14.76	38.05	46.00	-7.95	QP	300	175	
5	480.5276	45.83	-11.53	34.30	46.00	-11.70	QP	300	281	
6	625.0779	47.40	-9.05	38.35	46.00	-7.65	QP	300	336	



**Test Results (Above 1000MHz)**

Test Mode: 802.11b Mode					Test channel: Lowest			
Peak Value								
Frequency (MHz)	Read Level (dBuV)	Antenna Factor (dB/m)	Cable Loss (dB)	Preamplifier Factor (dB)	Level (dBuV/m)	Limit (dBuV/m)	Over Limit (dB)	Pol.
4824.00	41.18	34.13	6.61	34.09	47.83	74.00	-26.17	V
7236.00	34.78	37.14	7.74	34.51	45.15	74.00	-28.85	V
9648.00	33.12	39.35	9.26	34.80	46.93	74.00	-27.07	V
12060.00	*					74.00		V
14472.00	*					74.00		V
16884.00	*					74.00		V
4824.00	39.71	34.13	6.61	34.09	46.36	74.00	-27.64	H
7236.00	34.46	37.14	7.74	34.51	44.83	74.00	-29.17	H
9648.00	32.66	39.35	9.26	34.80	46.47	74.00	-27.53	H
12060.00	*					74.00		H
14472.00	*					74.00		H
16884.00	*					74.00		H
Average Value								
Frequency (MHz)	Read Level (dBuV)	Antenna Factor (dB/m)	Cable Loss (dB)	Preamplifier Factor (dB)	Level (dBuV/m)	Limit (dBuV/m)	Over Limit (dB)	Pol.
4824.00	30.20	34.13	6.61	34.09	36.85	54.00	-17.15	V
7236.00	23.63	37.14	7.74	34.51	34.00	54.00	-20.00	V
9648.00	23.45	39.35	9.26	34.80	37.26	54.00	-16.74	V
12060.00	*					54.00		V
14472.00	*					54.00		V
16884.00	*					54.00		V
4824.00	29.21	34.13	6.61	34.09	35.86	54.00	-18.14	H
7236.00	23.03	37.14	7.74	34.51	33.40	54.00	-20.60	H
9648.00	22.40	39.35	9.26	34.80	36.21	54.00	-17.79	H
12060.00	*					54.00		H
14472.00	*					54.00		H
16884.00	*					54.00		H

**Test Results (Above 1000MHz)**

Test Mode: 802.11b Mode					Test channel: Middle			
Peak Value								
Frequency (MHz)	Read Level (dBuV)	Antenna Factor (dB/m)	Cable Loss (dB)	Preamplifier Factor (dB)	Level (dBuV/m)	Limit (dBuV/m)	Over Limit (dB)	Pol.
4874.00	40.09	34.35	6.67	34.09	47.02	74.00	-26.98	V
7311.00	34.76	37.21	7.77	34.53	45.21	74.00	-28.79	V
9748.00	34.07	39.45	9.33	34.80	48.05	74.00	-25.95	V
12185.00	*					74.00		V
14622.00	*					74.00		V
17059.00	*					74.00		V
4874.00	40.45	34.35	6.67	34.09	47.38	74.00	-26.62	H
7311.00	33.34	37.21	7.77	34.53	43.79	74.00	-30.21	H
9748.00	33.93	39.45	9.33	34.80	47.91	74.00	-26.09	H
12185.00	*					74.00		H
14622.00	*					74.00		H
17059.00	*					74.00		H
Average Value								
Frequency (MHz)	Read Level (dBuV)	Antenna Factor (dB/m)	Cable Loss (dB)	Preamplifier Factor (dB)	Level (dBuV/m)	Limit (dBuV/m)	Over Limit (dB)	Pol.
4874.00	30.88	34.35	6.67	34.09	37.81	54.00	-16.19	V
7311.00	23.06	37.21	7.77	34.53	33.51	54.00	-20.49	V
9748.00	23.31	39.45	9.33	34.80	37.29	54.00	-16.71	V
12185.00	*					54.00		V
14622.00	*					54.00		V
17059.00	*					54.00		V
4874.00	30.52	34.35	6.67	34.09	37.45	54.00	-16.55	H
7311.00	22.41	37.21	7.77	34.53	32.86	54.00	-21.14	H
9748.00	23.63	39.45	9.33	34.80	37.61	54.00	-16.39	H
12185.00	*					54.00		H
14622.00	*					54.00		H
17059.00	*					54.00		H

**Test Results (Above 1000MHz)**

Test Mode:802.11b Mode					Test channel: Highest			
Peak Value								
Frequency (MHz)	Read Level (dBuV)	Antenna Factor (dB/m)	Cable Loss (dB)	Preamplifier Factor (dB)	Level (dBuV/m)	Limit (dBuV/m)	Over Limit (dB)	Pol.
4924.00	46.15	34.57	6.74	34.09	53.37	74.00	-20.63	V
7386.00	35.77	37.29	7.80	34.55	46.31	74.00	-27.69	V
9848.00	37.60	39.55	9.41	34.81	51.75	74.00	-22.25	V
12310.00	*					74.00		V
14772.00	*					74.00		V
17234.00	*					74.00		V
4924.00	45.26	34.57	6.74	34.09	52.48	74.00	-21.52	H
7386.00	34.57	37.29	7.80	34.55	45.11	74.00	-28.89	H
9848.00	33.73	39.55	9.41	34.81	47.88	74.00	-26.12	H
12310.00	*					74.00		H
14772.00	*					74.00		H
17234.00	*					74.00		H
Average Value								
Frequency (MHz)	Read Level (dBuV)	Antenna Factor (dB/m)	Cable Loss (dB)	Preamplifier Factor (dB)	Level (dBuV/m)	Limit (dBuV/m)	Over Limit (dB)	Pol.
4924.00	36.97	34.57	6.74	34.09	44.19	54.00	-9.81	V
7386.00	25.66	37.29	7.80	34.55	36.20	54.00	-17.80	V
9848.00	26.08	39.55	9.41	34.81	40.23	54.00	-13.77	V
12310.00	*					54.00		V
14772.00	*					54.00		V
17234.00	*					54.00		V
4924.00	35.56	34.57	6.74	34.09	42.78	54.00	-11.22	H
7386.00	23.94	37.29	7.80	34.55	34.48	54.00	-19.52	H
9848.00	22.97	39.55	9.41	34.81	37.12	54.00	-16.88	H
12310.00	*					54.00		H
14772.00	*					54.00		H
17234.00	*					54.00		H

Remark:

1. During the test, pre-scan the 802.11b,g,n(HT20N),n(HT40N) mode, and found the 802.11b mode is worse case , the report only record this mode.
2. Level =Receiver Read level + Antenna Factor + Cable Loss – Preamplifier Factor
3. “\*”, means this data is the too weak instrument of signal is unable to test.

The Project in above 18000MHz was tested in MRT Technology (Suzhou) Co., Ltd.



**Radiated Band Edge:**

Test Mode: 802.11b Mode					Test channel: Lowest			
Peak Value								
Frequency (MHz)	Read Level (dBuV)	Antenna Factor (dB/m)	Cable Loss (dB)	Preamp Factor (dB)	Level (dBuV/m)	Limit (dBuV/m)	Over Limit (dB)	Pol.
2390.00	51.59	29.15	3.41	34.01	50.14	74.00	-23.86	H
2400.00	60.59	29.16	3.43	34.01	59.17	74.00	-14.83	H
2390.00	53.27	29.15	3.41	34.01	51.82	74.00	-22.18	V
2400.00	62.37	29.16	3.43	34.01	60.95	74.00	-13.05	V
Average Value								
Frequency (MHz)	Read Level (dBuV)	Antenna Factor (dB/m)	Cable Loss (dB)	Preamp Factor (dB)	Level (dBuV/m)	Limit (dBuV/m)	Over Limit (dB)	Pol.
2390.00	38.37	29.15	3.41	34.01	36.92	54.00	-17.08	H
2400.00	46.66	29.16	3.43	34.01	45.24	54.00	-8.76	H
2390.00	40.19	29.15	3.41	34.01	38.74	54.00	-15.26	V
2400.00	47.78	29.16	3.43	34.01	46.36	54.00	-7.64	V

Test Mode: 802.11b Mode					Test channel: Highest			
Peak Value								
Frequency (MHz)	Read Level (dBuV)	Antenna Factor (dB/m)	Cable Loss (dB)	Preamp Factor (dB)	Level (dBuV/m)	Limit (dBuV/m)	Over Limit (dB)	Pol.
2483.50	52.23	29.28	3.53	34.03	51.01	74.00	-22.99	H
2500.00	48.07	29.30	3.56	34.03	46.90	74.00	-27.10	H
2483.50	54.48	29.28	3.53	34.03	53.26	74.00	-20.74	V
2500.00	50.57	29.30	3.56	34.03	49.40	74.00	-24.60	V
Average Value								
Frequency (MHz)	Read Level (dBuV)	Antenna Factor (dB/m)	Cable Loss (dB)	Preamp Factor (dB)	Level (dBuV/m)	Limit (dBuV/m)	Over Limit (dB)	Pol.
2483.50	38.73	29.28	3.53	34.03	37.51	54.00	-16.49	H
2500.00	34.84	29.30	3.56	34.03	33.67	54.00	-20.33	H
2483.50	40.67	29.28	3.53	34.03	39.45	54.00	-14.55	V
2500.00	36.72	29.30	3.56	34.03	35.55	54.00	-18.45	V

Remark:

1. Level = Receiver Read level + Antenna Factor + Cable Loss – Pre-amplifier Factor

**Radiated Band Edge:**

Test Mode: 802.11g Mode					Test channel: Lowest			
Peak Value								
Frequency (MHz)	Read Level (dBuV)	Antenna Factor (dB/m)	Cable Loss (dB)	Preamp Factor (dB)	Level (dBuV/m)	Limit (dBuV/m)	Over Limit (dB)	Pol.
2390.00	50.35	27.53	5.47	33.92	49.43	74.00	-24.57	H
2400.00	58.93	27.55	5.49	29.93	62.04	74.00	-11.96	H
2390.00	51.94	27.53	5.47	33.92	51.02	74.00	-22.98	V
2400.00	60.38	27.55	5.49	29.93	63.49	74.00	-10.51	V
Average Value								
Frequency (MHz)	Read Level (dBuV)	Antenna Factor (dB/m)	Cable Loss (dB)	Preamp Factor (dB)	Level (dBuV/m)	Limit (dBuV/m)	Over Limit (dB)	Pol.
2390.00	37.49	27.53	5.47	33.92	36.57	54.00	-17.43	H
2400.00	45.64	27.55	5.49	29.93	48.75	54.00	-5.25	H
2390.00	39.20	27.53	5.47	33.92	38.28	54.00	-15.72	V
2400.00	46.67	27.55	5.49	29.93	49.78	54.00	-4.22	V

Test Mode: 802.11g Mode					Test channel: Highest			
Peak Value								
Frequency (MHz)	Read Level (dBuV)	Antenna Factor (dB/m)	Cable Loss (dB)	Preamp Factor (dB)	Level (dBuV/m)	Limit (dBuV/m)	Over Limit (dB)	Pol.
2483.50	50.45	29.28	3.53	34.03	49.23	74.00	-24.77	H
2500.00	46.69	29.30	3.56	34.03	45.52	74.00	-28.48	H
2483.50	52.44	29.28	3.53	34.03	51.22	74.00	-22.78	V
2500.00	48.96	29.30	3.56	34.03	47.79	74.00	-26.21	V
Average Value								
Frequency (MHz)	Read Level (dBuV)	Antenna Factor (dB/m)	Cable Loss (dB)	Preamp Factor (dB)	Level (dBuV/m)	Limit (dBuV/m)	Over Limit (dB)	Pol.
2483.50	37.65	29.28	3.53	34.03	36.43	54.00	-17.57	H
2500.00	34.00	29.30	3.56	34.03	32.83	54.00	-21.17	H
2483.50	39.49	29.28	3.53	34.03	38.27	54.00	-15.73	V
2500.00	35.83	29.30	3.56	34.03	34.66	54.00	-19.34	V

Remark:

1. Level = Receiver Read level + Antenna Factor + Cable Loss – Pre-amplifier Factor

**Radiated Band Edge:**

Test Mode: 802.11n20 Mode					Test channel: Lowest			
Peak Value								
Frequency (MHz)	Read Level (dBuV)	Antenna Factor (dB/m)	Cable Loss (dB)	Preamp Factor (dB)	Level (dBuV/m)	Limit (dBuV/m)	Over Limit (dB)	Pol.
2390.00	50.63	27.53	5.47	33.92	49.71	74.00	-24.29	H
2400.00	59.31	27.55	5.49	29.93	62.42	74.00	-11.58	H
2390.00	52.25	27.53	5.47	33.92	51.33	74.00	-22.67	V
2400.00	60.83	27.55	5.49	29.93	63.94	74.00	-10.06	V
Average Value								
Frequency (MHz)	Read Level (dBuV)	Antenna Factor (dB/m)	Cable Loss (dB)	Preamp Factor (dB)	Level (dBuV/m)	Limit (dBuV/m)	Over Limit (dB)	Pol.
2390.00	37.69	27.53	5.47	33.92	36.77	54.00	-17.23	H
2400.00	45.87	27.55	5.49	29.93	48.98	54.00	-5.02	H
2390.00	39.43	27.53	5.47	33.92	38.51	54.00	-15.49	V
2400.00	46.92	27.55	5.49	29.93	50.03	54.00	-3.97	V

Test Mode: 802.11n20 Mode					Test channel: Highest			
Peak Value								
Frequency (MHz)	Read Level (dBuV)	Antenna Factor (dB/m)	Cable Loss (dB)	Preamp Factor (dB)	Level (dBuV/m)	Limit (dBuV/m)	Over Limit (dB)	Pol.
2483.50	50.86	29.28	3.53	34.03	49.64	74.00	-24.36	H
2500.00	47.01	29.30	3.56	34.03	45.84	74.00	-28.16	H
2483.50	52.91	29.28	3.53	34.03	51.69	74.00	-22.31	V
2500.00	49.33	29.30	3.56	34.03	48.16	74.00	-25.84	V
Average Value								
Frequency (MHz)	Read Level (dBuV)	Antenna Factor (dB/m)	Cable Loss (dB)	Preamp Factor (dB)	Level (dBuV/m)	Limit (dBuV/m)	Over Limit (dB)	Pol.
2483.50	37.90	29.28	3.53	34.03	36.68	54.00	-17.32	H
2500.00	34.19	29.30	3.56	34.03	33.02	54.00	-20.98	H
2483.50	39.76	29.28	3.53	34.03	38.54	54.00	-15.46	V
2500.00	36.04	29.30	3.56	34.03	34.87	54.00	-19.13	V

Remark:

1. Level = Receiver Read level + Antenna Factor + Cable Loss – Pre-amplifier Factor

**Radiated Band Edge:**

Test Mode: 802.11n40 Mode					Test channel: Lowest			
Peak Value								
Frequency (MHz)	Read Level (dBuV)	Antenna Factor (dB/m)	Cable Loss (dB)	Preamp Factor (dB)	Level (dBuV/m)	Limit (dBuV/m)	Over Limit (dB)	Pol.
2390.00	49.61	27.53	5.47	33.92	48.69	74.00	-25.31	H
2400.00	57.94	27.55	5.49	29.93	61.05	74.00	-12.95	H
2390.00	51.15	27.53	5.47	33.92	50.23	74.00	-23.77	V
2400.00	59.19	27.55	5.49	29.93	62.30	74.00	-11.70	V
Average Value								
Frequency (MHz)	Read Level (dBuV)	Antenna Factor (dB/m)	Cable Loss (dB)	Preamp Factor (dB)	Level (dBuV/m)	Limit (dBuV/m)	Over Limit (dB)	Pol.
2390.00	36.96	27.53	5.47	33.92	36.04	54.00	-17.96	H
2400.00	45.04	27.55	5.49	29.93	48.15	54.00	-5.85	H
2390.00	38.62	27.53	5.47	33.92	37.70	54.00	-16.30	V
2400.00	46.00	27.55	5.49	29.93	49.11	54.00	-4.89	V

Test Mode: 802.11n40 Mode					Test channel: Highest			
Peak Value								
Frequency (MHz)	Read Level (dBuV)	Antenna Factor (dB/m)	Cable Loss (dB)	Preamp Factor (dB)	Level (dBuV/m)	Limit (dBuV/m)	Over Limit (dB)	Pol.
2483.50	49.40	29.28	3.53	34.03	48.18	74.00	-25.82	H
2500.00	45.88	29.30	3.56	34.03	44.71	74.00	-29.29	H
2483.50	51.24	29.28	3.53	34.03	50.02	74.00	-23.98	V
2500.00	48.00	29.30	3.56	34.03	46.83	74.00	-27.17	V
Average Value								
Frequency (MHz)	Read Level (dBuV)	Antenna Factor (dB/m)	Cable Loss (dB)	Preamp Factor (dB)	Level (dBuV/m)	Limit (dBuV/m)	Over Limit (dB)	Pol.
2483.50	37.02	29.28	3.53	34.03	35.80	54.00	-18.20	H
2500.00	33.51	29.30	3.56	34.03	32.34	54.00	-21.66	H
2483.50	38.78	29.28	3.53	34.03	37.56	54.00	-16.44	V
2500.00	35.31	29.30	3.56	34.03	34.14	54.00	-19.86	V

Remark:

1. Level = Receiver Read level + Antenna Factor + Cable Loss – Pre-amplifier Factor

## 5. Maximum Peak Output Power Test

### 5.1. Test Standard and Limit

Test Standard	FCC Part15 C Section 15.247 (b)(3)
Test Limit	30dBm

### 5.2. Test Setup

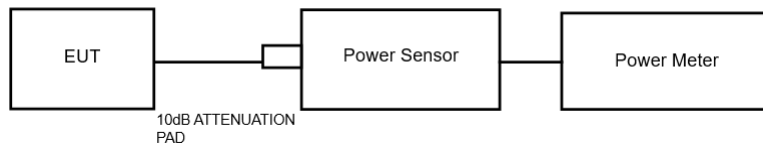

### 5.3. Test Procedure

1. The Transmitter output (antenna port) was connected to the power meter.
2. Turn on the EUT and power meter and then record the power value.
3. Repeat above procedures on all channels needed to be tested.

Note: The cable loss and attenuator loss were offset into measure device as amplitude offset.

### 5.4. Test Data

Test Item	: Max. peak output power	Test Mode	: CH Low ~ CH High
Test Voltage	: AC 120V/60Hz	Temperature	: 24°C
Test Result	: PASS	Humidity	: 55%RH

Test Channel	Frequency (MHz)	Maximum Peak Conducted Output Power (PK) (dBm)	Limit dBm	Results
<b>TX 802.11b Mode</b>				
CH01	2412	15.11	30	PASS
CH06	2437	15.78	30	PASS
CH11	2462	<b>17.48</b>	30	PASS
<b>TX 802.11g Mode</b>				
CH01	2412	13.26	30	PASS
CH06	2437	16.37	30	PASS
CH11	2462	16.08	30	PASS
<b>TX 802.11n(20) Mode</b>				
CH01	2412	13.75	30	PASS
CH06	2437	16.24	30	PASS
CH11	2462	15.74	30	PASS
<b>TX 802.11n(40) Mode</b>				
CH03	2422	12.29	30	PASS
CH06	2437	15.15	30	PASS
CH09	2452	13.83	30	PASS

**Note: For power test the duty cycle is 100% in continuous transmitting mode.  
 Please see the plot of next page**

### Duty Cycle

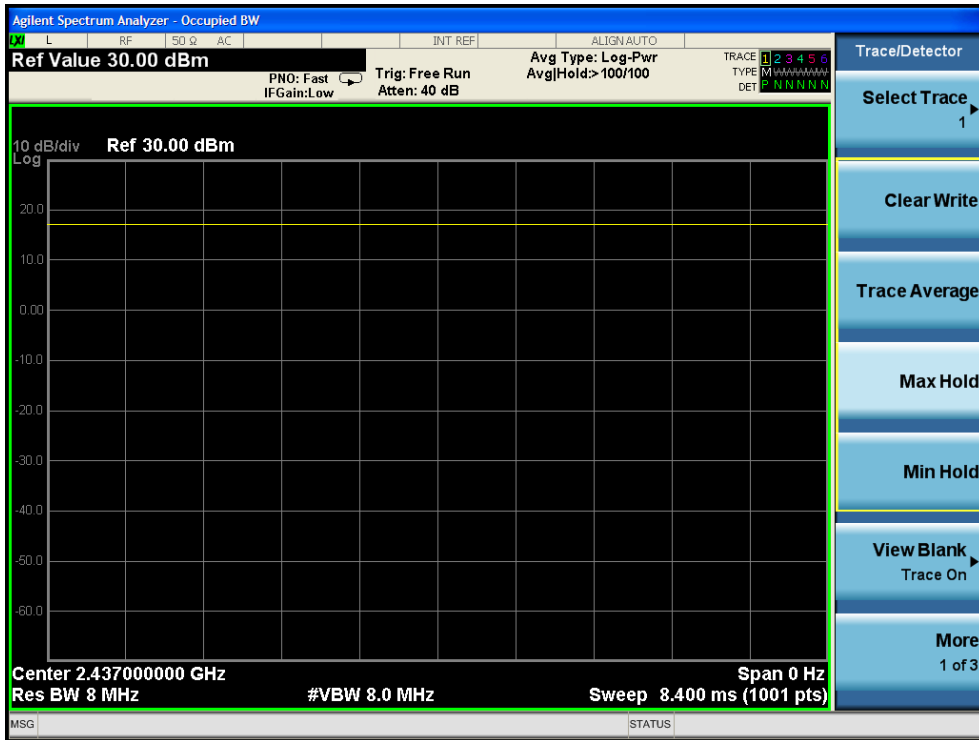

802.11b mode

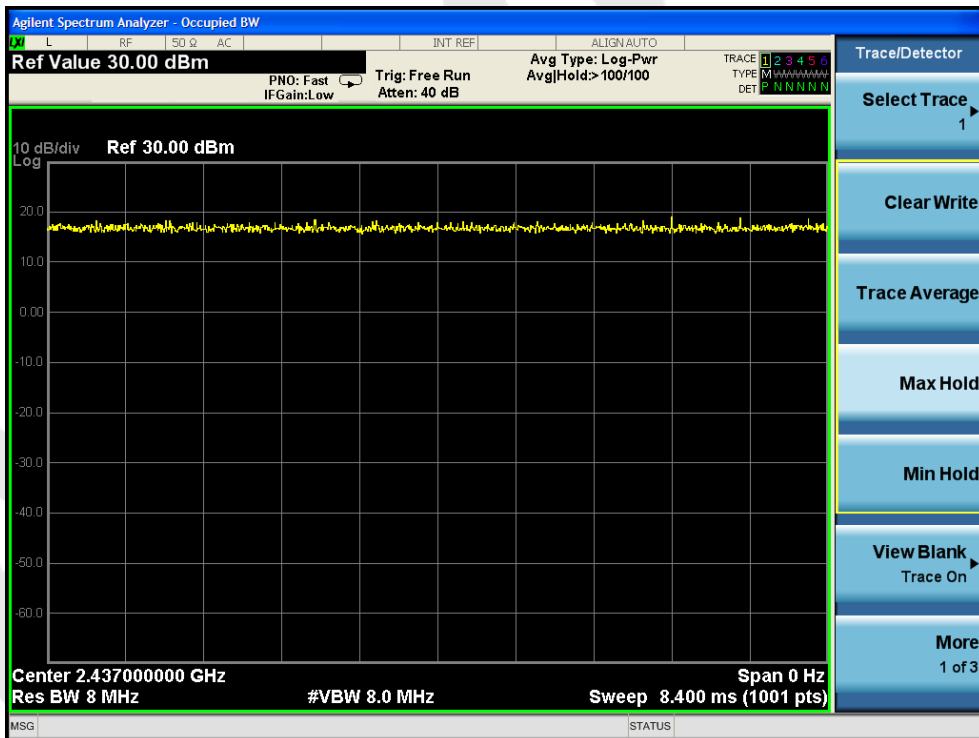

802.11g mode

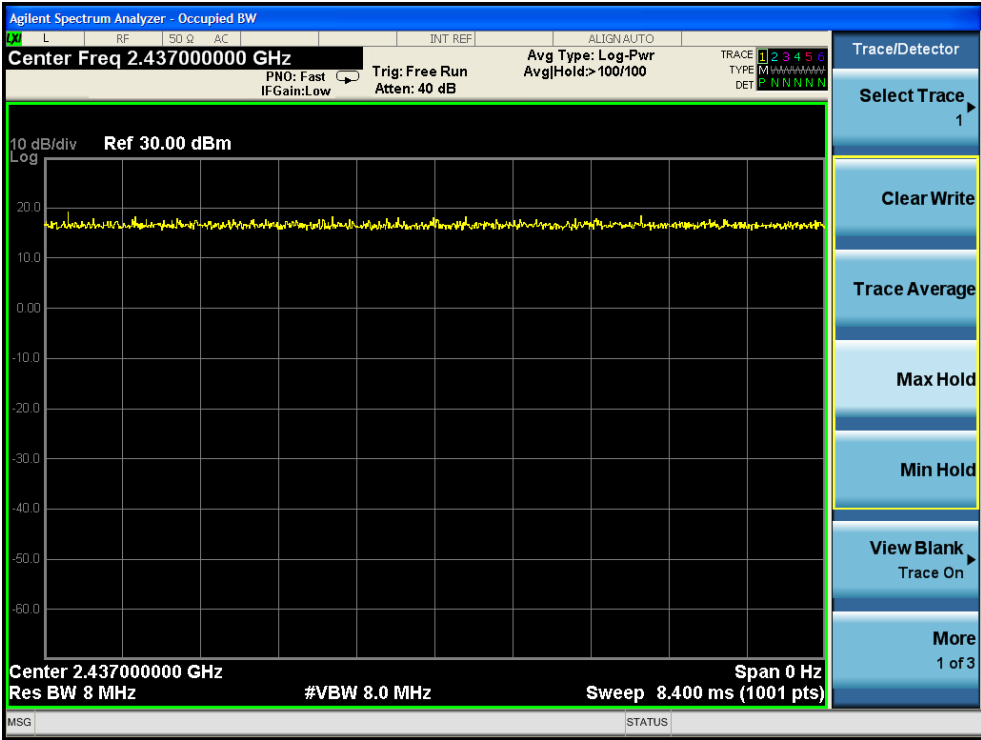

802.11n(HT20) mode

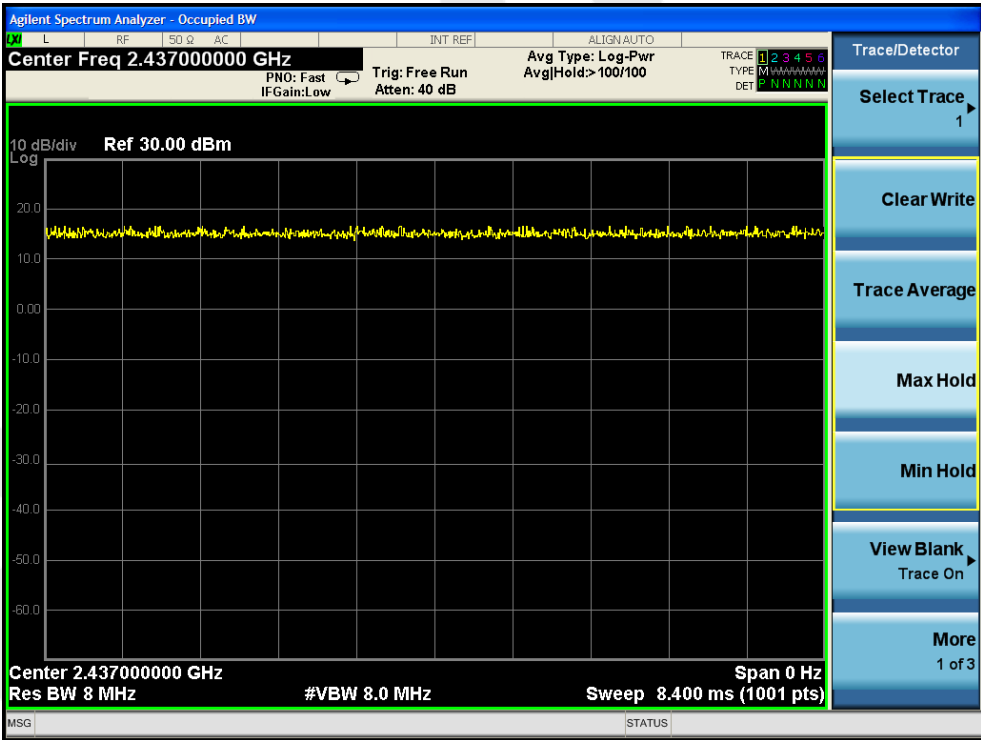

802.11n(HT40) mode



## 6. 6DB Occupy Bandwidth Test

### 6.1. Test Standard and Limit

Test Standard	FCC Part15 C Section 15.247 (a)(2)
Test Limit	>500kHz

### 6.2. Test Setup

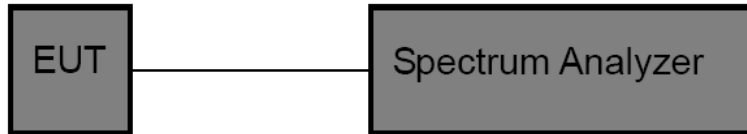

### 6.3. Test Procedure

1. Place the EUT on the table and set it in the transmitting mode.
2. Remove the antenna from the EUT and then connect a low loss RF cable from the antenna port to the spectrum analyzer.
3. Set the spectrum analyzer as:  
 RBW = 100kHz, VBW  $\geq$  3\*RBW =300kHz,  
 Detector= Peak  
 Trace mode= Max hold.  
 Sweep- auto couple.
4. Mark the peak frequency and -6dB (upper and lower) frequency.
5. Repeat until all the rest channels are investigated.

### 6.4. Test Data

Test Item : 6dB Bandwidth  
 Test Voltage : AC 120V/60Hz  
 Test Result : PASS

Test Mode : CH Low ~ CH High  
 Temperature : 24°C  
 Humidity : 55%RH

Mode	Channel	Frequency (MHz)	Bandwidth (MHz)	Limit (kHz)	Results
802.11b	Low	2412	9.137	>500	PASS
	Middle	2437	9.590		PASS
	High	2462	10.070		PASS
802.11g	Low	2412	16.070	>500	PASS
	Middle	2437	15.170		PASS
	High	2462	15.140		PASS
802.11n20	Low	2412	15.160	>500	PASS
	Middle	2437	15.960		PASS
	High	2462	15.320		PASS
802.11n40	Low	2422	35.190	>500	PASS
	Middle	2437	35.230		PASS
	High	2452	35.210		PASS

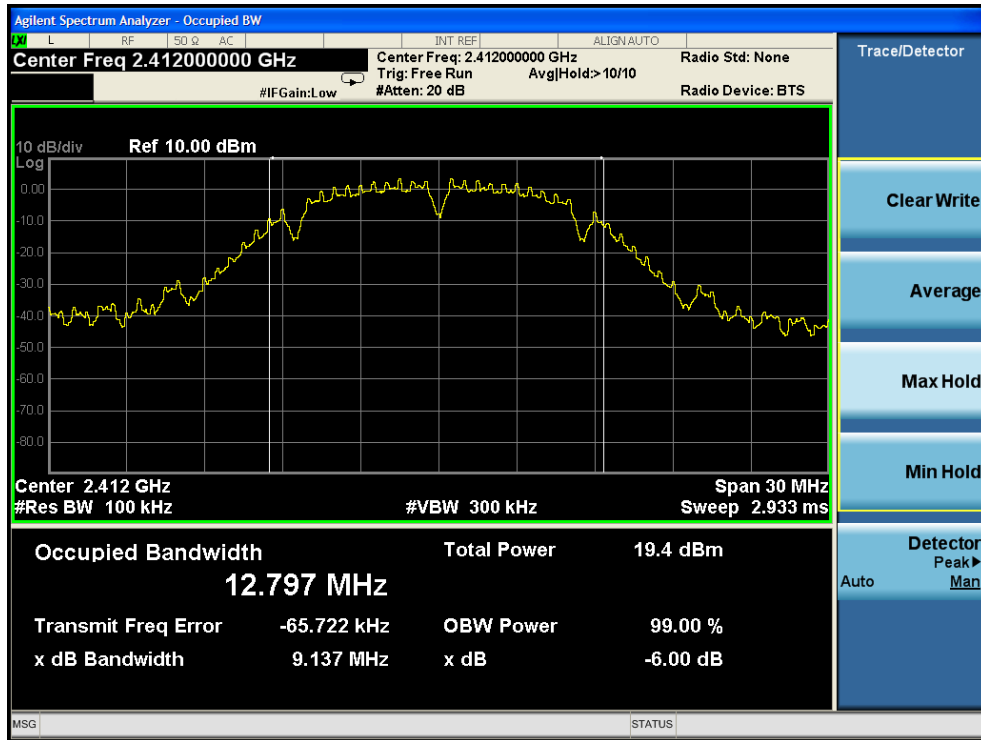

802.11b mode : Lowest

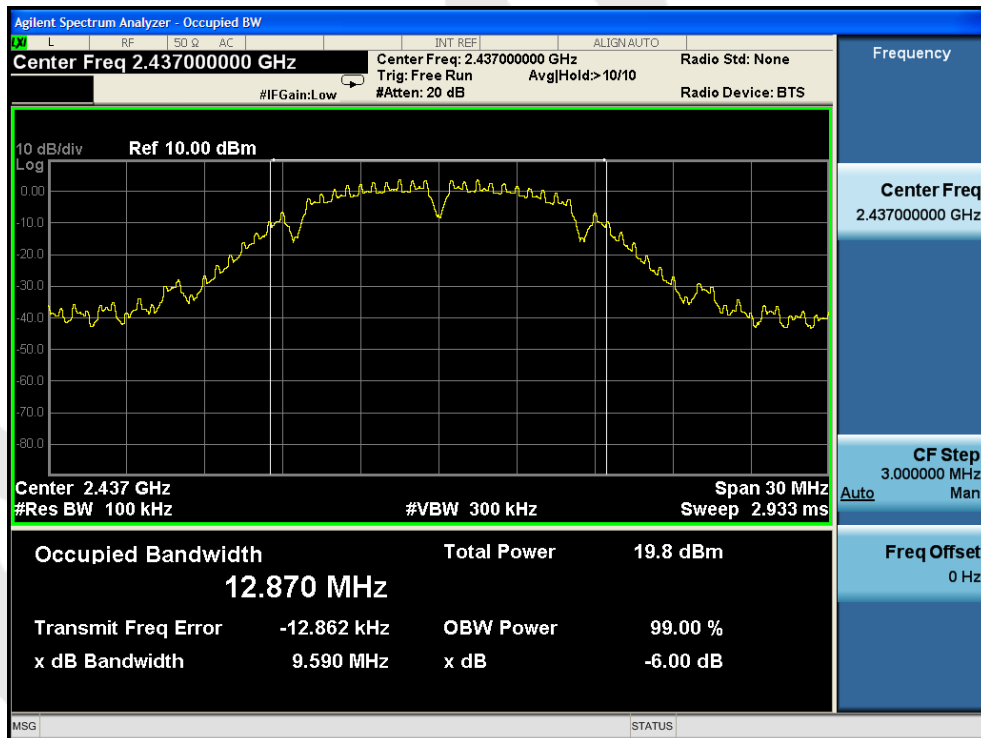

802.11b mode : Middle

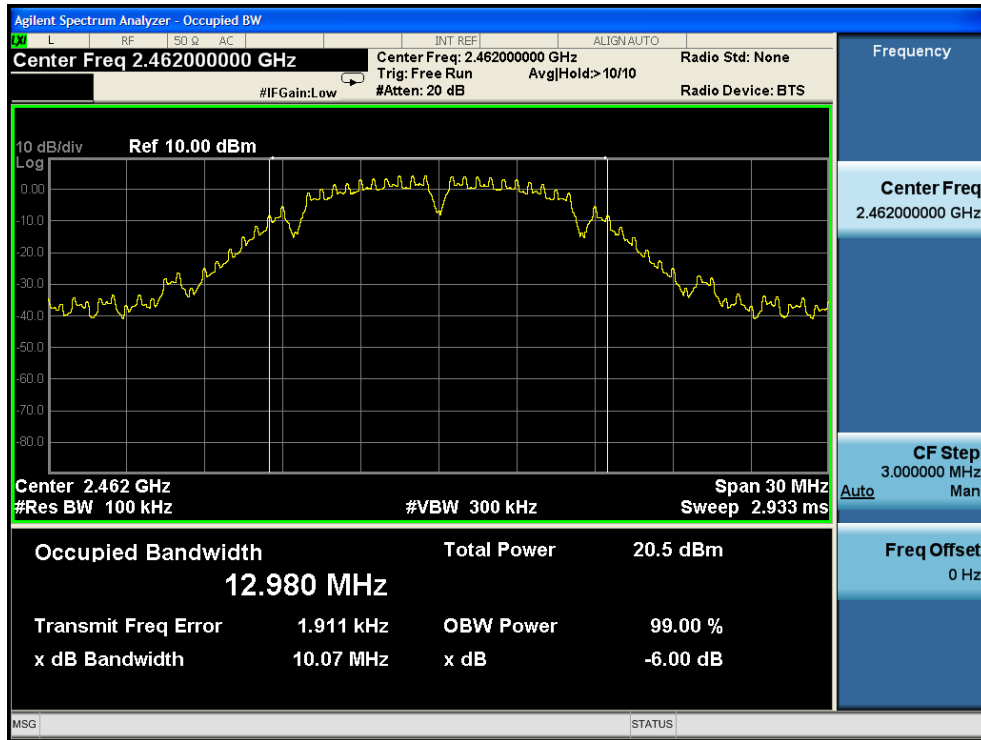

802.11b mode : Highest

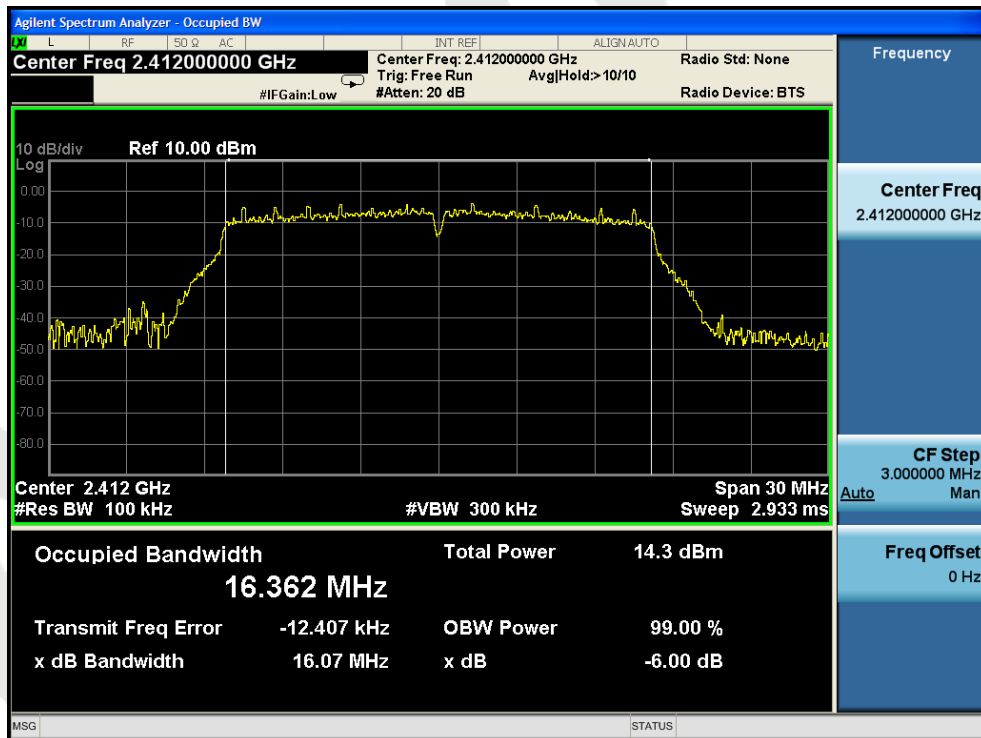

802.11g mode : Lowest

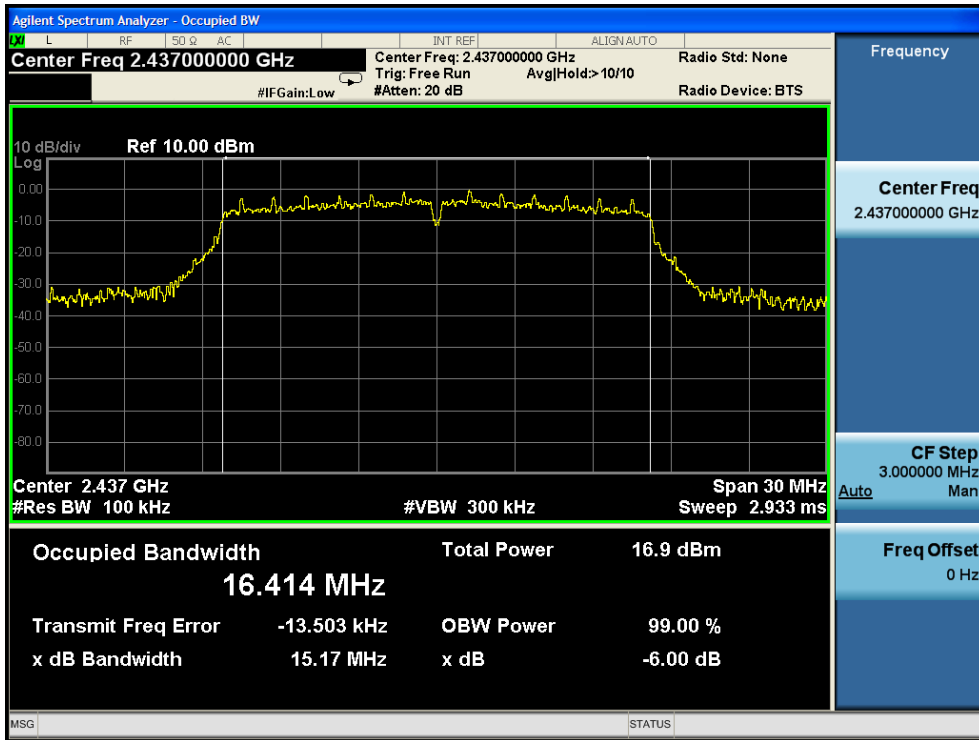

802.11g mode : Middle

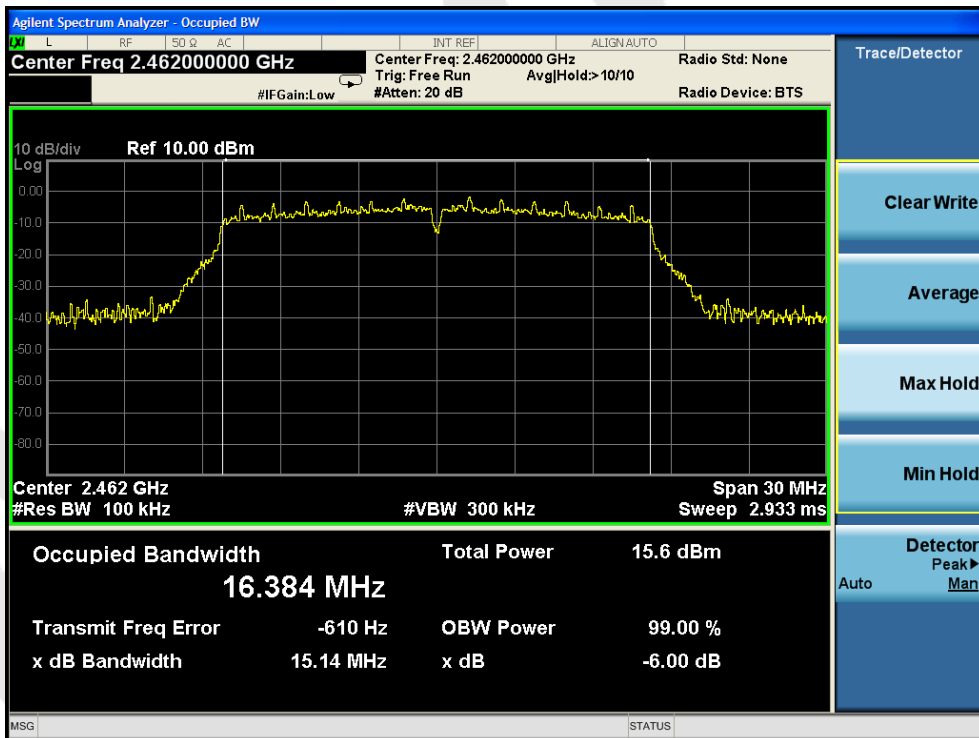

802.11g mode : Highest

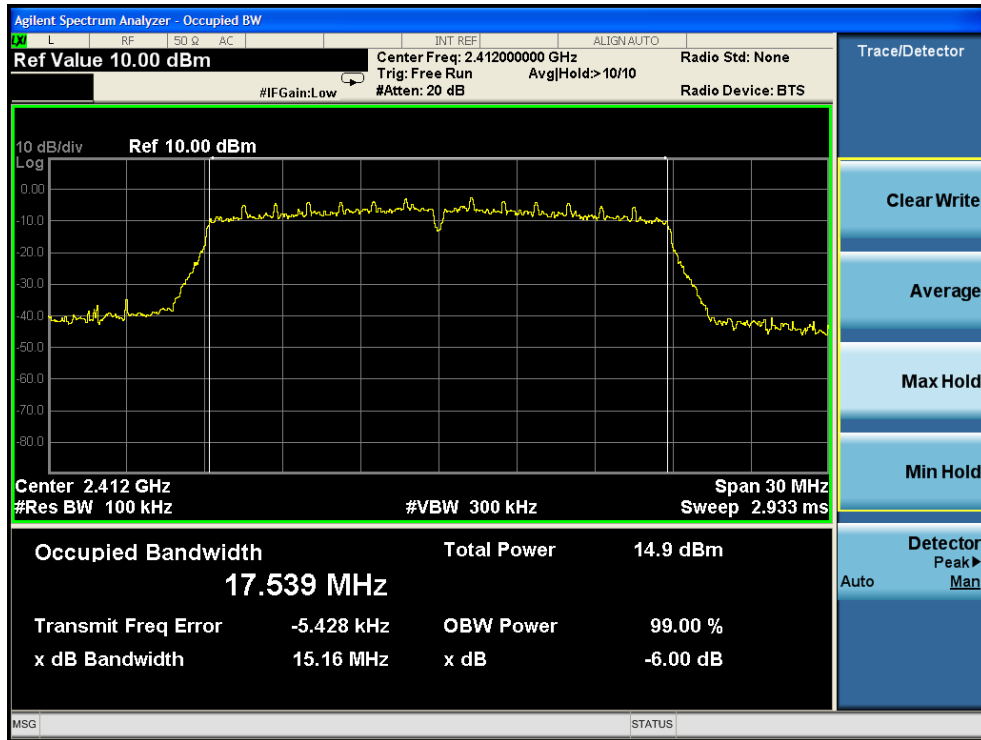

802.11n20 mode : Lowest

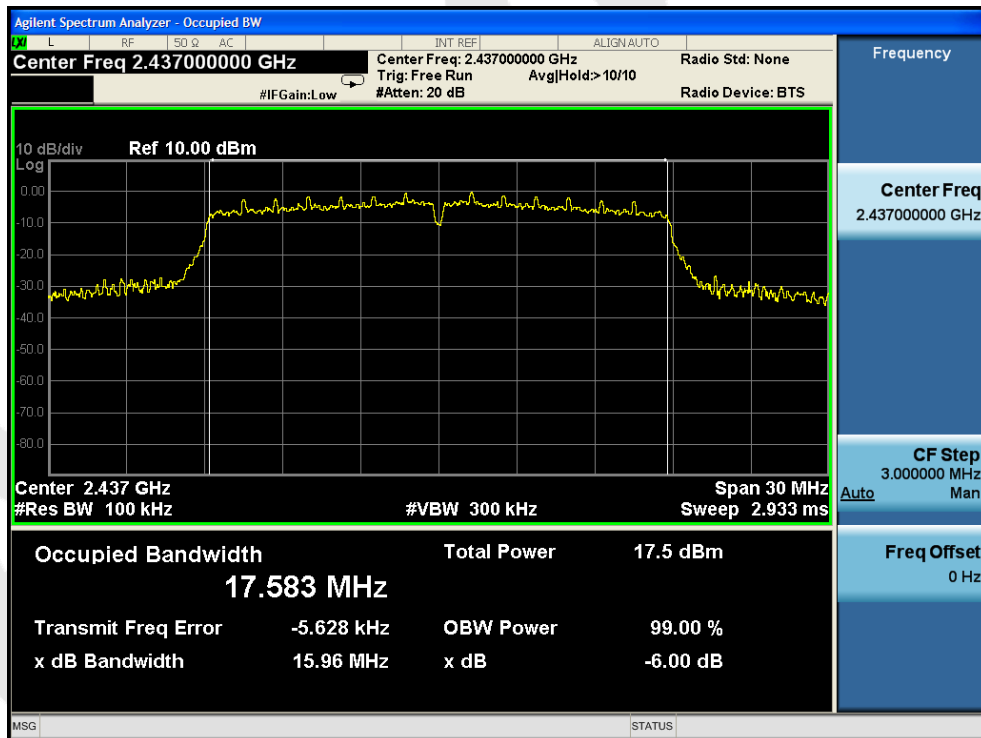

802.11n20 mode : Middle

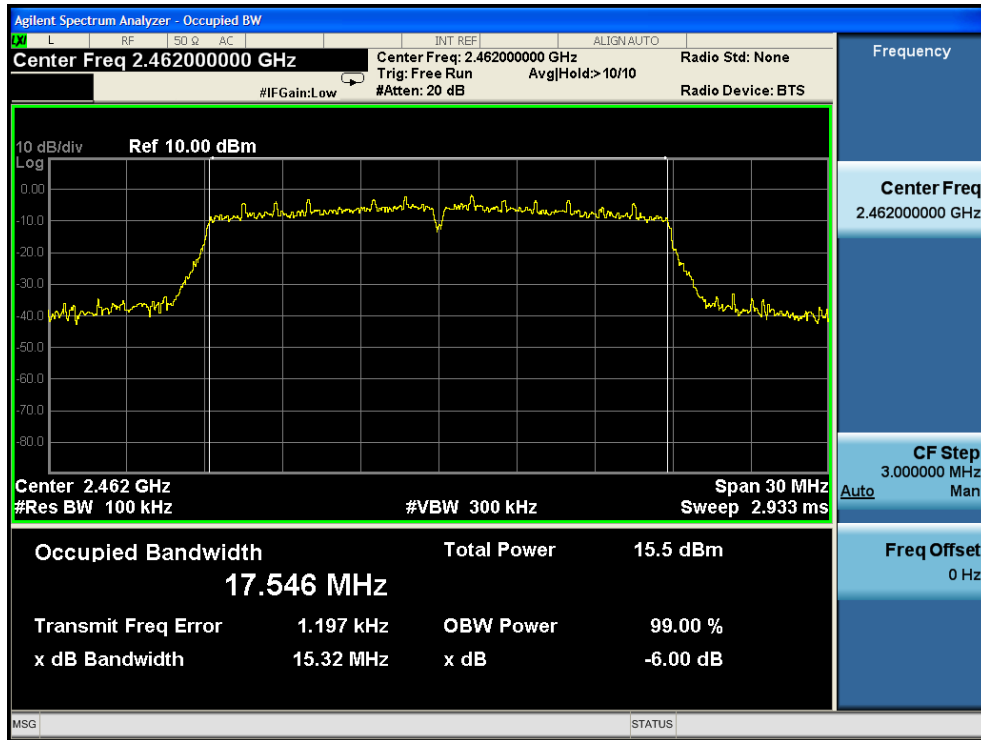

802.11n20 mode : Highest

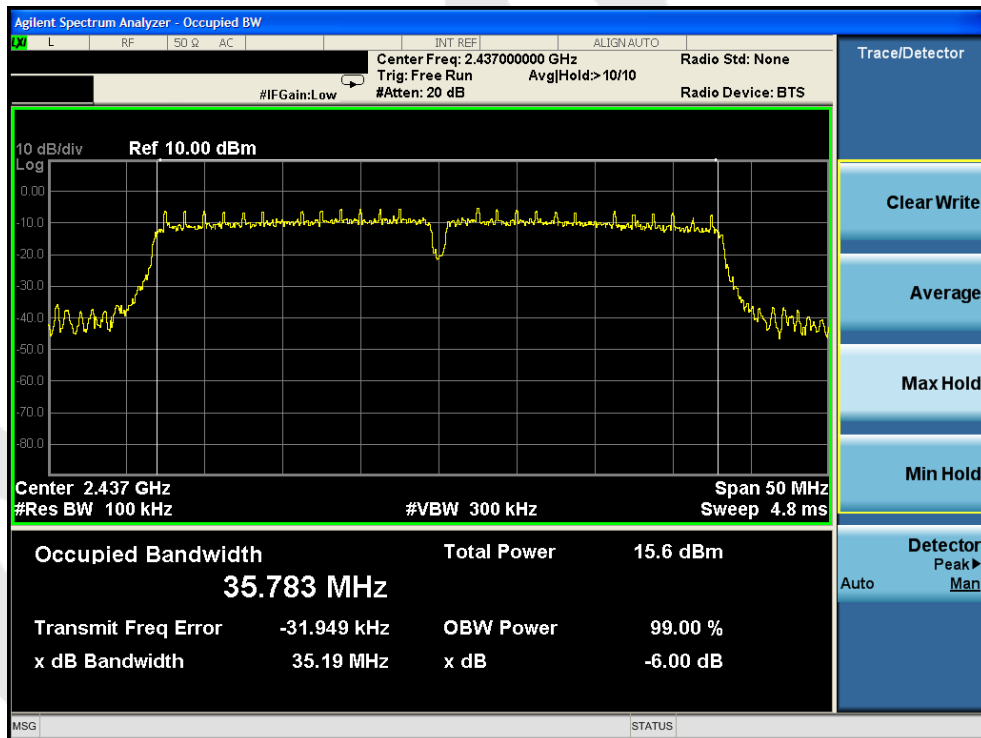

802.11n40 mode : Lowest

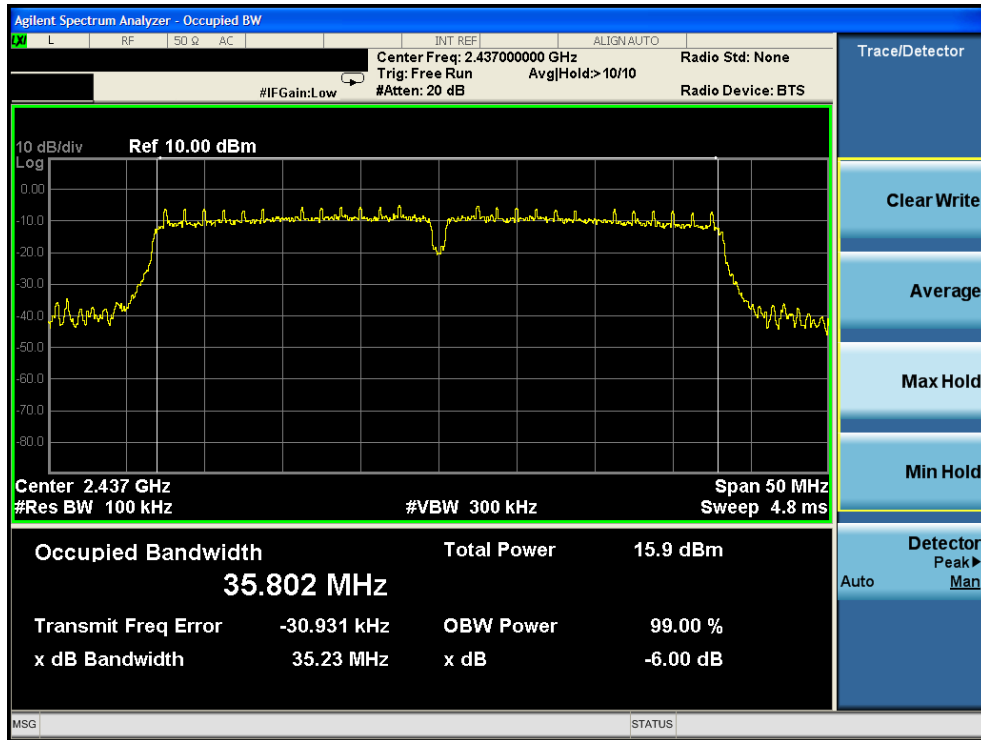

802.11n40 mode : Middle

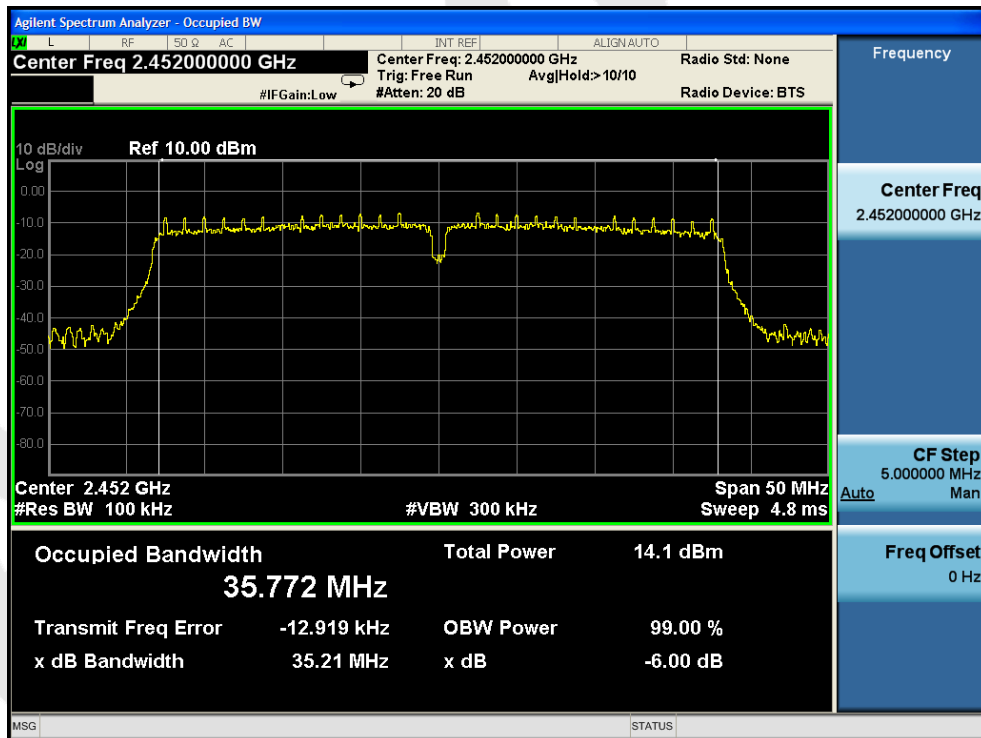

802.11n40 mode : Highest



## 7. Power Spectral Density Test

### 7.1. Test Standard and Limit

Test Standard	FCC Part15 C Section 15.247 (e)
Test Limit	8dBm/3KHz

### 7.2. Test Setup

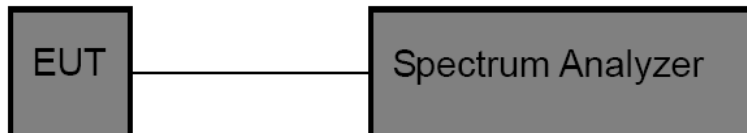

### 7.3. Test Procedure

1. Place the EUT on the table and set it in transmitting mode. Remove the antenna from the EUT and then connect a low loss RF cable from the antenna port to the spectrum analyzer.
2. Set the spectrum analyzer as RBW = 3kHz, VBW = 10kHz, Span = 1.5xDTS BW
3. Record the max. reading.
4. Repeat the above procedure until the measurements for all frequencies are completed.

### 7.4. Test Data

Test Item	: Power Spectral Density	Test Mode	: CH Low ~ CH High
Test Voltage	: AC 120V/60Hz	Temperature	: 24°C
Test Result	: PASS	Humidity	: 55%RH

Mode	Channel	Frequency (MHz)	PPSD (dBm/3KHz)	Limit (dBm/3KHz)	Results
802.11b	Low	2412	-9.265	8.00	PASS
	Middle	2437	-11.196	8.00	PASS
	High	2462	-10.515	8.00	PASS
802.11g	Low	2412	-17.257	8.00	PASS
	Middle	2437	-16.231	8.00	PASS
	High	2462	-16.438	8.00	PASS
802.11n20	Low	2412	-17.903	8.00	PASS
	Middle	2437	-16.287	8.00	PASS
	High	2462	-17.147	8.00	PASS
802.11n40	Low	2422	-23.410	8.00	PASS
	Middle	2437	-20.659	8.00	PASS
	High	2452	-22.389	8.00	PASS



802.11b mode : Lowest

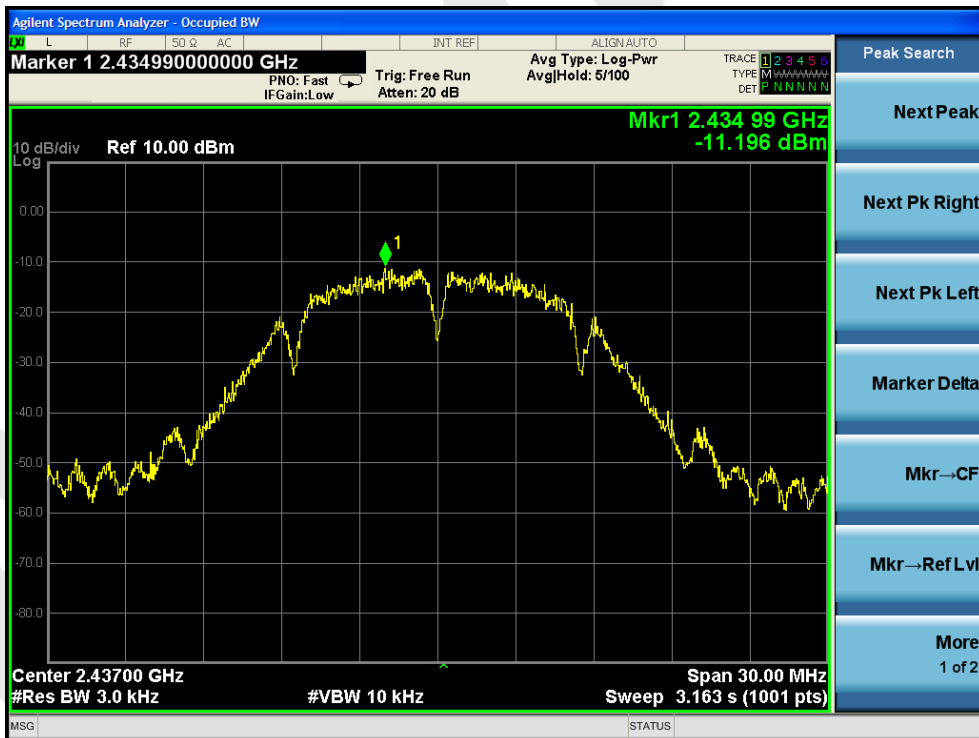

802.11b mode : Middle



802.11b mode : Highest

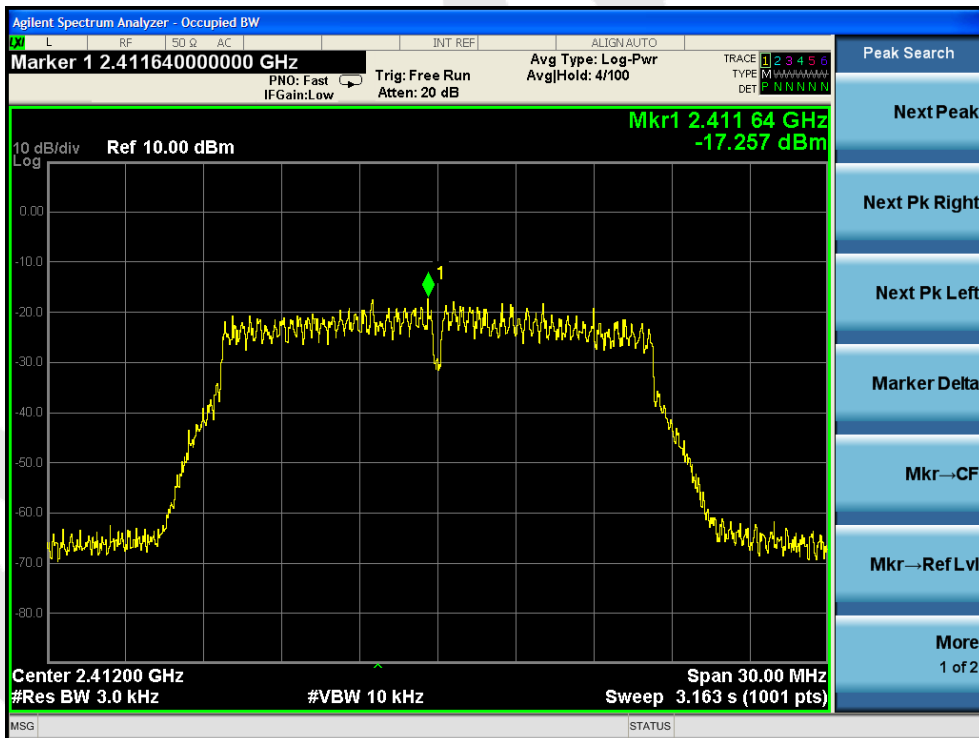

802.11g mode : Lowest

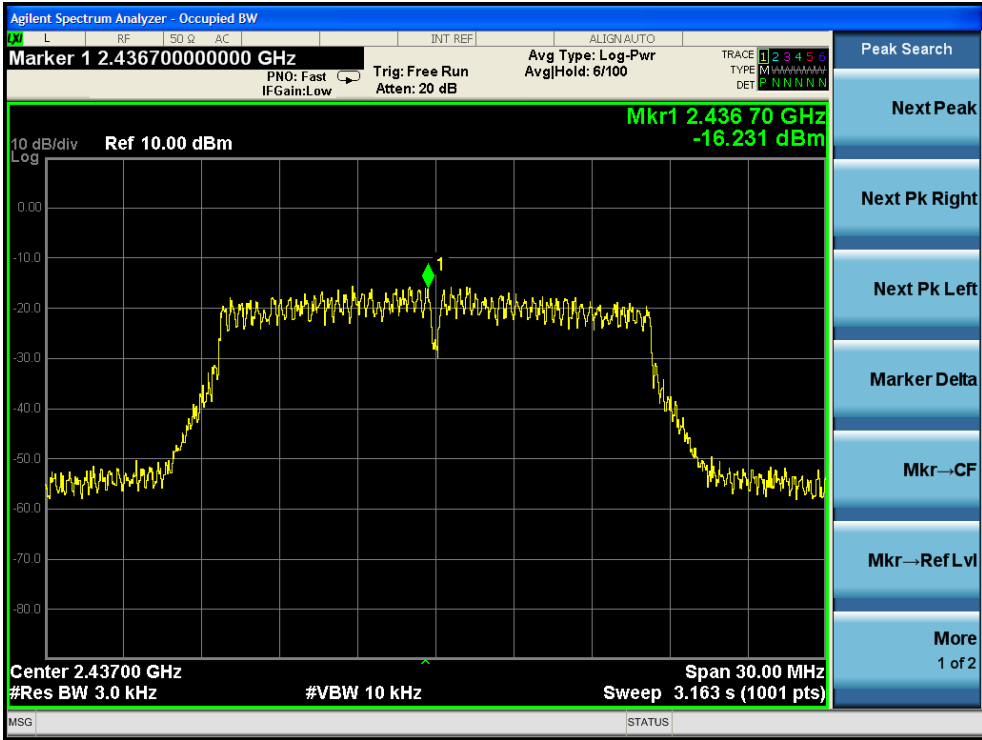

802.11g mode : Middle

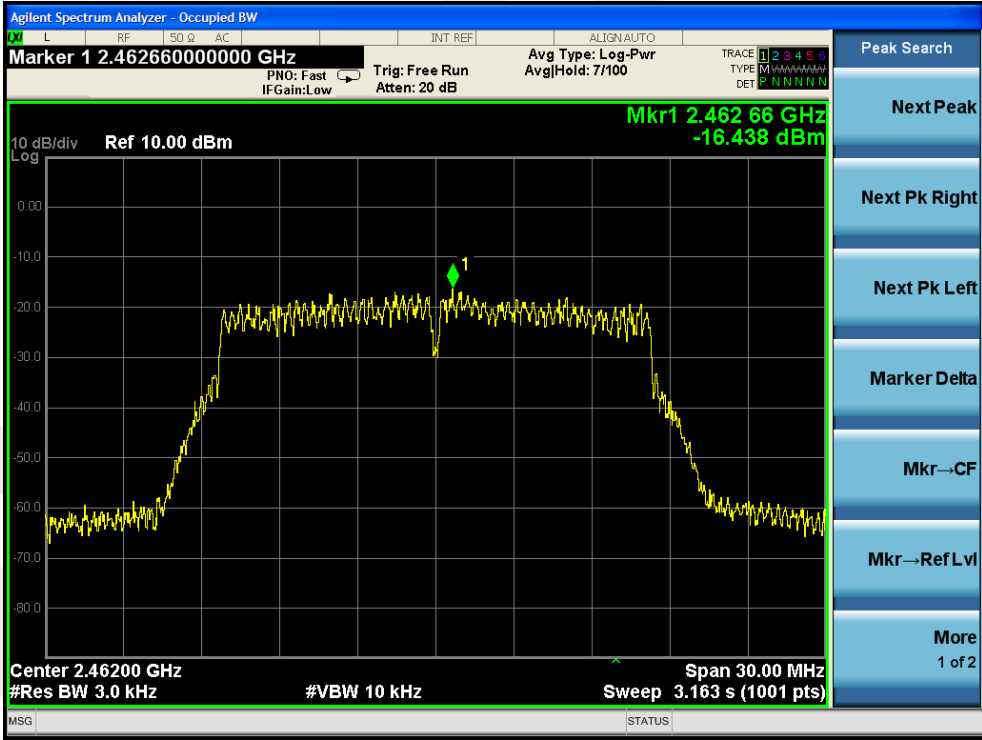

802.11g mode : Highest

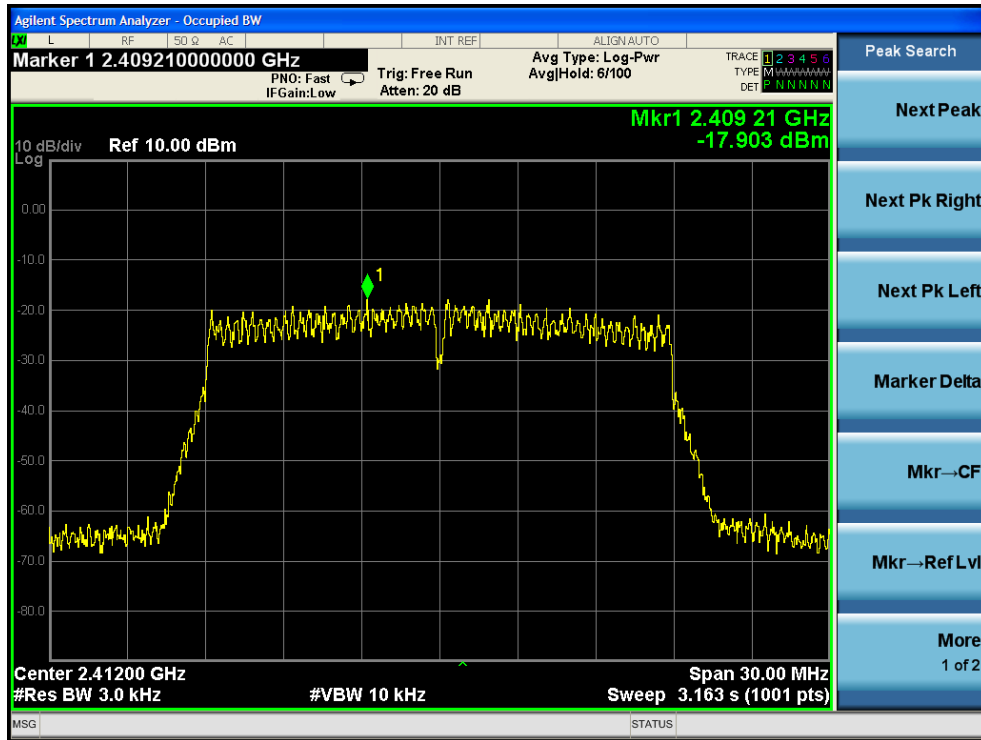

802.11n20 mode : Lowest

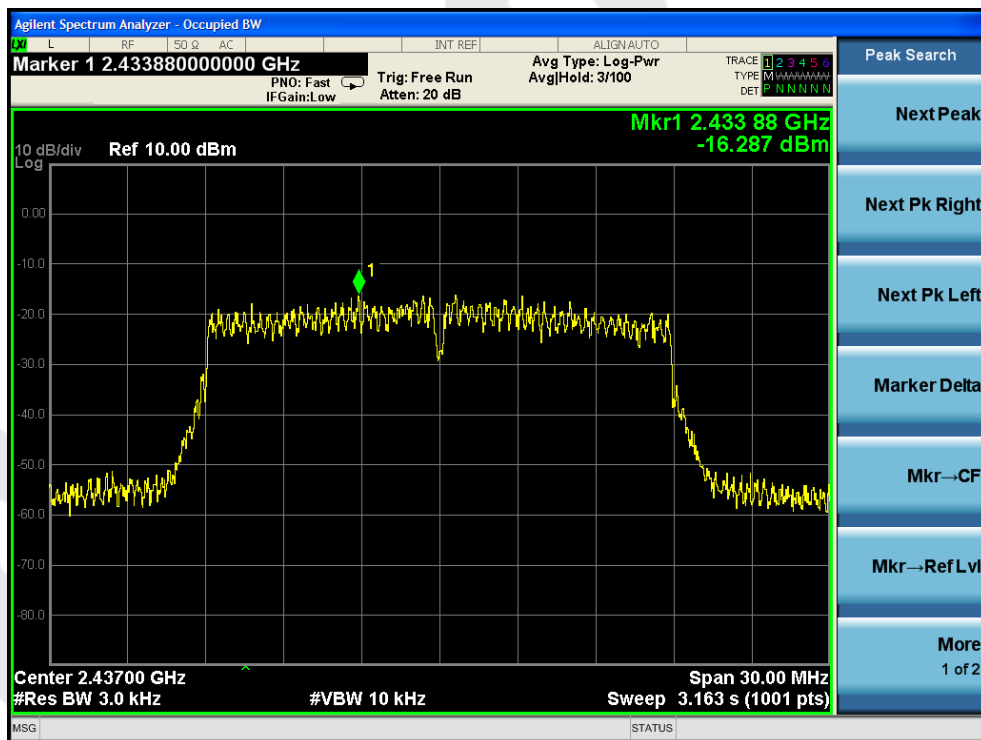

802.11n20 mode : Middle

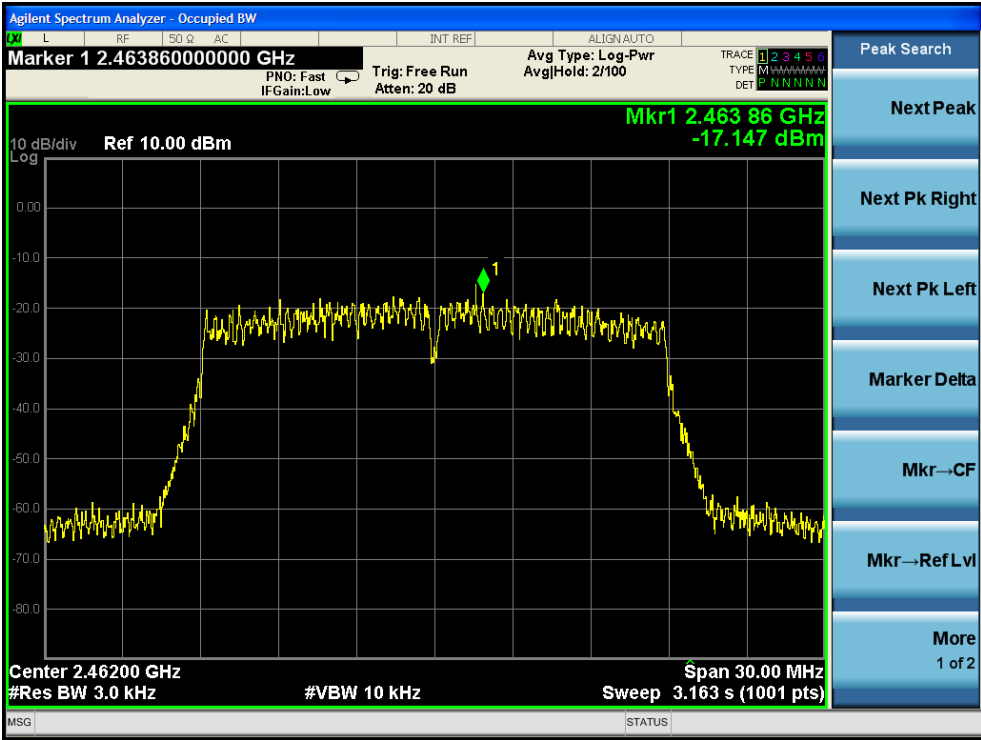

802.11n20 mode : Highest

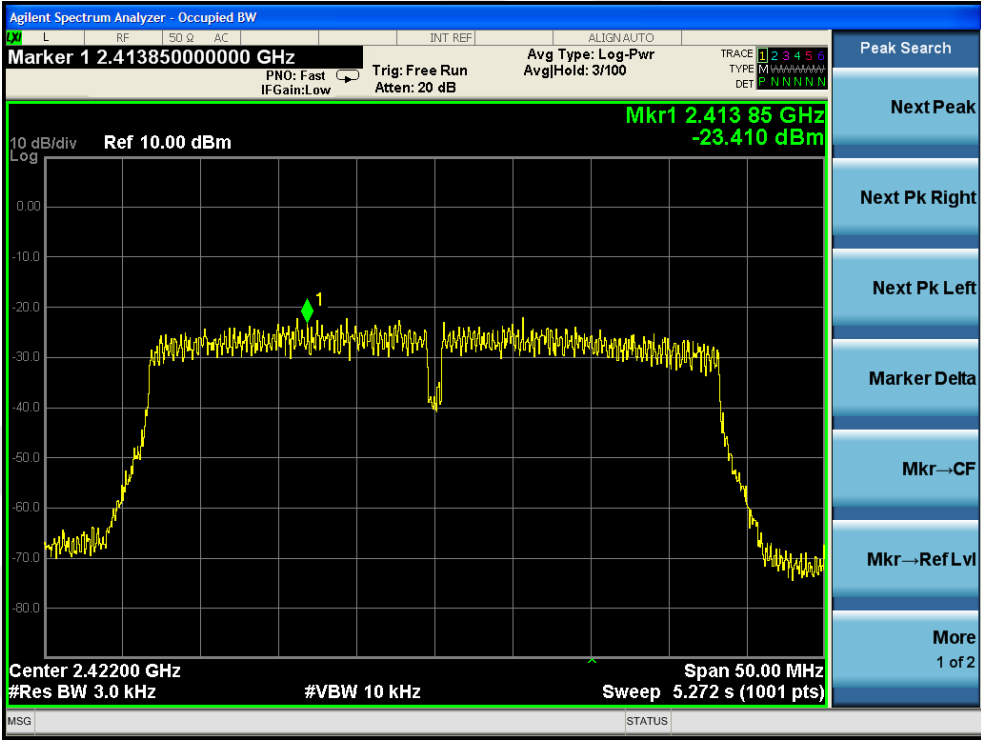

802.11n40 mode : Lowest

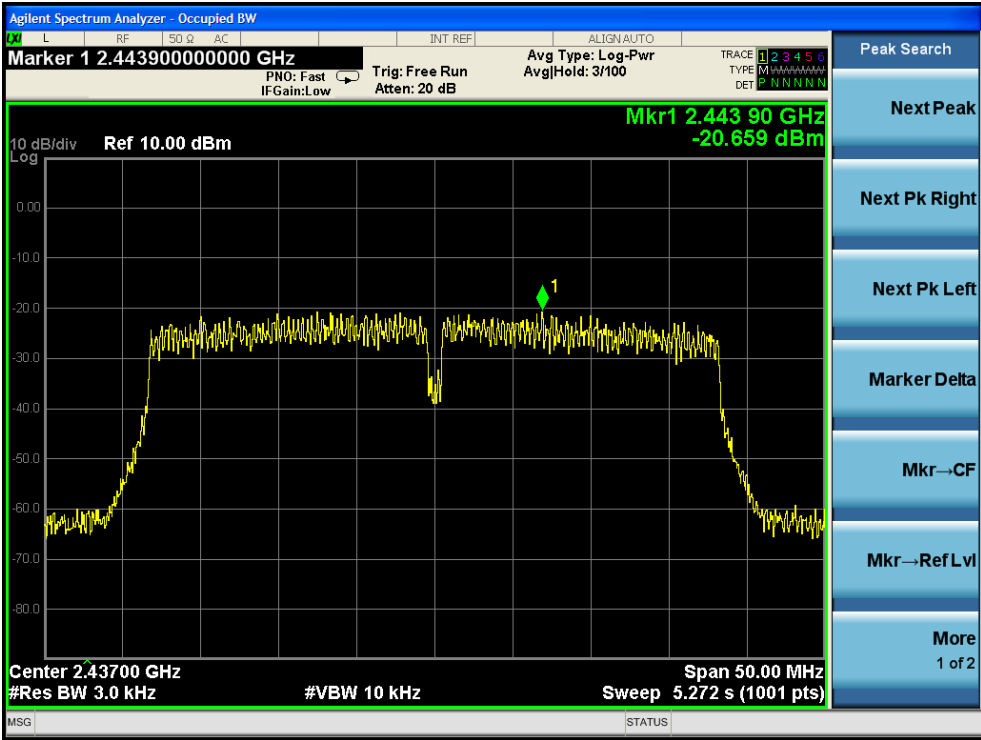

802.11n40 mode : Middle

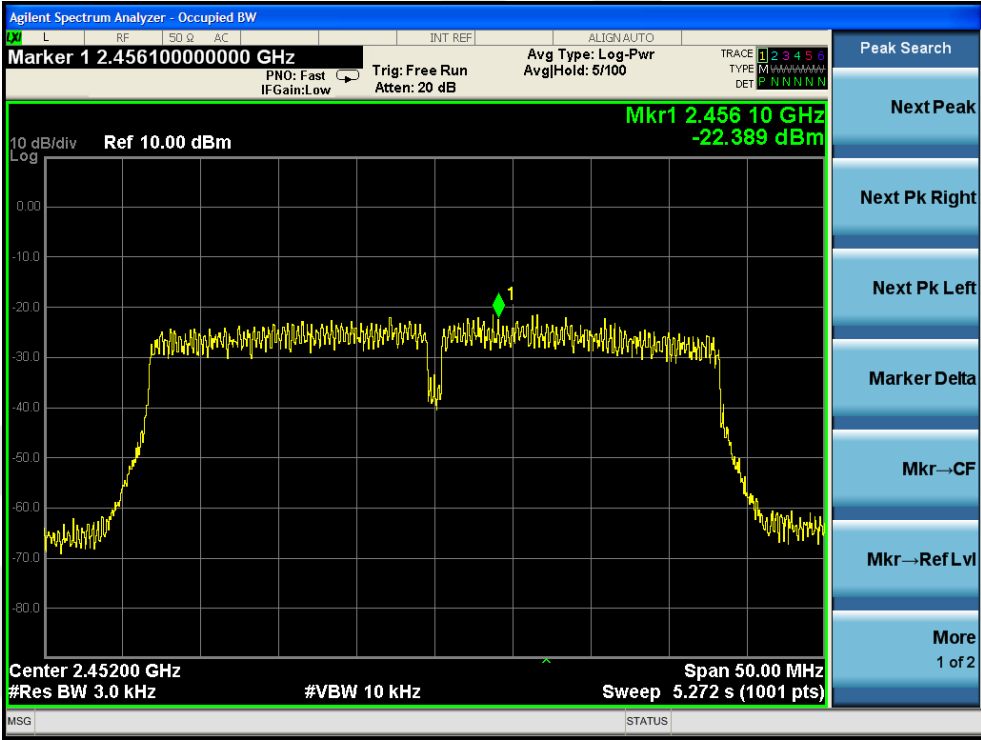

802.11n40 mode : Highest

## 8. 100kHz Bandwidth of Frequency Band Edge Requirement

### 8.1. Test Standard and Limit

Test Standard	FCC Part15 C Section 15.247 (d)
Test Limit	in any 100 kHz bandwidth outside the frequency bands in which the spread spectrum intentional radiator in operating, the radio frequency power that is produced by the intentional radiator shall be at least 20dB below that in the 100kHz bandwidth within the band that contains the highest level of the desired power, In addition, radiated emissions which fall in the restricted bands, as defined in §15.205(a), must also comply with the radiated emission limits specified in 15.209(a).

### 8.2. Test Setup

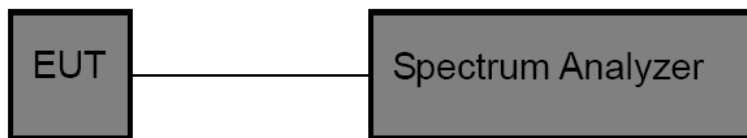

### 8.3. Test Procedure

Using the following spectrum analyzer setting:

1. Set the RBW = 100KHz.
2. Set the VBW = 300KHz.
3. Sweep time = auto couple.
4. Detector function = peak.
5. Trace mode = max hold.
6. Allow trace to fully stabilize.

### 8.4. Test Data

Test Item	: Band edge
Test Voltage	: AC 120V/60Hz
Test Result	: PASS

Test Mode	: CH Low ~ CH High
Temperature	: 24°C
Humidity	: 55%RH



Mode	Frequency Band (MHz)	Delta Peak to Band Emission (dBc)	Limit (dBc)	Results
802.11b	2412	43.313	>20	PASS
	2462	62.069	>20	PASS
802.11g	2412	38.736	>20	PASS
	2462	43.917	>20	PASS
802.11n20	2412	38.194	>20	PASS
	2462	43.646	>20	PASS
802.11n40	2422	28.172	>20	PASS
	2452	29.885	>20	PASS

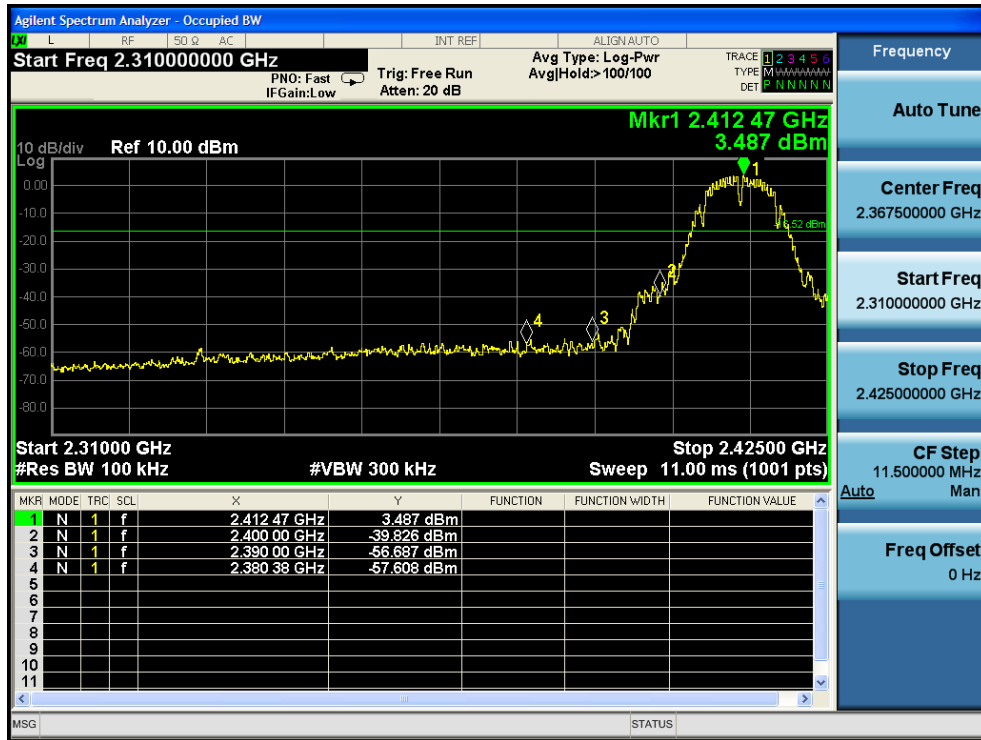

802.11b mode : Lowest



802.11b mode : Highest

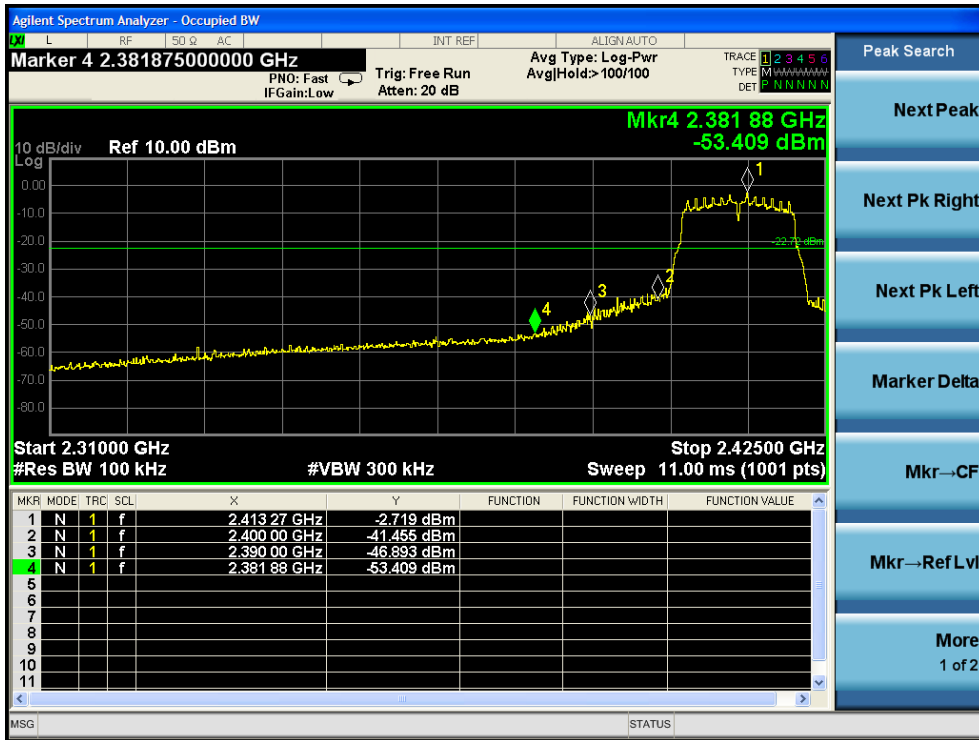

802.11g mode : Lowest



802.11g mode : Highest

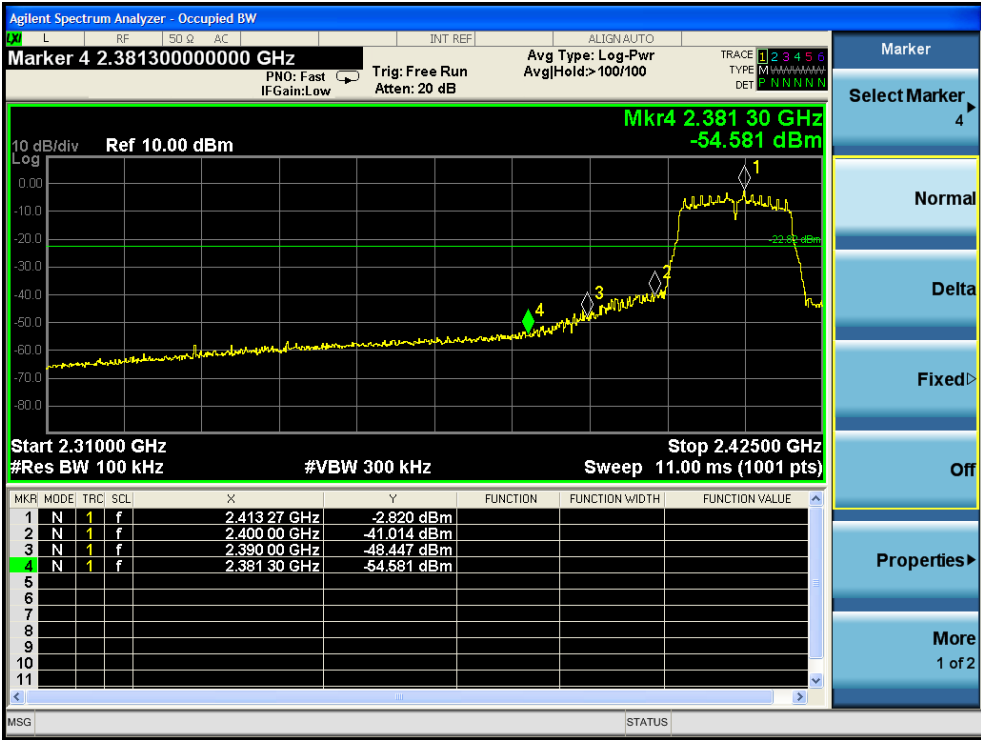

802.11n20 mode : Lowest



802.11n20 mode : Highest



802.11n40 mode : Lowest



802.11n40 mode : Highest

Conducted Emission Method



802.11b mode : Lowest



802.11b mode : Middle



802.11b mode : Highest



802.11g mode : Lowest



802.11g mode : Middle



802.11g mode : Highest





802.11n20 mode : Lowest



802.11n20 mode : Middle



802.11n20 mode : Highest



802.11n40 mode : Lowest



802.11n40 mode : Middle



802.11n40 mode : Highest

## 9. Antenna Requirement

### 9.1. Test Standard and Requirement

Test Standard	FCC Part15 Section 15.203 /247(c)
Requirement	<p>1) 15.203 requirement: An intentional radiator shall be designed to ensure that no antenna other than that furnished by the responsible party shall be used with the device. The use of a permanently attached antenna or of an antenna that uses a unique coupling to the intentional radiator, the manufacturer may design the unit so that a broken antenna can be replaced by the user, but the use of a standard antenna jack or electrical connector is prohibited.</p> <p>2) 15.247(c) (1)(i) requirement: Systems operating in the 2400-2483.5 MHz band that is used exclusively for fixed. Point-to-point operations may employ transmitting antennas with directional gain greater than 6dBi provided the maximum conducted output power of the intentional radiator is reduced by 1 dB for every 3 dB that the directional gain of the antenna exceeds 6 dBi.</p>

### 9.2. Antenna Connected Construction

The WIFI antenna is a PIFA Antenna which permanently attached, and the best case gain of the antenna is 2 dBi. It complies with the standard requirement.



## APPENDIX I -- TEST SETUP PHOTOGRAPH

Please see the test report of R0217060035W1

Anbotek

## **APPENDIX II -- EXTERNAL PHOTOGRAPH**

Please see the test report of R0217060035W1

Anbotek

## APPENDIX III -- INTERNAL PHOTOGRAPH

Please see the test report of R0217060035W1

Anbotek