

# TEST REPORT

**Product Name** : Eye Massager  
CME10A, CME10B, CME10C, CME10D,  
CME10E, CME10F, CME10G, CME10H,  
CME10I, CME10J, CME10K, CME10L,  
**Model Number** : CME10M, CME10N, CME10O, CME10P,  
CME10Q, CME10R, CME10S, CME10T,  
CME10U, CME10V, CME10W, CME10X,  
CME10Y, CME10Z  
**FCC ID** : 2ANDX-CME10X

**Prepared for** : Shenzhen Yolanda Technology Co., Ltd.  
**Address** : Room 201, Jinfulai Building, No.49-1, Dabao Road, Dalang  
Area, Xinan Street, Baoan, Shenzhen, China

**Prepared by** : EMTEK (DONGGUAN) CO., LTD.  
**Address** : -1&2/F., Building 2, Zone A, Zhongda Marine Biotechnology  
Research and Development Base, No.9, Xincheng Avenue,  
Songshanhu High-technology Industrial Development Zone,  
Dongguan, Guangdong, China

TEL: +86-0769-22807078  
FAX: +86-0769-22807079

**Report Number** : EDG2306210136E00201R  
**Date(s) of Tests** : June 21, 2023 to July 10, 2023  
**Date of issue** : July 10, 2023

## Table of Contents

|          |  |           |
|----------|--|-----------|
| <b>1</b> | <b>TEST RESULT CERTIFICATION .....</b>                     | <b>3</b>  |
| <b>2</b> | <b>EUT TECHNICAL DESCRIPTION .....</b>                     | <b>5</b>  |
| <b>3</b> | <b>SUMMARY OF TEST RESULT .....</b>                        | <b>6</b>  |
| <b>4</b> | <b>TEST METHODOLOGY .....</b>                              | <b>7</b>  |
| 4.1      | GENERAL DESCRIPTION OF APPLIED STANDARDS .....             | 7         |
| 4.2      | MEASUREMENT EQUIPMENT USED .....                           | 7         |
| 4.3      | DESCRIPTION OF TEST MODES .....                            | 8         |
| <b>5</b> | <b>FACILITIES AND ACCREDITATIONS .....</b>                 | <b>9</b>  |
| 5.1      | FACILITIES .....   | 9         |
| 5.2      | EQUIPMENT .....  | 9         |
| 5.3      | LABORATORY ACCREDITATIONS AND LISTINGS .....               | 9         |
| <b>6</b> | <b>TEST SYSTEM UNCERTAINTY .....</b>                       | <b>10</b> |
| <b>7</b> | <b>SETUP OF EQUIPMENT UNDER TEST .....</b>                 | <b>11</b> |
| 7.1      | RADIO FREQUENCY TEST SETUP 1 .....                         | 11        |
| 7.2      | RADIO FREQUENCY TEST SETUP 2 .....                         | 11        |
| 7.3      | CONDUCTED EMISSION TEST SETUP .....                        | 14        |
| 7.4      | BLOCK DIAGRAM CONFIGURATION OF TEST SYSTEM .....           | 15        |
| 7.5      | SUPPORT EQUIPMENT .....                                    | 15        |
| <b>8</b> | <b>TEST REQUIREMENTS .....</b>                             | <b>16</b> |
| 8.1      | DTS 6DB BANDWIDTH .....                                    | 16        |
| 8.2      | DTS 99% BANDWIDTH .....                                    | 20        |
| 8.3      | MAXIMUM PEAK CONDUCTED OUTPUT POWER .....                  | 23        |
| 8.4      | MAXIMUM POWER SPECTRAL DENSITY .....                       | 27        |
| 8.5      | UNWANTED EMISSIONS IN NON-RESTRICTED FREQUENCY BANDS ..... | 30        |
| 8.6      | RADIATED SPURIOUS EMISSION .....                           | 39        |
| 8.7      | CONDUCTED EMISSIONS TEST .....                             | 47        |
| 8.8      | ANTENNA APPLICATION .....                                  | 50        |

# 1 TEST RESULT CERTIFICATION

Applicant : Shenzhen Yolanda Technology Co., Ltd.  
 Address : Room 201, Jinfulai Building, No.49-1, Dabao Road, Dalang Area, Xinan Street, Baoan, Shenzhen, China  
 Manufacturer : Shenzhen Yolanda Technology Co., Ltd.  
 Address : Room 201, Jinfulai Building, No.49-1, Dabao Road, Dalang Area, Xinan Street, Baoan, Shenzhen, China  
 EUT : Eye Massager  
 Model Name : CME10A, CME10B, CME10C, CME10D, CME10E, CME10F, CME10G, CME10H, CME10I, CME10J, CME10K, CME10L, CME10M, CME10N, CME10O, CME10P, CME10Q, CME10R, CME10S, CME10T, CME10U, CME10V, CME10W, CME10X, CME10Y, CME10Z  
 Trademark : N/A

Measurement Procedure Used:

| APPLICABLE STANDARDS  |             |
|---|-------------|
| STANDARD  | TEST RESULT |
| FCC 47 CFR Part 2 , Subpart J<br>FCC 47 CFR Part 15, Subpart C                      | PASS        |
| IC RSS-GEN, Issue 5(04-2018)+A1(03-2019)+A2(02-2021)<br>IC RSS-247 Issue 2(02-2017) | PASS        |

The above equipment was tested by EMTEK(DONGGUAN) CO., LTD. The test data, data evaluation, test procedures, and equipment configurations shown in this report were made in accordance with the procedures given in ANSI C63.10 (2013) and the energy emitted by the sample EUT tested as described in this report is in compliance with the requirements of FCC Rules Part 2, Part 15.247, IC RSS-247 Issue 2 and IC RSS-GEN, Issue 5.

The test results of this report relate only to the tested sample identified in this report.

Date of Test : June 21, 2023 to July 10, 2023

*Warren Deng*

Prepared by : Warren Deng /Editor

*Tim Dong*

Reviewer : Tim Dong /Supervisor

*Sam Lv*  

Approve & Authorized Signer : Sam Lv /Manager

## Modified History

| Version | Report No.           | Revision Date | Summary         |
|---------|----------------------|---------------|-----------------|
|         | EDG2306210136E00201R | /             | Original Report |
|         |                      |               |                 |
|         |                      |               |                 |



## 2 EUT TECHNICAL DESCRIPTION

| Characteristics                   | Description  |
|-----------------------------------|--|
| <b>Product:</b>                   | Eye Massager   |
| <b>Model Number:</b>              | CME10A, CME10B, CME10C, CME10D, CME10E, CME10F, CME10G, CME10H, CME10I, CME10J, CME10K, CME10L, CME10M, CME10N, CME10O, CME10P, CME10Q, CME10R, CME10S, CME10T, CME10U, CME10V, CME10W, CME10X, CME10Y, CME10Z<br>These models are the same except the model name and appearance, Here select CME10A for test. |
| <b>Sample number:</b>             | 1#   |
| <b>Device Type:</b>               | Bluetooth V5.0   |
| <b>Data Rate :</b>                | 2Mbps  |
| <b>Modulation:</b>                | GFSK   |
| <b>Operating Frequency Range:</b> | 2402-2480MHz   |
| <b>Number of Channels:</b>        | 40 Channels  |
| <b>Transmit Power Max:</b>        | -0.9 dBm(0.000813 W)   |
| <b>Antenna Type:</b>              | PCB Antenna  |
| <b>Antenna Gain:</b>              | -0.58 dBi  |
| <b>Power Supply:</b>              | DC5V from USB<br>DC 3.7V from battery  |
| <b>Temperature Range:</b>         | -10°C ~ +45°C  |

*Note: for more details, please refer to the User's manual of the EUT.*

### 3 SUMMARY OF TEST RESULT

| FCC Part Clause  | IC Part Clause  | Test Parameter  | Verdict | Remark |
|--|---|---|---------|--------|
| 15.247(a)(2)   | RSS-247 5.2(a)<br>RSS-Gen 6.7   | Emission Bandwidth  | PASS    |        |
| 15.247(b)(3)   | RSS-247 5.4(d)<br>RSS-Gen 6.12  | Maximum Peak Conducted Output Power                           | PASS    |        |
| 15.247(e)  | RSS-247 5.2(b)<br>RSS-Gen 6.12  | Maximum Power Spectral Density Level                          | PASS    |        |
| 15.247(d)  | RSS-247 5.5   | Unwanted Emission Into Non-Restricted Frequency Bands         | PASS    |        |
| 15.247(d)  | RSS-247 5.5   | Unwanted Emission Into Restricted Frequency Bands (conducted) | PASS    |        |
| 15.247(d)<br>15.209<br>15.205  | RSS-Gen 8.9<br>RSS-Gen 8.10<br>RSS-Gen 6.13<br>RSS-247 3.3<br>RSS-247 5.5 | Radiated Spurious Emission                                    | PASS    |        |
| 15.207   | RSS-Gen 8.8   | Conducted Emission Test                                       | PASS    |        |
| 15.203<br>15.247(b)  | RSS-Gen 6.8<br>RSS-247 5.4  | Antenna Application   | PASS    |        |
| NOTE1: N/A (Not Applicable)  |   |   |         |        |
| NOTE2: According to FCC OET KDB 558074, the report use radiated measurements in the restricted frequency bands. In addition, the radiated test is also performed to ensure the emissions emanating from the device cabinet also comply with the applicable limits. |   |   |         |        |

RELATED SUBMITTAL(S)/GRANT(S):

This submittal(s) (test report) is intended for **FCC ID: 2ANDX-CME10X** filing to comply with Section 15.247 of the FCC Part 15, Subpart C Rules.

## 4 TEST METHODOLOGY

### 4.1 GENERAL DESCRIPTION OF APPLIED STANDARDS

According to its specifications, the EUT must comply with the requirements of the following standards:

FCC 47 CFR Part 2, Subpart J

FCC 47 CFR Part 15, Subpart C

IC RSS-GEN, Issue 5(04-2018)+A1(03-2019)+A2(02-2021)

IC RSS-247 Issue 2(02-2017)

FCC KDB 558074 D01 15.247 Meas Guidance v05r02

### 4.2 MEASUREMENT EQUIPMENT USED

#### Conducted Emission Test Equipment

| Equipment                  | Manufacturer         | Model No. | Serial No. | Last Cal. | Cal. Interval |
|----------------------------|----------------------|-----------|------------|-----------|---------------|
| EMI Test Receiver          | Rohde&Schwarz        | ESCI      | 100137     | 2023/5/11 | 1Year         |
| AMN                        | Rohde&Schwarz        | ENV216    | 101209     | 2023/5/11 | 1Year         |
| AMN                        | Rohde&Schwarz        | ENV216    | 100017     | 2023/5/11 | 1Year         |
| RF Switching Unit          | CDS                  | RSU-M2    | 38401      | 2023/5/11 | 1Year         |
| AMN                        | Schwarzbeck          | NNLK8121  | 8121-641   | 2023/5/11 | 1Year         |
| AMN                        | Rohde&Schwarz        | ESH3-Z6   | 101101     | 2023/5/11 | 1Year         |
| AMN                        | Rohde&Schwarz        | ESH3-Z6   | 101102     | 2023/5/11 | 1Year         |
| Power Splitters & Dividers | Weinschel Associates | WA1506A   | A1066      | 2023/5/11 | 1Year         |
| Current Probe              | FCC                  | F-52      | 8377       | 2023/5/11 | 1Year         |
| Passive voltage probe      | Rohde&Schwarz        | ESH2-Z3   | 100122     | 2023/5/11 | 1Year         |

#### For Spurious Emissions Test

| Equipment             | Manufacturer  | Model No. | Serial No.   | Last Cal. | Cal. Interval |
|-----------------------|---------------|-----------|--------------|-----------|---------------|
| EMI Test Receiver     | Rohde&Schwarz | ESCI      | 101415       | 2023/5/11 | 1Year         |
| Bi-log Hybrid Antenna | Schwarzbeck   | VULB9163  | 141          | 2023/5/15 | 1Year         |
| Pre-Amplifie          | HP            | 8447F     | OPTH64       | 2023/5/11 | 1 Year        |
| Signal Analyzer       | R&S           | FSV30     | 103039       | 2023/5/11 | 1 Year        |
| Horn Antenna          | Schwarzbeck   | BBHA9120D | 1272         | 2023/5/15 | 1Year         |
| Horn Antenna          | Schwarzbeck   | BBHA9170  | 9170-567     | 2023/5/15 | 1Year         |
| Pre-Amplifie          | LUNAR EM      | PM1-18-40 | J10100000081 | 2023/5/11 | 1Year         |
| Loop antenna          | Schwarzbeck   | FMZB1519  | 1519-012     | 2023/5/15 | 1Year         |

#### For other test items:

| Equipment                         | Manufacturer | Model No. | Serial No. | Last Cal.  | Cal. Interval |
|-----------------------------------|--------------|-----------|------------|------------|---------------|
| Wireless Connectivity Tester      | R&S          | CMW270    | 102543     | 2023/05/11 | 1Year         |
| Automatic Control Unit            | Tonscend     | JS0806-2  | 2118060480 | 2023/05/11 | 1Year         |
| Signal Analyzer                   | KEYSIGHT     | N9010B    | MY60242456 | 2023/05/11 | 1Year         |
| Analog Signal Generator           | KEYSIGHT     | N5173B    | MY61252625 | 2023/05/11 | 1Year         |
| UP/DOWN-Converter                 | R&S          | CMW-Z800A | 100274     | 2023/05/11 | 1Year         |
| Vector Signal Generator           | KEYSIGHT     | N5182B    | MY61252674 | 2023/05/11 | 1Year         |
| Frequency Extender                | KEYSIGHT     | N5182BX07 | MY59362541 | 2023/05/11 | 1Year         |
| Temperature&Humidity test chamber | ESPEC        | EL-02KA   | 12107166   | 2023/05/11 | 1 Year        |

### 4.3 DESCRIPTION OF TEST MODES

The EUT has been tested under its typical operating condition.

The EUT configuration for testing is installed on RF field strength measurement to meet the Commissions requirement and operating in a manner which intends to maximize its emission characteristics in a continuous normal application.

The Transmitter was operated in the normal operating mode. The TX frequency was fixed which was for the purpose of the measurements.

Test of channel included the lowest and middle and highest frequency to perform the test, then record on this report.

Those data rates (Bluetooth DTS :2Mbps) were used for all test.

Pre-defined engineering program for regulatory testing used to control the EUT for staying in continuous transmitting and receiving mode is programmed.

Frequency and Channel list for Bluetooth DTS:

| Channel | Frequency (MHz) | Channel | Frequency (MHz) | Channel | Frequency (MHz) |
|---------|-----------------|---------|-----------------|---------|-----------------|
| 0       | 2402            | 19      | 2440            | ...     | ...             |
| 1       | 2404            | 20      | 2442            | 37      | 2476            |
| 2       | 2406            | 21      | 2444            | 38      | 2478            |
| ...     | ...             | ...     | ...             | 39      | 2480            |

Note:  $f_c=2402\text{MHz}+k \times 2\text{MHz}$   $k=0$  to 39

Test Frequency and channel for Bluetooth DTS:

| Lowest Frequency |                 | Middle Frequency |                 | Highest Frequency |                 |
|------------------|-----------------|------------------|-----------------|-------------------|-----------------|
| Channel          | Frequency (MHz) | Channel          | Frequency (MHz) | Channel           | Frequency (MHz) |
| 0                | 2402            | 19               | 2440            | 39                | 2480            |



## 5 FACILITIES AND ACCREDITATIONS

### 5.1 FACILITIES

All measurement facilities used to collect the measurement data are located at:

EMTEK (DONGGUAN) CO., LTD.

-1&2/F., Building 2, Zone A, Zhongda Marine Biotechnology Research and Development Base, No.9, Xincheng Avenue, Songshanhu High-technology Industrial Development Zone, Dongguan, Guangdong, China

The sites are constructed in conformance with the requirements of ANSI C63.7, ANSI C63.4 and CISPR Publication 22.

### 5.2 EQUIPMENT

Radiated emissions are measured with one or more of the following types of linearly polarized antennas: tuned dipole, biconical, log periodic, bi-log, and/or ridged waveguide, horn. Spectrum analyzers with preselectors and quasi-peak detectors are used to perform radiated measurements.

Conducted emissions are measured with Line Impedance Stabilization Networks and EMI Test Receivers.

Calibrated wideband preamplifiers, coaxial cables, and coaxial attenuators are also used for making measurements.

All receiving equipment conforms to CISPR Publication 16-1, "Radio Interference Measuring Apparatus and Measurement Methods."

### 5.3 LABORATORY ACCREDITATIONS AND LISTINGS

#### Site Description

EMC Lab.

: Accredited by CNAS, 2020.08.27  
The certificate is valid until 2024.07.05  
The Laboratory has been assessed and proved to be in compliance with CNAS-CL01:2018  
The Certificate Registration Number is L3150

Accredited by FCC  
Designation Number: CN1300  
Test Firm Registration Number: 945551

Accredited by A2LA, April 05, 2021  
The Certificate Registration Number is 4321.02

Accredited by Industry Canada  
The Certificate Registration Number is CN0113

Name of Firm

: EMTEK (DONGGUAN) CO., LTD.

Site Location

: -1&2/F., Building 2, Zone A, Zhongda Marine Biotechnology Research and Development Base, No.9, Xincheng Avenue, Songshanhu High-technology Industrial Development Zone, Dongguan, Guangdong, China

## 6 TEST SYSTEM UNCERTAINTY

The following measurement uncertainty levels have been estimated for tests performed on the apparatus:

| Test Parameter                 | Measurement Uncertainty |
|--------------------------------|-------------------------|
| Radio Frequency                | $\pm 1 \times 10^{-5}$  |
| Maximum Peak Output Power Test | $\pm 1.0\text{dB}$      |
| Conducted Emissions Test       | $\pm 2.0\text{dB}$      |
| Radiated Emission Test         | $\pm 2.0\text{dB}$      |
| Power Density                  | $\pm 2.0\text{dB}$      |
| Occupied Bandwidth Test        | $\pm 1.0\text{dB}$      |
| Band Edge Test                 | $\pm 3\text{dB}$        |
| All emission, radiated         | $\pm 3\text{dB}$        |
| Antenna Port Emission          | $\pm 3\text{dB}$        |
| Temperature                    | $\pm 0.5^\circ\text{C}$ |
| Humidity                       | $\pm 3\%$               |

Measurement Uncertainty for a level of Confidence of 95%

## 7 SETUP OF EQUIPMENT UNDER TEST

### 7.1 RADIO FREQUENCY TEST SETUP 1

The Bluetooth component's antenna ports(s) of the EUT are connected to the measurement instrument per an appropriate attenuator. The EUT is controlled by PC/software to emit the specified signals for the purpose of measurements.

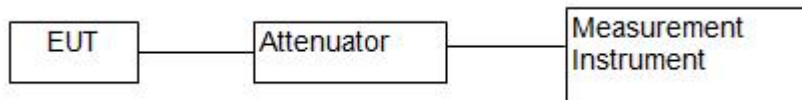

### 7.2 RADIO FREQUENCY TEST SETUP 2

The test site semi-anechoic chamber has met the requirement of NSA tolerance 4 dB according to the standards: ANSI C63.10. The test distance is 3m. The setup is according to the requirements in Section 13.1.4.1 of ANSI C63.10-2013 and CAN/CSA-CEI/IEC CISPR 22.

The maximal emission value is acquired by adjusting the antenna height, polarisation and turntable azimuth. Normally, the height range of antenna is 1 m to 4 m, the azimuth range of turntable is 0° to 360°, and the receive antenna has two polarizations Vertical (V) and Horizontal (H).

Below 30MHz:

The EUT is placed on a turntable 0.8 meters above the ground in the chamber, 3 meter away from the antenna (loop antenna). The Antenna should be positioned with its plane vertical at the specified distance from the EUT and rotated about its vertical axis for maximum response at each azimuth about the EUT. The center of the loop shall be 1 m above the ground. For certain applications, the loop antenna plane may also need to be positioned horizontally at the specified distance from the EUT.

Above 30MHz:

The EUT is placed on a turntable 0.8 meters above the ground in the chamber, 3 meter away from the antenna. The maximal emission value is acquired by adjusting the antenna height, polarisation and turntable azimuth. Normally, the height range of antenna is 1 m to 4 m, the azimuth range of turntable is 0° to 360°, and the receive antenna has two polarizations Vertical (V) and Horizontal (H).

Above 1GHz:

The EUT is placed on a turntable 1.5 meters above the ground in the chamber, 3 meter away from the antenna. The maximal emission value is acquired by adjusting the antenna height, polarisation and turntable azimuth. Normally, the height range of antenna is 1 m to 4 m, the azimuth range of turntable is 0° to 360°, and the receive antenna has two polarizations Vertical (V) and Horizontal (H).

Measurements shall be taken, using the following steps, at a test site that has been validated using the procedures of ANSI C63.4 or the latest CISPR 16-1-4 for measurements above 1 GHz, so as to simulate a near free-space environment (see RSS-Gen for applicable versions of ANSI and CISPR standards).

(1) Line the ground plane with absorbers between the transmitter and the receive antenna to minimize reflections. The absorbers used should have a minimum-rated attenuation of 20 dB through the measurement frequency range of interest. The absorbers shall be positioned to replicate the layout used when compliance with the applicable acceptability criterion was achieved, as set forth in the aforementioned standards on site validation.

(2) Set the height of the receive antenna to 1.5 m. The receive antenna must be one that was designed and fabricated to operate over the entire frequency range of interest, for example, an appropriate standard gain horn.

(3) The distance between the receive antenna and the radiating source shall be sufficient in order to ensure far-field conditions.

(4) Mount the transmitter at a height of 1.5 m.

(5) Configure the device under test (DUT) to produce the maximum power spectral density as measured while assessing compliance with Section 6.2.2 (i.e. channel frequency, modulation type and data rate). If the DUT is equipped with a detachable antenna and the antenna is intended for remote installation (i.e.

tower-mounted), the DUT may be substituted with a suitable signal generator. The level and frequency settings on the generator shall be set so as to reproduce the maximum power spectral density, measured within a 1 MHz bandwidth, obtained while assessing compliance to Section 6.2.2.

(6) Position the transmitter or the radiating antenna so that elevation pattern measurements can be taken.

(7) Find the 0° reference point in the horizontal plane.

(8) Care should be taken when positioning the receive antenna to avoid cross-polarization. Antennas of known mounting polarization should be assessed with the receive antenna oriented in the same polarity. If the polarization of the transmit antenna is unknown or the transmit antenna can be mounted in either polarization, e.i.r.p. measurements should be performed to find which mounting polarity provides the highest e.i.r.p. value. Testing shall be carried out with the receive antenna and the DUT mounted in each polarity.

(9) The emission shall be centred on the display of the spectrum analyzer with the following settings:

i. If the power spectral density of the DUT was assessed with a peak detector and the antenna cannot be detached from the DUT, the spectrum analyzer shall be set to a peak detector with a resolution bandwidth and video bandwidth of 1 MHz.

ii. If the power spectral density of the DUT was assessed using a sample detector with power averaging and the antenna cannot be detached from the DUT, the spectrum analyzer shall be set to a sample detector, configured to produce 100 power averages and set with a resolution bandwidth, as well as a video bandwidth of 1 MHz.

iii. If the antenna can be detached from the DUT, a continuous wave (CW) signal equal to that of the power spectral density measurement may be used, the spectrum analyzer shall be set to peak detector with a resolution bandwidth and video bandwidth of 1 MHz.

(10) Rotate the turntable 360° recording the field strength at each step. Throughout the main beam of the antenna, the step size shall be kept to a maximum of 1°.

Once outside the main beam of the antenna, the maximum step size shall be as follows, when compared to the requirements of Section 6.2.2:

i. Between 0° and 8°, maximum step size of 2°;

ii. Between 8° and 40°, maximum step size of 4°;

iii. Between 40° and 45°, maximum step size of 1°;

iv. Between 45° and 90°, maximum step size of 5°.

Once the mask reaches 90°, the mask will be inverted and the step size will follow in the same manner as above.

For the purpose of this procedure, the main beam of the antenna is defined as the 3 dB beamwidth.

(11) Convert the measured field strength values in terms of e.i.r.p. density (dBW/1 MHz) using the following equation:

$$\text{e.i.r.p. density (dBW/MHz)} = 10 \log((E \cdot r)^2 / 30)$$

E = field strength in V/m

r = measurement distance in metres

(12) Plot the results against the emission mask with reference to the horizontal plane.

(13) Using the plot, the 0° can be rotated to determine the worst-case installation tilt angle.

(14) Testing shall be performed using the highest gain antenna for every antenna type, if applicable.

(15) Antenna type(s), antenna model number(s), and worst-case tilt angle(s) necessary to remain compliant with the elevation mask requirement set forth in Section 6.2.2(3) of RSS-247 shall be clearly indicated in the user manual.

The following figure is an example of a polar elevation mask measured using the Method 1 reference to dBμV/m at 3 m.

(a) Radiated Emission Test Set-Up, Frequency Below 30MHz

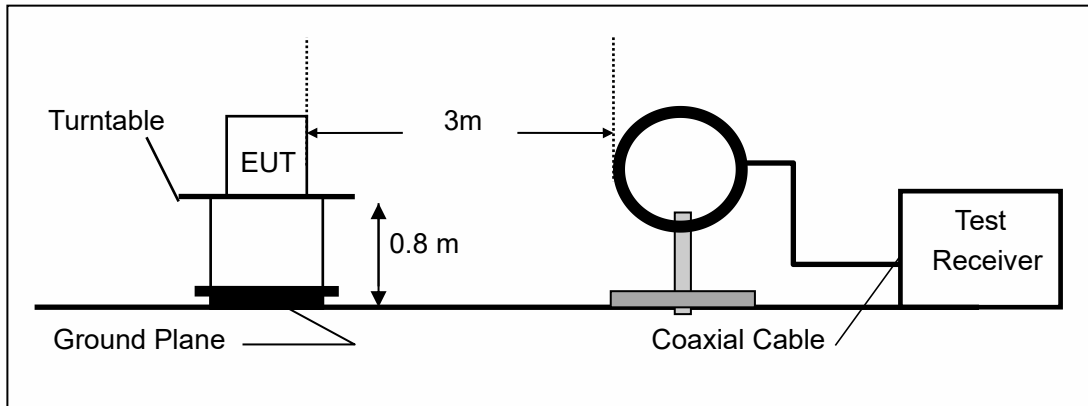

(b) Radiated Emission Test Set-Up, Frequency Below 1000MHz

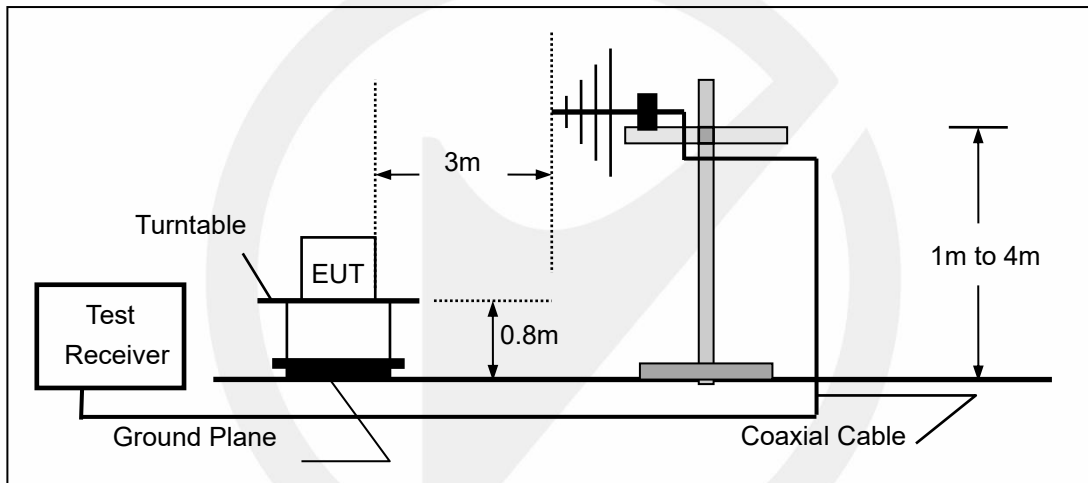

(c) Radiated Emission Test Set-Up, Frequency above 1000MHz

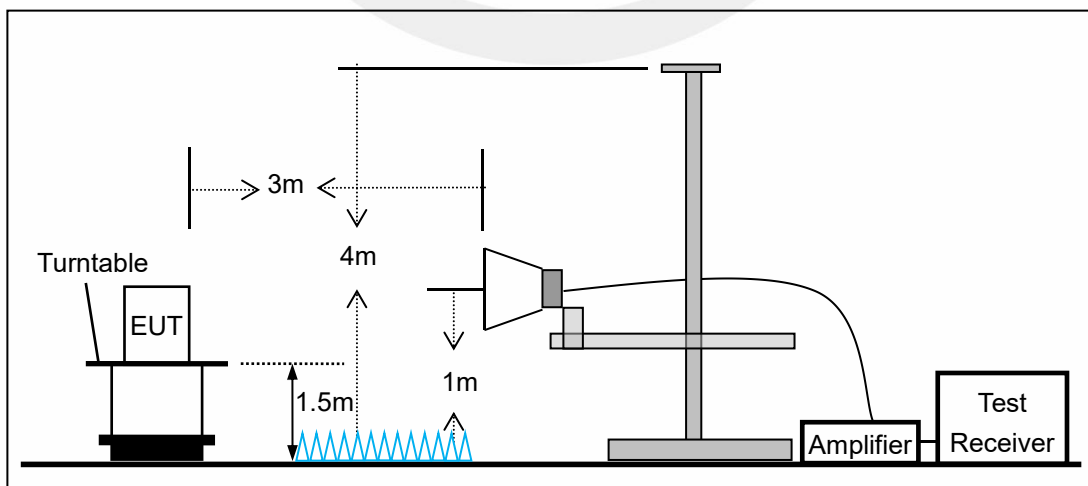

### 7.3 CONDUCTED EMISSION TEST SETUP

The mains cable of the EUT (maybe per AC/DC Adapter) must be connected to LISN. The LISN shall be placed 0.8 m from the boundary of EUT and bonded to a ground reference plane for LISN mounted on top of the ground reference plane. This distance is between the closest points of the LISN and the EUT. All other units of the EUT and associated equipment shall be at least 0.8m from the LISN.

Ground connections, where required for safety purposes, shall be connected to the reference ground point of the LISN and, where not otherwise provided or specified by the manufacturer, shall be of same length as the mains cable and run parallel to the mains connection at a separation distance of not more than 0.8 m.

According to the requirements in Section 13.1.4.1 of ANSI C63.10-2013 Conducted emissions from the EUT measured in the frequency range between 0.15 MHz and 30 MHz using CISPR Quasi-Peak and average detector mode.

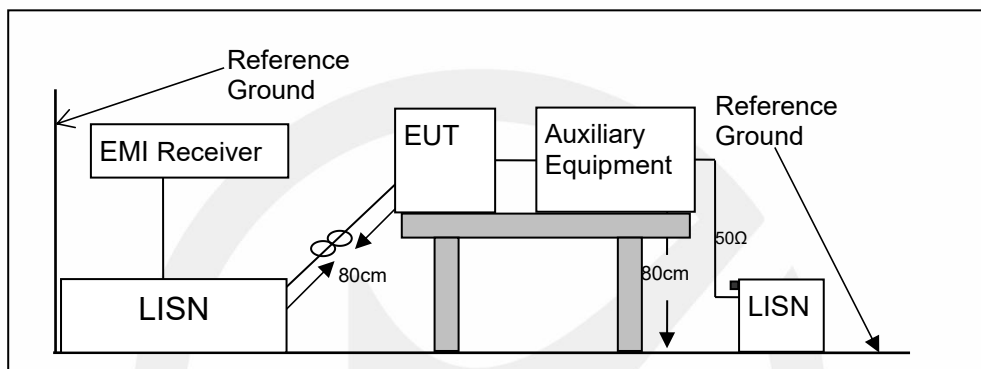

### 7.4 BLOCK DIAGRAM CONFIGURATION OF TEST SYSTEM

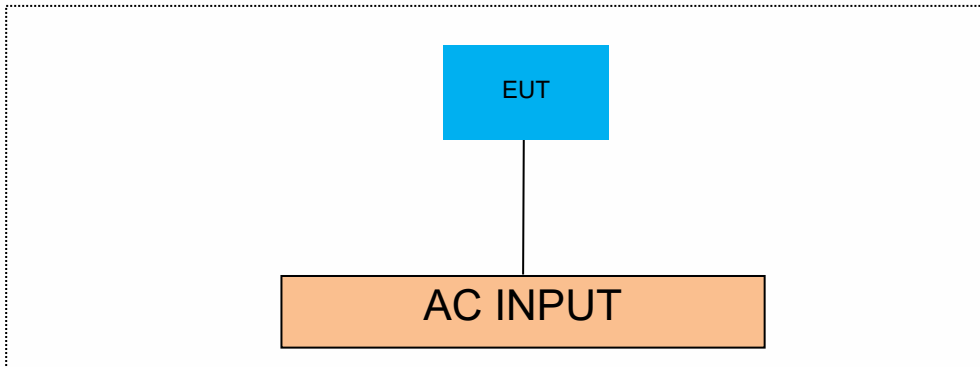

### 7.5 SUPPORT EQUIPMENT

| EUT Equipment List and Details |              |       |               |
|--------------------------------|--------------|-------|---------------|
| Description                    | Manufacturer | Model | Serial Number |
| /                              | /            | /     | /             |

| EUT Cable List and Details |            |                     |                        |
|----------------------------|------------|---------------------|------------------------|
| Cable Description          | Length (m) | Shielded/Unshielded | With / Without Ferrite |
| power line                 | 0.5        | /                   | /                      |
| /                          | /          | /                   | /                      |

| Auxiliary Cable List and Details |            |                     |                        |
|----------------------------------|------------|---------------------|------------------------|
| Cable Description                | Length (m) | Shielded/Unshielded | With / Without Ferrite |
| /                                | /          | /                   | /                      |
| /                                | /          | /                   | /                      |

| Auxiliary Equipment List and Details |              |       |                        |
|--------------------------------------|--------------|-------|------------------------|
| Description                          | Manufacturer | Model | Serial Number          |
| Notebook                             | Lenovo       | E46L  | 11S168003748Z0LR06E0HG |
| /                                    | /            | /     | /                      |

**Notes:**

1. All the equipment/cables were placed in the worst-case configuration to maximize the emission during the test.
2. Grounding was established in accordance with the manufacturer’s requirements and conditions for the intended use.



## 8 TEST REQUIREMENTS

### 8.1 DTS 6DB BANDWIDTH

#### 8.1.1 Applicable Standard

According to FCC Part 15.247(a)(2) and KDB 558074 D01 15.247 Meas Guidance v05r02  
 According to RSS-247 5.2(a)

#### 8.1.2 Conformance Limit

The minimum -6 dB bandwidth shall be at least 500 kHz.

#### 8.1.3 Test Configuration

Test according to clause 7.1 radio frequency test setup 1

#### 8.1.4 Test Procedure

The EUT was operating in Bluetooth mode and controlled its channel. Printed out the test result from the spectrum by hard copy function.

The RF output of EUT was connected to the spectrum analyzer by RF cable and attenuator. The path loss was compensated to the results for each measurement.

Set to the maximum power setting and enable the EUT transmit continuously

Set RBW = 100 kHz.

Set the video bandwidth (VBW) =300 kHz.

Set Span=2 times OBW

Set Detector = Peak.

Set Trace mode = max hold.

Set Sweep = auto couple.

Allow the trace to stabilize.

Measure the maximum width of the emission that is constrained by the frequencies associated with the two outermost amplitude points (upper and lower frequencies) that are attenuated by 6 dB relative to the maximum level measured in the fundamental emission.

Measure and record the results in the test report.

#### Test Results

|                    |           |
|--------------------|-----------|
| Temperature:       | 25°C      |
| Relative Humidity: | 45%       |
| ATM Pressure:      | 1011 mbar |

Note: N/A



| TestMode | Antenna | Frequency[MHz] | DTS BW [MHz] | FL[MHz]  | FH[MHz]  | Limit[MHz] | Verdict |
|----------|---------|----------------|--------------|----------|----------|------------|---------|
| BLE_2M   | Ant1    | 2402           | 0.860        | 2401.428 | 2402.288 | 0.5        | PASS    |
| BLE_2M   | Ant1    | 2440           | 0.864        | 2439.428 | 2440.292 | 0.5        | PASS    |
| BLE_2M   | Ant1    | 2480           | 0.860        | 2479.428 | 2480.288 | 0.5        | PASS    |





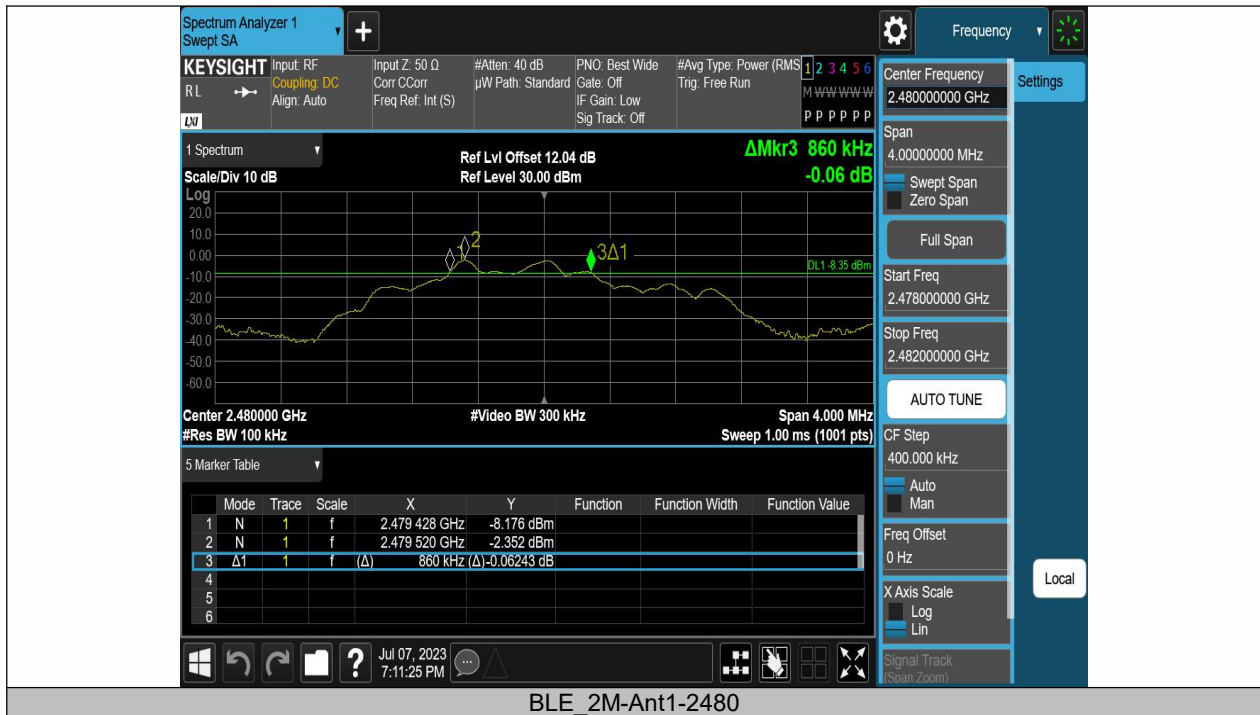

## 8.2 DTS 99% BANDWIDTH

### 8.2.1 Applicable Standard

According to RSS-Gen 6.7 and KDB 558074 D01 DTS Meas Guidance v05r02

### 8.2.2 Test Configuration

Test according to clause 7.1 radio frequency test setup 1

### 8.2.3 Test Procedure

The EUT was operating in Bluetooth mode and controlled its channel. Printed out the test result from the spectrum by hard copy function.

The RF output of EUT was connected to the spectrum analyzer by RF cable and attenuator. The path loss was compensated to the results for each measurement.

Set to the maximum power setting and enable the EUT transmit continuously

Set RBW = 1%-5% OBW(43 KHz).

Set the video bandwidth (VBW) =130 kHz.

Set Span=4 MHz

Set Detector = Peak.

Set Trace mode = max hold.

Set Sweep = auto couple.

Allow the trace to stabilize.

Use the 99 % power bandwidth function of the instrument

Measure the maximum width of the emission.

Measure and record the results in the test report.

### 8.2.4 Test Results

|                    |           |
|--------------------|-----------|
| Temperature:       | 25°C      |
| Relative Humidity: | 45%       |
| ATM Pressure:      | 1011 mbar |

Note: N/A

| TestMode | Antenna | Frequency[MHz] | OCB [MHz] | FL[MHz]   | FH[MHz]   | Limit[MHz] | Verdict |
|----------|---------|----------------|-----------|-----------|-----------|------------|---------|
| BLE_2M   | Ant1    | 2402           | 2.0594    | 2400.9985 | 2403.0579 | ---        | ---     |
| BLE_2M   | Ant1    | 2440           | 2.0580    | 2438.9996 | 2441.0576 | ---        | ---     |
| BLE_2M   | Ant1    | 2480           | 2.0596    | 2478.9990 | 2481.0586 | ---        | ---     |

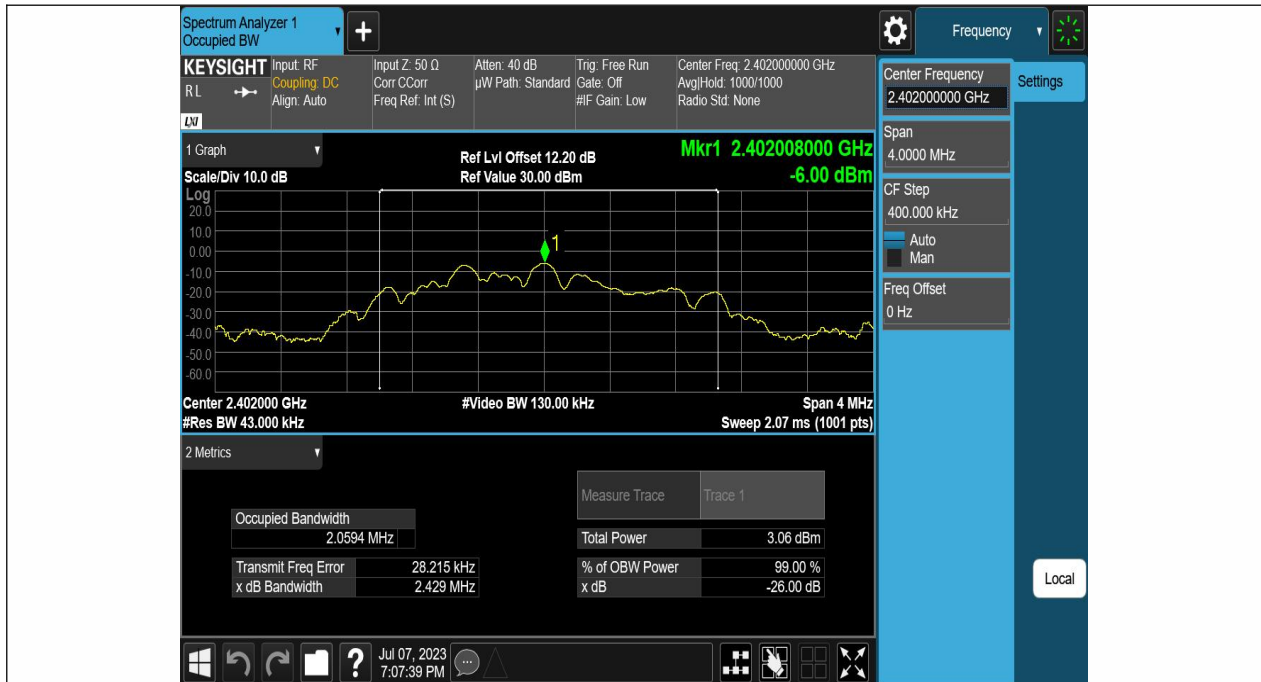

BLE\_2M-Ant1-2402



BLE\_2M-Ant1-2440



### 8.3 MAXIMUM PEAK CONDUCTED OUTPUT POWER

#### 8.3.1 Applicable Standard

According to FCC Part 15.247(b)(3) and KDB 558074 D01 15.247 Meas Guidance v05r02  
 According to RSS-247 5.4(d) and RSS-Gen 6.12

#### 8.3.2 Conformance Limit

The maximum peak conducted output power of the intentional radiator for systems using digital modulation in the 2400 - 2483.5 MHz bands shall not exceed: 1 Watt (30 dBm).

#### 8.3.3 Test Configuration

Test according to clause 7.1 radio frequency test setup 1

#### 8.3.4 Test Procedure

As an alternative to a peak power measurement, compliance with the one Watt limit can be based on a measurement of the maximum conducted output power. For smart system, Maximum Conducted Output Power is defined as the total transmit power delivered to all antennas and antenna elements averaged across all symbols in the signaling alphabet when the transmitter is operating at its maximum power control level. Power must be summed across all antennas and antenna elements. If multiple modes of operation are possible (e.g., alternative modulation methods), the maximum conducted output power is the highest total transmit power occurring in any mode.

Set the RBW  $\geq$  DTS bandwidth(about 2MHz).

Set VBW =3\*RBW(about 6MHz)

Set the span  $\geq$  3\*RBW

Set Sweep time = auto couple.

Set Detector = peak.

Set Trace mode = max hold.

Allow trace to fully stabilize. Use peak marker function to determine the peak amplitude level.

Conducted output power limit specified in paragraph (b) of this section is based on the use of antennas with directional gains that do not exceed 6 dBi. If transmitting antennas of directional gain greater than 6 dBi are used, the conducted output power from the intentional radiator shall be reduced below the stated values in paragraphs (b)(3) of this section, as appropriate, by the amount in dB that the directional gain of the antenna exceeds 6 dBi.

#### 8.3.5 Test Results

|                    |           |
|--------------------|-----------|
| Temperature:       | 25 °C     |
| Relative Humidity: | 45%       |
| ATM Pressure:      | 1011 mbar |

Note: N/A



| TestMode | Antenna | Frequency[MHz] | Conducted Peak Power[dBm] | Conducted Limit[dBm] | EIRP[dBm] | EIRP Limit[dBm] | Verdict |
|----------|---------|----------------|---------------------------|----------------------|-----------|-----------------|---------|
| BLE_2M   | Ant1    | 2402           | -1.1                      | ≤30                  | -1.68     | ≤36             | PASS    |
| BLE_2M   | Ant1    | 2440           | -0.9                      | ≤30                  | -1.48     | ≤36             | PASS    |
| BLE_2M   | Ant1    | 2480           | -1.25                     | ≤30                  | -1.83     | ≤36             | PASS    |





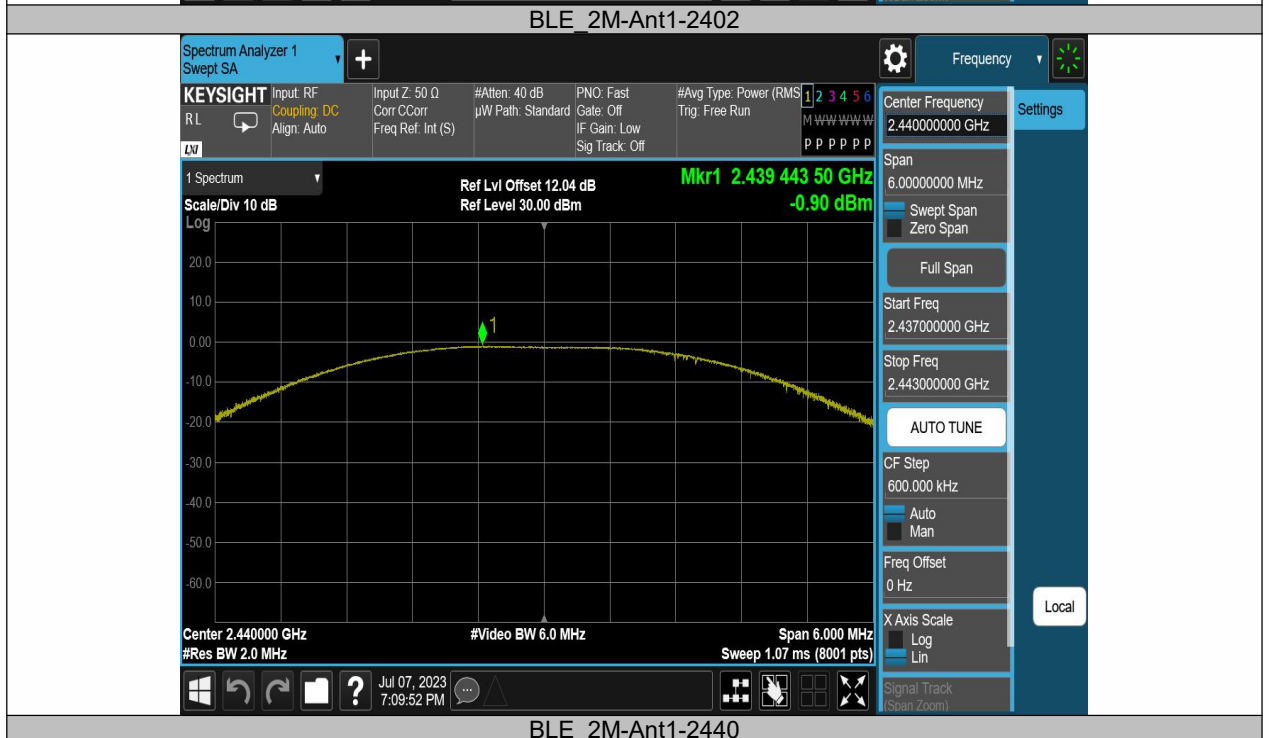



## 8.4 MAXIMUM POWER SPECTRAL DENSITY

### 8.4.1 Applicable Standard

According to FCC Part 15.247(e) and KDB 558074 D01 15.247 Meas Guidance v05r02  
 According to RSS-247 5.2(b) and RSS-Gen 6.12

### 8.4.2 Conformance Limit

The transmitter power spectral density conducted from the transmitter to the antenna shall not be greater than 8 dBm in any 3 kHz band during any time interval of continuous transmission.

### 8.4.3 Test Configuration

Test according to clause 7.1 radio frequency test setup 1

### 8.4.4 Test Procedure

This procedure shall be used if maximum peak conducted output power was used to demonstrate compliance

The transmitter output (antenna port) was connected to the spectrum analyzer

Set analyzer center frequency to DTS channel center frequency.

Set the span to 1.5 times the DTS bandwidth.

Set the RBW to: 3 kHz

Set the VBW to: 10 kHz.

Set Detector = peak.

Set Sweep time = auto couple.

Set Trace mode = max hold.

Allow trace to fully stabilize.

Use the peak marker function to determine the maximum amplitude level within the RBW.

### 8.4.5 Test Results

|                    |           |
|--------------------|-----------|
| Temperature:       | 25 °C     |
| Relative Humidity: | 45%       |
| ATM Pressure:      | 1011 mbar |

Note: N/A

| TestMode | Antenna | Frequency[MHz] | Result[dBm/3kHz] | Limit[dBm/3kHz] | Verdict |
|----------|---------|----------------|------------------|-----------------|---------|
| BLE_2M   | Ant1    | 2402           | -23.78           | ≤8.00           | PASS    |
| BLE_2M   | Ant1    | 2440           | -23.57           | ≤8.00           | PASS    |
| BLE_2M   | Ant1    | 2480           | -24.05           | ≤8.00           | PASS    |

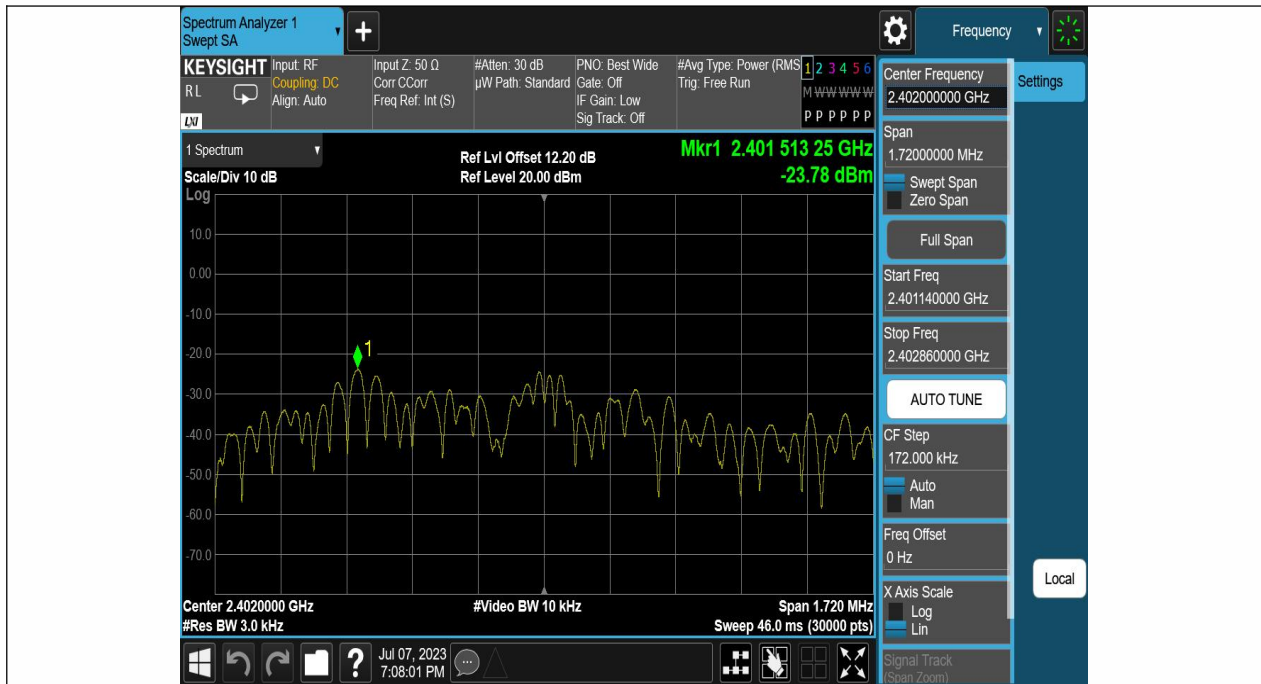

BLE\_2M-Ant1-2402

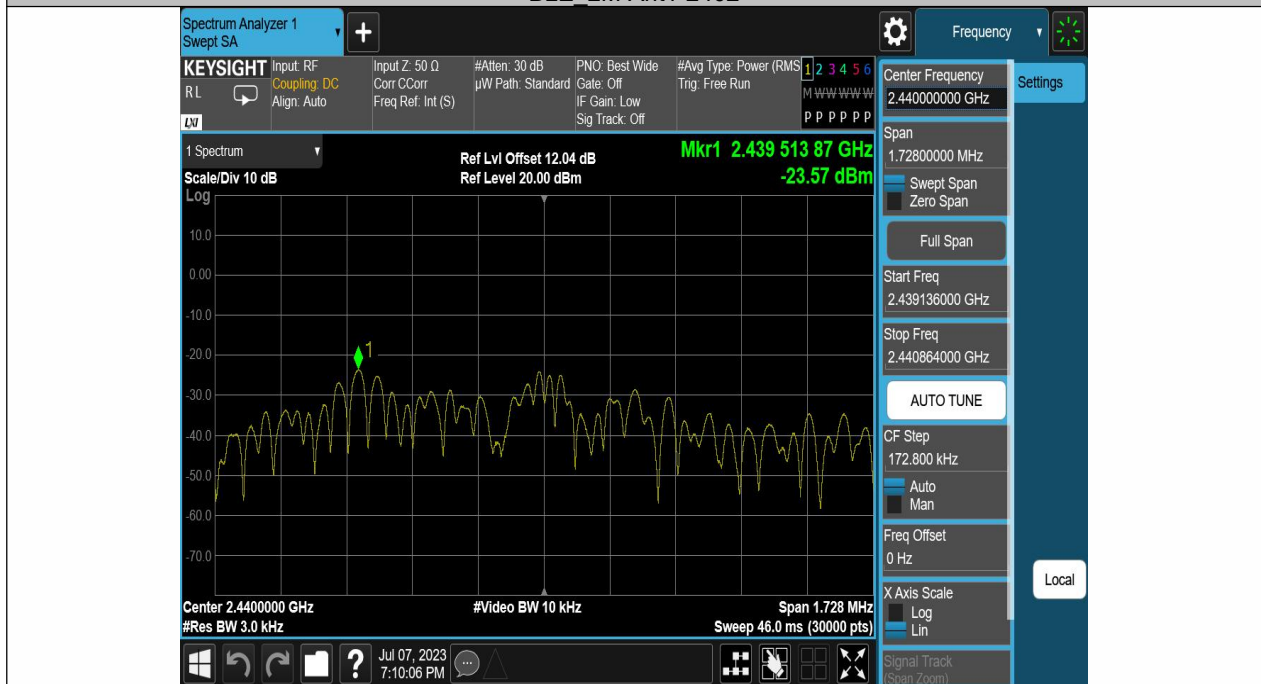

BLE\_2M-Ant1-2440

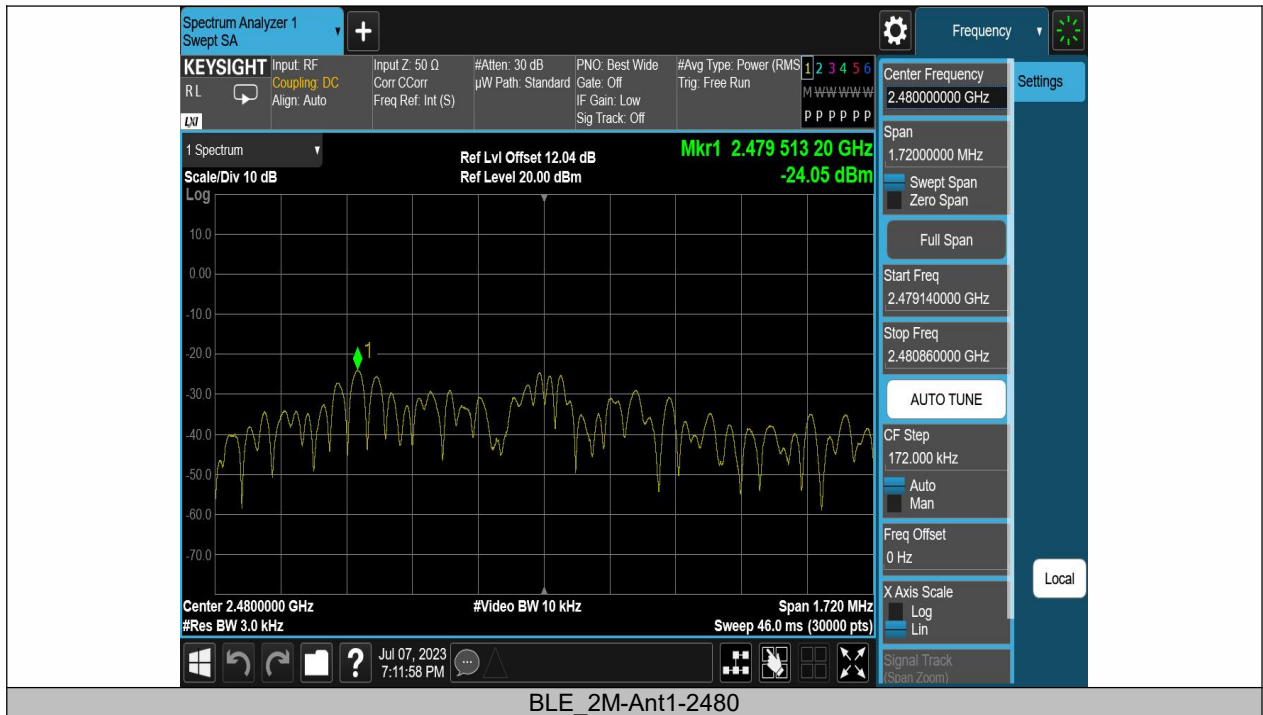

## 8.5 UNWANTED EMISSIONS IN NON-RESTRICTED FREQUENCY BANDS

### 8.5.1 Applicable Standard

According to FCC Part 15.247(d) and KDB 558074 D01 15.247 Meas Guidance v05r02  
According to RSS-247 5.5

### 8.5.2 Conformance Limit

In any 100 kHz bandwidth outside the frequency band in which the spread spectrum or digitally modulated intentional radiator is operating, the radio frequency power that is produced by the intentional radiator shall be at least 20 dB below that in the 100 kHz bandwidth within the band that contains the highest level of the desired power, based on either an RF conducted or a radiated measurement, provided the transmitter demonstrates compliance with the peak conducted power limits. If the transmitter complies with the conducted power limits based on the use of RMS averaging over a time interval, as permitted under paragraph (b)(3) of this section, the attenuation required under this paragraph shall be 30 dB instead of 20 dB.

### 8.5.3 Test Configuration

Test according to clause 7.1 radio frequency test setup 1

### 8.5.4 Test Procedure

The transmitter output (antenna port) was connected to the spectrum analyzer

#### ■ Reference level measurement

Establish a reference level by using the following procedure:

Set instrument center frequency to DTS channel center frequency.

Set the span to = 1.5 times the DTS bandwidth.

Set the RBW = 100 kHz.

Set the VBW  $\geq 3 \times$  RBW.

Set Detector = peak.

Set Sweep time = auto couple.

Set Trace mode = max hold.

Allow trace to fully stabilize.

Use the peak marker function to determine the maximum PSD level.

Note that the channel found to contain the maximum PSD level can be used to establish the reference level.

#### ■ Band-edge measurement

Use the following spectrum analyzer settings:

Span = wide enough to capture the peak level of the emission operating on the channel closest to the band-edge, as well as any modulation products which fall outside of the authorized band of operation

Set RBW  $\geq 1\%$  of the span=100kHz Set VBW  $\geq 3 \times$  RBW

Set Sweep = auto Set Detector function = peak Set Trace = max hold

Allow the trace to stabilize. Set the marker on the emission at the bandedge, or on the highest modulation product outside of the band, if this level is greater than that at the bandedge. Enable the marker-delta function, then use the marker-to-peak function to move the marker to the peak of the in-band emission. The marker-delta value now displayed must comply with the limit specified in this Section.

#### ■ Emission level measurement

Set the center frequency and span to encompass frequency range to be measured.

Set the RBW = 100 kHz.

Set the VBW =300 kHz.

Set Detector = peak

Sweep time = auto couple.

Trace mode = max hold.

Allow trace to fully stabilize.



Use the peak marker function to determine the maximum amplitude level.

Ensure that the amplitude of all unwanted emissions outside of the authorized frequency band (excluding restricted frequency bands) are attenuated by at least the minimum requirements . Report the three highest emissions relative to the limit.

### 8.5.5 Test Results

|                    |           |
|--------------------|-----------|
| Temperature:       | 25 °C     |
| Relative Humidity: | 45%       |
| ATM Pressure:      | 1011 mbar |

Note: N/A

#### Band edge

| TestMode | Antenna | ChName | Frequency[MHz] | RefLevel[dBm] | Result[dBm] | Limit[dBm] | Verdict |
|----------|---------|--------|----------------|---------------|-------------|------------|---------|
| BLE_2M   | Ant1    | Low    | 2402           | -1.89         | -33.75      | ≤-21.89    | PASS    |
| BLE_2M   | Ant1    | High   | 2480           | -2.13         | -47.31      | ≤-22.13    | PASS    |

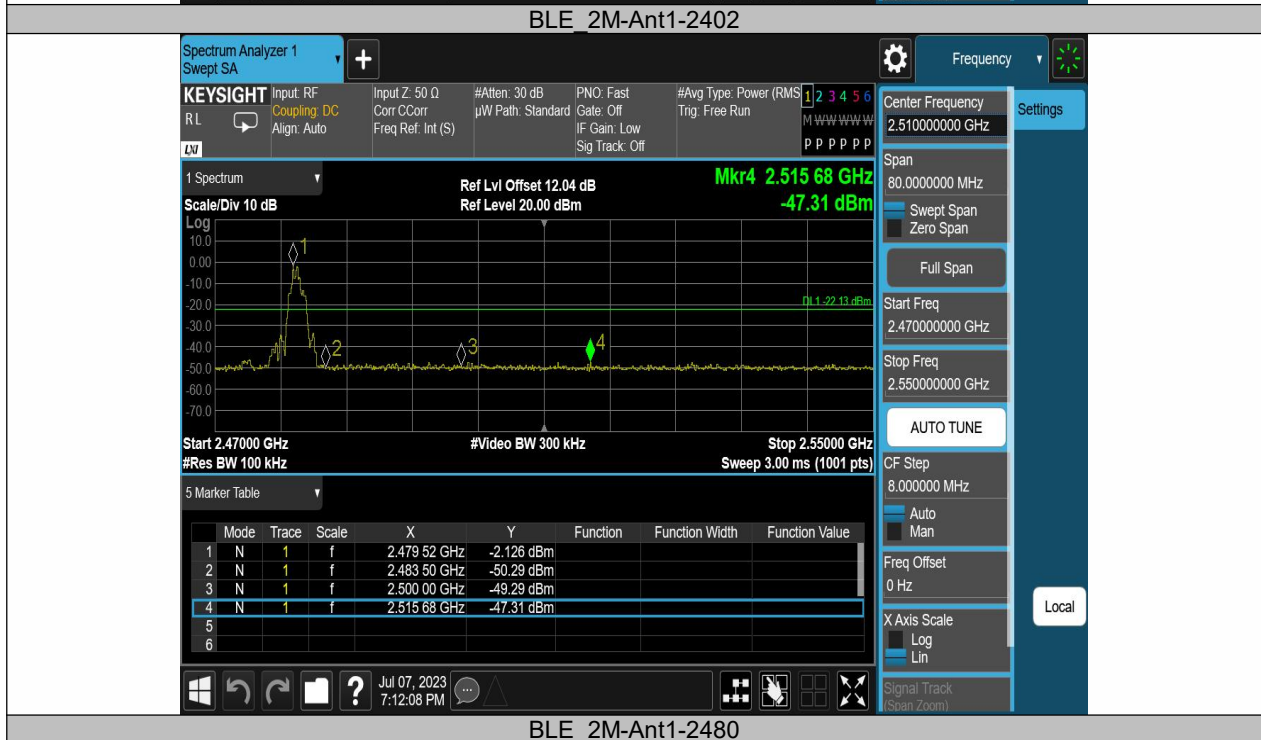
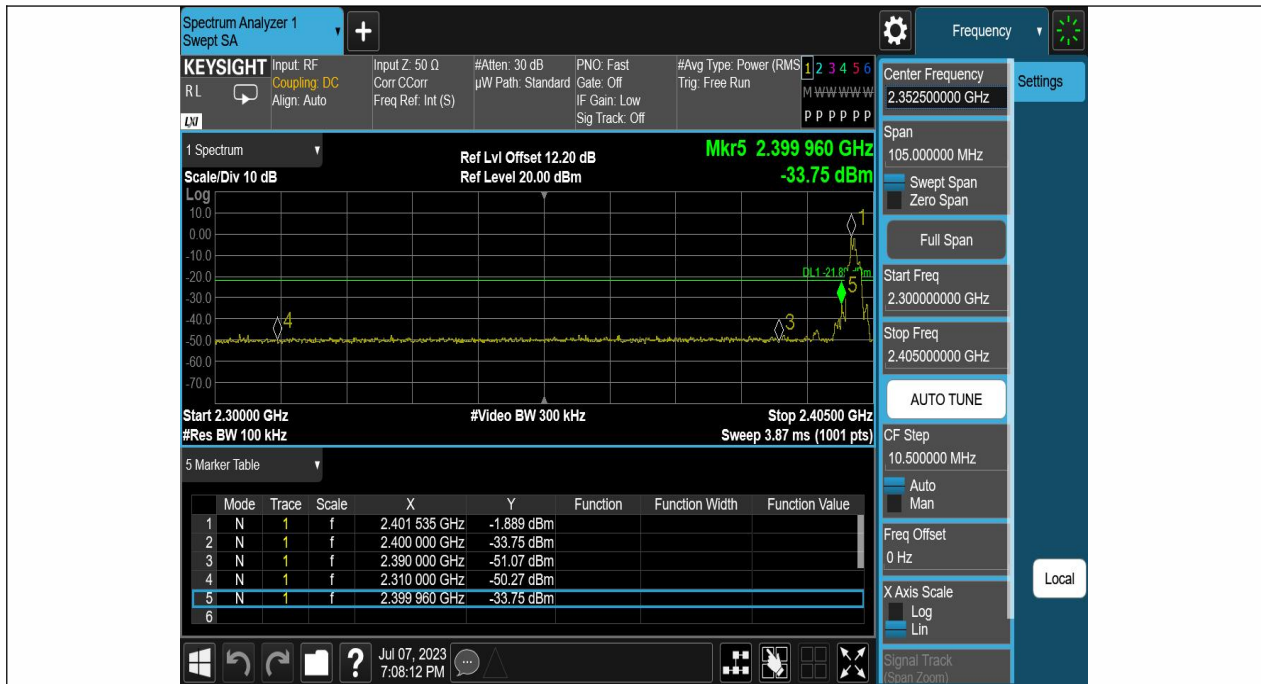



### Conducted Spurious Emission

| TestMode | Antenna | Frequency[MHz] | FreqRange [MHz] | RefLevel [dBm] | Result[dBm] | Limit[dBm] | Verdict |
|----------|---------|----------------|-----------------|----------------|-------------|------------|---------|
| BLE_2M   | Ant1    | 2402           | 0~Reference     | -1.97          | -1.97       | ---        | PASS    |
| BLE_2M   | Ant1    | 2402           | 1000~26500      | -1.97          | -49.78      | ≤-21.97    | PASS    |
| BLE_2M   | Ant1    | 2402           | 30~1000         | -1.97          | -57.44      | ≤-21.97    | PASS    |
| BLE_2M   | Ant1    | 2440           | 0~Reference     | -1.75          | -1.75       | ---        | PASS    |
| BLE_2M   | Ant1    | 2440           | 1000~26500      | -1.75          | -49.04      | ≤-21.75    | PASS    |
| BLE_2M   | Ant1    | 2440           | 30~1000         | -1.75          | -57.25      | ≤-21.75    | PASS    |
| BLE_2M   | Ant1    | 2480           | 0~Reference     | -2.16          | -2.16       | ---        | PASS    |
| BLE_2M   | Ant1    | 2480           | 1000~26500      | -2.16          | -48.93      | ≤-22.16    | PASS    |
| BLE_2M   | Ant1    | 2480           | 30~1000         | -2.16          | -57.78      | ≤-22.16    | PASS    |





BLE 2M-Ant1-2402-0~Reference



BLE 2M-Ant1-2402-1000~26500

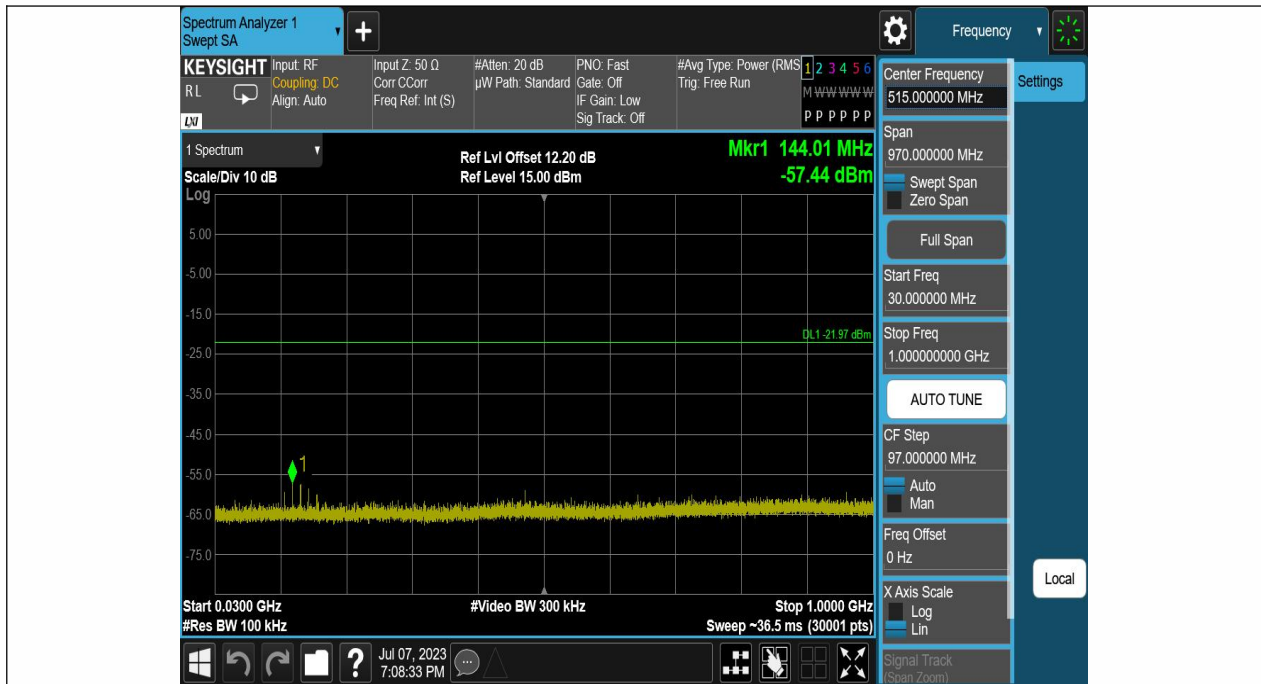

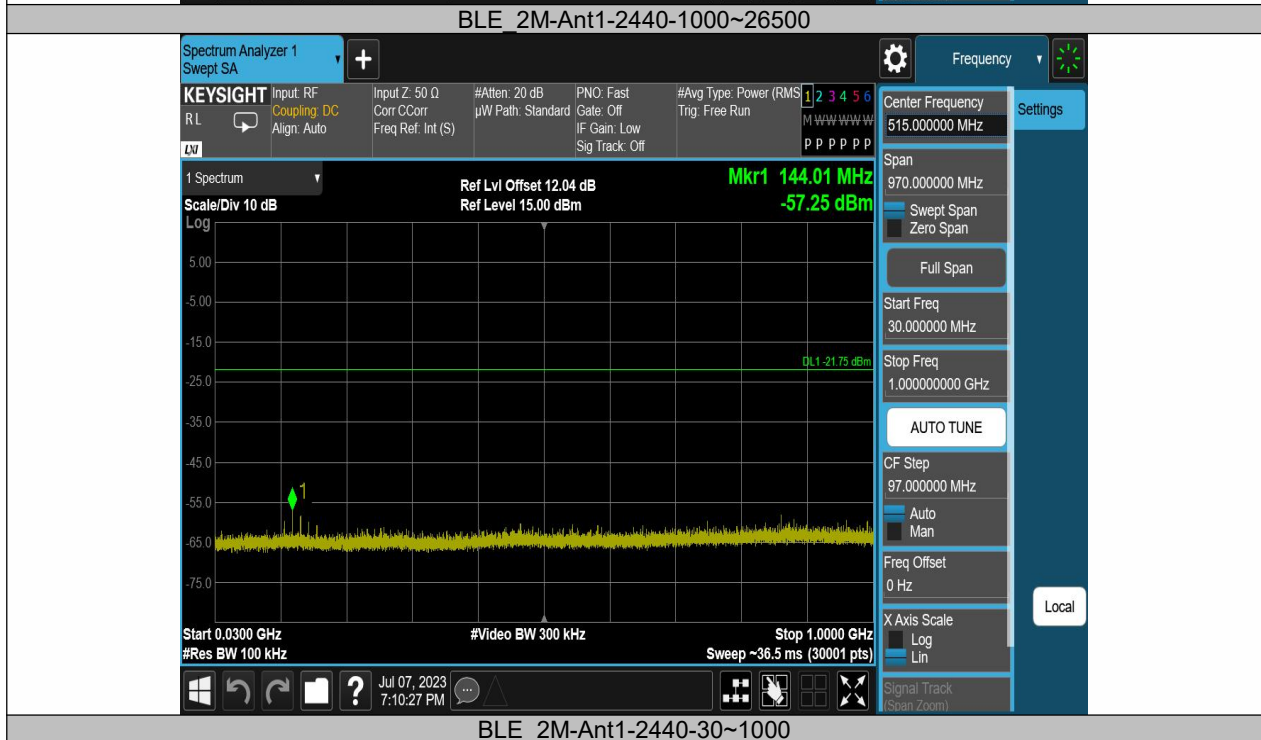



BLE 2M-Ant1-2480-0~Reference



BLE 2M-Ant1-2480-1000~26500



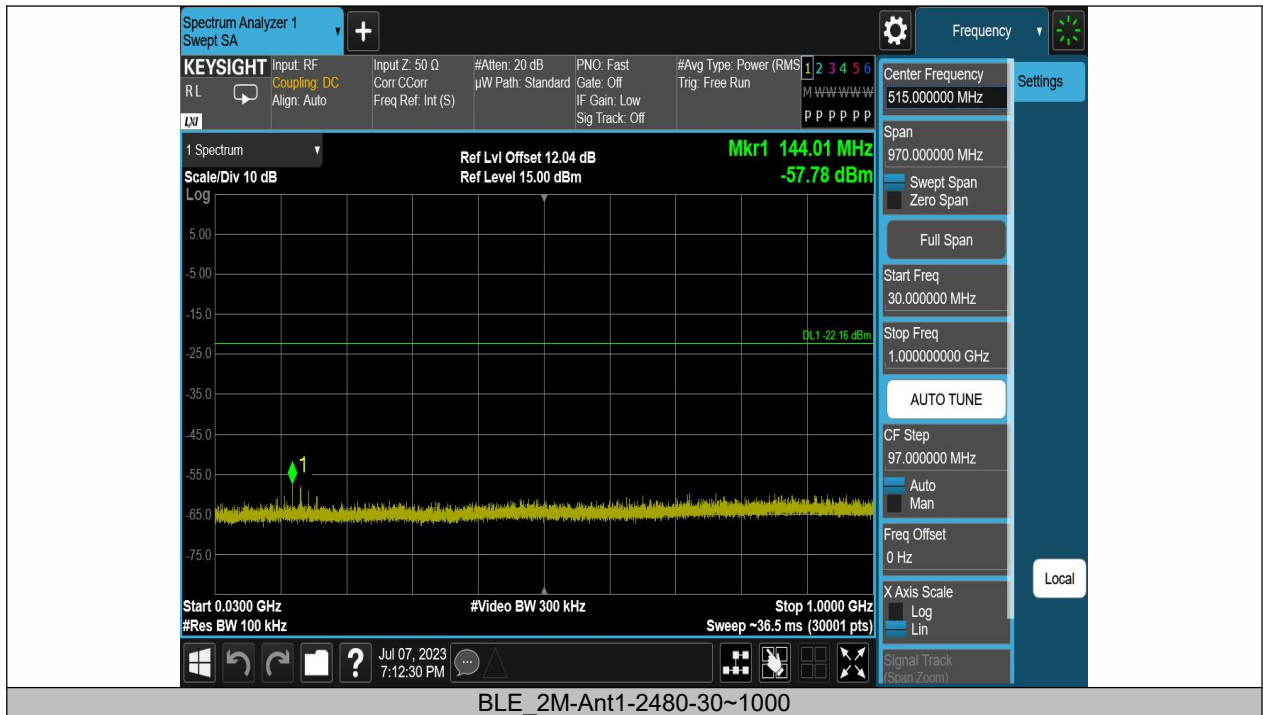

## 8.6 RADIATED SPURIOUS EMISSION

### 8.6.1 Applicable Standard

According to FCC Part 15.247(d), 15.205, 15.209 and KDB 558074 D01 15.247 Meas Guidance v05r02  
According to IC RSS-Gen and RSS-247

### 8.6.2 Conformance Limit

According to FCC Part 15.247(d): radiated emissions which fall in the restricted bands, as defined in §15.205(a), must also comply with the radiated emission limits specified in §15.209(a) (see §15.205(c)).  
According to FCC Part 15.205, Restricted bands

| MHz               | MHz                 | MHz           | GHz         |
|-------------------|---------------------|---------------|-------------|
| 0.090-0.110       | 16.42-16.423        | 399.9-410     | 4.5-5.15    |
| 10.495-0.505      | 16.69475-16.69525   | 608-614       | 5.35-5.46   |
| 2.1735-2.1905     | 16.80425-16.80475   | 960-1240      | 7.25-7.75   |
| 4.125-4.128       | 25.5-25.67          | 1300-1427     | 8.025-8.5   |
| 4.17725-4.17775   | 37.5-38.25          | 1435-1626.5   | 9.0-9.2     |
| 4.20725-4.20775   | 73-74.6             | 1645.5-1646.5 | 9.3-9.5     |
| 6.215-6.218       | 74.8-75.2           | 1660-1710     | 10.6-12.7   |
| 6.26775-6.26825   | 123-138             | 2200-2300     | 14.47-14.5  |
| 8.291-8.294       | 149.9-150.05        | 2310-2390     | 15.35-16.2  |
| 8.362-8.366       | 156.52475-156.52525 | 2483.5-2500   | 17.7-21.4   |
| 8.37625-8.38675   | 156.7-156.9         | 2690-2900     | 22.01-23.12 |
| 8.41425-8.41475   | 162.0125-167.17     | 3260-3267     | 23.6-24.0   |
| 12.29-12.293      | 167.72-173.2        | 3332-3339     | 31.2-31.8   |
| 12.51975-12.52025 | 240-285             | 3345.8-3358   | 36.43-36.5  |
| 12.57675-12.57725 | 322-335.4           | 3600-4400     | (2)         |
| 13.36-13.41       |                     |               |             |

According to FCC Part 15.205, the level of any transmitter spurious emission in Restricted bands shall not exceed the level of the emission specified in the following table

| Restricted Frequency(MHz) | Field Strength (μV/m) | Field Strength (dBμV/m) | Measurement Distance |
|---------------------------|-----------------------|-------------------------|----------------------|
| 0.009-0.490               | 2400/F(KHz)           | 20 log (uV/m)           | 300                  |
| 0.490-1.705               | 24000/F(KHz)          | 20 log (uV/m)           | 30                   |
| 1.705-30                  | 30                    | 29.5                    | 30                   |
| 30-88                     | 100                   | 40                      | 3                    |
| 88-216                    | 150                   | 43.5                    | 3                    |
| 216-960                   | 200                   | 46                      | 3                    |
| Above 960                 | 500                   | 54                      | 3                    |

### 8.6.3 Test Configuration

Test according to clause 7.2 radio frequency test setup 2

### 8.6.4 Test Procedure

This test is required for any spurious emission that falls in a Restricted Band, as defined in Section 15.205. It must be performed with the highest gain of each type of antenna proposed for use with the EUT. Use the following spectrum analyzer settings:

The EUT was placed on a turn table which is 0.8m above ground plane.

Maximum procedure was performed on the highest emissions to ensure EUT compliance.

Span = wide enough to fully capture the emission being measured

RBW = 1 MHz for  $f \geq 1$  GHz(1GHz to 25GHz), 100 kHz for  $f < 1$  GHz(30MHz to 1GHz)

VBW ≥ RBW  
 Sweep = auto  
 Detector function = peak  
 Trace = max hold

Follow the guidelines in ANSI C63.10-2013 with respect to maximizing the emission by rotating the EUT, measuring the emission while the EUT is situated in three orthogonal planes (if appropriate), adjusting the measurement antenna height and polarization, etc. A pre-amp and a high pass filter are required for this test, in order to provide the measuring system with sufficient sensitivity. Allow the trace to stabilize. The peak reading of the emission, after being corrected by the antenna factor, cable loss, pre-amp gain, etc., is the peak field strength, which must comply with the limit specified in Section 15.35(b). Submit this data.

Now set the VBW to 10 Hz, while maintaining all of the other instrument settings. This peak level, once corrected, must comply with the limit specified in Section 15.209. If the dwell time per channel of the hopping signal is less than 100 ms, then the reading obtained with the 10 Hz VBW may be further adjusted by a “duty cycle correction factor”, derived from  $20\log(\text{dwell time}/100 \text{ ms})$ , in an effort to demonstrate compliance with the 15.209 limit. Submit this data.

Repeat above procedures until all frequency measured was complete.

### 8.6.5 Test Results

|                    |           |
|--------------------|-----------|
| Temperature:       | 22° C     |
| Relative Humidity: | 43%       |
| ATM Pressure:      | 1011 mbar |

#### ■ Spurious Emission below 30MHz (9KHz to 30MHz)

| Freq.<br>(MHz) | Ant.Pol.<br>H/V | Emission<br>Level(dBuV/m) |    | Limit 3m(dBuV/m) |    | Over(dB) |    |
|----------------|-----------------|---------------------------|----|------------------|----|----------|----|
|                |                 | PK                        | AV | PK               | AV | PK       | AV |
| --             | --              | --                        | -- | --               | -- | --       | -- |

Note: the amplitude of spurious emission that is attenuated by more than 20dB below the permissible limit has no need to be reported.

Distance extrapolation factor =  $40\log(\text{Specific distance}/ \text{test distance})$  (dB);

Limit line = Specific limits(dBuV) + distance extrapolation factor



■ Spurious Emission Above 1GHz (1GHz to 25GHz)

All the antenna(Antenna 1) and modes(BLE\_2M) mode have been tested, and The test data are as follows:

Test mode: BLE\_2M Frequency: Channel 0: 2402MHz

| Freq. (MHz) | Ant.Pol. | Emission Level(dBuV/m) |       | Limit 3m(dBuV/m) |    | Over(dB) |        |
|-------------|----------|------------------------|-------|------------------|----|----------|--------|
|             | H/V      | PK                     | AV    | PK               | AV | PK       | AV     |
| 7766        | V        | 57.93                  | 43.14 | 74               | 54 | -16.07   | -10.86 |
| 9874        | V        | 58.63                  | 43.84 | 74               | 54 | -15.37   | -10.16 |
| 13682       | V        | 58.21                  | 43.42 | 74               | 54 | -15.79   | -10.58 |
| 8038        | H        | 57.8                   | 42.99 | 74               | 54 | -16.20   | -11.01 |
| 9670        | H        | 58.05                  | 43.33 | 74               | 54 | -15.95   | -10.67 |
| 14430       | H        | 58.67                  | 43.73 | 74               | 54 | -15.33   | -10.27 |

Test mode: BLE\_2M Frequency: Channel 19: 2440MHz

| Freq. (MHz) | Ant.Pol. | Emission Level(dBuV/m) |       | Limit 3m(dBuV/m) |    | Over(dB) |        |
|-------------|----------|------------------------|-------|------------------|----|----------|--------|
|             | H/V      | PK                     | AV    | PK               | AV | PK       | AV     |
| 7970        | V        | 58.44                  | 43.69 | 74               | 54 | -15.56   | -10.31 |
| 9432        | V        | 58.72                  | 43.91 | 74               | 54 | -15.28   | -10.09 |
| 13240       | V        | 58.4                   | 43.62 | 74               | 54 | -15.60   | -10.38 |
| 7596        | H        | 58.74                  | 43.97 | 74               | 54 | -15.26   | -10.03 |
| 9432        | H        | 58.58                  | 43.79 | 74               | 54 | -15.42   | -10.21 |
| 14090       | H        | 57.99                  | 43.17 | 74               | 54 | -16.01   | -10.83 |

Test mode: BLE\_2M Frequency: Channel 39: 2480MHz

| Freq. (MHz) | Ant.Pol. | Emission Level(dBuV/m) |       | Limit 3m(dBuV/m) |    | Over(dB) |        |
|-------------|----------|------------------------|-------|------------------|----|----------|--------|
|             | H/V      | PK                     | AV    | PK               | AV | PK       | AV     |
| 7834        | V        | 58.49                  | 43.7  | 74               | 54 | -15.51   | -10.30 |
| 10316       | V        | 57.65                  | 42.88 | 74               | 54 | -16.35   | -11.12 |
| 13410       | V        | 57.82                  | 43.03 | 74               | 54 | -16.18   | -10.97 |
| 7902        | H        | 57.97                  | 43.19 | 74               | 54 | -16.03   | -10.81 |
| 9806        | H        | 57.74                  | 42.96 | 74               | 54 | -16.26   | -11.04 |
| 13988       | H        | 57.87                  | 43.66 | 74               | 54 | -16.13   | -10.34 |

- Note:**
- (1) All Readings are Peak Value (VBW=3MHz) and Average Value (VBW=10Hz).
  - (2) Emission Level= Reading Level+Correct Factor.
  - (3) Correct Factor= Ant\_F + Cab\_L – Preamp
  - (4) The reading of emissions are attenuated more than 20dB below the permissible limits or the field strength is too small to be measured.

■ Spurious Emission in Restricted Band 2310-2390MHz and 2483.5-2500MHz

All the antenna(Antenna 1) and modes(BLE\_2M) mode have been tested, and and The test data are as follows:

| Test mode: BLE_2M |          | Frequency:            |                   | Channel 0: 2402MHz    |                   |
|-------------------|----------|-----------------------|-------------------|-----------------------|-------------------|
| Frequency (MHz)   | Polarity | PK(dBuV/m) (VBW=3MHz) | Limit 3m (dBuV/m) | AV(dBuV/m) (VBW=10Hz) | Limit 3m (dBuV/m) |
| 2386              | H        | 45.68                 | 74                | 32.54                 | 54                |
| 2387.44           | V        | 46.34                 | 74                | 33.19                 | 54                |

| Test mode: BLE_2M |          | Frequency:            |                   | Channel 39: 2480MHz   |                   |
|-------------------|----------|-----------------------|-------------------|-----------------------|-------------------|
| Frequency (MHz)   | Polarity | PK(dBuV/m) (VBW=3MHz) | Limit 3m (dBuV/m) | AV(dBuV/m) (VBW=10Hz) | Limit 3m (dBuV/m) |
| 2484.028          | H        | 44.88                 | 74                | 31.34                 | 54                |
| 2483.995          | H        | 44.57                 | 74                | 31.24                 | 54                |

- Note:**
- (1) All Readings are Peak Value (VBW=3MHz) and Average Value (VBW=10Hz).
  - (2) Emission Level= Reading Level+Correct Factor.
  - (3) Correct Factor= Ant\_F + Cab\_L - Preamp
  - (4) The reading of emissions are attenuated more than 20dB below the permissible limits or the field strength is too small to be measured.

**Test Model** Spurious Emission in Restricted Band 2310-2390MHz  
 Channel 0: 2402MHz BLE\_2M H

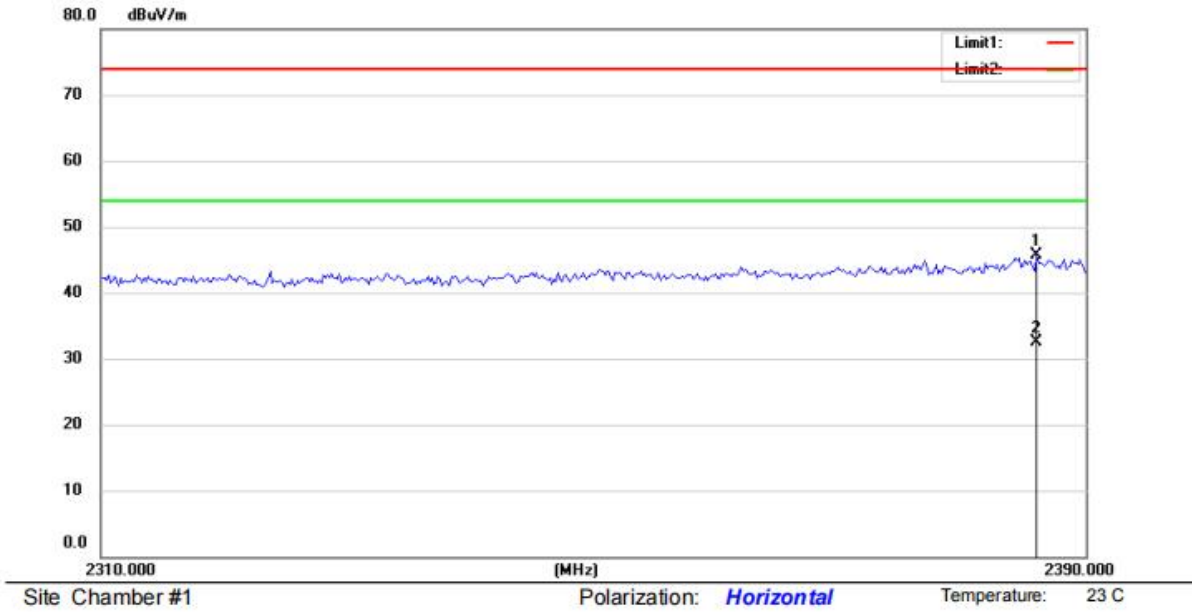

**Test Model** Spurious Emission in Restricted Band 2310-2390MHz  
 Channel 0: 2402MHz BLE\_2M V

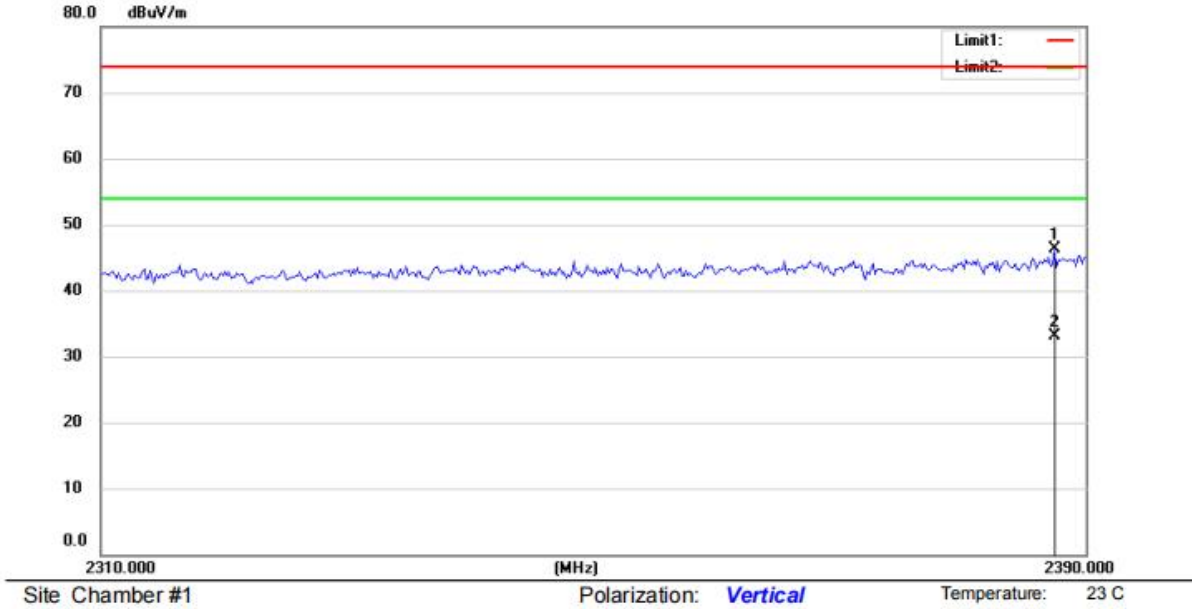

**Test Model** Spurious Emission in Restricted Band 2483.5-2500MHz  
 Channel 39: 2480MHz BLE\_2M H

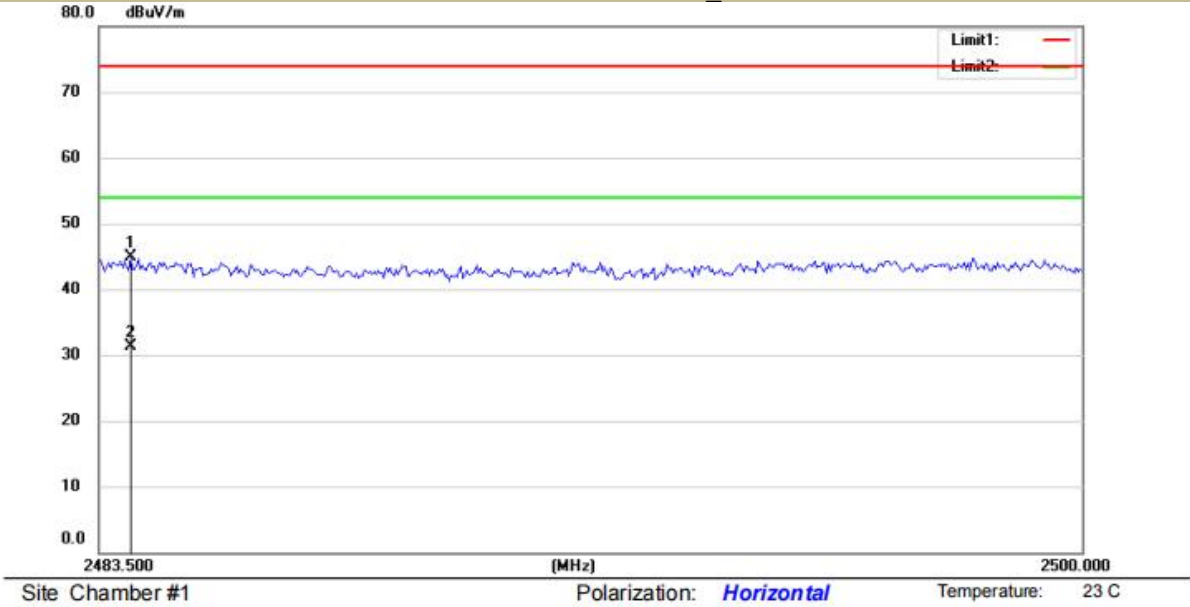

**Test Model** Spurious Emission in Restricted Band 2483.5-2500MHz  
 Channel 39: 2480MHz BLE\_2M V

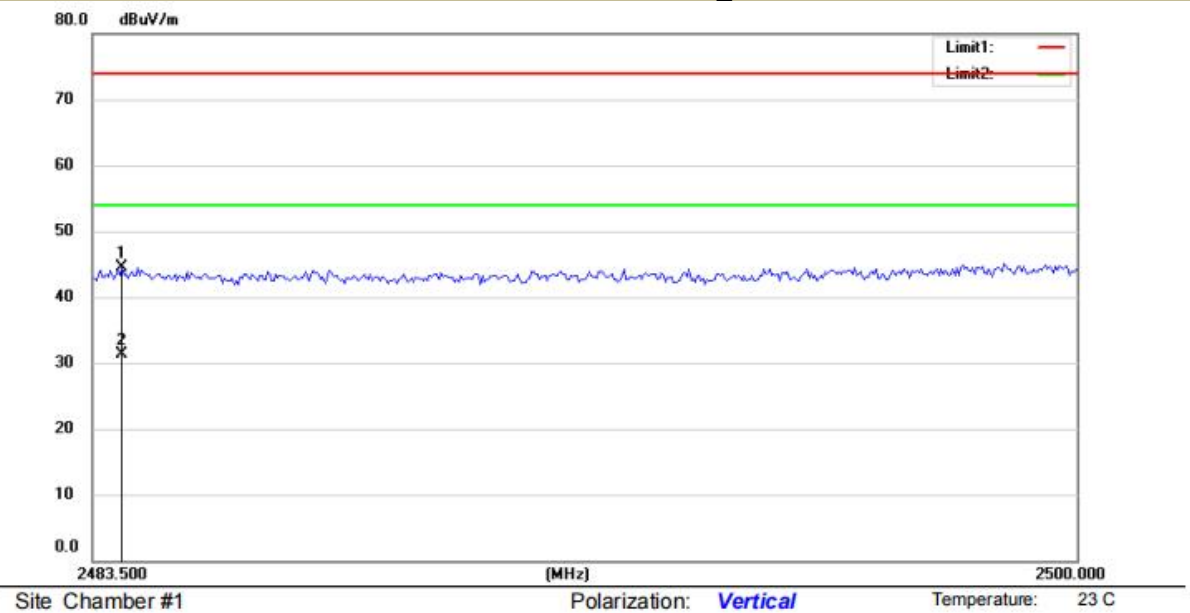

■ Spurious Emission below 1GHz (30MHz to 1GHz)

All the antenna(Antenna 1) and modes(BLE\_2M) mode have been tested, and The test data are as follows:

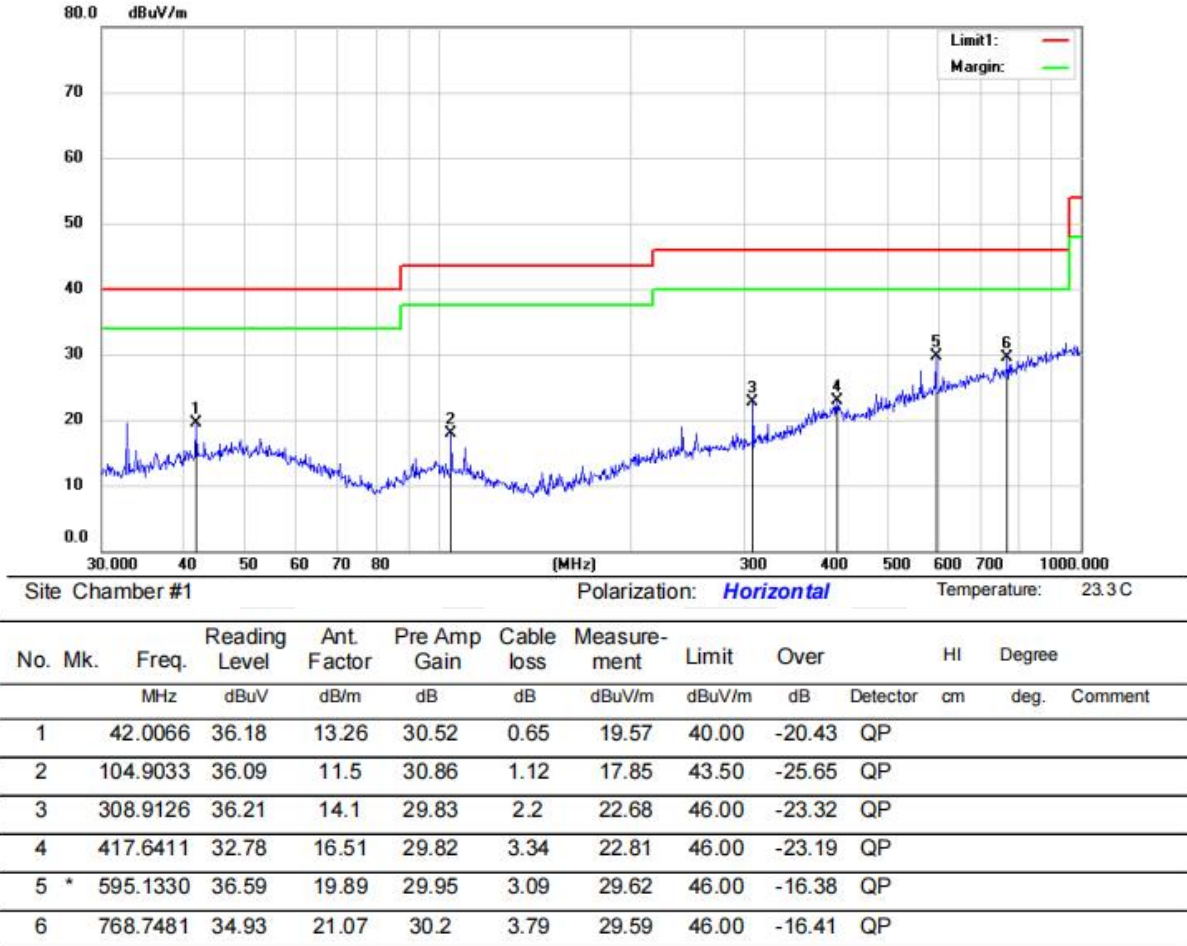

\*:Maximum data    x:Over limit    !:over margin

Operator: Ccyf

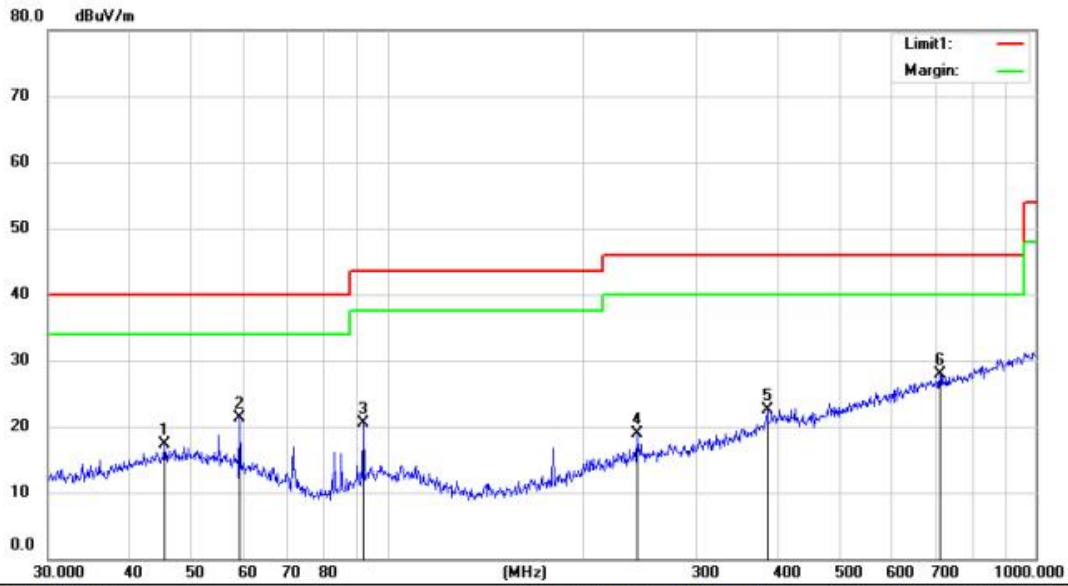

Site Chamber #1 Polarization: **Vertical** Temperature: 23.3 C

| No. | Mk. | Freq.<br>MHz | Reading<br>Level<br>dBuV | Ant.<br>Factor<br>dB/m | Pre Amp<br>Gain<br>dB | Cable<br>loss<br>dB | Measure-<br>ment<br>dBuV/m | Limit<br>dBuV/m | Over<br>dB | HI<br>Detector | Degree<br>cm | Comment |
|-----|-----|--------------|--------------------------|------------------------|-----------------------|---------------------|----------------------------|-----------------|------------|----------------|--------------|---------|
| 1   |     | 45.3755      | 33.33                    | 13.82                  | 30.5                  | 0.71                | 17.36                      | 40.00           | -22.64     | QP             |              |         |
| 2   |     | 59.2325      | 38.34                    | 12.48                  | 30.51                 | 1.03                | 21.34                      | 40.00           | -18.66     | QP             |              |         |
| 3   |     | 91.8163      | 39.90                    | 10.23                  | 30.77                 | 1.07                | 20.43                      | 43.50           | -23.07     | QP             |              |         |
| 4   |     | 242.5253     | 34.22                    | 12.79                  | 30.13                 | 2.07                | 18.95                      | 46.00           | -27.05     | QP             |              |         |
| 5   |     | 385.2805     | 33.05                    | 15.92                  | 29.82                 | 3.31                | 22.46                      | 46.00           | -23.54     | QP             |              |         |
| 6   | *   | 711.6734     | 32.98                    | 21.54                  | 30.12                 | 3.56                | 27.96                      | 46.00           | -18.04     | QP             |              |         |

\*:Maximum data x:Over limit !:over margin

Operator: Ccyf

## 8.7 CONDUCTED EMISSIONS TEST

### 8.7.1 Applicable Standard

According to FCC Part 15.207(a)  
According to IC RSS-Gen 8.8

### 8.7.2 Conformance Limit

| Frequency(MHz) | Conducted Emission Limit |         |
|----------------|--------------------------|---------|
|                | Quasi-peak               | Average |
| 0.15-0.5       | 66-56                    | 56-46   |
| 0.5-5.0        | 56                       | 46      |
| 5.0-30.0       | 60                       | 50      |

Note: 1. The lower limit shall apply at the transition frequencies  
2. The limit decreases in line with the logarithm of the frequency in the range of 0.15 to 0.50MHz.

### 8.7.3 Test Configuration

Test according to clause 7.3 conducted emission test setup

### 8.7.4 Test Procedure

The EUT was placed on a table which is 0.8m above ground plane.  
Maximum procedure was performed on the highest emissions to ensure EUT compliance.  
Repeat above procedures until all frequency measured were complete.

### 8.7.5 Test Results

Pass



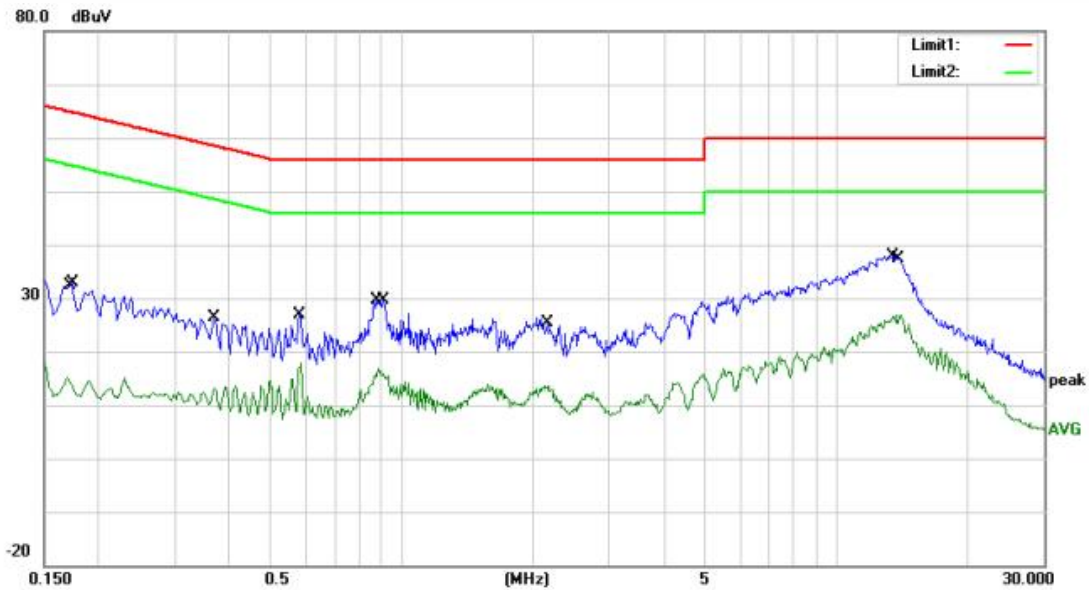

Site site #1 Phase: **L1** Temperature: 23.0

| No. | Mk. | Freq.   | Reading Level | Correct Factor | Measurement | Limit | Over   | Detector | Comment |
|-----|-----|---------|---------------|----------------|-------------|-------|--------|----------|---------|
|     |     | MHz     | dBuV          | dB             | dBuV        | dBuV  | dB     |          |         |
| 1   |     | 0.1700  | 5.52          | 9.55           | 15.07       | 54.96 | -39.89 | AVG      |         |
| 2   |     | 0.1740  | 23.30         | 9.55           | 32.85       | 64.77 | -31.92 | QP       |         |
| 3   |     | 0.3700  | 16.80         | 9.55           | 26.35       | 58.50 | -32.15 | QP       |         |
| 4   |     | 0.3700  | 3.46          | 9.55           | 13.01       | 48.50 | -35.49 | AVG      |         |
| 5   |     | 0.5820  | 17.21         | 9.57           | 26.78       | 56.00 | -29.22 | QP       |         |
| 6   |     | 0.5860  | 8.26          | 9.57           | 17.83       | 46.00 | -28.17 | AVG      |         |
| 7   |     | 0.8820  | 7.25          | 9.52           | 16.77       | 46.00 | -29.23 | AVG      |         |
| 8   |     | 0.9060  | 20.03         | 9.52           | 29.55       | 56.00 | -26.45 | QP       |         |
| 9   |     | 2.1580  | 15.82         | 9.60           | 25.42       | 56.00 | -30.58 | QP       |         |
| 10  |     | 2.1780  | 4.10          | 9.59           | 13.69       | 46.00 | -32.31 | AVG      |         |
| 11  | *   | 13.5620 | 28.51         | 9.42           | 37.93       | 60.00 | -22.07 | QP       |         |
| 12  |     | 14.0660 | 17.53         | 9.41           | 26.94       | 50.00 | -23.06 | AVG      |         |

\*:Maximum data x:Over limit !:over margin Comment: Factor build in receiver. Operator: Lennard Lio

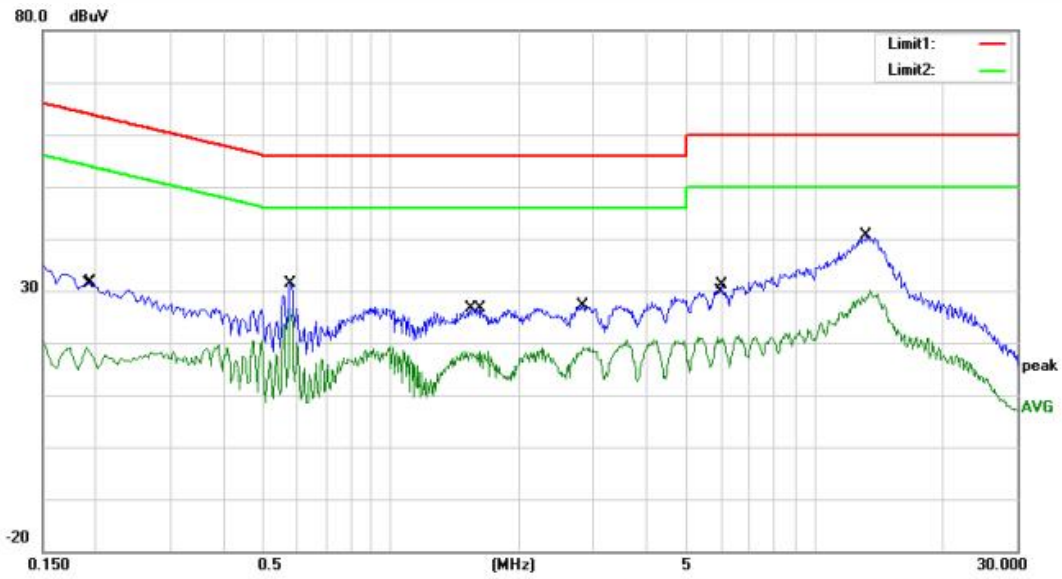

Site site #1 Phase: **N** Temperature: 23.0

| No. | Mk. | Freq.   | Reading Level | Correct Factor | Measurement | Limit | Over   | Detector | Comment |
|-----|-----|---------|---------------|----------------|-------------|-------|--------|----------|---------|
|     |     | MHz     | dBuV          | dB             | dBuV        | dBuV  | dB     |          |         |
| 1   |     | 0.1900  | 9.55          | 9.54           | 19.09       | 54.04 | -34.95 | AVG      |         |
| 2   |     | 0.1940  | 21.98         | 9.53           | 31.51       | 63.86 | -32.35 | QP       |         |
| 3   |     | 0.5780  | 21.90         | 9.57           | 31.47       | 56.00 | -24.53 | QP       |         |
| 4   |     | 0.5780  | 17.03         | 9.57           | 26.60       | 46.00 | -19.40 | AVG      |         |
| 5   |     | 1.5420  | 17.09         | 9.57           | 26.66       | 56.00 | -29.34 | QP       |         |
| 6   |     | 1.6260  | 8.87          | 9.58           | 18.45       | 46.00 | -27.55 | AVG      |         |
| 7   |     | 2.8260  | 17.63         | 9.54           | 27.17       | 56.00 | -28.83 | QP       |         |
| 8   |     | 2.8260  | 9.61          | 9.54           | 19.15       | 46.00 | -26.85 | AVG      |         |
| 9   |     | 5.9260  | 11.57         | 9.50           | 21.07       | 50.00 | -28.93 | AVG      |         |
| 10  |     | 6.0020  | 21.53         | 9.51           | 31.04       | 60.00 | -28.96 | QP       |         |
| 11  | *   | 13.2420 | 31.19         | 9.42           | 40.61       | 60.00 | -19.39 | QP       |         |
| 12  |     | 13.4700 | 20.59         | 9.42           | 30.01       | 50.00 | -19.99 | AVG      |         |

\*:Maximum data x:Over limit !:over margin Comment: Factor build in receiver. Operator: Lennard Lio

## 8.8 ANTENNA APPLICATION

### 8.8.1 Antenna Requirement

| Standard                   | Requirement  |
|----------------------------|--|
| FCC CRF Part 15.203        | An intentional radiator shall be designed to ensure that no antenna other than that furnished by the responsible party shall be used with the device. The use of a permanently attached antenna or of an antenna that uses a unique coupling to the intentional radiator shall be considered sufficient to comply with the provisions of this section. The manufacturer may design the unit so that a broken antenna can be replaced by the user, but the use of a standard antenna jack or electrical connector is prohibited.  |
| FCC 47 CFR Part 15.247 (b) | If transmitting antennas of directional gain greater than 6dBi are used, the power shall be reduced by the amount in dB that the directional gain of the antenna exceeds 6dBi.   |
| RSS-Gen Section 6.8        | The applicant for equipment certification shall provide a list of all antenna types that may be used with the transmitter, where applicable (i.e. for transmitters with detachable antenna), indicating the maximum permissible antenna gain (in dBi) and the required impedance for each antenna. The test report shall demonstrate the compliance of the transmitter with the limit for maximum equivalent isotropically radiated power (e.i.r.p.) specified in the applicable RSS, when the transmitter is equipped with any antenna type, selected from this list.   |
| RSS-247 Section 5.4        | If the transmitter employs an antenna system that emits multiple directional beams, but does not emit multiple directional beams simultaneously, the total output power conducted to the array or arrays that comprise the device (i.e. the sum of the power supplied to all antennas, antenna elements, staves, etc., and summed across all carriers or frequency channels) shall not exceed the applicable output power limit. However, the total conducted output power shall be reduced by 1 dB below the specified limits for each 3 dB that the directional gain of the antenna/antenna array exceeds 6 dBi. The directional antenna gain shall be computed as the sum of 10 log (number of array elements or staves) plus the directional gain of the element or stave having the highest gain. |

### 8.8.2 Result

PASS.

- Note:
- Antenna use a permanently attached antenna which is not replaceable.
  - Not using a standard antenna jack or electrical connector for antenna replacement
  - The antenna has to be professionally installed (please provide method of installation)

Please refer to the attached document Internal Photos to show the antenna connector.

Detail of Factor For Radiated Emission

| Frequency(MHz) | Ant_F(dB) | Cab_L(dB) | Preamp(dB) | Correct Factor(dB) |
|----------------|-----------|-----------|------------|--------------------|
| 0.009          | 20.6      | 0.03      | \          | 20.63              |
| 0.15           | 20.7      | 0.1       | \          | 20.8               |
| 1              | 20.9      | 0.15      | \          | 21.05              |
| 10             | 20.1      | 0.28      | \          | 20.38              |
| 30             | 18.8      | 0.45      | \          | 19.25              |
|                |           |           |            |                    |
| 30             | 11.7      | 0.62      | 27.9       | -15.58             |
| 100            | 12.5      | 1.02      | 27.8       | -14.28             |
| 300            | 12.9      | 1.91      | 27.5       | -12.69             |
| 600            | 19.2      | 2.92      | 27         | -4.88              |
| 800            | 21.1      | 3.54      | 26.6       | -1.96              |
| 1000           | 22.3      | 4.17      | 26.2       | 0.27               |
|                |           |           |            |                    |
| 1000           | 25.6      | 1.76      | 41.4       | -14.04             |
| 3000           | 28.9      | 3.27      | 43.2       | -11.03             |
| 5000           | 31.1      | 4.2       | 44.6       | -9.3               |
| 8000           | 36.2      | 5.95      | 44.7       | -2.55              |
| 10000          | 38.4      | 6.3       | 43.9       | 0.8                |
| 12000          | 38.5      | 7.14      | 42.3       | 3.34               |
| 15000          | 40.2      | 8.15      | 41.4       | 6.95               |
| 18000          | 45.4      | 9.02      | 41.3       | 13.12              |
|                |           |           |            |                    |
| 18000          | 37.9      | 1.81      | 47.9       | -8.19              |
| 21000          | 37.9      | 1.95      | 48.7       | -8.85              |
| 25000          | 39.3      | 2.01      | 42.8       | -1.49              |
| 28000          | 39.6      | 2.16      | 46.0       | -4.24              |
| 31000          | 41.2      | 2.24      | 44.5       | -1.06              |
| 34000          | 41.5      | 2.29      | 46.6       | -2.81              |
| 37000          | 43.8      | 2.30      | 46.4       | -0.3               |
| 40000          | 43.2      | 2.50      | 42.2       | 3.5                |

----- END OF REPORT -----