

RADIO TEST REPORT

FCC ID: 2ANDX-CK10A

Product : Smart Kitchen Scale

Trade Mark : N/A

Model Name : CK10A

CK10B, CK10C, CK10D, CK10E, CK10F,
CK10G, CK10A1, CK10B1, CK10C1,

Family Model : CK10D1, CK10E1, CK10F1, CK10G1,
CK20A, CK20B, CK20C, CK30A, CK30B,
CK30C

Report No. : S19100901903001

Prepared for

Shenzhen Yolanda Technology Co., Ltd.

Room 201-202, No.49-1, 28 Area, Dabao Road, Xinan Street, Baoan,
Shenzhen, China

Prepared by

Shenzhen NTEK Testing Technology Co., Ltd.

1/F, Building E, Fenda Science Park, Sanwei Community, Xixiang Street
Bao'an District, Shenzhen 518126 P.R. China

Tel.: +86-755-6115 6588 Fax.: +86-755-6115 6599

Website: <http://www.ntek.org.cn>

TEST RESULT CERTIFICATION

Applicant's name : Shenzhen Yolanda Technology Co., Ltd.
Address : Room 201-202, No.49-1, 28 Area, Dabao Road, Xinan Street, Baoan, Shenzhen, China

Manufacturer's Name : Shenzhen Yolanda Technology Co., Ltd.
Address : Room 201-202, No.49-1, 28 Area, Dabao Road, Xinan Street, Baoan, Shenzhen, China

Product description

Product name: Smart Kitchen Scale
Model and/or type reference : CK10A
Family Model: CK10B, CK10C, CK10D, CK10E, CK10F, CK10G, CK10A1, CK10B1, CK10C1, CK10D1, CK10E1, CK10F1, CK10G1, CK20A, CK20B, CK20C, CK30A, CK30B, CK30C
Rating(s): DC 3V from Battery

Standards: FCC Part15.249

Test procedure : ANSI C63.10-2013

This device described above has been tested by NTEK, and the test results show that the equipment under test (EUT) is in compliance with the FCC requirements. And it is applicable only to the tested sample identified in the report.

This report shall not be reproduced except in full, without the written approval of NTEK, this document may be altered or revised by NTEK, personnel only, and shall be noted in the revision of the document.

Date of Test :
Date (s) of performance of tests : Oct. 17, 2019 ~ Nov. 06, 2019
Date of Issue : Nov. 06, 2019
Test Result: Pass

Testing Engineer : Jerry Xie
(Jerry Xie)

Technical Manager : Jason Chen
(Jason Chen)

Authorized Signatory : Sam Chen
(Sam Chen)

Table of Contents

Page

1 . SUMMARY OF TEST RESULTS	4
1.1 TEST FACILITY	5
1.2 MEASUREMENT UNCERTAINTY	5
2 . GENERAL INFORMATION	6
2.1 GENERAL DESCRIPTION OF EUT	6
2.2 DESCRIPTION OF TEST MODES	8
2.3 BLOCK DIGRAM SHOWING THE CONFIGURATION OF SYSTEM TESTED	9
2.4 DESCRIPTION OF SUPPORT UNITS(CONDUCTED MODE)	10
2.5 EQUIPMENTS LIST FOR ALL TEST ITEMS	11
3 . ANTENNA REQUIREMENT	13
3.1 STANDARD REQUIREMENT	13
3.2 EUT ANTENNA	13
3.3 CONDUCTED EMISSION MEASUREMENT	14
3.3.1 POWER LINE CONDUCTED EMISSION LIMITS	14
3.3.2 TEST PROCEDURE	14
3.3.3 DEVIATION FROM TEST STANDARD	14
3.3.4 TEST SETUP	15
3.2.5 TEST RESULT	16
3.4 RADIATED EMISSION MEASUREMENT	17
3.4.1 RADIATED EMISSION LIMITS	17
3.4.2 TEST PROCEDURE	18
3.4.3 DEVIATION FROM TEST STANDARD	18
3.4.4 TEST RESULTS (BELOW 30MHZ)	21
3.4.5 TEST RESULTS (BELOW 1000 MHZ)	22
3.4.6 TEST RESULTS (ABOVE 1000 MHZ)	24
3.4.7 TEST RESULTS (RESTRICTED BANDS REQUIREMENTS)	27
4 . FREQUENCY TOLERANCE	29
4.1 FREQUENCY TOLERANCE LIMITS	29
4.2TEST PROCEDURE	29
4.3 TEST SETUP	29
4.4 TEST RESULTS	29
5. BANDWIDTH TEST	30
5.1 TEST PROCEDURE	30
5.1 DEVIATION FROM STANDARD	30
5.1 TEST SETUP	30
6. TEST RESULTS	31

1. SUMMARY OF TEST RESULTS

Test procedures according to the technical standards:

FCC Part15, Subpart C (15.249)			
Standard Section	Test Item	Judgment	Remark
15.207	Conducted Emission	N/A	
15.203	Antenna Requirement	Pass	
15.249 15.209	Radiated Spurious Emission	Pass	
15.249(2)	Frequency Tolerance	N/A	
15.249(a)	Fundamental Measurement	Pass	
15.205	Band Edge Emission	Pass	
15.249	Occupied Bandwidth	Pass	

1.1 TEST FACILITY

Shenzhen NTEK Testing Technology Co., Ltd
 Add. : 1/F, Building E, Fenda Science Park, Sanwei Community, Xixiang Street, Bao'an District, Shenzhen 518126 P.R. China.
 FCC FRN Registration No.:463705; IC Registration No.:9270A-1
 CNAS Registration No.:L5516

1.2 MEASUREMENT UNCERTAINTY

The reported uncertainty of measurement $y \pm U$, where expanded uncertainty U is based on a standard uncertainty multiplied by a coverage factor of $k=2$, providing a level of confidence of approximately **95 %**.

No.	Item	Uncertainty
1	Conducted Emission Test	$\pm 1.38\text{dB}$
2	RF power,conducted	$\pm 0.16\text{dB}$
3	Spurious emissions,conducted	$\pm 0.21\text{dB}$
4	All emissions,radiated(<1G)	$\pm 4.68\text{dB}$
5	All emissions,radiated(>1G)	$\pm 4.89\text{dB}$
6	Temperature	$\pm 0.5^\circ\text{C}$
7	Humidity	$\pm 2\%$

2. GENERAL INFORMATION

2.1 GENERAL DESCRIPTION OF EUT

Equipment	Smart Kitchen Scale
Trade Mark	N/A
Model Name	CK10A
Family Model	CK10B, CK10C, CK10D, CK10E, CK10F, CK10G, CK10A1, CK10B1, CK10C1, CK10D1, CK10E1, CK10F1, CK10G1, CK20A, CK20B, CK20C, CK30A, CK30B, CK30C
Model Difference	All models are the same circuit and RF module, except the model name.
Product Description	The EUT is a Smart Kitchen Scale
	Operation Frequency: 2402MHz~2480MHz
	Modulation Type: GFSK
	Antenna Designation: PCB Antenna
	Antenna Gain(Peak) 0.5 dBi
	Based on the application, features, or specification exhibited in User's Manual. More details of EUT technical specification, please refer to the User's Manual.
Channel List	Please refer to the Note 2.
Adapter	N/A
Battery	DC 3V from Battery.
HW Version	COM193A11
SW Version	A33

Note:

1. For a more detailed features description, please refer to the manufacturer's specifications or the User's Manual.

2.

Channel	Frequency (MHz)
01	2402
02	2426
03	2480

3.

Table for Filed Antenna

Ant.	Brand	Model Name	Antenna Type	Connector	Gain (dBi)	NOTE
1	N/A	N/A	PCB Antenna	N/A	0.5	Antenna

2.2 DESCRIPTION OF TEST MODES

To investigate the maximum EMI emission characteristics generates from EUT, the test system was pre-scanning tested base on the consideration of following EUT operation mode or test configuration mode which possible have effect on EMI emission level. Each of these EUT operation mode(s) or test configuration mode(s) mentioned above was evaluated respectively.

Pretest Mode	Description
Mode 1	CH01
Mode 2	CH02
Mode 3	CH03

For Radiated Spurious Emission	
Pretest Mode	Description
Mode 1	CH01
Mode 2	CH02
Mode 3	CH03

Note:

(1) The measurements are performed at the highest, middle, lowest available channels.

2.3 BLOCK DIGRAM SHOWING THE CONFIGURATION OF SYSTEM TESTED

Radiated Spurious Emission Test

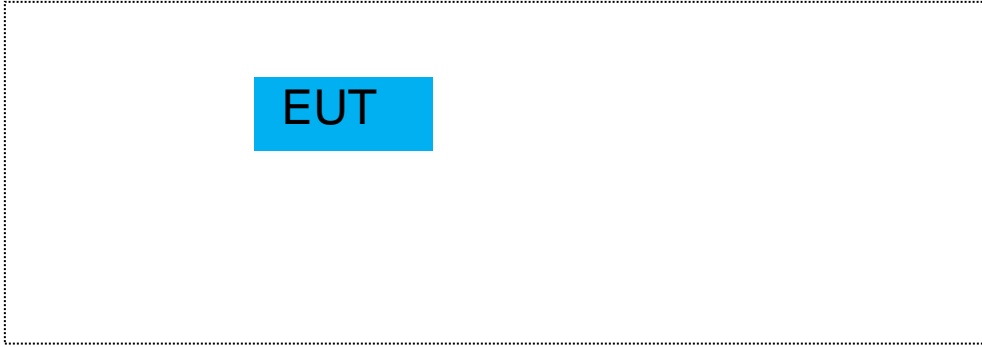

2.4 DESCRIPTION OF SUPPORT UNITS(CONDUCTED MODE)

The EUT has been tested as an independent unit together with other necessary accessories or support units. The following support units or accessories were used to form a representative test configuration during the tests.

Item	Equipment	Mfr/Brand	Model/Type No.	Series No.	Note

Item	Cable Type	Shielded Type	Ferrite Core	Length	Note

Note:

- (1) The support equipment was authorized by Declaration of Confirmation.
- (2) For detachable type I/O cable should be specified the length in cm in 『Length』 column.

2.5 EQUIPMENTS LIST FOR ALL TEST ITEMS

Radiation Test equipment

Item	Kind of Equipment	Manufacturer	Type No.	Serial No.	Last calibration	Calibrated until	Calibration period
1	Spectrum Analyzer	Agilent	E4407B	MY45108040	2019.05.13	2020.05.12	1 year
2	Spectrum Analyzer	Agilent	N9020A	MY49100060	2019.08.28	2020.08.27	1 year
3	EMI Test Receiver	Agilent	N9038A	MY53227146	2019.05.13	2020.05.12	1 year
4	Test Receiver	R&S	ESPI	101318	2019.05.13	2020.05.12	1 year
5	Bilog Antenna	TESEQ	CBL6111D	31216	2019.04.15	2020.04.14	1 year
6	50Ω Coaxial Switch	Anritsu	MP59B	6200983705	2019.05.13	2020.05.12	1 year
7	Horn Antenna	EM	EM-AH-10180	2011071402	2019.04.15	2020.04.14	1 year
8	Horn Ant	Schwarzbeck	BBHA 9170	9170-181	2019.05.13	2020.05.12	1 year
9	Amplifier	EMC	EMC051835SE	980246	2019.08.06	2020.08.05	1 year
10	Amplifier	MITEQ	TTA1840-35-HG	177156	2019.05.13	2020.05.12	1 year
11	Loop Antenna	ARA	PLA-1030/B	1029	2019.05.13	2020.05.12	1 year
12	Power Meter	DARE	RPR3006W	15I00041S NO84	2019.08.06	2020.08.05	1 year
13	Test Cable (9KHz-30MHz)	N/A	R-01	N/A	2017.04.21	2020.04.20	3 year
14	Test Cable (30MHz-1GHz)	N/A	R-02	N/A	2017.04.21	2020.04.20	3 year
15	High Test Cable(1G-40GHz)	N/A	R-03	N/A	2017.04.21	2020.04.20	3 year
16	High Test Cable(1G-40GHz)	N/A	R-04	N/A	2017.04.21	2020.04.20	3 year
17	temporary antenna connector (Note)	NTS	R001	N/A	N/A	N/A	N/A

Note:

We will use the temporary antenna connector (soldered on the Onboard meander board) When conducted test And this temporary antenna connector is listed within the instrument list

Conduction Test equipment

Item	Kind of Equipment	Manufacturer	Type No.	Serial No.	Last calibration	Calibrated until	Calibration period
1	Test Receiver	R&S	ESCI	101160	2019.05.13	2020.05.12	1 year
2	LISN	R&S	ENV216	101313	2019.04.15	2020.04.14	1 year
3	LISN	SCHWARZBECK	NNLK 8129	8129245	2019.05.13	2020.05.12	1 year
4	50Ω Coaxial Switch	ANRITSU CORP	MP59B	6200983704	2019.05.13	2020.05.12	1 year
5	Test Cable (9KHz-30MHz)	N/A	C01	N/A	2017.04.21	2020.04.20	3 year
6	Test Cable (9KHz-30MHz)	N/A	C02	N/A	2017.04.21	2020.04.20	3 year
7	Test Cable (9KHz-30MHz)	N/A	C03	N/A	2017.04.21	2020.04.20	3 year

Note: Each piece of equipment is scheduled for calibration once a year except the Test Cable which is scheduled for calibration every 3 years.

3. ANTENNA REQUIREMENT

3.1 STANDARD REQUIREMENT

15.203 requirement: For intentional device, according to 15.203: an intentional radiator shall be designed to ensure that no antenna other than that furnished by the responsible party shall be used with the device.

3.2 EUT ANTENNA

The EUT antenna is permanent attached PCB antenna(Gain:0.5dBi). It comply with the standard requirement.

3.3 CONDUCTED EMISSION MEASUREMENT

3.3.1 POWER LINE CONDUCTED EMISSION Limits (Frequency Range 150KHz-30MHz)

Frequency(MHz)	Conducted Emission Limit	
	Quasi-peak	Average
0.15-0.5	66-56*	56-46*
0.5-5.0	56	46
5.0-30.0	60	50

Note: 1. *Decreases with the logarithm of the frequency
 2. The lower limit shall apply at the transition frequencies
 3. The limit decreases in line with the logarithm of the frequency in the range of 0.15 to 0.50MHz.

The following table is the setting of the receiver

Receiver Parameters	Setting
Attenuation	10 dB
Start Frequency	0.15 MHz
Stop Frequency	30 MHz
IF Bandwidth	9 kHz

3.3.2 TEST PROCEDURE

- a. The EUT was placed 0.4 meters from the horizontal ground plane with EUT being connected to the power mains through a line impedance stabilization network (LISN). All other support equipments powered from additional LISN(s). The LISN provide 50 Ohm/ 50uH of coupling impedance for the measuring instrument.
- b. Interconnecting cables that hang closer than 40 cm to the ground plane shall be folded back and forth in the center forming a bundle 30 to 40 cm long.
- c. I/O cables that are not connected to a peripheral shall be bundled in the center. The end of the cable may be terminated, if required, using the correct terminating impedance. The overall length shall not exceed 1 m.
- d. LISN at least 80 cm from nearest part of EUT chassis.
- e. For the actual test configuration, please refer to the related Item –EUT Test Photos.

3.3.3 DEVIATION FROM TEST STANDARD

No deviation

3.3.4 TEST SETUP

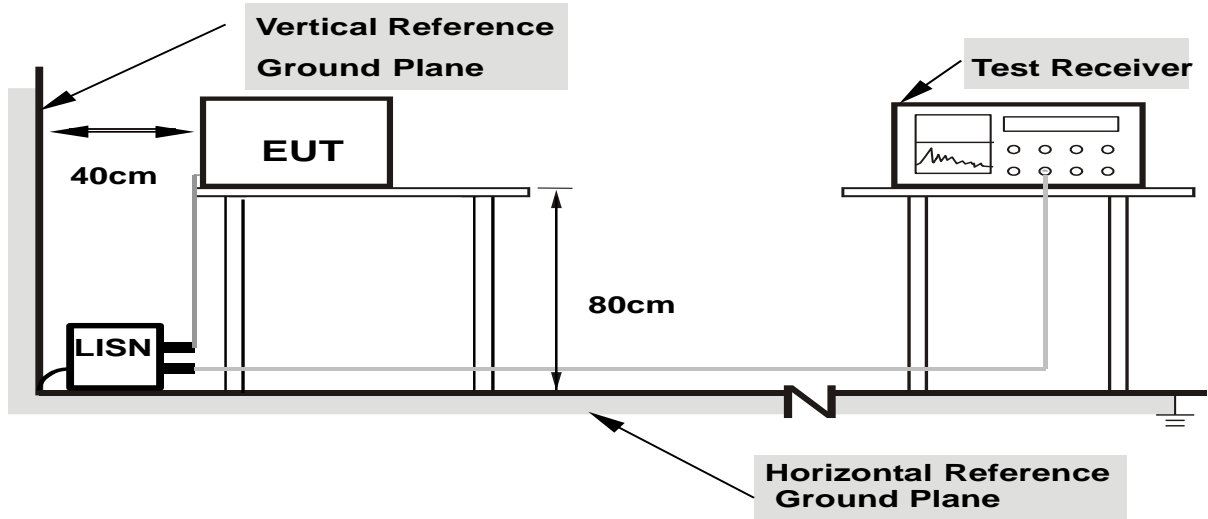

- Note:**
1. Support units were connected to second LISN.
 2. Both of LISNs (AMN) are 80 cm from EUT and at least 80 from other units and other metal planes

3.2.5 TEST RESULT

EUT :	Smart Kitchen Scale	Model Name. :	CK10A
Temperature :	25 °C	Relative Humidity :	55%
Pressure :	1010hPa	Phase :	N/A
Test Voltage :	N/A	Test Mode :	N/A

Note: Not applicable.

3.4 RADIATED EMISSION MEASUREMENT

3.4.1 Radiated Emission Limits (FCC 15.209)

Frequencies (MHz)	Field Strength (micorvolts/meter)	Measurement Distance (meters)
0.009~0.490	2400/F(KHz)	300
0.490~1.705	24000/F(KHz)	30
1.705~30.0	30	30
Frequency (MHz)	Limit (dBuV)	
30~88	40	3
88~216	43.5	3
216~960	46	3
960 -10000	54.00	3
*902 - 928	94.00	3

Note:

- (1) The tighter limit applies at the band edges.
- (2) Emission level (dBuV/m)=20log Emission level (uV/m).
- (3) *Note: This is the limit for the fundamental frequency.

LIMITS OF RADIATED EMISSION MEASUREMENT (FCC 15.249)

Frequency of Emission (MHz)	Field Strength of fundamental ((millivolts /meter)	Field Strength of Harmonics (microvolts/meter)
2400-2483.5	50	500

Notes:

- (1) Emissions radiated outside of the specified frequency bands, except for harmonics, shall be attenuated by at least 50 dB below the level of the fundamental or to the general radiated emission limits in Section 15.209, whichever is the lesser attenuation.

Spectrum Parameter	Setting
Attenuation	Auto
Start Frequency	1000 MHz
Stop Frequency	10th carrier harmonic
RB / VB (emission in restricted band)	1MHz / 1MHz for Peak

Receiver Parameter	Setting
Attenuation	Auto
Start ~ Stop Frequency	9kHz~150kHz / RB 200Hz for QP
Start ~ Stop Frequency	150kHz~30MHz / RB 9kHz for QP
Start ~ Stop Frequency	30MHz~1000MHz / RB 120kHz for QP

3.4.2 TEST PROCEDURE

- a. The measuring distance of at 3 m shall be used for measurements at frequency up to 1GHz. For frequencies above 1GHz, any suitable measuring distance may be used.
- b. The EUT was placed on the top of a rotating table 0.8 m for below 1GHz and 1.5m for above 1GHz the ground at a 3 meter. The table was rotated 360 degrees to determine the position of the highest radiation.
- c. The height of the equipment or of the substitution antenna shall be 0.8 m for below 1GHz and 1.5m for above 1GHz; the height of the test antenna shall vary between 1 m to 4 m. Both horizontal and vertical polarizations of the antenna are set to make the measurement.
- d. The initial step in collecting conducted emission data is a spectrum analyzer peak detector mode pre-scanning the measurement frequency range. Significant peaks are then marked and then Quasi Peak detector mode re-measured.
- e. If the Peak Mode measured value compliance with and lower than Quasi Peak Mode Limit, the EUT shall be deemed to meet QP Limits and then no additional QP Mode measurement performed.
- f. For the actual test configuration, please refer to the related Item –EUT Test Photos.

Note:

Both horizontal and vertical antenna polarities were tested and performed pretest to three orthogonal axis. The worst case emissions were reported

3.4.3 DEVIATION FROM TEST STANDARD

No deviation

(A) Radiated Emission Test-Up Frequency Below 30MHz

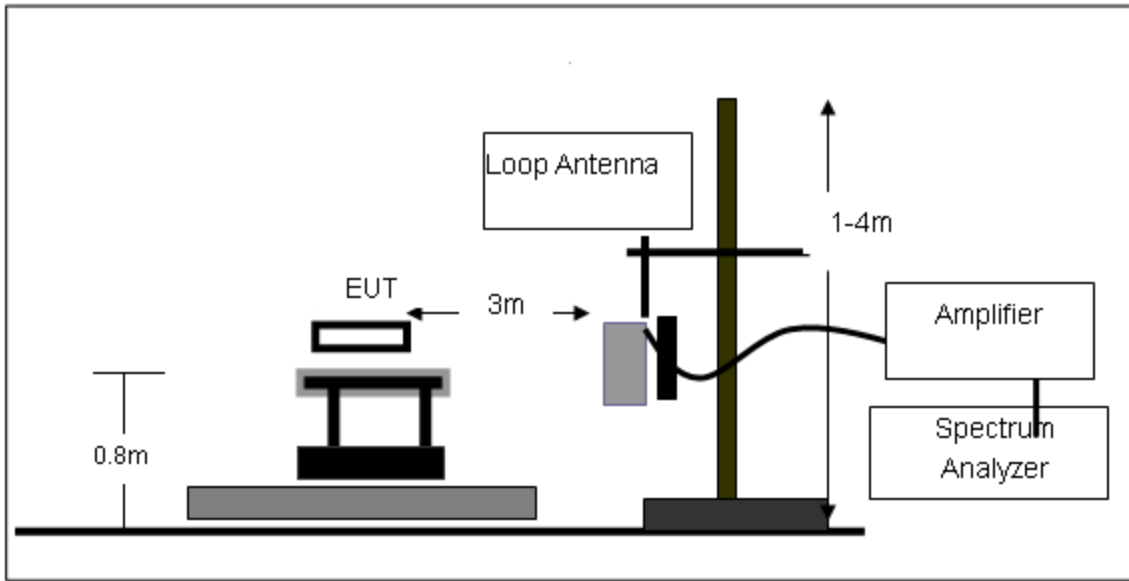

(B) Radiated Emission Test-Up Frequency 30MHz~1GHz

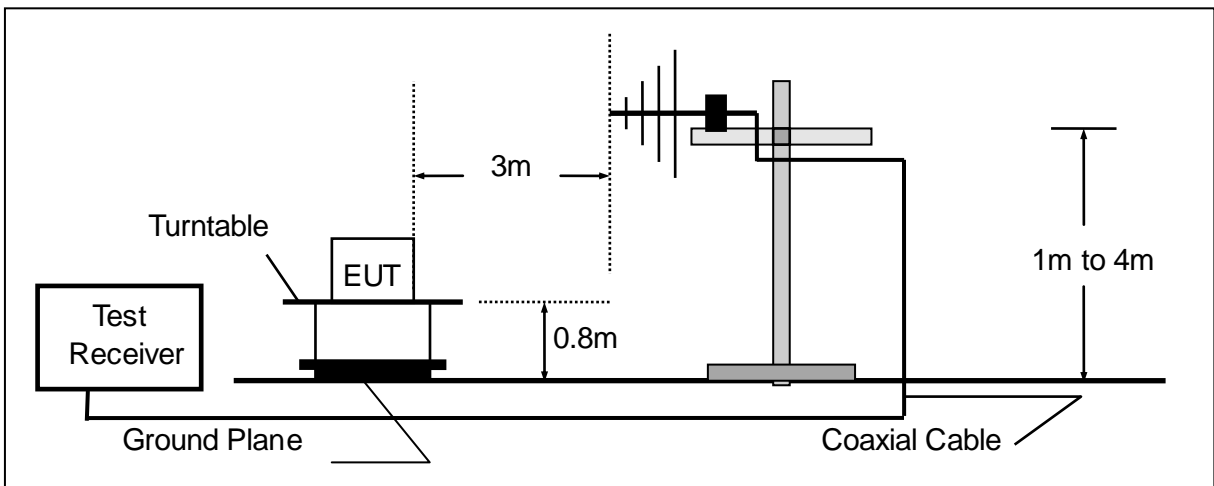

(C) Radiated Emission Test-Up Frequency Above 1GHz

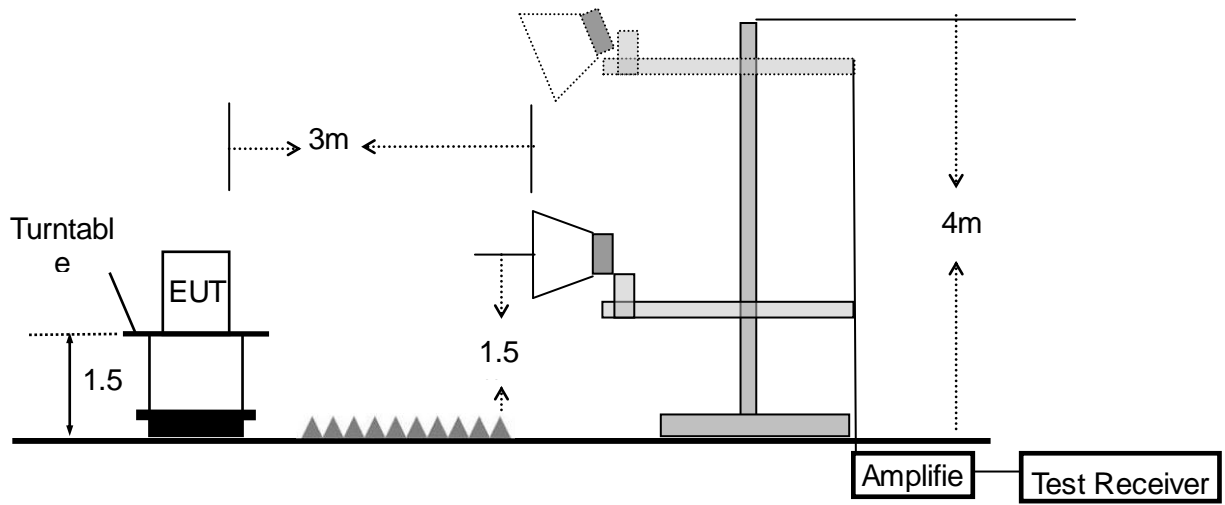

3.4.4 TEST RESULTS (BELOW 30MHz)

EUT :	Smart Kitchen Scale	Model Name. :	CK10A
Temperature :	20 °C	Relative Humidity :	48%
Pressure :	1010 hPa	Test Voltage :	DC 3V
Test Mode :	TX	Polarization :	--

Freq.	Reading	Limit	Margin	State
(MHz)	(dBuV/m)	(dBuV/m)	(dB)	P/F
--	--	--	--	PASS
--	--	--	--	PASS

NOTE:

The amplitude of spurious emissions which are attenuated by more than 20dB below the permissible value has no need to be reported.

Remark:1. Emission level in dBuV/m= $20 \log(\mu\text{V}/\text{m})$

2. Measurement was performed at an antenna to the closed point of EUT distance of meters.

3. For Frequency 9kHz~30MHz:

Distance extrapolation factor = $40 \log(\text{Specific distance}/ \text{test distance})(\text{dB})$;

Limit line=Specific limits(dBuV) + distance extrapolation factor.

For Frequency above 30MHz:

Distance extrapolation factor = $20 \log(\text{Specific distance}/ \text{test distance})(\text{dB})$;

Limit line=Specific limits(dBuV) + distance extrapolation factor.

3.4.5 TEST RESULTS (BELOW 1000 MHz)

EUT :	Smart Kitchen Scale	Model Name :	CK10A
Temperature :	25 °C	Relative Humidity :	51%
Pressure :	1010 hPa	Test Voltage :	DC 3V
Test Mode :	Model 1	Polarization :	Vertical

Frequency (MHz)	Meter Reading (dBμV)	Factor (dB)	Emission Level (dBμV/m)	Limits (dBμV/m)	Margin (dB)	Detector Type
44.7433	5.07	11.25	16.32	40.00	-23.68	QP
119.0180	5.98	12.33	18.31	43.50	-25.19	QP
281.9946	7.32	15.20	22.52	46.00	-23.48	QP
550.9480	7.34	22.50	29.84	46.00	-16.16	QP

Remark:

1. Factor = Antenna Factor + Cable Loss – Pre-amplifier.

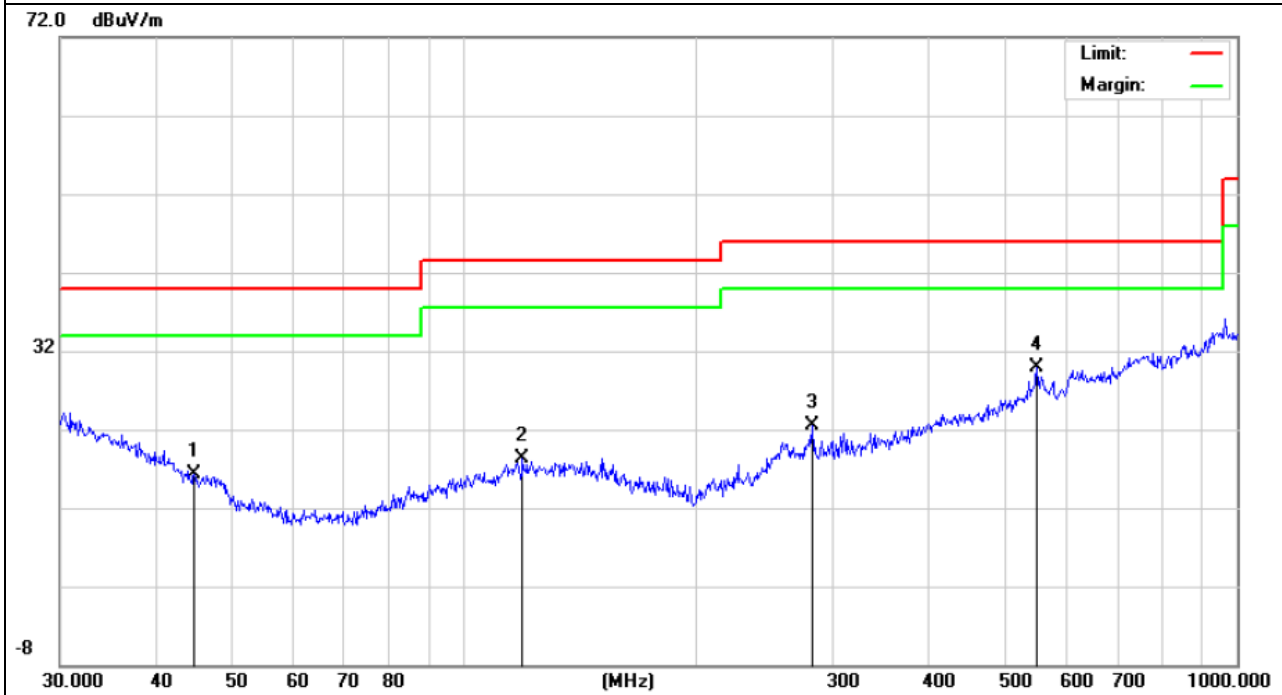

Note: The test mode 1 is the worst case, just reported the worst data in the report.

EUT :	Smart Kitchen Scale	Model Name :	CK10A
Temperature :	25 °C	Relative Humidity :	51%
Pressure :	1010 hPa	Test Voltage :	DC 3V
Test Mode :	Model 1	Polarization :	Horizontal

Frequency (MHz)	Meter Reading (dBμV)	Factor (dB)	Emission Level (dBμV/m)	Limits (dBμV/m)	Margin (dB)	Detector Type
46.3402	6.51	10.79	17.30	40.00	-22.70	QP
116.9495	7.60	12.37	19.97	43.50	-23.53	QP
281.9946	6.95	15.20	22.15	46.00	-23.85	QP
607.7867	8.59	22.11	30.70	46.00	-15.30	QP

Remark:

1. Factor = Antenna Factor + Cable Loss – Pre-amplifier.

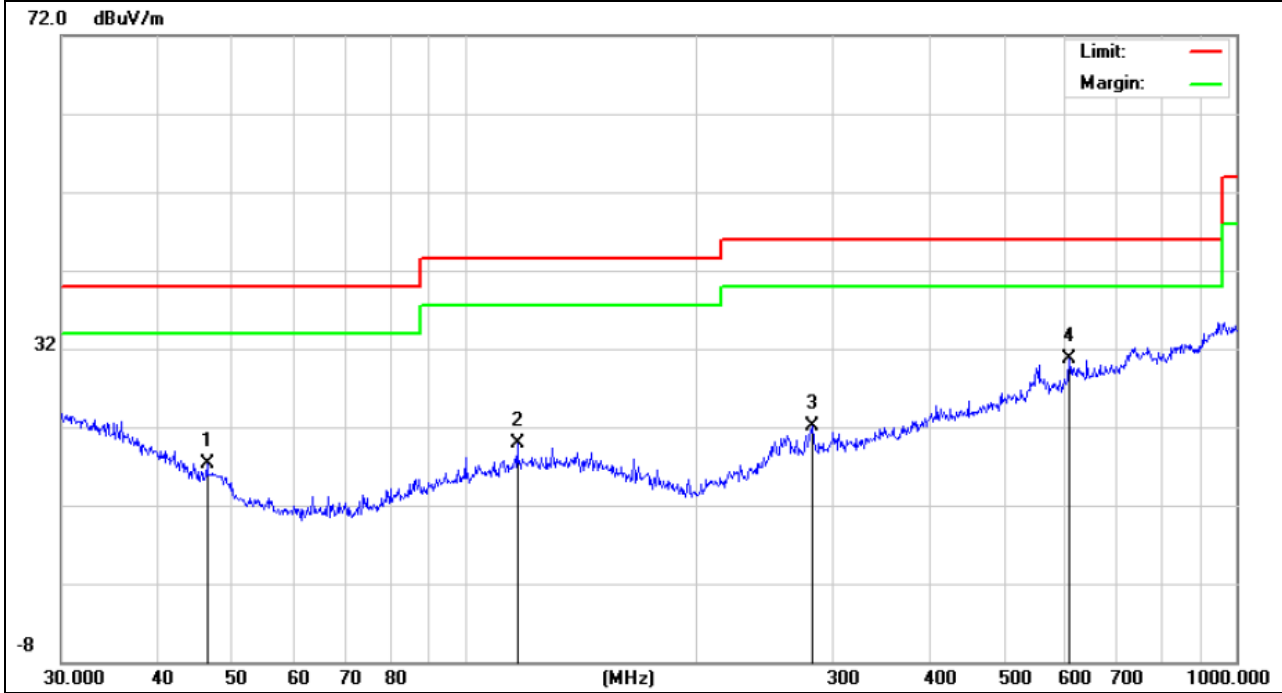

Note: The test mode 1 is the worst case, just reported the worst data in the report.

3.4.6 TEST RESULTS (ABOVE 1000 MHZ)

EUT :	Smart Kitchen Scale	Model Name :	CK10A
Temperature :	25 °C	Relative Humidity :	51%
Pressure :	1010 hPa	Test Voltage :	DC 3V
Polarization :	Horizontal		

Frequency (MHz)	Meter Reading (dBμV)	Factor (dB)	Emission Level (dBμV/m)	Limits (dBμV/m)	Margin (dB)	Detector Type
2402.000	70.46	4.53	74.99	114	-39.01	PEAK
2402.000	42.48	4.53	47.01	94	-46.99	AVG
2426.000	70.11	4.6	74.71	114	-39.29	PEAK
2426.000	41.94	4.6	46.54	94	-47.46	AVG
2480.000	70.47	4.75	75.22	114	-38.78	PEAK
2480.000	41.82	4.75	46.57	94	-47.43	AVG

EUT :	Smart Kitchen Scale	Model Name :	CK10A
Temperature :	25 °C	Relative Humidity :	51%
Pressure :	1010 hPa	Test Voltage :	DC 3V
Polarization :	Vertical		

Frequency (MHz)	Meter Reading (dBμV)	Factor (dB)	Emission Level (dBμV/m)	Limits (dBμV/m)	Margin (dB)	Detector Type
2402.000	64.64	4.53	69.17	114	-44.83	PEAK
2402.000	35.81	4.53	40.34	94	-53.66	AVG
2426.000	64.57	4.6	69.17	114	-44.83	PEAK
2426.000	34.43	4.6	39.03	94	-54.97	AVG
2480.000	64.49	4.75	69.24	114	-44.76	PEAK
2480.000	35.92	4.75	40.67	94	-53.33	AVG

Remark:

1. Factor = Antenna Factor + Cable Loss – Pre-amplifier.
2. Emission Level= Meter Reading + Factor.
3. Margin= Emission Level - Limit.

EUT :	Smart Kitchen Scale	Model Name :	CK10A
Temperature :	25 °C	Relative Humidity :	51%
Pressure :	1010 hPa	Test Voltage :	DC 3V
Test Mode :	Model 1	Polarization :	Horizontal

Frequency (MHz)	Meter Reading (dBμV)	Factor (dB)	Emission Level (dBμV/m)	Limits (dBμV/m)	Margin (dB)	Detector Type
4825.000	50.84	13.46	64.30	74.00	-9.70	PEAK
4825.000	29.38	13.46	42.84	54.00	-11.16	AVG
17022.50	35.08	27.51	62.59	74.00	-11.41	PEAK
17022.50	14.46	27.51	41.97	54.00	-12.03	AVG

Remark:
Factor = Antenna Factor + Cable Loss – Pre-amplifier.
No emission above 18GHz.

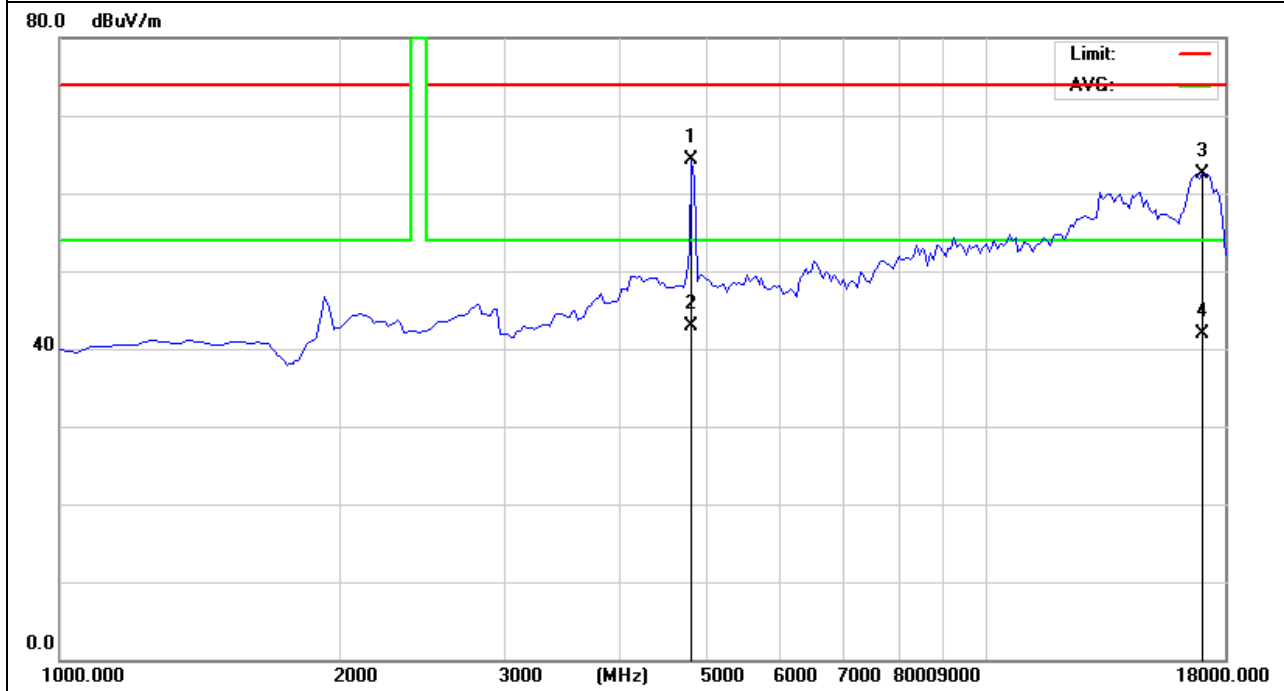

EUT :	Smart Kitchen Scale	Model Name :	CK10A
Temperature :	25 °C	Relative Humidity :	51%
Pressure :	1010 hPa	Test Voltage :	DC 3V
Test Mode :	Model 1	Polarization :	Vertical

Frequency (MHz)	Meter Reading (dBμV)	Factor (dB)	Emission Level (dBμV/m)	Limits (dBμV/m)	Margin (dB)	Detector Type
4825.000	39.21	13.46	52.67	74.00	-21.33	PEAK
4825.000	21.39	13.46	34.85	54.00	-19.15	AVG
17065.00	35.77	27.66	63.43	74.00	-10.57	PEAK
17065.00	15.80	27.66	43.46	54.00	-10.54	AVG

Remark:
 Factor = Antenna Factor + Cable Loss – Pre-amplifier.
 No emission above 18GHz.

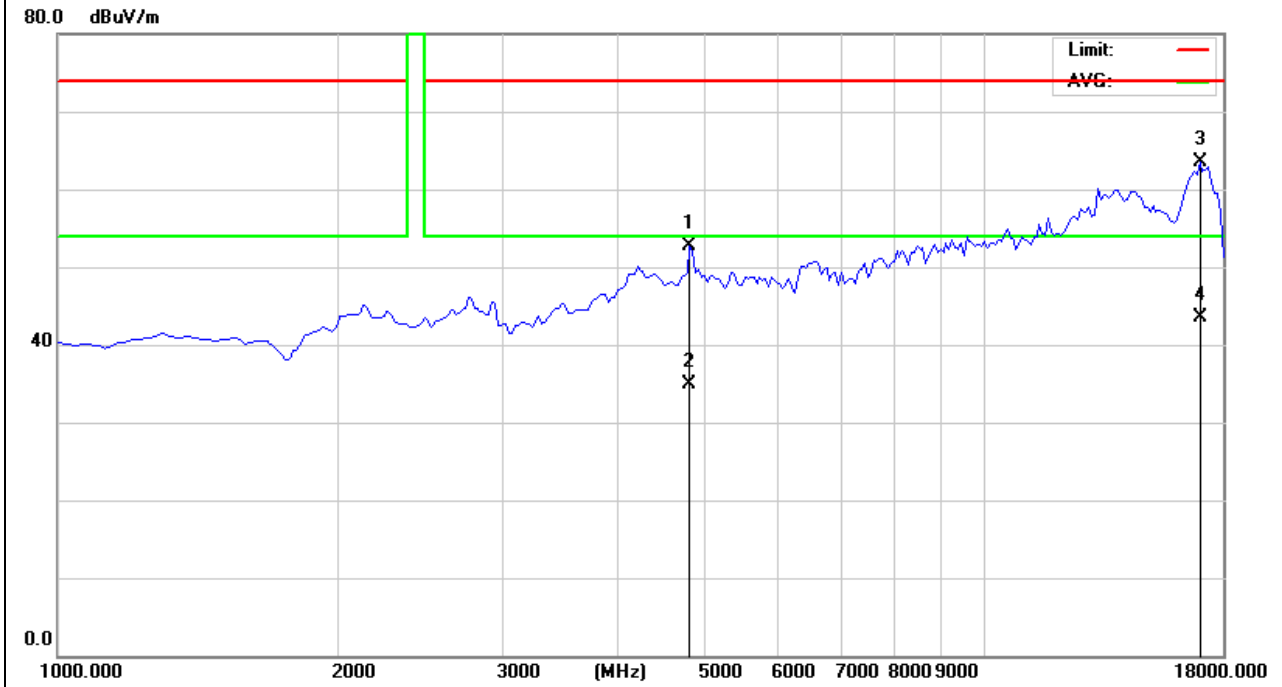

Note:

1. EUT Pre-scan X/Y/Z orientation, only worst case is presented in the report(X orientation).
2. All the modes have been test, only the worst result is presented in the report(mode 1).

3.4.7 TEST RESULTS (RESTRICTED BANDS REQUIREMENTS)

EUT :	Smart Kitchen Scale	Model Name :	CK10A
Temperature :	25 °C	Relative Humidity :	51%
Pressure :	1010 hPa	Test Voltage :	DC 3V
Test Mode :	Mode 1	Polarization :	Horizontal

Frequency (MHz)	Meter Reading (dBμV)	Factor (dB)	Emission Level (dBμV/m)	Limits (dBμV/m)	Margin (dB)	Detector Type
2400	49.97	4.53	54.5	74	-19.50	PEAK
2400	19.03	4.53	23.56	54	-30.44	AVG
2483.5	47.99	4.77	52.76	74	-21.24	PEAK

Remark:
Factor = Antenna Factor + Cable Loss – Pre-amplifier.

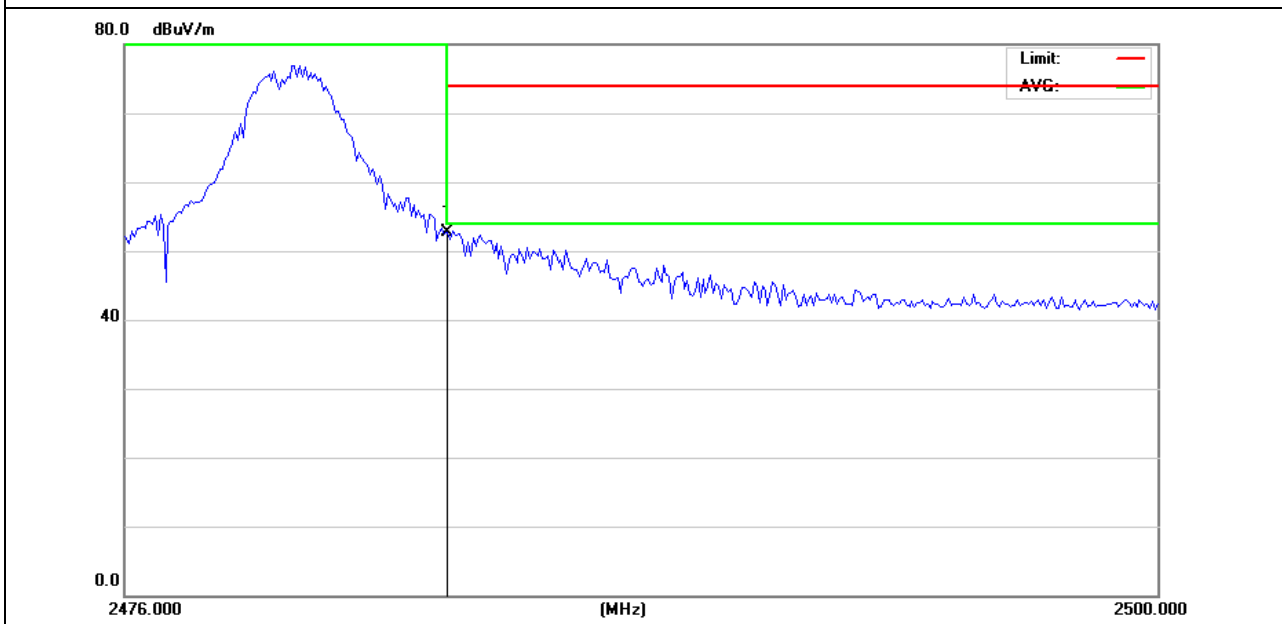
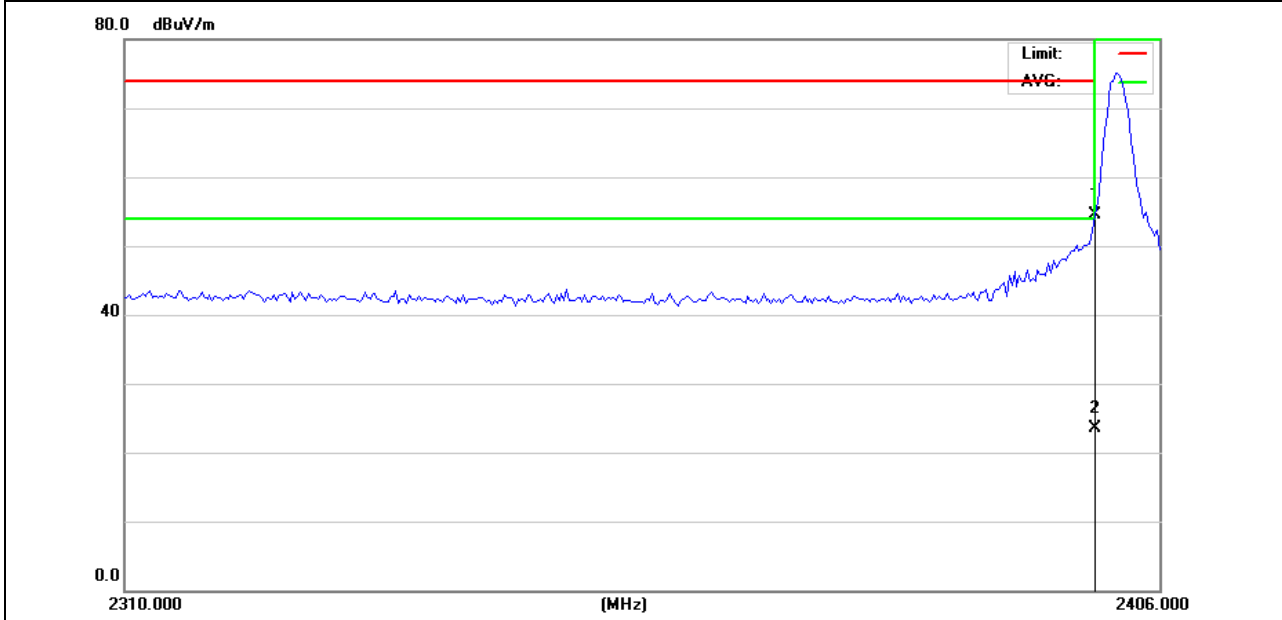

EUT :	Smart Kitchen Scale	Model Name :	CK10A
Temperature :	25 °C	Relative Humidity :	51%
Pressure :	1010 hPa	Test Voltage :	DC 3V
Test Mode :	Mode 1	Polarization :	Vertical

Frequency (MHz)	Meter Reading (dBμV)	Factor (dB)	Emission Level (dBμV/m)	Limits (dBμV/m)	Margin (dB)	Detector Type
2400	46.23	4.53	50.76	74	-23.24	PEAK
2483.5	39.5	4.77	44.27	74	-29.73	PEAK

Remark:
Factor = Antenna Factor + Cable Loss – Pre-amplifier.

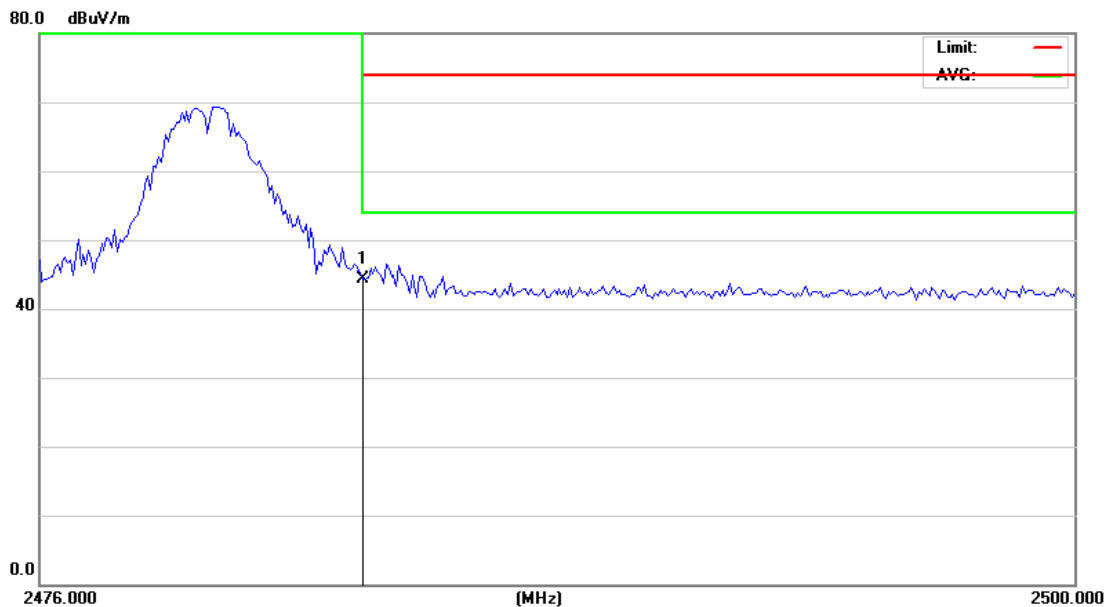
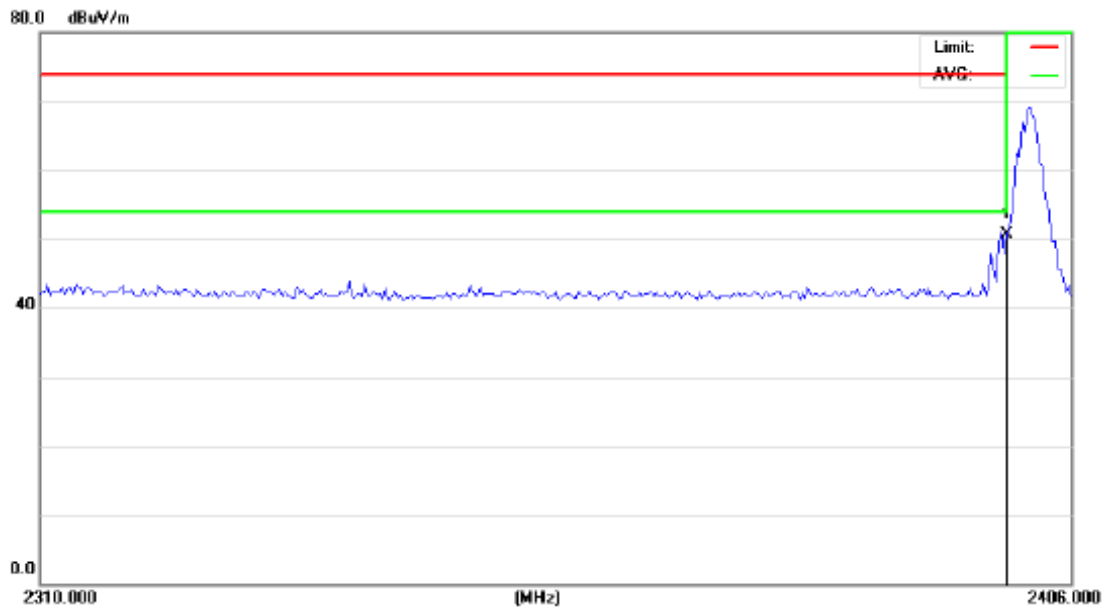

4. FREQUENCY TOLERANCE

4.1 FREQUENCY TOLERANCE LIMITS

The frequency tolerance of the carrier signal shall be maintained within $\pm 0.001\%$ of the operating frequency over a temperature variation of -20 degrees to $+50$ degrees C at normal supply voltage, and for a variation in the primary supply voltage from 85% to 115% of the rated supply voltage at a temperature of 20 degrees C.

4.2 TEST PROCEDURE

- a. The EUT was directly connected to the spectrum analyzer and antenna output port as show in the block diagram below,
- b. Spectrum Setting : RBW= 10KHz, VBW \geq RBW, Sweep time = Auto.

4.3 TEST SETUP

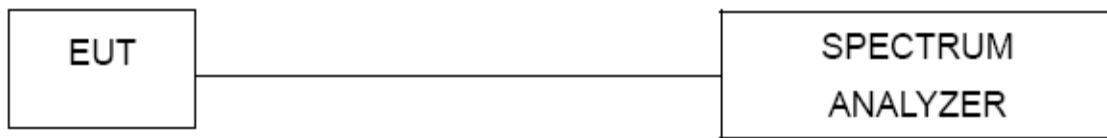

4.4 TEST RESULTS

EUT :	Smart Kitchen Scale	Model Name :	CK10A
Temperature :	26 °C	Relative Humidity :	53%
Pressure :	1020 hPa	Test Power :	
Test Mode :	N/A		

Note:

It's not applicable for this product.

5. BANDWIDTH TEST

5.1 TEST PROCEDURE

- a. The EUT was directly connected to the spectrum analyzer and antenna output port as show in the block diagram below,
- b. Spectrum Setting : RBW= 100KHz, VBW \geq RBW, Sweep time = Auto.

5.1 DEVIATION FROM STANDARD

No deviation.

5.1 TEST SETUP

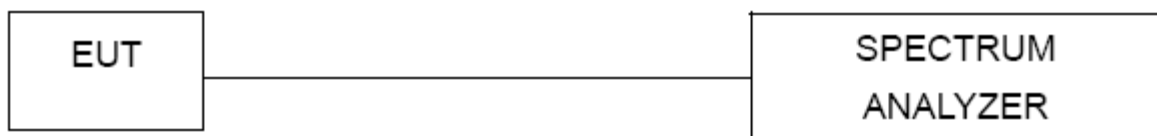

6. TEST RESULTS

EUT :	Smart Kitchen Scale	Model Name :	CK10A
Temperature :	26 °C	Relative Humidity :	53%
Pressure :	1020 hPa	Test Power :	DC 3V
Test Mode :	Model 1/2/3		

Test Channel	Frequency (MHz)	20 dBc Bandwidth (MHz)
CH01	2402	0.865
CH02	2426	0.938
CH03	2480	0.956

2402 MHz

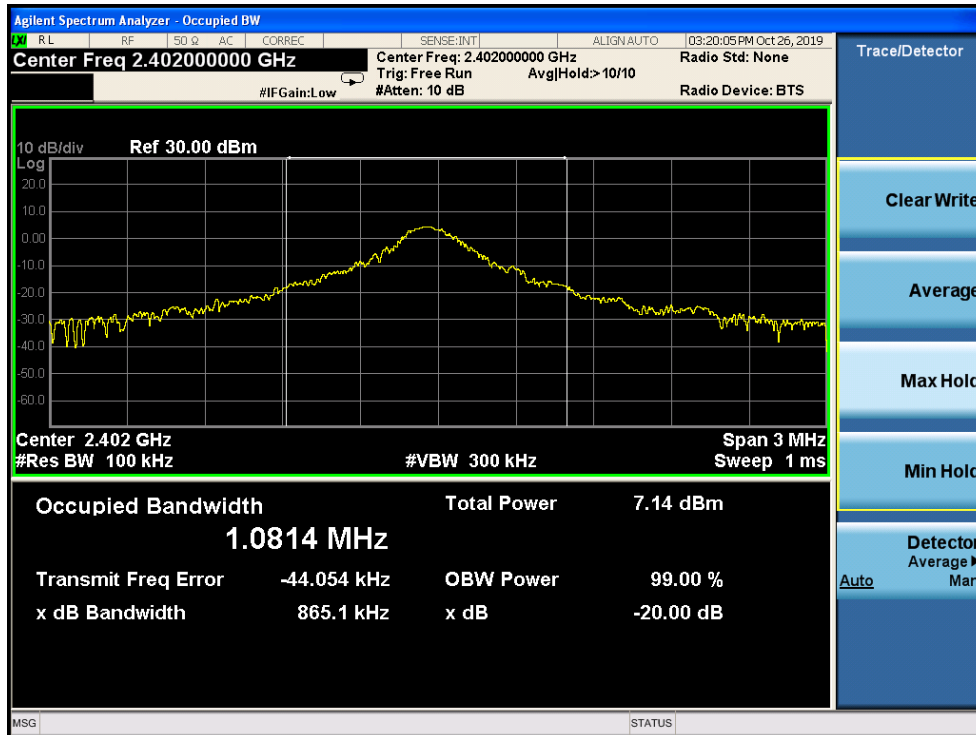

2426 MHz

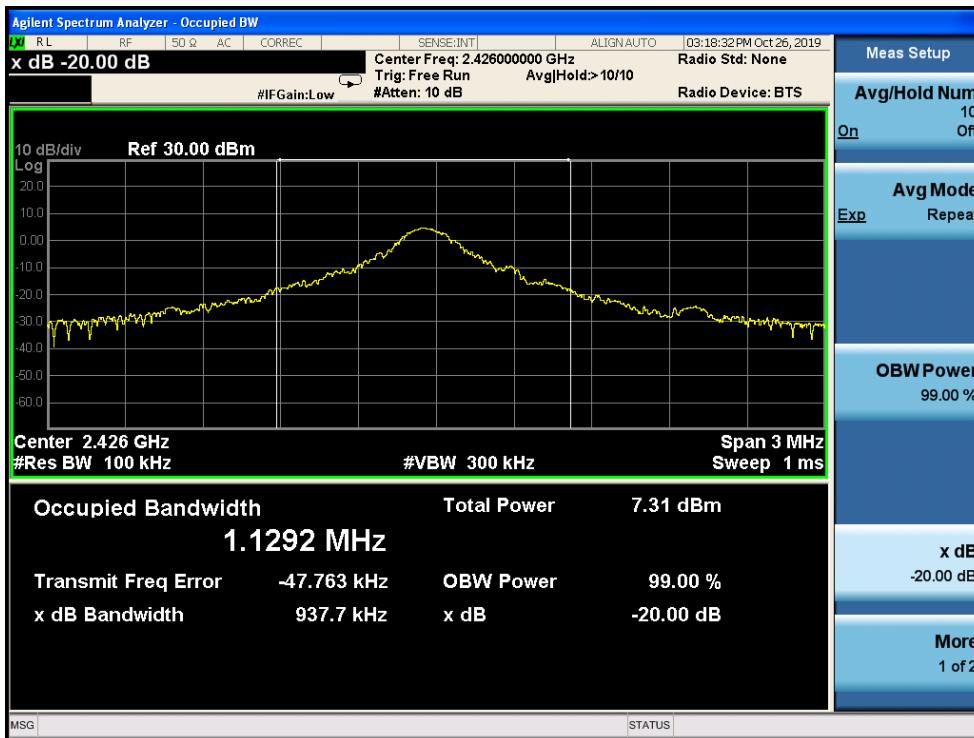

2480 MHz

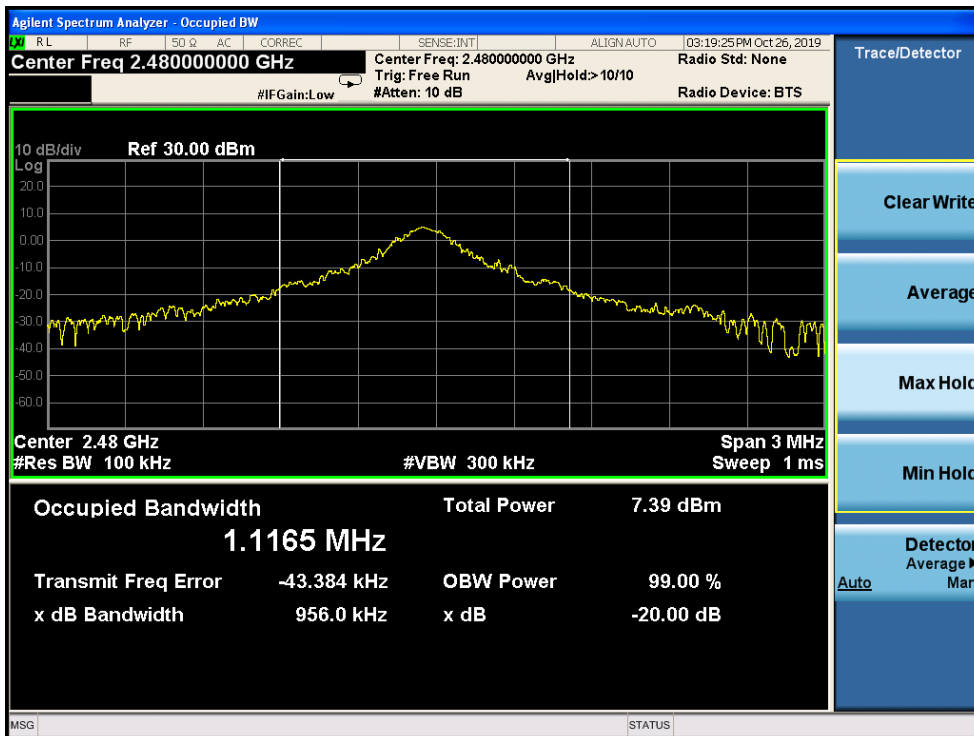

END OF REPORT