

DJI Antenna Datasheet
DM102 BLUETOOTH ANTENNA
2023-7-7



Revision history

Version	Change notes	Modifier	Date
V1.0	First draft.	Josh.hu	2023.07.07

DJI Antenna Datasheet

1、 Basic Specifications

No.	Specification	Descriptions	Notes	
1	Antenna Name	<i>DM102 Bluetooth Ant</i>		
2	Brand	<i>DJI</i>		
3	Operation Frequency	<i>2.4~2.483GHz;</i>		
4	Connector Type	<i>None</i>		
5	Impedance	<i>50ohm</i>		
6	Gain	<i>0.7dBi@2.4-2.483GHz</i>		
7	Efficiency	<i>≥30%</i>		
8	VSWR	<i>≤3</i>		
9	Polarization type	<i>Linear</i>		
10	3dB Beamwidth	<i>Omnidirectional</i>		
11	Weight			
12	Manufacturer	SZ DJI Osmo Technology Co., Ltd. 4F, Jingkou Community Comprehensive Service Building, No. 83 Bishui		

		Road North, Guangming Street, Guangming District, Shenzhen, China.		
--	--	--	--	--

2、 VSWR

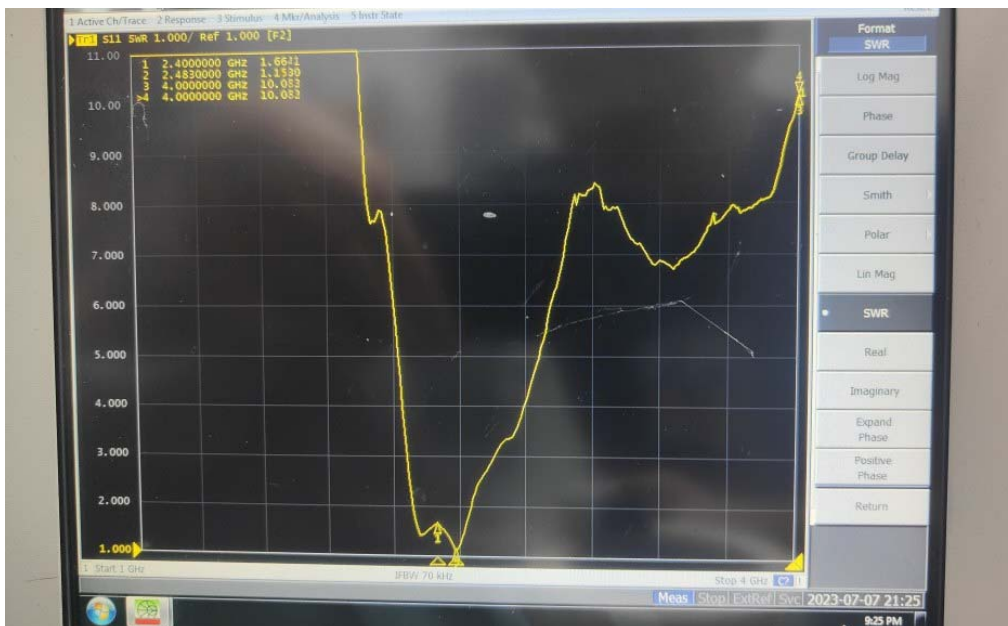

TX1

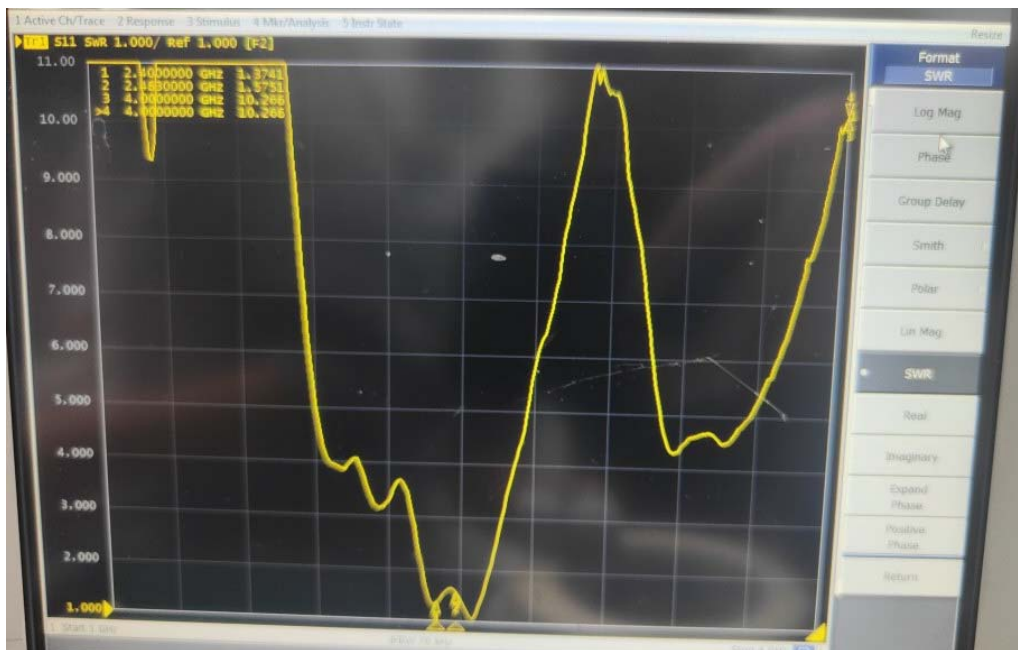

TX2

3、 Radiation Pattern

Test lab: Satimo SG24

Test date:2023.07.07

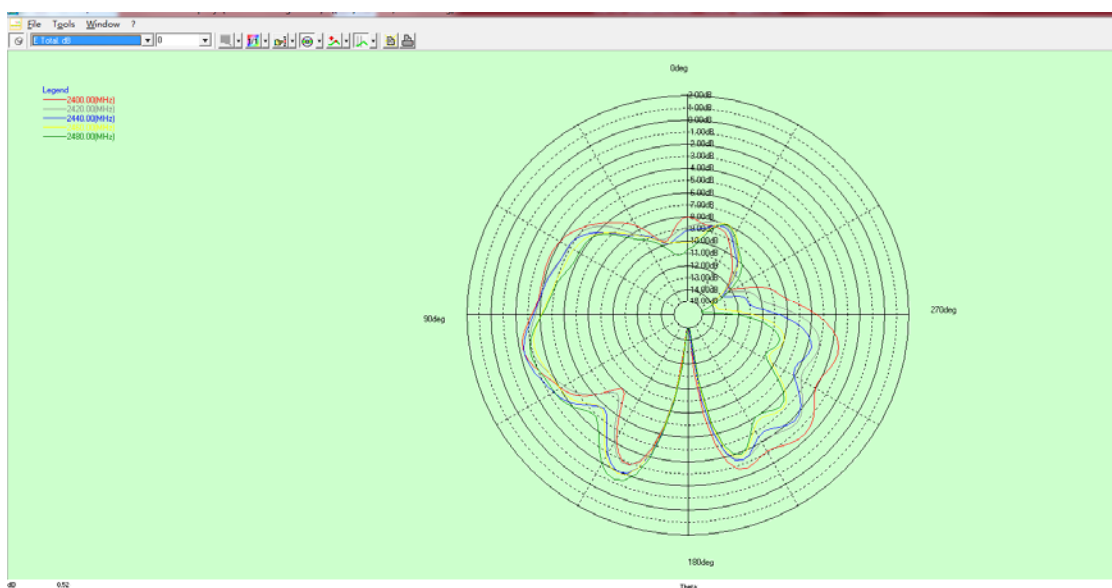

TX1Phi =0

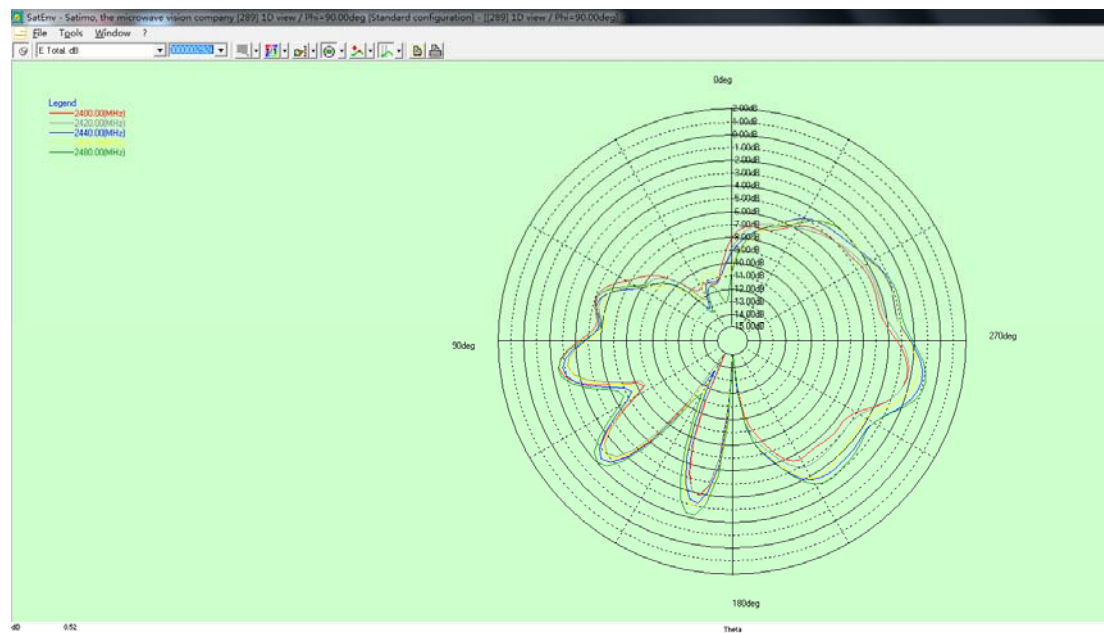

TX1Phi = 90

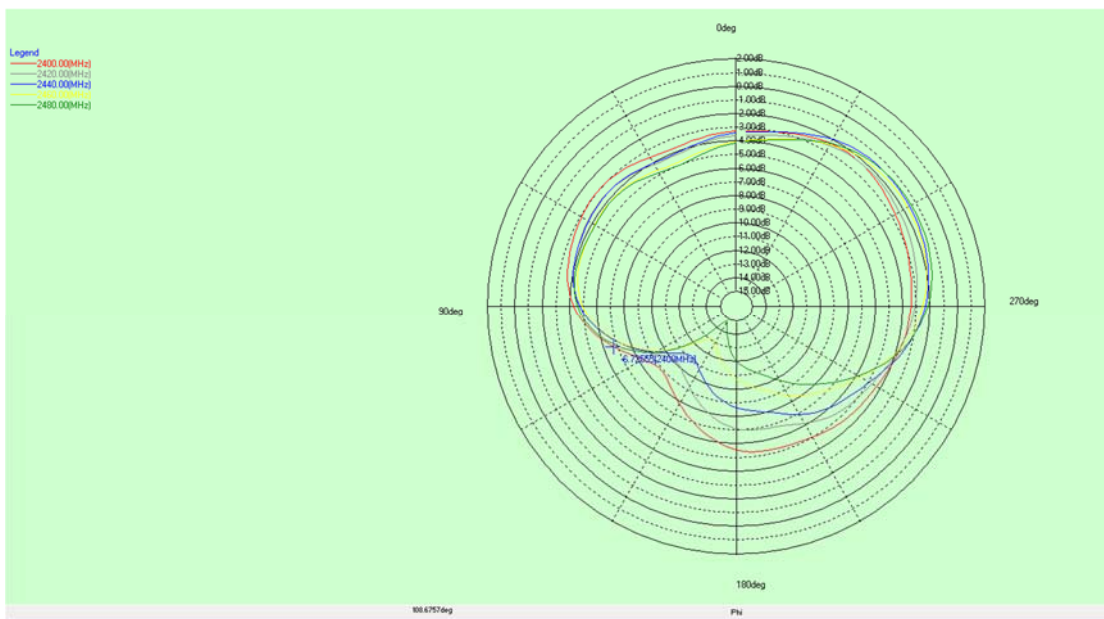

TX1Theta = 90

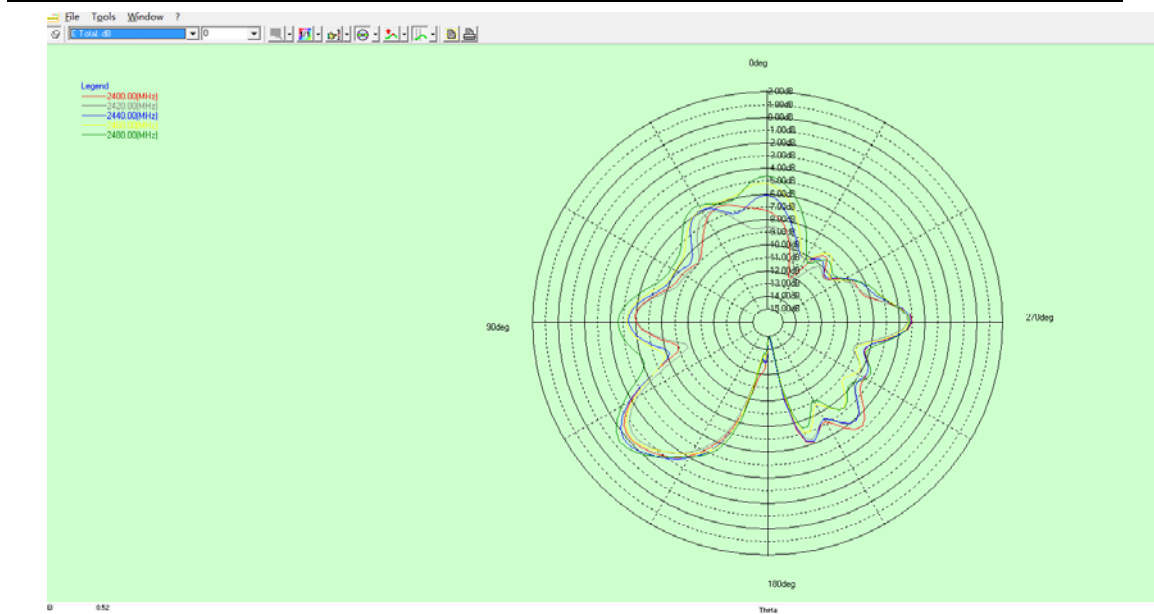

TX2Phi = 0

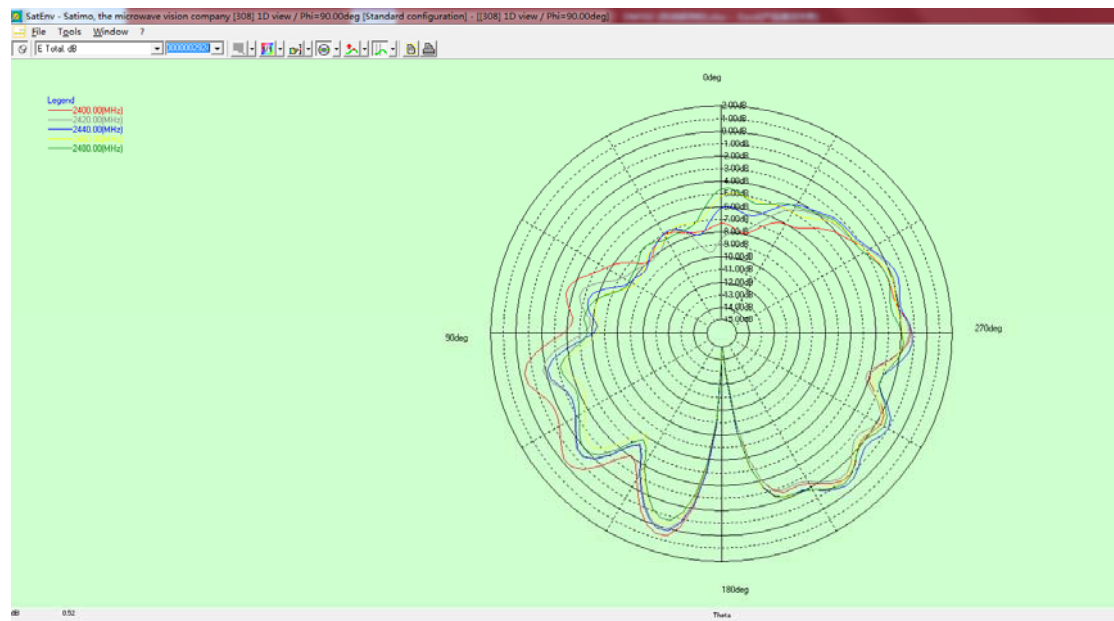

TX2Phi = 90

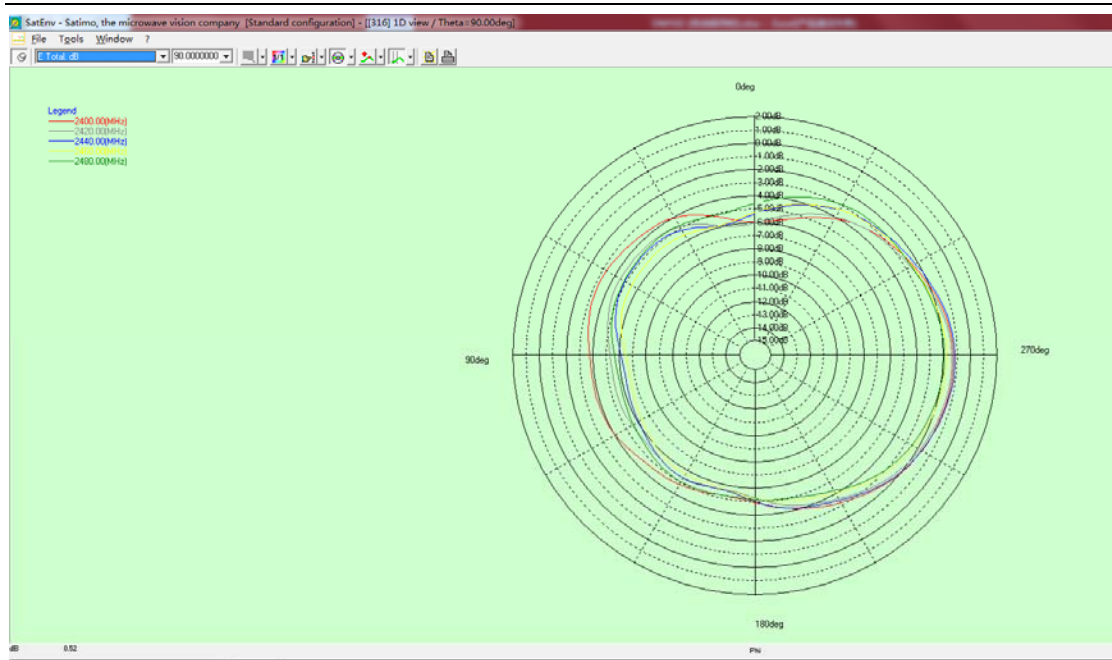

TX2Theta =90

4、 Structure drawing

TX1:

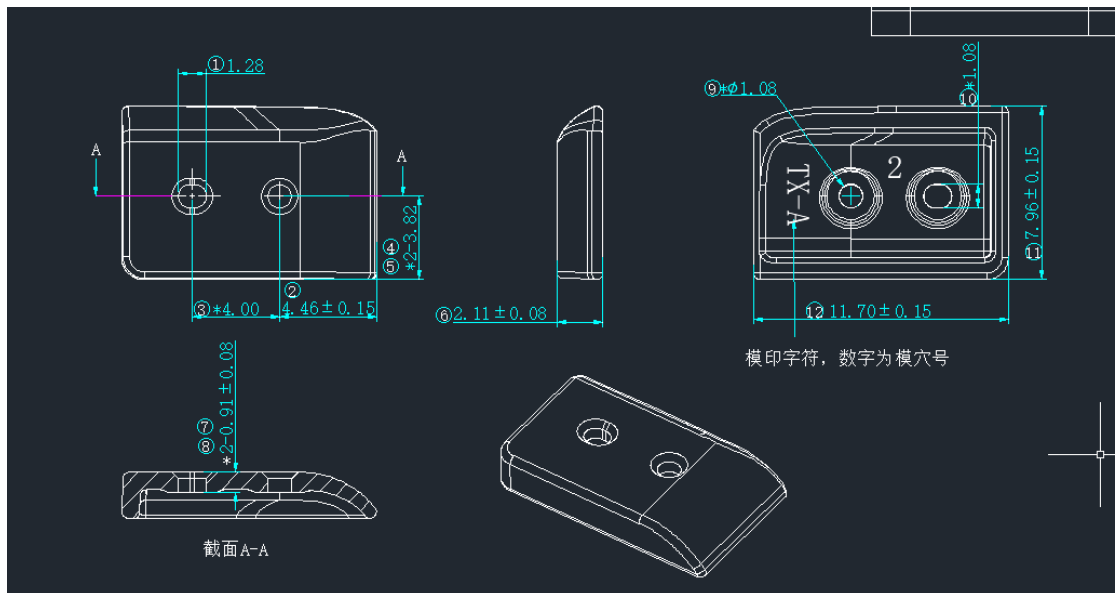

TX2 (PCB 天线) :

