

DJI Antenna Datasheet  
DM102 BLUETOOTH ANTENNA  
2023-7-7



---

## Revision history

Version	Change notes	Modifier	Date
V1.0	First draft.	Josh.hu	2023.07.07

# DJI Antenna Datasheet

## 1、 Basic Specifications

No.	Specification	Descriptions	Notes	
1	Antenna Name	<i>DM102 Bluetooth Ant</i>		
2	Brand	<i>DJI</i>		
3	Operation Frequency	<i>2.4~2.483GHz;</i>		
4	Connector Type	<i>None</i>		
5	Impedance	<i>50ohm</i>		
6	Gain	<i>0.3dBi@2.4-2.483GHz</i>		
7	Efficiency	<i>≥30%</i>		
8	VSWR	<i>≤3</i>		
9	Polarization type	<i>Linear</i>		
10	3dB Beamwidth	<i>Omnidirectional</i>		
11	Weight			
12	Manufacturer	SZ DJI Osmo Technology Co., Ltd. 4F, Jingkou Community Comprehensive Service Building, No. 83 Bishui		



		Road North, Guangming Street, Guangming District, Shenzhen, China.		
--	--	--	--	--

## 2、 VSWR

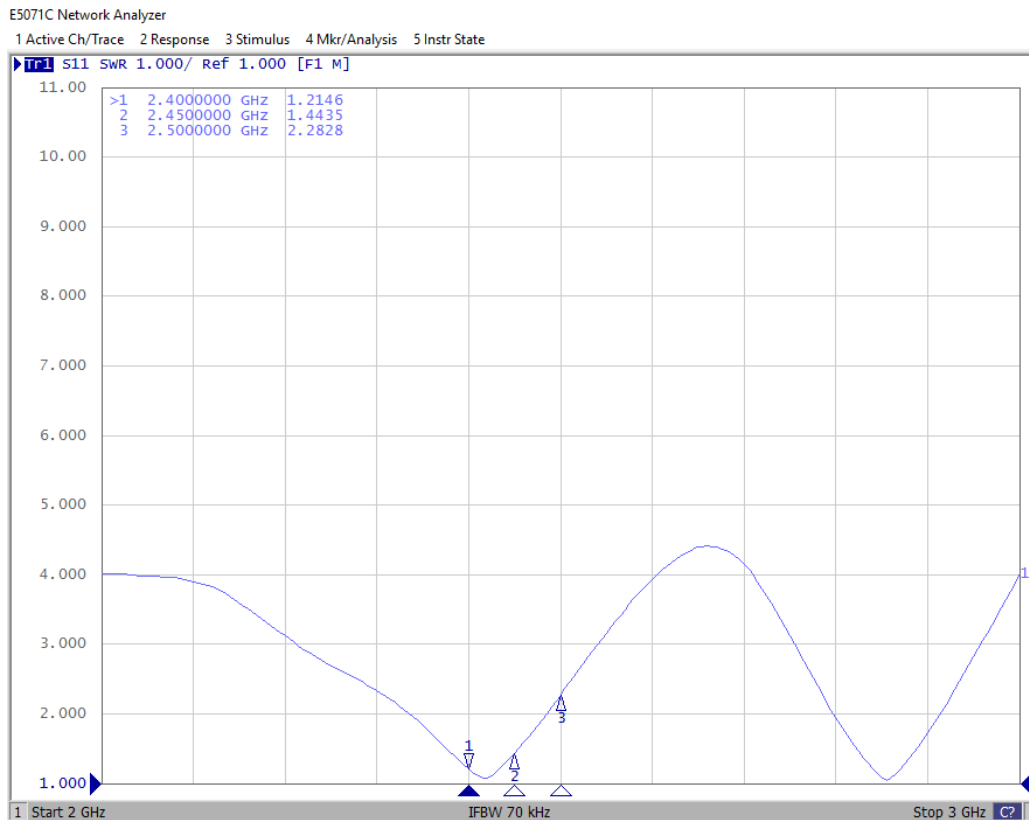

RX1

E5071C Network Analyzer

1 Active Ch/Trace 2 Response 3 Stimulus 4 Mkr/Analysis 5 Instr State

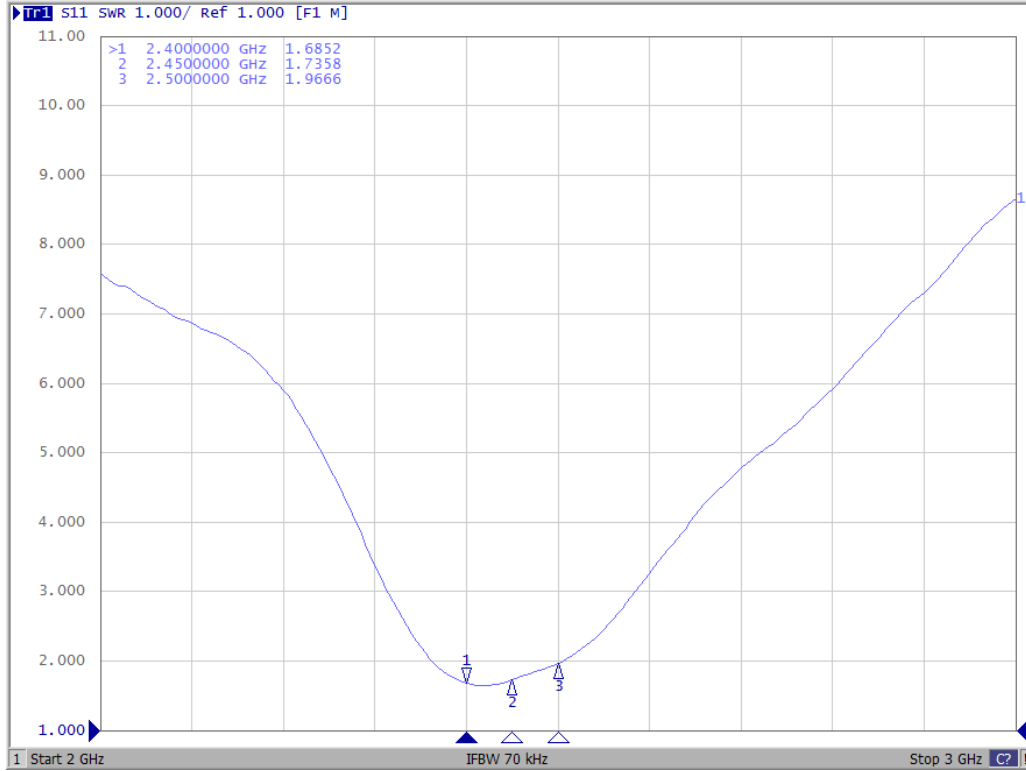

RX2

### 3、 Radiation Pattern

Test lab: Satimo SG24

Test date:2023.07.07

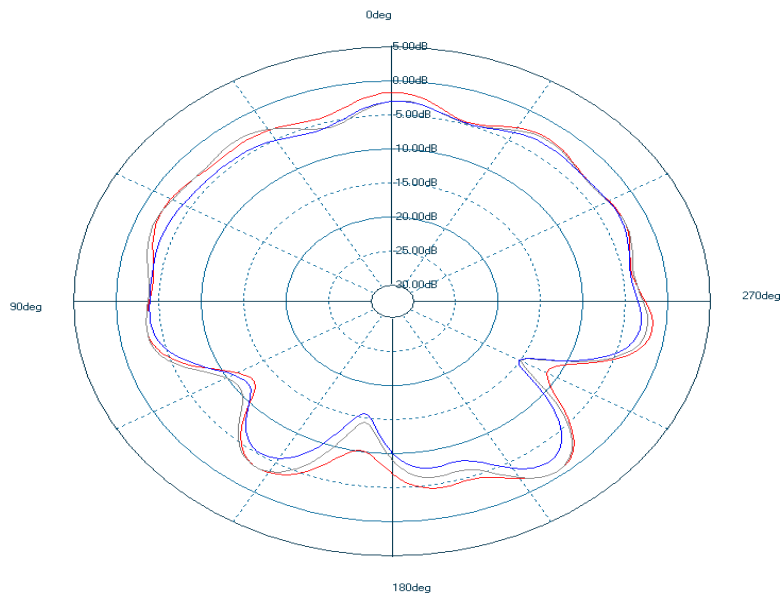

### RX1Phi = 0

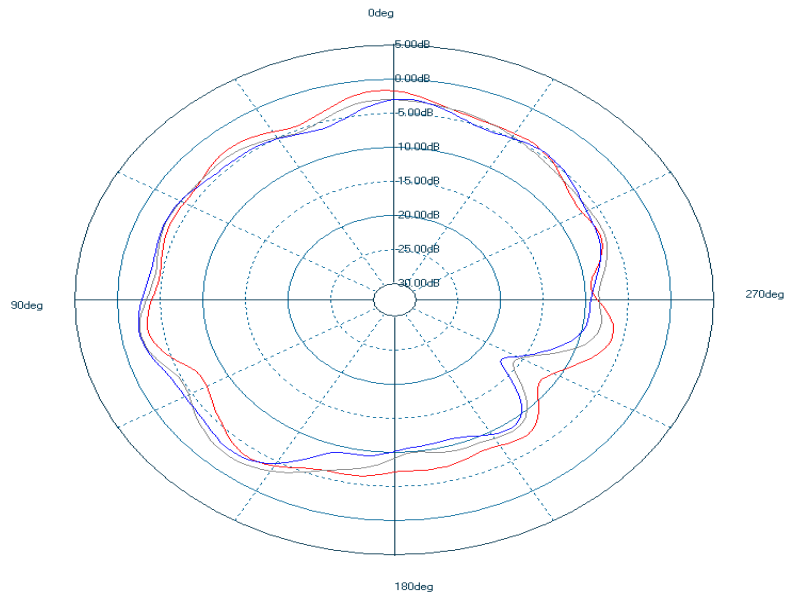

### RX1Phi = 90

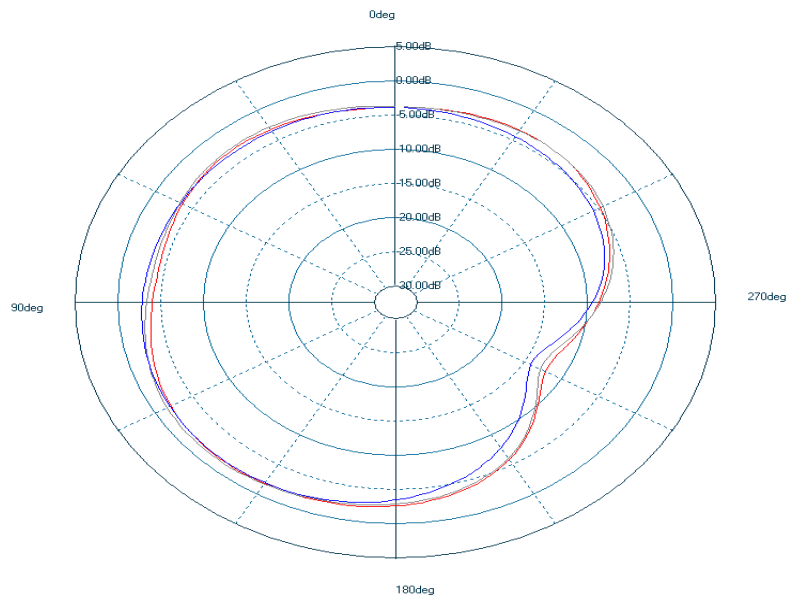

### RX1Theta = 90

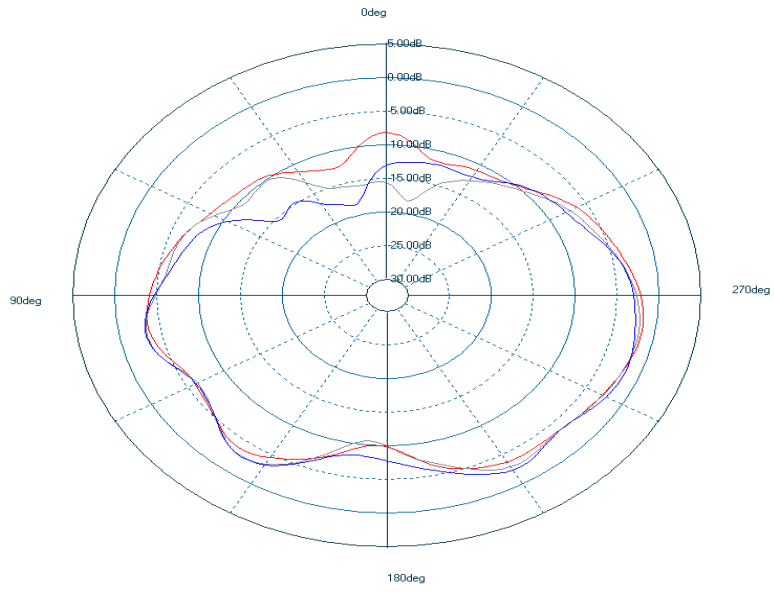

$RX2\Phi = 0$

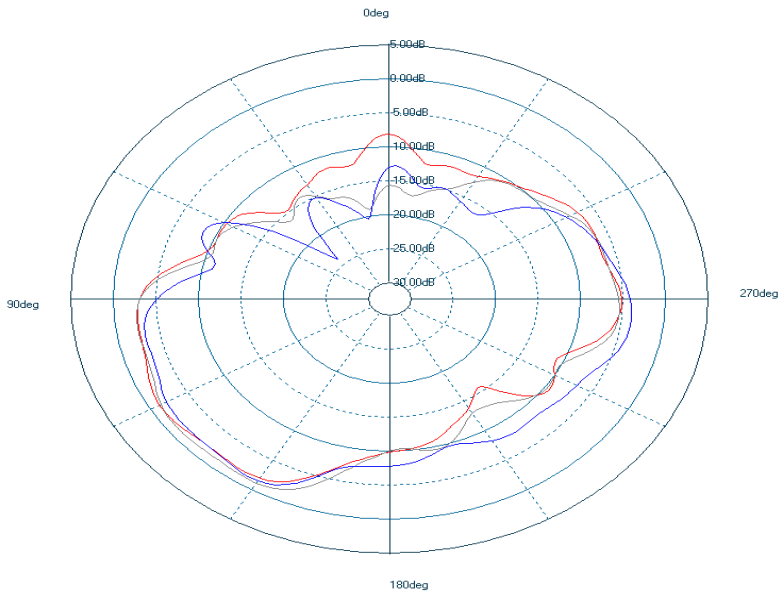

$RX2\Phi = 90$

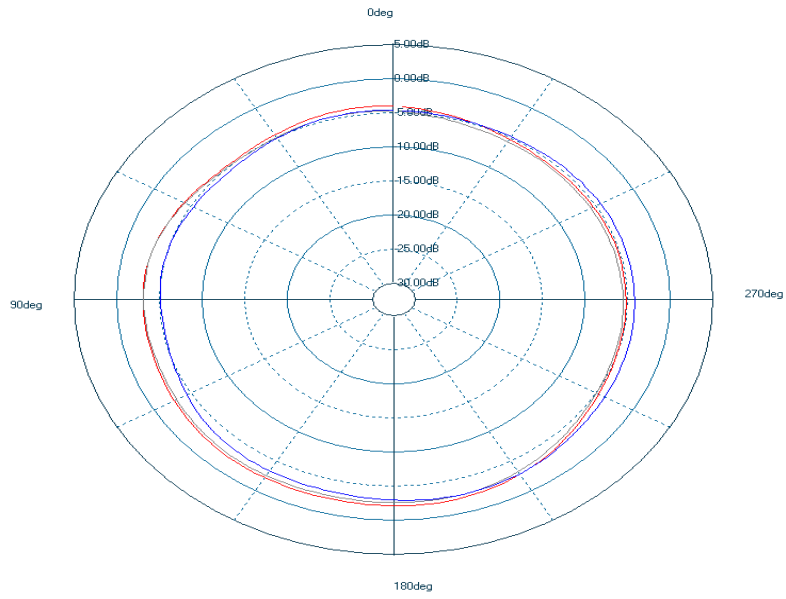

RX2Theta =90

———2400MHz

———2440MHz

———2480MHz

#### 4、 Structure drawing

RX1:

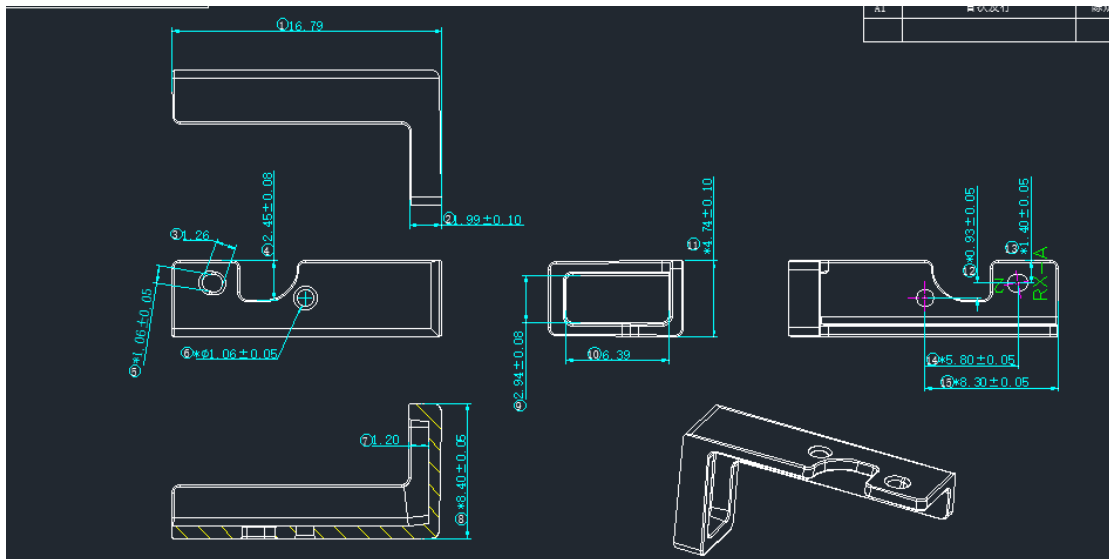

RX2:



