

**CFR 47 FCC PART 15 SUBPART C  
ISED RSS-247 Issue 3**

**TEST REPORT**

*For*

**DJI Focus Pro Grip**

**MODEL NUMBER: DF03-003**

**REPORT NUMBER: 4790983922.1-1-RF-1**

**ISSUE DATE: January 10, 2024**

**FCC ID: 2ANDR-DF03323**

**IC: 23060-DF03323**

*Prepared for*

**SZ DJI Osmo Technology Co.,Ltd.**

**4F, Jingkou Community Comprehensive Service Building, No. 83 Bishui Road  
North, Guangming Street, Guangming District, Shenzhen, China**

*Prepared by*

**UL Verification Services (Guangzhou) Co., Ltd, Song Shan Lake Branch**

**Building 10, Innovation Technology Park, No. 1, Li Bin Road, Song Shan Lake Hi-Tech Development Zone Dongguan, 523808, People's Republic of China**

**Tel: +86 769 22038881**

**Fax: +86 769 33244054**

**Website: [www.ul.com](http://www.ul.com)**

## Revision History

Rev.	Issue Date	Revisions	Revised By
V0	January 10, 2024	Initial Issue	

### Summary of Test Results

Test Item	Clause	Limit/Requirement	Result
Antenna Requirement	N/A	FCC Part 15.203/15.247 (c) RSS-GEN Clause 6.8	Pass
AC Power Line Conducted Emission	ANSI C63.10-2013, Clause 6.2	FCC Part 15.207 RSS-GEN Clause 8.8	Pass
Conducted Output Power	ANSI C63.10-2013, Clause 11.9.1.3	FCC Part 15.247 (b)(3) RSS-247 Clause 5.4 (d)	Pass
6dB Bandwidth and 99% Occupied Bandwidth	ANSI C63.10-2013, Clause 11.8.1	FCC Part 15.247 (a)(2) RSS-247 Clause 5.2 (a) ISED RSS-Gen Clause 6.7	Pass
Power Spectral Density	ANSI C63.10-2013, Clause 11.10.2	FCC Part 15.247 (e) RSS-247 Clause 5.2 (b)	Pass
Conducted Band edge and spurious emission	ANSI C63.10-2013, Clause 11.11	FCC Part 15.247(d) RSS-247 Clause 5.5	Pass
Radiated Band edge and Spurious Emission	ANSI C63.10-2013, Clause 11.12 & Clause 11.13	FCC Part 15.247 (d) FCC Part 15.205/15.209 RSS-247 Clause 5.5 RSS-GEN Clause 8.9	Pass
Duty Cycle	ANSI C63.10-2013, Clause 11.6	None; for reporting purposes only.	Pass

\*This test report is only published to and used by the applicant, and it is not for evidence purpose in China.

\*The measurement result for the sample received is <Pass> according to <CFR 47 FCC PART 15 SUBPART C ISED RSS-247 Issue 3> when <Simple Acceptance> decision rule is applied.

## CONTENTS

<b>1. ATTESTATION OF TEST RESULTS</b> .....	<b>6</b>
<b>2. TEST METHODOLOGY</b> .....	<b>7</b>
<b>3. FACILITIES AND ACCREDITATION</b> .....	<b>7</b>
<b>4. CALIBRATION AND UNCERTAINTY</b> .....	<b>8</b>
4.1. <i>MEASURING INSTRUMENT CALIBRATION</i> .....	8
4.2. <i>MEASUREMENT UNCERTAINTY</i> .....	8
<b>5. EQUIPMENT UNDER TEST</b> .....	<b>9</b>
5.1. <i>DESCRIPTION OF EUT</i> .....	9
5.2. <i>CHANNEL LIST</i> .....	9
5.3. <i>MAXIMUM POWER</i> .....	9
5.4. <i>TEST CHANNEL CONFIGURATION</i> .....	9
5.5. <i>THE WORSE CASE POWER SETTING PARAMETER</i> .....	10
5.6. <i>DESCRIPTION OF AVAILABLE ANTENNAS</i> .....	10
5.7. <i>SUPPORT UNITS FOR SYSTEM TEST</i> .....	11
<b>6. MEASURING EQUIPMENT AND SOFTWARE USED</b> .....	<b>12</b>
<b>7. ANTENNA PORT TEST RESULTS</b> .....	<b>15</b>
7.1. <i>CONDUCTED OUTPUT POWER</i> .....	15
7.2. <i>6DB BANDWIDTH AND 99% OCCUPIED BANDWIDTH</i> .....	16
7.3. <i>POWER SPECTRAL DENSITY</i> .....	18
7.4. <i>CONDUCTED BAND EDGE AND SPURIOUS EMISSION</i> .....	20
7.5. <i>DUTY CYCLE</i> .....	22
<b>8. RADIATED TEST RESULTS</b> .....	<b>23</b>
8.1. <i>RESTRICTED BANDEDGE</i> .....	31
8.2. <i>SPURIOUS EMISSIONS(1 GHZ~3 GHZ)</i> .....	41
8.3. <i>SPURIOUS EMISSIONS(3 GHZ~18 GHZ)</i> .....	47
8.4. <i>SPURIOUS EMISSIONS(9 KHZ~30 MHZ)</i> .....	59
8.5. <i>SPURIOUS EMISSIONS(18 GHZ~26 GHZ)</i> .....	62
8.6. <i>SPURIOUS EMISSIONS(30 MHZ~1 GHZ)</i> .....	64
<b>9. ANTENNA REQUIREMENT</b> .....	<b>66</b>
<b>10. AC POWER LINE CONDUCTED EMISSION</b> .....	<b>67</b>
<b>11. TEST DATA</b> .....	<b>70</b>
11.1. <i>APPENDIX A: DTS BANDWIDTH</i> .....	70
11.1.1.    Test Result.....	70

11.1.2.	Test Graphs .....	71
11.2.	<i>APPENDIX B: OCCUPIED CHANNEL BANDWIDTH .....</i>	<i>73</i>
11.2.1.	Test Result .....	73
11.2.2.	Test Graphs .....	74
11.3.	<i>APPENDIX C: MAXIMUM CONDUCTED OUTPUT POWER .....</i>	<i>76</i>
11.3.1.	Test Result .....	76
11.4.	<i>APPENDIX D: MAXIMUM POWER SPECTRAL DENSITY .....</i>	<i>77</i>
11.4.1.	Test Result .....	77
11.4.2.	Test Graphs .....	78
11.5.	<i>APPENDIX E: BAND EDGE MEASUREMENTS .....</i>	<i>80</i>
11.5.1.	Test Result .....	80
11.5.2.	Test Graphs .....	81
11.6.	<i>APPENDIX F: CONDUCTED SPURIOUS EMISSION .....</i>	<i>83</i>
11.6.1.	Test Result .....	83
11.6.2.	Test Graphs .....	84
11.7.	<i>APPENDIX G: DUTY CYCLE .....</i>	<i>90</i>
11.7.1.	Test Result .....	90
11.7.2.	Test Graphs .....	91

# 1. ATTESTATION OF TEST RESULTS

## Applicant Information

Company Name: SZ DJI Osmo Technology Co.,Ltd.  
Address: 4F, Jinkou Community Comprehensive Service Building, No. 83 Bishui Road North, Guangming Street, Guangming District, Shenzhen, China

## Manufacturer Information

Company Name: SZ DJI Osmo Technology Co.,Ltd.  
Address: 4F, Jinkou Community Comprehensive Service Building, No. 83 Bishui Road North, Guangming Street, Guangming District, Shenzhen, China

## EUT Information

EUT Name: DJI Focus Pro Grip  
Model: DF03-003  
Brand: DJI  
Sample Received Date: November 16, 2023  
Sample Status: Normal  
Sample ID: 6425698-1  
Date of Tested: December 15, 2023 to January 10, 2024

APPLICABLE STANDARDS	
STANDARD	TEST RESULTS
CFR 47 FCC PART 15 SUBPART C ISED RSS-247 Issue 3	Pass

Prepared By:



Fanny Huang  
Engineer Project Associate

Checked By:

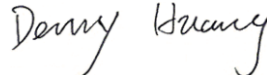

Denny Huang  
Senior Project Engineer

Approved By:



Stephen Guo  
Operations Manager

## 2. TEST METHODOLOGY

All tests were performed in accordance with the standard CFR 47 FCC PART 15 SUBPART C ISED RSS-247 Issue 3, KDB 558074 D01 15.247 Meas Guidance v05r02, 414788 D01 Radiated Test Site v01r01, CFR 47 FCC Part 2, ANSI C63.10-2013 and ISED RSS-GEN Issue 5.

## 3. FACILITIES AND ACCREDITATION

Accreditation Certificate	<p><b>A2LA (Certificate No.: 4102.01)</b> UL Verification Services (Guangzhou) Co., Ltd. Song Shan Lake Branch. has been assessed and proved to be in compliance with A2LA.</p> <p><b>FCC (FCC Designation No.: CN1187)</b> UL Verification Services (Guangzhou) Co., Ltd. Song Shan Lake Branch. Has been recognized to perform compliance testing on equipment subject to the Commission's Declaration of Conformity (DoC) and Certification rules</p> <p><b>ISED (Company No.: 21320)</b> UL Verification Services (Guangzhou) Co., Ltd. Song Shan Lake Branch. has been registered and fully described in a report filed with ISED. The Company Number is 21320 and the test lab Conformity Assessment Body Identifier (CABID) is CN0046.</p> <p><b>VCCI (Registration No.: G-20192, C-20153, T-20155 and R-20202)</b> UL Verification Services (Guangzhou) Co., Ltd. Song Shan Lake Branch. has been assessed and proved to be in compliance with VCCI, the Membership No. is 3793. Facility Name: Chamber D, the VCCI registration No. is G-20192 and R-20202 Shielding Room B, the VCCI registration No. is C-20153 and T-20155</p>
---------------------------	--

Note 1:

All tests measurement facilities use to collect the measurement data are located at Building 10, Innovation Technology Park, No. 1, Li Bin Road, Song Shan Lake Hi-Tech Development Zone Dongguan, 523808, People's Republic of China.

Note 2:

The test anechoic chamber in UL Verification Services (Guangzhou) Co., Ltd. Song Shan Lake Branch had been calibrated and compared to the open field sites and the test anechoic chamber is shown to be equivalent to or worst case from the open field site.

Note 3:

For below 30 MHz, lab had performed measurements at test anechoic chamber and comparing to measurements obtained on an open field site. And these measurements below 30 MHz had been correlated to measurements performed on an OFS.

## 4. CALIBRATION AND UNCERTAINTY

### 4.1. MEASURING INSTRUMENT CALIBRATION

The measuring equipment utilized to perform the tests documented in this report has been calibrated in accordance with the manufacturer's recommendations and is traceable to recognized national standards.

### 4.2. MEASUREMENT UNCERTAINTY

Where relevant, the following measurement uncertainty levels have been estimated for tests performed on the apparatus:

Test Item	Uncertainty
Conduction emission	3.62 dB
Radiated Emission (Included Fundamental Emission) (9 kHz ~ 30 MHz)	2.2 dB
Radiated Emission (Included Fundamental Emission) (30 MHz ~ 1 GHz)	4.00 dB
Radiated Emission (Included Fundamental Emission) (1 GHz to 26 GHz)	5.78 dB (1 GHz ~ 18 GHz)
	5.23 dB (18 GHz ~ 26 GHz)
Duty Cycle	±0.028%
DTS and 99% Occupied Bandwidth	±0.0196%
Maximum Conducted Output Power	±0.686 dB
Maximum Power Spectral Density Level	±0.743 dB
Conducted Band-edge Compliance	±1.328 dB
Conducted Unwanted Emissions In Non-restricted Frequency Bands	±0.746 dB (9 kHz ~ 1 GHz)
	±1.328dB (1 GHz ~ 26 GHz)
Note: This uncertainty represents an expanded uncertainty expressed at approximately the 95% confidence level using a coverage factor of k=2.	



## 5. EQUIPMENT UNDER TEST

### 5.1. DESCRIPTION OF EUT

EUT Name	DJI Focus Pro Grip
Model	DF03-003

Frequency Range:	2402 MHz to 2480 MHz
Type of Modulation:	GFSK
Data Rates:	1Mbps/2Mbps
Normal Test Voltage:	DC 7.2 V

### 5.2. CHANNEL LIST

Channel	Frequency (MHz)	Channel	Frequency (MHz)	Channel	Frequency (MHz)	Channel	Frequency (MHz)
0	2402	11	2424	22	2446	33	2468
1	2404	12	2426	23	2448	34	2470
2	2406	13	2428	24	2450	35	2472
3	2408	14	2430	25	2452	36	2474
4	2410	15	2432	26	2454	37	2476
5	2412	16	2434	27	2456	38	2478
6	2414	17	2436	28	2458	39	2480
7	2416	18	2438	29	2460	/	/
8	2418	19	2440	30	2462	/	/
9	2420	20	2442	31	2464	/	/
10	2422	21	2444	32	2468	/	/

### 5.3. MAXIMUM POWER

Test Mode	Frequency (MHz)	Channel Number	Maximum Peak Output Power (dBm)
LE 1M	2402 ~ 2480	0-39[40]	4.31
LE 2M	2402 ~ 2480	0-39[40]	4.42

### 5.4. TEST CHANNEL CONFIGURATION

Test Mode	Test Channel	Frequency
LE 1M	CH 0(Low Channel), CH 19(MID Channel), CH 39(High Channel)	2402 MHz, 2440 MHz, 2480 MHz
LE 2M	CH 0(Low Channel), CH 19(MID Channel), CH 39(High Channel)	2402 MHz, 2440 MHz, 2480 MHz

### 5.5. THE WORSE CASE POWER SETTING PARAMETER

The Worst Case Power Setting Parameter under 2400 ~ 2483.5MHz Band				
Test Software Version		DTM		
Modulation Type	Transmit Antenna Number	Test Software setting value		
		CH 0	CH 19	CH 39
GFSK(1Mbps)	1	4	4	4
GFSK(2Mbps)	1	4	4	4

### 5.6. DESCRIPTION OF AVAILABLE ANTENNAS

Antenna	Frequency (MHz)	Antenna Type	MAX Antenna Gain (dBi)
1	2402-2480	PCB	1.04

Test Mode	Transmit and Receive Mode	Description
LE 1M	<input checked="" type="checkbox"/> 1TX, 1RX	Antenna 1 can be used as transmitting/receiving antenna.
LE 2M	<input checked="" type="checkbox"/> 1TX, 1RX	Antenna 1 can be used as transmitting/receiving antenna.

## 5.7. SUPPORT UNITS FOR SYSTEM TEST

### SUPPORT EQUIPMENT

Item	Equipment	Brand Name	Model Name	Remarks
1	Laptop	Lenovo	E42-80	R303U5AG
2	UART	/	/	/
3	AC Power Adapter	/	PD-30CN	Input: AC 100-240 V, 50-60Hz, 0.8A Max Output: DC 3.3-11 V, 2.72A

### I/O CABLES

Cable No	Port	Connector Type	Cable Type	Cable Length(m)	Remarks
1	USB	/	/	1.0	/

### ACCESSORIES

Item	Accessory	Brand Name	Model Name	Description
/	/	/	/	/

### TEST SETUP

The EUT can work in engineering mode with a software through a Laptop.

### SETUP DIAGRAM FOR TESTS

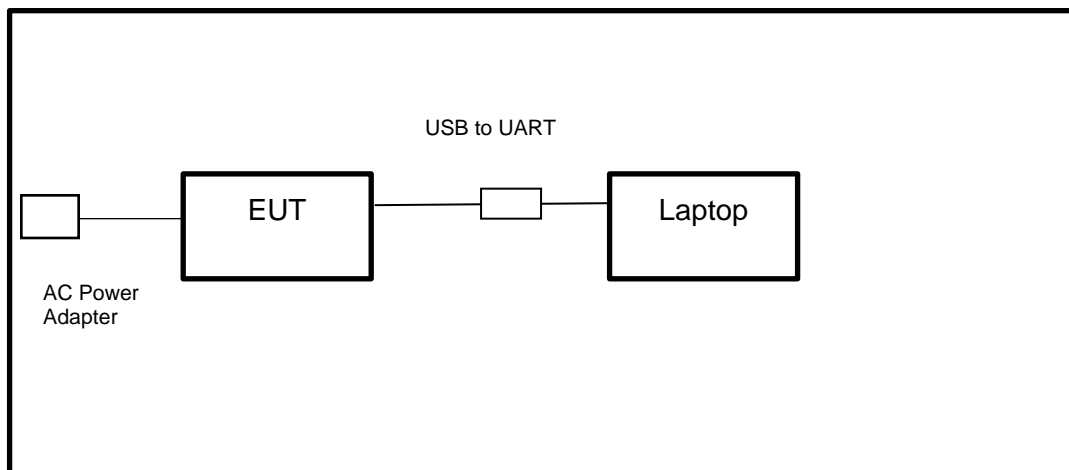

AC Power Adapter only used for AC Power Line Conducted Emission test.

## 6. MEASURING EQUIPMENT AND SOFTWARE USED

R&S TS 8997 Test System					
Equipment	Manufacturer	Model No.	Serial No.	Last Cal.	Due. Date
Power sensor, Power Meter	R&S	OSP120	100921	Mar.31,2023	Mar.30,2024
Vector Signal Generator	R&S	SMBV100A	261637	Oct.12, 2023	Oct.11, 2024
Signal Generator	R&S	SMB100A	178553	Oct.12, 2023	Oct.11, 2024
Signal Analyzer	R&S	FSV40	101118	Oct.12, 2023	Oct.11, 2024
Software					
Description	Manufacturer	Name		Version	
For R&S TS 8997 Test System	Rohde & Schwarz	EMC 32		10.60.10	
Tonsend RF Test System					
Equipment	Manufacturer	Model No.	Serial No.	Last Cal.	Due. Date
Wideband Radio Communication Tester	R&S	CMW500	155523	Oct.12, 2023	Oct.11, 2024
Wireless Connectivity Tester	R&S	CMW270	1201.0002N75-102	Sep.25, 2023	Sep.24, 2024
PXA Signal Analyzer	Keysight	N9030A	MY55410512	Oct.12, 2023	Oct.11, 2024
MXG Vector Signal Generator	Keysight	N5182B	MY56200284	Oct.12, 2023	Oct.11, 2024
MXG Vector Signal Generator	Keysight	N5172B	MY56200301	Oct.12, 2023	Oct.11, 2024
DC power supply	Keysight	E3642A	MY55159130	Oct.12, 2023	Oct.11, 2024
Temperature & Humidity Chamber	SANMOOD	SG-80-CC-2	2088	Oct.12, 2023	Oct.11, 2024
Attenuator	Aglient	8495B	2814a12853	Oct.12, 2023	Oct.11, 2024
RF Control Unit	Tonscend	JS0806-2	23B80620666	April 18, 2023	April 17, 2024
Software					
Description	Manufacturer	Name		Version	
Tonsend SRD Test System	Tonsend	JS1120-3 RF Test System		V3.2.22	

Conducted Emissions					
Equipment	Manufacturer	Model No.	Serial No.	Last Cal.	Due Date
EMI Test Receiver	R&S	ESR3	101961	Oct.13, 2023	Oct.12, 2024
Two-Line V-Network	R&S	ENV216	101983	Oct.13, 2023	Oct.12, 2024
Artificial Mains Networks	Schwarzbeck	NSLK 8126	8126465	Oct.13, 2023	Oct.12, 2024
Software					
Description			Manufacturer	Name	Version
Test Software for Conducted Emissions			Farad	EZ-EMC	Ver. UL-3A1

Radiated Emissions					
Equipment	Manufacturer	Model No.	Serial No.	Last Cal.	Due Date
MXE EMI Receiver	KESIGHT	N9038A	MY56400036	Oct.12, 2023	Oct.11, 2024
Hybrid Log Periodic Antenna	TDK	HLP-3003C	130959	Aug.02, 2021	Aug.01, 2024
Preamplifier	HP	8447D	2944A09099	Oct.12, 2023	Oct.11, 2024
EMI Measurement Receiver	R&S	ESR26	101377	Oct.12, 2023	Oct.11, 2024
Horn Antenna	TDK	HRN-0118	130940	July 20, 2021	July 19, 2024
Preamplifier	TDK	PA-02-0118	TRS-305-00067	Oct.12, 2023	Oct.11, 2024
Horn Antenna	Schwarzbeck	BBHA9170	697	July 20, 2021	July 19, 2024
Preamplifier	TDK	PA-02-2	TRS-307-00003	Oct.12, 2023	Oct.11, 2024
Preamplifier	TDK	PA-02-3	TRS-308-00002	Oct.12, 2023	Oct.11, 2024
Loop antenna	Schwarzbeck	1519B	00008	Dec.14, 2021	Dec.13, 2024
Preamplifier	TDK	PA-02-001-3000	TRS-302-00050	Oct.12, 2023	Oct.11, 2024
High Pass Filter	Wi	WHKX10-2700-3000-18000-40SS	23	Oct.12, 2023	Oct.11, 2024
Highpass Filter	Wainwright	WHKX10-5850-6500-1800-40SS	4	Oct.12, 2023	Oct.11, 2024
Band Reject Filter	Wainwright	WRCJV12-5695-5725-5850-5880-40SS	4	Oct.12, 2023	Oct.11, 2024
Band Reject Filter	Wainwright	WRCJV20-5120-5150-5350-5380-60SS	2	Oct.12, 2023	Oct.11, 2024

Band Reject Filter	Wainwright	WRCJV20-5440-5470-5725-5755-60SS	1	Oct.12, 2023	Oct.11, 2024
Band Reject Filter	Wainwright	WRCJV8-2350-2400-2483.5-2533.5-40SS	4	Oct.12, 2023	Oct.11, 2024
Band Reject Filter	Wainwright	WRCD5-1879-1879.85-1880.15-1881-40SS	1	Oct.12, 2023	Oct.11, 2024
Notch Filter	Wainwright	WHJ10-882-980-7000-40SS	1	Oct.12, 2023	Oct.11, 2024
Highpass Filter	Xingbo	XBLBQ-GTA68	211115-2-1	Oct.12, 2023	Oct.11, 2024
Notch Filter (5905-6445 MHz)	Xingbo	XBLBQ-DZA175	210922-2-1	Oct.12, 2023	Oct.11, 2024
Notch Filter (6425-6525 MHz)	Xingbo	XBLBQ-DZA176	210922-2-2	Oct.12, 2023	Oct.11, 2024
Notch Filter (6825-7125 MHz)	Xingbo	XBLBQ-DZA177	210922-2-3	Oct.12, 2023	Oct.11, 2024
Notch Filter (6525-6875 MHz)	Xingbo	XBLBQ-DZA178	210922-2-4	Oct.12, 2023	Oct.11, 2024
Software					
Description			Manufacturer	Name	Version
Test Software for Radiated Emissions			Farad	EZ-EMC	Ver. UL-3A1

Other Instrument					
Equipment	Manufacturer	Model No.	Serial No.	Last Cal.	Due Date
Temperature humidity probe	OMEGA	ITHX-SD-5	18470007	Oct.21, 2023	Oct.20, 2024
Barometer	Yiyi	Baro	N/A	Oct.19, 2023	Oct.18, 2024
Attenuator	Agilent	8495B	2814a12853	Oct.12, 2023	Oct.11, 2024

## 7. ANTENNA PORT TEST RESULTS

### 7.1. CONDUCTED OUTPUT POWER

#### LIMITS

CFR 47 FCC Part15 (15.247) Subpart C ISED RSS-247 ISSUE 3			
Section	Test Item	Limit	Frequency Range (MHz)
CFR 47 FCC 15.247(b)(3) ISED RSS-247 5.4 (d)	Peak Conduct Output Power	1 watt or 30 dBm	2400-2483.5

#### TEST PROCEDURE

Connect the EUT to a low loss RF cable from the antenna port to the power sensor (video bandwidth is greater than the occupied bandwidth).  
 Measure peak emission level, the indicated level is the peak output power, after any corrections for external attenuators and cables.

#### TEST SETUP

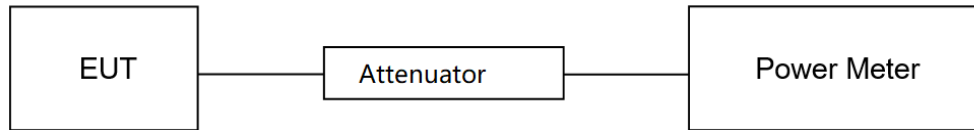

#### TEST ENVIRONMENT

Temperature	25.4°C	Relative Humidity	45.5%
Atmosphere Pressure	101kPa	Test Voltage	DC 7.2 V

#### TEST DATE / ENGINEER

Test Date	December 2, 2023	Test By	Johnson Liu
-----------	------------------	---------	-------------

#### TEST RESULTS

Please refer to section "Test Data" - Appendix C

## 7.2. 6DB BANDWIDTH AND 99% OCCUPIED BANDWIDTH

### LIMITS

CFR 47 FCC Part15 (15.247) Subpart C ISED RSS-247 ISSUE 3			
Section	Test Item	Limit	Frequency Range (MHz)
CFR 47 FCC 15.247(a)(2) ISED RSS-247 5.2 (a)	6 dB Bandwidth	≥ 500 kHz	2400-2483.5
ISED RSS-Gen Clause 6.7	99 % Occupied Bandwidth	For reporting purposes only.	2400-2483.5

### TEST PROCEDURE

Refer to ANSI C63.10-2013 clause 11.8 for DTS bandwidth and clause 6.9 for Occupied Bandwidth.

Connect the EUT to the spectrum analyzer and use the following settings:

Center Frequency	The center frequency of the channel under test
Frequency Span	For 6 dB Bandwidth: Enough to capture all products of the modulation carrier emission For 99 % Occupied Bandwidth: Between 1.5 times and 5.0 times the OBW
Detector	Peak
RBW	For 6 dB Bandwidth: 100 kHz For 99 % Occupied Bandwidth: 1 % to 5 % of the occupied bandwidth
VBW	For 6 dB Bandwidth: ≥3 × RBW For 99 % Occupied Bandwidth: ≥3 × RBW
Trace	Max hold
Sweep	Auto couple

a) Use the 99 % power bandwidth function of the instrument, allow the trace to stabilize and report the measured bandwidth.

b) Allow the trace to stabilize and measure the maximum width of the emission that is constrained by the frequencies associated with the two outermost amplitude points (upper and lower frequencies) that are attenuated by 6 dB relative to the maximum level measured in the fundamental emission.

### TEST SETUP

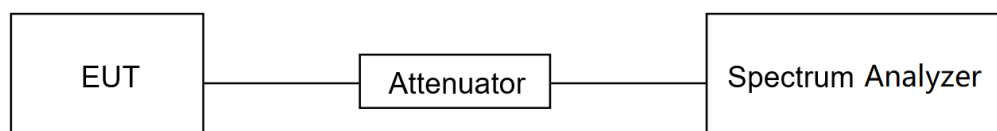



**TEST ENVIRONMENT**

Temperature	25.4°C	Relative Humidity	45.5%
Atmosphere Pressure	101kPa	Test Voltage	DC 7.2 V

**TEST DATE / ENGINEER**

Test Date	December 2, 2023	Test By	Johnson Liu
-----------	------------------	---------	-------------

**TEST RESULTS**

Please refer to section "Test Data" - Appendix A&B

### 7.3. POWER SPECTRAL DENSITY

#### LIMITS

CFR 47 FCC Part15 (15.247) Subpart C ISED RSS-247 ISSUE 3			
Section	Test Item	Limit	Frequency Range (MHz)
CFR 47 FCC §15.247 (e) ISED RSS-247 5.2 (b)	Power Spectral Density	8 dBm in any 3 kHz band	2400-2483.5

#### TEST PROCEDURE

Refer to ANSI C63.10-2013 clause 11.10.5.

Connect the EUT to the spectrum analyzer and use the following settings:

Center Frequency	The center frequency of the channel under test
Detector	power averaging (rms)
RBW	$3 \text{ kHz} \leq \text{RBW} \leq 100 \text{ kHz}$
VBW	$\geq 3 \times \text{RBW}$
Span	1.5 x OBW bandwidth
Trace	Employ trace averaging(rms)mode over a minimum of 100 traces
Sweep time	Auto couple

Allow trace to fully stabilize and use the peak marker function to determine the maximum amplitude level within the RBW.

If measured value exceeds limit, reduce RBW (no less than 3 kHz) and repeat.

#### TEST SETUP

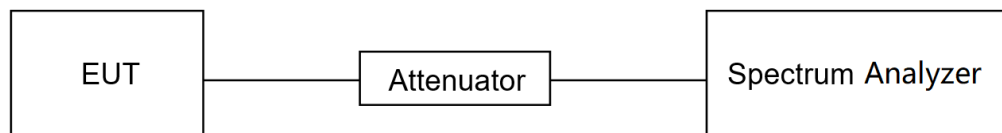

#### TEST ENVIRONMENT

Temperature	25.4°C	Relative Humidity	45.5%
Atmosphere Pressure	101kPa	Test Voltage	DC 7.2 V

#### TEST DATE / ENGINEER

Test Date	December 2, 2023	Test By	Johnson Liu
-----------	------------------	---------	-------------

**TEST RESULTS**

Please refer to section "Test Data" - Appendix D

## 7.4. CONDUCTED BAND EDGE AND SPURIOUS EMISSION

### LIMITS

CFR 47 FCC Part15 (15.247) Subpart C ISED RSS-247 ISSUE 3		
Section	Test Item	Limit
CFR 47 FCC §15.247 (d) ISED RSS-247 5.5	Conducted Bandedge and Spurious Emissions	at least 20 dB below that in the 100 kHz bandwidth within the band that contains the highest level of the desired power

### TEST PROCEDURE

Refer to ANSI C63.10-2013 clause 11.11 and 11.13.

Connect the EUT to the spectrum analyzer and use the following settings for reference level measurement:

Center Frequency	The center frequency of the channel under test
Detector	Peak
RBW	100 kHz
VBW	$\geq 3 \times \text{RBW}$
Span	1.5 x DTS bandwidth
Trace	Max hold
Sweep time	Auto couple.

Allow trace to fully stabilize and use the peak marker function to determine the maximum PSD level.

Change the settings for emission level measurement:

Span	Set the center frequency and span to encompass frequency range to be measured
Detector	Peak
RBW	100 kHz
VBW	$\geq 3 \times \text{RBW}$
measurement points	$\geq \text{span}/\text{RBW}$
Trace	Max hold
Sweep time	Auto couple.

Allow trace to fully stabilize and use the peak marker function to determine the maximum PSD level. Ensure that the amplitude of all unwanted emissions outside of the authorized frequency band (excluding restricted frequency bands) is attenuated by at least the minimum requirements specified in 11.11.

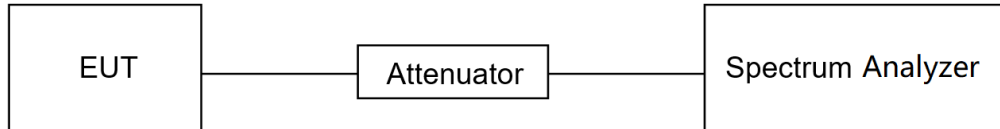
**TEST SETUP****TEST ENVIRONMENT**

Temperature	25.4°C	Relative Humidity	45.5%
Atmosphere Pressure	101kPa	Test Voltage	DC 7.2 V

**TEST DATE / ENGINEER**

Test Date	December 2, 2023	Test By	Johnson Liu
-----------	------------------	---------	-------------

**TEST RESULTS**

Please refer to section "Test Data" - Appendix E&F

## 7.5. DUTY CYCLE

### LIMITS

None; for reporting purposes only.

### TEST PROCEDURE

Refer to ANSI C63.10-2013 clause 11.6 Zero – Span Spectrum Analyzer method.

### TEST SETUP

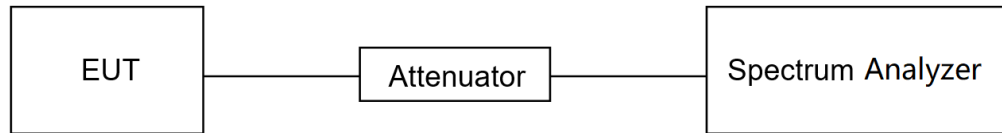

### TEST ENVIRONMENT

Temperature	25.4°C	Relative Humidity	45.5%
Atmosphere Pressure	101kPa	Test Voltage	DC 7.2 V

### TEST DATE / ENGINEER

Test Date	December 2, 2023	Test By	Johnson Liu
-----------	------------------	---------	-------------

### TEST RESULTS

Please refer to section "Test Data" - Appendix G

## 8. RADIATED TEST RESULTS

### LIMITS

Please refer to CFR 47 FCC §15.205 and §15.209.

Please refer to ISED RSS-GEN Clause 8.9 and Clause 8.10.

Radiation Disturbance Test Limit for FCC (Class B) (9 kHz ~ 1 GHz)

Emissions radiated outside of the specified frequency bands above 30 MHz			
Frequency Range (MHz)	Field Strength Limit (uV/m) at 3 m	Field Strength Limit (dBuV/m) at 3 m	
		Quasi-Peak	
30 - 88	100	40	
88 - 216	150	43.5	
216 - 960	200	46	
Above 960	500	54	
Above 1000	500	Peak	Average
		74	54

FCC Emissions radiated outside of the specified frequency bands below 30 MHz		
Frequency (MHz)	Field strength (microvolts/meter)	Measurement distance (meters)
0.009-0.490	2400/F(kHz)	300
0.490-1.705	24000/F(kHz)	30
1.705-30.0	30	30

ISED General field strength limits at frequencies below 30 MHz

Table 6 – General field strength limits at frequencies below 30 MHz		
Frequency	Magnetic field strength (H-Field) (µA/m)	Measurement distance (m)
9 - 490 kHz <sup>Note 1</sup>	6.37/F (F in kHz)	300
490 - 1705 kHz	63.7/F (F in kHz)	30
1.705 - 30 MHz	0.08	30

**Note 1:** The emission limits for the ranges 9-90 kHz and 110-490 kHz are based on measurements employing a linear average detector.

**ISED Restricted bands please refer to ISED RSS-GEN Clause 8.10**

Table 7 – Restricted frequency bands <sup>Note 1</sup>		
MHz	MHz	GHz
0.090 - 0.110	149.9 - 150.05	9.0 - 9.2
0.495 - 0.505	156.52475 - 156.52525	9.3 - 9.5
2.1735 - 2.1905	156.7 - 156.9	10.6 - 12.7
3.020 - 3.026	162.0125 - 167.17	13.25 - 13.4
4.125 - 4.128	167.72 - 173.2	14.47 - 14.5
4.17725 - 4.17775	240 - 285	15.35 - 16.2
4.20725 - 4.20775	322 - 335.4	17.7 - 21.4
5.677 - 5.683	399.9 - 410	22.01 - 23.12
6.215 - 6.218	608 - 614	23.6 - 24.0
6.26775 - 6.26825	960 - 1427	31.2 - 31.8
6.31175 - 6.31225	1435 - 1626.5	36.43 - 36.5
8.291 - 8.294	1645.5 - 1646.5	Above 38.6
8.362 - 8.366	1660 - 1710	
8.37625 - 8.38675	1718.8 - 1722.2	
8.41425 - 8.41475	2200 - 2300	
12.29 - 12.293	2310 - 2390	
12.51975 - 12.52025	2483.5 - 2500	
12.57675 - 12.57725	2655 - 2900	
13.36 - 13.41	3260 - 3267	
16.42 - 16.423	3332 - 3339	
16.69475 - 16.69525	3345.8 - 3358	
16.80425 - 16.80475	3500 - 4400	
25.5 - 25.67	4500 - 5150	
37.5 - 38.25	5350 - 5460	
73 - 74.6	7250 - 7750	
74.8 - 75.2	8025 - 8500	
108 - 138		

**Note 1:** Certain frequency bands listed in table 7 and in bands above 38.6 GHz are designated for licence-exempt applications. These frequency bands and the requirements that apply to related devices are set out in the 200 and 300 series of RSSs.

**FCC Restricted bands of operation refer to FCC §15.205 (a):**

MHz	MHz	MHz	GHz
0.090-0.110	16.42-16.423	399.9-410	4.5-5.15
<sup>1</sup> 0.495-0.505	16.69475-16.69525	608-614	5.35-5.46
2.1735-2.1905	16.80425-16.80475	960-1240	7.25-7.75
4.125-4.128	25.5-25.67	1300-1427	8.025-8.5
4.17725-4.17775	37.5-38.25	1435-1626.5	9.0-9.2
4.20725-4.20775	73-74.6	1645.5-1646.5	9.3-9.5
6.215-6.218	74.8-75.2	1660-1710	10.6-12.7
6.26775-6.26825	108-121.94	1718.8-1722.2	13.25-13.4
6.31175-6.31225	123-138	2200-2300	14.47-14.5
8.291-8.294	149.9-150.05	2310-2390	15.35-16.2
8.362-8.366	156.52475-156.52525	2483.5-2500	17.7-21.4
8.37625-8.38675	156.7-156.9	2690-2900	22.01-23.12
8.41425-8.41475	162.0125-167.17	3260-3267	23.6-24.0
12.29-12.293	167.72-173.2	3332-3339	31.2-31.8
12.51975-12.52025	240-285	3345.8-3358	36.43-36.5
12.57675-12.57725	322-335.4	3600-4400	( <sup>2</sup> )
13.36-13.41			

Note: <sup>1</sup>Until February 1, 1999, this restricted band shall be 0.490-0.510 MHz.

<sup>2</sup>Above 38.6c

**TEST PROCEDURE**

Below 30 MHz



## The setting of the spectrum analyzer

RBW	200 Hz (From 9 kHz to 0.15 MHz)/ 9 kHz (From 0.15 MHz to 30 MHz)
VBW	200 Hz (From 9 kHz to 0.15 MHz)/ 9 kHz (From 0.15 MHz to 30 MHz)
Sweep	Auto

1. The testing follows the guidelines in ANSI C63.10-2013 clause 6.4.
2. The EUT was arranged to its worst case and then turntable (from 0 degree to 360 degrees) to find the maximum reading. A pre-amp and a high pass filter are used for the test in order to get better signal level. Both Horizontal, Face-on and Face-off polarizations of the antenna are set to make the measurement.
3. The EUT was placed on a turntable with 80 cm above ground.
4. The EUT was set 3 meters from the interference receiving antenna, which was mounted on the top of a 1 m height antenna tower.
5. The radiated emission limits are based on measurements employing a CISPR quasi-peak detector except for the frequency bands 9-90 kHz, 110-490 kHz and above 1000 MHz Radiated emission limits in these three bands are based on measurements employing an average detector.
6. For measurement below 1 GHz, the initial step in collecting conducted emission data is a spectrum analyzer peak detector mode pre-scanning the measurement frequency range. Significant peaks are then marked and then Quasi Peak and average detector mode re-measured. If the emission level of the EUT measured by the peak detector is 3 dB lower than the applicable limit, the peak emission level will be reported. Otherwise, the emission measurement will be repeated using the quasi-peak and average detector and reported.
7. Although these tests were performed other than open field site, adequate comparison measurements were confirmed against 30m open field site. Therefore sufficient tests were made to demonstrate that the alternative site produces results that correlate with the ones of tests made in an open field site based on KDB 414788.
8. The limits in CFR 47, Part 15, Subpart C, paragraph 15.209 (a), are identical to those in RSS-GEN Section 8.9, Table 6, since the measurements are performed in terms of magnetic field strength and converted to electric field strength levels (as reported in the table) using the free space impedance of  $377\Omega$ . For example, the measurement frequency X kHz resulted in a level of Y dBuV/m, which is equivalent to  $Y-51.5 = Z$  dBuA/m, which has the same margin, W dB, to the corresponding RSS-GEN Table 6 limit as it has to be 15.209(a) limit.

Below 1 GHz and above 30 MHz

The setting of the spectrum analyzer

RBW	120 kHz
VBW	300 kHz
Sweep	Auto
Detector	Peak/QP
Trace	Max hold

1. The testing follows the guidelines in ANSI C63.10-2013 clause 6.5.
2. The EUT was arranged to its worst case and then tune the antenna tower (from 1 m to 4 m) and turntable (from 0 degree to 360 degrees) to find the maximum reading. A pre-amp and a high pass filter are used for the test in order to get better signal level. Both horizontal and vertical polarizations of the antenna are set to make the measurement.
3. The EUT was placed on a turntable with 80 cm above ground.
4. The EUT was set 3 meters from the interference receiving antenna, which was mounted on the top of a variable height antenna tower.
5. For measurement below 1 GHz, the initial step in collecting conducted emission data is a spectrum analyzer peak detector mode pre-scanning the measurement frequency range. Significant peaks are then marked and then Quasi Peak detector mode re-measured. If the emission level of the EUT measured by the peak detector is 3 dB lower than the applicable limit, the peak emission level will be reported. Otherwise, the emission measurement will be repeated using the quasi-peak detector and reported.

Above 1 GHz

The setting of the spectrum analyzer

RBW	1 MHz
VBW	PEAK: 3 MHz AVG: see note 6
Sweep	Auto
Detector	Peak
Trace	Max hold

1. The testing follows the guidelines in ANSI C63.10-2013 clause 6.6.
2. The EUT was arranged to its worst case and then tune the antenna tower (from 1 m to 4 m) and turntable (from 0 degree to 360 degrees) to find the maximum reading. A pre-amp and a high pass filter are used for the test in order to get better signal level. Both horizontal and vertical polarizations of the antenna are set to make the measurement.
3. The EUT was placed on a turntable with 1.5 m above ground.
4. The EUT was set 3 meters from the interference receiving antenna, which was mounted on the top of a variable height antenna tower.
5. For measurement above 1 GHz, the emission measurement will be measured by the peak detector. This peak level, once corrected, must comply with the limit specified in Section 15.209.
6. For measurements above 1 GHz the resolution bandwidth is set to 1 MHz, then the video bandwidth is set to 3 MHz for peak measurements and 1 MHz resolution bandwidth with 1/T video bandwidth with peak detector for average measurements. For the Duty Cycle please refer to clause 7.5. ON TIME AND DUTY CYCLE.

X axis, Y axis, Z axis positions:

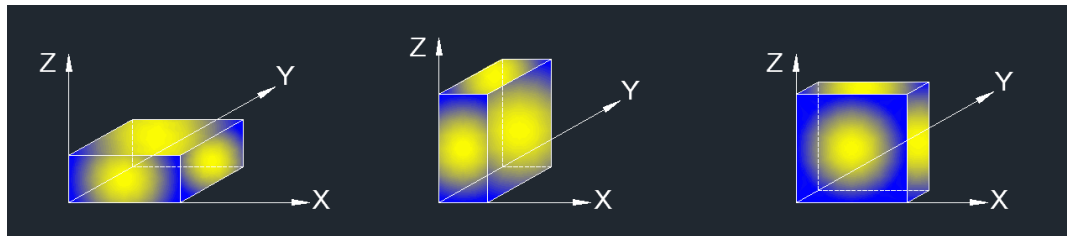

Note 1: For all radiated test, EUT in each of three orthogonal axis emissions had been tested, but only the worst case (X axis) data recorded in the report.

Note 2: The EUT was fully exercised with external accessories during the test. In the case of multiple accessory external ports, an external accessory shall be connected to one of each type of port.

For Restricted Bandedge:

Note:

1. Measurement = Reading Level + Correct Factor.
2. If the peak values are less than the average limit of 54 dBuV/m, the average result is deemed to comply with average limit.
3. PK=Peak: Peak detector.
4. AV=Average: VBW=1/Ton, where: Ton is the transmitting duration.
5. For the transmitting duration, please refer to clause 7.5.
6. Only the worst data was recorded, if it complies with the limit, the other emissions deemed to comply with the limit.
7. Both horizontal and vertical have been tested, only the worst data was recorded in the report.
8. All modes have been tested, but only the worst data was recorded in the report.

For Radiate Spurious emission (9 kHz ~ 30 MHz):

Note:

1. Measurement = Reading Level + Correct Factor.
2. If the peak values are less than the QP limit, the QP result is deemed to comply with QP limit.
3. All 3 polarizations (Horizontal, Face-on and Face-off) of the loop antenna had been tested, but only the worst data recorded in the report.
4. All modes have been tested, but only the worst data was recorded in the report.
5. dBuA/m= dBuV/m- 20Log10[120π] = dBuV/m- 51.5

For Radiate Spurious Emission (30 MHz ~ 1 GHz):

Note:

1. Result Level = Read Level + Correct Factor.
2. If the peak values are less than the QP limit, the QP result is deemed to comply with QP limit.
3. All modes have been tested, but only the worst data was recorded in the report.

For Radiate Spurious Emission (1 GHz ~ 3 GHz):

Note:

1. Measurement = Reading Level + Correct Factor.
2. If the peak values are less than the average limit of 54 dBuV/m, the average result is deemed to comply with average limit.
3. Peak: Peak detector.
4. AVG: VBW=1/Ton, where: Ton is the transmitting duration.
5. For the transmitting duration, please refer to clause 7.5.
6. Filter losses were only considered in the spurious frequency bands and the authorized band was not corrected for Band reject filter losses.
7. Proper operation of the transmitter prior to adding the filter to the measurement chain.
8. All modes have been tested, but only the worst data was recorded in the report.

For Radiate Spurious Emission (3 GHz ~ 18 GHz):

Note:

1. Peak Result = Reading Level + Correct Factor.
2. If the peak values are less than the average limit of 54 dBuV/m, the average result is deemed to comply with average limit.
3. Peak: Peak detector.
4. AVG:  $VBW=1/T_{on}$ , where:  $T_{on}$  is the transmitting duration.
5. For the transmitting duration, please refer to clause 7.5.
6. Filter losses were only considered in the spurious frequency bands and the authorized band was not corrected for High Pass Filter losses.
7. Proper operation of the transmitter prior to adding the filter to the measurement chain.
8. All modes have been tested, but only the worst data was recorded in the report.

For Radiate Spurious emission (18 GHz ~ 26 GHz):

Note:

1. Measurement = Reading Level + Correct Factor.
2. If the peak values are less than the average limit of 54 dBuV/m, the average result is deemed to comply with average limit.
3. Peak: Peak detector.
4. All modes have been tested, but only the worst data was recorded in the report.

### TEST SETUP

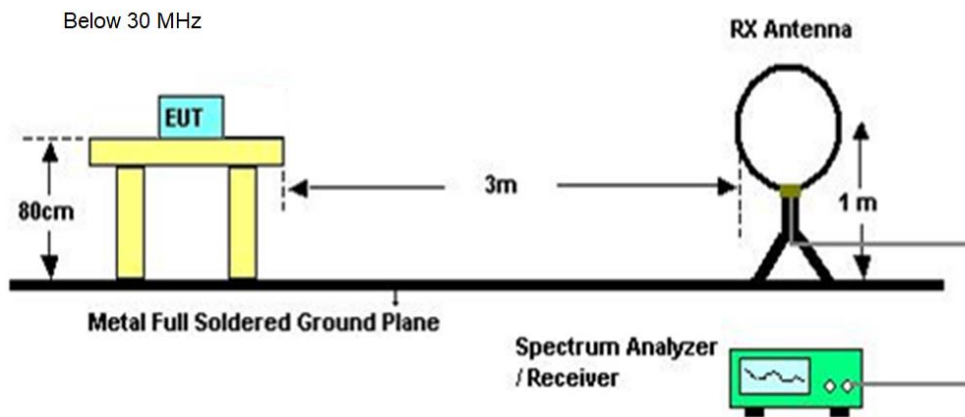

Below 1 GHz and above 30 MHz

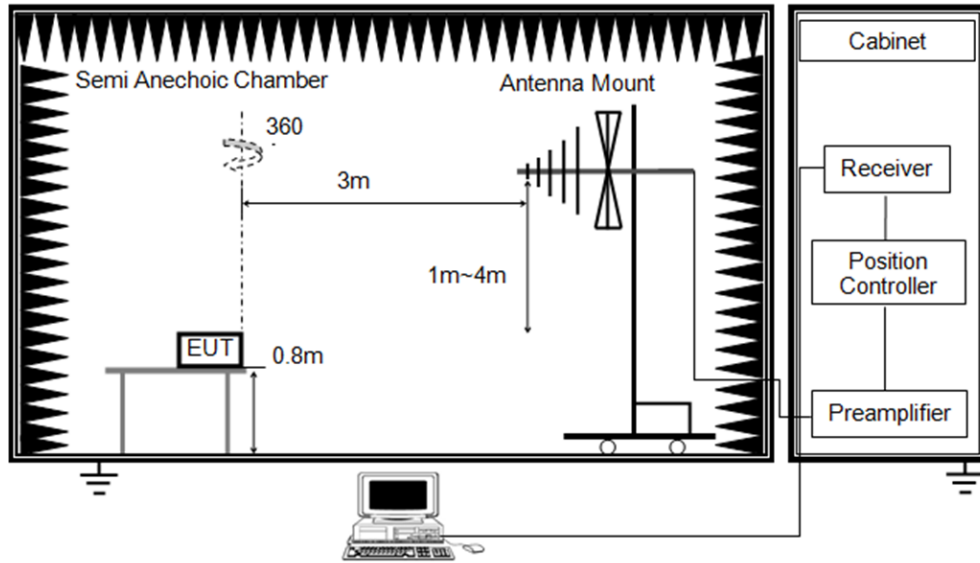

Above 1 GHz

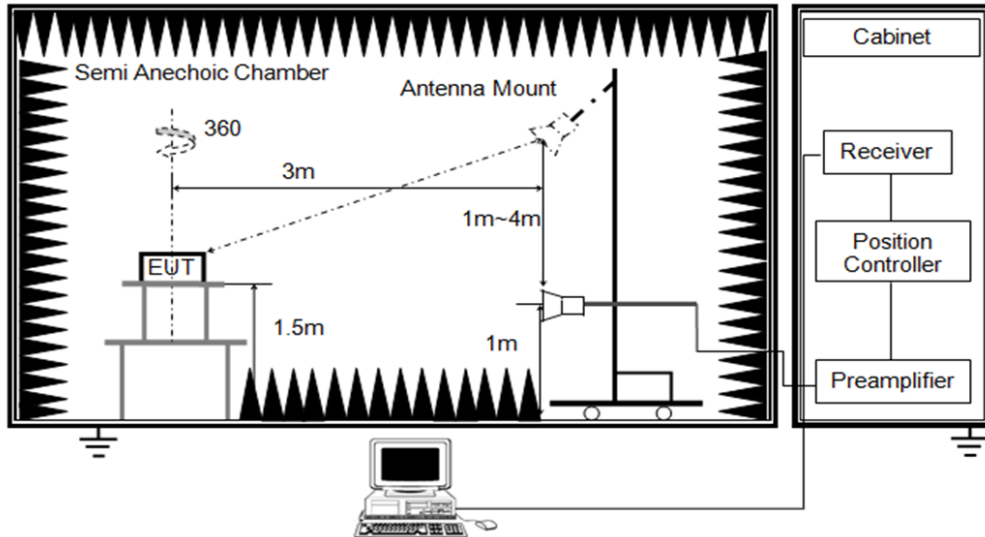

**TEST ENVIRONMENT**

Temperature	24.8°C	Relative Humidity	57%
Atmosphere Pressure	101kPa	Test Voltage	

**TEST DATE / ENGINEER**

Test Date	January 10, 2024	Test By	Rex Huang
-----------	------------------	---------	-----------

**TEST RESULTS**

### 8.1. RESTRICTED BANDEDGE

Test Mode:	BLE 1M PK	Frequency(MHz):	2402
Polarity:	Horizontal	Test Voltage:	DC 7.2 V

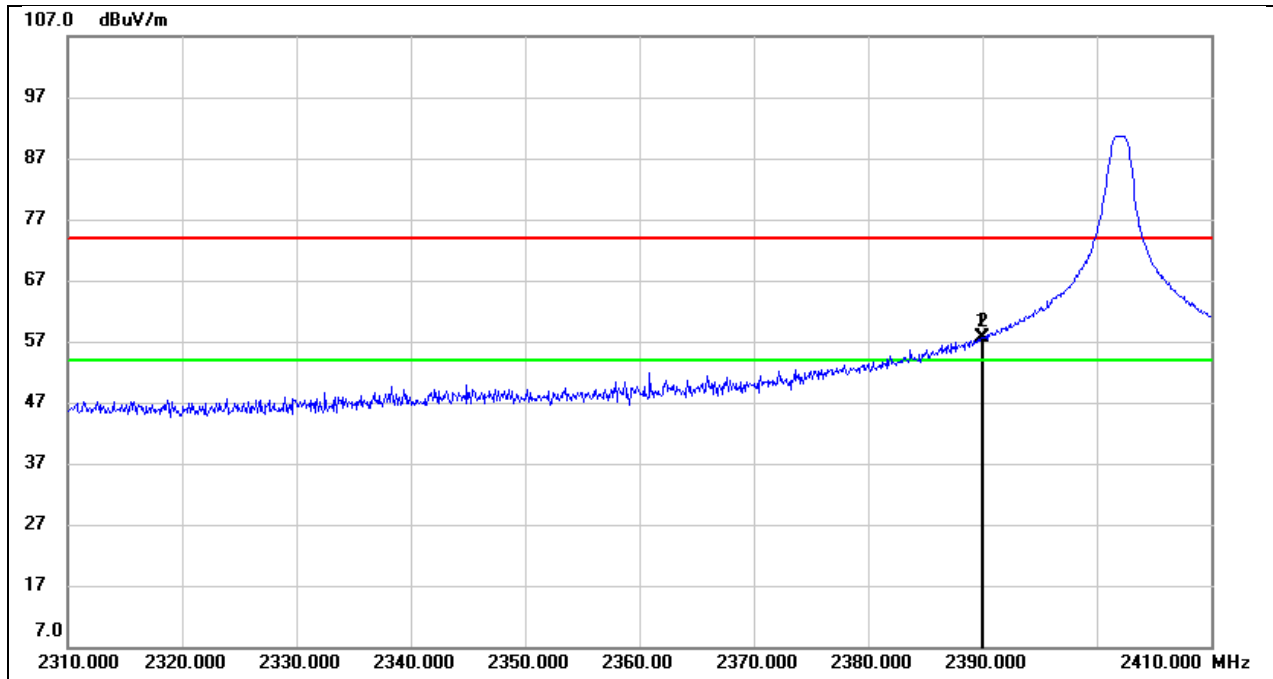

No.	Frequency (MHz)	Reading (dBuV)	Correct (dB/m)	Result (dBuV/m)	Limit (dBuV/m)	Margin (dB)	Remark
1	2389.900	25.56	32.16	57.72	74.00	-16.28	peak
2	2390.000	25.55	32.16	57.71	74.00	-16.29	peak

Test Mode:	BLE 1M AV	Frequency(MHz):	2402
Polarity:	Horizontal	Test Voltage:	DC 7.2 V

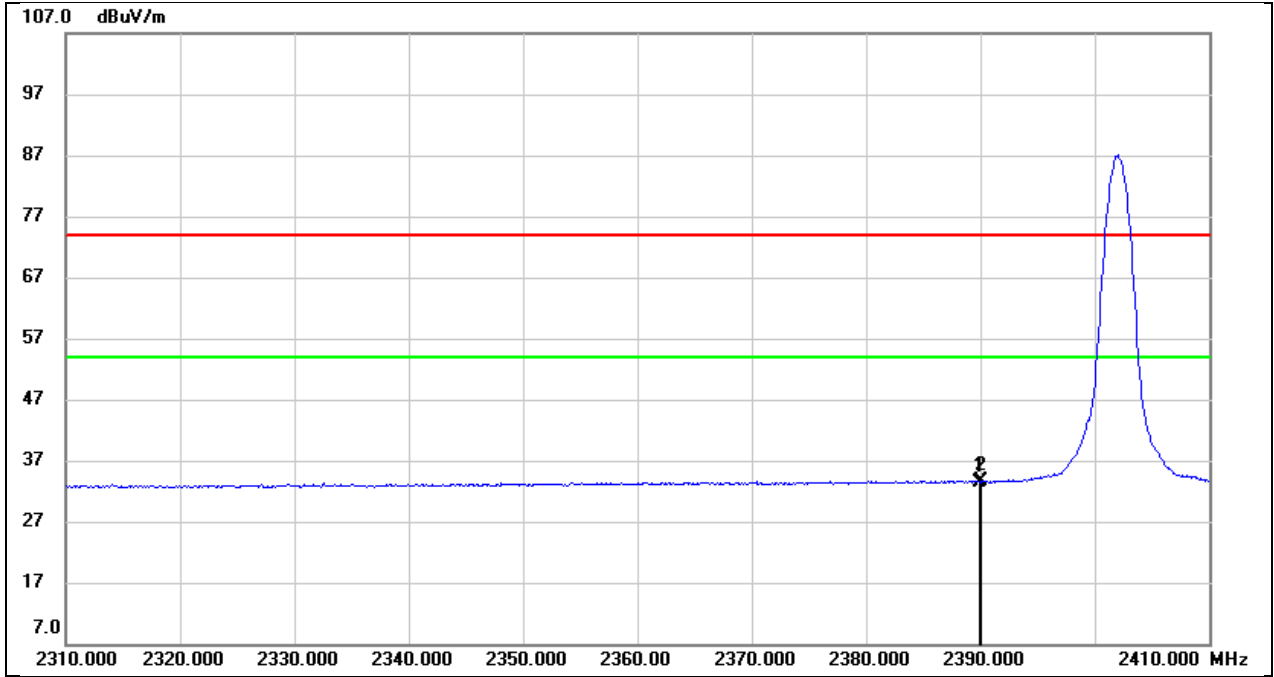

No.	Frequency (MHz)	Reading (dBuV)	Correct (dB/m)	Result (dBuV/m)	Limit (dBuV/m)	Margin (dB)	Remark
1	2389.900	1.32	32.16	33.48	54.00	-20.52	AVG
2	2390.000	1.40	32.16	33.56	54.00	-20.44	AVG



Test Mode:	BLE 1M PK	Frequency(MHz):	2402
Polarity:	Vertical	Test Voltage:	DC 7.2 V

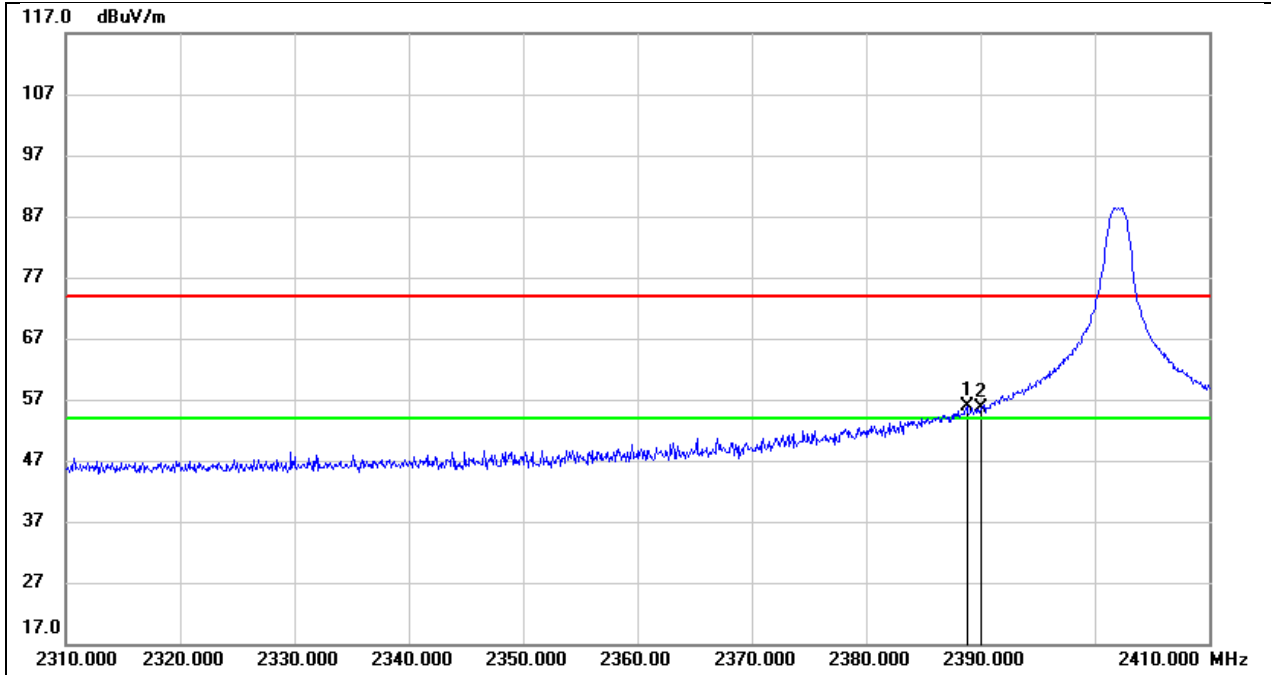

No.	Frequency (MHz)	Reading (dBuV)	Correct (dB/m)	Result (dBuV/m)	Limit (dBuV/m)	Margin (dB)	Remark
1	2388.800	23.64	32.16	55.80	74.00	-18.20	peak
2	2390.000	23.36	32.16	55.52	74.00	-18.48	peak

Test Mode:	BLE 1M AV	Frequency(MHz):	2402
Polarity:	Vertical	Test Voltage:	DC 7.2 V

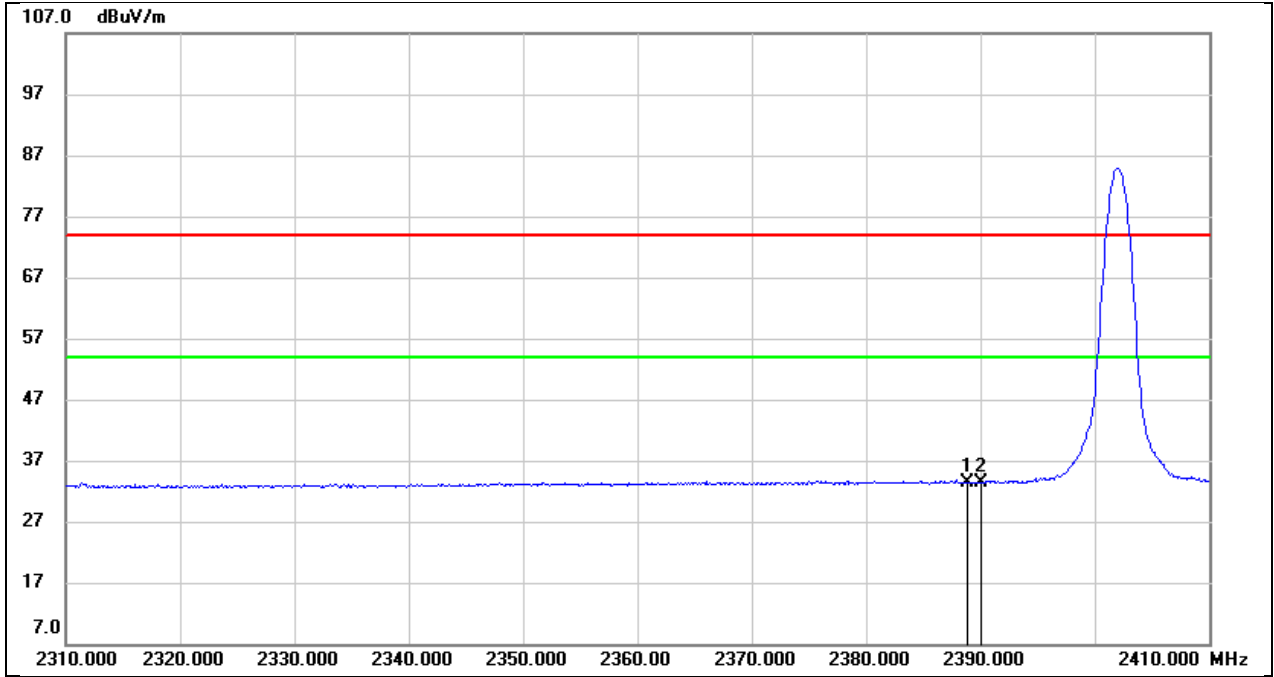

No.	Frequency (MHz)	Reading (dBuV)	Correct (dB/m)	Result (dBuV/m)	Limit (dBuV/m)	Margin (dB)	Remark
1	2388.800	1.20	32.16	33.36	54.00	-20.64	AVG
2	2390.000	1.24	32.16	33.40	54.00	-20.60	AVG

Test Mode:	BLE 1M PK	Frequency(MHz):	2480
Polarity:	Horizontal	Test Voltage:	DC 7.2 V

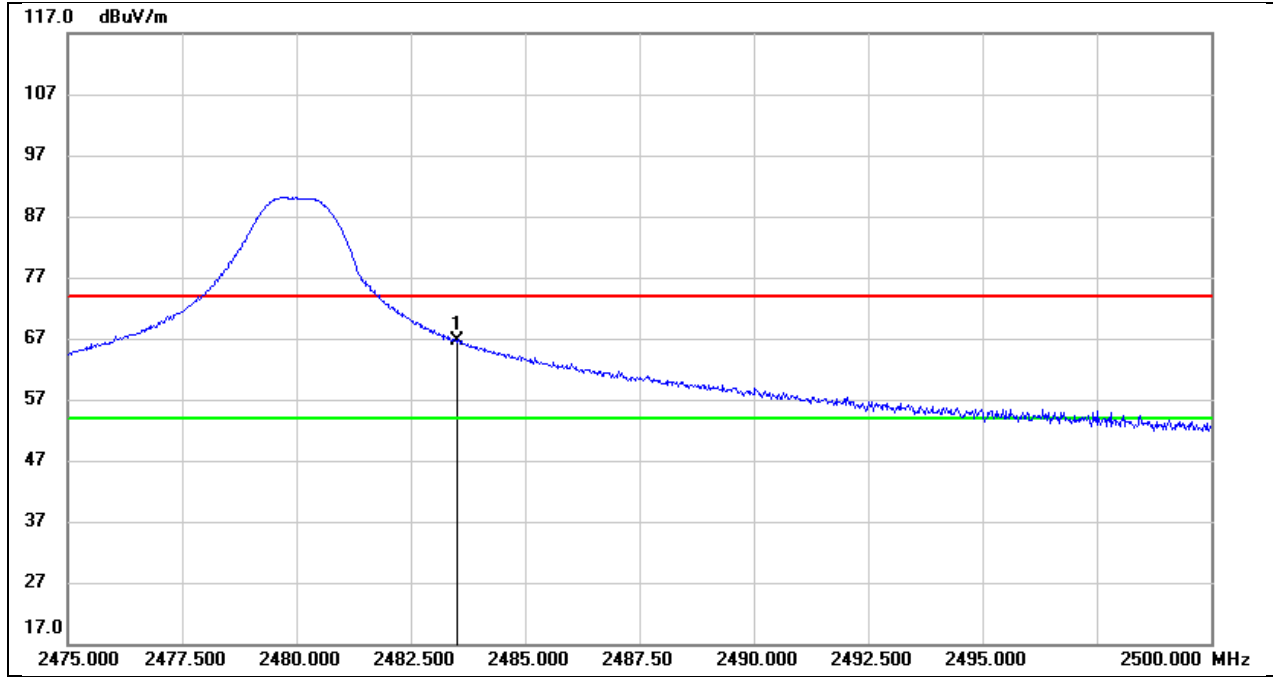

No.	Frequency (MHz)	Reading (dBuV)	Correct (dB/m)	Result (dBuV/m)	Limit (dBuV/m)	Margin (dB)	Remark
1	2483.500	34.29	32.44	66.73	74.00	-7.27	peak

Test Mode:	BLE 1M AV	Frequency(MHz):	2480
Polarity:	Horizontal	Test Voltage:	DC 7.2 V

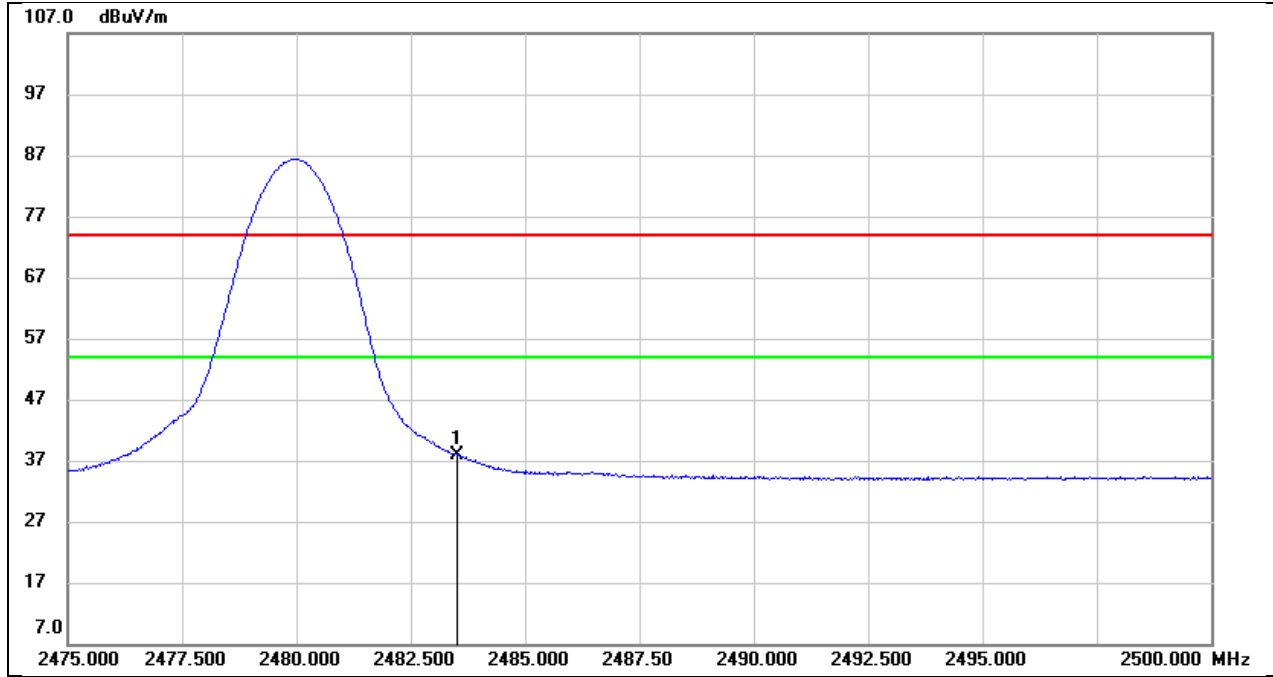

No.	Frequency (MHz)	Reading (dBuV)	Correct (dB/m)	Result (dBuV/m)	Limit (dBuV/m)	Margin (dB)	Remark
1	2483.500	5.52	32.44	37.96	54.00	-16.04	AVG

Test Mode:	BLE 2M PK	Frequency(MHz):	2402
Polarity:	Horizontal	Test Voltage:	DC 7.2 V

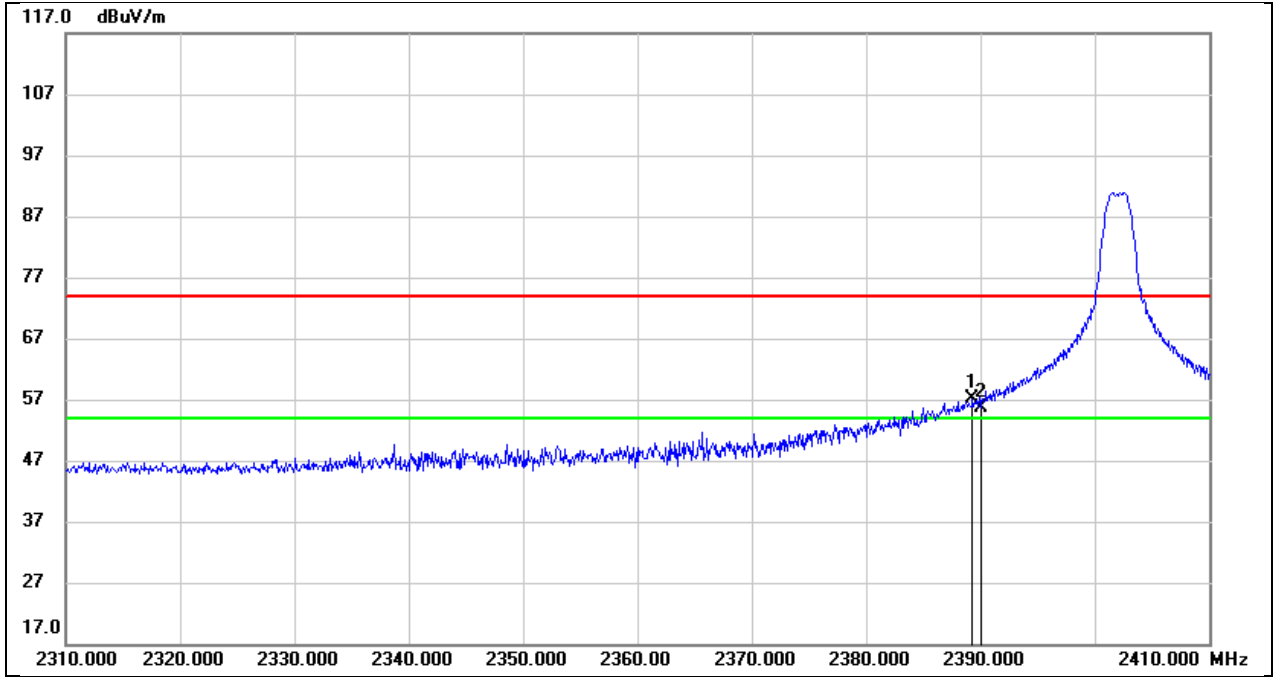

No.	Frequency (MHz)	Reading (dBuV)	Correct (dB/m)	Result (dBuV/m)	Limit (dBuV/m)	Margin (dB)	Remark
1	2389.300	24.90	32.16	57.06	74.00	-16.94	peak
2	2390.000	23.49	32.16	55.65	74.00	-18.35	peak

Test Mode:	BLE 2M AV	Frequency(MHz):	2402
Polarity:	Horizontal	Test Voltage:	DC 7.2 V

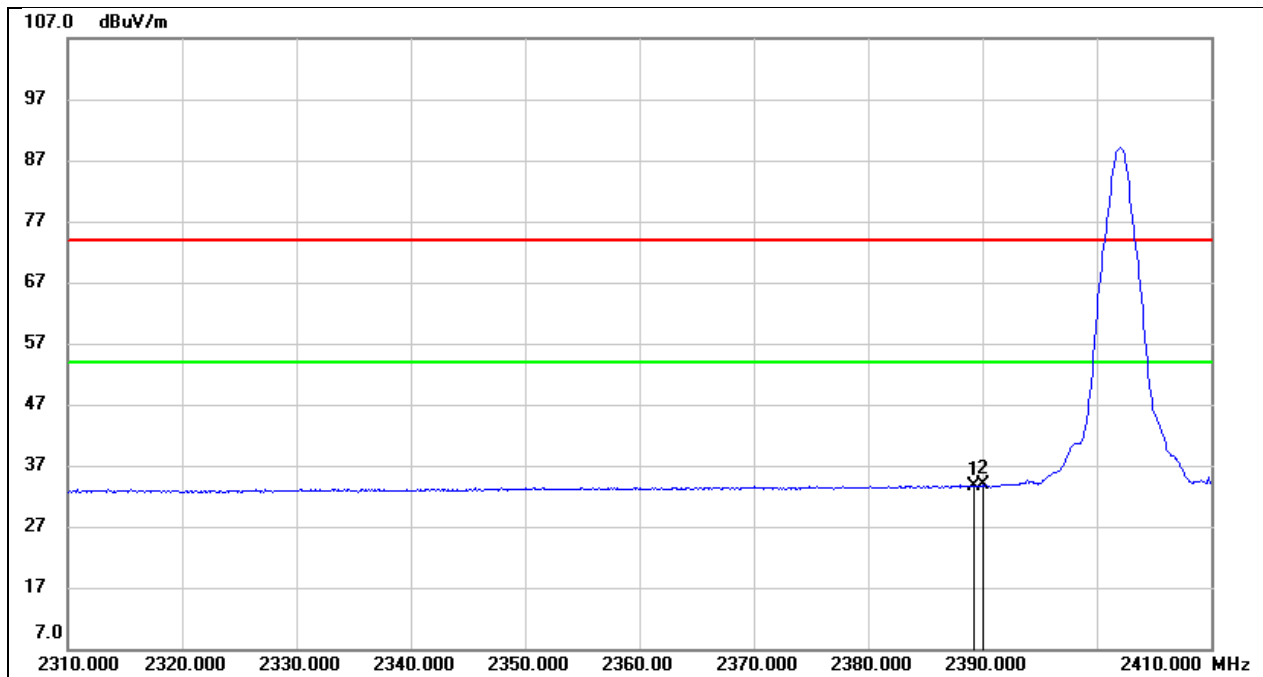

No.	Frequency (MHz)	Reading (dBuV)	Correct (dB/m)	Result (dBuV/m)	Limit (dBuV/m)	Margin (dB)	Remark
1	2389.300	1.37	32.16	33.53	54.00	-20.47	AVG
2	2390.000	1.61	32.16	33.77	54.00	-20.23	AVG

Test Mode:	BLE 2M PK	Frequency(MHz):	2480
Polarity:	Horizontal	Test Voltage:	DC 7.2 V

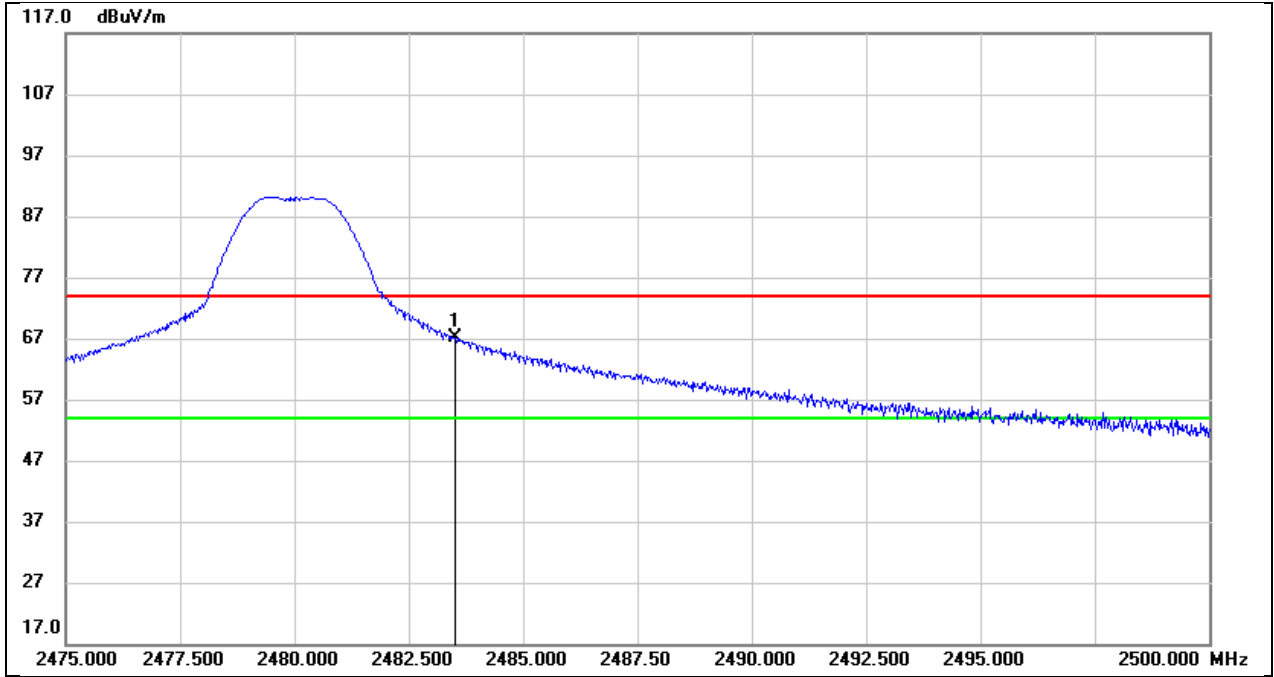

No.	Frequency (MHz)	Reading (dBuV)	Correct (dB/m)	Result (dBuV/m)	Limit (dBuV/m)	Margin (dB)	Remark
1	2483.500	34.59	32.44	67.03	74.00	-6.97	peak

Test Mode:	BLE 2M AV	Frequency(MHz):	2480
Polarity:	Horizontal	Test Voltage:	DC 7.2 V

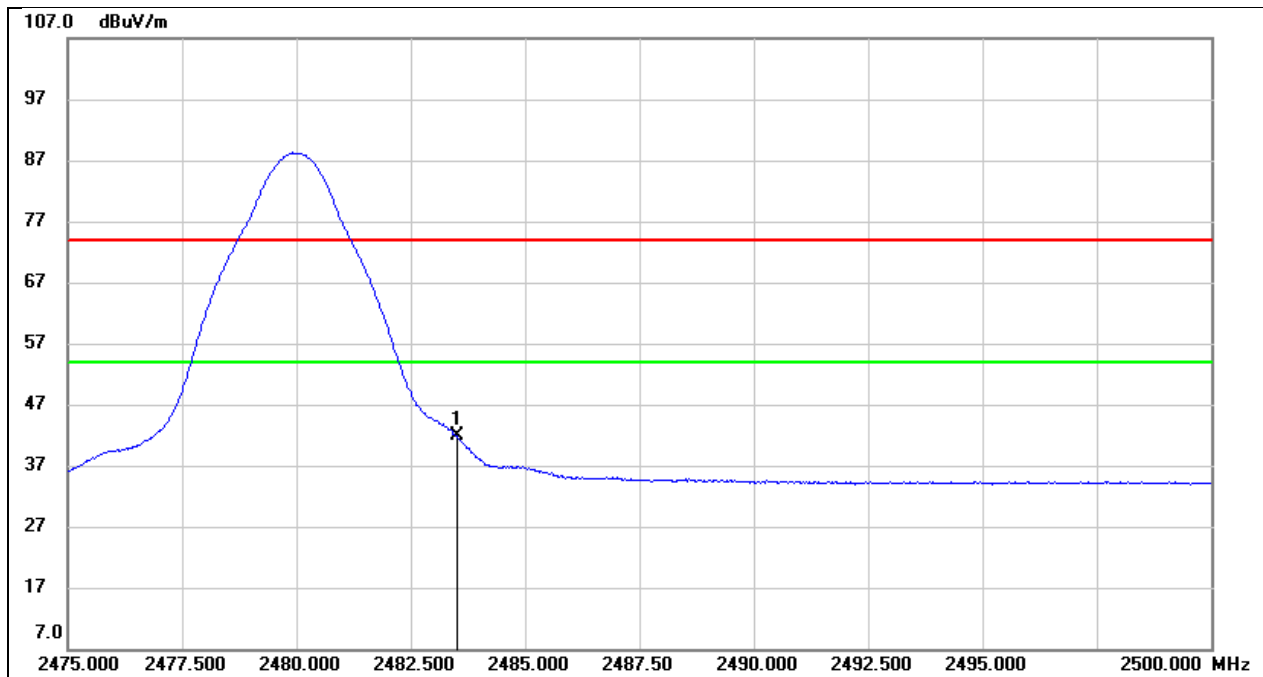

No.	Frequency (MHz)	Reading (dBuV)	Correct (dB/m)	Result (dBuV/m)	Limit (dBuV/m)	Margin (dB)	Remark
1	2483.500	9.36	32.44	41.80	54.00	-12.20	AVG



### 8.2. SPURIOUS EMISSIONS(1 GHZ~3 GHZ)

Test Mode:	BLE 1M	Frequency(MHz):	2402
Polarity:	Horizontal	Test Voltage:	DC 7.2 V

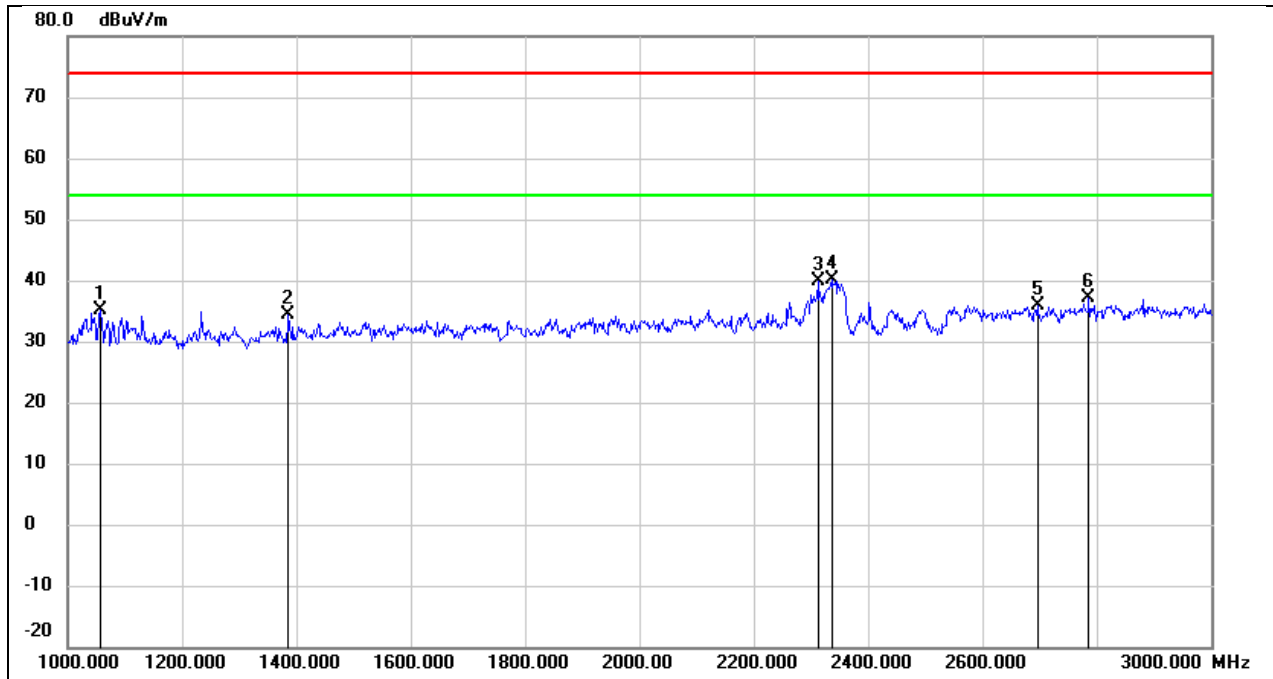

No.	Frequency (MHz)	Reading (dBuV)	Correct (dB/m)	Result (dBuV/m)	Limit (dBuV/m)	Margin (dB)	Remark
1	1056.000	50.00	-14.77	35.23	74.00	-38.77	peak
2	1386.000	47.64	-13.24	34.40	74.00	-39.60	peak
3	2312.000	49.45	-9.46	39.99	74.00	-34.01	peak
4	2336.000	49.36	-9.33	40.03	74.00	-33.97	peak
5	2696.000	43.76	-7.90	35.86	74.00	-38.14	peak
6	2786.000	44.64	-7.63	37.01	74.00	-36.99	peak

Test Mode:	BLE 1M	Frequency(MHz):	2402
Polarity:	Vertical	Test Voltage:	DC 7.2 V

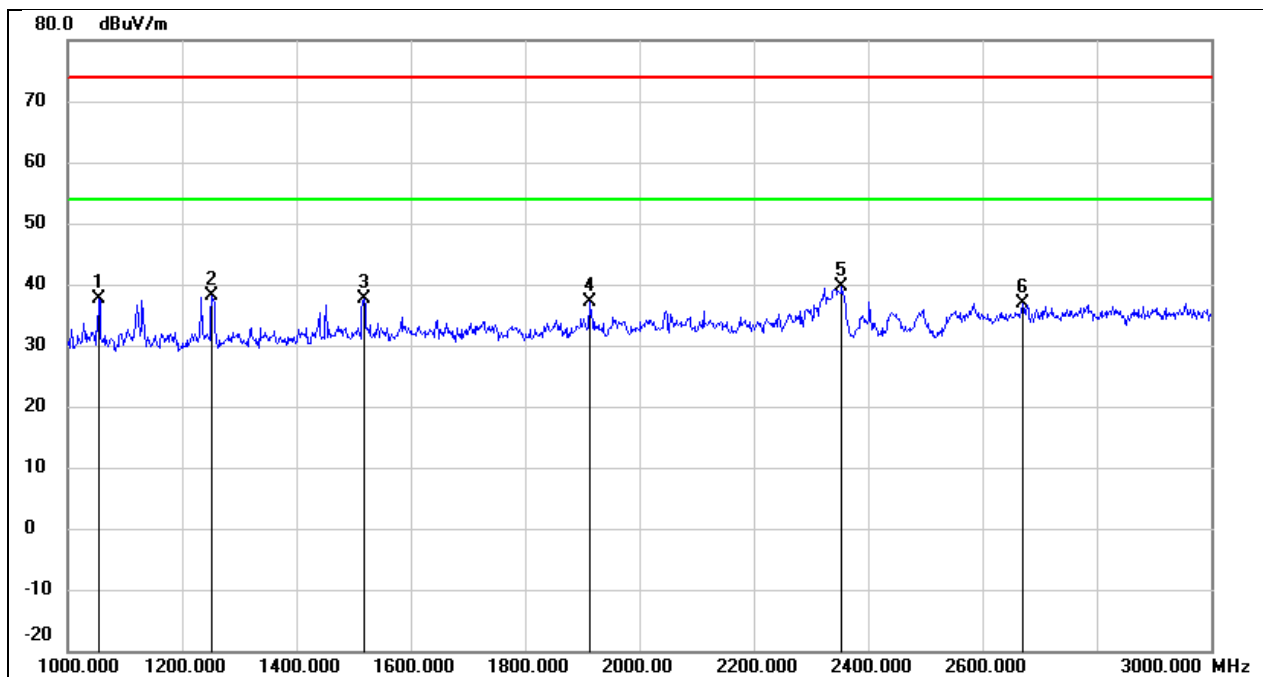

No.	Frequency (MHz)	Reading (dBuV)	Correct (dB/m)	Result (dBuV/m)	Limit (dBuV/m)	Margin (dB)	Remark
1	1054.000	52.29	-14.78	37.51	74.00	-36.49	peak
2	1252.000	51.87	-13.86	38.01	74.00	-35.99	peak
3	1518.000	50.26	-12.65	37.61	74.00	-36.39	peak
4	1912.000	48.37	-11.35	37.02	74.00	-36.98	peak
5	2354.000	48.94	-9.24	39.70	74.00	-34.30	peak
6	2670.000	44.92	-7.97	36.95	74.00	-37.05	peak

Test Mode:	BLE 1M	Frequency(MHz):	2440
Polarity:	Horizontal	Test Voltage:	DC 7.2 V

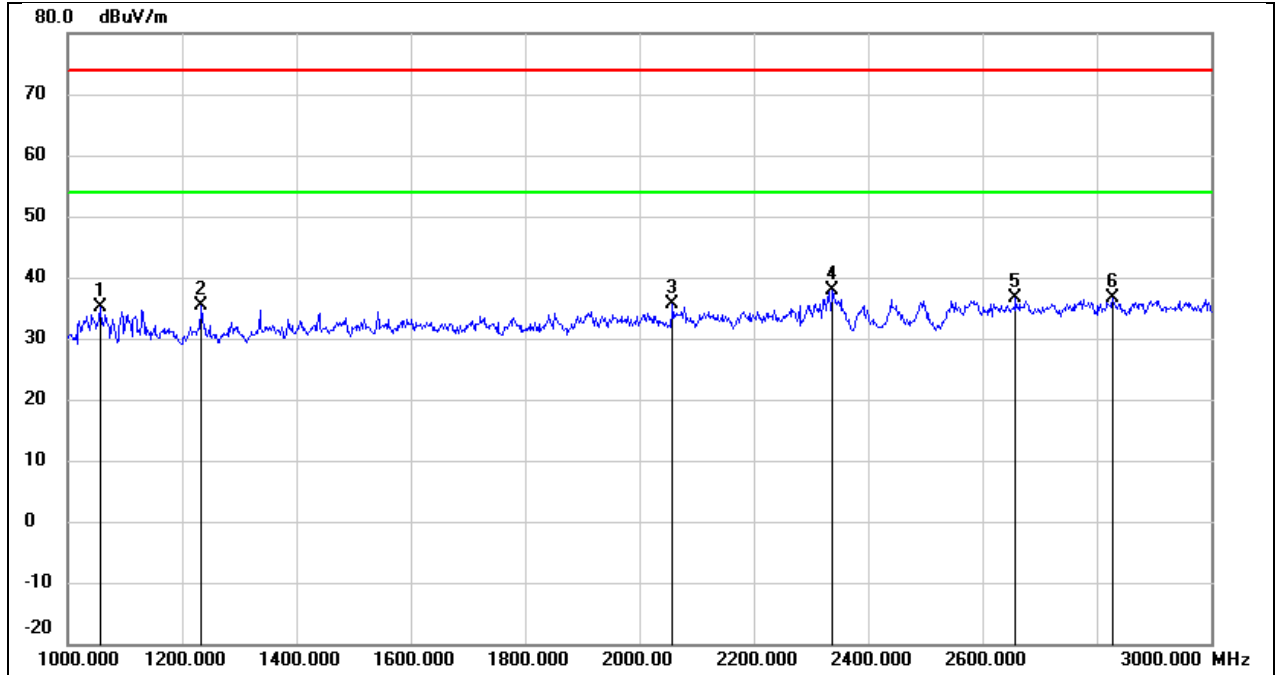

No.	Frequency (MHz)	Reading (dBuV)	Correct (dB/m)	Result (dBuV/m)	Limit (dBuV/m)	Margin (dB)	Remark
1	1056.000	49.78	-14.77	35.01	74.00	-38.99	peak
2	1234.000	49.40	-13.94	35.46	74.00	-38.54	peak
3	2058.000	46.29	-10.76	35.53	74.00	-38.47	peak
4	2338.000	47.27	-9.32	37.95	74.00	-36.05	peak
5	2658.000	44.55	-8.02	36.53	74.00	-37.47	peak
6	2828.000	44.08	-7.50	36.58	74.00	-37.42	peak

Test Mode:	BLE 1M	Frequency(MHz):	2440
Polarity:	Vertical	Test Voltage:	DC 7.2 V

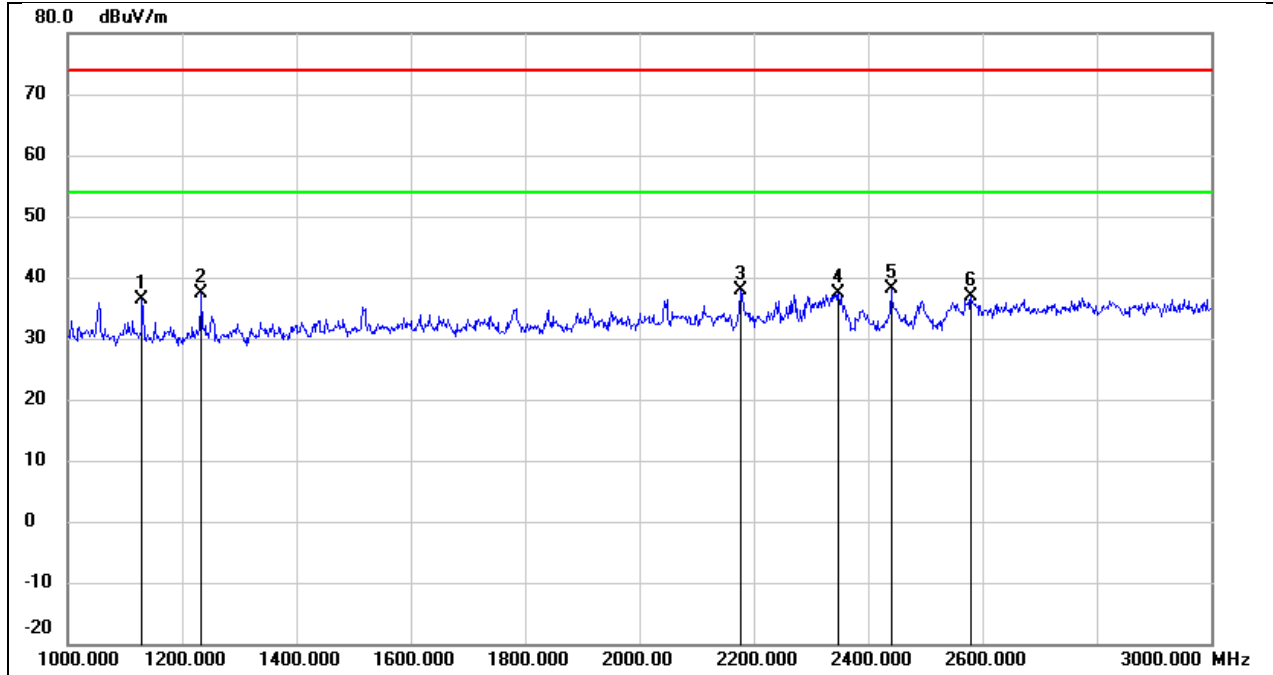

No.	Frequency (MHz)	Reading (dBuV)	Correct (dB/m)	Result (dBuV/m)	Limit (dBuV/m)	Margin (dB)	Remark
1	1130.000	50.69	-14.43	36.26	74.00	-37.74	peak
2	1234.000	51.37	-13.94	37.43	74.00	-36.57	peak
3	2176.000	48.14	-10.16	37.98	74.00	-36.02	peak
4	2348.000	46.62	-9.28	37.34	74.00	-36.66	peak
5	2440.000	47.00	-8.80	38.20	/	/	fundamental
6	2580.000	45.14	-8.25	36.89	74.00	-37.11	peak

Test Mode:	BLE 1M	Frequency(MHz):	2480
Polarity:	Horizontal	Test Voltage:	DC 7.2 V

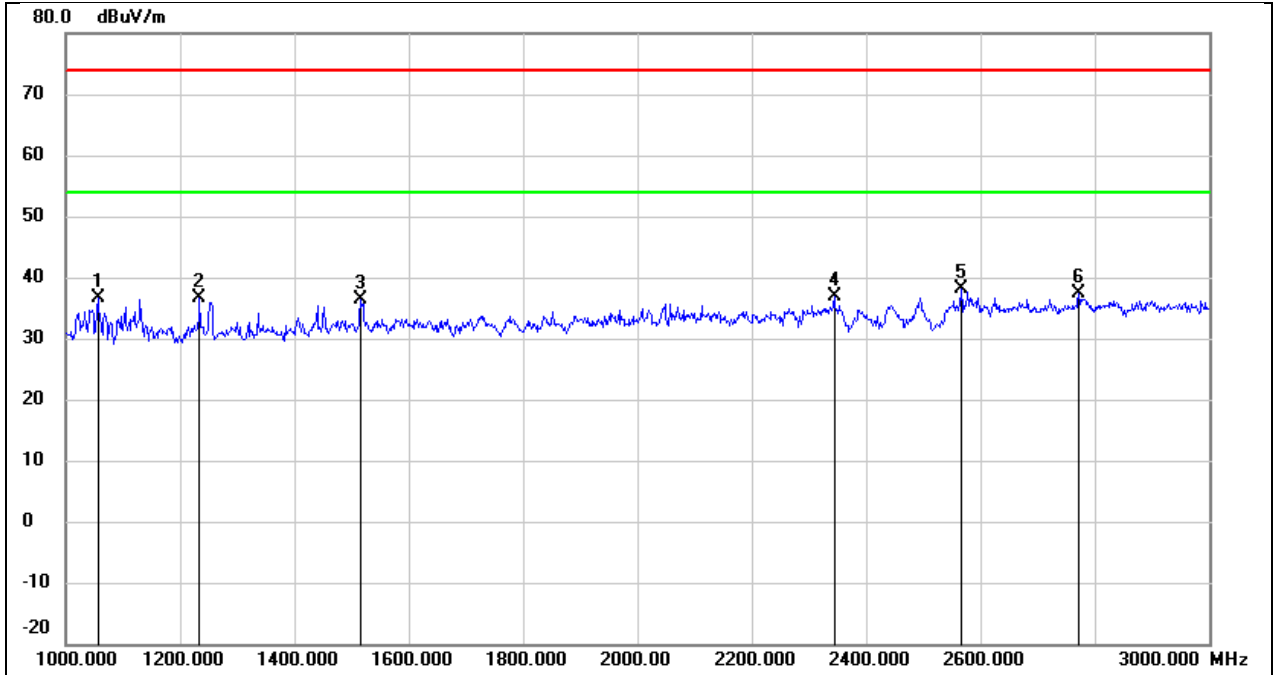

No.	Frequency (MHz)	Reading (dBuV)	Correct (dB/m)	Result (dBuV/m)	Limit (dBuV/m)	Margin (dB)	Remark
1	1056.000	51.31	-14.77	36.54	74.00	-37.46	peak
2	1234.000	50.65	-13.94	36.71	74.00	-37.29	peak
3	1516.000	49.13	-12.66	36.47	74.00	-37.53	peak
4	2344.000	46.12	-9.30	36.82	74.00	-37.18	peak
5	2566.000	46.44	-8.29	38.15	74.00	-35.85	peak
6	2772.000	45.00	-7.67	37.33	74.00	-36.67	peak

Test Mode:	BLE 1M	Frequency(MHz):	2480
Polarity:	Vertical	Test Voltage:	DC 7.2 V

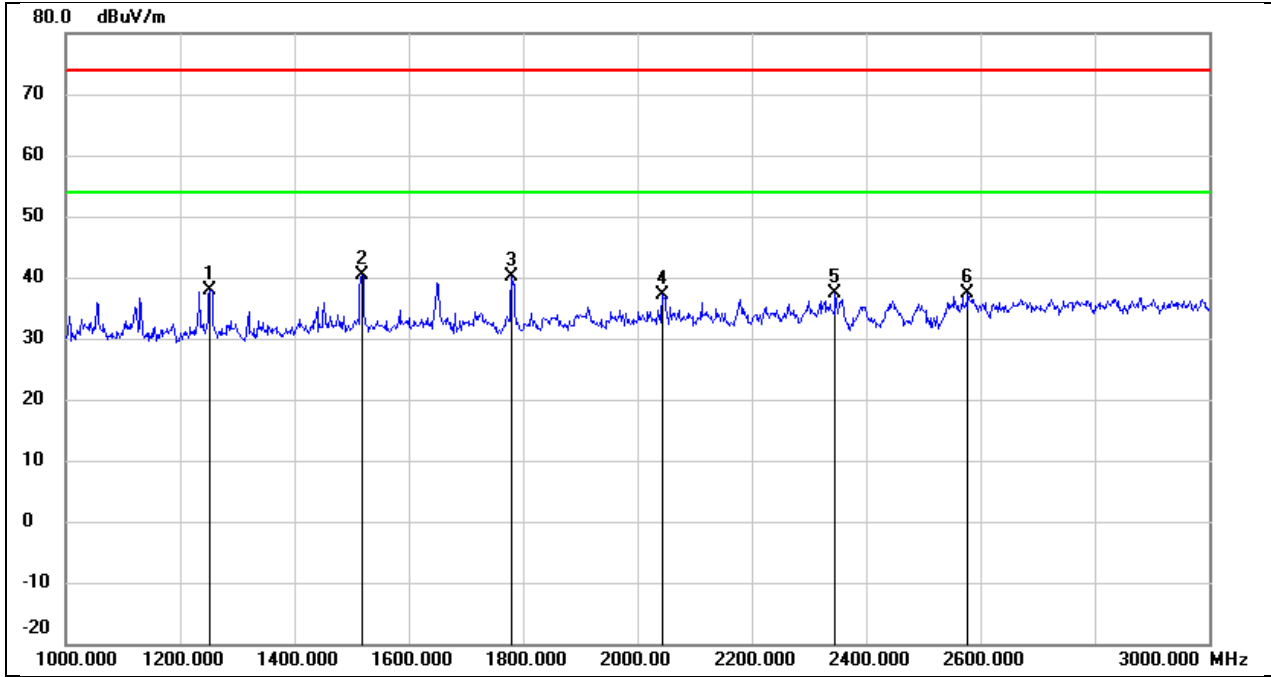

No.	Frequency (MHz)	Reading (dBuV)	Correct (dB/m)	Result (dBuV/m)	Limit (dBuV/m)	Margin (dB)	Remark
1	1252.000	51.86	-13.86	38.00	74.00	-36.00	peak
2	1518.000	53.15	-12.65	40.50	74.00	-33.50	peak
3	1780.000	52.02	-11.79	40.23	74.00	-33.77	peak
4	2044.000	47.85	-10.84	37.01	74.00	-36.99	peak
5	2346.000	46.59	-9.28	37.31	74.00	-36.69	peak
6	2578.000	45.73	-8.26	37.47	74.00	-36.53	peak

### 8.3. SPURIOUS EMISSIONS(3 GHZ~18 GHZ)

Test Mode:	BLE 1M	Frequency(MHz):	2402
Polarity:	Horizontal	Test Voltage:	DC 7.2 V

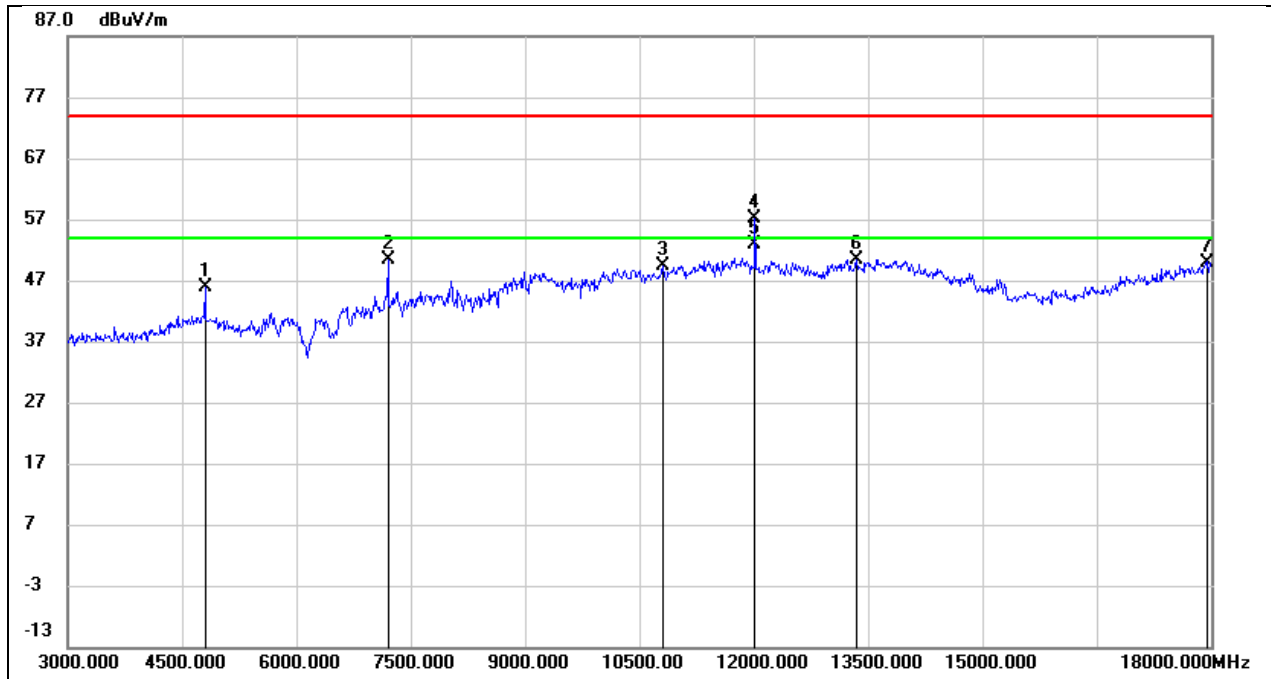

No.	Frequency (MHz)	Reading (dBuV)	Correct (dB/m)	Result (dBuV/m)	Limit (dBuV/m)	Margin (dB)	Remark
1	4800.000	46.27	-0.31	45.96	74.00	-28.04	peak
2	7200.000	43.89	6.55	50.44	74.00	-23.56	peak
3	10815.000	35.20	14.11	49.31	74.00	-24.69	peak
4	12015.000	39.07	17.95	57.02	74.00	-16.98	peak
5	12015.000	34.87	17.95	52.82	54.00	-1.18	AVG
6	13350.000	30.21	20.24	50.45	74.00	-23.55	peak
7	17940.000	24.66	25.34	50.00	74.00	-24.00	peak

Test Mode:	BLE 1M	Frequency(MHz):	2402
Polarity:	Vertical	Test Voltage:	DC 7.2 V

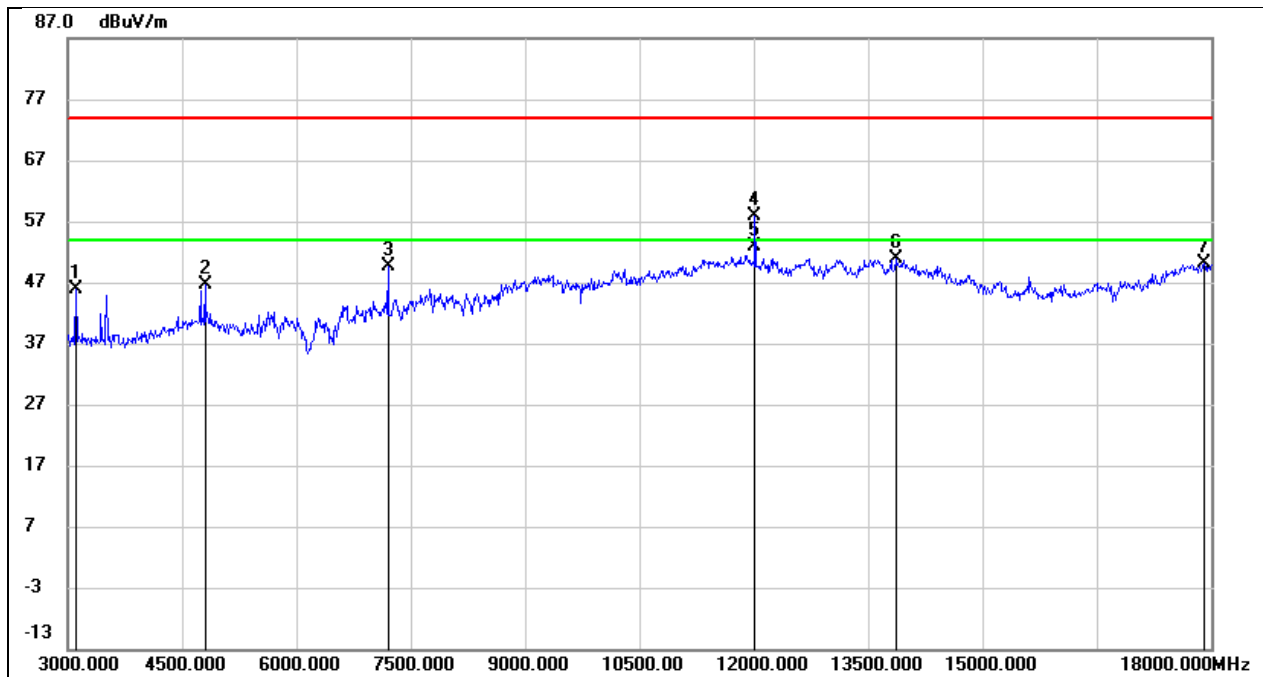

No.	Frequency (MHz)	Reading (dBuV)	Correct (dB/m)	Result (dBuV/m)	Limit (dBuV/m)	Margin (dB)	Remark
1	3105.000	51.17	-5.18	45.99	74.00	-28.01	peak
2	4800.000	46.84	-0.31	46.53	74.00	-27.47	peak
3	7200.000	42.96	6.55	49.51	74.00	-24.49	peak
4	12015.000	40.02	17.95	57.97	74.00	-16.03	peak
5	12015.000	34.99	17.95	52.94	54.00	-1.06	AVG
6	13860.000	29.32	21.67	50.99	74.00	-23.01	peak
7	17910.000	24.93	25.16	50.09	74.00	-23.91	peak



Test Mode:	BLE 1M	Frequency(MHz):	2440
Polarity:	Horizontal	Test Voltage:	DC 7.2 V

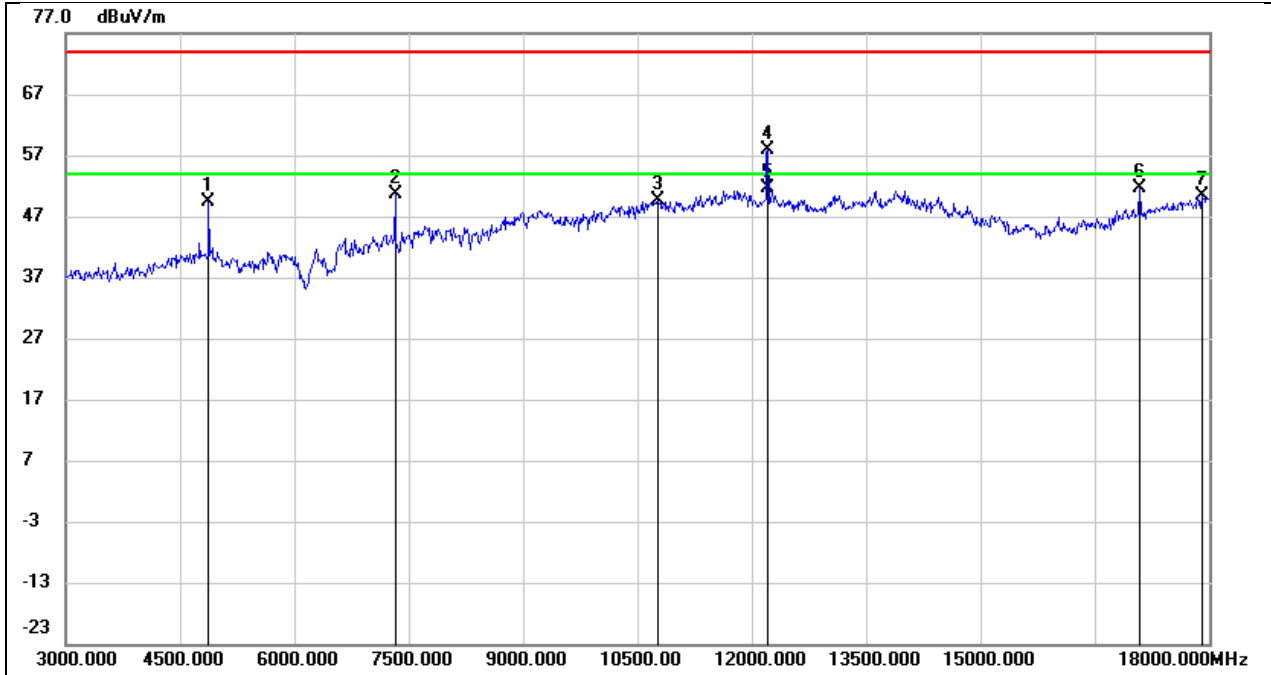

No.	Frequency (MHz)	Reading (dBuV)	Correct (dB/m)	Result (dBuV/m)	Limit (dBuV/m)	Margin (dB)	Remark
1	4875.000	49.41	-0.03	49.38	74.00	-24.62	peak
2	7320.000	44.28	6.46	50.74	74.00	-23.26	peak
3	10770.000	35.75	13.95	49.70	74.00	-24.30	peak
4	12210.000	40.19	17.81	58.00	74.00	-16.00	peak
5	12210.000	33.83	17.81	51.64	54.00	-2.36	AVG
6	17085.000	30.41	21.20	51.61	74.00	-22.39	peak
7	17910.000	25.33	25.16	50.49	74.00	-23.51	peak

Test Mode:	BLE 1M	Frequency(MHz):	2440
Polarity:	Vertical	Test Voltage:	DC 7.2 V

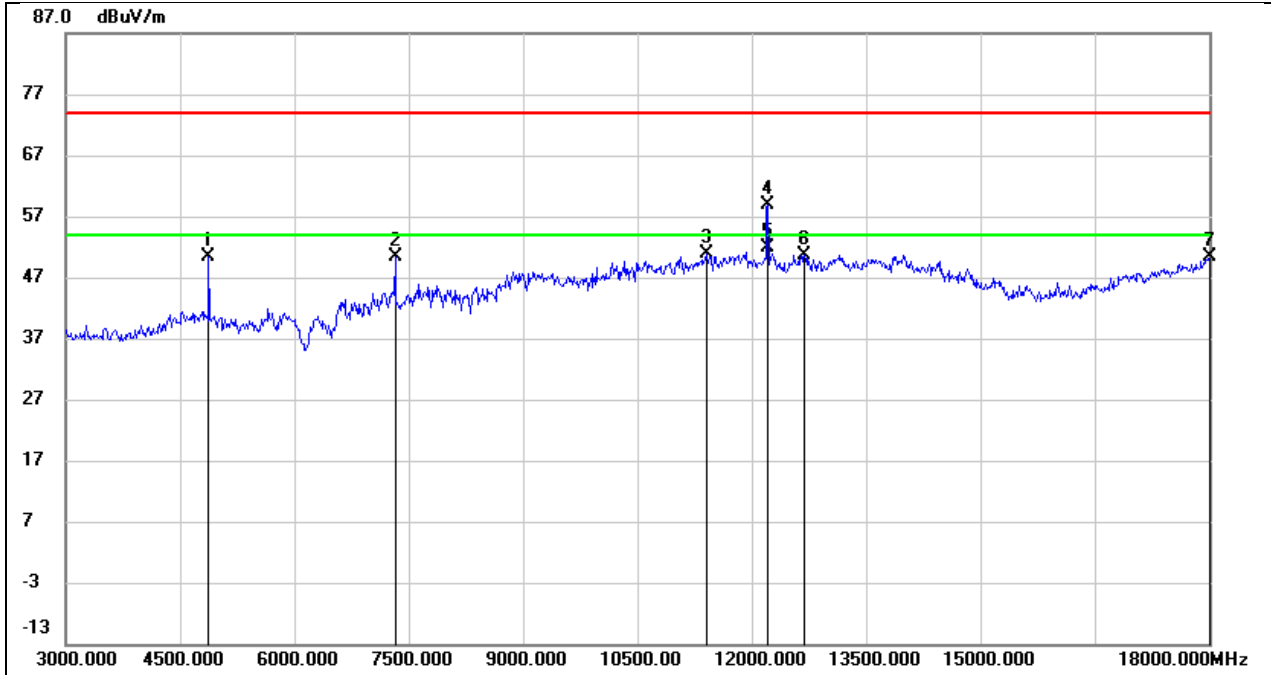

No.	Frequency (MHz)	Reading (dBuV)	Correct (dB/m)	Result (dBuV/m)	Limit (dBuV/m)	Margin (dB)	Remark
1	4875.000	50.42	-0.03	50.39	74.00	-23.61	peak
2	7320.000	44.03	6.46	50.49	74.00	-23.51	peak
3	11415.000	34.60	16.29	50.89	74.00	-23.11	peak
4	12210.000	41.15	17.81	58.96	74.00	-15.04	peak
5	12210.000	34.00	17.81	51.81	54.00	-2.19	AVG
6	12690.000	32.68	18.02	50.70	74.00	-23.30	peak
7	18000.000	24.65	25.69	50.34	74.00	-23.66	peak

Test Mode:	BLE 1M	Frequency(MHz):	2480
Polarity:	Horizontal	Test Voltage:	DC 7.2 V

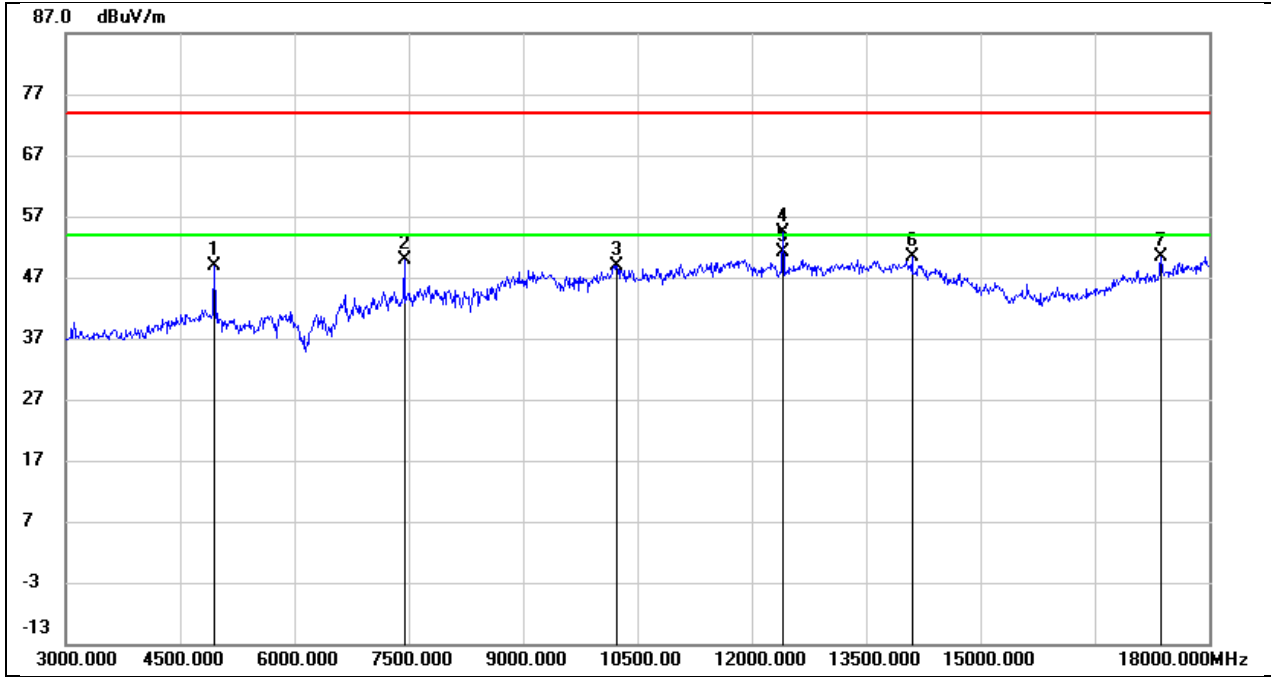

No.	Frequency (MHz)	Reading (dBuV)	Correct (dB/m)	Result (dBuV/m)	Limit (dBuV/m)	Margin (dB)	Remark
1	4950.000	48.70	0.26	48.96	74.00	-25.04	peak
2	7440.000	43.54	6.38	49.92	74.00	-24.08	peak
3	10230.000	36.50	12.46	48.96	74.00	-25.04	peak
4	12405.000	36.74	17.67	54.41	74.00	-19.59	peak
5	12405.000	33.55	17.67	51.22	54.00	-2.78	AVG
6	14100.000	28.76	21.55	50.31	74.00	-23.69	peak
7	17370.000	28.23	22.25	50.48	74.00	-23.52	peak

Test Mode:	BLE 1M	Frequency(MHz):	2480
Polarity:	Vertical	Test Voltage:	DC 7.2 V

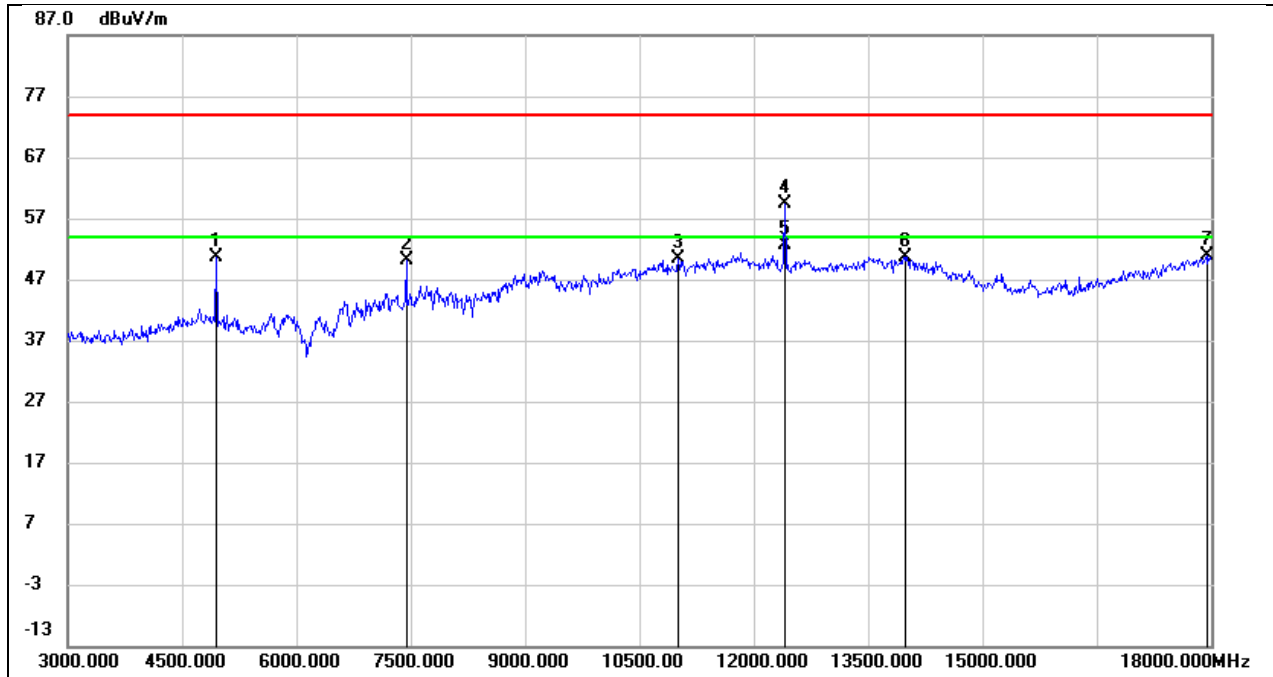

No.	Frequency (MHz)	Reading (dBuV)	Correct (dB/m)	Result (dBuV/m)	Limit (dBuV/m)	Margin (dB)	Remark
1	4950.000	50.33	0.26	50.59	74.00	-23.41	peak
2	7440.000	43.77	6.38	50.15	74.00	-23.85	peak
3	11010.000	35.53	14.81	50.34	74.00	-23.66	peak
4	12405.000	41.83	17.67	59.50	74.00	-14.50	peak
5	12405.000	35.07	17.67	52.74	54.00	-1.26	AVG
6	13980.000	28.79	21.92	50.71	74.00	-23.29	peak
7	17940.000	25.62	25.34	50.96	74.00	-23.04	peak

Test Mode:	BLE 2M	Frequency(MHz):	2402
Polarity:	Horizontal	Test Voltage:	DC 7.2 V

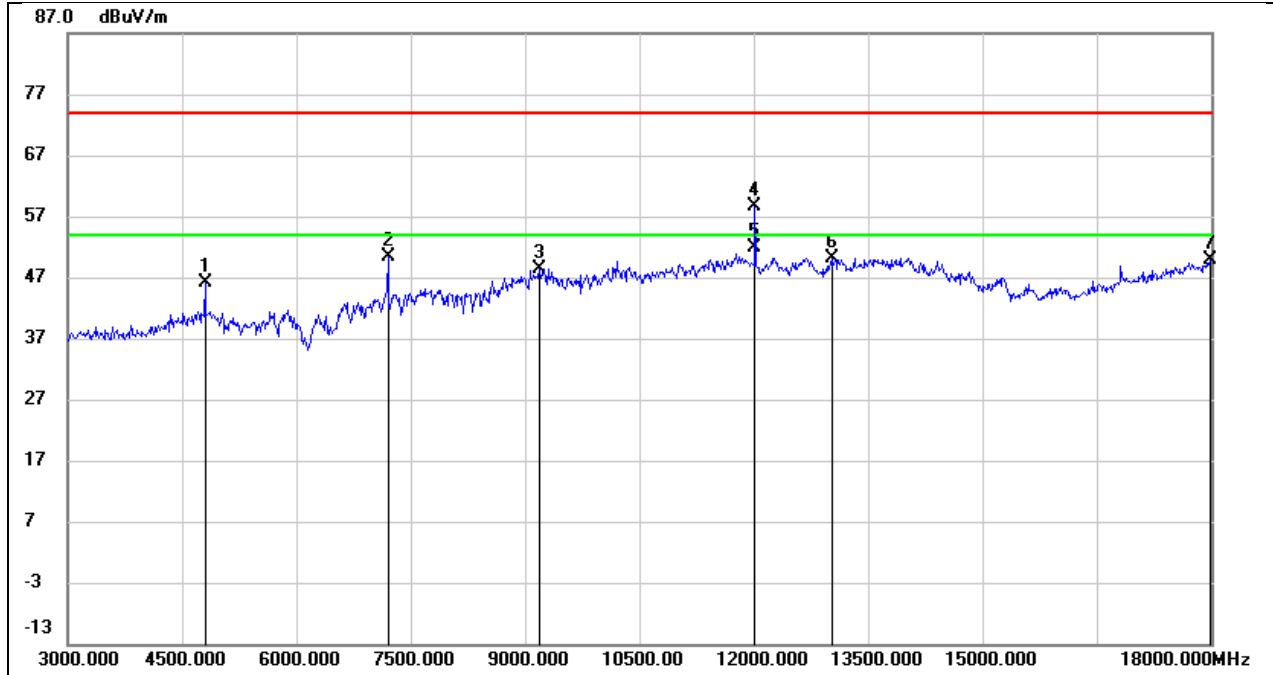

No.	Frequency (MHz)	Reading (dBuV)	Correct (dB/m)	Result (dBuV/m)	Limit (dBuV/m)	Margin (dB)	Remark
1	4800.000	46.41	-0.31	46.10	74.00	-27.90	peak
2	7200.000	43.85	6.55	50.40	74.00	-23.60	peak
3	9180.000	37.86	10.56	48.42	74.00	-25.58	peak
4	12015.000	40.67	17.95	58.62	74.00	-15.38	peak
5	12015.000	34.02	17.95	51.97	54.00	-2.03	AVG
6	13020.000	31.40	18.80	50.20	74.00	-23.80	peak
7	17985.000	24.35	25.60	49.95	74.00	-24.05	peak

Test Mode:	BLE 2M	Frequency(MHz):	2402
Polarity:	Vertical	Test Voltage:	DC 7.2 V

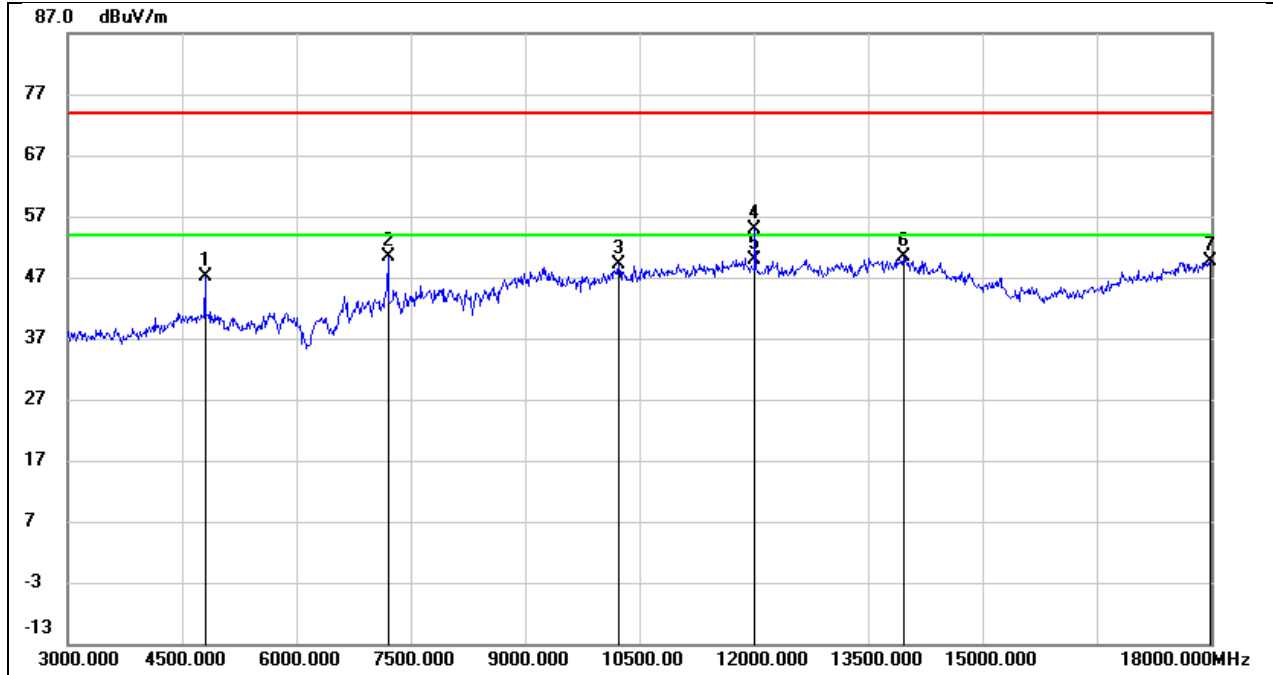

No.	Frequency (MHz)	Reading (dBuV)	Correct (dB/m)	Result (dBuV/m)	Limit (dBuV/m)	Margin (dB)	Remark
1	4800.000	47.37	-0.31	47.06	74.00	-26.94	peak
2	7200.000	43.82	6.55	50.37	74.00	-23.63	peak
3	10230.000	36.63	12.46	49.09	74.00	-24.91	peak
4	12015.000	36.88	17.95	54.83	74.00	-19.17	peak
5	12015.000	32.01	17.95	49.96	54.00	-4.04	AVG
6	13965.000	28.37	21.89	50.26	74.00	-23.74	peak
7	17985.000	24.04	25.60	49.64	74.00	-24.36	peak

Test Mode:	BLE 2M	Frequency(MHz):	2440
Polarity:	Horizontal	Test Voltage:	DC 7.2 V

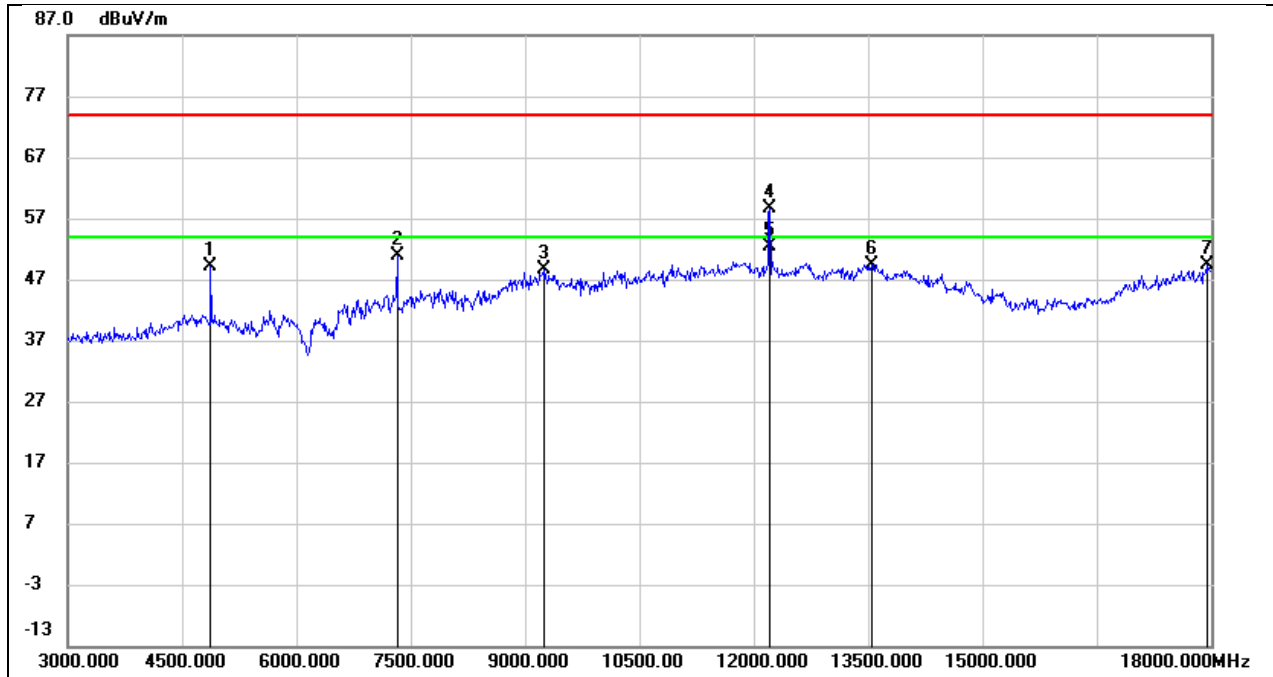

No.	Frequency (MHz)	Reading (dBuV)	Correct (dB/m)	Result (dBuV/m)	Limit (dBuV/m)	Margin (dB)	Remark
1	4875.000	49.24	-0.03	49.21	74.00	-24.79	peak
2	7320.000	44.54	6.46	51.00	74.00	-23.00	peak
3	9240.000	38.04	10.58	48.62	74.00	-25.38	peak
4	12210.000	40.81	17.81	58.62	74.00	-15.38	peak
5	12210.000	34.45	17.81	52.26	54.00	-1.74	AVG
6	13545.000	28.50	20.99	49.49	74.00	-24.51	peak
7	17940.000	24.04	25.34	49.38	74.00	-24.62	peak

Test Mode:	BLE 2M	Frequency(MHz):	2440
Polarity:	Vertical	Test Voltage:	DC 7.2 V

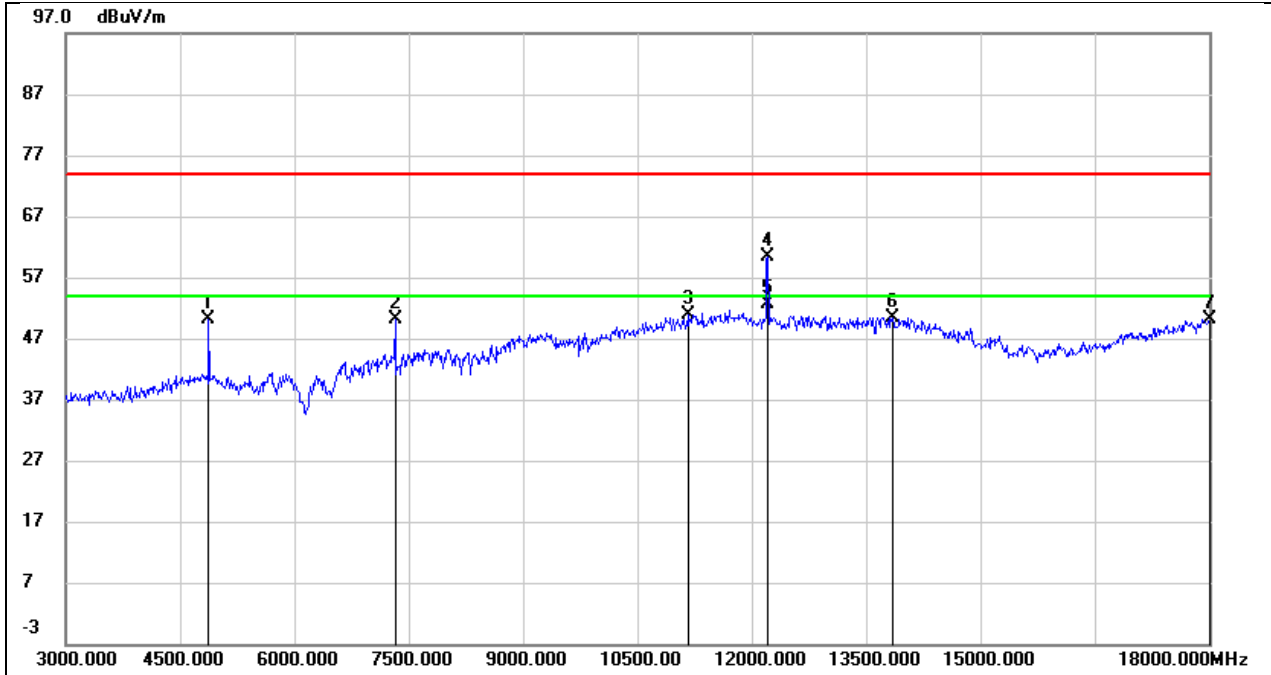

No.	Frequency (MHz)	Reading (dBuV)	Correct (dB/m)	Result (dBuV/m)	Limit (dBuV/m)	Margin (dB)	Remark
1	4875.000	50.04	-0.03	50.01	74.00	-23.99	peak
2	7320.000	43.57	6.46	50.03	74.00	-23.97	peak
3	11160.000	35.61	15.36	50.97	74.00	-23.03	peak
4	12210.000	42.48	17.81	60.29	74.00	-13.71	peak
5	12210.000	34.77	17.81	52.58	54.00	-1.42	AVG
6	13845.000	28.88	21.62	50.50	74.00	-23.50	peak
7	18000.000	24.52	25.69	50.21	74.00	-23.79	peak



Test Mode:	BLE 2M	Frequency(MHz):	2480
Polarity:	Horizontal	Test Voltage:	DC 7.2 V

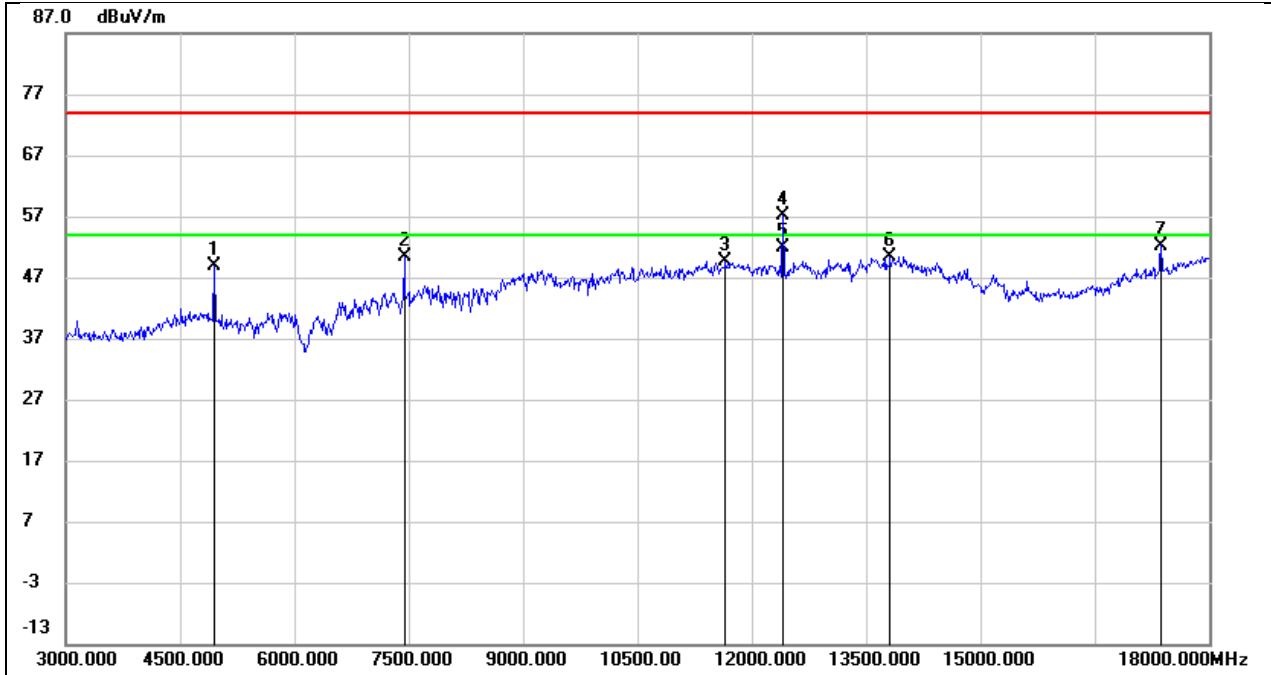

No.	Frequency (MHz)	Reading (dBuV)	Correct (dB/m)	Result (dBuV/m)	Limit (dBuV/m)	Margin (dB)	Remark
1	4950.000	48.61	0.26	48.87	74.00	-25.13	peak
2	7440.000	43.92	6.38	50.30	74.00	-23.70	peak
3	11655.000	32.64	17.01	49.65	74.00	-24.35	peak
4	12405.000	39.38	17.67	57.05	74.00	-16.95	peak
5	12405.000	34.18	17.67	51.85	54.00	-2.15	AVG
6	13815.000	28.93	21.56	50.49	74.00	-23.51	peak
7	17370.000	30.00	22.25	52.25	74.00	-21.75	peak

Test Mode:	BLE 2M	Frequency(MHz):	2480
Polarity:	Vertical	Test Voltage:	DC 7.2 V

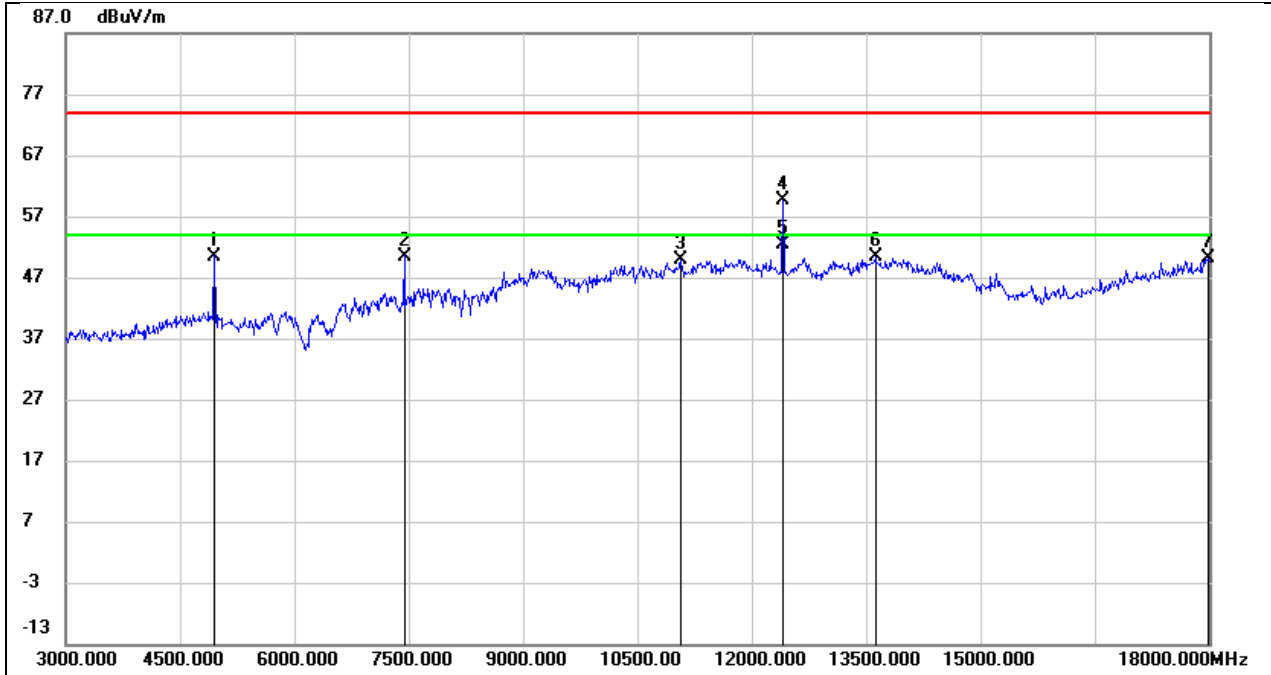

No.	Frequency (MHz)	Reading (dBuV)	Correct (dB/m)	Result (dBuV/m)	Limit (dBuV/m)	Margin (dB)	Remark
1	4950.000	50.24	0.26	50.50	74.00	-23.50	peak
2	7440.000	44.12	6.38	50.50	74.00	-23.50	peak
3	11070.000	34.75	15.03	49.78	74.00	-24.22	peak
4	12405.000	41.93	17.67	59.60	74.00	-14.40	peak
5	12405.000	34.83	17.67	52.50	54.00	-1.50	AVG
6	13620.000	29.12	21.15	50.27	74.00	-23.73	peak
7	17985.000	24.44	25.60	50.04	74.00	-23.96	peak

### 8.4. SPURIOUS EMISSIONS(9 KHZ~30 MHZ)

Test Mode:	BLE 1M	Frequency(MHz):	2402
Polarity:	Horizontal	Test Voltage:	DC 7.2 V

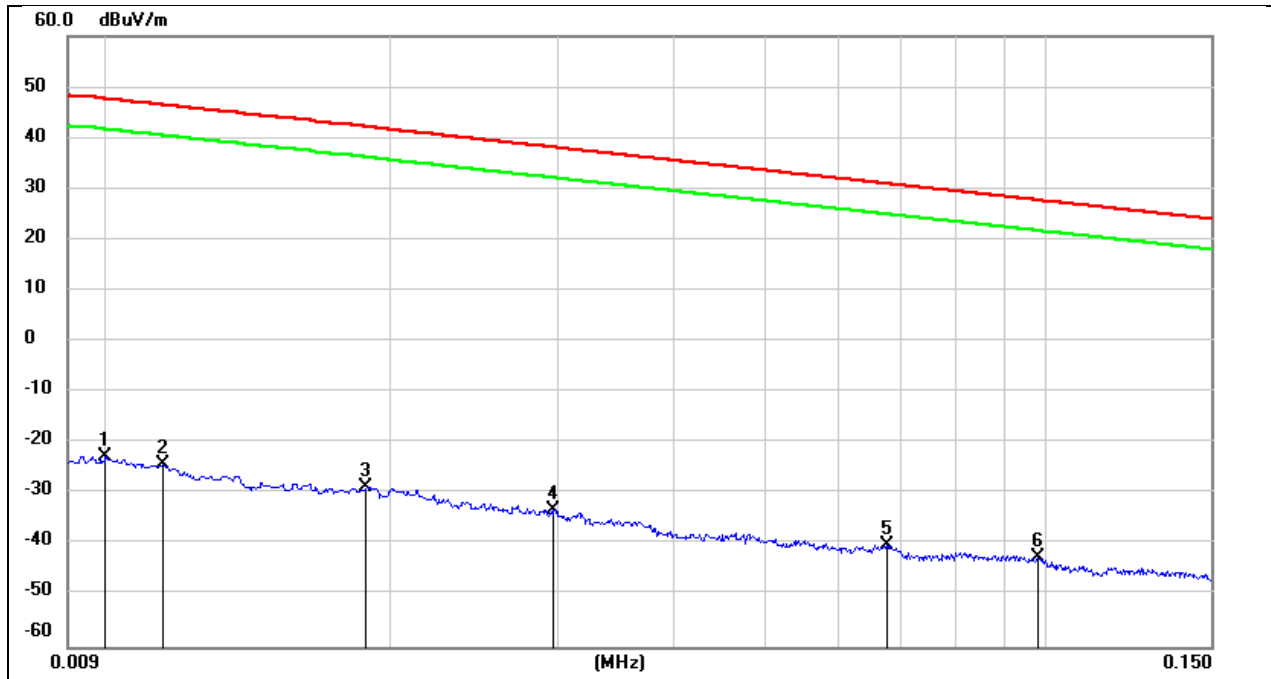

No.	Frequency (MHz)	Reading (dBuV)	Correct (dB/m)	FCC Result (dBuV/m)	FCC Limit (dBuV/m)	ISED Result (dBuA/m)	ISED Limit (dBuA/m)	Margin (dB)	Remark
1	0.0100	78.72	-101.40	-22.68	47.60	-74.18	-3.90	-70.28	peak
2	0.0114	77.38	-101.40	-24.02	46.46	-75.52	-5.04	-70.48	peak
3	0.0188	72.64	-101.35	-28.71	42.12	-80.21	-9.38	-70.83	peak
4	0.0298	68.24	-101.39	-33.15	38.12	-84.65	-13.38	-71.27	peak
5	0.0675	61.64	-101.56	-39.92	31.02	-91.42	-20.48	-70.94	peak
6	0.0981	59.27	-101.78	-42.51	27.77	-94.01	-23.73	-70.28	peak

Test Mode:	BLE 1M	Frequency(MHz):	2402
Polarity:	Horizontal	Test Voltage:	DC 7.2 V

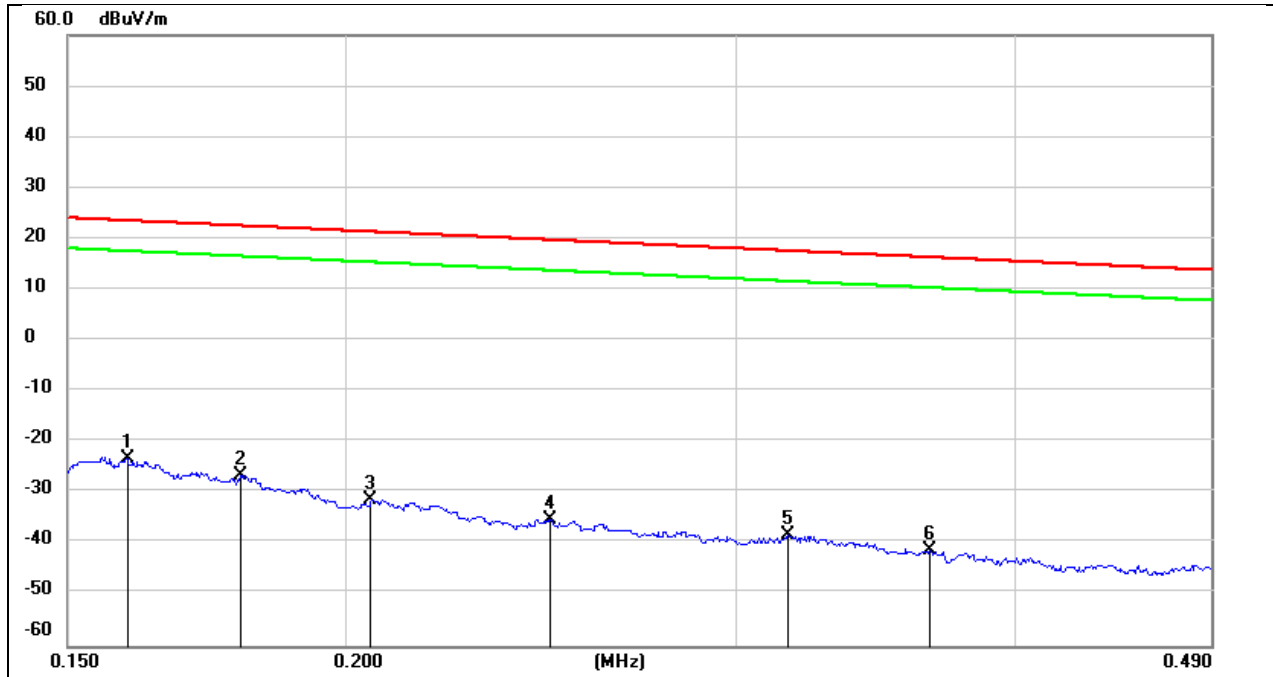

No.	Frequency (MHz)	Reading (dBuV)	Correct (dB/m)	FCC Result (dBuV/m)	FCC Limit (dBuV/m)	ISED Result (dBuA/m)	ISED Limit (dBuA/m)	Margin (dB)	Remark
1	0.1595	78.36	-101.65	-23.29	23.55	-74.79	-27.95	-46.84	peak
2	0.1794	75.27	-101.68	-26.41	22.53	-77.91	-28.97	-48.94	peak
3	0.2053	70.29	-101.73	-31.44	21.35	-82.94	-30.15	-52.79	peak
4	0.2472	66.45	-101.80	-35.35	19.74	-86.85	-31.76	-55.09	peak
5	0.3163	63.70	-101.87	-38.17	17.60	-89.67	-33.90	-55.77	peak
6	0.3662	60.58	-101.93	-41.35	16.33	-92.85	-35.17	-57.68	peak

Test Mode:	BLE 1M	Frequency(MHz):	2402
Polarity:	Horizontal	Test Voltage:	DC 7.2 V

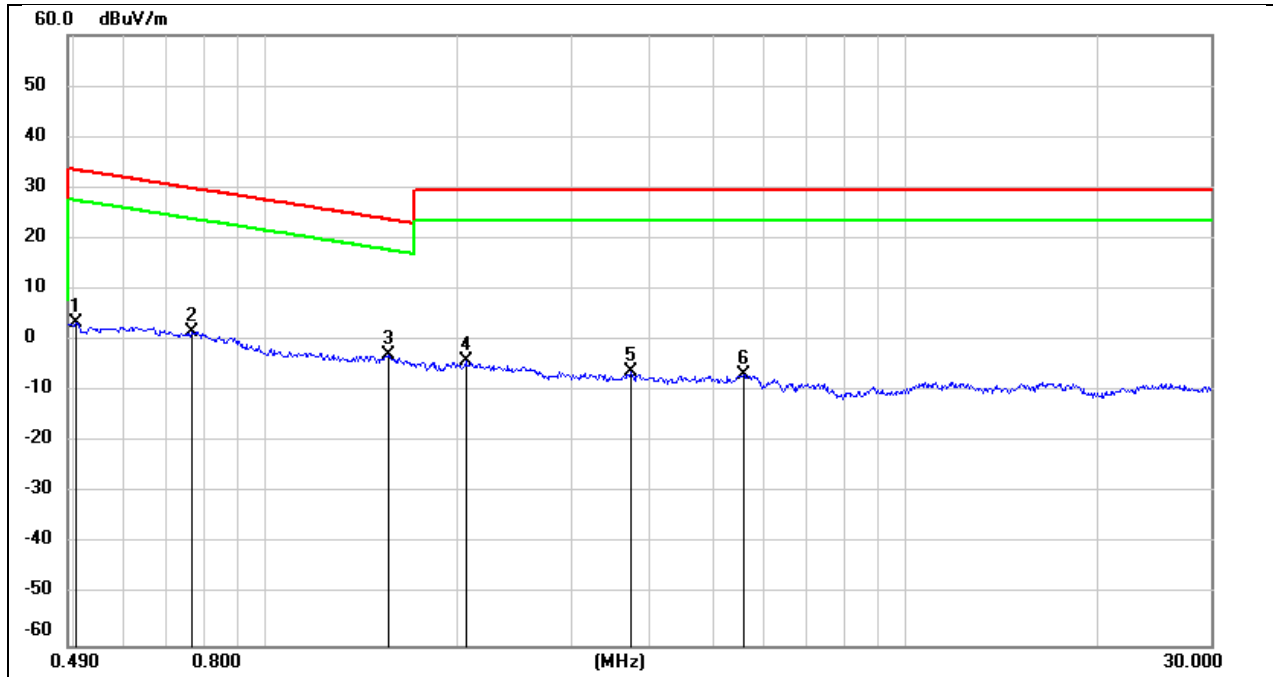

No.	Frequency (MHz)	Reading (dBuV)	Correct (dB/m)	FCC Result (dBuV/m)	FCC Limit (dBuV/m)	ISED Result (dBuA/m)	ISED Limit (dBuA/m)	Margin (dB)	Remark
1	0.5039	65.43	-62.07	3.36	33.56	-48.14	-17.94	-30.20	peak
2	0.7641	63.92	-62.12	1.80	29.94	-49.70	-21.56	-28.14	peak
3	1.5564	59.18	-62.02	-2.84	23.76	-54.34	-27.74	-26.60	peak
4	2.0539	57.70	-61.81	-4.11	29.54	-55.61	-21.96	-33.65	peak
5	3.7100	55.20	-61.41	-6.21	29.54	-57.71	-21.96	-35.75	peak
6	5.5952	54.55	-61.41	-6.86	29.54	-58.36	-21.96	-36.40	peak

### 8.5. SPURIOUS EMISSIONS(18 GHZ~26 GHZ)

Test Mode:	BLE 1M	Frequency(MHz):	2402
Polarity:	Horizontal	Test Voltage:	DC 7.2 V

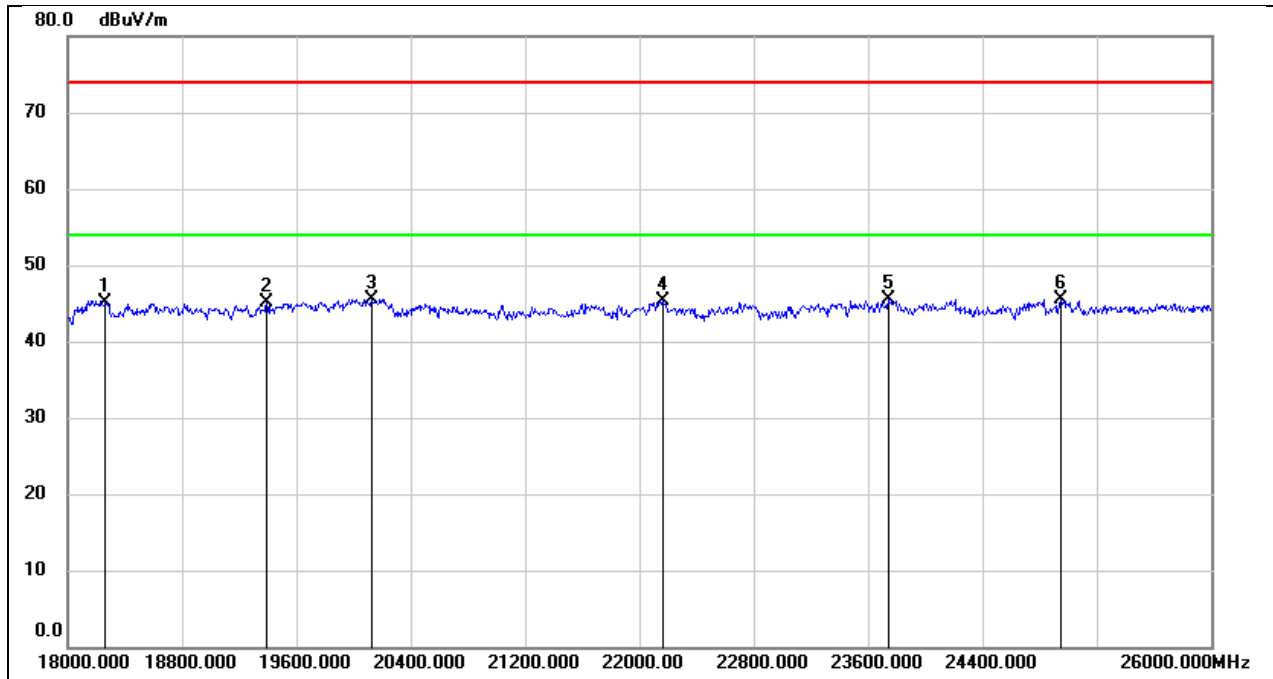

No.	Frequency (MHz)	Reading (dBuV)	Correct (dB/m)	Result (dBuV/m)	Limit (dBuV/m)	Margin (dB)	Remark
1	18264.000	50.65	-5.53	45.12	74.00	-28.88	peak
2	19392.000	50.62	-5.57	45.05	74.00	-28.95	peak
3	20128.000	51.12	-5.53	45.59	74.00	-28.41	peak
4	22160.000	49.58	-4.31	45.27	74.00	-28.73	peak
5	23744.000	48.65	-3.20	45.45	74.00	-28.55	peak
6	24952.000	47.63	-2.14	45.49	74.00	-28.51	peak

Test Mode:	BLE 1M	Frequency(MHz):	2402
Polarity:	Vertical	Test Voltage:	DC 7.2 V

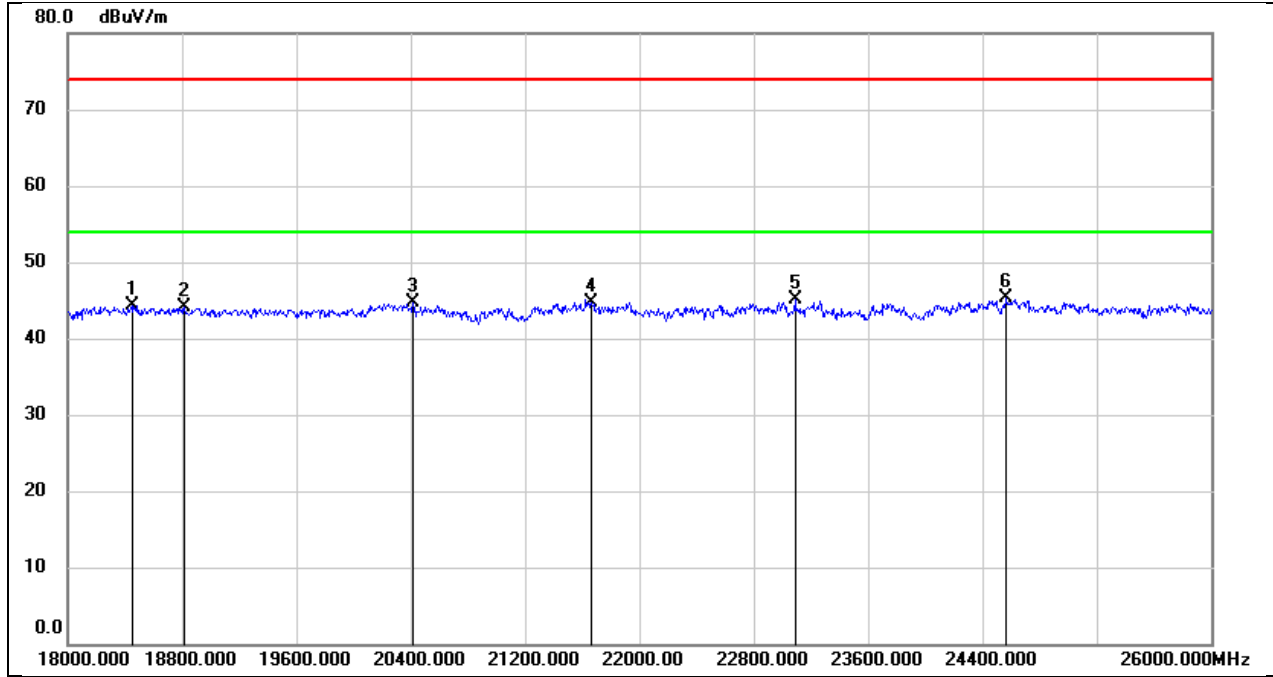

No.	Frequency (MHz)	Reading (dBuV)	Correct (dB/m)	Result (dBuV/m)	Limit (dBuV/m)	Margin (dB)	Remark
1	18448.000	49.70	-5.32	44.38	74.00	-29.62	peak
2	18816.000	49.42	-5.38	44.04	74.00	-29.96	peak
3	20416.000	50.13	-5.45	44.68	74.00	-29.32	peak
4	21664.000	49.23	-4.45	44.78	74.00	-29.22	peak
5	23088.000	48.52	-3.41	45.11	74.00	-28.89	peak
6	24568.000	47.60	-2.33	45.27	74.00	-28.73	peak

## 8.6. SPURIOUS EMISSIONS(30 MHZ~1 GHZ)

Test Mode:	BLE 1M	Frequency(MHz):	2402
Polarity:	Horizontal	Test Voltage:	DC 7.2 V

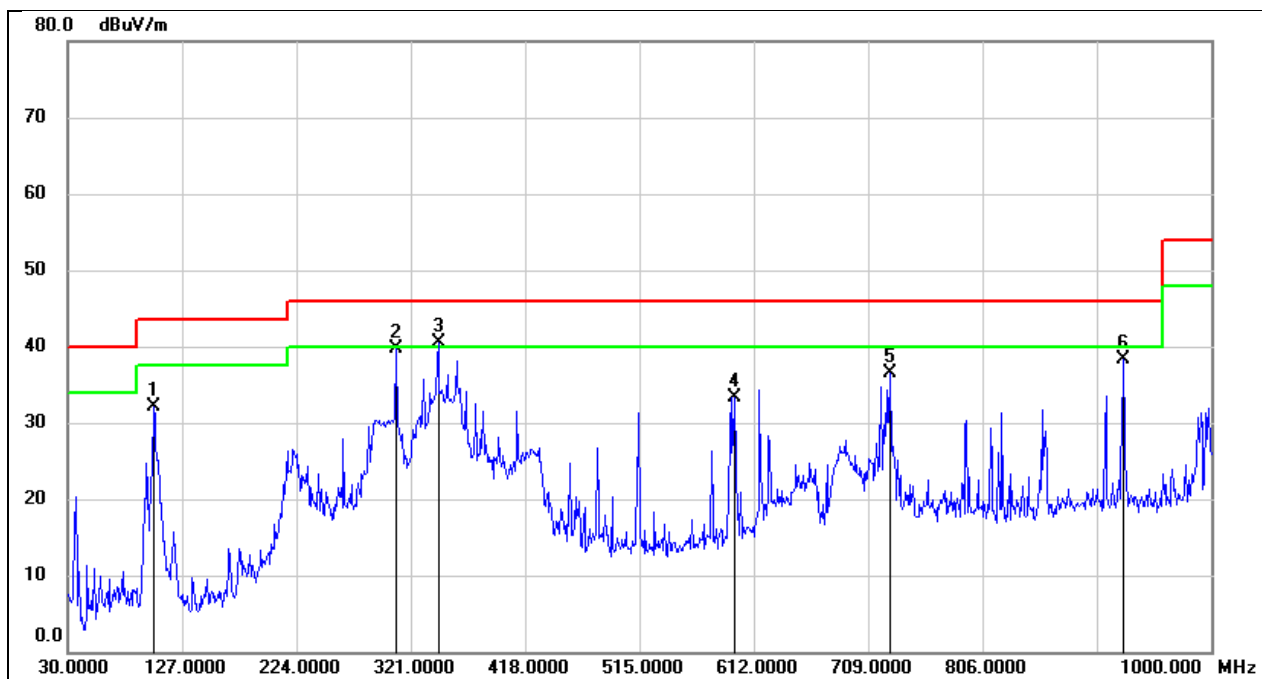

No.	Frequency (MHz)	Reading (dBuV)	Correct (dB/m)	Result (dBuV/m)	Limit (dBuV/m)	Margin (dB)	Remark
1	102.7500	52.71	-20.57	32.14	43.50	-11.36	QP
2	308.3900	54.17	-14.41	39.76	46.00	-6.24	QP
3	344.2800	53.21	-12.77	40.44	46.00	-5.56	QP
4	595.5100	42.41	-9.09	33.32	46.00	-12.68	QP
5	727.4300	43.56	-7.13	36.43	46.00	-9.57	QP
6	925.3100	42.91	-4.51	38.40	46.00	-7.60	QP



Test Mode:	BLE 1M	Frequency(MHz):	2402
Polarity:	Vertical	Test Voltage:	DC 7.2 V

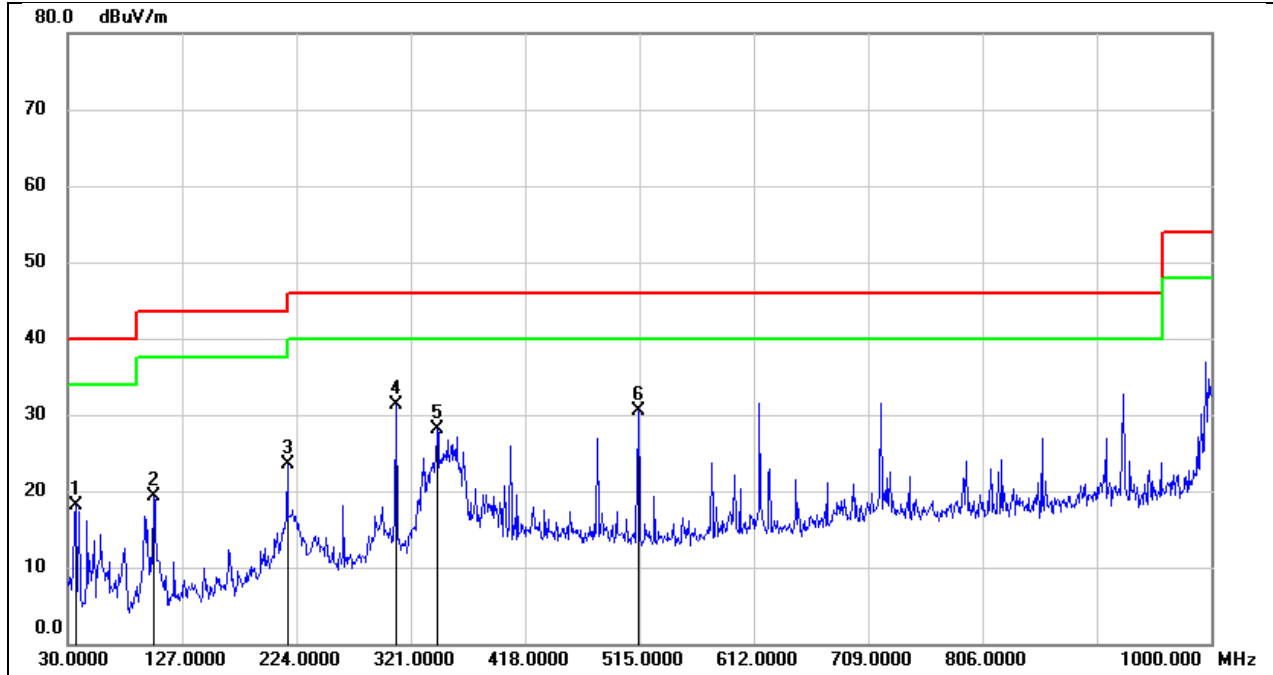

No.	Frequency (MHz)	Reading (dBuV)	Correct (dB/m)	Result (dBuV/m)	Limit (dBuV/m)	Margin (dB)	Remark
1	36.7900	37.01	-18.83	18.18	40.00	-21.82	QP
2	102.7500	39.85	-20.57	19.28	43.50	-24.22	QP
3	216.2400	40.15	-16.64	23.51	46.00	-22.49	QP
4	308.3900	45.69	-14.41	31.28	46.00	-14.72	QP
5	343.3100	41.01	-12.82	28.19	46.00	-17.81	QP
6	514.0300	40.91	-10.32	30.59	46.00	-15.41	QP

## 9. ANTENNA REQUIREMENT

### REQUIREMENT

Please refer to FCC part 15.203

An intentional radiator shall be designed to ensure that no antenna other than that furnished by the responsible party shall be used with the device. The use of a permanently attached antenna or of an antenna that uses a unique coupling to the intentional radiator shall be considered sufficient to comply with the provisions of this section. The manufacturer may design the unit so that a broken antenna can be replaced by the user, but the use of a standard antenna jack or electrical connector is prohibited.

Please refer to FCC part 15.247(b)(4)

The conducted output power limit specified in paragraph (b) of this section is based on the use of antennas with directional gains that do not exceed 6 dBi. Except as shown in paragraph (c) of this section, if transmitting antennas of directional gain greater than 6 dBi are used, the conducted output power from the intentional radiator shall be reduced below the stated values in paragraphs (b)(1), (b)(2), and (b)(3) of this section, as appropriate, by the amount in dB that the directional gain of the antenna exceeds 6 dBi.

### DESCRIPTION

Pass

## 10. AC POWER LINE CONDUCTED EMISSION

### LIMITS

Please refer to CFR 47 FCC §15.207 (a) and ISED RSS-Gen Clause 8.8

FREQUENCY (MHz)	Quasi-peak	Average
0.15 -0.5	66 - 56 *	56 - 46 *
0.50 -5.0	56.00	46.00
5.0 -30.0	60.00	50.00

### TEST PROCEDURE

The EUT is put on a table of non-conducting material that is 80 cm high. The vertical conducting wall of shielding is located 40 cm to the rear of the EUT. The power line of the EUT is connected to the AC mains through a Artificial Mains Network (A.M.N.). A EMI Measurement Receiver (R&S Test Receiver ESR3) is used to test the emissions from both sides of AC line. According to the requirements in Section 6.2 of ANSI C63.10-2013. Conducted emissions from the EUT measured in the frequency range between 0.15 MHz and 30 MHz using CISPR Quasi-Peak and average detector mode. The bandwidth of EMI test receiver is set at 9 kHz.

The arrangement of the equipment is installed to meet the standards and operating in a manner, which tends to maximize its emission characteristics in a normal application.

### TEST SETUP

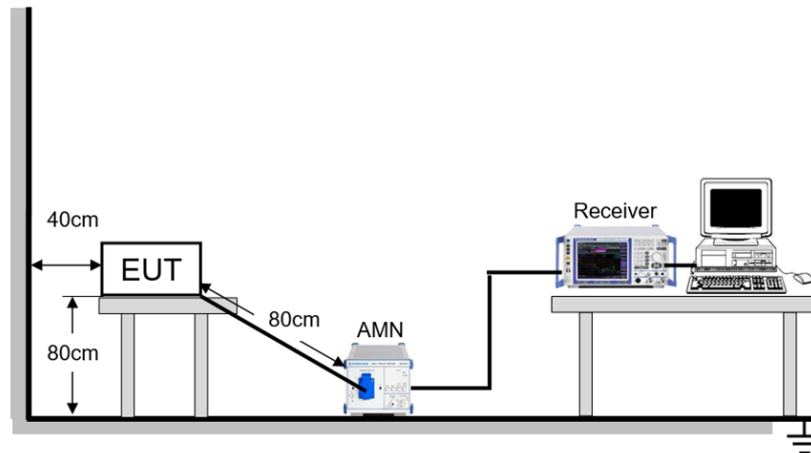

### TEST ENVIRONMENT

Temperature	24.5°C	Relative Humidity	58%
Atmosphere Pressure	101kPa	Test Voltage	AC 120 V, 60 Hz

### TEST DATE / ENGINEER

Test Date	January 10, 2024	Test By	Fanny Huang
-----------	------------------	---------	-------------

**TEST RESULTS**

Test Mode:	BLE 1M	Frequency(MHz):	2402
Line:	Line		

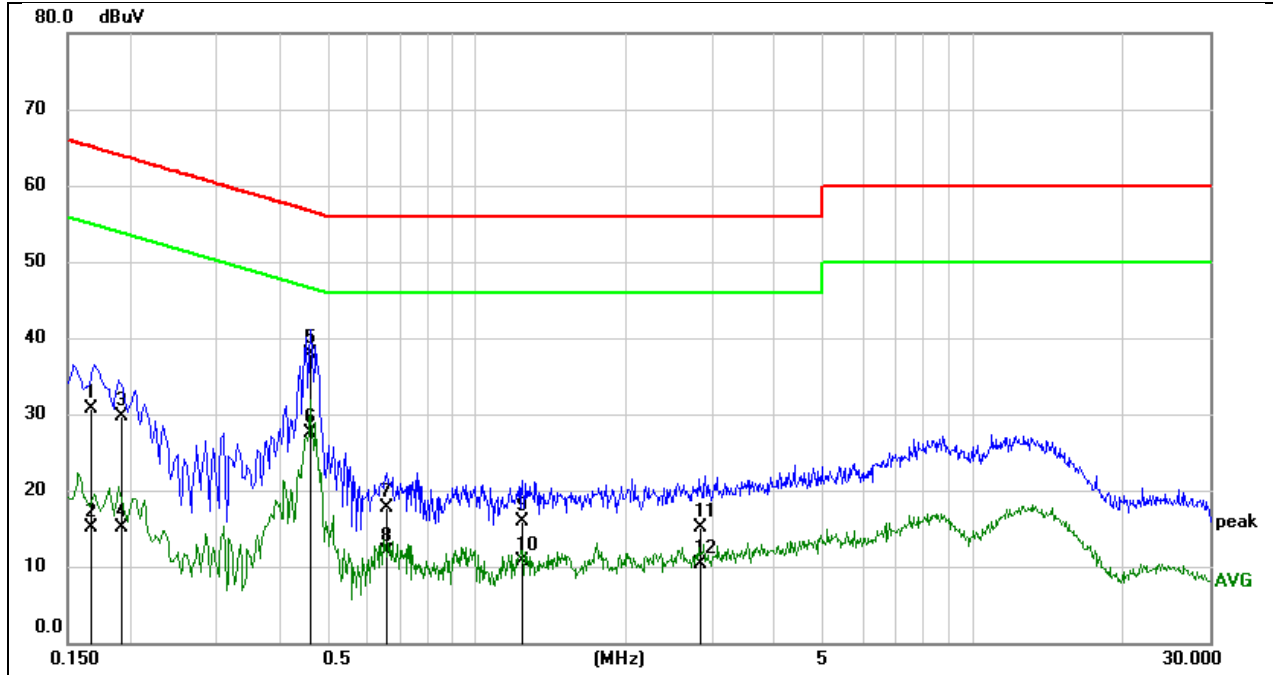

No.	Frequency (MHz)	Reading (dBuV)	Correct (dB)	Result (dBuV)	Limit (dBuV)	Margin (dB)	Remark
1	0.1667	21.07	9.59	30.66	65.12	-34.46	QP
2	0.1667	5.55	9.59	15.14	55.12	-39.98	AVG
3	0.1930	20.14	9.59	29.73	63.91	-34.18	QP
4	0.1930	5.43	9.59	15.02	53.91	-38.89	AVG
5	0.4625	28.39	9.60	37.99	56.65	-18.66	QP
6	0.4625	17.85	9.60	27.45	46.65	-19.20	AVG
7	0.6592	8.09	9.60	17.69	56.00	-38.31	QP
8	0.6592	2.24	9.60	11.84	46.00	-34.16	AVG
9	1.2383	6.36	9.61	15.97	56.00	-40.03	QP
10	1.2383	1.12	9.61	10.73	46.00	-35.27	AVG
11	2.8444	5.37	9.66	15.03	56.00	-40.97	QP
12	2.8444	0.61	9.66	10.27	46.00	-35.73	AVG

Note:

1. Result = Reading + Correct Factor.
2. If QP Result complies with AV limit, AV Result is deemed to comply with AV limit.
3. Test setup: RBW: 200 Hz (9 kHz ~ 150 kHz), 9 kHz (150 kHz ~ 30 MHz).
4. Step size: 80 Hz (0.009 MHz ~ 0.15 MHz), 4 kHz (0.15 MHz ~ 30 MHz), Scan time: auto.

Note: All the modes have been tested, only the worst data was recorded in the report.

Test Mode:	BLE 1M	Frequency(MHz):	2402
Line:	Neutral		

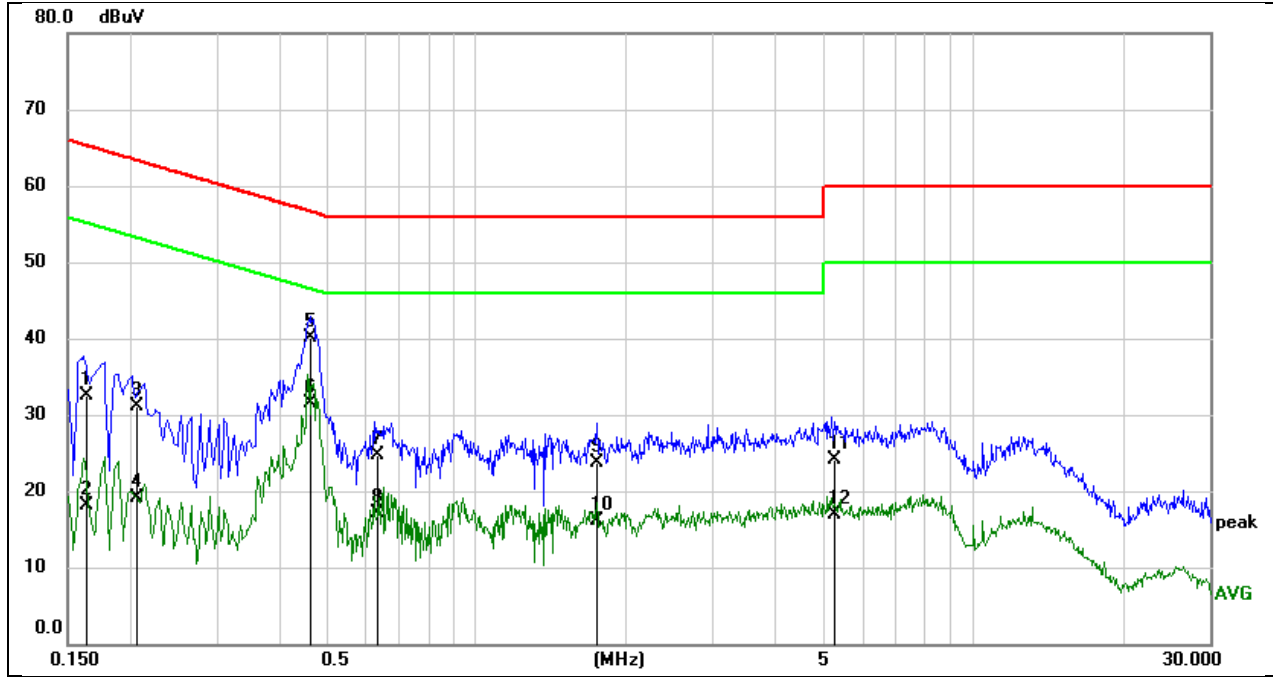

No.	Frequency (MHz)	Reading (dBuV)	Correct (dB)	Result (dBuV)	Limit (dBuV)	Margin (dB)	Remark
1	0.1640	23.00	9.59	32.59	65.26	-32.67	QP
2	0.1640	8.47	9.59	18.06	55.26	-37.20	AVG
3	0.2065	21.50	9.59	31.09	63.34	-32.25	QP
4	0.2065	9.49	9.59	19.08	53.34	-34.26	AVG
5	0.4627	30.50	9.60	40.10	56.64	-16.54	QP
6	0.4627	21.89	9.60	31.49	46.64	-15.15	AVG
7	0.6306	15.15	9.60	24.75	56.00	-31.25	QP
8	0.6306	7.44	9.60	17.04	46.00	-28.96	AVG
9	1.7506	14.14	9.62	23.76	56.00	-32.24	QP
10	1.7506	6.50	9.62	16.12	46.00	-29.88	AVG
11	5.2525	14.46	9.72	24.18	60.00	-35.82	QP
12	5.2525	7.12	9.72	16.84	50.00	-33.16	AVG

Note:

1. Result = Reading + Correct Factor.
2. If QP Result complies with AV limit, AV Result is deemed to comply with AV limit.
3. Test setup: RBW: 200 Hz (9 kHz ~ 150 kHz), 9 kHz (150 kHz ~ 30 MHz).
4. Step size: 80 Hz (0.009 MHz ~ 0.15 MHz), 4 kHz (0.15 MHz ~ 30 MHz), Scan time: auto.

Note: All the modes have been tested, only the worst data was recorded in the report.

## 11. TEST DATA

### 11.1. APPENDIX A: DTS BANDWIDTH

#### 11.1.1. Test Result

Test Mode	Antenna	Frequency[MHz]	DTS BW [MHz]	FL[MHz]	FH[MHz]	Limit[MHz]	Verdict
BLE_1M	Ant1	2402	0.69	2401.65	2402.34	≥0.5	PASS
		2440	0.69	2439.65	2440.34	≥0.5	PASS
		2480	0.72	2479.63	2480.34	≥0.5	PASS
BLE_2M	Ant1	2402	1.04	2401.46	2402.50	≥0.5	PASS
		2440	1.03	2439.46	2440.49	≥0.5	PASS
		2480	1.05	2479.46	2480.51	≥0.5	PASS

### 11.1.2. Test Graphs

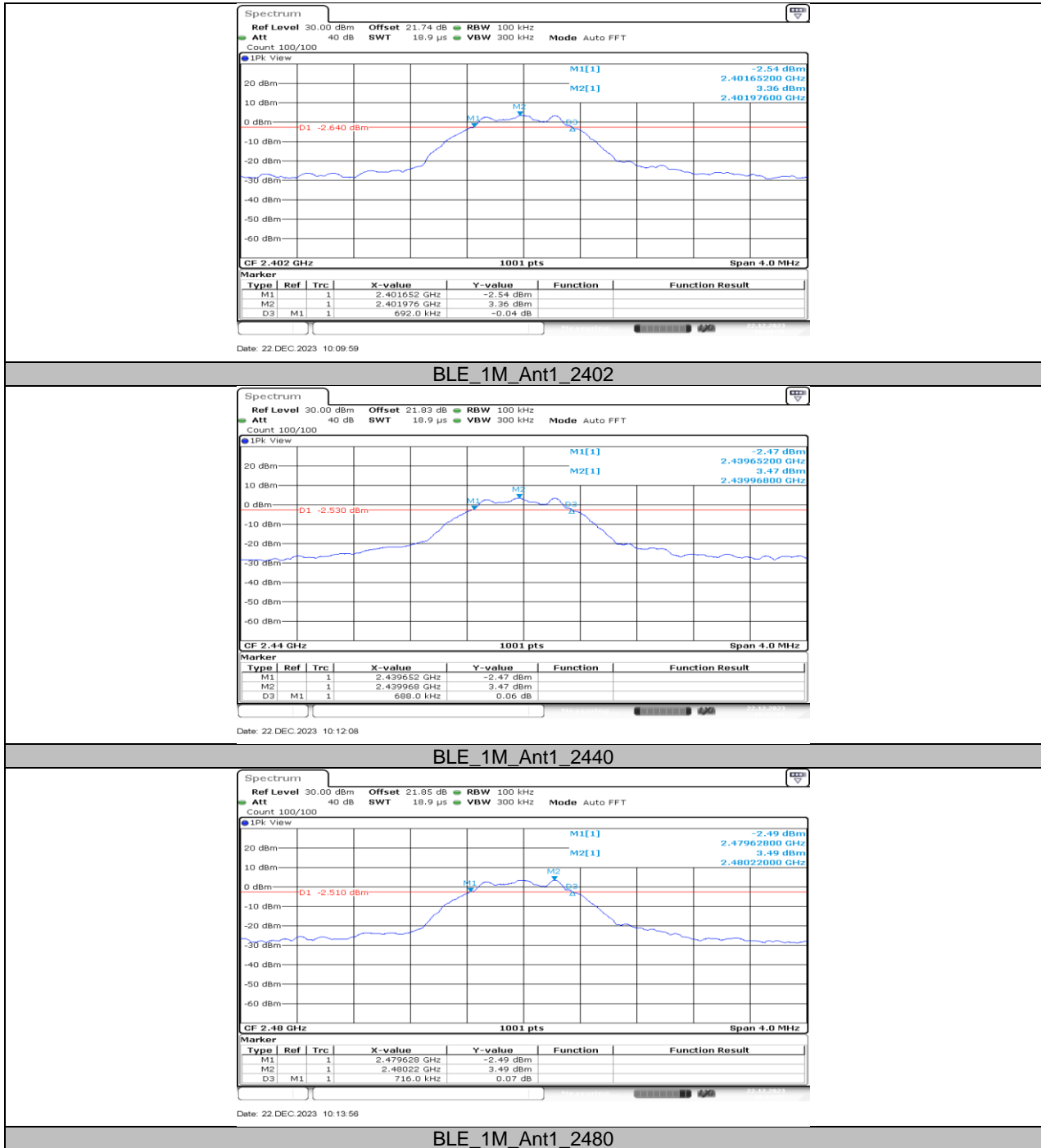

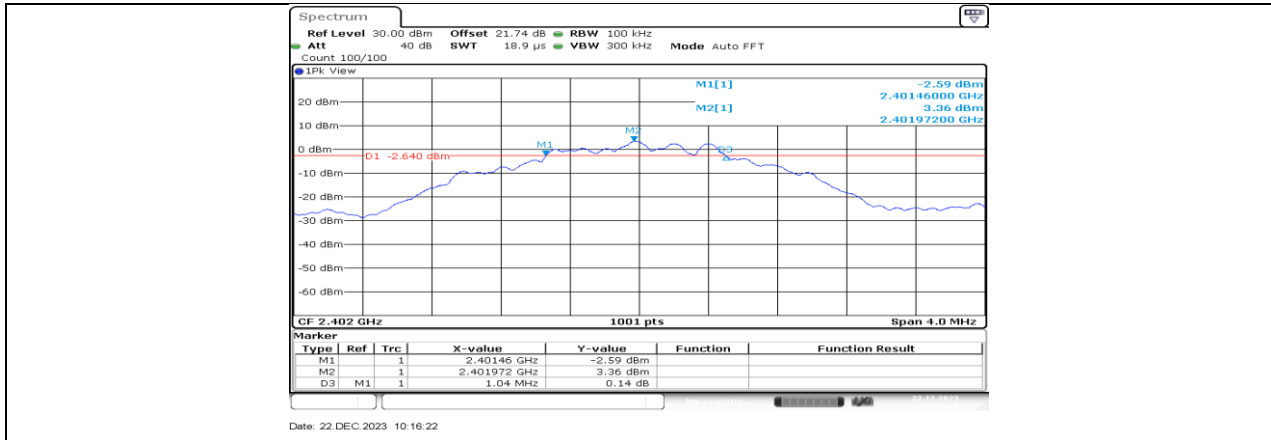

BLE\_2M\_Ant1\_2402

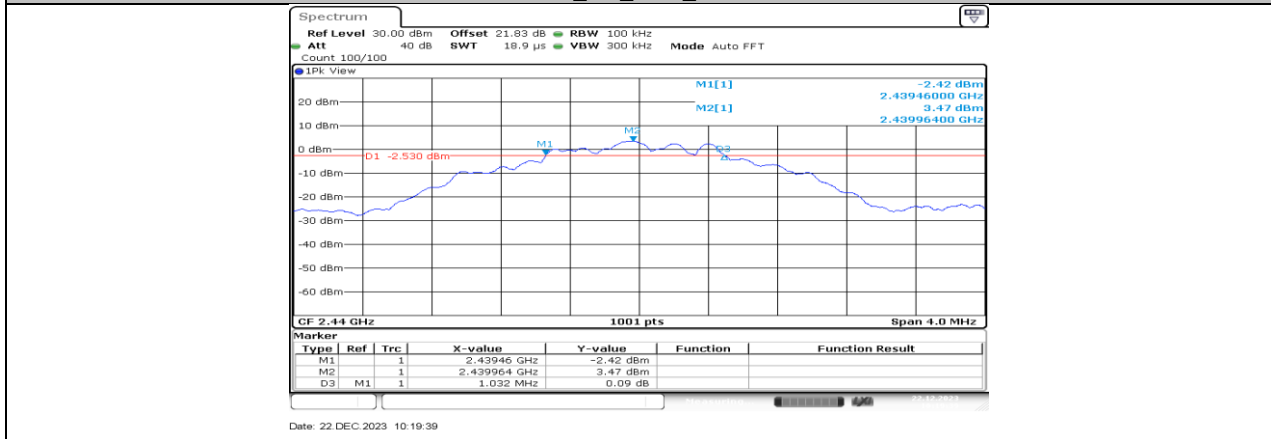

BLE\_2M\_Ant1\_2440

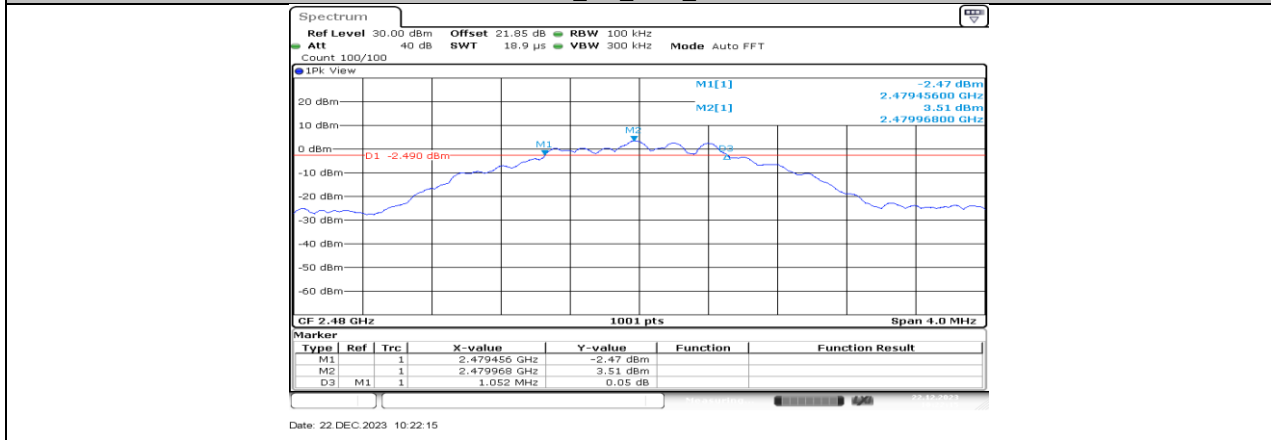

BLE\_2M\_Ant1\_2480



## 11.2. APPENDIX B: OCCUPIED CHANNEL BANDWIDTH

### 11.2.1. Test Result

Test Mode	Antenna	Frequency[MHz]	OCB [MHz]	FL[MHz]	FH[MHz]	Verdict
BLE_1M	Ant1	2402	1.123	2401.4286	2402.5514	PASS
		2440	1.123	2439.4246	2440.5475	PASS
		2480	1.135	2479.4246	2480.5594	PASS
BLE_2M	Ant1	2402	2.146	2400.9171	2403.0629	PASS
		2440	2.126	2438.9291	2441.0549	PASS
		2480	2.126	2478.9331	2481.0589	PASS

### 11.2.2. Test Graphs

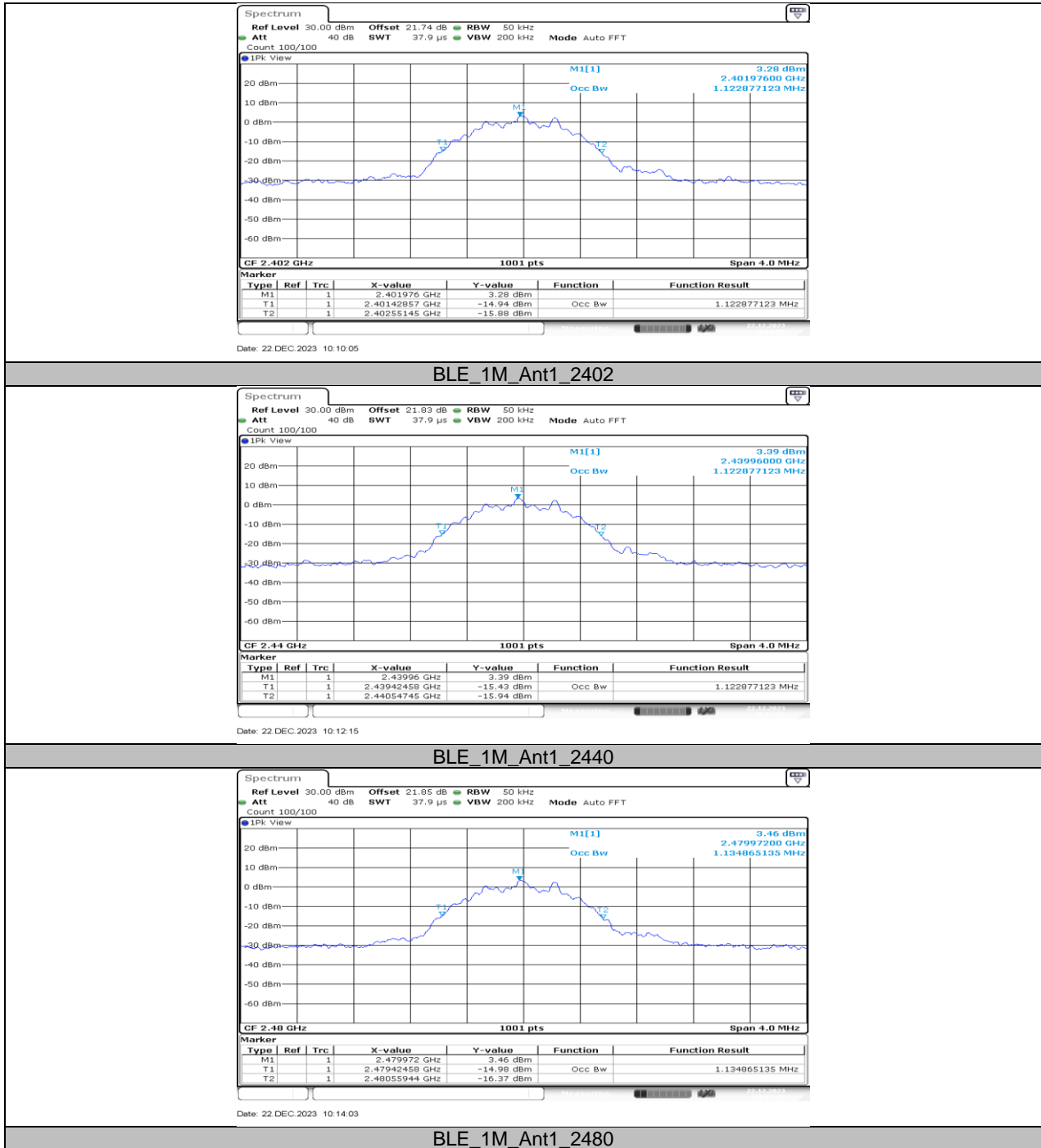

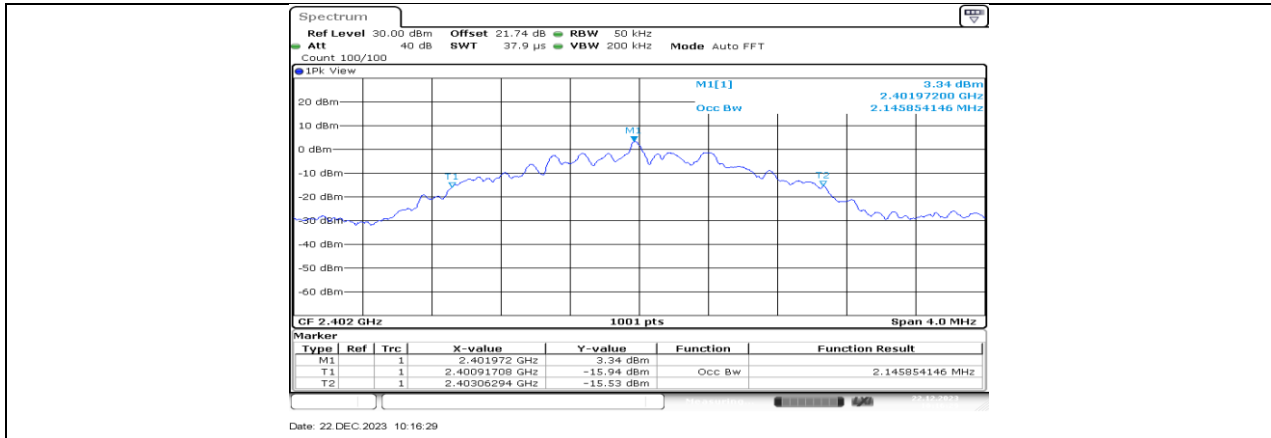

BLE\_2M\_Ant1\_2402

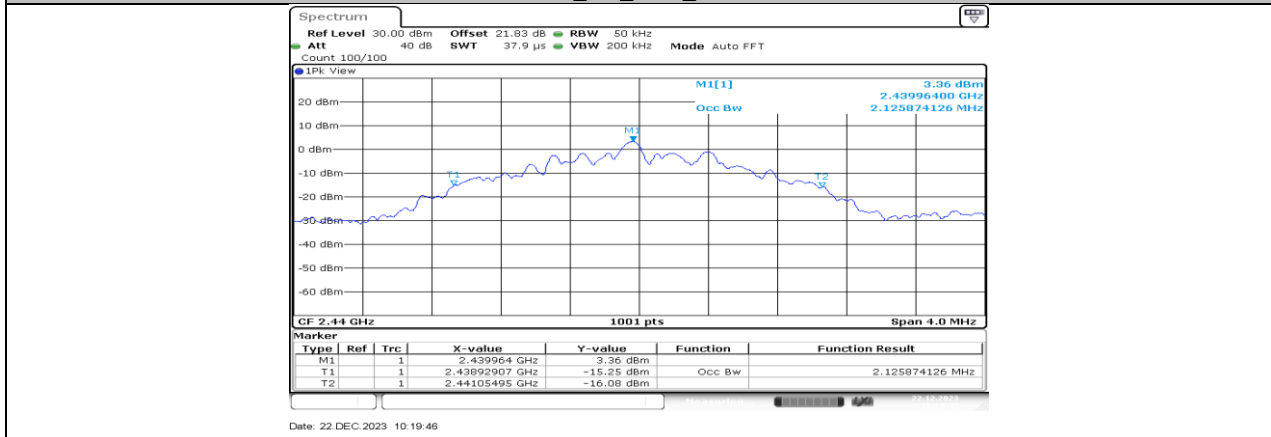

BLE\_2M\_Ant1\_2440

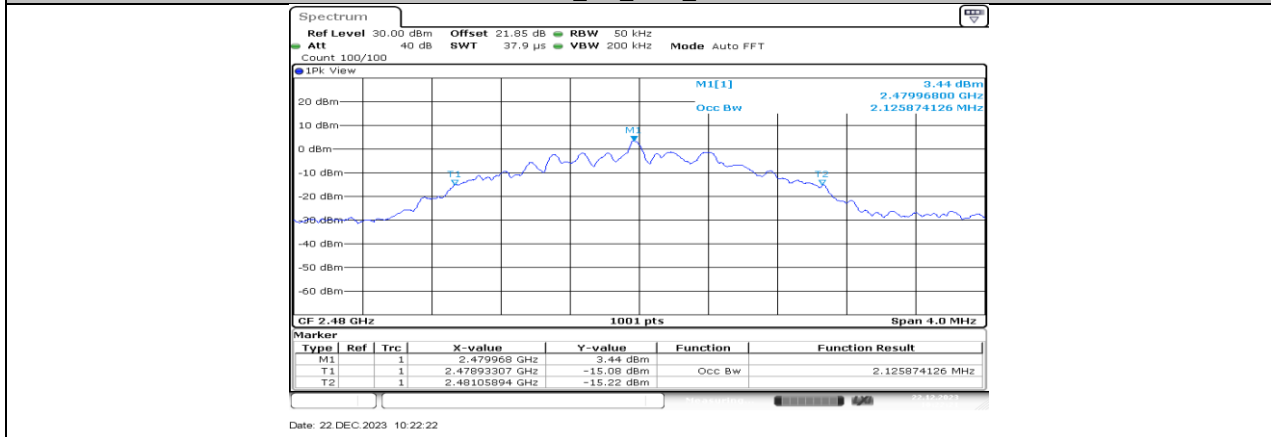

BLE\_2M\_Ant1\_2480

## 11.3. APPENDIX C: MAXIMUM CONDUCTED OUTPUT POWER

### 11.3.1. Test Result

Test Mode	Antenna	Frequency[MHz]	Result[dBm]	Limit[dBm]	Verdict
BLE_1M	Ant1	2402	4.31	≤30	PASS
		2440	3.74	≤30	PASS
		2480	3.69	≤30	PASS
BLE_2M	Ant1	2402	3.68	≤30	PASS
		2440	4.35	≤30	PASS
		2480	4.42	≤30	PASS

## 11.4. APPENDIX D: MAXIMUM POWER SPECTRAL DENSITY

### 11.4.1. Test Result

Test Mode	Antenna	Frequency[MHz]	Result[dBm/3kHz]	Limit[dBm/3kHz]	Verdict
BLE_1M	Ant1	2402	-10.07	≤8.00	PASS
		2440	-8.69	≤8.00	PASS
		2480	-8.83	≤8.00	PASS
BLE_2M	Ant1	2402	-8.61	≤8.00	PASS
		2440	-10.25	≤8.00	PASS
		2480	-8.20	≤8.00	PASS

### 11.4.2. Test Graphs

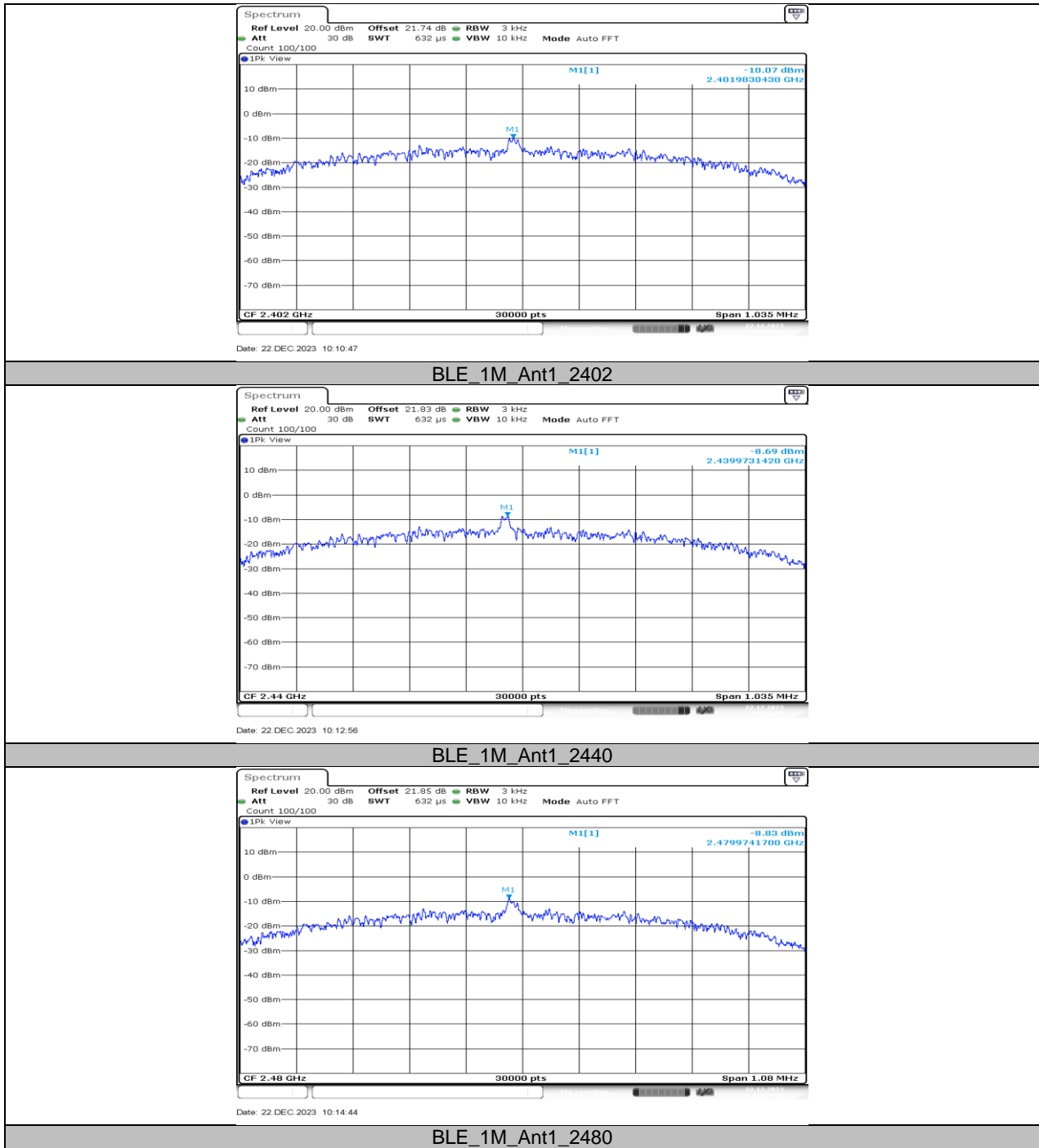

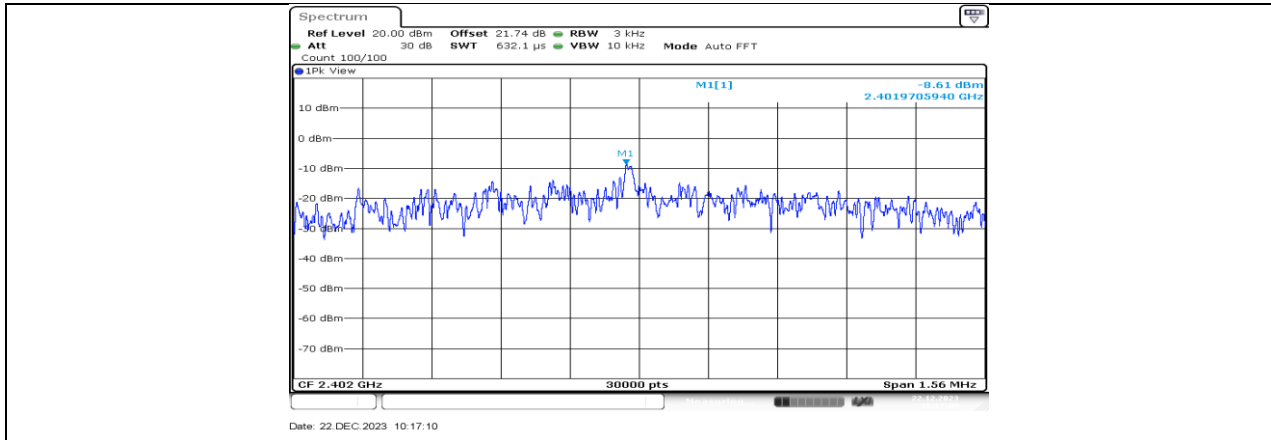

BLE\_2M\_Ant1\_2402

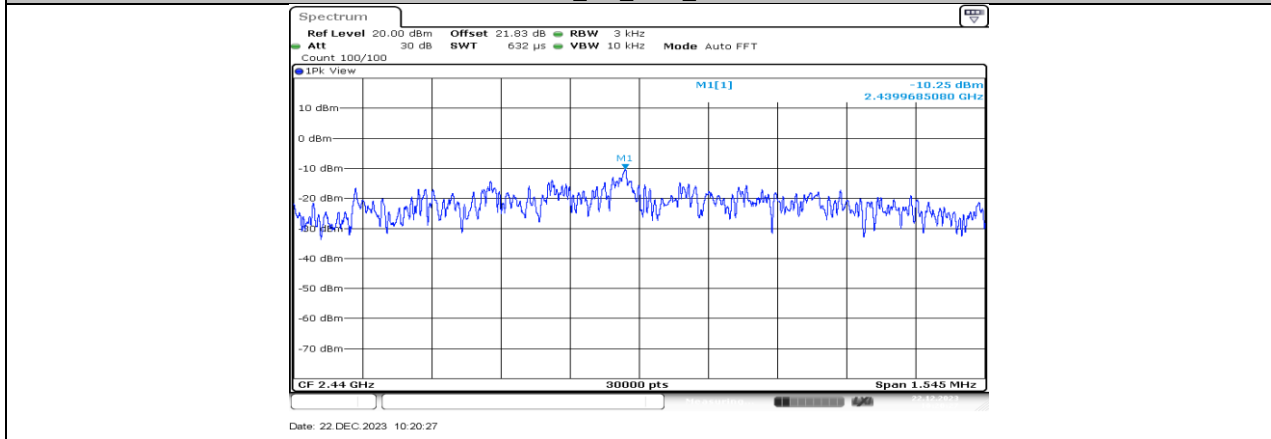

BLE\_2M\_Ant1\_2440

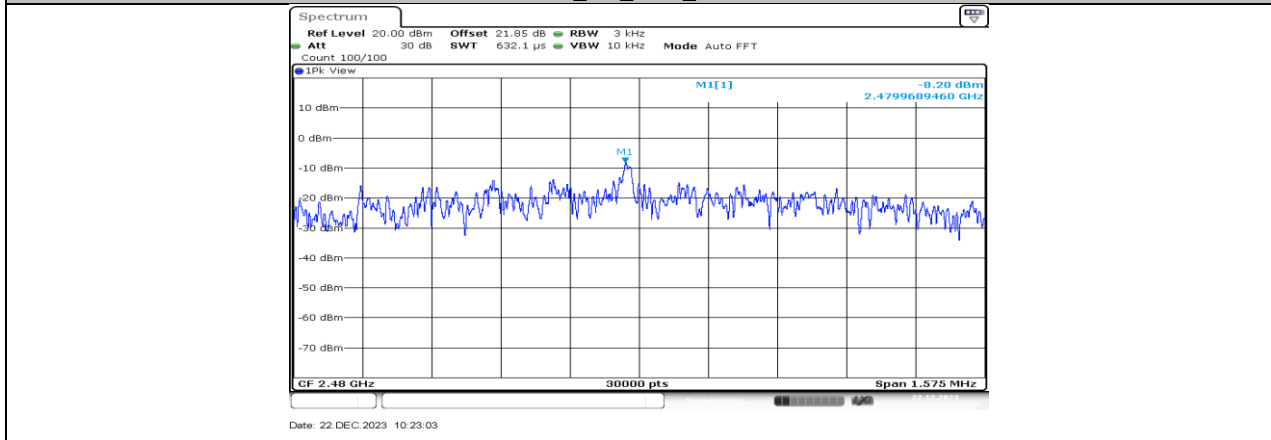

BLE\_2M\_Ant1\_2480

## 11.5. APPENDIX E: BAND EDGE MEASUREMENTS

### 11.5.1. Test Result

Test Mode	Antenna	ChName	Frequency [MHz]	RefLevel [dBm]	Result [dBm]	Limit[dBm]	Verdict
BLE_1M	Ant1	Low	2402	3.36	-33.7	≤-16.64	PASS
		High	2480	3.53	-34.71	≤-16.47	PASS
BLE_2M	Ant1	Low	2402	3.38	-30.54	≤-16.62	PASS
		High	2480	3.51	-34.22	≤-16.49	PASS



### 11.5.2. Test Graphs

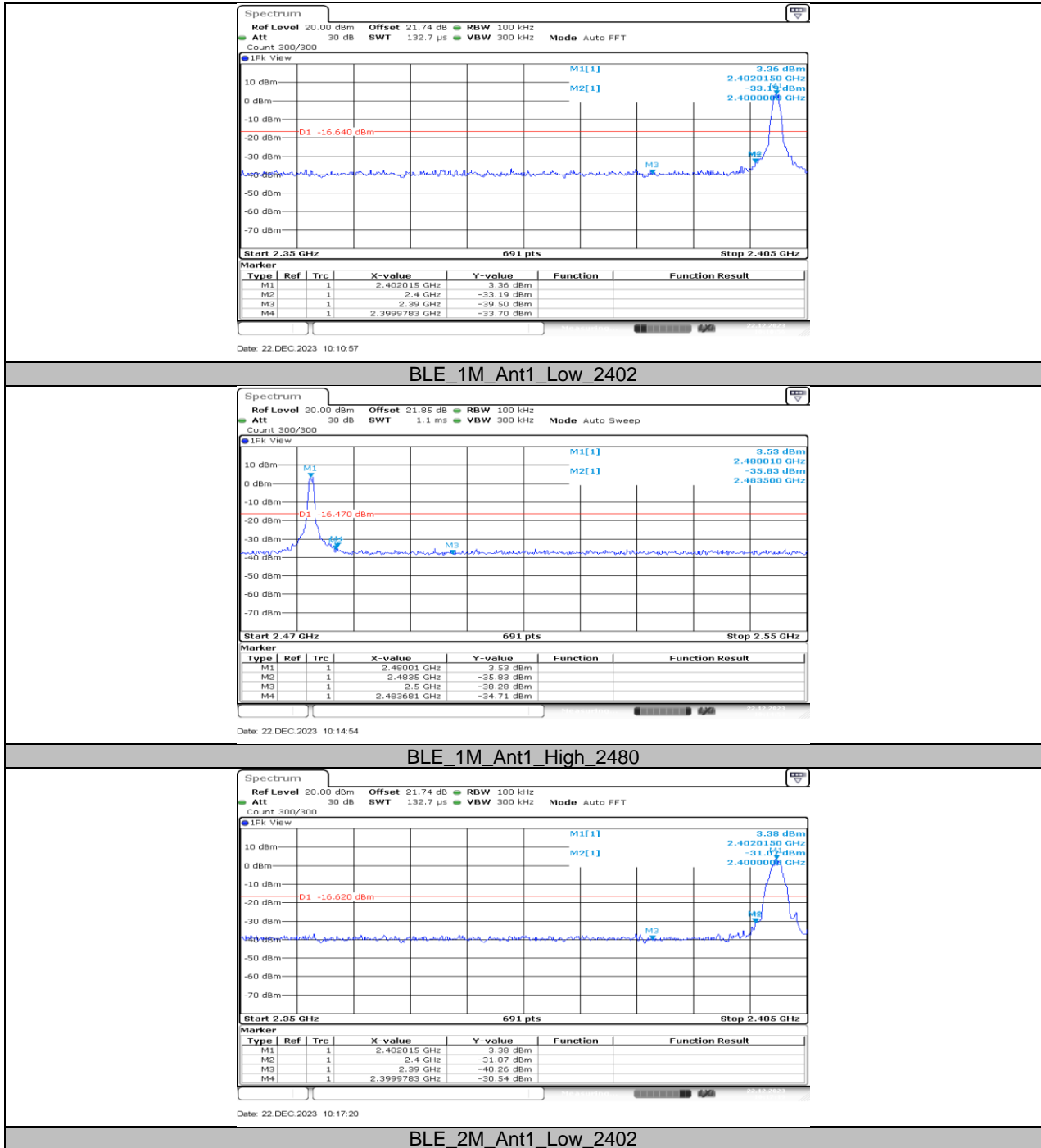

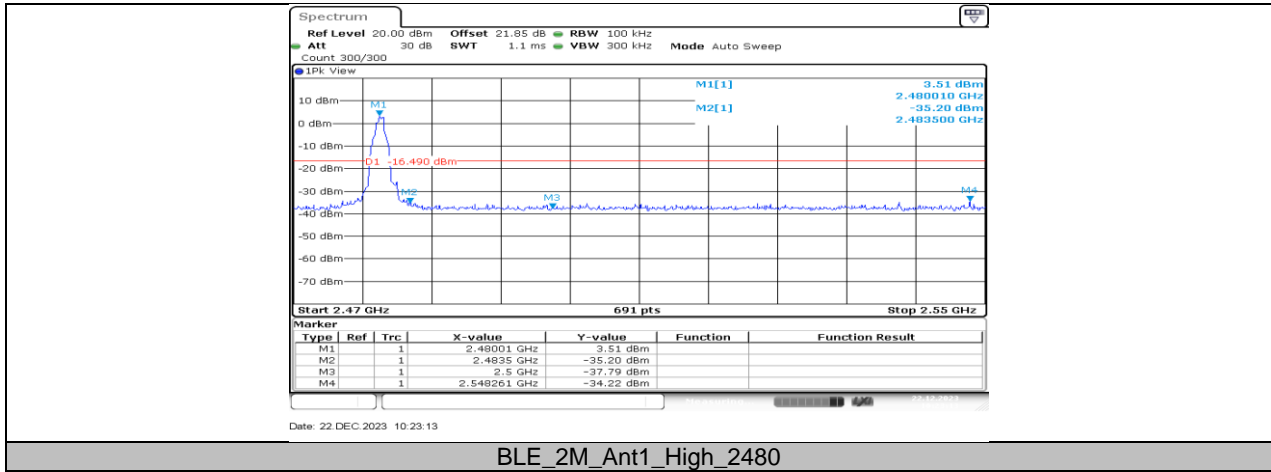

BLE\_2M\_Ant1\_High\_2480

## 11.6. APPENDIX F: CONDUCTED SPURIOUS EMISSION

### 11.6.1. Test Result

Test Mode	Antenna	Frequency [MHz]	FreqRange [MHz]	Result[dBm]	Limit[dBm]	Verdict
BLE_1M	Ant1	2402	Reference	3.36	---	PASS
			30~1000	-45.39	≤-16.64	PASS
			1000~26500	-40.24	≤-16.64	PASS
		2440	Reference	3.41	---	PASS
			30~1000	-44.59	≤-16.59	PASS
			1000~26500	-40.02	≤-16.59	PASS
		2480	Reference	3.45	---	PASS
			30~1000	-45.52	≤-16.55	PASS
			1000~26500	-39.72	≤-16.55	PASS
BLE_2M	Ant1	2402	Reference	3.36	---	PASS
			30~1000	-44.89	≤-16.64	PASS
			1000~26500	-39.13	≤-16.64	PASS
		2440	Reference	3.38	---	PASS
			30~1000	-45.24	≤-16.62	PASS
			1000~26500	-39.99	≤-16.62	PASS
		2480	Reference	3.44	---	PASS
			30~1000	-45.27	≤-16.56	PASS
			1000~26500	-40.34	≤-16.56	PASS

### 11.6.2. Test Graphs

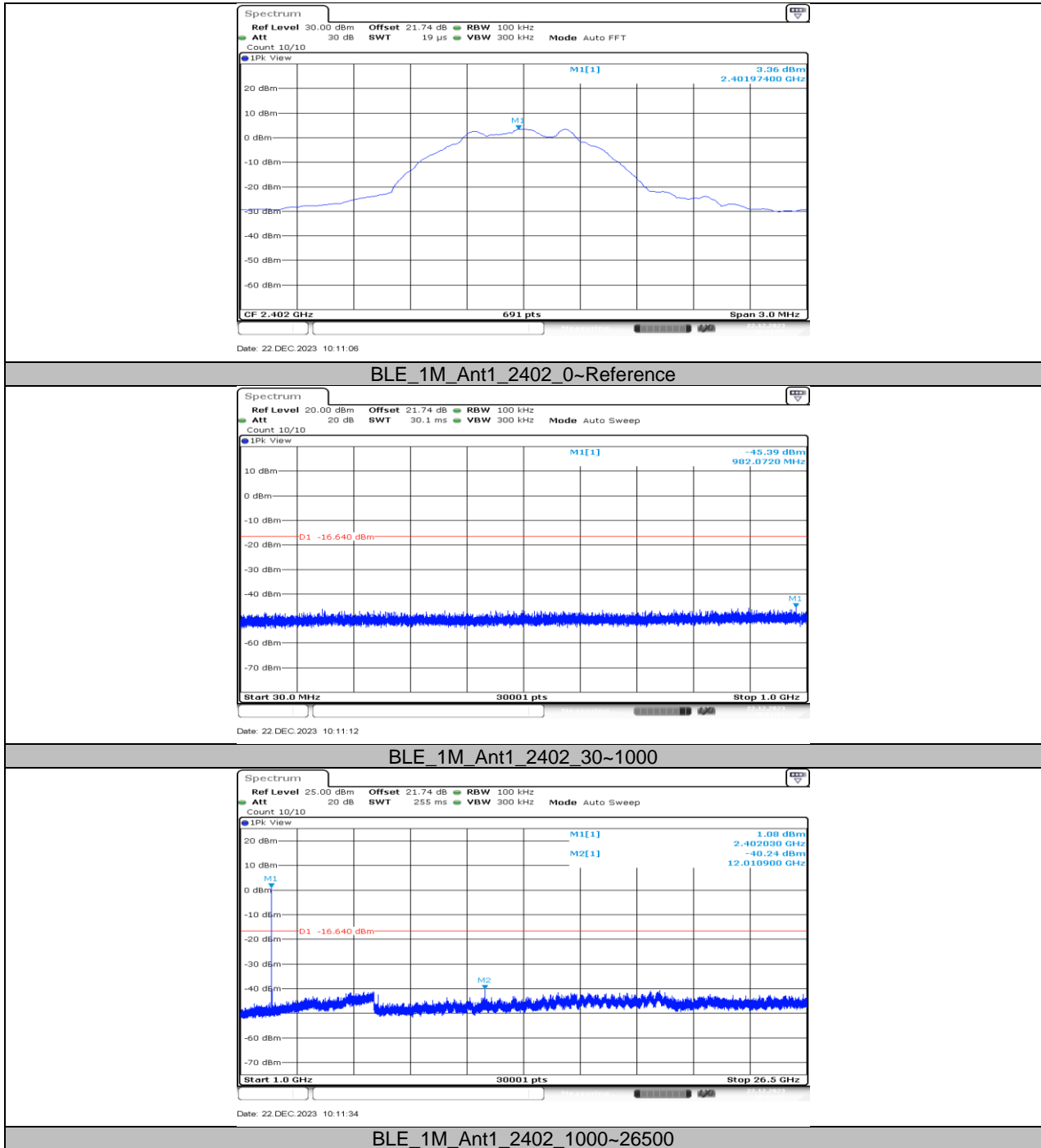

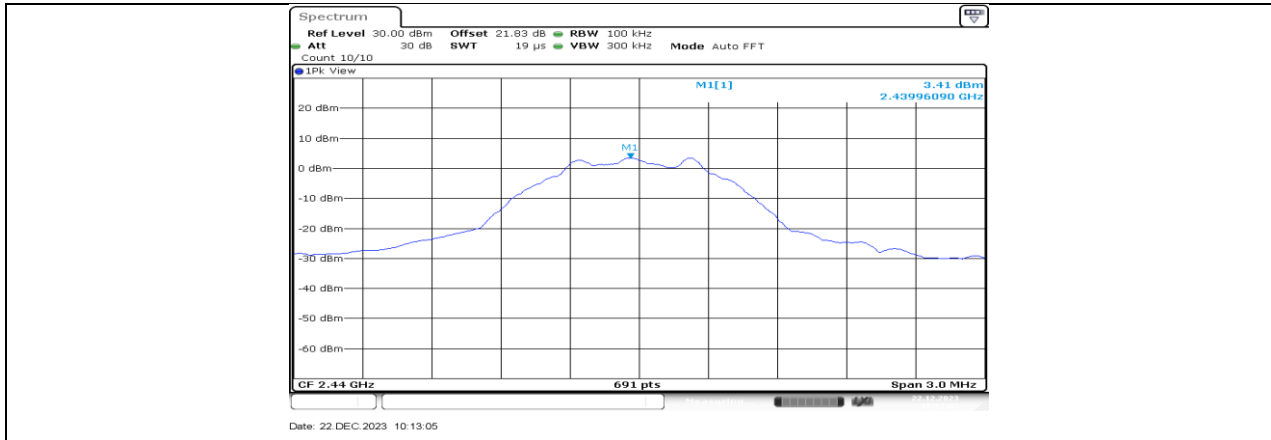

BLE\_1M\_Ant1\_2440\_0~Reference

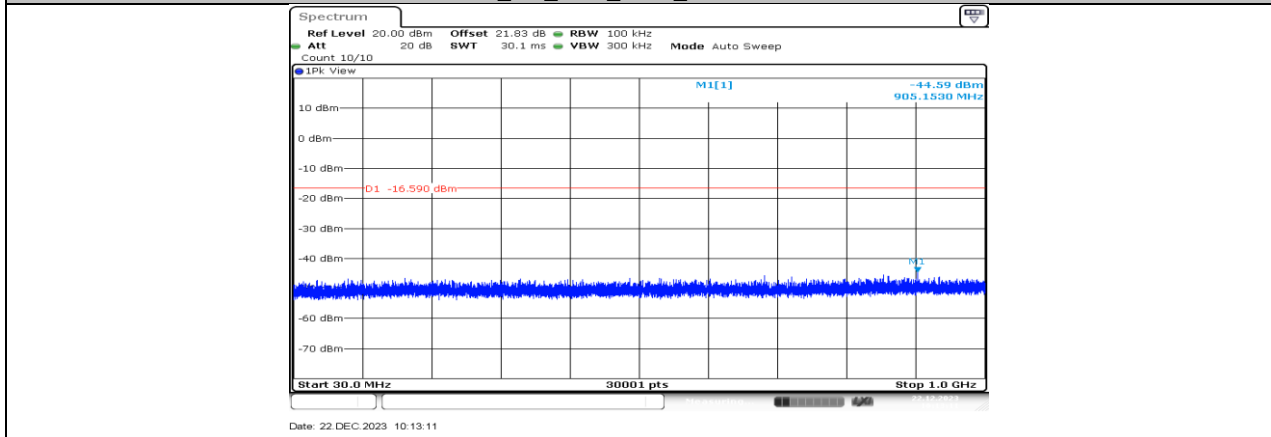

BLE\_1M\_Ant1\_2440\_30~1000

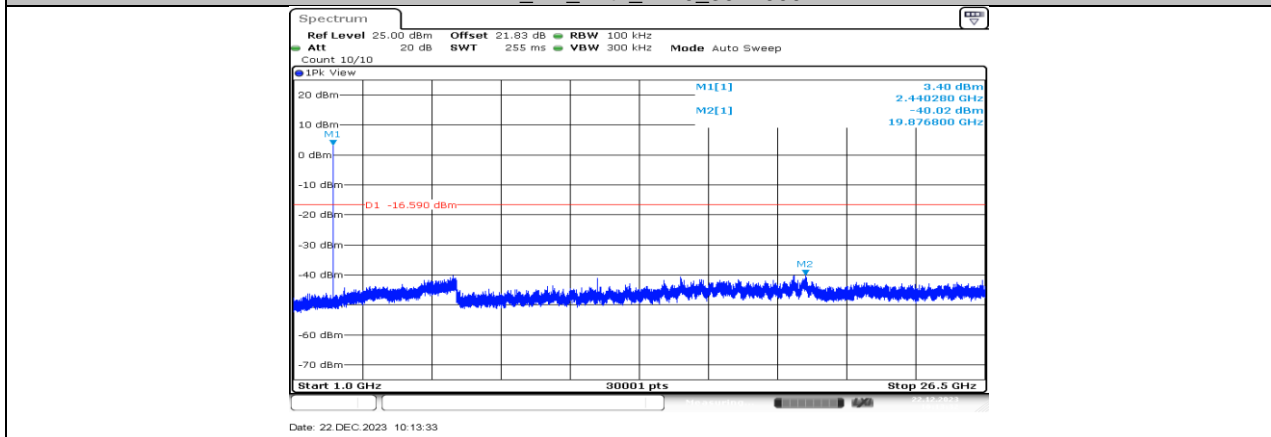

BLE\_1M\_Ant1\_2440\_1000~26500

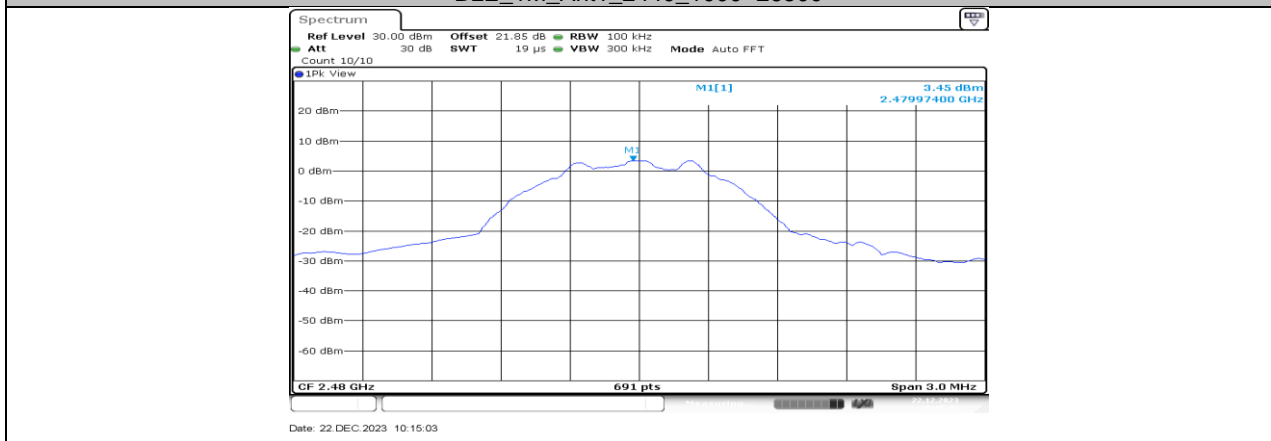

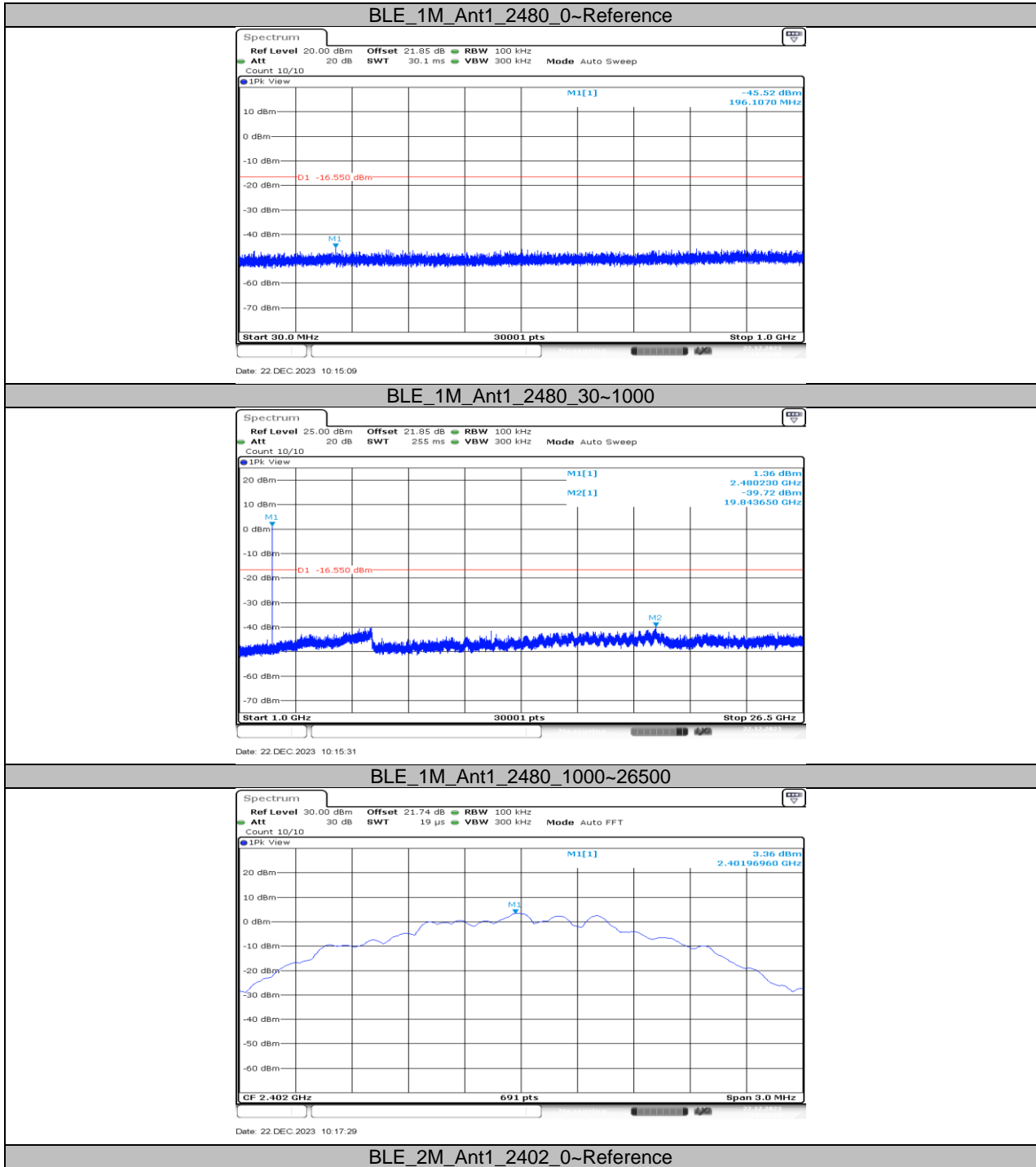

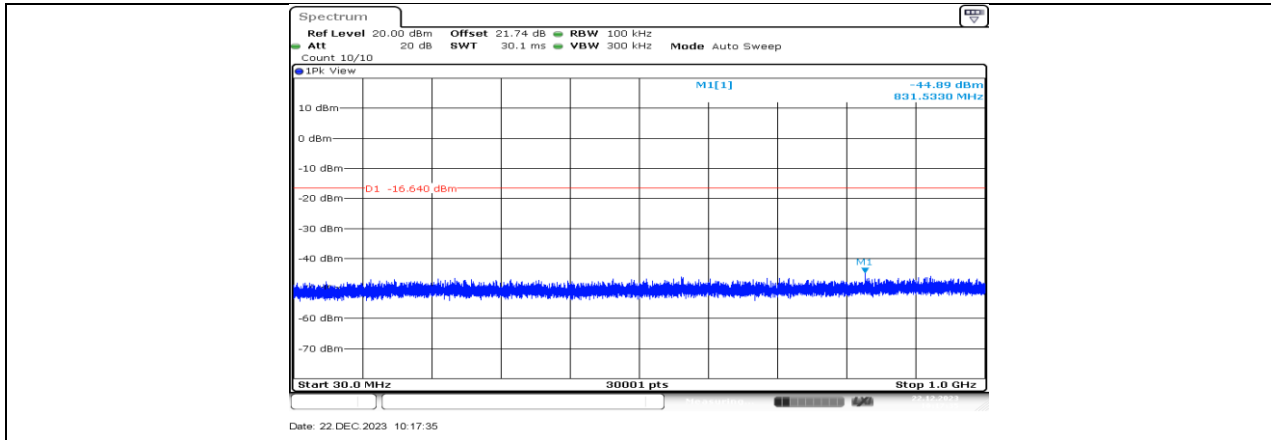

BLE\_2M\_Ant1\_2402\_30~1000

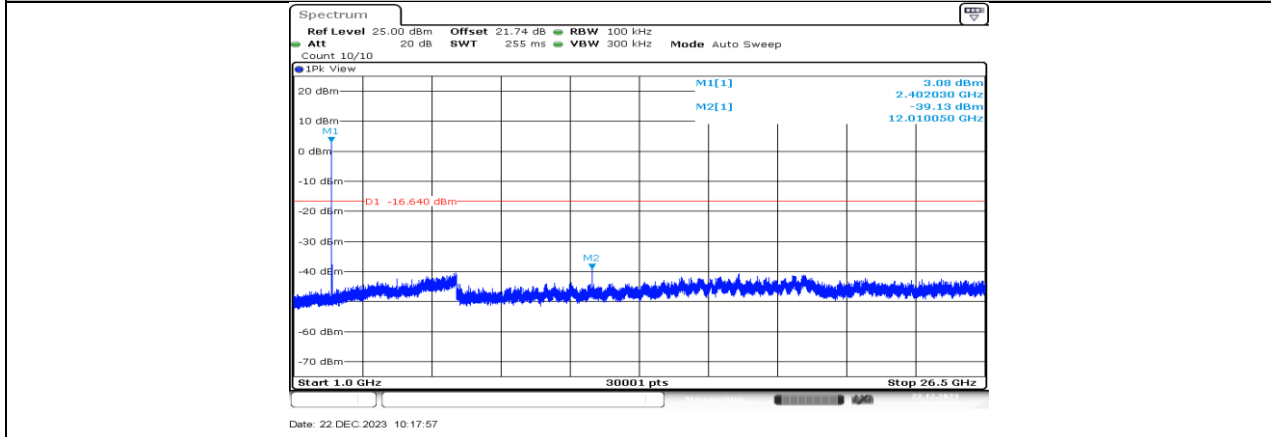

BLE\_2M\_Ant1\_2402\_1000~26500

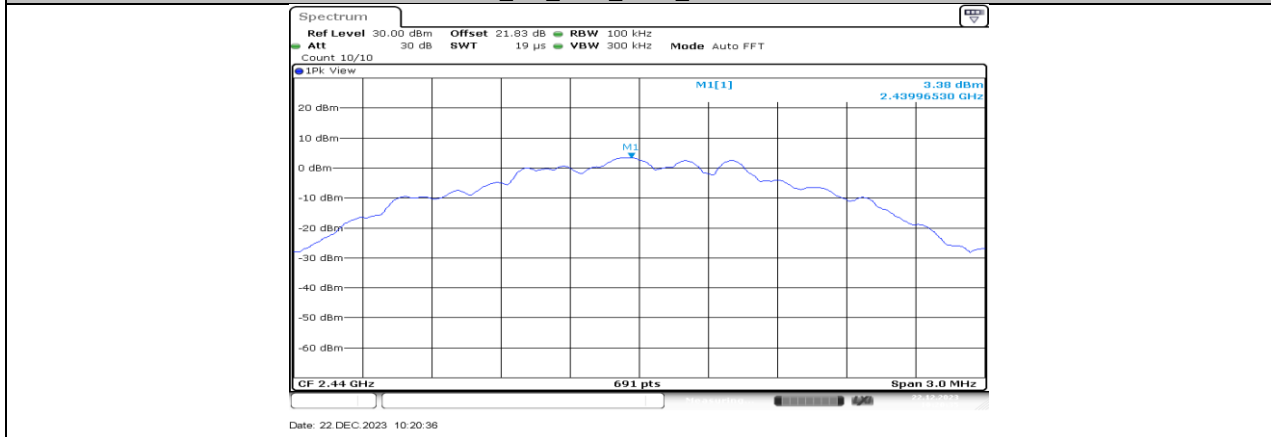

BLE\_2M\_Ant1\_2440\_0~Reference

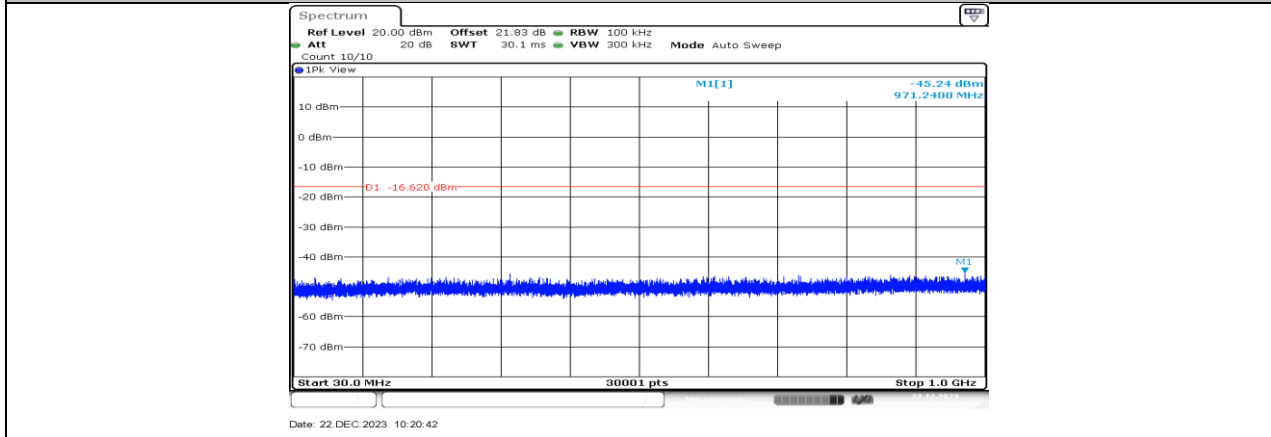

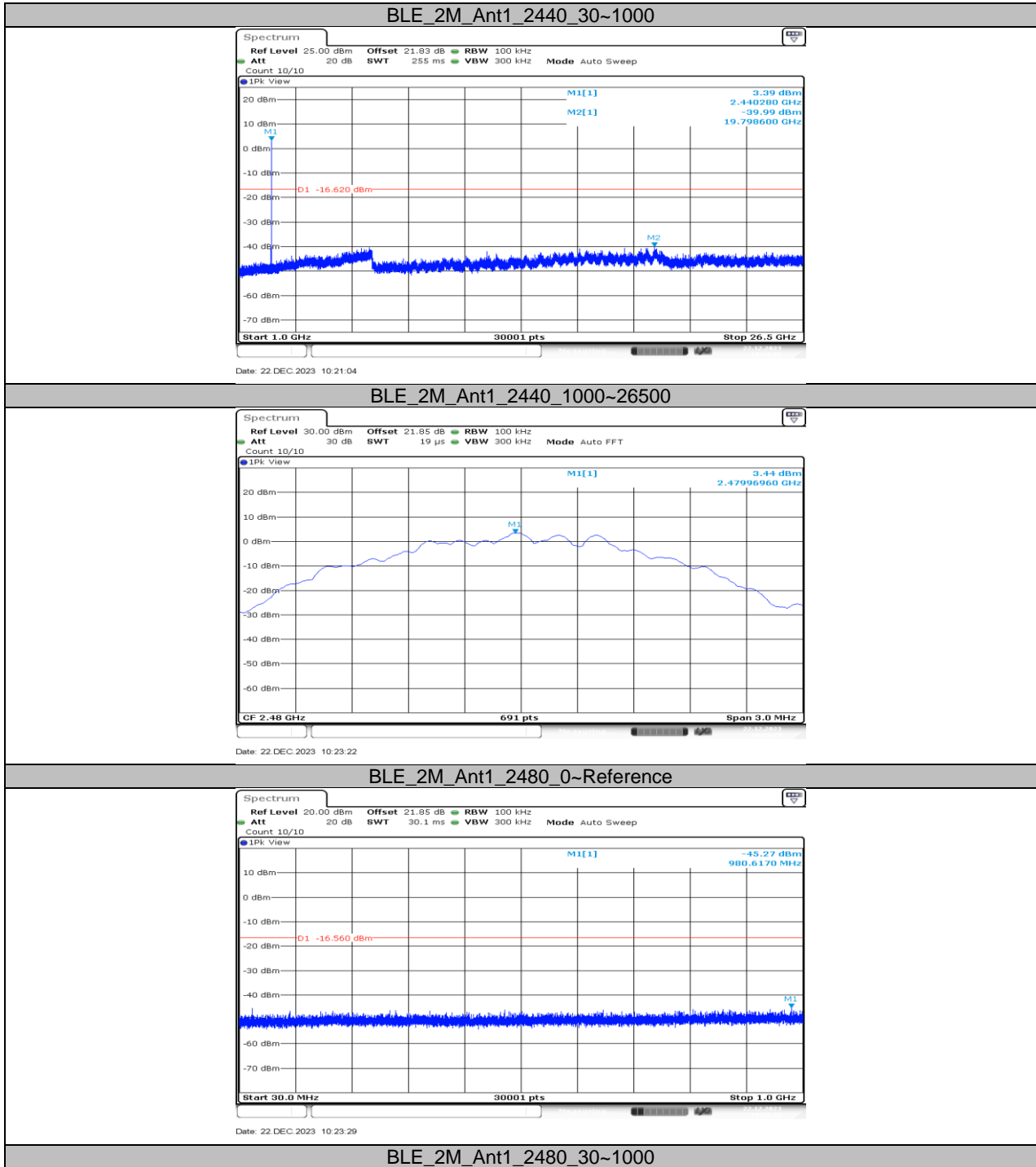



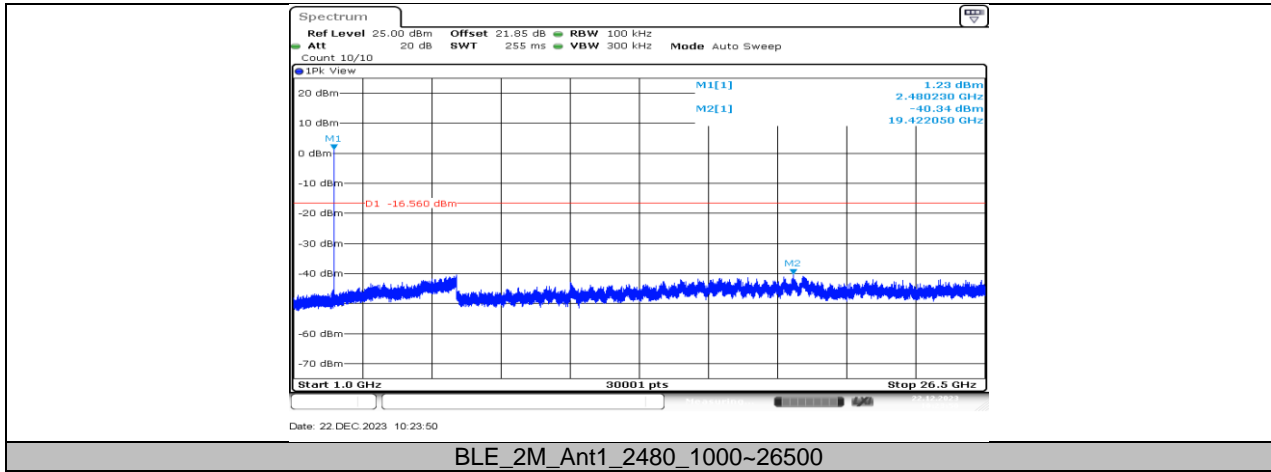

## 11.7. APPENDIX G: DUTY CYCLE

### 11.7.1. Test Result

Test Mode	On Time (msec)	Period (msec)	Duty Cycle x (Linear)	Duty Cycle (%)	Duty Cycle Correction Factor (dB)	1/T Minimum VBW (kHz)	Final setting For VBW (kHz)
BLE_1M	0.42	0.62	0.6774	67.74	1.69	2.38	3
BLE_2M	1.10	1.85	0.5946	59.46	2.26	0.91	1

Note:

Duty Cycle Correction Factor=10log (1/x).

Where: x is Duty Cycle (Linear)

Where: T is On Time

If that calculated VBW is not available on the analyzer then the next higher value should be used.

### 11.7.2. Test Graphs

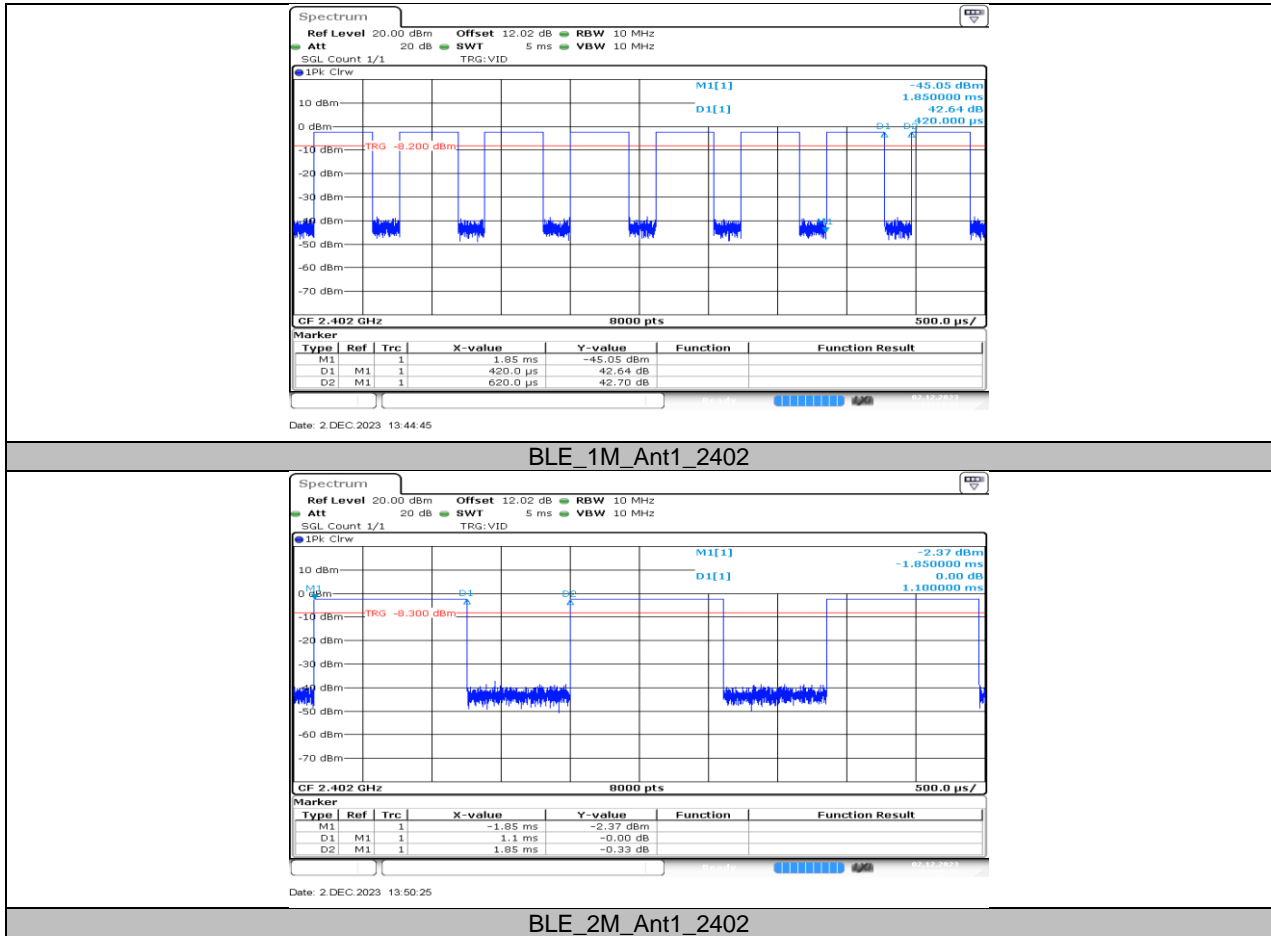

**END OF REPORT**