

MEASUREMENT REPORT

FCC PART 15.407 WLAN 802.11a/ac

FCC ID: 2ANDLTY-R8816

APPLICANT: Hangzhou Tuya Information Technology Co., Ltd

Application Type: Certification

Product: Smart Camera

Model No.: SC114-WK2

Brand Name: TUYA

FCC Classification: Unlicensed National Information Infrastructure (UNII)

FCC Rule Part(s): Part15 Subpart E (Section 15.407)

Test Procedure(s): ANSI C63.10-2013, KDB 789033 D02v02r01

Test Date: June 04 ~ July 02, 2020

Reviewed By:

Jame Yuan

(Jame Yuan)

Approved By:

Robin Wu

(Robin Wu)



The test results relate only to the samples tested.

This equipment has been shown to be capable of compliance with the applicable technical standards as indicated in the measurement report and was tested in accordance with the measurement procedures specified in KDB 789033 D02v02r01. Test results reported herein relate only to the item(s) tested.

The test report shall not be reproduced except in full without the written approval of MRT Technology (Suzhou) Co., Ltd.

Revision History

Report No.	Version	Description	Issue Date	Note
2005RSU047-U2	Rev. 01	Initial Report	07-21-2020	Valid

CONTENTS

Description	Page
General Information	6
1. INTRODUCTION	7
1.1. Scope	7
1.2. MRT Test Location	7
2. PRODUCT INFORMATION	8
2.1. Equipment Description.....	8
2.2. Product Specification Subjective to this Report.....	8
2.3. Working Frequencies for this Report.....	9
2.4. Test Mode	9
2.5. Description of Test Software	10
2.6. Duty Cycle	10
2.7. Test Configuration	12
2.8. EMI Suppression Device(s)/Modifications	12
2.9. Labeling Requirements.....	12
3. DESCRIPTION OF TEST	13
3.1. Evaluation Procedure	13
3.2. AC Line Conducted Emissions	13
3.3. Radiated Emissions.....	14
4. ANTENNA REQUIREMENTS	15
5. TEST EQUIPMENT CALIBRATION DATE	16
6. MEASUREMENT UNCERTAINTY	18
7. TEST RESULT	19
7.1. Summary	19
7.2. 26dB Bandwidth Measurement.....	20
7.2.1. Test Limit	20
7.2.2. Test Procedure Used	20
7.2.3. Test Setting.....	20
7.2.4. Test Setup	21
7.2.5. Test Result.....	22
7.3. 6dB Bandwidth Measurement.....	27
7.3.1. Test Limit	27
7.3.2. Test Procedure Used	27
7.3.3. Test Setting.....	27

7.3.4. Test Setup	27
7.3.5. Test Result.....	28
7.4. Output Power Measurement	32
7.4.1. Test Limit	32
7.4.2. Test Procedure Used	32
7.4.3. Test Setting.....	32
7.4.4. Test Setup	32
7.4.5. Test Result.....	33
7.5. Transmit Power Control	35
7.5.1. Test Limit	35
7.5.2. Test Procedure Used	35
7.5.3. Test Setting.....	35
7.5.4. Test Setup	35
7.5.5. Test Result.....	35
7.6. Power Spectral Density Measurement	36
7.6.1. Test Limit	36
7.6.2. Test Procedure Used	36
7.6.3. Test Setting.....	36
7.6.4. Test Setup	37
7.6.5. Test Result.....	38
7.7. Frequency Stability Measurement.....	44
7.7.1. Test Limit	44
7.7.2. Test Procedure Used	44
7.7.3. Test Setup	45
7.7.4. Test Result.....	46
7.8. Radiated Spurious Emission Measurement	47
7.8.1. Test Limit	47
7.8.2. Test Procedure Used	47
7.8.3. Test Setting.....	47
7.8.4. Test Setup	49
7.8.5. Test Result.....	50
7.9. Radiated Restricted Band Edge Measurement	70
7.9.1. Test Limit	70
7.9.2. Test Procedure Used	71
7.9.3. Test Setting.....	72
7.9.4. Test Setup	73
7.9.5. Test Result.....	74
7.10. AC Conducted Emissions Measurement.....	104
7.10.1. Test Limit	104

7.10.2. Test Setup	104
7.10.3. Test Result.....	105
8. CONCLUSION.....	107
Appendix A - Test Setup Photograph	108
Appendix B - EUT Photograph.....	109

General Information

Applicant:	Hangzhou Tuya Information Technology Co., Ltd
Applicant Address:	Room701, Building3, More Center, No.87 GuDun Road, Hangzhou, Zhejiang, China
Manufacturer:	Hangzhou Tuya Information Technology Co., Ltd
Manufacturer Address:	Room701, Building3, More Center, No.87 GuDun Road, Hangzhou, Zhejiang, China
Test Site:	MRT Technology (Suzhou) Co., Ltd
Test Site Address:	D8 Building, No.2 Tian'edang Rd., Wuzhong Economic Development Zone, Suzhou, China
Test Device Serial No.:	N/A <input type="checkbox"/> Production <input checked="" type="checkbox"/> Pre-Production <input type="checkbox"/> Engineering

Test Facility / Accreditations

Measurements were performed at MRT Laboratory located in Tian'edang Rd., Suzhou, China.

- MRT facility is a FCC registered (MRT Designation No. CN1166) test facility with the site description report on file and has met all the requirements specified in ANSI C63.4-2014.
- MRT facility is an IC registered (MRT Reg. No. 11384A-1) test laboratory with the site description on file at Industry Canada.
- MRT facility is a VCCI registered (R-20025, G-20034, C-20020, T-20020) test laboratory with the site description on file at VCCI Council.
- MRT Lab is accredited to ISO 17025 by the American Association for Laboratory Accreditation (A2LA) under the American Association for Laboratory Accreditation Program (A2LA Cert. No. 3628.01) in EMC, Telecommunications, Radio and SAR testing.



1. INTRODUCTION

1.1. Scope

Measurement and determination of electromagnetic emissions (EMC) of radio frequency devices including intentional and/or unintentional radiators for compliance with the technical rules and regulations of the Federal Communications Commission and the Innovation, Science and Economic Development Canada and Certification and Engineering Bureau.

1.2. MRT Test Location

The map below shows the location of the MRT LABORATORY, its proximity to the Taihu Lake. These measurement tests were conducted at the MRT Technology (Suzhou) Co., Ltd. Facility located at D8 Building, No.2 Tian'edang Rd., Wuzhong Economic Development Zone, Suzhou, China. The measurement facility compliant with the test site requirements specified in ANSI C63.4-2014.



2. PRODUCT INFORMATION

2.1. Equipment Description

Product Name:	Smart Camera
Model No.:	SC114-WK2
Brand Name:	TUYA
Wi-Fi Specification:	802.11a/b/g/n/ac
Accessories	
DC Adapter:	Model No.: KA06E-0501000US Input Power: 100 - 240V ~ 50/60Hz, 0.25A Output Power: 5Vdc 1.0A

2.2. Product Specification Subjective to this Report

Frequency Range:	For 802.11a/ac-VHT20: 5180~5240MHz, 5745~5825MHz For 802.11ac-VHT40: 5190~5230MHz, 5755~5795MHz For 802.11ac-VHT80: 5210MHz, 5775MHz
Type of Modulation:	802.11a/ac: OFDM
Data Rate:	802.11a: 6/9/12/18/24/36/48/54Mbps 802.11ac: up to 433.3Mbps
Maximum Average Output Power:	802.11a: 10.67dBm 802.11ac-VHT20: 10.52dBm 802.11ac-VHT40: 10.61dBm 802.11ac-VHT80: 9.46dBm
Antenna Type:	FPC Antenna
Antenna Gain:	3.00dBi

Note: For other features of this EUT, test report will be issued separately.

2.3. Working Frequencies for this Report

802.11a/ac-VHT20

Channel	Frequency	Channel	Frequency	Channel	Frequency
36	5180 MHz	40	5200 MHz	44	5220 MHz
48	5240 MHz	149	5745 MHz	153	5765 MHz
157	5785 MHz	161	5805 MHz	165	5825 MHz

802.11ac-VHT40

Channel	Frequency	Channel	Frequency	Channel	Frequency
38	5190 MHz	46	5230 MHz	151	5755 MHz
159	5795 MHz	--	--	--	--

802.11ac-VHT80

Channel	Frequency	Channel	Frequency	Channel	Frequency
42	5210 MHz	155	5775 MHz	--	--

2.4. Test Mode

Test Mode	Mode 1: Transmit by 802.11a (6Mbps)
	Mode 2: Transmit by 802.11ac-VHT20 (MCS0)
	Mode 3: Transmit by 802.11ac-VHT40 (MCS0)
	Mode 4: Transmit by 802.11ac-VHT80 (MCS0)

2.5. Description of Test Software

The test utility software used during testing was directive commands provided by manufacture.

2.6. Duty Cycle

5GHz (NII) operation is possible in 20MHz, 40MHz and 80MHz channel bandwidths. The maximum achievable duty cycles for all modes were determined based on measurements performed on a spectrum analyzer in zero-span mode with RBW = 8MHz, VBW = 50MHz, and detector = average per the guidance of Section B)2)b) of KDB 789033 D02v02r01. The RBW and VBW were both greater than $50/T$, where T is the minimum transmission duration, and the number of sweep points across T was greater than 100. The duty cycles are as follows:

Test Mode	Duty Cycle
802.11a	97.15%
802.11ac-VHT20	97.56%
802.11ac-VHT40	92.84%
802.11ac-VHT80	97.70%

Duty Cycle (T = Transmission Duration)

802.11a (T = 1.912ms)

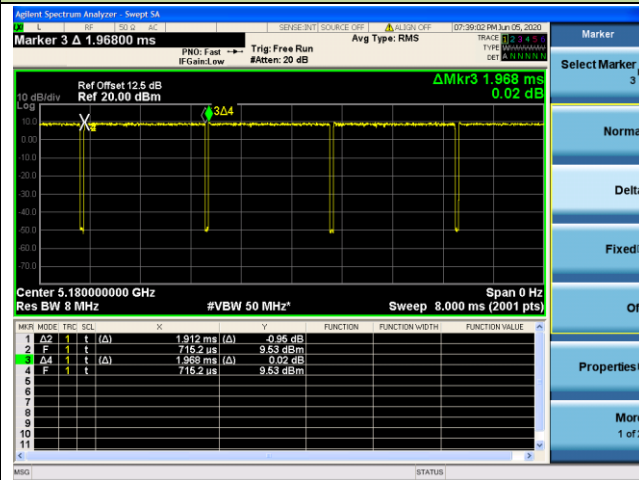

802.11ac-VHT20 (T = 1.916ms)

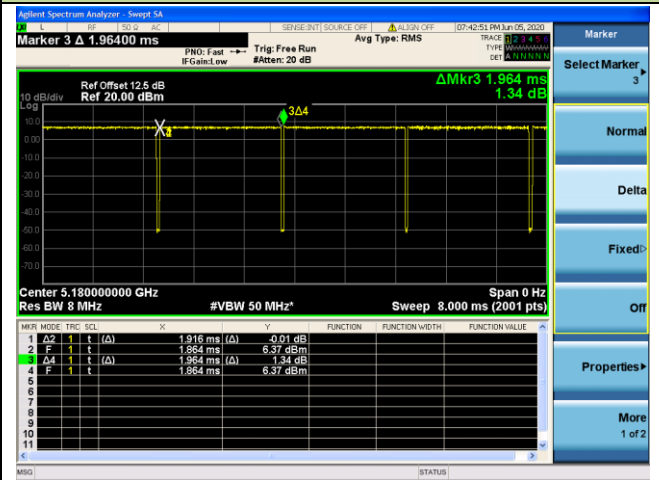

802.11ac-VHT40 (T = 938.6μs)

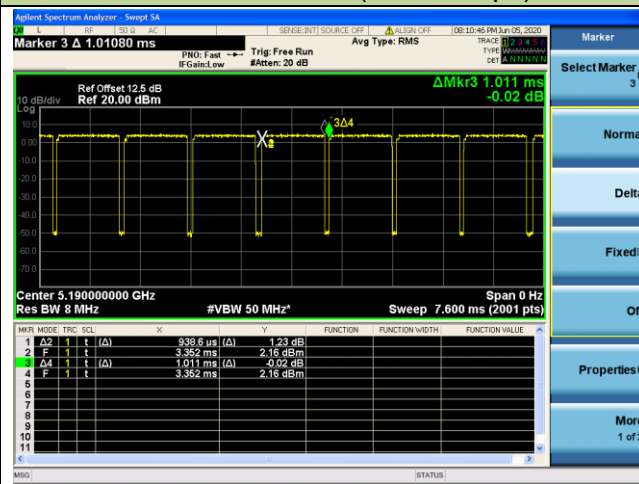

802.11ac-VHT80 (T = 1.915ms)

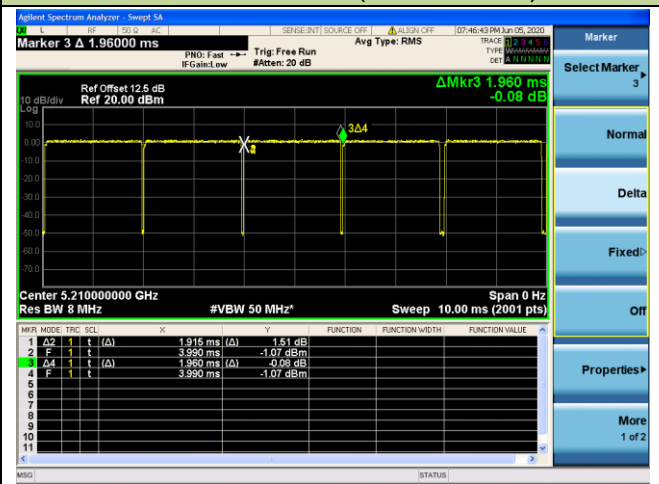

2.7. Test Configuration

The device was tested per the guidance of KDB 789033 D02v02r01. ANSI C63.10-2013 was used to reference the appropriate EUT setup for radiated spurious emissions testing and AC line conducted testing.

2.8. EMI Suppression Device(s)/Modifications

No EMI suppression device(s) were added and/or no modifications were made during testing.

2.9. Labeling Requirements

Per 2.1074 & 15.19; Docket 95-19

The label shall be permanently affixed at a conspicuous location on the device; instruction manual or pamphlet supplied to the user and be readily visible to the purchaser at the time of purchase.

However, when the device is so small wherein placement of the label with specified statement is not practical, only the FCC ID must be displayed on the device per Section 15.19(a)(5). Please see attachment for FCC ID label and label location.

3. DESCRIPTION OF TEST

3.1. Evaluation Procedure

The measurement procedures described in the American National Standard for Testing Unlicensed Wireless Devices (ANSI C63.10-2013), and the guidance provided in KDB 789033 D02v02r01 were used in the measurement.

3.2. AC Line Conducted Emissions

The line-conducted facility is located inside an 8'x4'x4' shielded enclosure. A 1m x 2m wooden table 80cm high is placed 40cm away from the vertical wall and 80cm away from the sidewall of the shielded room. Two 10kHz-30MHz, 50Ω/50uH Line-Impedance Stabilization Networks (LISNs) are bonded to the shielded room floor. Power to the LISNs is filtered by external high-current high-insertion loss power line filters. These filters attenuate ambient signal noise from entering the measurement lines. These filters are also bonded to the shielded enclosure.

The EUT is powered from one LISN and the support equipment is powered from the second LISN. All interconnecting cables more than 1 meter were shortened to a 1 meter length by non-inductive bundling (serpentine fashion) and draped over the back edge of the test table. All cables were at least 40cm above the horizontal reference ground-plane. Power cables for support equipment were routed down to the second LISN while ensuring that that cables were not draped over the second LISN.

Sufficient time for the EUT, support equipment, and test equipment was allowed in order for them to warm up to their normal operating condition. The RF output of the LISN was connected to the receiver and exploratory measurements were made to determine the frequencies producing the maximum emission from the EUT. The receiver was scanned from 150kHz to 30MHz. The detector function was set to peak mode for exploratory measurements while the bandwidth of the analyzer was set to 9kHz. The EUT, support equipment, and interconnecting cables were arranged and manipulated to maximize each emission. Each emission was also maximized by varying: power lines, the mode of operation or data exchange speed, or support equipment whichever determined the worst-case emission. Once the worst case emissions have been identified, the one EUT cable configuration/arrangement and mode of operation that produced these emissions are used for final measurements on the same test site. The analyzer is set to CISPR quasi-peak and average detectors with a 9kHz resolution bandwidth for final measurements.

An extension cord was used to connect to a single LISN which powered by EUT. The extension cord was calibrated with LISN, the impedance and insertion loss are compliance with the requirements as stated in ANSI C63.10-2013.

3.3. Radiated Emissions

The radiated test facilities consisted of an indoor 3 meter semi-anechoic chamber used for final measurements and exploratory measurements, when necessary. The measurement area is contained within the semi-anechoic chamber which is shielded from any ambient interference. For measurements above 1GHz absorbers are arranged on the floor between the turn table and the antenna mast in such a way so as to maximize the reduction of reflections. For measurements below 1GHz, the absorbers are removed. A MF Model 210SS turntable is used for radiated measurement. It is a continuously rotatable, remote controlled, metallic turntable and 2 meters (6.56 ft.) in diameter. The turn table is flush with the raised floor of the chamber in order to maintain its function as a ground plane. An 80cm high PVC support structure is placed on top of the turntable.

For all measurements, the spectrum was scanned through all EUT azimuths and from 1 to 4 meter receive antenna height using a broadband antenna from 30MHz up to the upper frequency shown in 15.33(b)(1) depending on the highest frequency generated or used in the device or on which the device operates or tunes. For frequencies above 1GHz, linearly polarized double ridge horn antennas were used. For frequencies below 30MHz, a calibrated loop antenna was used. When exploratory measurements were necessary, they were performed at 1 meter test distance inside the semi-anechoic chamber using broadband antennas, broadband amplifiers, and spectrum analyzers to determine the frequencies and modes producing the maximum emissions. Sufficient time for the EUT, support equipment, and test equipment was allowed in order for them to warm up to their normal operating condition. The test set-up for frequencies below 1GHz was placed on top of the 0.8 meter high, 1 x 1.5 meter table; and test set-up for frequencies 1-40GHz was placed on top of the 1.5 meter high, 1 x 1.5 meter table. The EUT, support equipment, and interconnecting cables were arranged and manipulated to maximize each emission. Appropriate precaution was taken to ensure that all emissions from the EUT were maximized and investigated. The system configuration, clock speed, mode of operation or video resolution, if applicable, turntable azimuth, and receive antenna height was noted for each frequency found.

Final measurements were made in the semi-anechoic chamber using calibrated, linearly polarized broadband and horn antennas. The test setup was configured to the setup that produced the worst case emissions. The spectrum analyzer was set to investigate all frequencies required for testing to compare the highest radiated disturbances with respect to the specified limits. The turntable containing the EUT was rotated through 360 degrees and the height of the receive antenna was varied 1 to 4 meters and stopped at the azimuth and height producing the maximum emission. Each emission was maximized by changing the orientation of the EUT through three orthogonal planes and changing the polarity of the receive antenna, whichever produced the worst-case emissions. According to 3dB Beam-Width of horn antenna, the horn antenna should be always directed to the EUT when rising height.

4. ANTENNA REQUIREMENTS

Excerpt from §15.203 of the FCC Rules/Regulations:

“An intentional radiator antenna shall be designed to ensure that no antenna other than that furnished by the responsible party can be used with the device. The use of a permanently attached antenna or of an antenna that uses a unique coupling to the intentional radiator shall be considered sufficient to comply with the provisions of this section.”

- The antenna of the **device** is **permanently attached**.
- There are no provisions for connection to an external antenna.

Conclusion:

The unit complies with the requirement of §15.203.

5. TEST EQUIPMENT CALIBRATION DATE

Conducted Emission - SR2

Instrument	Manufacturer	Type No.	Asset No.	Cali. Interval	Cali. Due Date
EMI Test Receiver	R&S	ESR3	MRTSUE06185	1 year	2021/01/18
Two-Line V-Network	R&S	ENV 216	MRTSUE06002	1 year	2021/06/11
Two-Line V-Network	R&S	ENV 216	MRTSUE06003	1 year	2021/06/11
Thermohygrometer	testo	608-H1	MRTSUE06404	1 year	2020/08/08
Shielding Room	MIX-BEP	Chamber-SR2	MRTSUE06215	N/A	N/A

Radiated Emission - AC1

Instrument	Manufacturer	Type No.	Asset No.	Cali. Interval	Cali. Due Date
EMI Test Receiver	R&S	ESR7	MRTSUE06001	1 year	2021/01/18
PXA Signal Analyzer	Keysight	N9030B	MRTSUE06395	1 year	2020/09/03
Loop Antenna	Schwarzbeck	FMZB 1519	MRTSUE06025	1 year	2020/11/13
Bilog Period Antenna	Schwarzbeck	VULB 9168	MRTSUE06172	1 year	2021/04/03
Horn Antenna	Schwarzbeck	BBHA 9120D	MRTSUE06023	1 year	2020/10/13
Horn Antenna	Schwarzbeck	BBHA9170	MRTSUE06597	1 year	2020/12/17
Microwave System Amplifier	Agilent	83017A	MRTSUE06076	1 year	2020/11/15
Preamplifier	Schwarzbeck	BBV 9721	MRTSUE06121	1 year	2020/06/11
Thermohygrometer	Testo	608-H1	MRTSUE06403	1 year	2020/08/08
Anechoic Chamber	TDK	Chamber-AC1	MRTSUE06212	1 year	2021/04/30

Radiated Emission - AC2

Instrument	Manufacturer	Type No.	Asset No.	Cali. Interval	Cali. Due Date
MXE EMI Receiver	Keysight	N9038A	MRTSUE06125	1 year	2020/08/01
Loop Antenna	Schwarzbeck	FMZB 1519	MRTSUE06025	1 year	2020/11/13
Bilog Period Antenna	Schwarzbeck	VULB 9162	MRTSUE06022	1 year	2020/10/13
Broad-Band Horn Antenna	Schwarzbeck	BBHA 9120D	MRTSUE06171	1 year	2020/10/27
Horn Antenna	Schwarzbeck	BBHA9170	MRTSUE06597	1 year	2020/12/17
Broadband Coaxial Preamplifier	Schwarzbeck	BBV 9718	MRTSUE06176	1 year	2020/11/15
Preamplifier	Schwarzbeck	BBV 9721	MRTSUE06121	1 year	2020/06/11
Temperature/Humidity Meter	Minggao	ETH529	MRTSUE06170	1 year	2020/12/15
Anechoic Chamber	RIKEN	Chamber-AC2	MRTSUE06213	1 year	2021/04/30

Conducted Test Equipment - TR3

Instrument	Manufacturer	Type No.	Asset No.	Cali. Interval	Cali. Due Date
EXA Signal Analyzer	Agilent	N9020A	MRTSUE06106	1 year	2021/04/14
EXA Signal Analyzer	Keysight	N9010B	MRTSUE06607	1 year	2021/01/08
Signal Analyzer	R&S	FSV40	MRTSUE06218	1 year	2021/04/14
Power Meter	Agilent	U2021XA	MRTSUE06030	1 year	2020/11/18
USB wideband power sensor	Keysight	U2021XA	MRTSUE06446	1 year	2021/06/11
USB wideband power sensor	Keysight	U2021XA	MRTSUE06447	1 year	2021/06/11
Bluetooth Test Set	Anritsu	MT8852B-042	MRTSUE06389	1 year	2021/06/11
Audio Analyzer	Agilent	U8903B	MRTSUE06143	1 year	2021/06/11
Modulation Analyzer	HP	HP8901A	MRTSUE06098	1 year	2020/10/10
Wideband Radio Communication Tester	R&S	CMW 500	MRTSUE06243	1 year	2020/11/07
DC Power Supply	GWINSTEK	DPS-3303C	MRTSUE06064	N/A	N/A
Temperature & Humidity Chamber	BAOYT	BYH-150CL	MRTSUE06051	1 year	2020/11/07
Thermohygrometer	Testo	608-H1	MRTSUE06401	1 year	2020/08/08

Software	Version	Function
EMI Software	V3	EMI Test Software

6. MEASUREMENT UNCERTAINTY

Where relevant, the following test uncertainty levels have been estimated for tests performed on the EUT as specified in CISPR 16-4-2. This uncertainty represents an expanded uncertainty expressed at approximately the 95% confidence level using a coverage factor of $k = 2$.

Conducted Emission Measurement

The maximum measurement uncertainty is evaluated as:

9kHz~150kHz: 3.74dB

150kHz~30MHz: 3.44dB

Radiated Emission Measurement

The maximum measurement uncertainty is evaluated as:

Horizontal: 30MHz~300MHz: 5.04dB

300MHz~1GHz: 4.95dB

1GHz~18GHz: 6.40dB

Vertical: 30MHz~300MHz: 5.24dB

300MHz~1GHz: 6.03dB

1GHz~18GHz: 6.40dB

7. TEST RESULT

7.1. Summary

FCC Section(s)	Test Description	Test Limit	Test Condition	Test Result	Reference
15.407(a)	26dB Bandwidth	N/A	Conducted	Pass	Section 7.2
15.407(e)	6dB Bandwidth	$\geq 500\text{kHz}$		Pass	Section 7.3
15.407(a)(1)(iv), (2), (3)	Maximum Conducted Output Power	U-NII-1: $\leq 250\text{mW}$ U-NII-2: $\leq 250\text{mW}$ or $11 + 10\log_{10} B$ U-NII-3: $\leq 1\text{W}$		Pass	Section 7.4
15.407(h)(1)	Transmit Power Control	$\leq 24\text{dBm}$		Pass	Section 7.5
15.407(a)(1)(iv), (2), (3), (5)	Peak Power Spectral Density	U-NII-1 & U-NII-2: $\leq 11\text{dBm/MHz}$ U-NII-3: $\leq 30\text{dBm}/500\text{kHz}$		Pass	Section 7.6
15.407(g)	Frequency Stability	N/A		Pass	Section 7.7
15.407(b)(1), (2), (3), (4)(i)	Undesirable Emissions	Detail see section 7.9	Radiated	Pass	Section 7.8 Section 7.9
15.205, 15.209 15.407(b)(5), (6), (7)	General Field Strength Limits (Restricted Bands and Radiated Emission Limits)	Emissions in restricted bands must meet the radiated limits detailed in 15.209		Pass	
15.207	AC Conducted Emissions 150kHz-30MHz	$< \text{FCC } 15.207 \text{ limits}$	Line Conducted	Pass	Section 7.10

Notes:

- The analyzer plots shown in this section were all taken with a correction table loaded into the analyzer. The correction table was used to account for the losses of the cables and attenuators used as part of the system to connect the EUT to the analyzer at all frequencies of interest.
- All modes of operation and data rates were investigated. For radiated emission test, every axis (X, Y, Z) was also verified. The test results shown in the following sections represent the worst case emissions.

7.2. 26dB Bandwidth Measurement

7.2.1. Test Limit

N/A

7.2.2. Test Procedure Used

KDB 789033 D02v02r01 - Section C.1 (26dB Bandwidth)

KDB 789033 D02v02r01 - Section D (99% Bandwidth)

7.2.3. Test Setting

26dB Bandwidth:

1. Set RBW = approximately 1% of the emission bandwidth.
2. Set the VBW > RBW.
3. Detector = Peak.
4. Trace mode = max hold.
5. Measure the maximum width of the emission that is 26 dB down from the maximum of the emission. Compare this with the RBW setting of the analyzer. Readjust RBW and repeat measurement as needed until the RBW/EBW ratio is approximately 1%.

99% Bandwidth:

1. Set center frequency to the nominal EUT channel center frequency.
2. Set span = 1.5 times to 5.0 times the OBW.
3. Set RBW = 1% to 5% of the OBW
4. Set VBW $\geq 3 \cdot$ RBW.
5. Video averaging is not permitted. Where practical, a sample detection and single sweep mode shall be used. Otherwise, peak detection and max hold mode (until the trace stabilizes) shall be used.
6. Use the 99% power bandwidth function of the instrument (if available).
7. If the instrument does not have a 99% power bandwidth function, the trace data points are recovered and directly summed in power units. The recovered amplitude data points, beginning

at the lowest frequency, are placed in a running sum until 0.5% of the total is reached; that frequency is recorded as the lower frequency. The process is repeated until 99.5% of the total is reached; that frequency is recorded as the upper frequency. The 99% occupied bandwidth is the difference between these two frequencies.

7.2.4. Test Setup

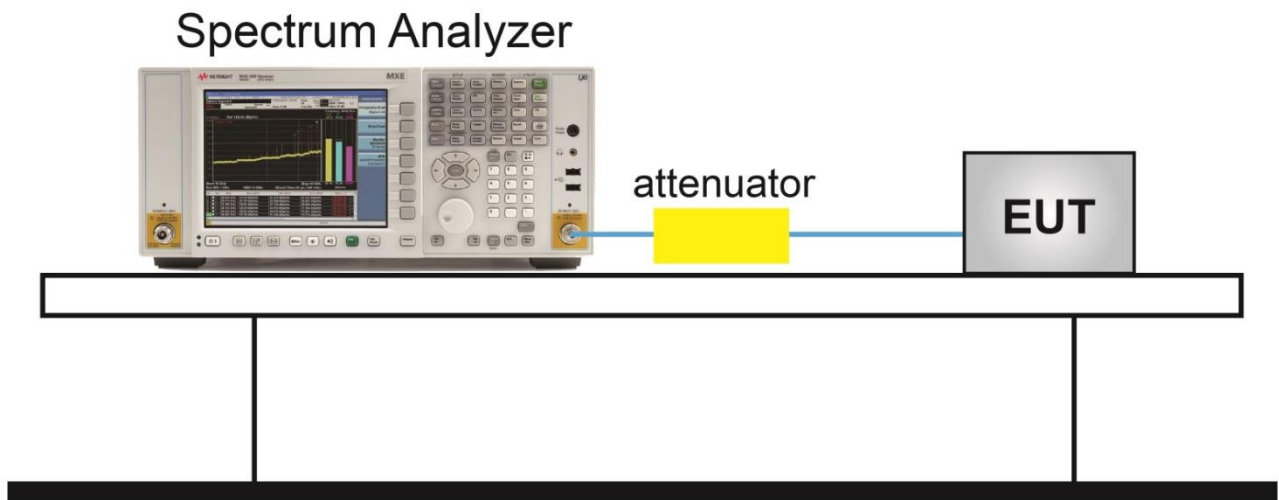

7.2.5. Test Result

Product	Smart Camera	Temperature	27°C
Test Engineer	Amy Zhang	Relative Humidity	47%
Test Site	TR3	Test Date	2020/06/06

Test Mode	Data Rate/ MCS	Channel No.	Frequency (MHz)	26dB Bandwidth (MHz)	99% Bandwidth (MHz)
802.11a	6Mbps	36	5180	39.73	19.92
802.11a	6Mbps	44	5220	39.67	19.59
802.11a	6Mbps	48	5240	38.65	19.99
802.11a	6Mbps	149	5745	39.97	19.88
802.11a	6Mbps	157	5785	39.92	19.57
802.11a	6Mbps	165	5825	39.10	19.75
802.11ac-VHT20	MCS0	36	5180	37.90	19.61
802.11ac-VHT20	MCS0	44	5220	40.00	19.89
802.11ac-VHT20	MCS0	48	5240	39.15	19.81
802.11ac-VHT20	MCS0	149	5745	39.13	19.80
802.11ac-VHT20	MCS0	157	5785	39.71	19.98
802.11ac-VHT20	MCS0	165	5825	40.00	19.48
802.11ac-VHT40	MCS0	38	5190	77.70	39.87
802.11ac-VHT40	MCS0	46	5230	78.26	39.19
802.11ac-VHT40	MCS0	151	5755	76.49	39.85
802.11ac-VHT40	MCS0	159	5795	79.54	39.83
802.11ac-VHT80	MCS0	42	5210	148.90	77.15
802.11ac-VHT80	MCS0	155	5775	154.00	78.65

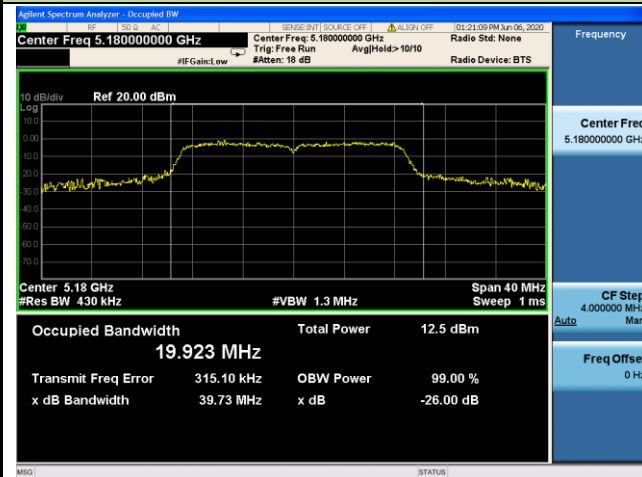
802.11a 26dB Bandwidth & 99% Bandwidth
Channel 36 (5180MHz)

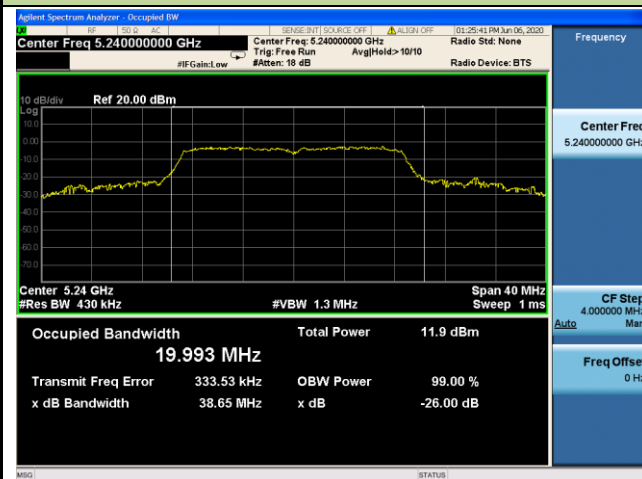
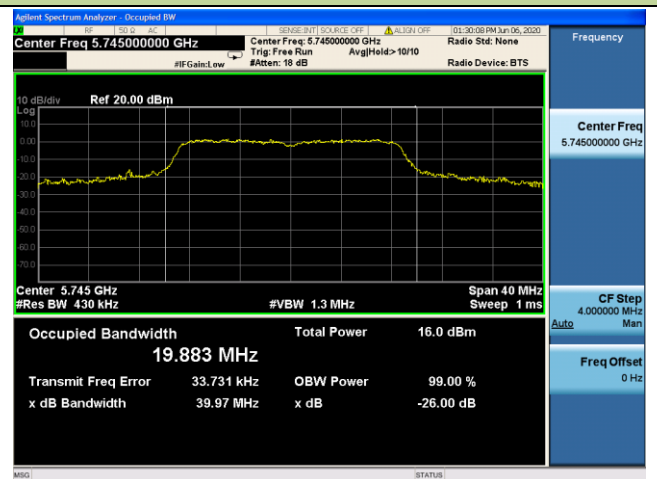
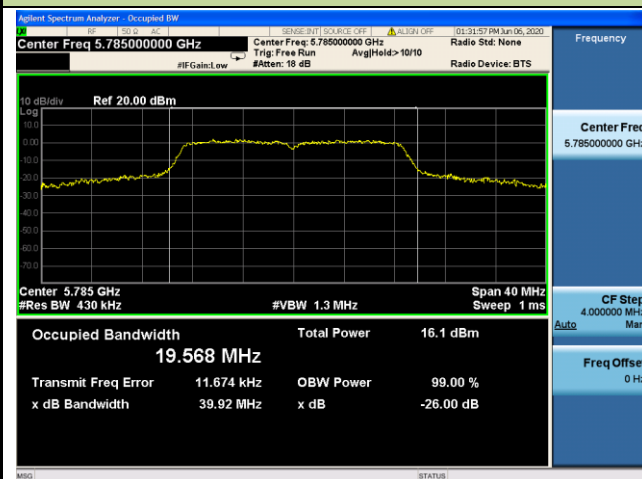
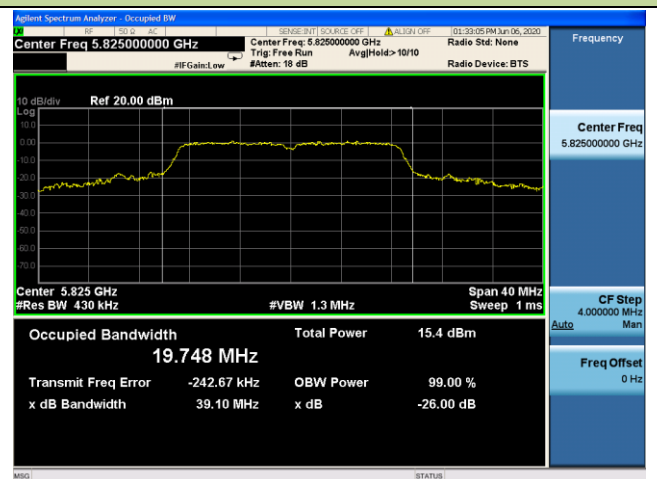
Channel 44 (5220MHz)

Channel 48 (5240MHz)

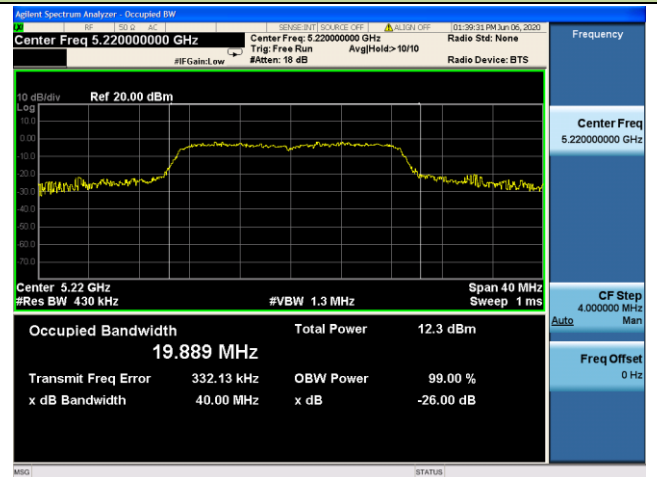
Channel 149 (5745MHz)

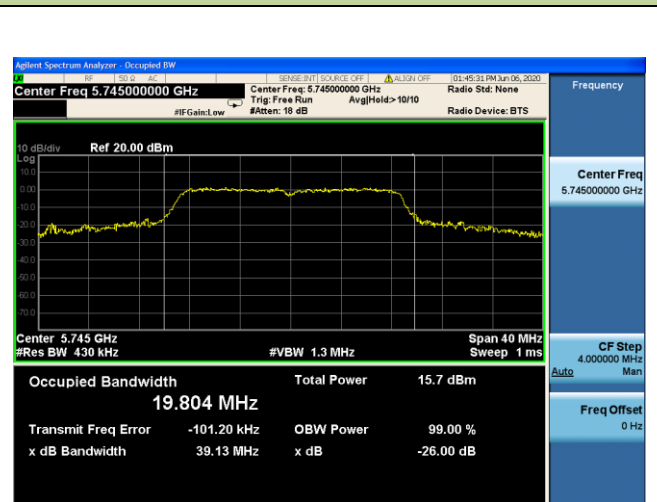
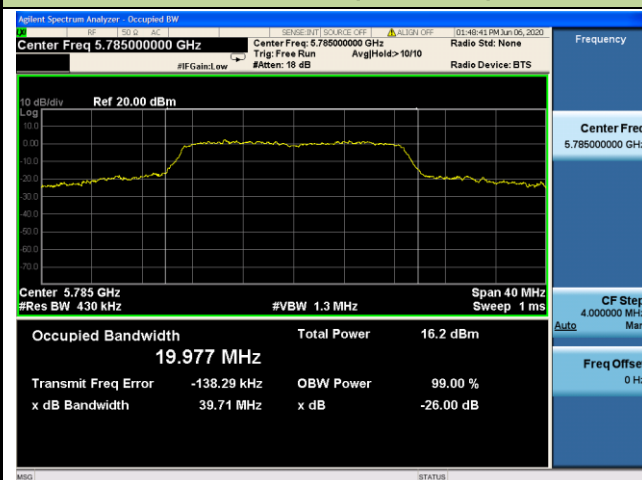
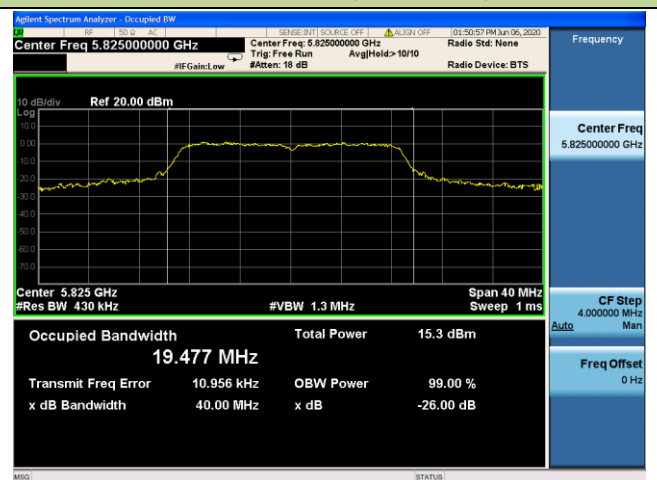
Channel 157 (5785MHz)

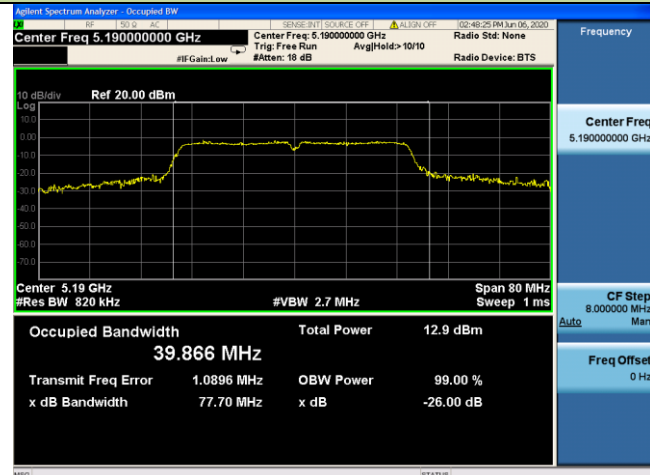
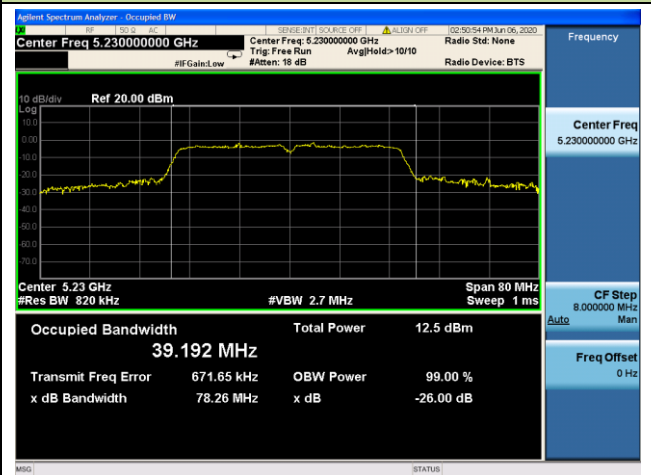
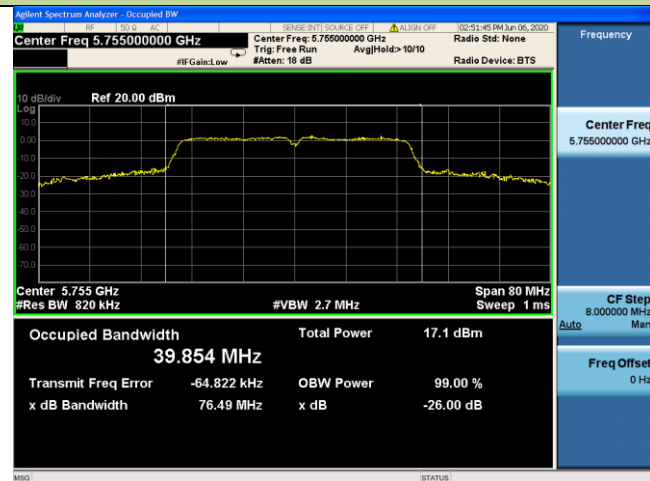
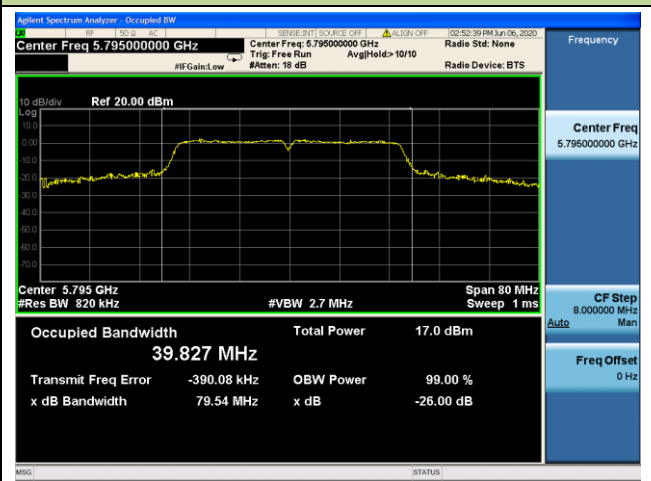
Channel 165 (5825MHz)

802.11ac-VHT20 26dB Bandwidth & 99% Bandwidth
Channel 36 (5180MHz)

Channel 44 (5220MHz)

Channel 48 (5240MHz)

Channel 149 (5745MHz)

Channel 157 (5785MHz)

Channel 165 (5825MHz)

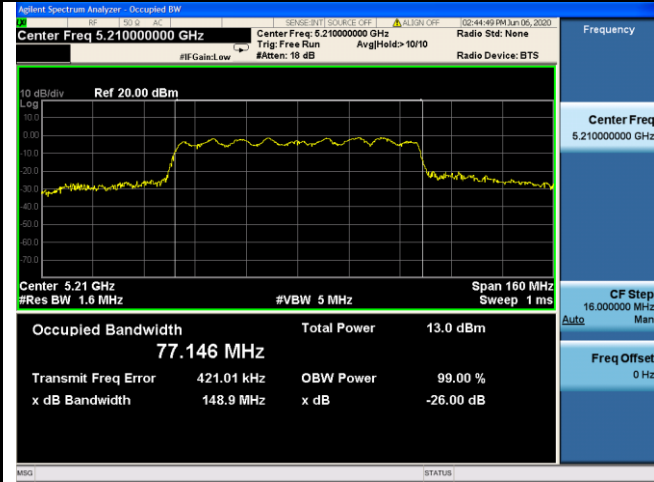
802.11ac-VHT40 26dB Bandwidth & 99% Bandwidth
Channel 38 (5190MHz)

Channel 46 (5230MHz)

Channel 151 (5755MHz)

Channel 159 (5795MHz)

802.11ac-VHT80 26dB Bandwidth & 99% Bandwidth

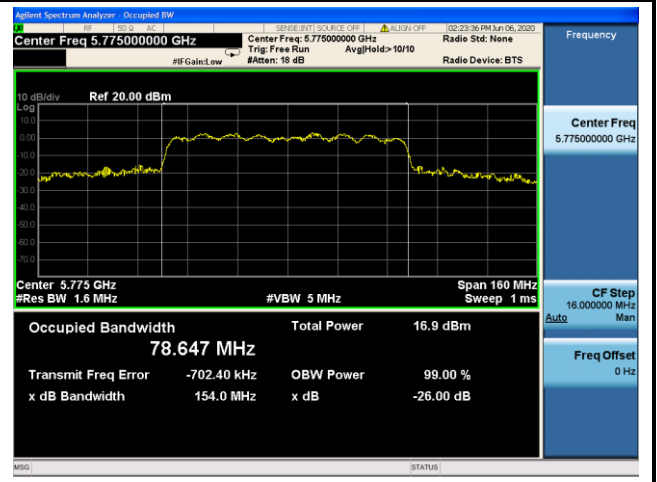
Channel 42 (5210MHz)



Channel 155 (5775MHz)



7.3. 6dB Bandwidth Measurement

7.3.1. Test Limit

The minimum 6dB bandwidth shall be at least 500 kHz.

7.3.2. Test Procedure Used

KDB 789033 D02v02r01 - Section C.2

7.3.3. Test Setting

1. Set RBW = 100 kHz.
2. Set the video bandwidth (VBW) $\geq 3 \times$ RBW.
3. Detector = Peak.
4. Trace mode = max hold.
5. Sweep = auto couple.
6. Allow the trace to stabilize.
7. Measure the maximum width of the emission that is constrained by the frequencies associated with the two outermost amplitude points (upper and lower frequencies) that are attenuated by 6 dB relative to the maximum level measured in the fundamental emission.

7.3.4. Test Setup

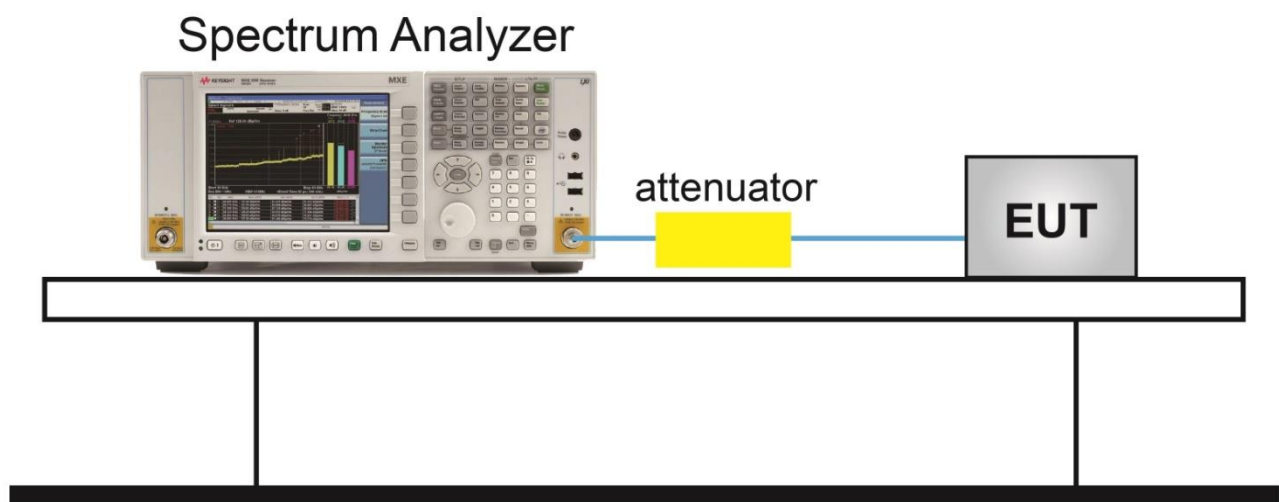

7.3.5. Test Result

Product	Smart Camera	Temperature	27°C
Test Engineer	Amy Zhang	Relative Humidity	47%
Test Site	TR3	Test Date	2020/06/05

Test Mode	Data Rate/ MCS	Channel No.	Frequency (MHz)	6dB Bandwidth (MHz)	Limit (MHz)	Result
802.11a	6Mbps	149	5745	16.94	≥ 0.5	Pass
802.11a	6Mbps	157	5785	16.93	≥ 0.5	Pass
802.11a	6Mbps	165	5825	16.54	≥ 0.5	Pass
802.11ac-VHT20	MCS0	149	5745	16.14	≥ 0.5	Pass
802.11ac-VHT20	MCS0	157	5785	17.16	≥ 0.5	Pass
802.11ac-VHT20	MCS0	165	5825	17.01	≥ 0.5	Pass
802.11ac-VHT40	MCS0	151	5755	35.36	≥ 0.5	Pass
802.11ac-VHT40	MCS0	159	5795	35.37	≥ 0.5	Pass
802.11ac-VHT80	MCS0	155	5775	73.89	≥ 0.5	Pass

802.11a 6dB Bandwidth

Channel 149 (5745MHz)

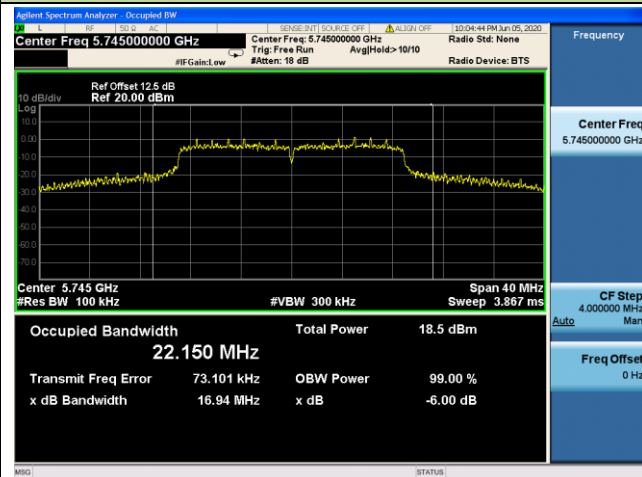

Channel 157 (5785MHz)

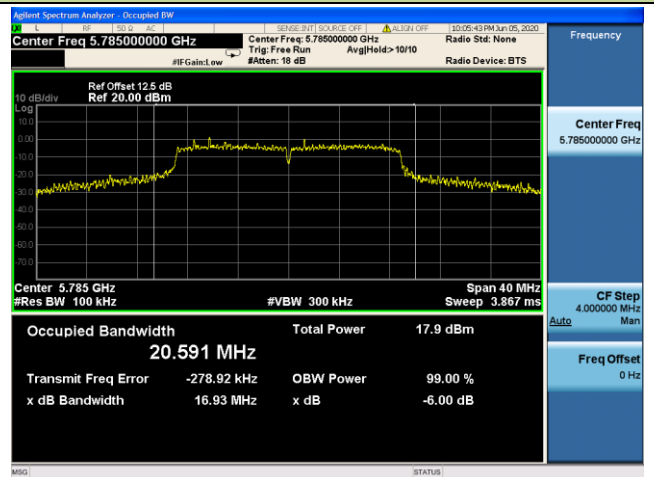

Channel 165 (5825MHz)

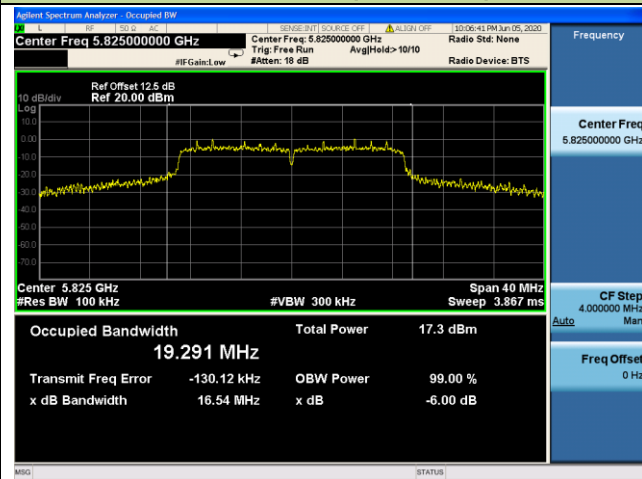

802.11ac-VHT20 6dB Bandwidth

Channel 149 (5745MHz)

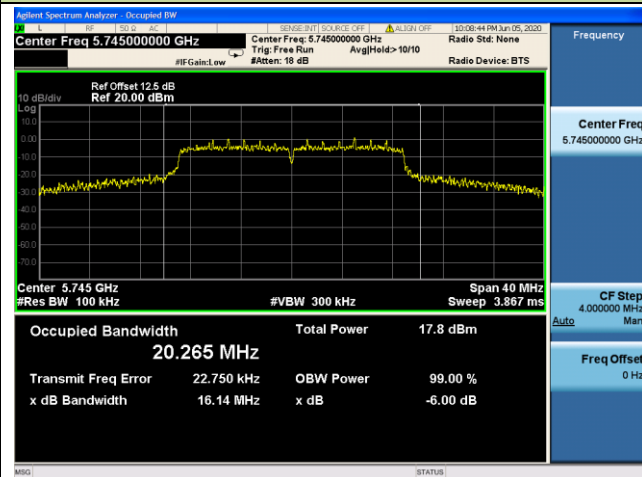

Channel 157 (5785MHz)

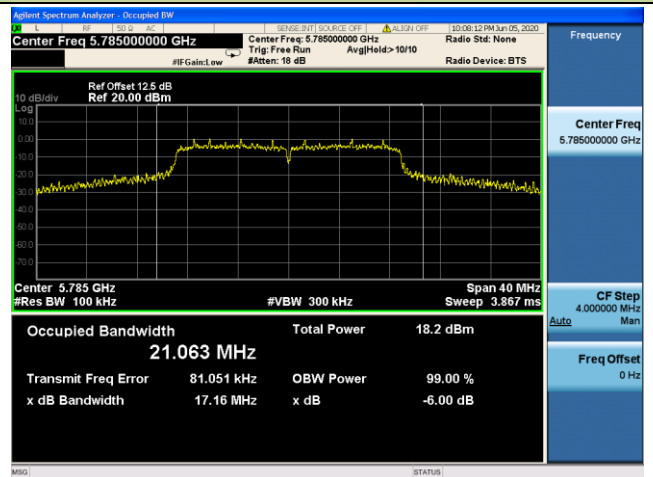

Channel 165 (5825MHz)

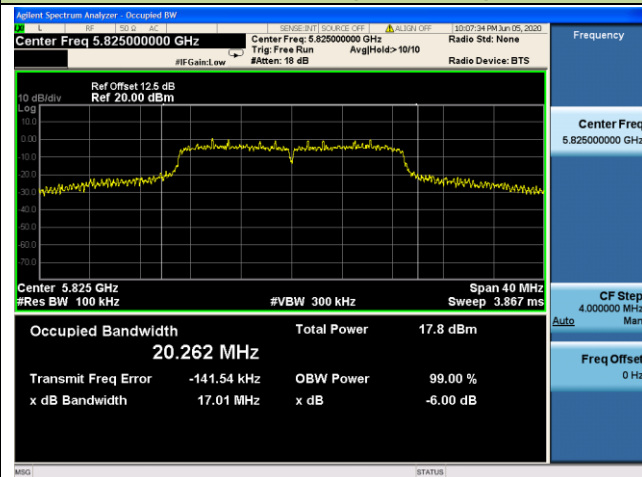

802.11ac-VHT40 6dB Bandwidth

Channel 151 (5755MHz)

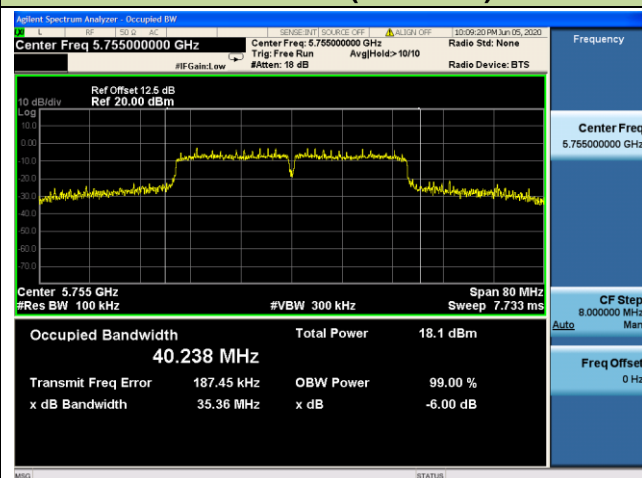

Channel 159 (5795MHz)

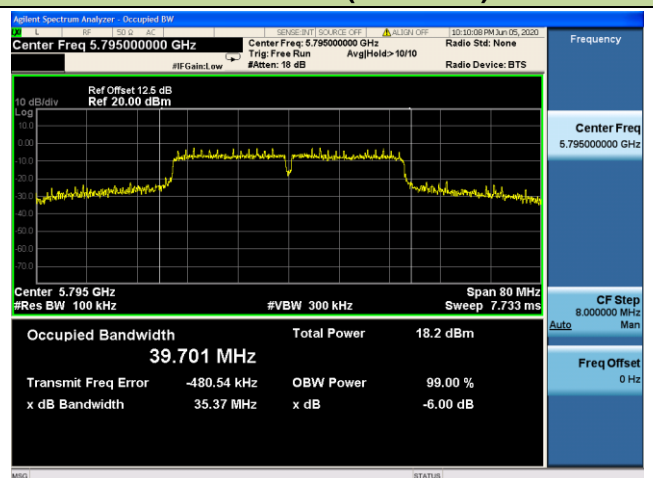

802.11ac-VHT80 6dB Bandwidth

Channel 155 (5775MHz)

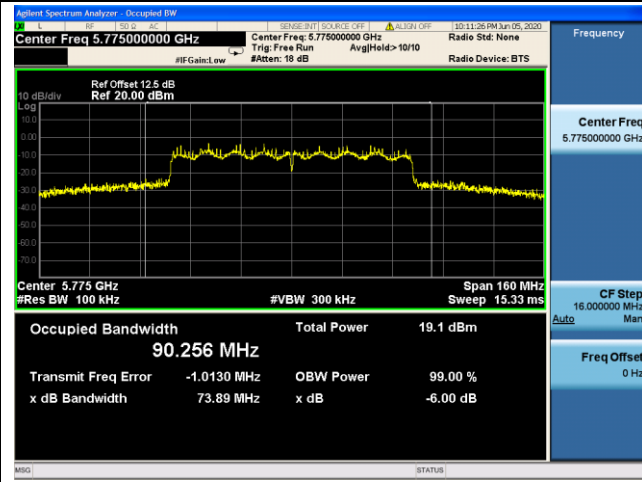

7.4. Output Power Measurement

7.4.1. Test Limit

For client devices in the 5.15-5.25 GHz band, the maximum conducted output power over the frequency band of operation shall not exceed 250 mW provided the maximum antenna gain does not exceed 6 dBi.

For the band 5.725-5.85 GHz, the maximum conducted output power over the frequency band of operation shall not exceed 1 W (30dBm).

If transmitting antennas of directional gain greater than 6dBi are used, the maximum conducted output power shall be reduced by the amount in dB that the directional gain of the antenna exceeds 6dBi.

7.4.2. Test Procedure Used

KDB 789033 D02v02r01 - Section E) 3) b) Method PM-G

7.4.3. Test Setting

Average power measurements were performed only when the EUT was transmitting at its maximum power control level using a broadband power meter with a pulse sensor. The power meter implemented triggering and gating capabilities which were set up such that power measurements were recorded only during the ON time of the transmitter.

7.4.4. Test Setup

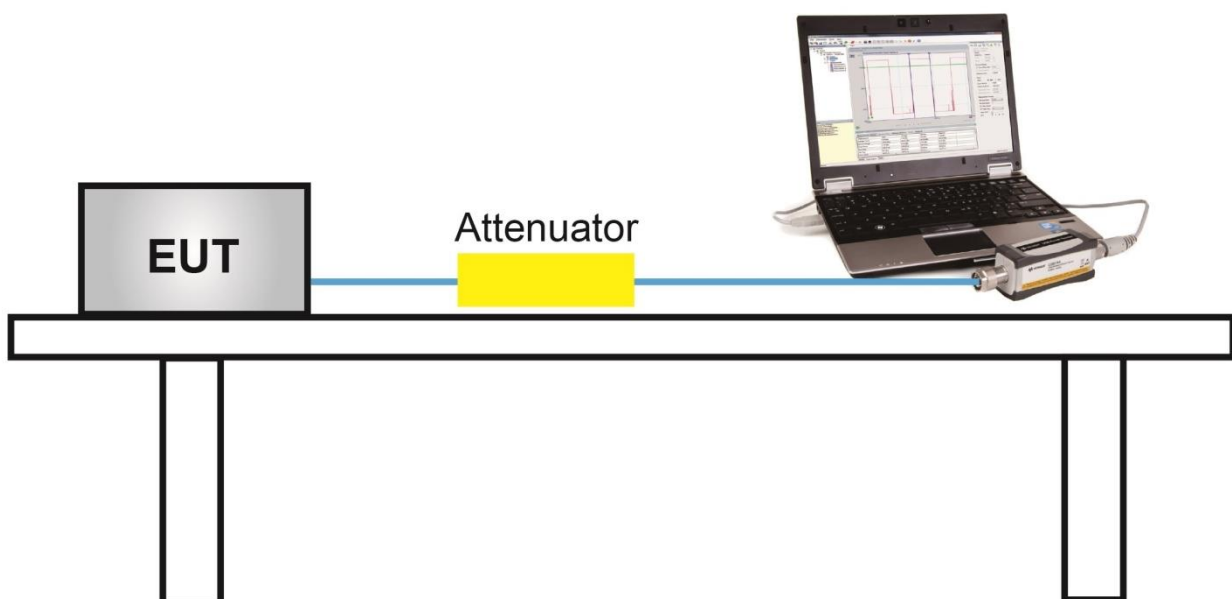

7.4.5. Test Result

Output power test was verified over all data rates of each mode shown as below table, and then choose the maximum output power (gray marker) for final test of each channel.

Test Mode	Bandwidth	Channel No.	Frequency (MHz)	Data Rate/ MCS	Average Power (dBm)
802.11a	20	36	5180	6Mbps	8.05
				24Mbps	7.85
				54Mbps	7.66
802.11ac	20	36	5180	MCS0	6.91
				MCS4	6.79
				MCS8	6.65
802.11ac	40	38	5190	MCS0	6.49
				MCS4	6.33
				MCS9	6.15
802.11ac	80	42	5210	MCS0	4.81
				MCS4	4.70
				MCS9	4.52

Product	Smart Camera	Temperature	27°C
Test Engineer	Amy Zhang	Relative Humidity	47%
Test Site	TR3	Test Date	2020/06/06

Test Mode	Data Rate/ MCS	Channel No.	Frequency (MHz)	Average Power (dBm)	Average Power Limit (dBm)	Result
11a	6Mbps	36	5180	8.05	≤ 23.98	Pass
11a	6Mbps	44	5220	6.97	≤ 23.98	Pass
11a	6Mbps	48	5240	6.95	≤ 23.98	Pass
11a	6Mbps	149	5745	10.34	≤ 30.00	Pass
11a	6Mbps	157	5785	10.67	≤ 30.00	Pass
11a	6Mbps	165	5825	10.05	≤ 30.00	Pass
11ac-VHT20	MCS0	36	5180	6.91	≤ 23.98	Pass
11ac-VHT20	MCS0	44	5220	6.72	≤ 23.98	Pass
11ac-VHT20	MCS0	48	5240	6.66	≤ 23.98	Pass
11ac-VHT20	MCS0	149	5745	10.35	≤ 30.00	Pass
11ac-VHT20	MCS0	157	5785	10.52	≤ 30.00	Pass
11ac-VHT20	MCS0	165	5825	10.03	≤ 30.00	Pass
11ac-VHT40	MCS0	38	5190	6.49	≤ 23.98	Pass
11ac-VHT40	MCS0	46	5230	6.09	≤ 23.98	Pass
11ac-VHT40	MCS0	151	5755	10.57	≤ 30.00	Pass
11ac-VHT40	MCS0	159	5795	10.61	≤ 30.00	Pass
11ac-VHT80	MCS0	42	5210	4.81	≤ 23.98	Pass
11ac-VHT80	MCS0	155	5775	9.46	≤ 30.00	Pass

7.5. Transmit Power Control

7.5.1. Test Limit

The U-NII device is required to have the capability to operate at least 6 dB below the mean EIRP value of 30 dBm.

7.5.2. Test Procedure Used

KDB 789033 D02v02r01 - Section E) 3) b) Method PM-G

7.5.3. Test Setting

Average power measurements were performed only when the EUT was transmitting at its maximum power control level using a broadband power meter with a pulse sensor. The power meter implemented triggering and gating capabilities which were set up such that power measurements were recorded only during the ON time of the transmitter.

7.5.4. Test Setup

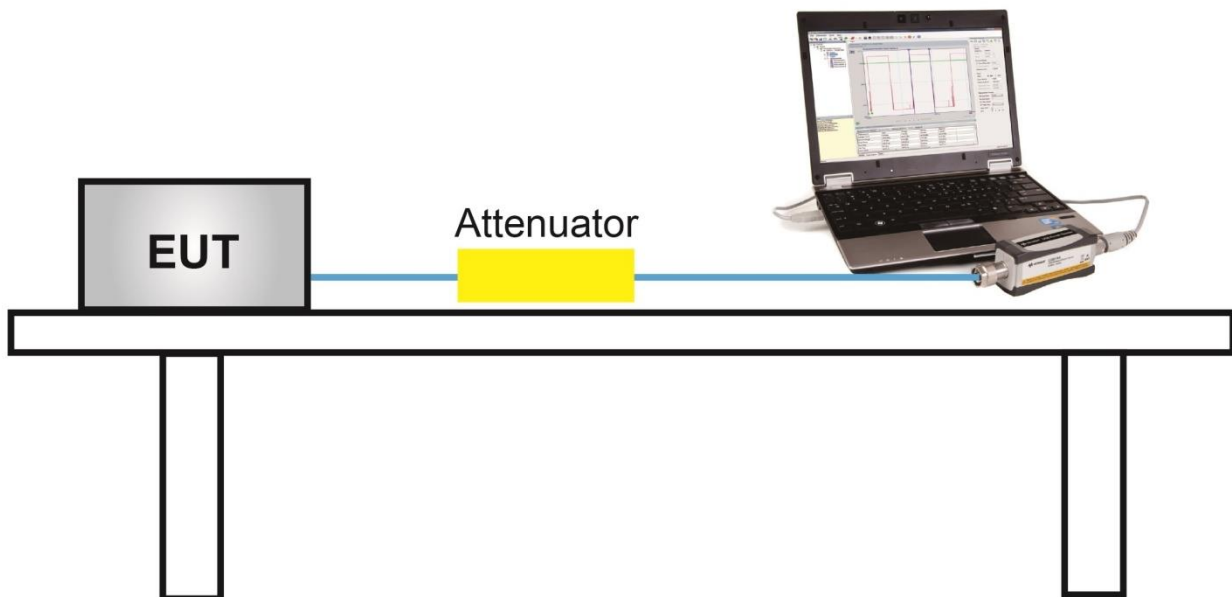

7.5.5. Test Result

A TPC mechanism is not required for systems with an e.i.r.p. of less than 500 mW.

7.6. Power Spectral Density Measurement

7.6.1. Test Limit

For client devices in the 5.15-5.25 GHz band, the maximum power spectral density shall not exceed 11 dBm in any 1 megahertz band.

For the band 5.725-5.85 GHz, the maximum power spectral density shall not exceed 30 dBm in any 500-kHz band.

If transmitting antennas of directional gain greater than 6dBi are used, the peak power spectral density shall be reduced by the amount in dB that the directional gain of the antenna exceeds 6dBi.

7.6.2. Test Procedure Used

KDB 789033 D02v02r01 - Section F

7.6.3. Test Setting

1. Analyzer was set to the center frequency of the UNII channel under investigation
2. Span was set to encompass the entire 26dB EBW of the signal.
3. RBW = 1MHz, if measurement bandwidth of Maximum PSD is specified in 500 kHz,
RBW = 100kHz
4. VBW $\geq 3 \times$ RBW.
5. Number of sweep points $\geq 2 \times$ (span / RBW)
6. Detector = Power averaging (Average)
7. Sweep time = Auto
8. Trigger = Free run
9. Use the peak search function on the instrument to find the peak of the spectrum and record its value.
10. Add $10 \times \log(1/x)$, where x is the duty cycle, to the measured power in order to compute the average power during the actual transmission times (because the measurement represents an average over both the on and off times of the transmission). For example, add $10 \times \log(1/0.25) = 6$ dB if the duty cycle is 25 percent.
11. When the measurement bandwidth of Maximum PSD is specified in 500 kHz, add a constant factor $10 \times \log(500\text{kHz}/100\text{kHz}) = 6.99$ dB to the measured result.

7.6.4. Test Setup

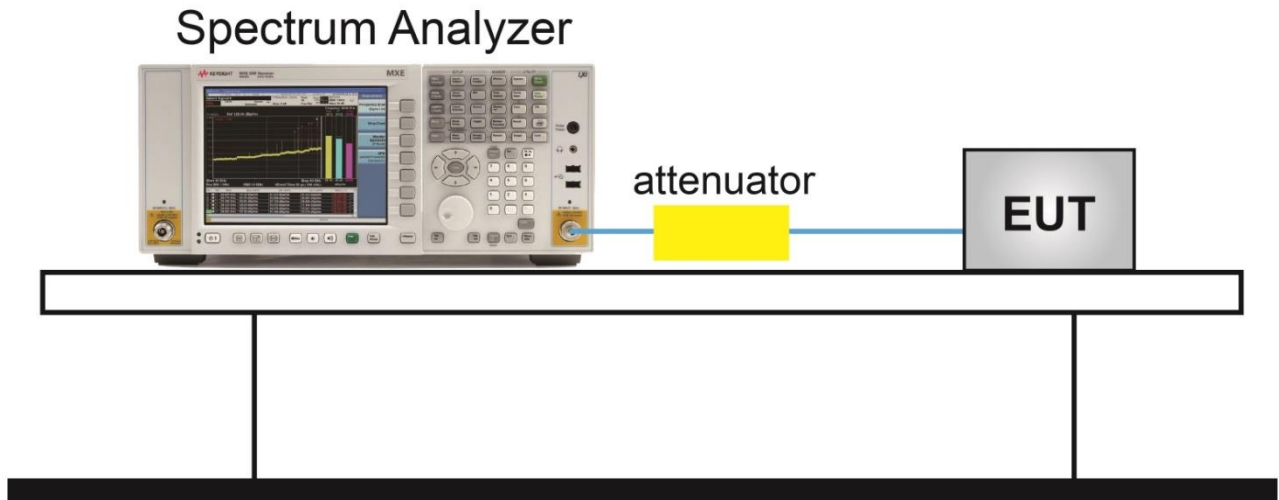

7.6.5. Test Result

Product	Smart Camera	Temperature	27°C
Test Engineer	Amy Zhang	Relative Humidity	47%
Test Site	TR3	Test Date	2020/06/06
Test Item	Power Spectral Density (UNII-Band 1)		

Test Mode	Data Rate/MCS	Channel No.	Freq. (MHz)	PSD (dBm/MHz)	Duty Cycle (%)	Final PSD (dBm/MHz)	PSD Limit (dBm/MHz)	Result
11a	6Mbps	36	5180	-5.63	97.15	-5.51	≤11.00	Pass
11a	6Mbps	44	5220	-6.48	97.15	-6.36	≤11.00	Pass
11a	6Mbps	48	5240	-6.07	97.15	-5.95	≤11.00	Pass
11ac-VHT20	MCS0	36	5180	-5.65	97.56	-5.54	≤11.00	Pass
11ac-VHT20	MCS0	44	5220	-5.62	97.56	-5.52	≤11.00	Pass
11ac-VHT20	MCS0	48	5240	-5.68	97.56	-5.57	≤11.00	Pass
11ac-VHT40	MCS0	38	5190	-8.64	92.84	-8.31	≤11.00	Pass
11ac-VHT40	MCS0	46	5230	-9.59	92.84	-9.27	≤11.00	Pass
11ac-VHT80	MCS0	42	5210	-11.60	97.70	-11.50	≤11.00	Pass

Note 1: When EUT duty cycle ≥ 98%, Final PSD (dBm/MHz) = PSD (dBm/MHz).

Note 2: When EUT duty cycle < 98%, Final PSD (dBm/MHz) = PSD (dBm/MHz) + 10*log (1/Duty Cycle).

Product	Smart Camera	Temperature	27°C
Test Engineer	Amy Zhang	Relative Humidity	47%
Test Site	TR3	Test Date	2020/06/06
Test Item	Power Spectral Density (UNII-Band 3)		

Test Mode	Data Rate/MCS	Channel No.	Freq. (MHz)	PSD (dBm/100kHz)	Duty Cycle (%)	Constant Factor (dB)	Final PSD (dBm/500kHz)	Limit (dBm/500kHz)	Result
11a	6Mbps	149	5745	-11.75	97.15	6.99	-4.64	≤ 30.00	Pass
11a	6Mbps	157	5785	-11.32	97.15	6.99	-4.20	≤ 30.00	Pass
11a	6Mbps	165	5825	-11.92	97.15	6.99	-4.81	≤ 30.00	Pass
11ac-VHT20	MCS0	149	5745	-11.27	97.56	6.99	-4.17	≤ 30.00	Pass
11ac-VHT20	MCS0	157	5785	-11.08	97.56	6.99	-3.99	≤ 30.00	Pass
11ac-VHT20	MCS0	165	5825	-11.45	97.56	6.99	-4.35	≤ 30.00	Pass
11ac-VHT40	MCS0	151	5755	-14.20	92.84	6.99	-6.88	≤ 30.00	Pass
11ac-VHT40	MCS0	159	5795	-14.16	92.84	6.99	-6.85	≤ 30.00	Pass
11ac-VHT80	MCS0	155	5775	-17.22	97.70	6.99	-10.13	≤ 30.00	Pass

Note 1: When EUT duty cycle ≥ 98%, Final PSD (dBm/500kHz) = PSD (dBm/100kHz) + Constant Factor (dB).

Note 2: When EUT duty cycle < 98%, Final PSD (dBm/500kHz) = PSD (dBm/100kHz) + Constant Factor (dB) + 10*log (1/Duty Cycle).

802.11a Power Spectral Density

Channel 36 (5180MHz)

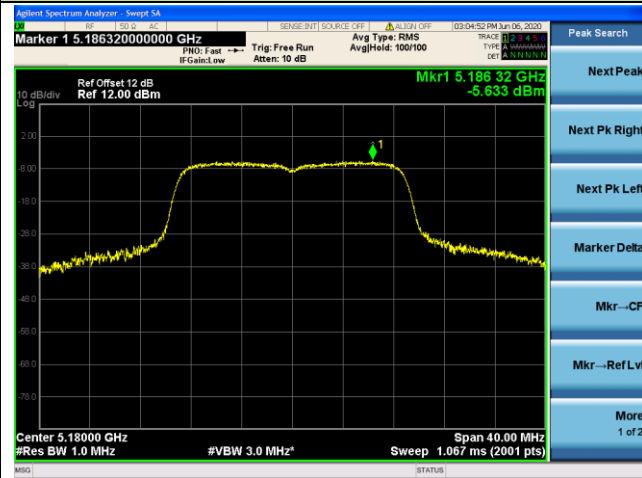

Channel 44 (5220MHz)



Channel 48 (5240MHz)



Channel 149 (5745MHz)



Channel 157 (5785MHz)

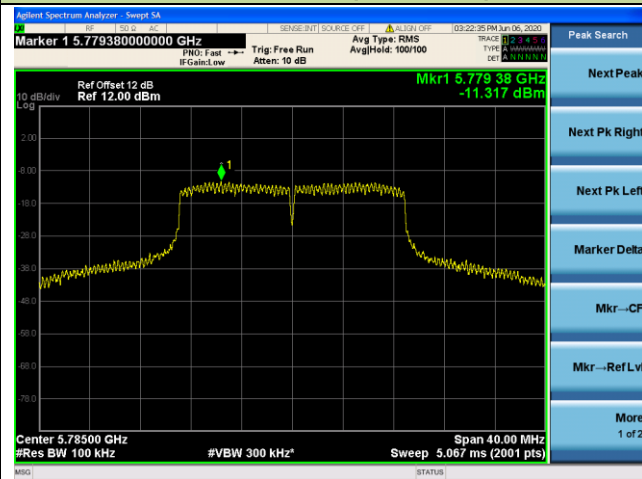

Channel 165 (5825MHz)

