



# TCS905-3S Module Datasheet

Version: 20230117

## Contents

<b>1</b>	<b>Product overview</b>	<b>2</b>
1.1	Features . . . . .	2
1.2	Applications . . . . .	2
<b>2</b>	<b>Module interfaces</b>	<b>4</b>
2.1	Dimensions and footprint . . . . .	4
2.2	Pin definition . . . . .	5
2.3	Definitions of test points . . . . .	7
<b>3</b>	<b>Electrical parameters</b>	<b>8</b>
3.1	Absolute electrical parameters . . . . .	8
3.2	Normal working conditions . . . . .	8
3.3	RF power consumption . . . . .	9
3.4	Working current . . . . .	9
<b>4</b>	<b>RF parameters</b>	<b>12</b>
4.1	Basic RF features . . . . .	12
4.2	Wi-Fi transmission performance . . . . .	12
4.3	Wi-Fi receiving performance . . . . .	13
4.4	Bluetooth transmission performance . . . . .	13
4.5	Bluetooth receiving performance . . . . .	14
<b>5</b>	<b>Antenna information</b>	<b>15</b>
5.1	Antenna type . . . . .	15
5.2	Antenna interference reduction . . . . .	15
<b>6</b>	<b>Packaging information and production instructions</b>	<b>18</b>
6.1	Mechanical dimensions . . . . .	18
6.2	Production instructions . . . . .	22
6.3	Recommended oven temperature curve . . . . .	23
6.4	Storage conditions . . . . .	25
<b>7</b>	<b>MOQ and packaging information</b>	<b>26</b>
<b>8</b>	<b>Appendix: Statement</b>	<b>27</b>



TCS905-3S is an embedded low-power Wi-Fi module that Tuya has developed. It consists of a highly integrated RF chip BK7231NSP and a few peripherals. TCS905-3S not only supports the Wi-Fi AP and STA modes, but also supports the Bluetooth LE.

## 1 Product overview

TCS905-3S is built in with a 32-bit MCU whose running speed can be up to 120 MHz, 2-MB flash memory, and 256-KB RAM, to support the Tuya IoT cloud connection. The MCU instructions specially extended for signal processing can effectively implement audio encoding and decoding.

Besides, it has rich peripherals, such as PWM and UART. There are six 32-bit PWM outputs, making the chip very suitable for high-quality LED control.

### 1.1 Features

- Built in with the low-power 32-bit CPU, which can also function as an application processor
- The clock rate: 120 MHz
- Working voltage: 3.0 to 3.6V
- Peripherals: 6 PWMs and 1 UART
- Wi-Fi connectivity
  - 802.11 b/g/n
  - Channels 1 to 14@2.4 GHz
  - Support WEP, WPA/WPA2, WPA/WPA2 PSK (AES), WPA3 security modes
  - Up to +16 dBm output power in 802.11b mode
  - Support STA/AP/STA+AP working mode
  - Support SmartConfig and AP network configuration manners for Android and iOS devices
  - Onboard PCB antenna with a gain of 1.3 dBi
  - Working temperature: -40°C to 85°C
- Bluetooth connectivity
  - Support the transmit power of 6 dBm in the Bluetooth mode
  - Complete Bluetooth coexistence interface
  - Onboard PCB antenna with a gain of 1.3 dBi

### 1.2 Applications

- Intelligent building
- Smart household and home appliances

- Smart socket and light
- Industrial wireless control
- Baby monitor
- Network camera
- Intelligent bus

## 2 Module interfaces

### 2.1 Dimensions and footprint

The dimensions of TCS905-3S are  $16.00 \pm 0.35$  mm (W)  $\times$   $24.00 \pm 0.35$  mm (L)  $\times$   $2.8 \pm 0.15$  mm (H).

The dimensions of TCS905-3S are as follows:

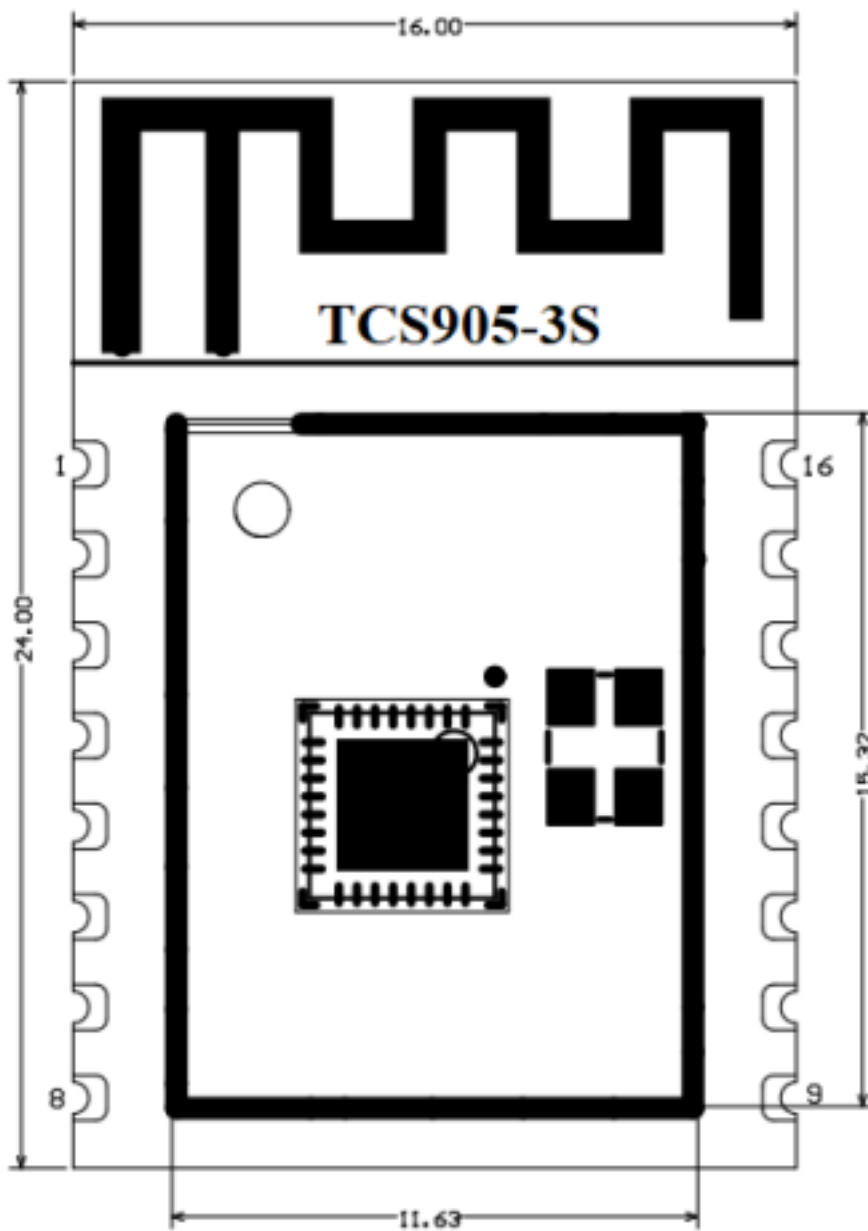

## 2.2 Pin definition

Pin number	Symbol	I/O type	Function
1	NC	I	Directly connected to Pin 3. Low level reset, high level active (the pin has been pulled high internally), correspond to CEN of the IC
2	ADC3	AI	ADC pin, which corresponds to P23 of the IC
3	CEN	I	Enabling pin, which is pulled high internally to be compatible with other modules
4	P14	I/O	A common GPIO interface, which corresponds to P14 of the IC
5	P26	I/O	GPIOP_26, which corresponds to P26 of the IC, PWM 5
6	P24	I/O	GPIOP_24, which corresponds to P24 of the IC, PWM 4

Pin number	Symbol	I/O type	Function
7	P6	I/O	GPIOP_6, which corresponds to P6 of the IC, PWM 0
8	3V3	P	Power supply pin (3.3V)
9	GND	P	Power supply reference ground
10	P9	I/O	GPIOP_9, which corresponds to P9 of the IC, PWM 3
11	TXD2	I/O	UART2_TXD (used to display the module internal information), which corresponds to P0 of the IC
12	RXD2	I/O	UART2_RXD, which corresponds to P1 on the internal IC
13	P8	I/O	GPIOP_8, which corresponds to P8 of the IC, PWM 2
14	P7	I/O	GPIOP_7, which corresponds to P7 of the IC, PWM 1
15	RXD1	I/O	UART1_RXD (User serial port), which corresponds to P10 of the IC



Pin number	Symbol	I/O type	Function
16	TXD1	I/O	UART1_TXD (User serial port), which corresponds to P11 of the IC

### 2.3 Definitions of test points

Pin number	Symbol	I/O type	Function
-	CSN	I/O	It is a mode selection pin. If it is connected to the ground before being powered on, enter the firmware test mode. If it is not connected or connected to VCC before being powered on, enter the firmware application mode. Correspond to P21 of the IC.

P indicates a power supply pin, I/O indicates an input/output pin, and AI indicates an analog input pin.

### 3 Electrical parameters

#### 3.1 Absolute electrical parameters

Parameter	Description	Minimum value	Maximum value	Unit
Ts	Storage temperature	-55	125	°C
VBAT	Power supply voltage	-0.3	3.9	V
ESD voltage (human body model)	TAMB-25°C	-4	4	KV
ESD voltage (machine model)	TAMB-25°C	-200	200	V

#### 3.2 Normal working conditions

Parameter	Description	Minimum value	Typical value	Maximum value	Unit
Ta	Working temperature	-40	-	85	°C
VBAT	Power supply voltage	3	3.3	3.6	V
VOL	I/O low level output	VSS	-	VSS+0.3	V
VOH	I/O high level output	VBAT-0.3	-	VBAT	V

Parameter	Description	Minimum value	Typical value	Maximum value	Unit
I <sub>max</sub>	I/O drive current	-	6	20	mA

### 3.3 RF power consumption

Working status	Mode	Rate	Transmit power/ Receive	Average value	Peak value (Typical value)	Unit
Transmit	11b	11Mbps	+16dBm	252	287	mA
Transmit	11g	54Mbps	+15dBm	246	265	mA
Transmit	11n	MCS7	+14dBm	242	264	mA
Receive	11b	11Mbps	Constantly receive	73	82	mA
Receive	11g	54Mbps	Constantly receive	75	82	mA
Receive	11n	MCS7	Constantly receive	75	82	mA

### 3.4 Working current

Working mode	Working status, Ta = 25°C	Average value	Maximum value (Typical value)	Unit
Quick network connection state (Bluetooth)	The module is in fast network connection state and the Wi-Fi indicator flashes fast	75	348	mA
Quick network connection state (AP)	The module is in hotspot network connection state and the Wi-Fi indicator flashes slowly	78	351	mA
Quick network connection state (EZ)	The module is in fast network connection state and the Wi-Fi indicator flashes fast	72	342	mA
Connected	The module is connected to the network and the Wi-Fi indicator is always on	53	357	mA

Working mode	Working status, Ta = 25°C	Average value	Maximum value (Typical value)	Unit
Weakly connected	The module and the hotspot are weakly connected and the Wi-Fi indicator is always on	212	352	mA
Disconnected	The module is disconnected and the Wi-Fi indicator is always off	58	341	mA
Module disabled	The CEN pin of the module is connected to the ground.	330	-	μA

## 4 RF parameters

### 4.1 Basic RF features

Parameter	Description
Working frequency	2.412 to 2.484 GHz
Wi-Fi standard	IEEE 802.11 b/g/n (channels 1 to 14)
Data transmission rate	11b: 1, 2, 5.5, 11 (Mbps) 11g: 6, 9, 12, 18, 24, 36, 48, 54 (Mbps) 11n: HT20 MCS 0 to 7
Antenna type	PCB antenna

### 4.2 Wi-Fi transmission performance

Parameter	Minimum value	Typical value	Maximum value	Unit
Average RF output power, 802.11b CCK Mode 11M	14	16	18	dBm
Average RF output power, 802.11g OFDM Mode 54M	13	15	17	dBm
Average RF output power, 802.11n OFDM Mode MCS7	12	14	16	dBm
Frequency error	-20	-	20	ppm

### 4.3 Wi-Fi receiving performance

Parameter	Minimum value	Typical value	Maximum value	Unit
PER<8%, RX sensitivity, 802.11b DSSS Mode 11M	-	-88	-	dBm
PER<10%, RX sensitivity, 802.11g OFDM Mode 54M	-	-74	-	dBm
PER<10%, RX sensitivity, 802.11n OFDM Mode MCS7	-	-73	-	dBm
PER<10%, RX sensitivity, Bluetooth LE 1M	-	-96	-	dBm

### 4.4 Bluetooth transmission performance

Parameter	Minimum value	Typical value	Maximum value	Unit
Working frequency	2402	-	2480	MHz
Air rate	-	1	-	Mbps
Transmit power	-20	6	20	dBm

Parameter	Minimum value	Typical value	Maximum value	Unit
Frequency error	-150	-	150	KHz

#### 4.5 Bluetooth receiving performance

Parameter	Minimum value	Typical value	Maximum value	Unit
RX sensitivity	-	-96	-	dBm
Maximum RF signal input	-10	-	-	dBm
Inter-modulation	-	-	-23	dBm
Co-channel suppression ratio	-	10	-	dB



## 5 Antenna information

### 5.1 Antenna type

TCS905-3S uses the PCB antenna with a gain of 1.3 dBi.

### 5.2 Antenna interference reduction

To ensure optimal Wi-Fi performance when the Wi-Fi module uses an onboard PCB antenna, it is recommended that the antenna be at least 15 mm away from other metal parts.

To prevent adverse impact on the antenna radiation performance, avoid copper or traces within the antenna area on the PCB.

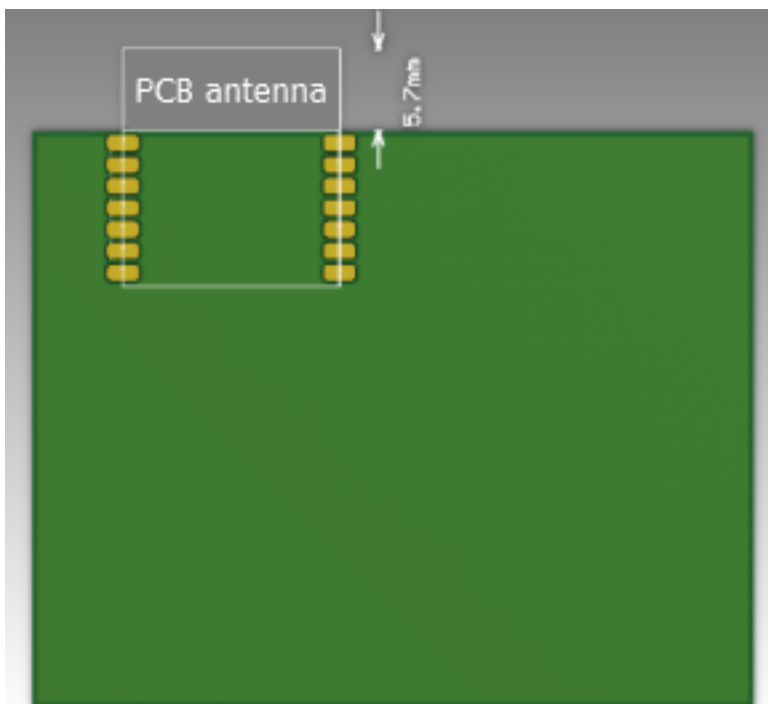

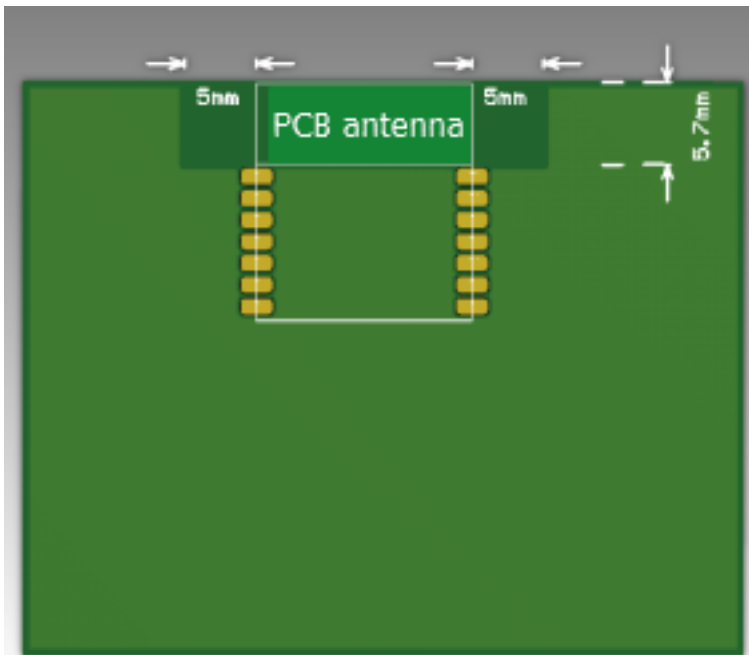
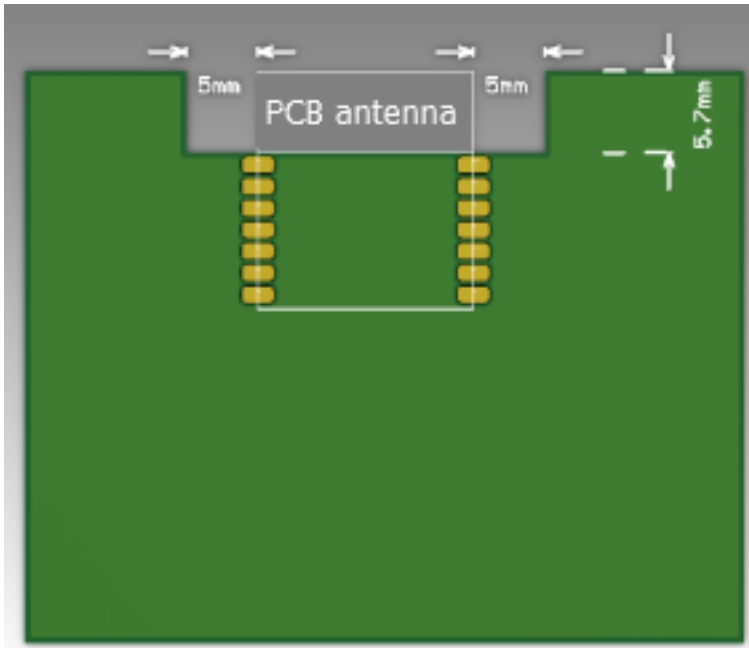

**Do not place any metal in the red area above the antenna.  
The recommended diameter of the circular arc is greater than 3 cm.**

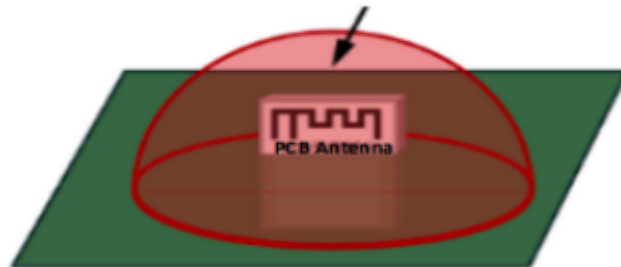

## 6 Packaging information and production instructions

### 6.1 Mechanical dimensions

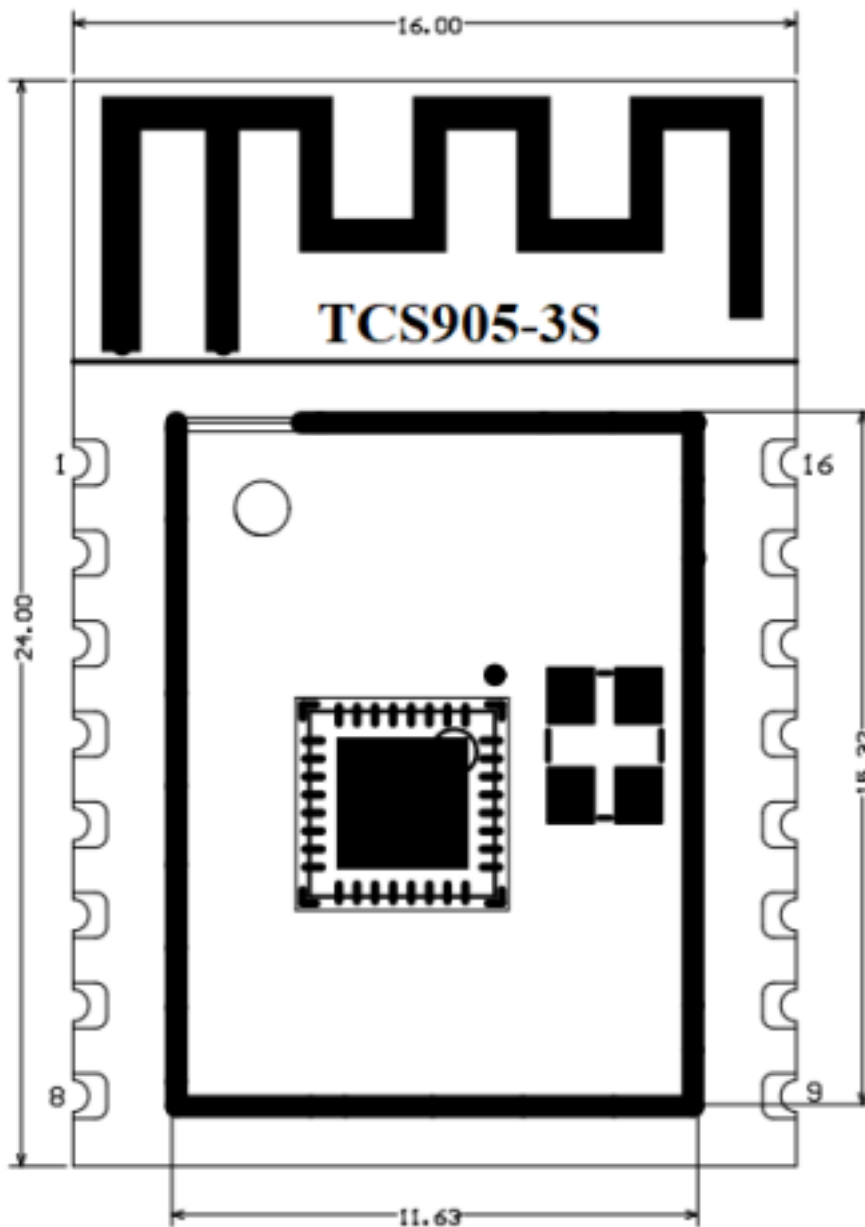

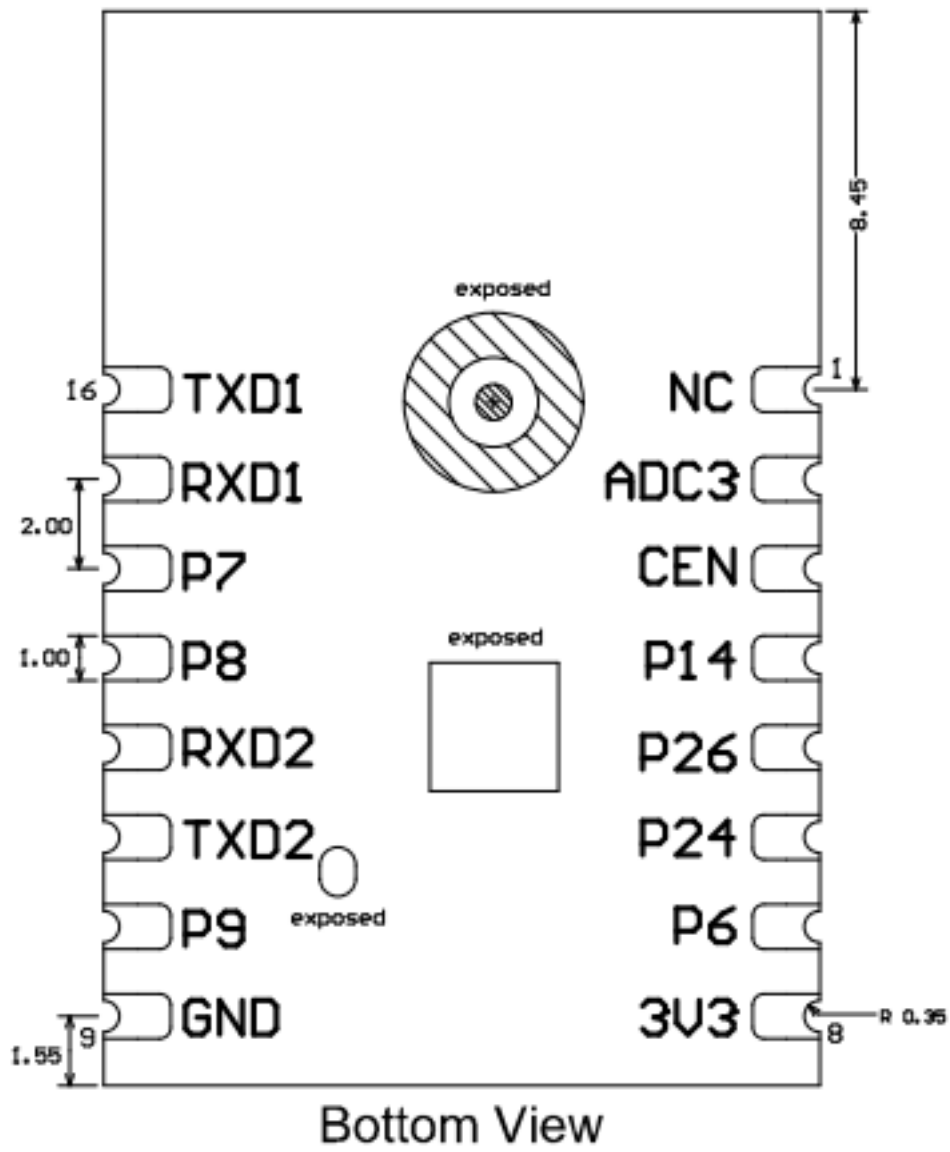

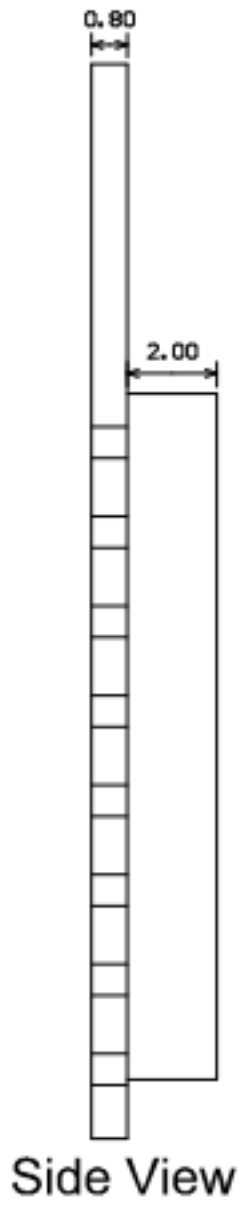

### Recommended footprint

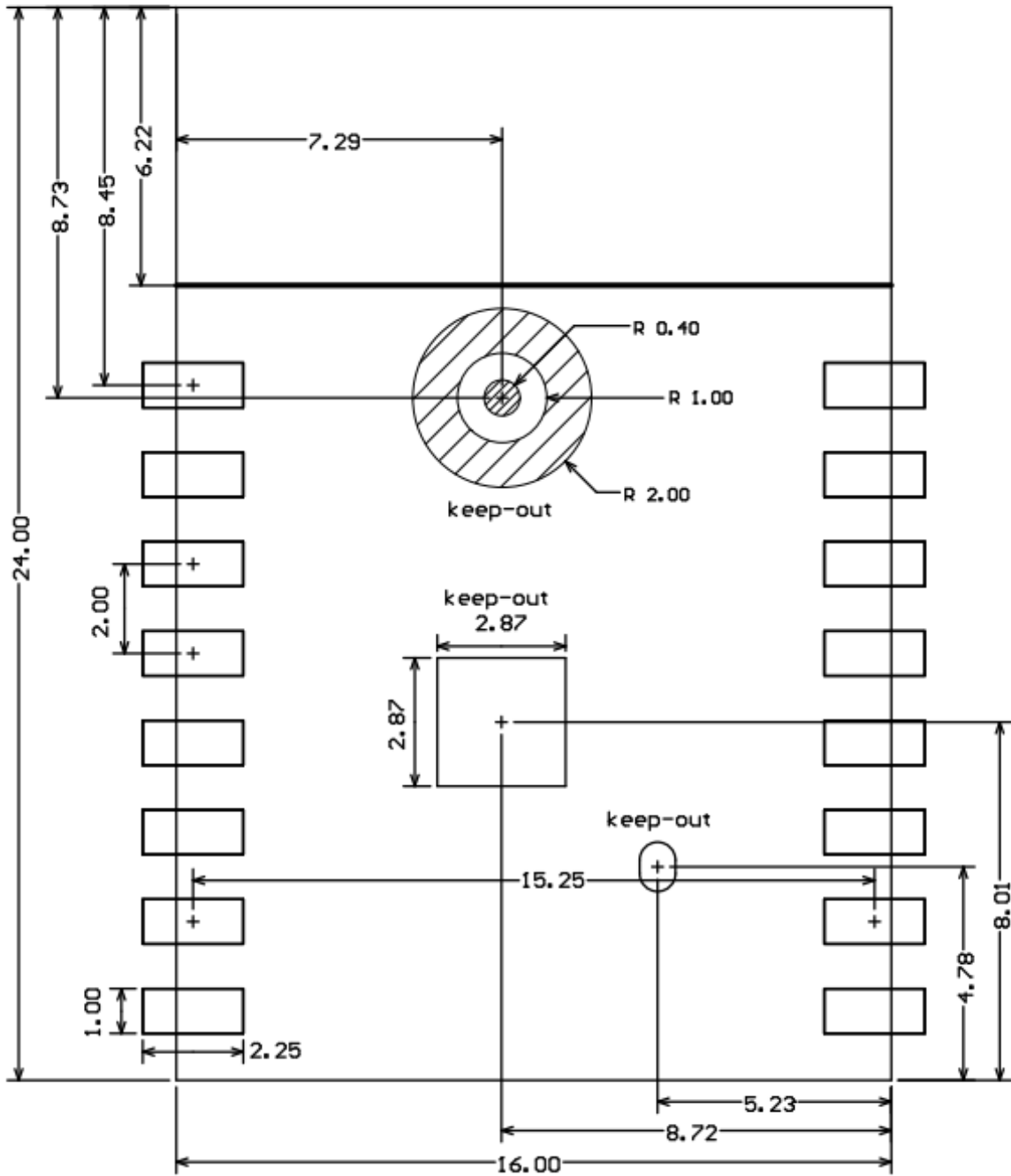

## 6.2 Production instructions

1. The Tuya SMT module should be mounted by the SMT device. After being unpacked, it should be soldered within 24 hours. Otherwise, it should be put into the drying cupboard where the RH is not greater than 10%; or it needs to be packaged under vacuum again and the exposure time needs to be recorded (the total exposure time cannot exceed 168 hours).

- SMT devices:
  - Mounter
  - SPI
  - Reflow soldering machine
  - Thermal profiler
  - Automated optical inspection (AOI) equipment
- Baking devices:
  - Cabinet oven
  - Anti-electrostatic and heat-resistant trays
  - Anti-electrostatic and heat-resistant gloves

2. Storage conditions for a delivered module:

- The moisture-proof bag must be placed in an environment where the temperature is below 40°C and the relative humidity is lower than 90%.
- The shelf life of a dry-packaged product is 12 months from the date when the product is packaged and sealed.
- There is a humidity indicator card (HIC) in the packaging bag.

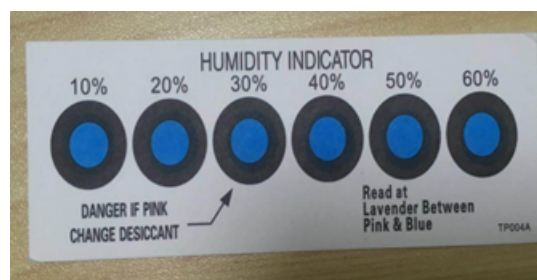

**Figure 1:** HIC-SMT module.png

3. The module needs to be baked in the following cases:

- The packaging bag is damaged before unpacking.



- There is no HIC in the packaging bag.
- After unpacking, circles of 10% and above on the HIC become pink.
- The total exposure time has lasted for over 168 hours since unpacking.
- More than 12 months have passed since the sealing of the bag.

#### 4. Baking settings:

- Temperature: 40°C and  $\leq 5\%$  RH for reel package and 125°C and  $\leq 5\%$  RH for tray package (please use the heat-resistant tray rather than a plastic container)
- Time: 168 hours for reel package and 12 hours for tray package
- Alarm temperature: 50°C for reel package and 135°C for tray package
- Production-ready temperature after natural cooling:  $< 36^\circ\text{C}$
- Re-baking situation: If a module remains unused for over 168 hours after being baked, it needs to be baked again.
- If a batch of modules is not baked within 168 hours, do not use the wave soldering to solder them. Because these modules are Level-3 moisture-sensitive devices, they are very likely to get damp when exposed beyond the allowable time. In this case, if they are soldered at high temperatures, it may result in device failure or poor soldering.

5. In the whole production process, take electrostatic discharge (ESD) protective measures.

6. To guarantee the passing rate, it is recommended that you use the SPI and AOI to monitor the quality of solder paste printing and mounting.

### 6.3 Recommended oven temperature curve

Set oven temperatures according to the following temperature curve of reflow soldering. The peak temperature is 245°C.

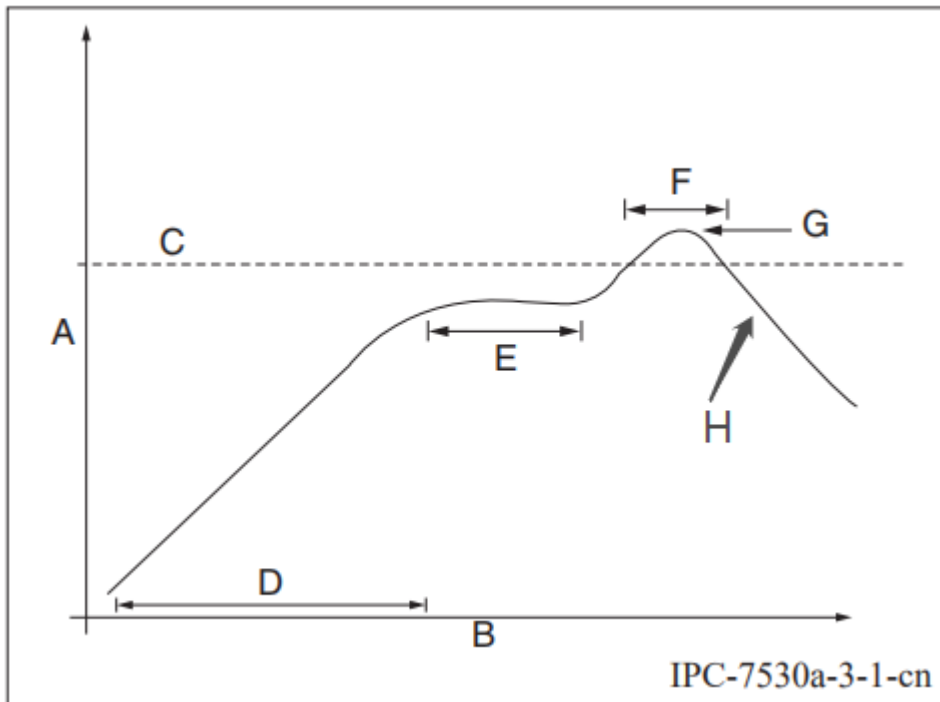

- A: Temperature axis
- B: Time axis
- C: Liquidus temperature: 217 to 220°C
- D: Ramp-up slope: 1 to 3°C/s
- E: Duration of constant temperature: 60 to 120s; the range of constant temperature: 150 to 200°C
- F: Duration above the liquidus: 50 to 70s
- G: Peak temperature: 235 to 245°C
- H: Ramp-down slope: 1 to 4°C/s

:::info

The above curve is just an example of the solder paste SAC305. For more details about other solder pastes, please refer to Recommended oven temperature curve in the solder paste specifications.

:::

6.4 Storage conditions

 **Caution**  
This bag contains **MOISTURE-SENSITIVE DEVICES**

**LEVEL**  
**3**  
If blank, see adjacent bar code label

1. Calculated shelf life in sealed bag: 12 months at <math><40^{\circ}\text{C}</math> and <math><90\%</math> relative humidity (RH)
2. Peak package body temperature: 260 °C  
If blank, see adjacent bar code label
3. After bag is opened, devices that will be subjected to reflow solder or other high temperature process must be
  - a) Mounted within: 168 hours of factory conditions  
If blank, see adjacent bar code label  
<math>\leq 30^{\circ}\text{C}/60\%</math> RH, or
  - b) Stored per J-STD-033
4. Devices require bake, before mounting, if:
  - a) Humidity Indicator Card reads >10% for level 2a - 5a devices or >60% for level 2 devices when read at  $23 \pm 5^{\circ}\text{C}$
  - b) 3a or 3b are not met
5. If baking is required, refer to IPC/JEDEC J-STD-033 for bake procedure

Bag Seal Date: See Production Date  
If blank, see adjacent bar code label

**Note: Level and body temperature defined by IPC/JEDEC J-STD-020**

## 7 MOQ and packaging information

Product number	MOQ (pcs)	Shipping packaging method	The number of modules per reel	The number of reels per carton
TCS905-3S	3600	Tape reel	900	4

## 8 Appendix: Statement

**FCC Caution:** Any changes or modifications not expressly approved by the party responsible for compliance could void the user's authority to operate this device. The module is limited to installation in mobile or fixed applications.

This device complies with Part 15 of the FCC Rules. Operation is subject to the following two conditions: (1) This device may not cause harmful interference, and (2) this device must accept any interference received, including interference that may cause undesired operation.

**Note:** This device has been tested and found to comply with the limits for a Class B digital device, according to part 15 of the FCC Rules. These limits are designed to provide reasonable protection against harmful interference in a residential installation. This device generates, uses, and can radiate radio frequency energy and, if not installed and used following the instructions, may cause harmful interference to radio communications. However, there is no guarantee that interference will not occur in a particular installation.

If this device does cause harmful interference to radio or television reception, which can be determined by turning the device off and on, the user is encouraged to try to correct the interference by one or more of the following measures:

- Reorient or relocate the receiving antenna.
- Increase the separation between the device and receiver.
- Connect the device into an outlet on a circuit different from that to which the receiver is connected.
- Consult the dealer or an experienced radio/TV technician for help.

### **Radiation Exposure Statement**

This device complies with FCC radiation exposure limits set forth for an uncontrolled rolled environment. This device should be installed and operated with a minimum distance of 20cm between the radiator and your body.

### **Important Note**

This radio module must not be installed to co-locate and operate simultaneously with other radios in the host system except following FCC multi-transmitter product procedures. Additional testing and device authorization may be required to operate simultaneously with other radios.

The availability of some specific channels and/or operational frequency bands are

country-dependent and are firmware programmed at the factory to match the intended destination. The firmware setting is not accessible by the end-user.

The host product manufacturer is responsible for compliance with any other FCC rules that apply to the host not covered by the modular transmitter grant of certification. The final host product still requires Part 15 Subpart B compliance testing with the modular transmitter installed. The separate approval is required for all other operating configurations including portable configurations with respect to Part 2.1093 and different antenna configuration.

The end-user manual shall include all required regulatory information/warnings as shown in this manual, including “This product must be installed and operated with a minimum distance of 20 cm between the radiator and user body” .

The OEM integrator is responsible for ensuring that the end-user has no manual instructions to remove or install module.

This device has got an FCC ID: 2ANDL-TCS905-3S. The end product must be labeled in a visible area with the following: “Contains Transmitter Module FCC ID: 2ANDL-TCS905-3S” .

This device is intended only for OEM integrators under the following conditions:

The antenna must be installed such that 20cm is maintained between the antenna and users, and the transmitter module may not be co-located with any other transmitter or antenna.

As long as the 2 conditions above are met, further transmitter tests will not be required. However, the OEM integrator is still responsible for testing their end-product for any additional compliance requirements required with this module installed.

### **Declaration of Conformity European Notice**



Hereby, Hangzhou Tuya Information Technology Co., Ltd declares that this module product complies with essential requirements and other relevant provisions of Directive 2014/53/EU, 2011/65/EU. A copy of the Declaration of conformity can be found at <https://www.tuya.com>.



This product must not be disposed of as normal household waste, under the EU directive for waste electrical and electronic equipment (WEEE-2012/19/EU). Instead, it should be disposed of by returning it to the point of sale, or a municipal recycling collection point.

The device could be used with a separation distance of 20cm to the human body.