



AXY2S Module Datasheet

Version: 20211102

Contents

1	Product overview	2
1.1	Features	2
1.2	Applications	2
2	Module interfaces	3
2.1	Dimensions and footprint	3
2.2	Pin definition	5
3	Electrical parameters	8
3.1	Absolute electrical parameters	8
3.2	Working conditions	8
3.3	RF power consumption	9
3.4	Power consumption during working	10
4	RF parameters	12
4.1	Basic RF features	12
4.2	TX performance	12
5	Antenna information	17
5.1	Antenna type	17
5.2	Antenna interference reduction	17
6	Packaging information and production instructions	18
6.1	Mechanical dimensions	18
6.2	Recommended PCB footprint	21
6.3	Production instructions	23
6.4	Recommended oven temperature curve	25
6.5	Storage conditions	28
7	MOQ and packaging information	29
8	Appendix: Statement	30



AXY2S is a low-power-consumption embedded Wi-Fi 6+Bluetooth module that Tuya has developed. Embedded with the Wi-Fi network protocol stack and rich library functions, it consists of a highly integrated wireless RF chip (ECR6600-TS2D).

1 Product overview

With a maximum clock rate of 240 MHz, AXY2S also contains a low-power-consumption Andes D10 MCU, a WLAN MAC, a 1T1R WLAN, a 292-KB SRAM, a 2-MB flash memory, and extensive peripherals.

AXY2S is an RTOS platform that integrates all function libraries of the Wi-Fi MAC and TCP/IP. You can develop embedded Wi-Fi products as required.

1.1 Features

- Embedded with a low-power-consumption Andes D10 MCU, which can also function as an application processor Main clock rate: 240 MHz
- Operating voltage: 3.0 to 3.6 V
- Peripherals: 5 GPIOs, 1 Data UART, 1 Log UART, and 1 ADC
- Wi-Fi and Bluetooth connectivity:
 - 802.11 B/G/N20/N40/N40/AX20
 - Channels 1 to 14@2.4 GHz (CH1 to 11 for US/CA and CH1 to 13 for EU/CN)
 - Support WEP, WPA, WPA2, and WPA2 PSK (AES) security modes
 - Support Bluetooth Low Energy 5.1
 - Up to +20 dBm output power in 802.11b mode
 - Support uplink/downlink MU-OFDMA
 - Support fast network configuration via Wi-Fi for Android and iOS devices
 - Onboard PCB antenna
 - Certified by CE and FCC
 - Operating temperature: -40°C to 85°C

1.2 Applications

- Intelligent buildings
- Smart household and home appliances
- Smart socket and light
- Industrial wireless control
- Baby monitor
- Network camera
- Intelligent bus

2 Module interfaces

2.1 Dimensions and footprint

AXY2S has 2 lines of pins with a spacing of 2mm.

The AXY2S dimensions are 15 ± 0.35 mm (W) \times 17.91 ± 0.35 mm (L) \times 2.9 ± 0.15 mm (H). The dimensions of AXY2S are as follows:

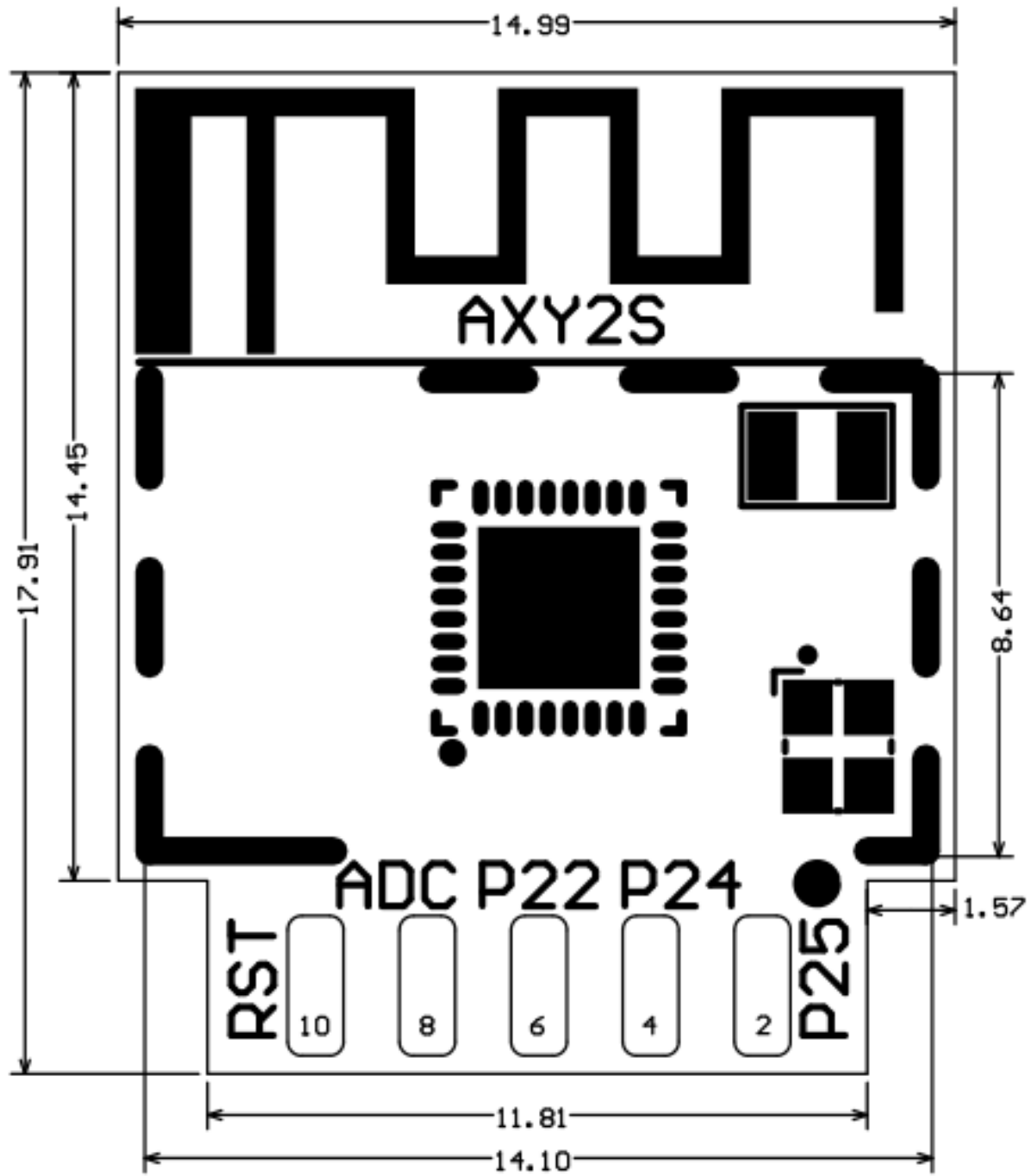

Top View

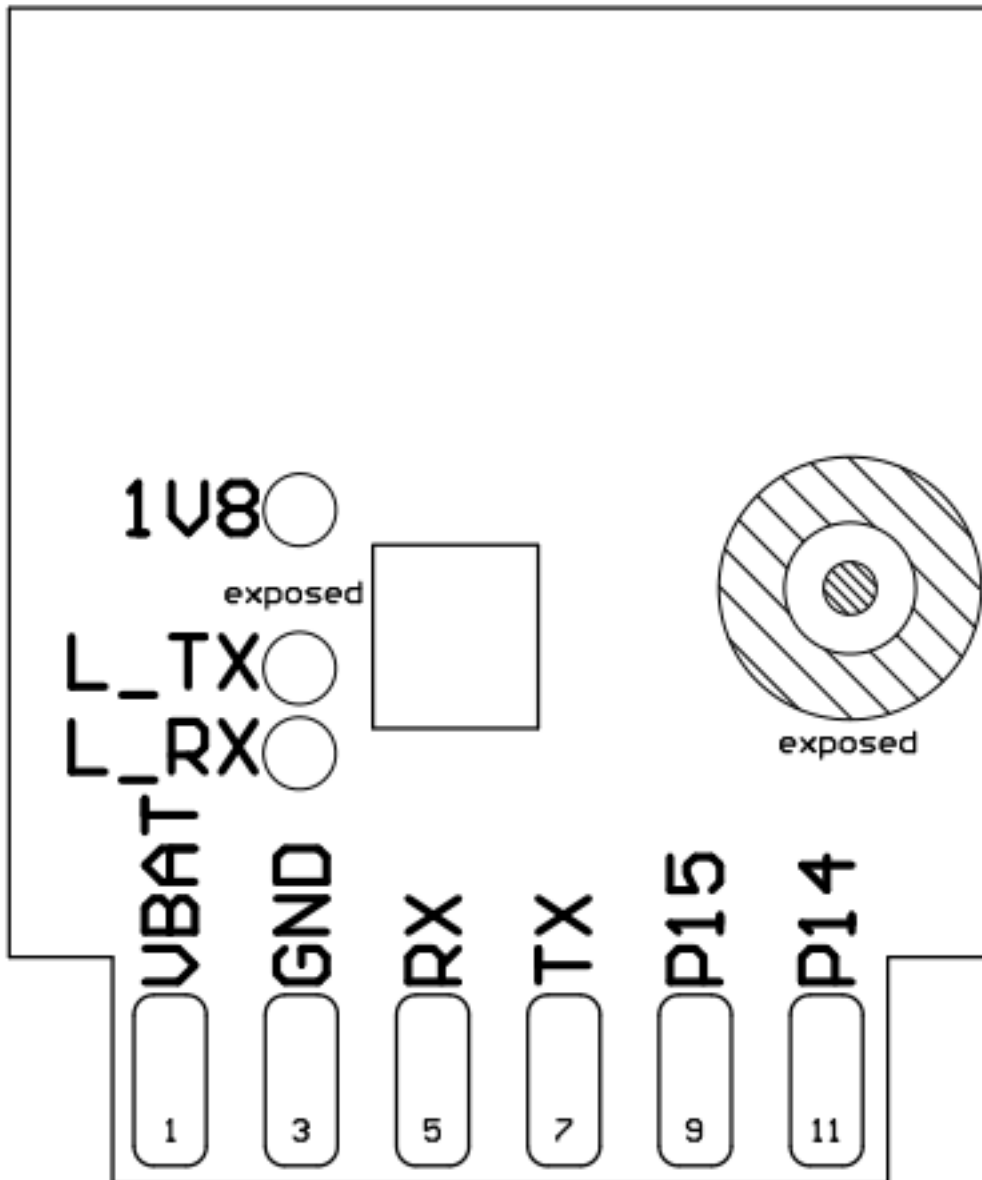

Bottom View

2.2 Pin definition

Pin number	Symbol	Type	Function
1	VBAT	P	Power supply pin (3.3V)
2	P25	I/O	GPIO_25, hardware PWM, correspond to Pin 7 of the IC
3	GND	P	Power supply reference ground
4	P24	I/O	GPIO_24, hardware PWM, correspond to Pin 8 of the IC
5	RX	I/O	GPIO_5, UART0_RXD (user serial interface)
6	P22	I/O	GPIO_22, hardware PWM, Pin 4 of the IC
7	TX	I/O	GPIO_6, UART0_TXD (user serial interface)
8	ADC	AI	GPIO_20, common GPIO, which can be used as ADC. The range of input voltage is 0 to 3.3V. Correspond to Pin 27 of the IC.
9	P15	I/O	GPIO_15, hardware PWM, Pin 28 of the IC

Pin number	Symbol	Type	Function
10	RST	I/O	Reset pin, reset at a low level. The module has been pulled to a high level and the user can control the pin externally.
11	P14	I/O	GPIO_14, hardware PWM, correspond to Pin 29 of the IC

Note: P indicates a power supply pin and I/O indicates an input/output pin.

3 Electrical parameters

3.1 Absolute electrical parameters

Parameter	Description	Minimum value	Maximum value	Unit
Ts	Storage temperature	-40	125	°C
VDD	Power supply voltage	-0.3	3.6	V
ESD voltage (human body model)	TAMB-25°C	-	2	KV
ESD voltage (machine model)	TAMB-25°C	-	0.5	KV

3.2 Working conditions

Parameter	Description	Minimum value	Typical value	Maximum value	Unit
Ta	Operating temperature	-40	-	85	°C
VDD	Operating voltage	3.0	-	3.6	V
VIL	Voltage input low	0	-	0.3vdd	V
VIH	Voltage input high	0.7vdd	-	vdd	V
VOL	Voltage output low	-	-	0.1vdd	V

Parameter	Description	Minimum value	Typical value	Maximum value	Unit
VOH	Voltage output high	0.9vdd	-	-	V
I _{max}	Drive current	-	4	-	mA
C _{pad}	Input pin capacitance	-	2	-	pF

3.3 RF power consumption

TX power consumption:

Symbol	Mode	Power	Average value	Peak value (Typical value)	Unit
IRF	11b 1Mbps	17dBm	308	310	mA
IRF	11b 11Mbps	17dBm	304	305	mA
IRF	11g 6Mbps	17dBm	214	215	mA
IRF	11g 54Mbps	15dBm	175	176	mA
IRF	11n HT20 MCS0	17dBm	217	218	mA
IRF	11n HT20 MCS7	14dBm	179	180	mA
IRF	11n HT40 MCS0	15dBm	191	192	mA
IRF	11n HT40 MCS7	13dBm	169	170	mA
IRF	11ax HE20 MCS0	17dBm	213	214	mA
IRF	11ax HE20 MCS7	14dBm	179	180	mA

RX power consumption:

Symbol	Mode	Average value	Peak value (Typical value)	Unit
IRF	11B 1M	32	32	mA
IRF	11B 11M	32	32	mA
IRF	11G 6M	33	33	mA
IRF	11G 54M	34	34	mA
IRF	11N HT20 MCS0	33	33	mA
IRF	11N HT20 MCS7	34	34	mA
IRF	11N HT40 MCS0	37	37	mA
IRF	11N HT40 MCS7	38	38	mA
IRF	11AX HT20 MCS0	32	32	mA
IRF	11AX HT20 MCS7	32	32	mA

3.4 Power consumption during working

Working mode	Working status, TA = 25°C	Average value	Peak value (Typical value)	Unit
Fast network configuration (AP)	The module is in fast network configuration state and the Wi-Fi indicator flashes slowly	40	210	mA

Working mode	Working status, TA = 25°C	Average value	Peak value (Typical value)	Unit
Fast network configuration (EZ)	The module is in fast network configuration state and the Wi-Fi indicator flashes fast	40	197	mA
Fast network configuration (Bluetooth)	The module is in fast network configuration state and the Wi-Fi indicator flashes fast	41	184	mA
No operation during network connection	The module is connected to the network and the Wi-Fi indicator is always on	34	52	mA
Operations are being performed during network connection	The module is connected to the network and the Wi-Fi indicator is always on	36	61	mA
Disconnected state	The module is disconnected and the Wi-Fi indicator is off	35	51	mA
The router is not powered	The module is disconnected and the Wi-Fi indicator is off	34	84	mA

4 RF parameters

4.1 Basic RF features

Parameter	Description
Frequency range	2.400 to 2.4835 GHz
Wi-Fi standard	IEEE 802.11b/g/n/ax (channels 1 to 14)
Bluetooth standard	Bluetooth 5.1
Data transmission rate	11b: 1, 2, 5.5, and 11 (Mbps)
Data transmission rate	11g: 6, 9, 12, 18, 24, 36, 48, 54 (Mbps)
Data transmission rate	11n: HT20 MCS0 to 7
Data transmission rate	11n: HT40 MCS0 to 7
Data transmission rate	11ax: HE20 MCS0 to 7
Antenna type	PCB antenna with a gain of 1.97 dBi

4.2 TX performance

TX performance

Parameter	Minimum value	Typical value	Maximum value	Unit
Average RF output power, 802.11b CCK Mode 1M	-	17	-	dBm
Average RF output power, 802.11b CCK Mode 11M	-	17	-	dBm
Average RF output power, 802.11g OFDM Mode 6M	-	17	-	dBm

Parameter	Minimum value	Typical value	Maximum value	Unit
Average RF output power, 802.11g OFDM Mode 54M	-	15	-	dBm
Average RF output power, 802.11n HT20 OFDM Mode MCS0	-	17	-	dBm
Average RF output power, 802.11n HT20 OFDM Mode MCS7	-	14	-	dBm
Average RF output power, 802.11n HT40 OFDM Mode MCS0	-	15	-	dBm
Average RF output power, 802.11n HT40 OFDM Mode MCS7	-	13	-	dBm
Average RF output power, 802.11ax HE20 OFDMA Mode MCS0	-	17	-	dBm

Parameter	Minimum value	Typical value	Maximum value	Unit
Average RF output power, 802.11ax HE20 OFDMA Mode MCS7	-	14	-	dBm
Average RF output power, Bluetooth 5.1 2M	-	7	-	dBm
Frequency error	-20	-	20	ppm
EVM@802.11b CCK 11Mbps Mode 17dBm	-	-	-10	dB
EVM@802.11g OFDM 54Mbps Mode 15dBm	-	-	-29	dB
EVM@802.11n HT20 OFDM MCS7 Mode 14dBm	-	-	-30	dB
EVM@802.11n HT40 OFDM MCS7 Mode 13dBm	-	-	-30	dB
EVM@802.11ax OFDMA MCS7 Mode 14dBm	-	-	-32	dB

RX Performance

Parameter	Minimum value	Typical value	Maximum value	Unit
PER<8%, RX sensitivity, 802.11b CCK Mode 1M	-	-95	-	dBm
PER<8%, RX sensitivity, 802.11b CCK Mode 11M	-	-86	-	dBm
PER<10%, RX sensitivity, 802.11g OFDM Mode 6M	-	-90	-	dBm
PER<10%, RX sensitivity, 802.11g OFDM Mode 54M	-	-74	-	dBm
PER<10%, RX sensitivity, 802.11n HT20 OFDM Mode MCS0	-	-90	-	dBm
PER<10%, RX sensitivity, 802.11n HT20 OFDM Mode MCS7	-	-71	-	dBm
PER<10%, RX sensitivity, 802.11n HT40 OFDM Mode MCS0	-	-86	-	dBm

Parameter	Minimum value	Typical value	Maximum value	Unit
PER<10%, RX sensitivity, 802.11n HT40 OFDM Mode MCS7	-	-68	-	dBm
PER<10%, RX sensitivity, 802.11ax OFDMA Mode MCS0	-	-90	-	dBm
PER<10%, RX sensitivity, 802.11ax OFDMA Mode MCS7	-	-70	-	dBm
PER<10%, RX sensitivity, Bluetooth 5.1 1M	-	-93	-	dBm
PER<10%, RX sensitivity, Bluetooth 5.1 2M	-	-91	-	dBm

5 Antenna information

5.1 Antenna type

AXY2S uses only the onboard PCB antenna with a gain of 1.97 dBi.

5.2 Antenna interference reduction

To ensure optimal Wi-Fi performance when the Wi-Fi module uses an onboard PCB antenna, it is recommended that the antenna be at least 15 mm away from other metal parts.

6 Packaging information and production instructions

6.1 Mechanical dimensions

The mechanical dimensions of the PCB of AXY2S are 15 ± 0.35 mm (W) \times 17.91 ± 0.35 mm (L) \times 0.8 ± 0.1 mm (H). The following figure shows the mechanical dimensions of AXY2S:

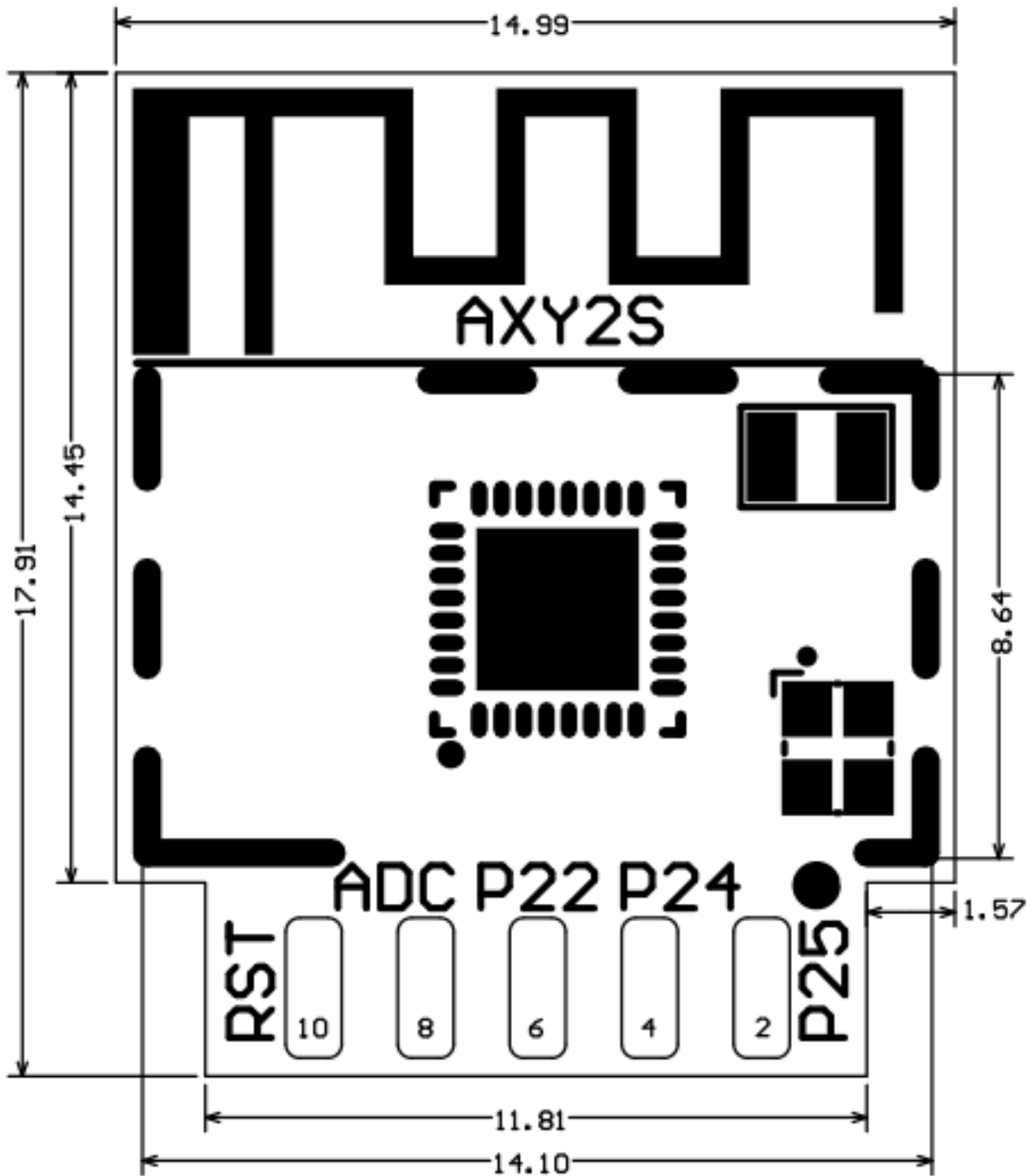

Top View

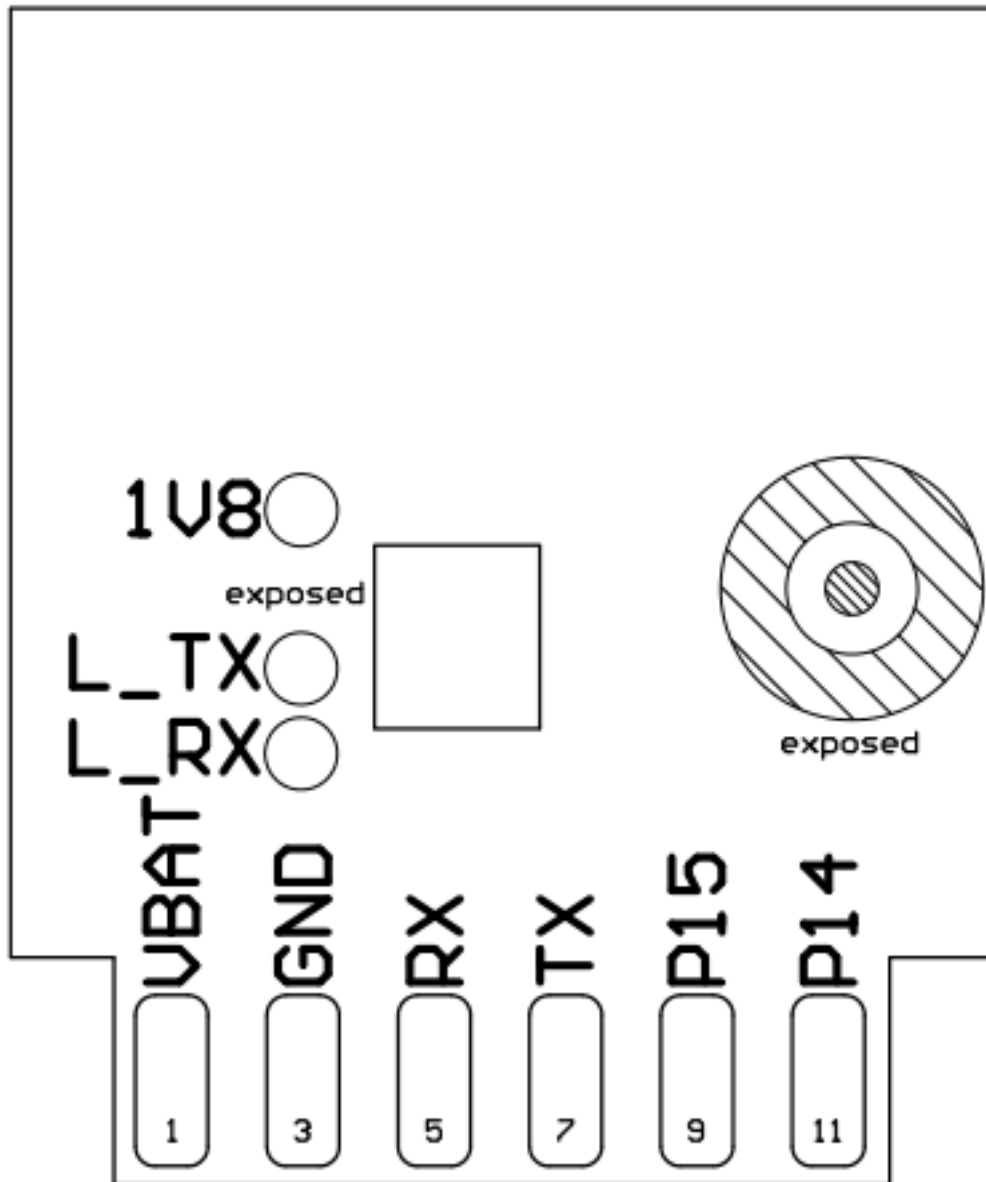

Bottom View



Unit: mm

Module form factor tolerance: ± 0.35 mm

PCB thickness tolerance: ± 0.1 mm

Shield cover height tolerance: ± 0.05 mm

Side View

Note: The default dimensional tolerance is ± 0.35 mm. If customers have specific requirements on dimensions, they should make them clear in the module datasheet after communication.

6.2 Recommended PCB footprint

Schematic diagram of AXY2S which shows how pins correspond:

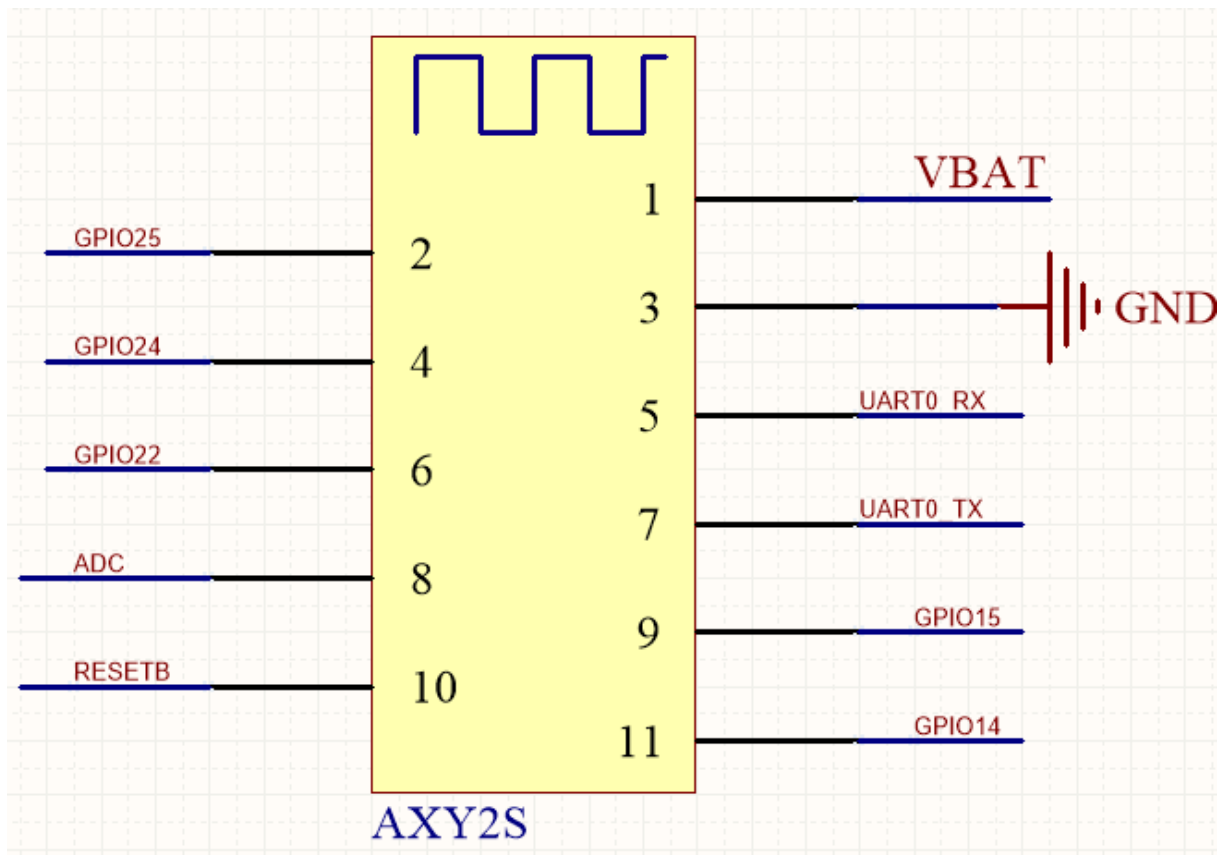

PCB footprint of AXY2S:

Recommended footprint

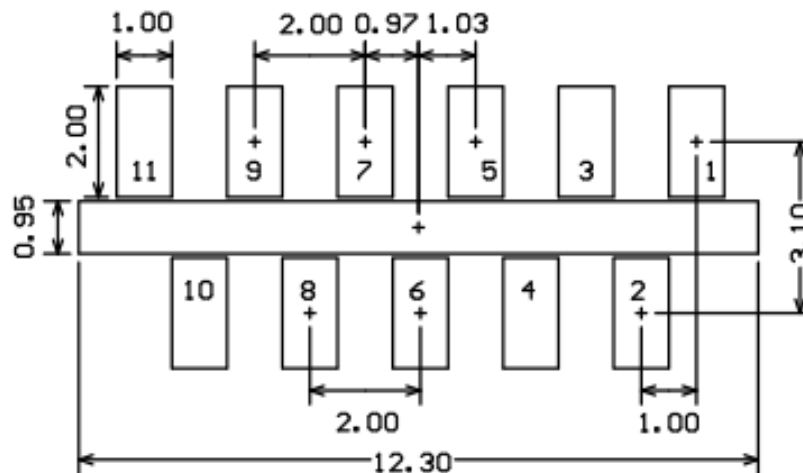

6.3 Production instructions

- For the modules that can be packaged with the SMT or in an in-line way, you can select either of them according to the PCB design solutions of customers. If a PCB is designed to be SMT-packaged, package the module with the SMT. If a PCB is designed to be in-line-packaged, package the module in an in-line way. After being unpacked, the module must be soldered within 24 hours. Otherwise, it needs to be put into the drying cupboard where the relative humidity is not greater than 10%; or it needs to be packaged again under vacuum and the exposure time needs to be recorded (the total exposure time cannot exceed 168 hours).

- (SMT process) SMT devices:
 - Mounter
 - SPI
 - Reflow soldering machine
 - Thermal profiler

- Automated optical inspection (AOI) equipment
- (Wave soldering process) Wave soldering devices
 - Wave soldering equipment
 - Wave soldering fixture
 - Constant-temperature soldering iron
 - Tin bar, tin wire and flux
 - Thermal profiler
- Baking devices:
 - Cabinet oven
 - Anti-electrostatic and heat-resistant trays
 - Anti-electrostatic and heat-resistant gloves

2. Storage conditions for a delivered module:

- The moisture-proof bag must be placed in an environment in which the temperature is below 40°C and the relative humidity is lower than 90%.
- The shelf life of a dry-packaged product is 12 months from the date when the product is packaged and sealed.
- There is a humidity indicator card (HIC) in the packaging bag.

```
1 ! [HIC-SMT and in-line module.png] (https://airtake-public-data-12541
2 53901.cos.ap-shanghai.myqcloud.com/goat/20210410/2c61fd34d2a6464d8cb
3 ee05f63689786.png)
```

3. The module needs to be baked in the following cases:

- The packaging bag is damaged before unpacking.
- There is no humidity indicator card (HIC) in the packaging bag.
- After unpacking, circles of 10% and above on the HIC become pink.
- The total exposure time has lasted for over 168 hours since unpacking.
- More than 12 months has passed since sealing of the bag.

4. Baking settings:

- Temperature: 60°C and $\leq 5\%$ RH for reel package and 125°C and $\leq 5\%$ RH for tray package (please use the heat-resistant tray rather than plastic container)
- Time: 48 hours for reel package and 12 hours for tray package
- Alarm temperature: 65°C for reel package and 135°C for tray package
- Production-ready temperature after natural cooling: $< 36^\circ\text{C}$

- Re-baking situation: If a module remains unused for over 168 hours after being baked, it needs to be baked again.
 - If a batch of modules is not baked within 168 hours, do not use the reflow soldering or wave soldering to solder them. Because these modules are Level-3 moisture-sensitive devices, they are very likely to get damp when exposed beyond the allowable time. In this case, if they are soldered at high temperatures, it may result in device failure or poor soldering.
5. In the whole production process, take electrostatic discharge (ESD) protective measures.
 6. To guarantee the passing rate, it is recommended that you use the SPI and AOI to monitor the quality of solder paste printing and mounting.

6.4 Recommended oven temperature curve

Select a proper soldering manner according to the process. For the SMT process, please refer to the recommended oven temperature curve of reflow soldering. For the wave soldering process, please refer to the recommended oven temperature curve of wave soldering. There are some differences between the set temperatures and the actual temperatures. All the temperatures shown in this module datasheet are obtained through actual measurements.

Manner 1: SMT process (Recommended oven temperature curve of reflow soldering)

Set oven temperatures according to the following curve.

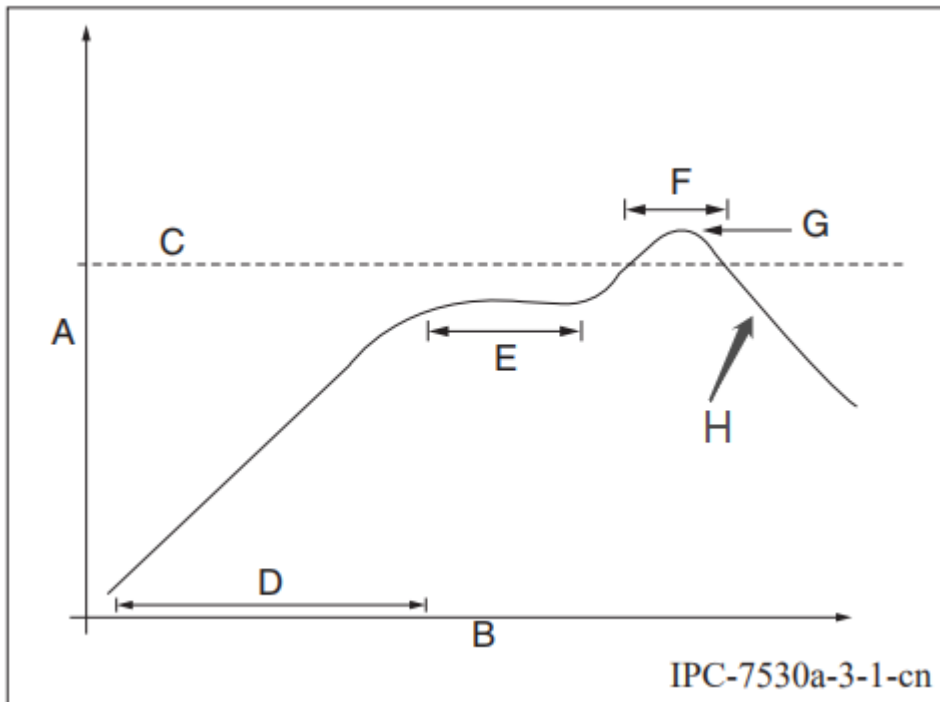

- A: Temperature axis
- B: Time axis
- C: Liquidus temperature: 217 to 220°C
- D: Ramp-up slope: 1 to 3°C/s
- E: Duration of constant temperature: 60 to 120s; the range of constant temperature: 150 to 200°C
- F: Duration above the liquidus: 50 to 70s
- G: Peak temperature: 235 to 245°C
- H: Ramp-down slope: 1 to 4°C/s

Note: The above curve is just an example of the solder paste SAC305. For more details about other solder pastes, please refer to Recommended oven temperature curve in the solder paste specifications.

Manner 2: Wave soldering process (Oven temperature curve of wave soldering)

Set oven temperatures according to the following temperature curve of wave soldering. The peak temperature is 260°C±5°C.

DIP Type Product Pass Wavesolder Graph

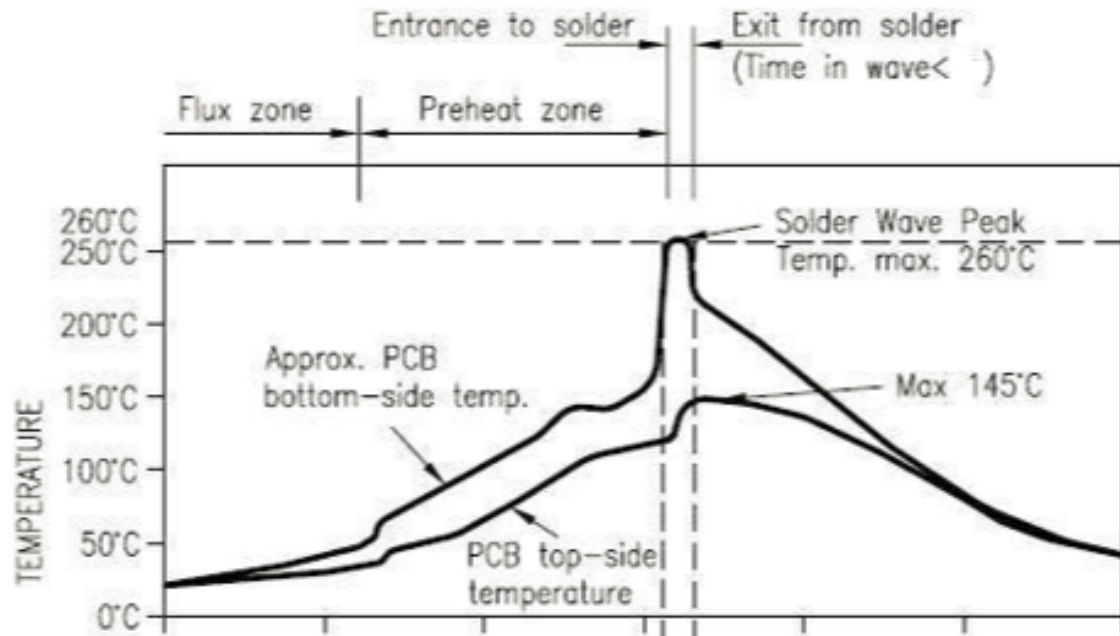

Suggestions on oven temperature curve of wave soldering

Suggestions on manual soldering temperature

Preheat temperature	80 to 130 °C	Soldering temperature	360±20°C
Preheat time	75 to 100s	Soldering time	< 3s/point
Peak contact time	3 to 5s	NA	NA
Temperature of tin cylinder	260±5°C	NA	NA
Ramp-up slope	≤2°C/s	NA	NA
Ramp-down slope	≤6°C/s	NA	NA

6.5 Storage conditions



Caution

This bag contains
MOISTURE-SENSITIVE DEVICES

LEVEL

3

If blank, see adjacent
bar code label

1. Calculated shelf life in sealed bag: 12 months at <math><40^{\circ}\text{C}</math> and <math><90\%</math> relative humidity (RH)
2. Peak package body temperature: 260 °C
If blank, see adjacent bar code label
3. After bag is opened, devices that will be subjected to reflow solder or other high temperature process must be
 - a) Mounted within: 168 hours of factory conditions
If blank, see adjacent bar code label
≤30°C/60% RH, or
 - b) Stored per J-STD-033
4. Devices require bake, before mounting, if:
 - a) Humidity Indicator Card reads >10% for level 2a - 5a devices or >60% for level 2 devices when read at 23 ± 5°C
 - b) 3a or 3b are not met
5. If baking is required, refer to IPC/JEDEC J-STD-033 for bake procedure

Bag Seal Date: _____
If blank, see adjacent bar code label

Note: Level and body temperature defined by IPC/JEDEC J-STD-020

7 MOQ and packaging information

Product model	MOQ (pcs)	Packaging method	The number of modules per reel	The number of reels per carton
AXY2S	4400	Tape reel	1100	4

8 Appendix: Statement

FCC Caution: Any changes or modifications not expressly approved by the party responsible for compliance could void the user's authority to operate this device.

This device complies with Part 15 of the FCC Rules. Operation is subject to the following two conditions: (1) This device may not cause harmful interference, and (2) this device must accept any interference received, including interference that may cause undesired operation.

Note: This device has been tested and found to comply with the limits for a Class B digital device, according to part 15 of the FCC Rules. These limits are designed to provide reasonable protection against harmful interference in a residential installation. This device generates, uses, and can radiate radio frequency energy and, if not installed and used following the instructions, may cause harmful interference to radio communications. However, there is no guarantee that interference will not occur in a particular installation.

If this device does cause harmful interference to radio or television reception, which can be determined by turning the device off and on, the user is encouraged to try to correct the interference by one or more of the following measures:

- Reorient or relocate the receiving antenna.
- Increase the separation between the device and receiver.
- Connect the device into an outlet on a circuit different from that to which the receiver is connected.
- Consult the dealer or an experienced radio/TV technician for help.

Radiation Exposure Statement

This device complies with FCC radiation exposure limits set forth for an uncontrolled rolled environment. This device should be installed and operated with a minimum distance of 20cm between the radiator and your body.

Important Note

This radio module must not be installed to co-locate and operate simultaneously with other radios in the host system except following FCC multi-transmitter product procedures. Additional testing and device authorization may be required to operate simultaneously with other radios.

The availability of some specific channels and/or operational frequency bands are country dependent and are firmware programmed at the factory to match the intended destination. The firmware setting is not accessible by the end-user.

The host product manufacturer is responsible for compliance with any other FCC rules that apply to the host not covered by the modular transmitter grant of certification. The final host product still requires Part 15 Subpart B compliance testing with the modular transmitter installed.

The end-user manual shall include all required regulatory information/warnings as shown in this manual, including “This product must be installed and operated with a minimum distance of 20 cm between the radiator and user body” .

This device has got an FCC ID: 2ANDL-AXY2S. The end product must be labelled in a visible area with the following: “Contains Transmitter Module FCC ID: 2ANDL-AXY2S” .

This device is intended only for OEM integrators under the following conditions:

The antenna must be installed such that 20cm is maintained between the antenna and users, and the transmitter module may not be co-located with any other transmitter or antenna.

As long as the 2 conditions above are met, further transmitter tests will not be required. However, the OEM integrator is still responsible for testing their end-product for any additional compliance requirements required with this module installed.

Declaration of Conformity European Notice



Hereby, Hangzhou Tuya Information Technology Co., Ltd declares that this module product complies with essential requirements and other relevant provisions of Directive 2014/53/EU, 2011/65/EU. A copy of the Declaration of conformity can be found at <https://www.tuya.com>.



This product must not be disposed of as normal household waste, by the EU directive for waste electrical and electronic equipment (WEEE-2012/19/EU). Instead, it should be disposed of by returning it to the point of sale, or to a municipal recycling collection point.

The device could be used with a separation distance of 20cm.