

# FCC RADIO TEST REPORT

**FCC ID:2ANDK-E05S**

Report Reference No..... : 17FAS07048 31  
Date of issue ..... : 2017-07-14  
FCC 2.948 No ..... : 923232  
Testing Laboratory ..... : ATT Product Service Co., Ltd.  
Address..... : No. 3, ChangLianShan Industrial Park, ChangAn Town,  
DongGuan City, GuangDong, China.

Applicant's name..... : ISONWIFI.  
Address..... : 3/F, Building 1, Henghui Science and Technology Park,  
Yuxing Road NO.63, GuangMing New District, Shenzhen,  
China.

Manufacturer..... : ISONWIFI.  
Address..... : 3/F, Building 1, Henghui Science and Technology Park,  
Yuxing Road NO.63, GuangMing New District, Shenzhen,  
China.

**Test specification:**

Test item description..... : Smart-Home Wi-Fi System  
Trade Mark..... : ISONWIFI  
Model/Type reference..... : E05S  
Ratings..... : I/P: DC12V/1.5A

Responsible Engineer :

  
\_\_\_\_\_  
Simle Wang

Authorized Signatory:

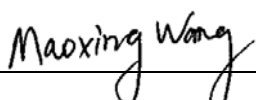
  
\_\_\_\_\_  
Maoxing Wang

## TABLE OF CONTENTS

1. Summary of test Standards and results .....	4
2.1. Accretations.....	5
2.2. Description of EUT .....	5
2.3. Accessories of EUT.....	5
2.4. Assistant equipment used for test.....	5
2.5. Block diagram of EUT configuration for test.....	6
2.6. Test environment conditions.....	6
2.7. Measurement uncertainty.....	7
3. 6dB Bandwidth and 99% Occupied Bandwidth.....	7
3.1. Test equipment .....	7
3.2. Block diagram of test setup.....	7
3.3. Limits .....	7
3.4. Test Procedure .....	7
3.5. Test Result.....	8
3.6. Original test data.....	8
4. Maximum Peak Output Power .....	15
4.1. Test equipment .....	15
4.2. Block diagram of test setup.....	15
4.3. Limits .....	15
4.4. Test Procedure .....	15
5. Power Spectral Density.....	17
5.1. Test equipment .....	17
5.2. Block diagram of test setup.....	17
5.3. Limits .....	17
5.5. Test Result.....	18
5.6. Original test data.....	19
6. Spurious Emissions.....	25
6.1. Test equipment .....	25
6.2. Block diagram of test setup.....	25
6.3. Limit .....	26
6.5. Test result.....	29
7. 100 kHz Bandwidth of Frequency Band Edge.....	36
7.1. Test equipment .....	36
7.2. Block diagram of test setup.....	36
7.3. Limit .....	36

7.4. Test Procedure .....	37
7.5. Test result .....	37
8 Power Line Conducted Emission.....	42
8.1 Test equipment .....	42
8.2 Block diagram of test setup.....	42
8.3 Power Line Conducted Emission Limits(Class B) .....	42
8.4 Test Procedure.....	43
8.5 Test Result.....	43
9. Antenna Requirements .....	46
9.1. Limit .....	46
9.2. Result .....	46

## TEST REPORT DECLARE

<b>Applicant</b>	:	ISONWIFI
<b>Address</b>	:	3/F, Building 1, Henghui Science and Technology Park, Yuxing Road NO.63, GuangMing New District, Shenzhen, China
<b>Equipment under Test</b>	:	Smart-Home Wi-Fi System
<b>Model No</b>	:	E05S
<b>Trade Mark</b>	:	ISONWIFI
<b>Manufacturer</b>	:	ISONWIFI
<b>Address</b>	:	3/F, Building 1, Henghui Science and Technology Park, Yuxing Road NO.63, GuangMing New District, Shenzhen, China

**Test Standard Used:** FCC Rules and Regulations Part 15 Subpart C : 2015.

**Test procedure used:** ANSI C63.10:2013, ANSI C63.4:2014, 558074 V03R05.

**We Declare:**

The equipment described above is tested by ATT Product Service Co., Ltd. and in the configuration tested the equipment complied with the standards specified above. The test results are contained in this test report and ATT Product Service Co., Ltd. is assumed of full responsibility for the accuracy and completeness of these tests.

**After test and evaluation, our opinion is that the equipment provided for test compliance with the requirement of the above FCC standards.**

<b>Report No:</b>	17FAS07048 31		
<b>Date of Test:</b>	2017-07-08---2017-07-12	<b>Date of Report:</b>	2017-07-14

Note: This report applies to above tested sample only. This report shall not be reproduced in parts without written approval of ATT Product Service Co., Ltd.

## 1. Summary of test Standards and results

The EUT have been tested according to the applicable standards as referenced below.

Description of Test Item	Standard	Results
6dB Bandwidth And 99% Occupied Bandwidth	§15.247 (a)(2)	PASS
Peak Output Power	§15.247(b)(3)	PASS
Power Spectral Density	§15.247(e)	PASS
Spurious Emissions at Antenna Port	§15.247(d)	PASS
Spurious Emissions	§15.205, §15.209, §15.247(d)	PASS
100 kHz Bandwidth of Frequency Band Edge	§15.247(d)	PASS
AC Line Conducted Emissions	§15.207 (a)	PASS
Antenna requirement	FCC Part 15: 15.203	PASS

## 2. GENERAL TEST INFORMATION

### 2.1. Accreditations

The measuring facility of laboratories has been authorized or registered by the following approval agencies.

**USA                      FCC    Registration Number :923232**

### 2.2. Description of EUT

EUT* Name	:	Smart-Home Wi-Fi System
Model Number	:	E05S
Trade Mark	:	ISONWIFI
EUT function description	:	Please reference user manual of this device
Power supply	:	DC12V/1.5A
Radio Specification	:	IEEE802.11b/g/n20/n40
Operation frequency	:	IEEE 802.11b: 2412MHz—2462MHz IEEE 802.11g: 2412MHz—2462MHz IEEE 802.11n20: HT20: 2412MHz—2462MHz IEEE 802.11n40: HT40: 2422MHz—2452MHz
Modulation	:	IEEE 802.11b: DSSS(CCK,DQPSK,DBPSK) IEEE 802.11g: OFDM(64QAM, 16QAM, QPSK, BPSK) IEEE 802.11n20: HT20: OFDM (64QAM, 16QAM, QPSK,BPSK) IEEE 802.11n40: HT40: OFDM (64QAM, 16QAM, QPSK,BPSK)
Antenna Type	:	PCB antenna,maximum PK gain: 8 dBi
Date of Receipt	:	2017-07-07
Sample Type	:	Series production

Note: EUT is the ab. of equipment under test.

### 2.3. Accessories of EUT

Description of Accessories	Manufacturer	Model number or Type	Other
/	/	/	/

### 2.4. Assistant equipment used for test

Description of Assistant equipment	Manufacturer	Model number or Type	Other
Notebook	acer	Aspire E1-472G	FCC DoC

## 2.5. Block diagram of EUT configuration for test

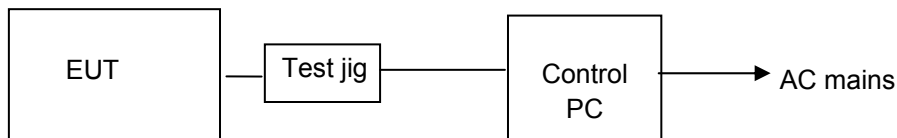

EUT was connected to control to a special test jig provided by manufacturer which has a standard RSS-232 connector to connect to Notebook, and the Notebook will run a special test software “7620QA” provided by manufacturer to control EUT work in test mode as blow table.

Tested mode, channel, and data rate information			
Mode	data rate (Mbps) (see Note)	Channel	Frequency (MHz)
IEEE 802.11b	1	Low :CH1	2412
	1	Middle: CH6	2437
	1	High: CH11	2462
IEEE 802.11g	6	Low :CH1	2412
	6	Middle: CH6	2437
	6	High: CH11	2462
IEEE 802.11n HT20	MCS 0	Low :CH1	2412
	MCS 0	Middle: CH6	2437
	MCS 0	High: CH11	2462
IEEE 802.11n HT40	MCS 0	Low :CH3	2422
	MCS 0	Middle: CH6	2437
	MCS 0	High: CH9	2452

Note: According exploratory test, EUT will have maximum output power in those data rate, so those data rate were used for all test. (Dutycycle>98%)

## 2.6. Test environment conditions

During the measurement the environmental conditions were within the listed ranges:

Temperature range:	21-25°C
Humidity range:	40-75%
Pressure range:	86-106kPa

## 2.7. Measurement uncertainty

Test Item	Uncertainty
Uncertainty for Conduction emission test	2.44dB
Uncertainty for Radiation Emission test (150KHz-30MHz)	3.21dB
Uncertainty for Radiation Emission test (30MHz-1GHz)	3.14 dB (Polarize: V)
	3.16 dB (Polarize: H)
Uncertainty for Radiation Emission test (1GHz to 25GHz)	2.08dB(Polarize: V)
	2.56dB (Polarize: H)
Uncertainty for radio frequency	1×10 <sup>-9</sup>
Uncertainty for conducted RF Power	0.65dB

Note: This uncertainty represents an expanded uncertainty expressed at approximately the 95% confidence level using a coverage factor of k=2.

## 3. 6dB Bandwidth and 99% Occupied Bandwidth

### 3.1. Test equipment

Item	Equipment	Manufacturer	Model No.	Serial No.	Cal Due.	Cal. Interval
1	Spectrum analyzer	KEYSIGHT	N9010A	MY55150427	2018/05/26	1 Year
2	Attenuator	Mini-Circuits	BW-S10W2	101109	2017/12/18	1 Year
3	RF Cable	Micable	C10-01-01-1	100309	2017/12/18	1 Year

### 3.2. Block diagram of test setup

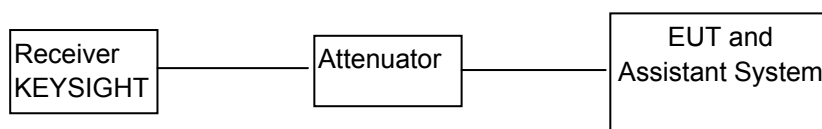

### 3.3. Limits

For direct sequence systems, the minimum 6dB bandwidth shall be at least 500 KHz

### 3.4. Test Procedure

- (1) Check the calibration of the measuring instrument using either an internal calibrator or a known signal from an external generator.
- (2) Position the EUT without connection to measurement instrument. Turn on the EUT and connect it to measurement instrument. Then set it to any one convenient frequency within its operating range. Set a reference level on the measuring instrument equal to the highest peak value.
- (3) Measure the frequency difference of two frequencies that were attenuated 6 dB from the reference level. Record the frequency difference as the emission bandwidth.
- (4) Repeat above procedures until all frequencies measured were complete.



### 3.5. Test Result

EUT Set Mode	CH or Frequency	6 dB bandwidth	99% dB bandwidth	Limt	Conclusion
		Result (MHz)	Result (MHz)		
11b	CH1	10.07	12.25	>500KHz	PASS
	CH6	10.05	12.24	>500KHz	PASS
	CH11	10.06	12.24	>500KHz	PASS
11g	CH1	16.38	16.48	>500KHz	PASS
	CH6	16.40	16.49	>500KHz	PASS
	CH11	16.39	16.48	>500KHz	PASS
11n HT 20	CH1	17.56	17.58	>500KHz	PASS
	CH6	17.32	17.57	>500KHz	PASS
	CH11	17.30	17.58	>500KHz	PASS
11n HT 40	CH3	36.33	36.18	>500KHz	PASS
	CH6	35.78	36.17	>500KHz	PASS
	CH9	35.78	36.17	>500KHz	PASS

### 3.6. Original test data

802.11 b Mode

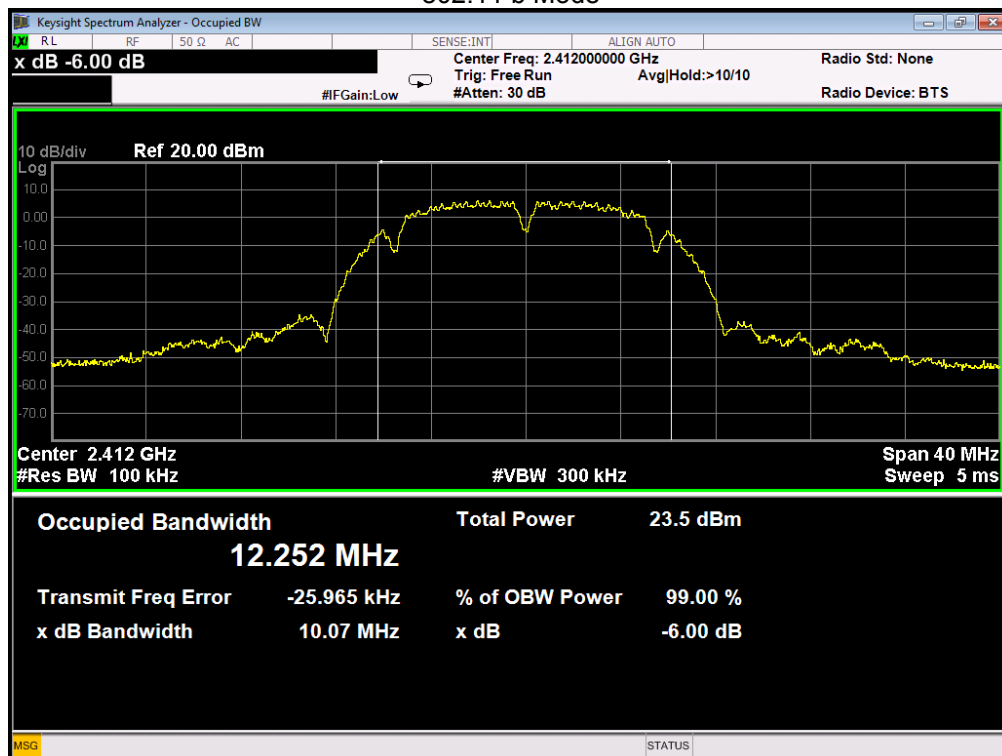

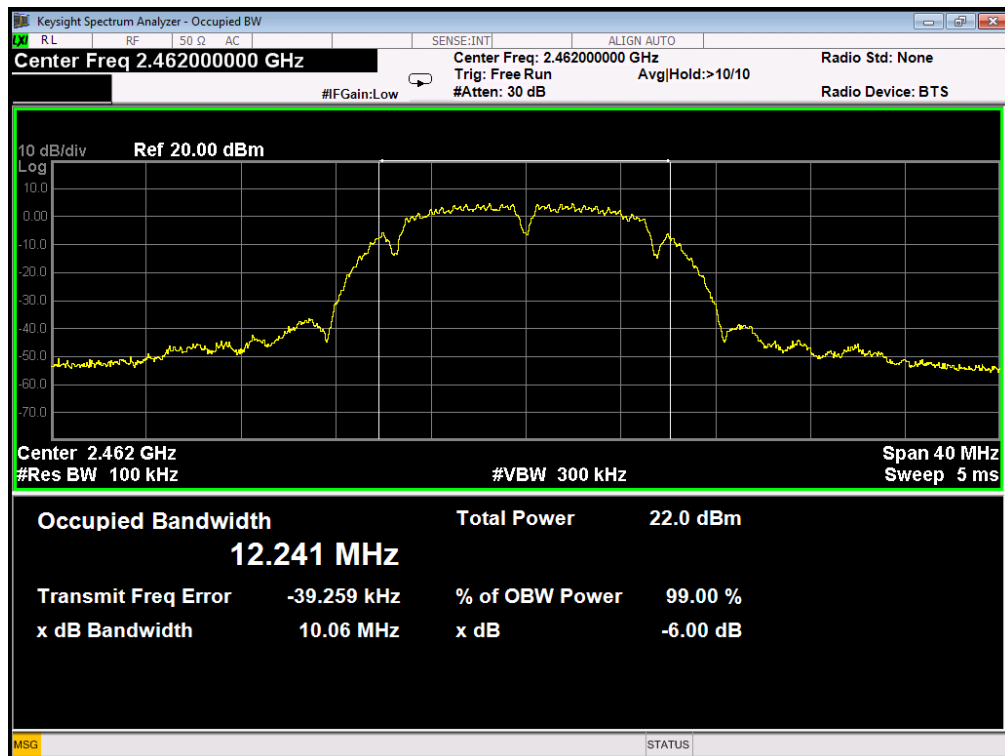
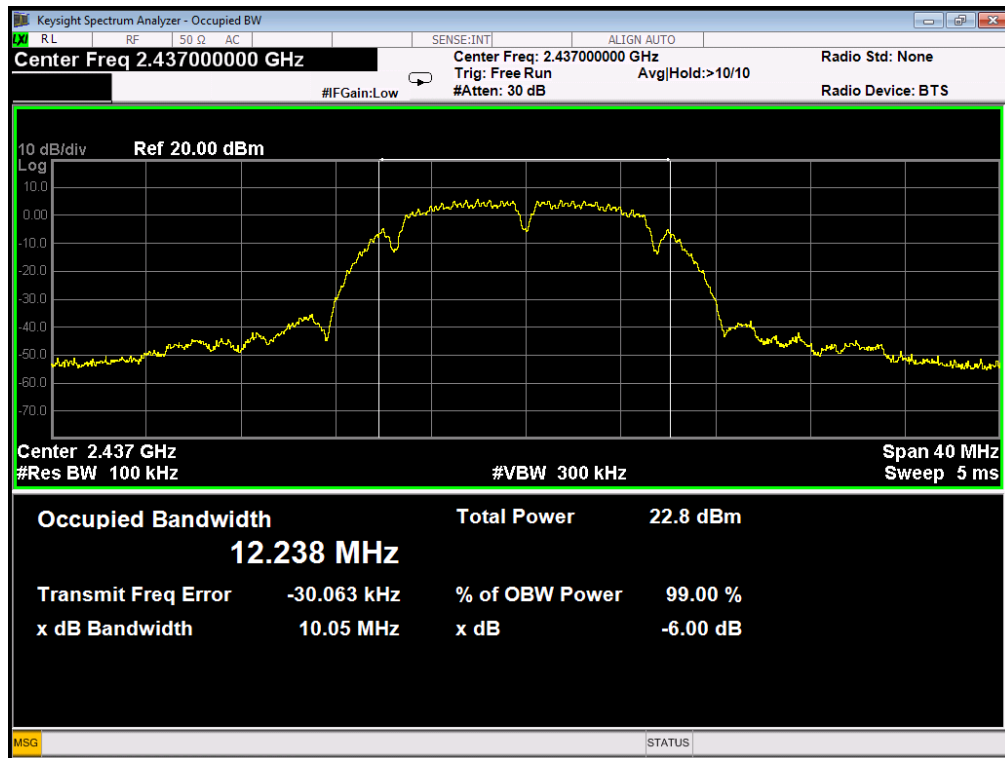

## 802.11 g Mode

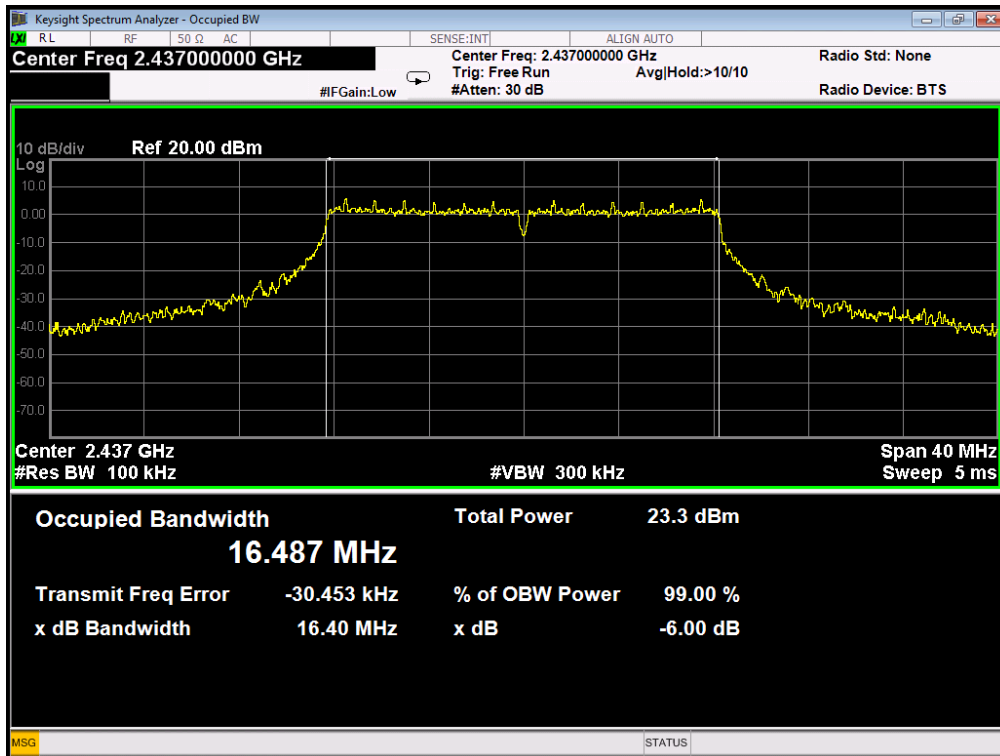
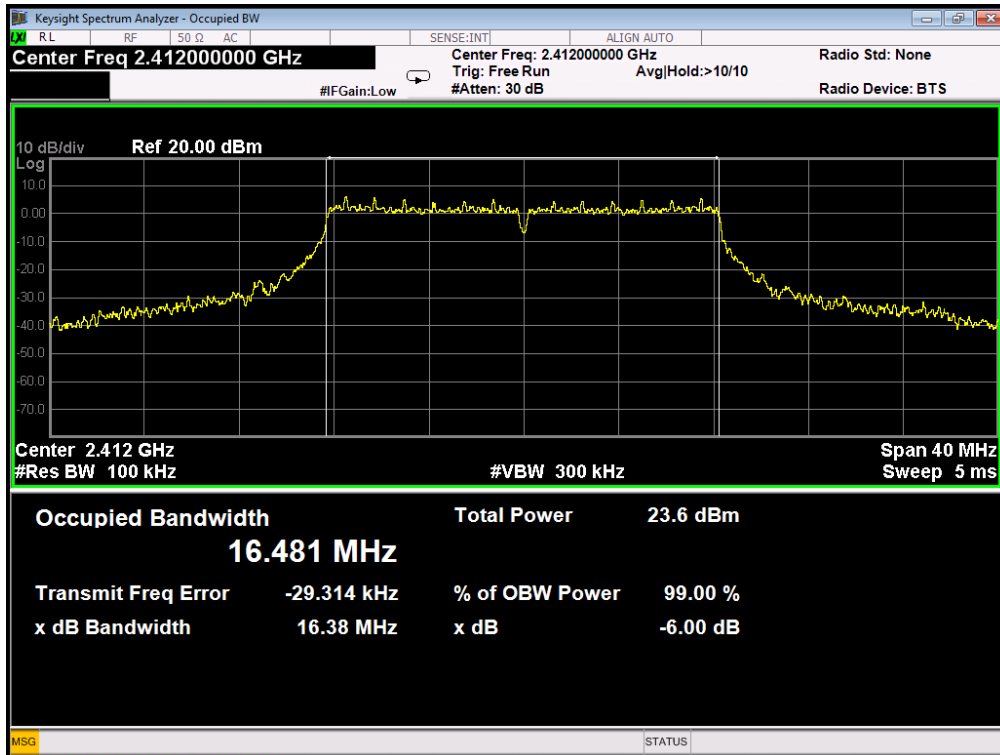

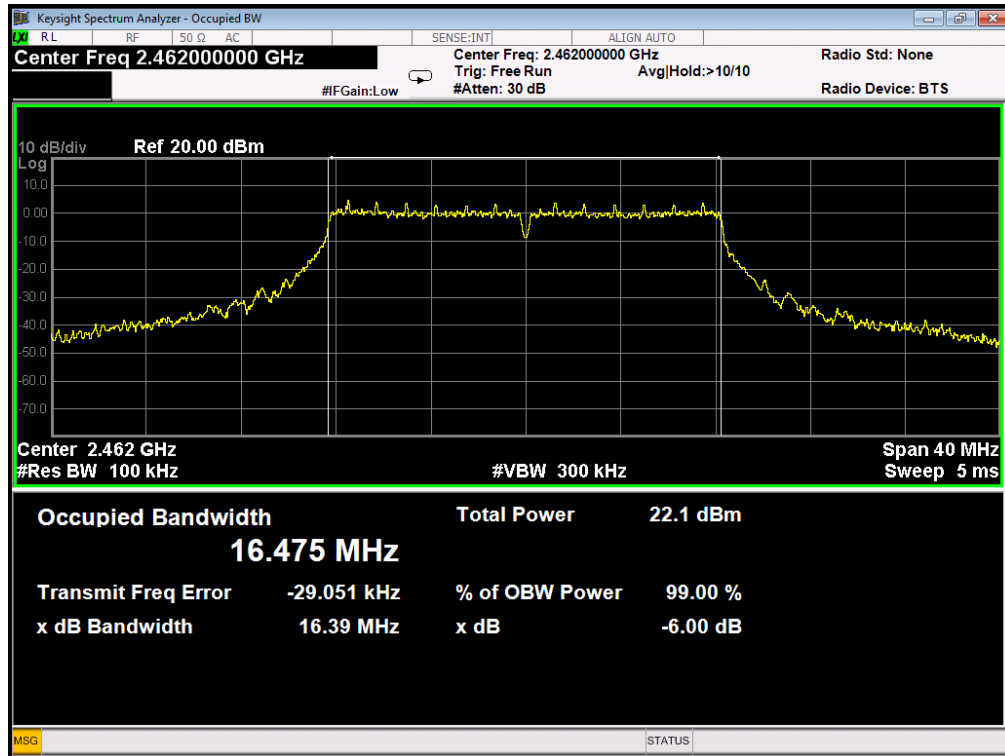

802.11 n20

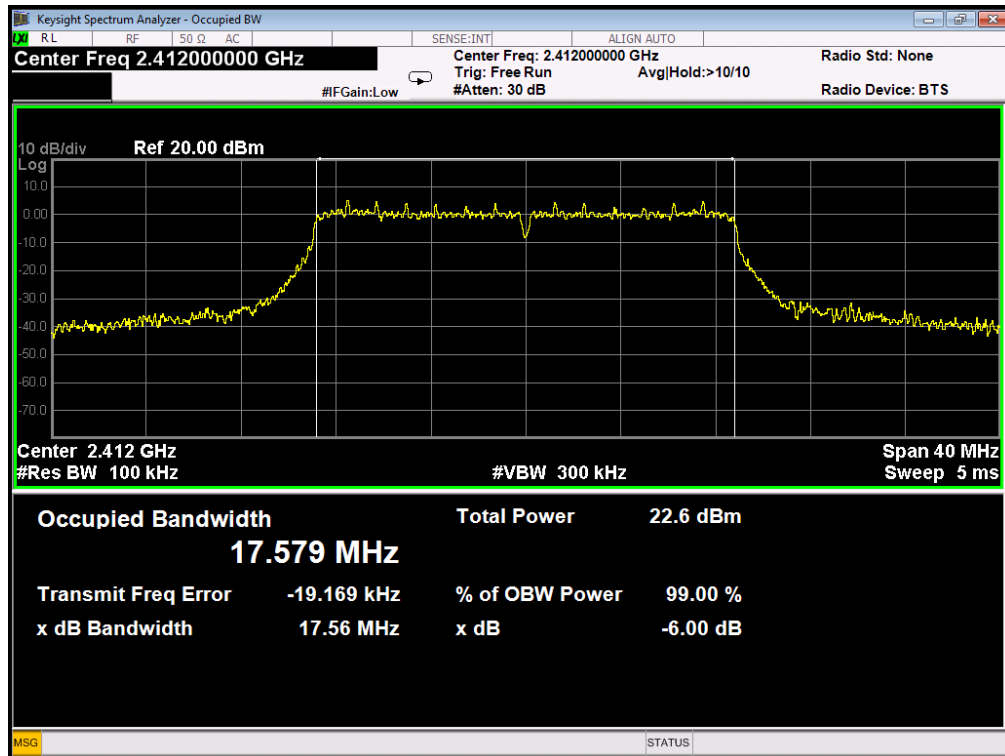

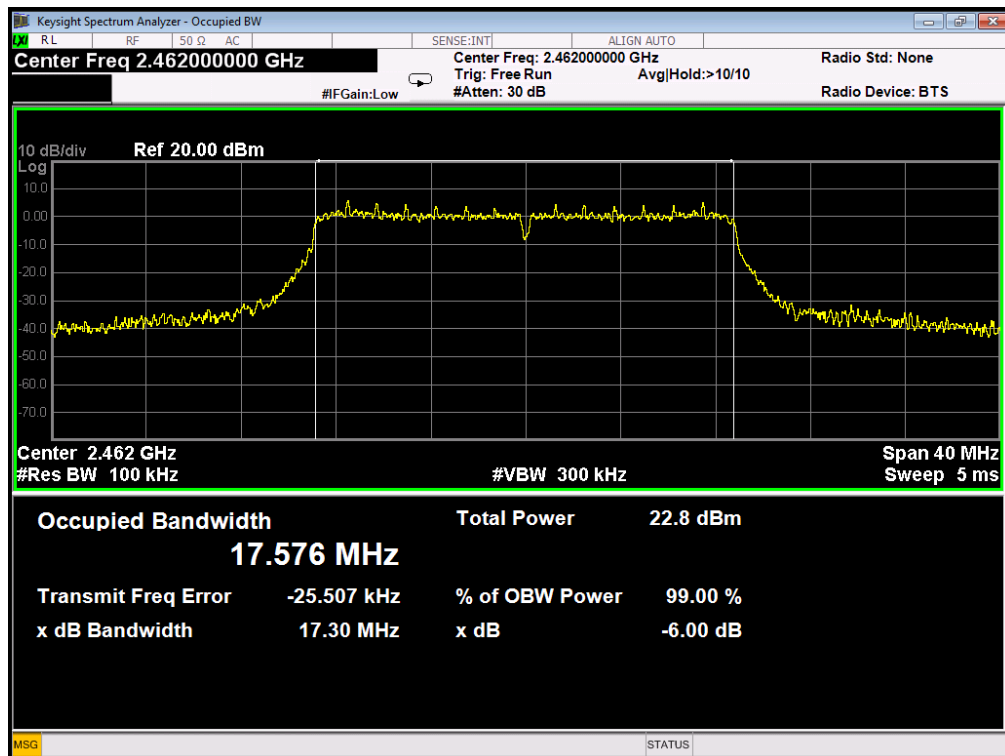
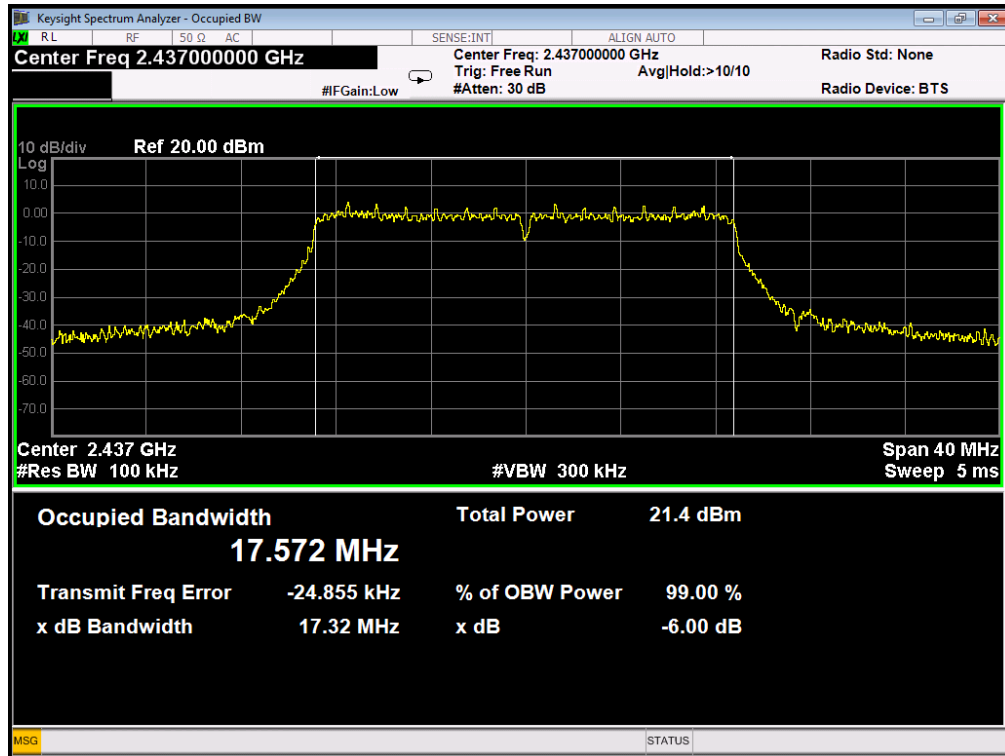

802.11 n40

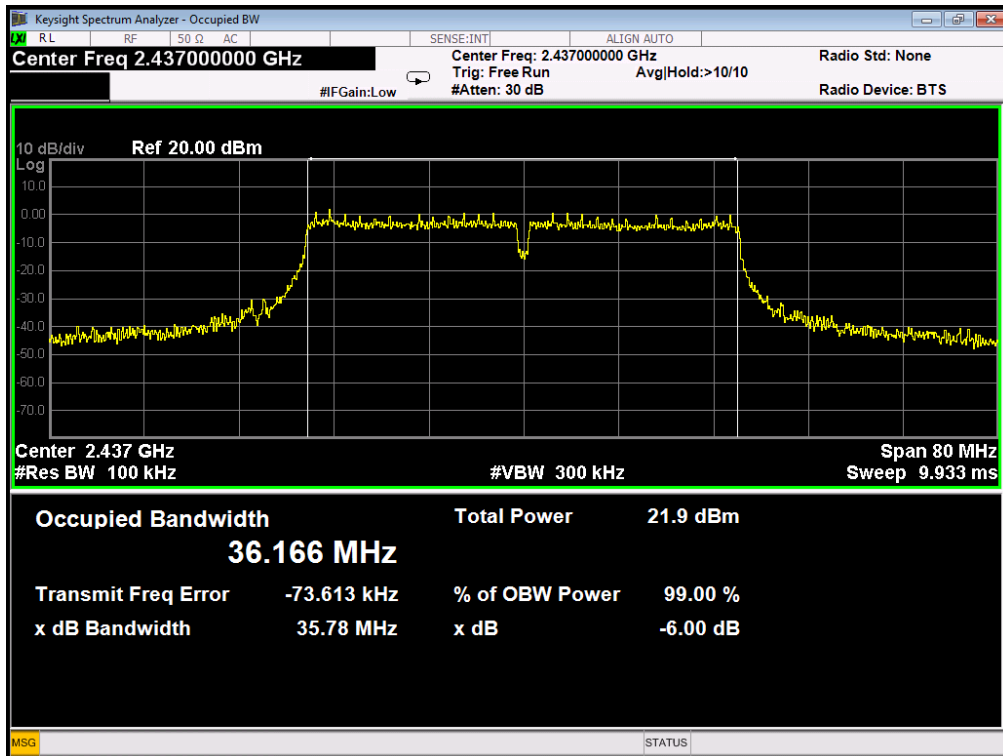
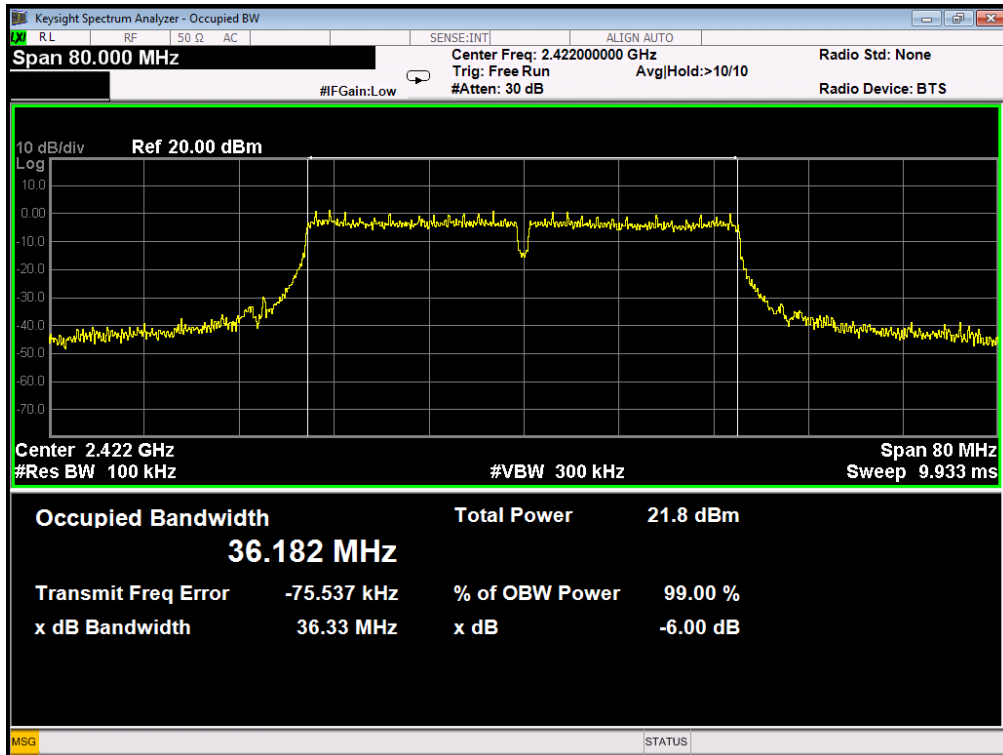

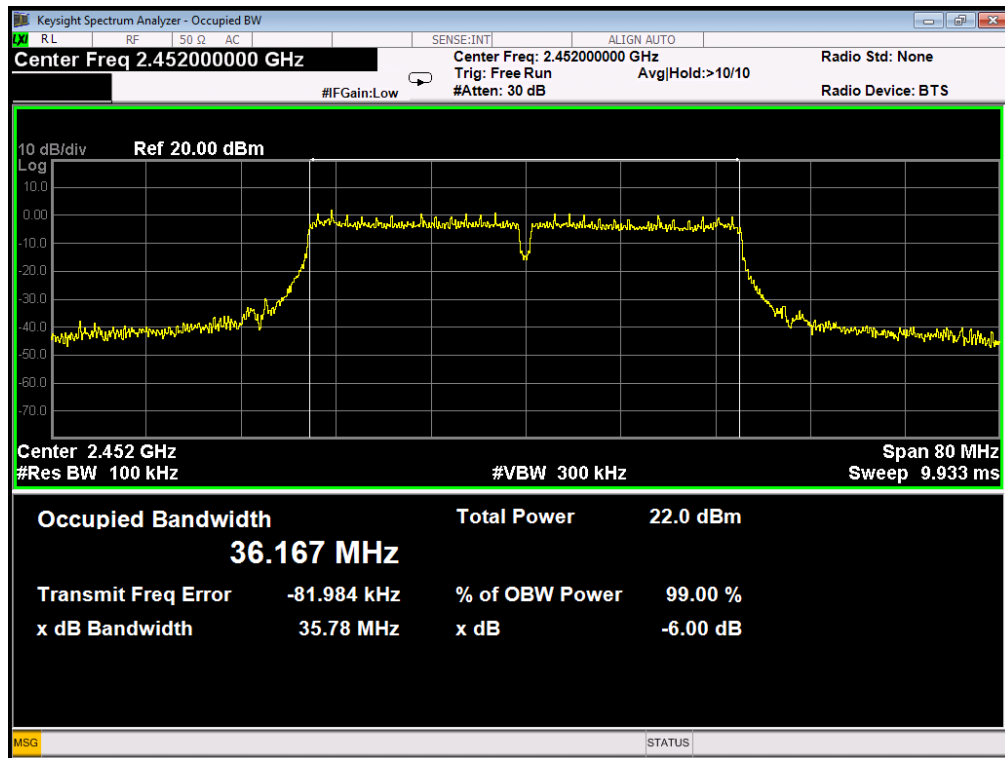

## 4. Maximum Peak Output Power

### 4.1. Test equipment

Item	Equipment	Manufacturer	Model No.	Serial No.	Calibrated until	Cal. Interval
2	Wireband Power sensor	Agilent	U2021XA	MY55270002	2018/05/26	1 Year

### 4.2. Block diagram of test setup

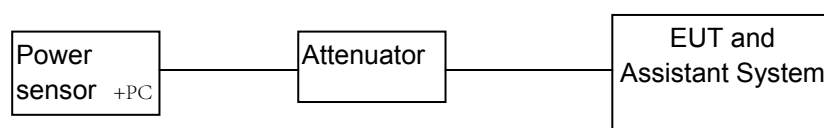

### 4.3. Limits

For systems using digital modulation in the 902-928 MHz, 2400-2483.5 MHz bands: 1 Watt. If transmitting antennas of directional gain greater than 6 dBi are used, the conducted output power from the intentional radiator shall be reduced below the stated values as appropriate, by the amount in dB that the directional gain of the antenna exceeds 6 dBi.

### 4.4. Test Procedure

1. Place the EUT on a bench and set it in transmitting mode.
2. A wide band power meter with a matched thermocouple detector was used to directly measure the output power from the RF output port of the EUT in continuously transmitting mode.
3. The measurement shall be repeated at the lowest, the middle, and the highest channel of the stated frequency range.



### 4.5. TEST RESULT

EUT Set Mode	Limit(Peak)	Conclusion	CH	Result(dBm)
				Peak
11b	28dBm	PASS	CH1	19.71
			CH6	19.36
			CH11	19.20
11g	28dBm	PASS	CH1	24.16
			CH6	24.38
			CH11	24.07
11n HT20	28dBm	PASS	CH1	25.32
			CH6	24.79
			CH11	24.64
11n HT40	28dBm	PASS	CH3	25.33
			CH6	25.14
			CH9	24.96

NOTE: limit is  $30-(8-6)=28\text{dBm}$

## 5. Power Spectral Density

### 5.1. Test equipment

Item	Equipment	Manufacturer	Model No.	Serial No.	Cal Due.	Cal. Interval
1	Spectrum analyzer	KEYSIGHT	N9010A	MY55150427	2018/05/26	1 Year
2	Attenuator	Mini-Circuits	BW-S10W2	101109	2017/12/18	1 Year
3	RF Cable	Micable	C10-01-01-1	100309	2017/12/18	1 Year

### 5.2. Block diagram of test setup

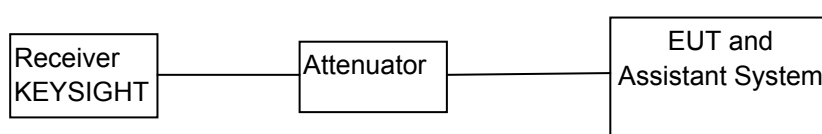

### 5.3. Limits

For digitally modulated systems, the power spectral density conducted from the intentional radiator to the antenna shall not be greater than 8dBm in any 3 kHz band during any time interval of continuous transmission.

### 5.4. TEST PROCEDURE

1. Check the calibration of the measuring instrument using either an internal calibrator or a known signal from an external generatorl.
2. Position the EUT was set without connection to measurement instrument. Turn on the EUT and connect its antenna terminal to measurement instrument via a low loss cable. Then set it to any one measured frequency within its operating range, and make sure the instrument is operated in its linear range
3. According to KDB 558074 D01 DTS Meas Guidance v03, set the RBW = 3 kHz, VBW = 30 kHz, Set the span to 1.5 times the DTS channel bandwidth.
4. Use the peak marker function to determine the maximum power level in any 3 kHz band segment within the fundamental EBW

### 5.5. Test Result

EUT Set Mode	CH or Frequency	Result dBm	Limit: <dBm/3KHz	Conclusion
11b	CH1	-9.96	8	PASS
	CH6	-9.86	8	PASS
	CH11	-10.90	8	PASS
11g	CH1	-9.73	8	PASS
	CH6	-9.57	8	PASS
	CH11	-12.40	8	PASS
11n HT 20	CH1	-10.10	8	PASS
	CH6	-9.38	8	PASS
	CH11	-10.71	8	PASS
11n HT 40	CH3	-12.18	8	PASS
	CH6	-12.32	8	PASS
	CH9	-13.14	8	PASS

## 5.6. Original test data

802.11 b Mode

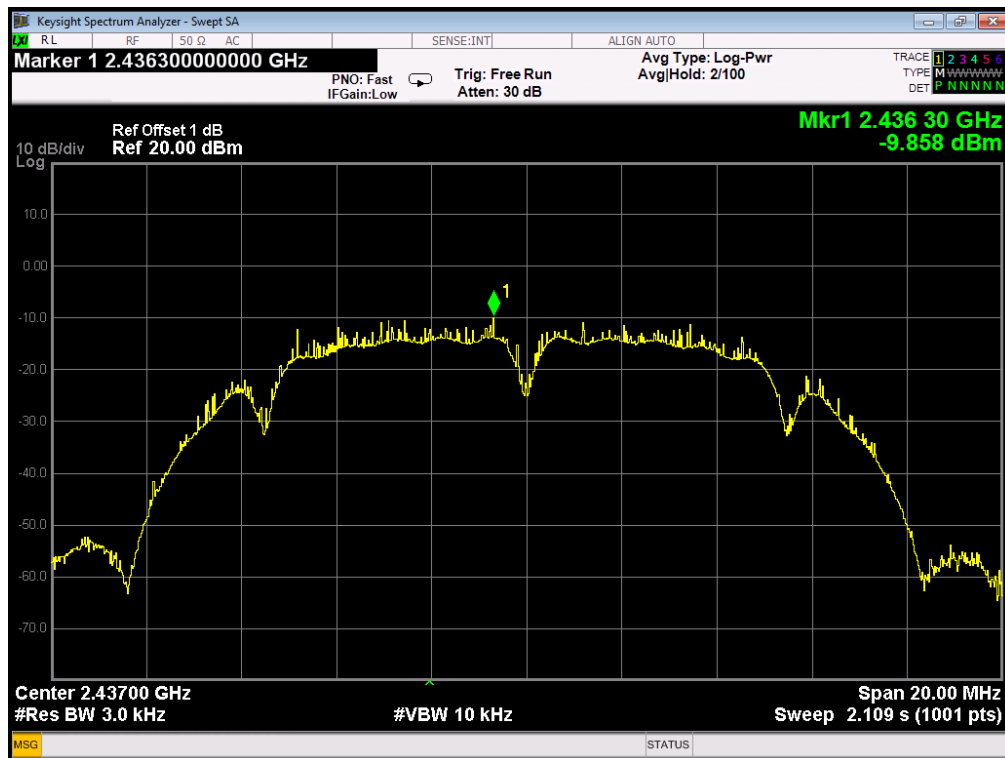
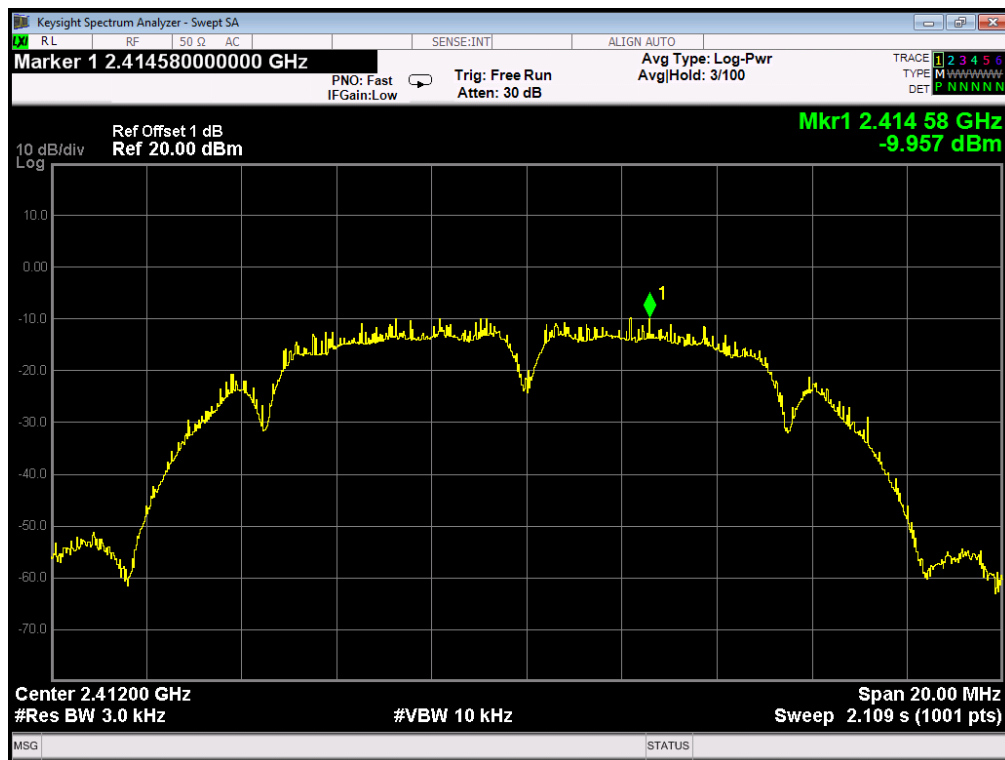

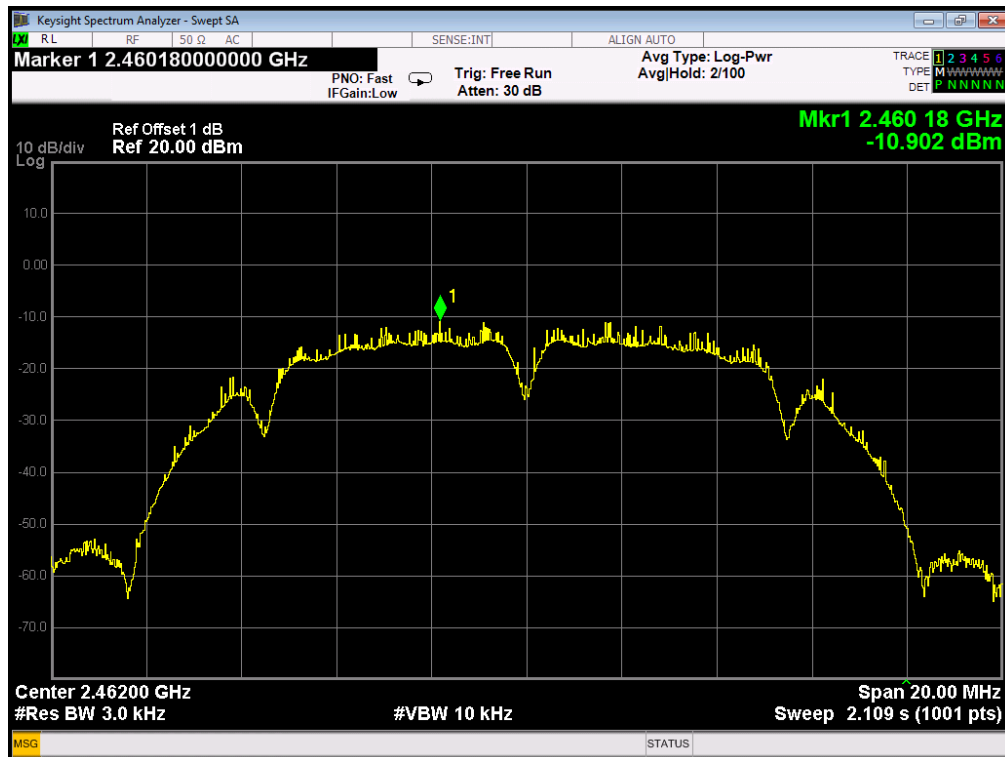

802.11 g Mode

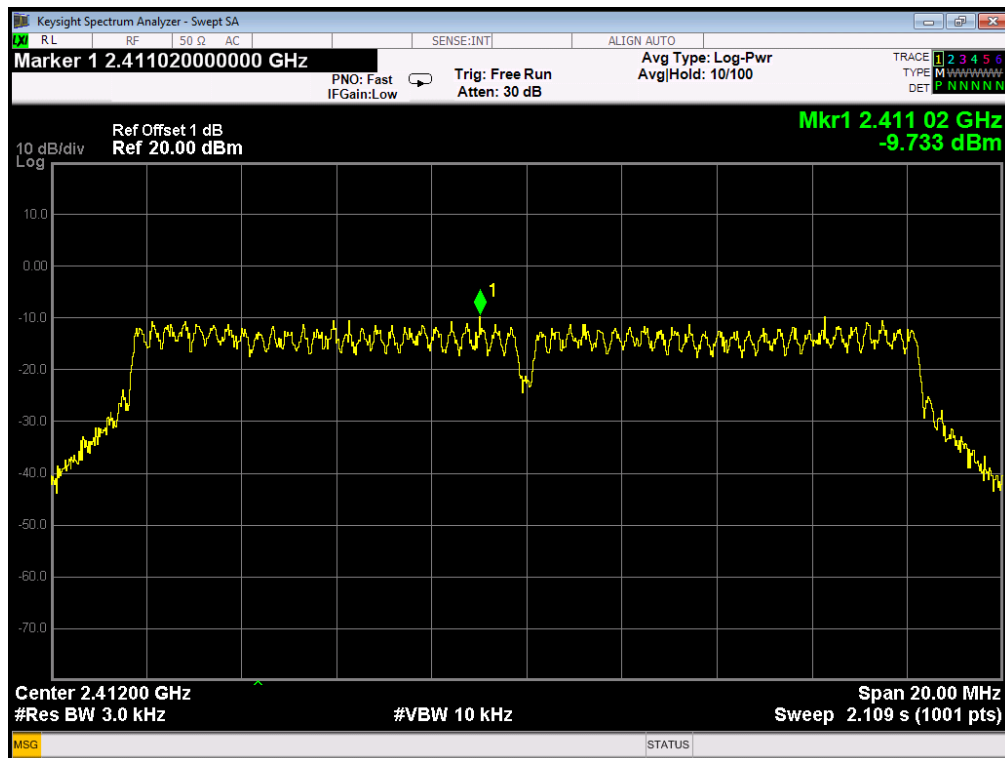

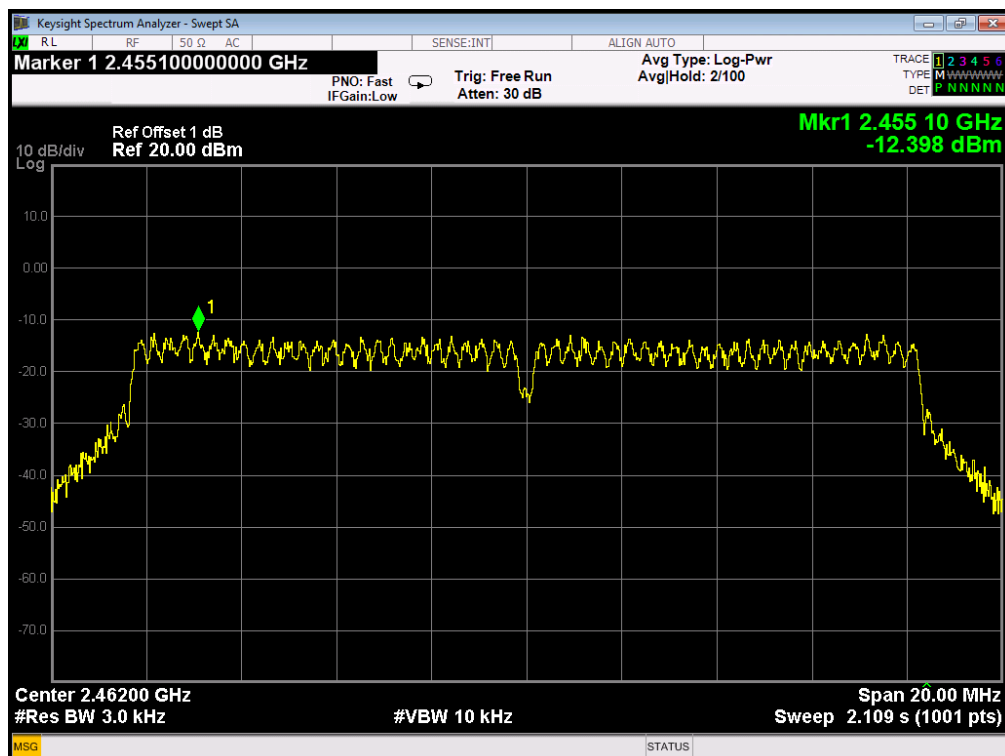
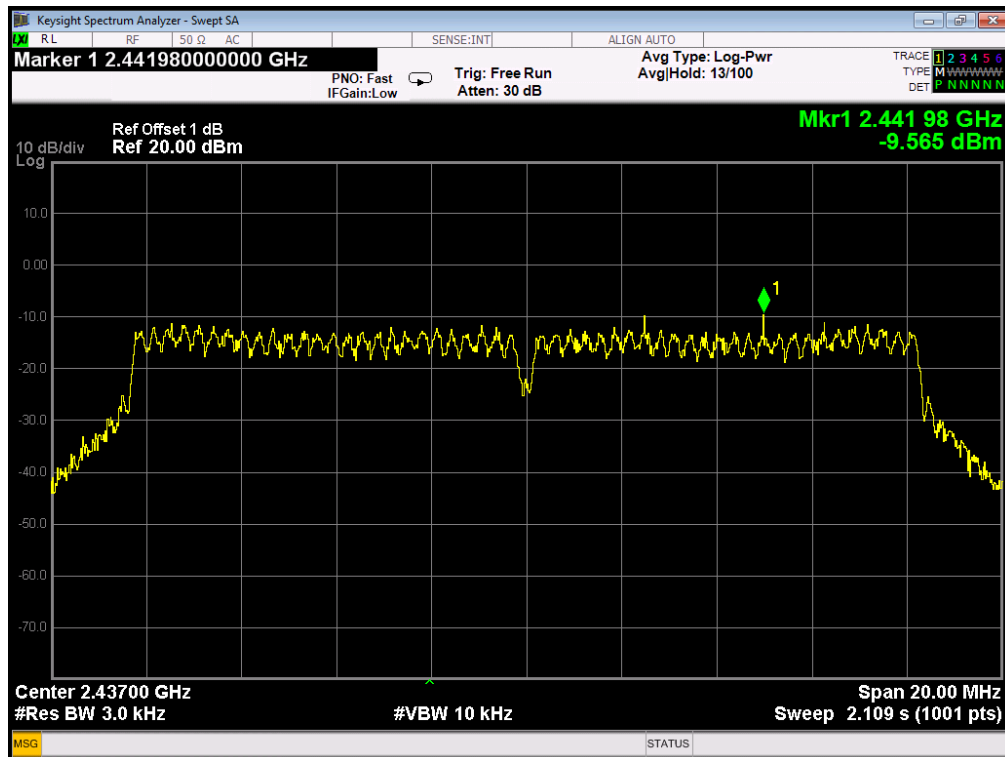

## 802.11 n20 Mode

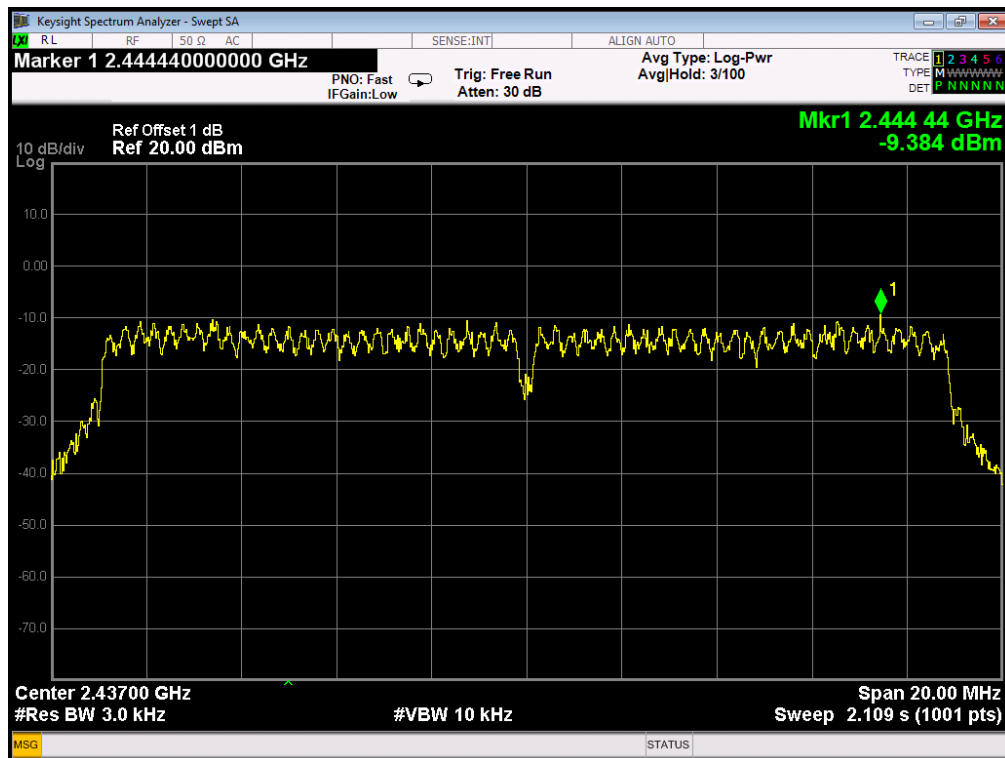
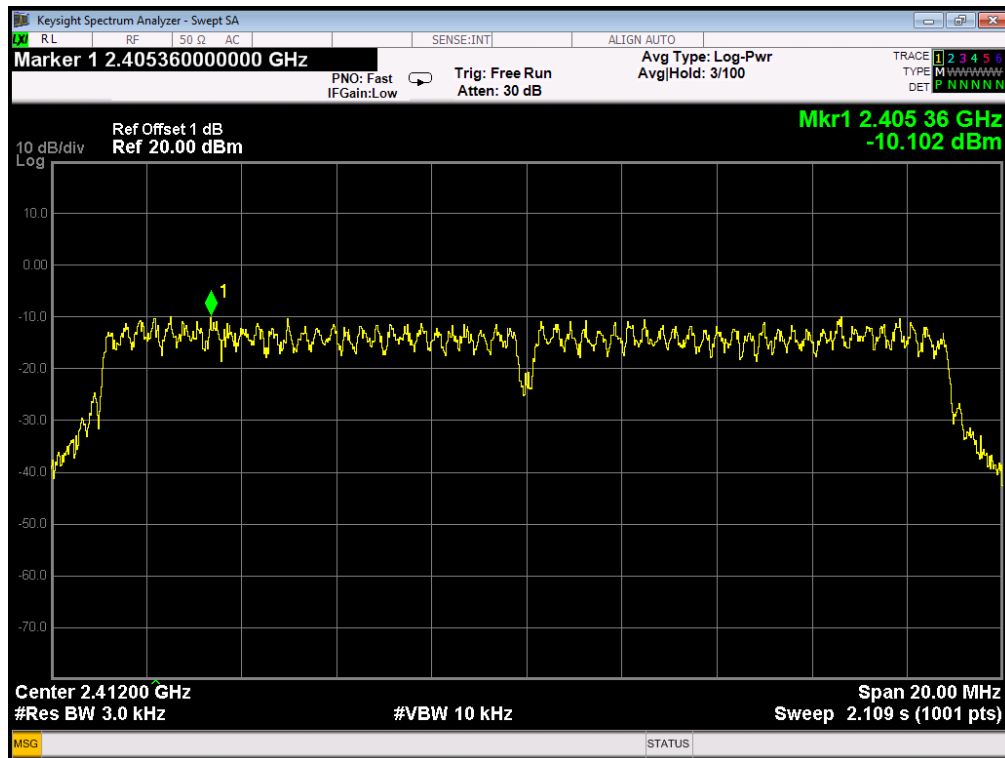

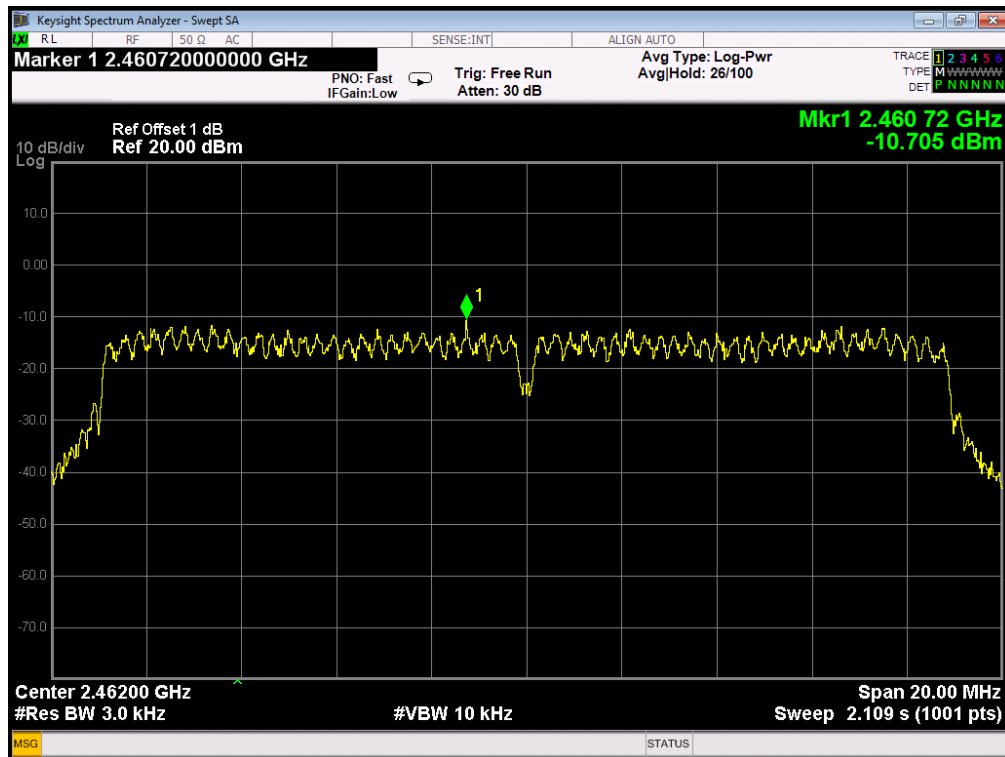

802.11 n40 Mode

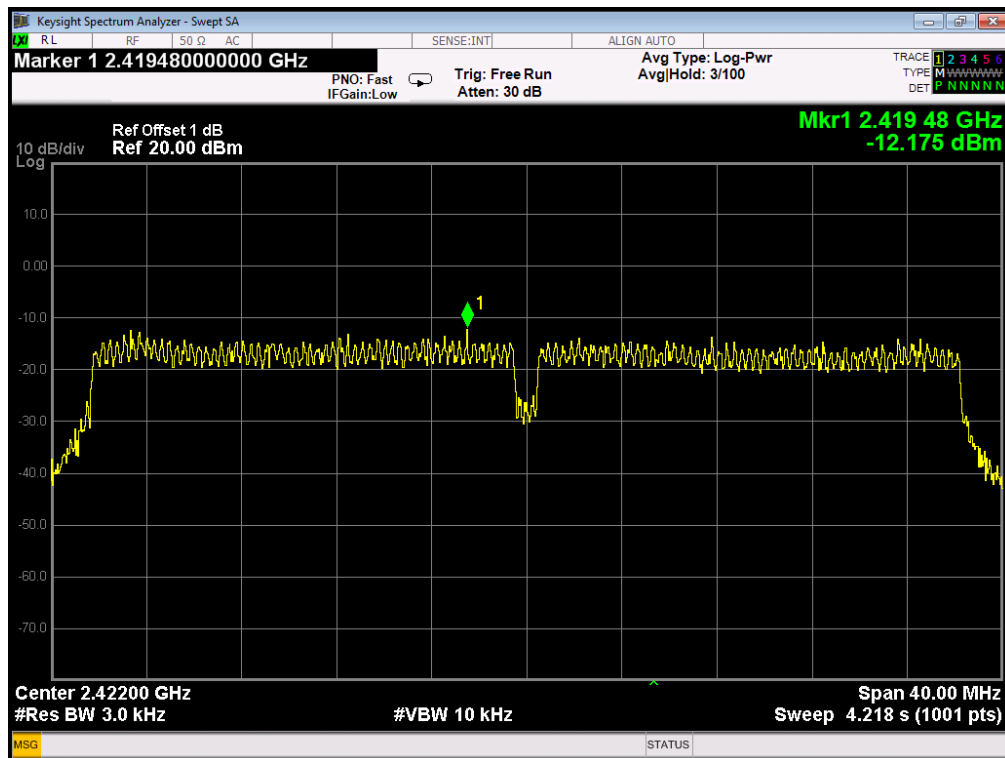



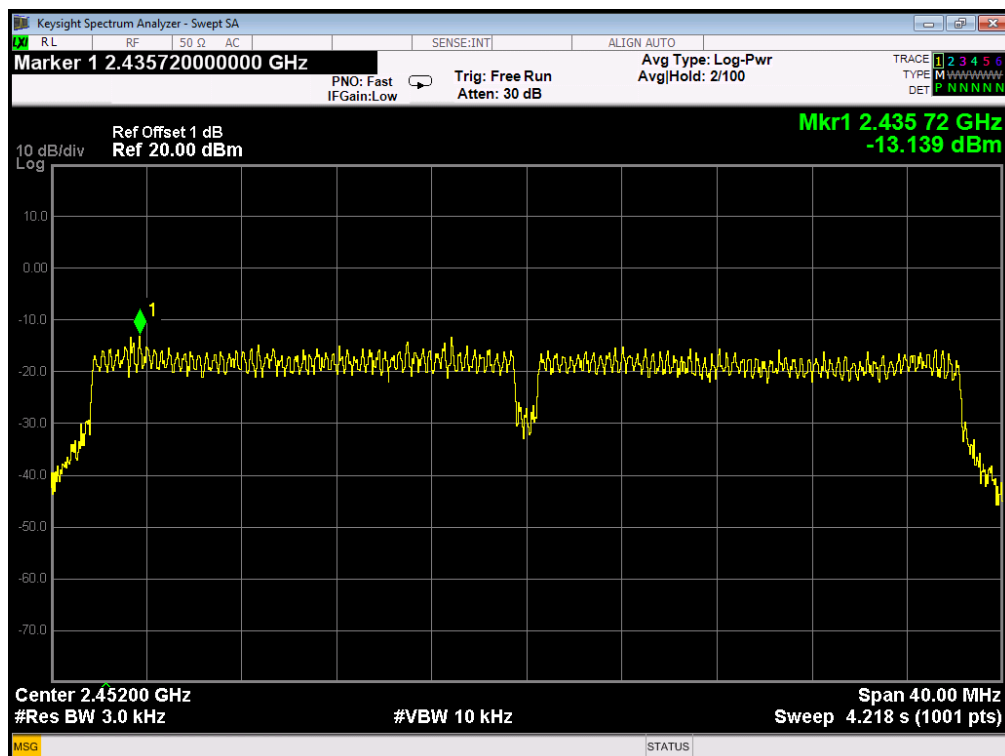
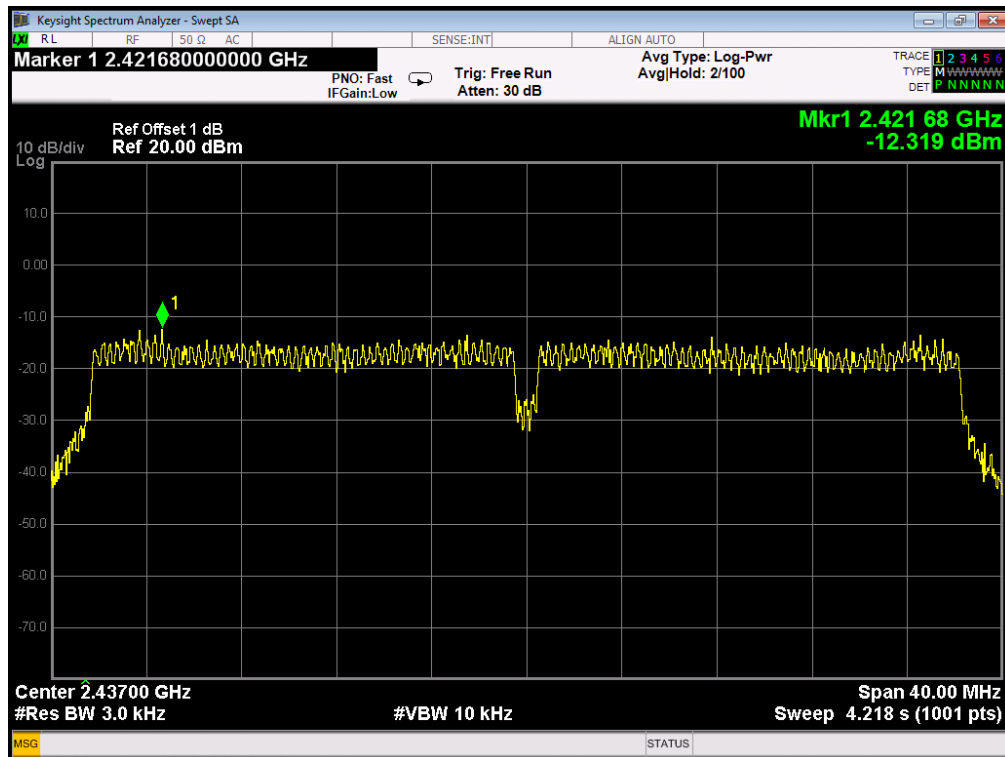

## 6. Spurious Emissions

### 6.1. Test equipment

Item	Equipment	Manufacturer	Model No.	Serial No.	Calibrated until	Cal. Interval
1	EMI Test Receiver	R&S	ESCI	101307	2017/12/18	1 Year
2	Spectrum analyzer	Agilent	E4407B	US40240708	2017/12/18	1 Year
3	Loop antenna	Chase	HLA6120	20129	2017/12/18	1 Year
4	Trilog Broadband Antenna	Schwarzbeck	VULB9163	9163-462	2017/12/18	1 Year
5	Double Ridged Horn Antenna	Schwarzbeck	BBHA9120D	9120D 1065	2017/12/18	1 Year
6	Pre-Amplifier	R&S	SCU-01	10049	2017/12/18	1 Year
7	Pre-Amplifier	A.H.	PAM0-0118	360	2017/12/18	1 Year
8	Pre-Amplifier	HP	8449B	3274A06298	2017/12/18	1 Year
9	RF Cable	R&S	R01	10403	2017/12/18	1 Year
10	RF Cable	R&S	R02	10512	2017/12/18	1 Year
11	Horn Antenna	Schwarzbeck	BBHA 9170	9170 1248	2017/12/18	1 Year

### 6.2. Block diagram of test setup

In 3m Anechoic Chamber Test Setup Diagram for below 1GHz

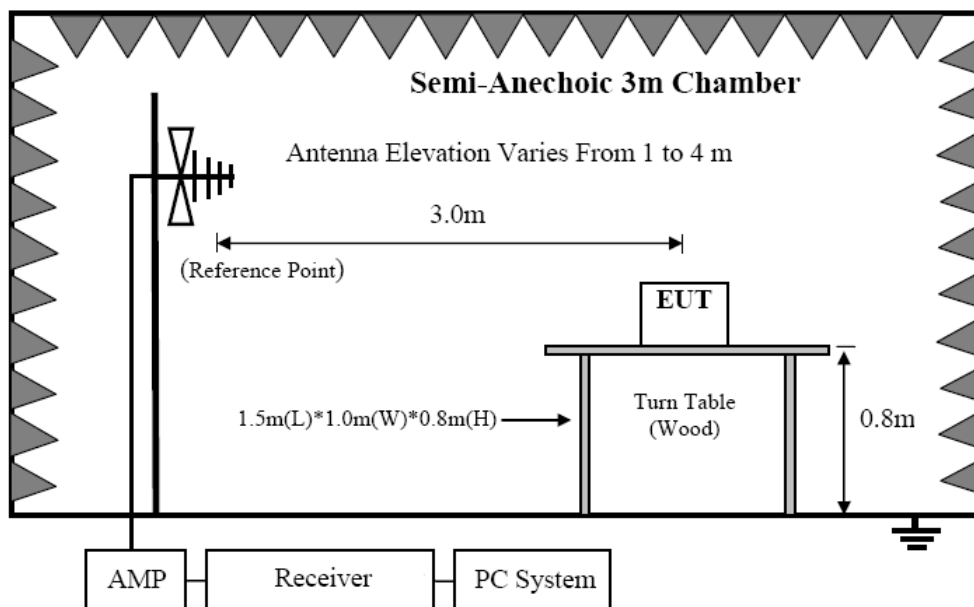

In 3m Anechoic Chamber Test Setup Diagram for frequency above 1GHz

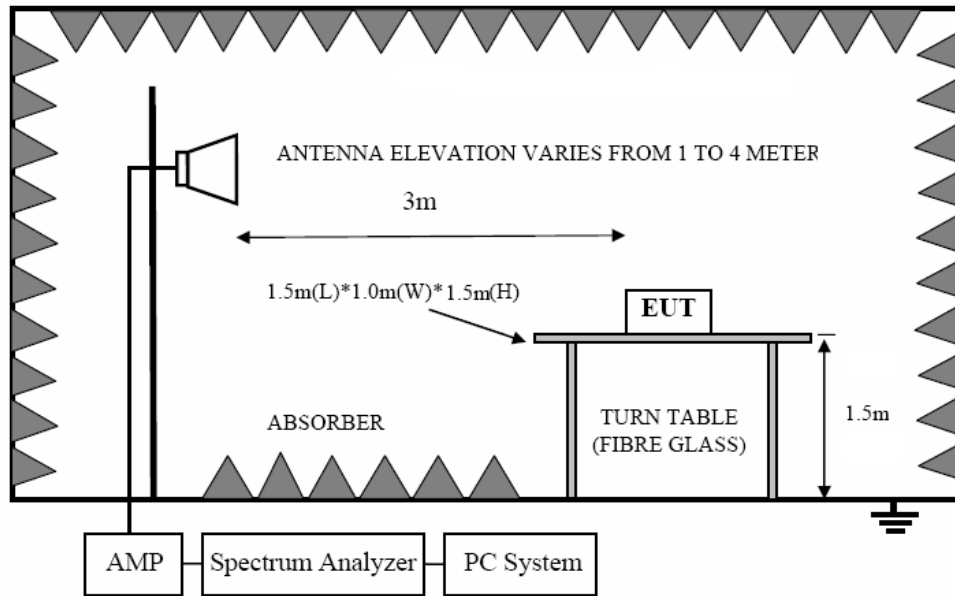

Note: For harmonic emissions test a appropriate high pass filter was inserted in the input port of AMP.

### 6.3. Limit

#### 6.3.1 FCC 15.205 Restricted frequency band

MHz	MHz	MHz	GHz
0.090 - 0.110	16.42 - 16.423	399.9 - 410	4.5 - 5.15
<sup>1</sup> 0.495 - 0.505	16.69475 - 16.69525	608 - 614	5.35 - 5.46
2.1735 - 2.1905	16.80425 - 16.80475	960 - 1240	7.25 - 7.75
4.125 - 4.128	25.5 - 25.67	1300 - 1427	8.025 - 8.5
4.17725 - 4.17775	37.5 - 38.25	1435 - 1626.5	9.0 - 9.2
4.20725 - 4.20775	73 - 74.6	1645.5 - 1646.5	9.3 - 9.5
6.215 - 6.218	74.8 - 75.2	1660 - 1710	10.6 - 12.7
6.26775 - 6.26825	108 - 121.94	1718.8 - 1722.2	13.25 - 13.4
6.31175 - 6.31225	123 - 138	2200 - 2300	14.47 - 14.5
8.291 - 8.294	149.9 - 150.05	2310 - 2390	15.35 - 16.2
8.362 - 8.366	156.52475 - 156.52525	2483.5 - 2500	17.7 - 21.4
8.37625 - 8.38675	156.7 - 156.9	2690 - 2900	22.01 - 23.12
8.41425 - 8.41475	162.0125 - 167.17	3260 - 3267	23.6 - 24.0
12.29 - 12.293	167.72 - 173.2	3332 - 3339	31.2 - 31.8
12.51975 - 12.52025	240 - 285	3345.8 - 3358	36.43 - 36.5
12.57675 - 12.57725	322 - 335.4	3600 - 4400	( <sup>2</sup> )

6.3.2 FCC 15.209 Limit

FREQUENCY MHz	DISTANCE Meters	FIELD STRENGTHS LIMIT	
		$\mu\text{V}/\text{m}$	$\text{dB}(\mu\text{V})/\text{m}$
30 ~ 88	3	100	40.0
88 ~ 216	3	150	43.5
216 ~ 960	3	200	46.0
960 ~ 1000	3	500	54.0
Above 1000	3	74.0 $\text{dB}(\mu\text{V})/\text{m}$ (Peak) 54.0 $\text{dB}(\mu\text{V})/\text{m}$ (Average)	

6.3.3 Limit for this EUT

The radiated emission tests were performed in the 3 meters test site, using the setup accordance with the ANSI C63.10:2013. The specification used was the FCC 15.209, and FCC 15.247 limits.

## 6.4. TEST PROCEDURE

- (1) EUT was placed on a non-metallic table, 80 cm above the ground plane inside a semi-anechoic chamber.
- (2) Setup EUT and assistant system according clause 2.4 and 8.2
- (3) Test antenna was located 3m from the EUT on an adjustable mast. Below pre-scan procedure was first performed in order to find prominent radiated emissions.
  - (a) Change work frequency or channel of device if practicable.
  - (b) Change modulation type of device if practicable.
  - (c) Change power supply range from 85% to 115% of the rated supply voltage
  - (d) Rotated EUT though three orthogonal axes to determine the attitude of EUT arrangement produces highest emissions
- (4) Spectrum frequency from 9MHz to 25GHz (tenth harmonic of fundamental frequency) was investigated, and no any obvious emission were detected from 9KHz to 30MHz and 18GHz to 25GHz, so below final test was performed with frequency range from 30MHz to 18GHz.
- (5) For final emissions measurements at each frequency of interest, the EUT were rotated and the antenna height was varied between 1m and 4m in order to maximize the emission. Measurements in both horizontal and vertical polarities were made and the data was recorded. In order to find the maximum emission, the relative positions of equipments and all of the interface cables were changed according to ANSI C63.10 2013 on Radiated Emission test.
- (6) For emissions from 30MHz to 1GHz, Quasi-Peak values were measured with EMI Receiver and the bandwidth of Receiver is 120 KHz.
- (7) For emissions above 1GHz, both Peak and Average level were measured with Spectrum Analyzer, and the RBW is set at 1MHz, VBW is set at 3MHz for Peak measure, Detector is at PK; RBW is set at 1MHz, VBW is set at 3MHz for Average measure, Detector is at RMS.

## 6.5. Test result

### Below 30M

<b>EUT:</b>	Smart-Home Wi-Fi System	<b>Model No.:</b>	E05S
<b>Temperature:</b>	24℃	<b>Relative Humidity:</b>	55%
<b>Distance:</b>	3m	<b>Test Power:</b>	12 Vdc
<b>Polarization:</b>	--	<b>Test Result:</b>	Pass
<b>Test Mode:</b>	Keeping TX mode	<b>Test By:</b>	Smile

Freq. (MHz)	Reading (dBuV/m)	Limit (dBuV/m)	Margin (dB)	State
--	--	--	--	P
--	--	--	--	P

**Note:**

The amplitude of spurious emissions which are attenuated by more than 20dB below the permissible value has no need to be reported.

Distance extrapolation factor =  $20 \log(\text{specific distance}/\text{test distance})$ (dB);

Limit line = specific limits(dBuv) + distance extrapolation factor

### Between 30M – 1000 MHz

EUT:	Smart-Home Wi-Fi System	Model No.:	E05S
Temperature:	24	Relative Humidity:	55%
Distance:	3m	Test Power:	12 Vdc
Polarization:	Vertical	Test Result:	Pass
Standard:	(RE)FCC PART 15 class B 3m	Test By:	Smile
Test Mode:	Keeping TX Mdoe		

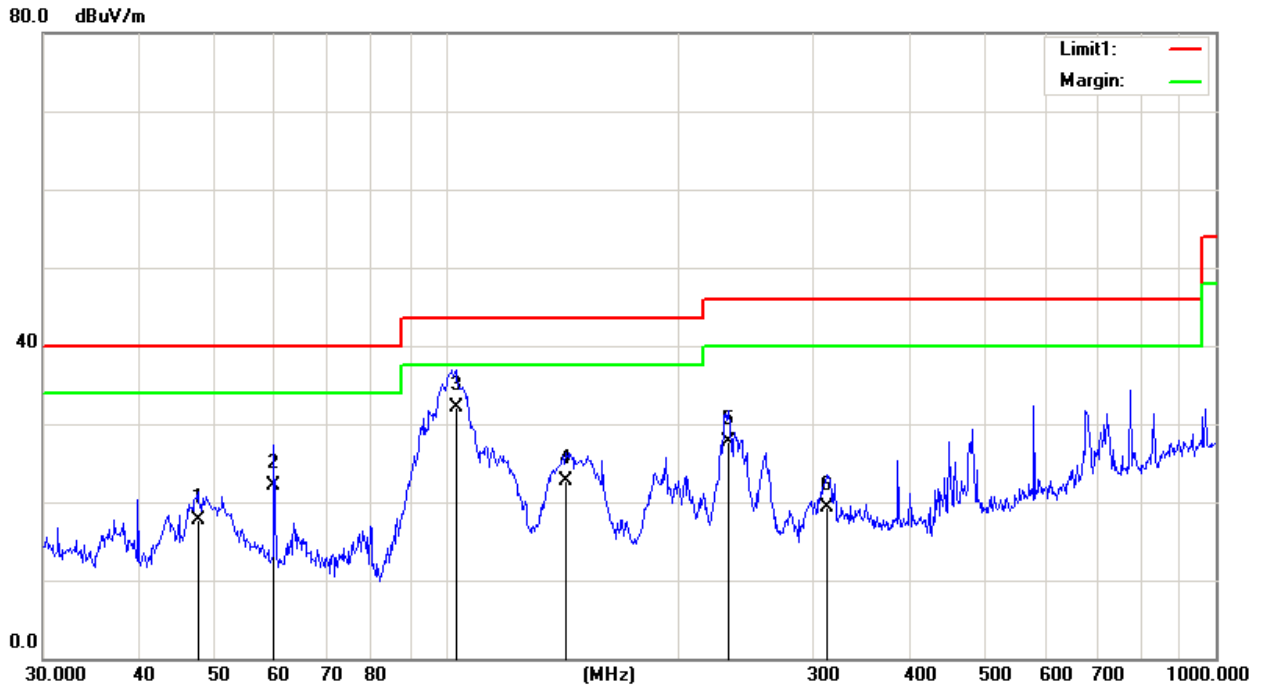

No.	Frequency (MHz)	Reading (dBuV/m)	Correct Factor(dB/m)	Result (dBuV/m)	Limit (dBuV/m)	Margin (dB)	Remark
1	47.6586	31.54	-13.92	17.62	40.00	-22.38	QP
2	59.8588	35.59	-13.44	22.15	40.00	-17.85	QP
3	103.0800	47.56	-15.41	32.15	43.50	-11.35	QP
4	143.3261	35.71	-13.00	22.71	43.50	-20.79	QP
5	233.3487	37.00	-9.38	27.62	46.00	-18.38	QP
6	312.1792	28.23	-8.89	19.34	46.00	-26.66	QP

UT:	Smart-Home Wi-Fi System	Model No.:	E05S
Temperature:	24	Relative Humidity:	55%
Distance:	3m	Test Power:	12 Vdc
Polarization:	Horizontal	Test Result:	Pass
Standard:	(RE)FCC PART 15 class B 3m	Test By:	Smile
Test Mode:	Keeping TX Mdoe		

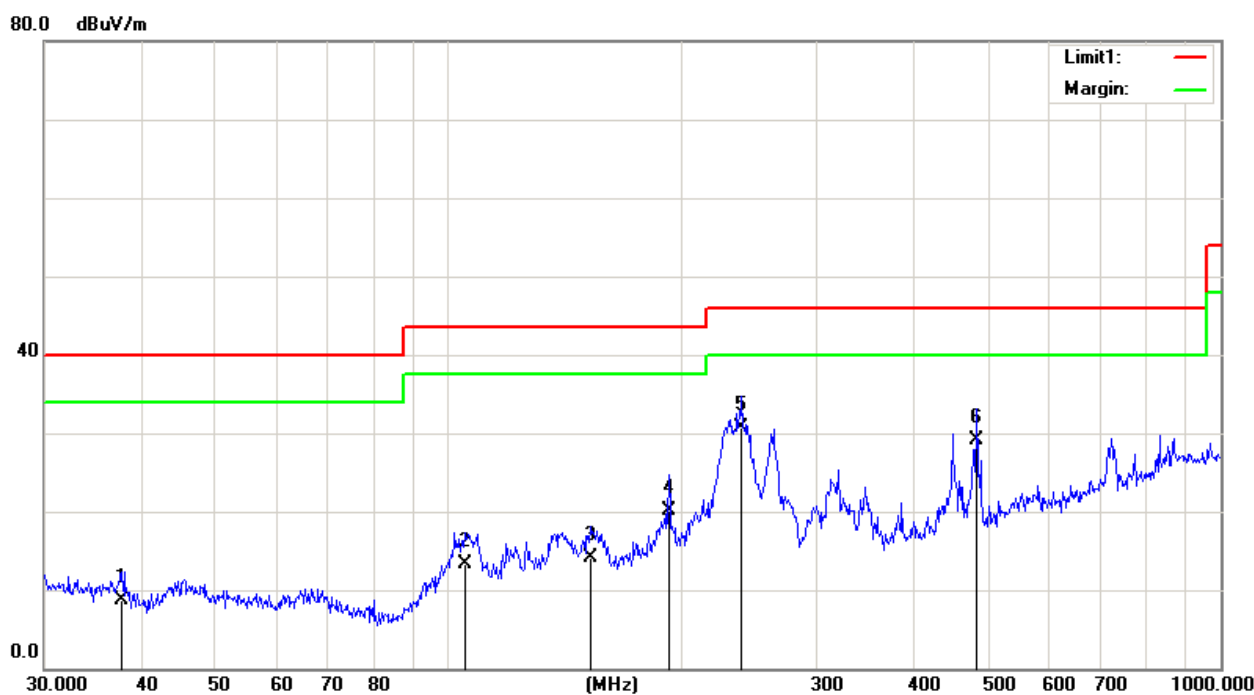

No.	Frequency (MHz)	Reading (dBuV/m)	Correct Factor(dB/m)	Result (dBuV/m)	Limit (dBuV/m)	Margin (dB)	Remark
1	37.8121	24.37	-15.68	8.69	40.00	-31.31	QP
2	105.2718	29.72	-16.46	13.26	43.50	-30.24	QP
3	153.2004	27.55	-13.39	14.16	43.50	-29.34	QP
4	193.0945	30.43	-10.29	20.14	43.50	-23.36	QP
5	239.9874	37.37	-6.68	30.69	46.00	-15.31	QP
6	483.9094	36.03	-6.90	29.13	46.00	-16.87	QP



**Between 1000M – 25000 MHz**

<b>Test Site</b>	: 3m Chamber		
<b>EUT</b>	: Smart-Home Wi-Fi System	<b>Tested By</b>	: Smile
<b>Power Supply</b>	: 12 Vdc	<b>Model Number</b>	: E05S
<b>Condition</b>	: Temp:24.5'C,Humi:55%, Press:100.1kPa	<b>Test Mode</b>	: Tx mode
<b>Memo</b>	: 802.11B (worst case)	<b>Antenna/Distance</b>	: VULB 9163 /3m

Frequency (MHz)	Receiver		Rx Antenna		Cable loss (dB)	Amplifier Gain (dB)	Corrected Amplitude (dB $\mu$ V/m)	FCC 15.247	
	Reading (dB $\mu$ V)	Detector (PK/QP/AV)	Polar (H/V)	Factor (dB)				Limit (dB $\mu$ V/m)	Margin (dB)
Low Channel (2412)									
4824	43.62	PK	H	32.3	5.91	31.78	50.05	74	-23.95
4824	35.36	AV	H	32.3	5.91	31.78	41.79	54	-12.21
4824	45.05	PK	V	32.3	5.91	31.78	51.48	74	-22.52
4824	37.06	AV	V	32.3	5.91	31.78	43.49	54	-10.51
7236	42.34	PK	H	36.3	6.34	30.97	54.01	74	-19.99
7236	34.52	AV	H	36.3	6.34	30.97	46.19	54	-7.81
7236	44.17	PK	V	36.3	6.34	30.97	55.84	74	-18.16
7236	36.09	AV	V	36.3	6.34	30.97	47.76	54	-6.24
9648	41.87	PK	H	37.9	8.01	30.86	56.92	74	-17.08
9648	31.68	AV	H	37.9	8.01	30.86	46.73	54	-7.27
9648	41.21	PK	V	37.9	8.01	30.86	56.26	74	-17.74
9648	31.65	AV	V	37.9	8.01	30.86	46.7	54	-7.3
Middle Channel (2437)									
4874	43.88	PK	H	32.6	6.34	31.78	51.04	74	-22.96
4874	35.69	AV	H	32.6	6.34	31.78	42.85	54	-11.15
4874	44.97	PK	V	32.6	6.34	31.78	52.13	74	-21.87
4874	36.45	AV	V	32.6	6.34	31.78	43.61	54	-10.39
7311	41.35	PK	H	36.7	6.72	30.97	53.8	74	-20.2
7311	32.08	AV	H	36.7	6.72	30.97	44.53	54	-9.47
7311	42.69	PK	V	36.7	6.72	30.97	55.14	74	-18.86
7311	34.87	AV	V	36.7	6.72	30.97	47.32	54	-6.68
9748	41.06	PK	H	38.2	8.43	30.86	56.83	74	-17.17
9748	32.99	AV	H	38.2	8.43	30.86	48.76	54	-5.24
9748	42.04	PK	V	38.2	8.43	30.86	57.81	74	-16.19
9748	34.58	AV	V	38.2	8.43	30.86	50.35	54	-3.65
High Channel (2462)									

4924	42.01	PK	H	32.8	6.39	31.78	49.42	74	-24.58
4924	34.75	AV	H	32.8	6.39	31.78	42.16	54	-11.84
4924	43.54	PK	V	32.8	6.39	31.78	50.95	74	-23.05
4924	35.43	AV	V	32.8	6.39	31.78	42.84	54	-11.16
7386	42.84	PK	H	36.8	6.77	30.97	55.44	74	-18.56
7386	33.18	AV	H	36.8	6.77	30.97	45.78	54	-8.22
7386	43.69	PK	V	36.8	6.77	30.97	56.29	74	-17.71
7386	34.04	AV	V	36.8	6.77	30.97	46.64	54	-7.36
9848	41.33	PK	H	38.4	8.48	30.86	57.35	74	-16.65
9848	32.66	AV	H	38.4	8.48	30.86	48.68	54	-5.32
9848	42.08	PK	V	38.4	8.48	30.86	58.1	74	-15.9
9848	34.64	AV	V	38.4	8.48	30.86	50.66	54	-3.34

Note: 1. Result Level = Read Level + Antenna Factor + Cable loss

2: 802.11b/g/nH20/nH40 all have been tested , only worse case 802.11b is reported

**Radiated band edge:**

Frequency (MHz)	Receiver		Rx Antenna		Cable loss (dB)	Amplifier Gain (dB)	Corrected Amplitude (dB $\mu$ V/m)	FCC 15.247	
	Reading (dB $\mu$ V)	PK/QP/AV	Polar (H/V)	Factor (dB)				Limit (dB $\mu$ V/m)	Margin (dB)
Lowest Channel (802.11B)									
2390	26.18	PK	H	27.8	3.57	0	57.55	74	-16.45
2390	18.54	AV	H	27.8	3.57	0	49.91	54	-4.09
2390	26.69	PK	V	27.8	3.57	0	58.06	74	-15.94
2390	18.88	AV	V	27.8	3.57	0	50.25	54	-3.75
Highest Channel (802.11B)									
2483.5	26.54	PK	H	28.7	3.72	0	58.96	74	-15.04
2483.5	17.61	AV	H	28.7	3.72	0	50.03	54	-3.97
2483.5	25.43	PK	V	28.7	3.72	0	57.85	74	-16.15
2483.5	18.44	AV	V	28.7	3.72	0	50.86	54	-3.14
Lowest Channel (802.11G)									
2390	26.84	PK	H	27.8	3.57	0	58.21	74	-15.79
2390	18.36	AV	H	27.8	3.57	0	49.73	54	-4.27
2390	25.28	PK	V	27.8	3.57	0	56.65	74	-17.35
2390	17.36	AV	V	27.8	3.57	0	48.73	54	-5.27
Highest Channel (802.11G)									
2483.5	27.13	PK	H	28.7	3.72	0	59.55	74	-14.45
2483.5	17.69	AV	H	28.7	3.72	0	50.11	54	-3.89
2483.5	26.34	PK	V	28.7	3.72	0	58.76	74	-15.24
2483.5	17.01	AV	V	28.7	3.72	0	49.43	54	-4.57

Frequency (MHz)	Receiver		Rx Antenna		Cable loss (dB)	Amplifier Gain (dB)	Corrected Amplitude (dBμV/m)	FCC 15.247	
	Reading (dBμV)	PK/QP/AV	Polar (H/V)	Factor (dB)				Limit (dBμV/m)	Margin (dB)
Lowest Channel (802.11N HT20)									
2390	26.54	PK	H	27.8	3.57	0	57.91	74	-16.09
2390	18.34	AV	H	27.8	3.57	0	49.71	54	-4.29
2390	26.28	PK	V	27.8	3.57	0	57.65	74	-16.35
2390	18.11	AV	V	27.8	3.57	0	49.48	54	-4.52
Highest Channel (802.11N HT20)									
2483.5	27.62	PK	H	28.7	3.72	0	60.04	74	-13.96
2483.5	18.75	AV	H	28.7	3.72	0	51.17	54	-2.83
2483.5	26.33	PK	V	28.7	3.72	0	58.75	74	-15.25
2483.5	18.08	AV	V	28.7	3.72	0	50.5	54	-3.5
Lowest Channel (802.11N HT40)									
2390	27.15	PK	H	27.8	3.57	0	58.52	74	-15.48
2390	17.46	AV	H	27.8	3.57	0	48.83	54	-5.17
2390	26.82	PK	V	27.8	3.57	0	58.19	74	-15.81
2390	15.39	AV	V	27.8	3.57	0	46.76	54	-7.24
Highest Channel (802.11N HT40)									
2483.5	27.16	PK	H	28.7	3.72	0	59.58	74	-14.42
2483.5	17.94	AV	H	28.7	3.72	0	50.36	54	-3.64
2483.5	26.33	PK	V	28.7	3.72	0	58.75	74	-15.25
2483.5	15.28	AV	V	28.7	3.72	0	47.7	54	-6.3

Note: 1. Result Level = Read Level + Antenna Factor + Cable Loss- Amplifier Gain

2. After test and evaluation hopping off mode and hopping on mode, will record worst case (hopping off mode) in this report.

## 7. 100 kHz Bandwidth of Frequency Band Edge

### 7.1. Test equipment

Item	Equipment	Manufacturer	Model No.	Serial No.	Cal Due.	Cal. Interval
1	Spectrum analyzer	KEYSIGHT	N9010A	MY55150427	2017/05/05	1 Year
2	Attenuator	Mini-Circuits	BW-S10W2	101109	2017/12/18	1 Year
3	RF Cable	Micable	C10-01-01-1	100309	2017/12/18	1 Year

### 7.2. Block diagram of test setup

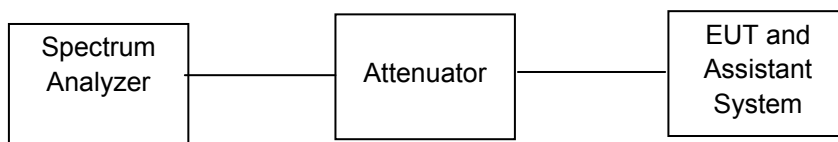

### 7.3. Limit

In any 100 kHz bandwidth outside the frequency band in which the spread spectrum or digitally modulated intentional radiator is operating, the radio frequency power that is produced by the intentional radiator shall be at least 20 dB below that in the 100 kHz bandwidth within the band that contains the highest level of the desired power, based on either an RF conducted or a radiated measurement, provided the transmitter demonstrates compliance with the peak conducted power limits. If the transmitter complies with the conducted power limits based on the use of RMS averaging over a time interval, as permitted under paragraph (b)(3) of this section, the attenuation required under this paragraph shall be 30 dB instead of 20 dB. Attenuation below the general limits specified in §15.209(a) is not required. In addition, radiated emissions which fall in the restricted bands, as defined in §15.205(a), must also comply with the radiated emission limits specified in §15.209(a) (see §15.205(c)).

### 7.4. Test Procedure

1. Check the calibration of the measuring instrument using either an internal calibrator or a known signal from an external generator.
2. Remove the antenna from the EUT and then connect to a low loss RF cable from the antenna port to a EMI test receiver, then turn on the EUT and make it operate in transmitting mode. Then set it to Low Channel and High Channel within its operating range, and make sure the instrument is operated in its linear range.
3. Set both RBW and VBW of spectrum analyzer to 100 kHz with a convenient frequency span including 100 kHz bandwidth from band edge.
4. Measure the highest amplitude appearing on spectral display and set it as a reference level. Plot the graph with marking the highest point and edge frequency.
5. Repeat above procedures until all measured frequencies were complete.

### 7.5. Test result

Frequency Band	Delta Peak to band emission (dBc)	>Limit (dBc)	Result
802.11 b Mode			
2400	51.41	20	Pass
2483.5	57.51	20	Pass
802.11 g Mode			
2400	34.74	20	Pass
2483.5	53.27	20	Pass
802.11 n20 Mode			
2400	37.68	20	Pass
2483.5	47.39	20	Pass
802.11 n40 Mode			
2400	31.33	20	Pass
2483.5	40.95	20	Pass

## 802.11 b Mode

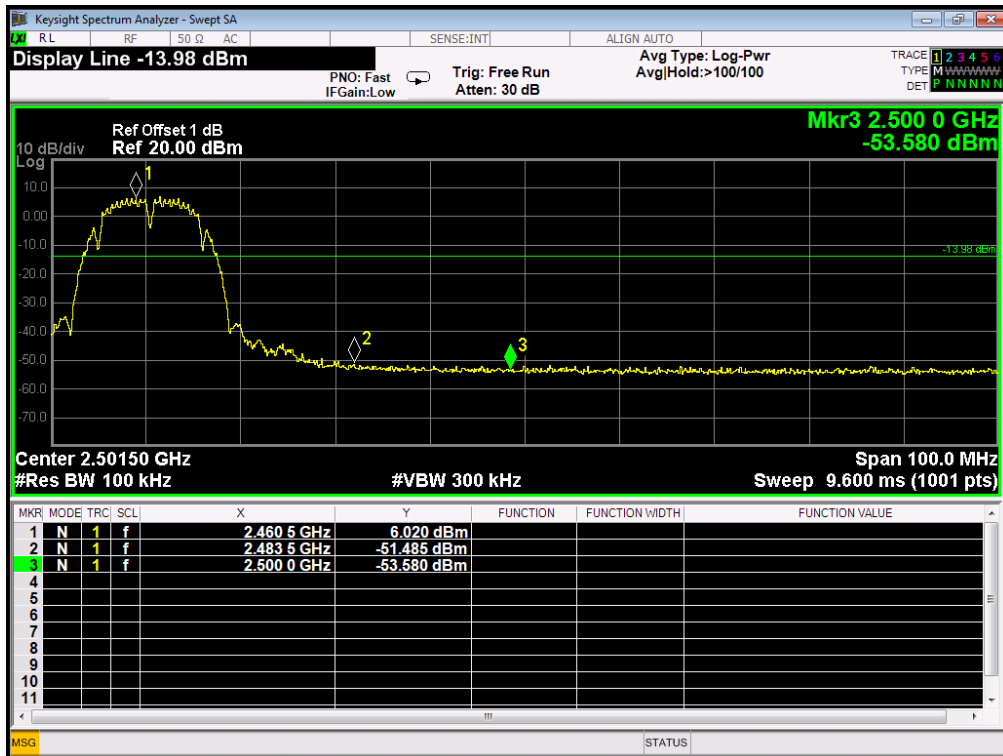
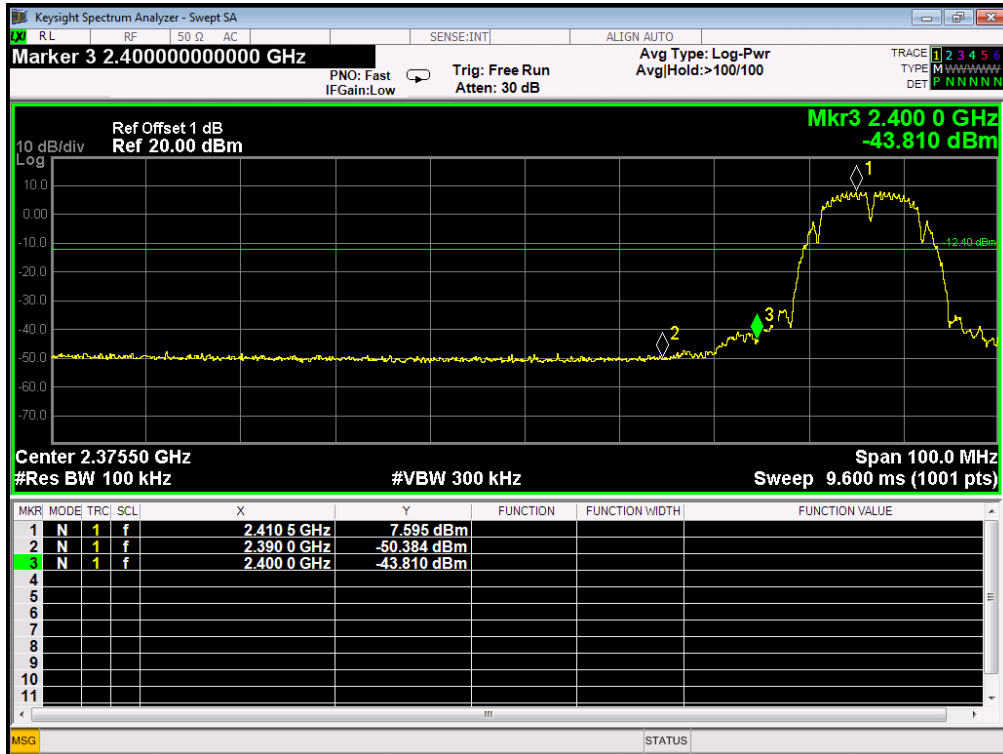

## 802.11 g Mode

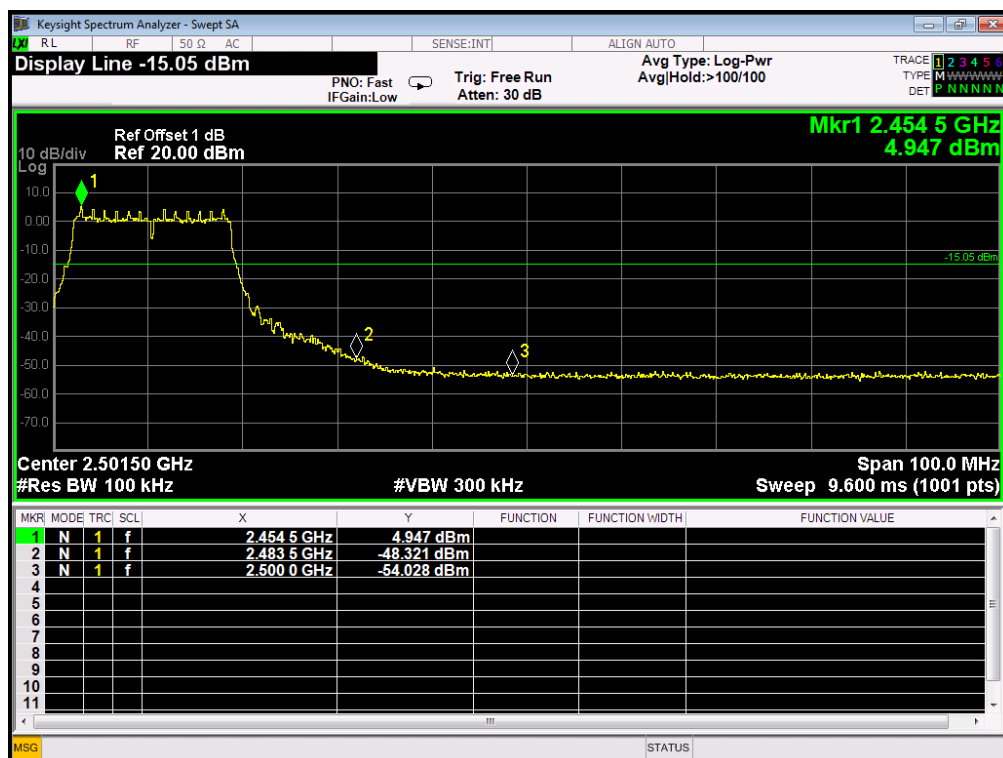
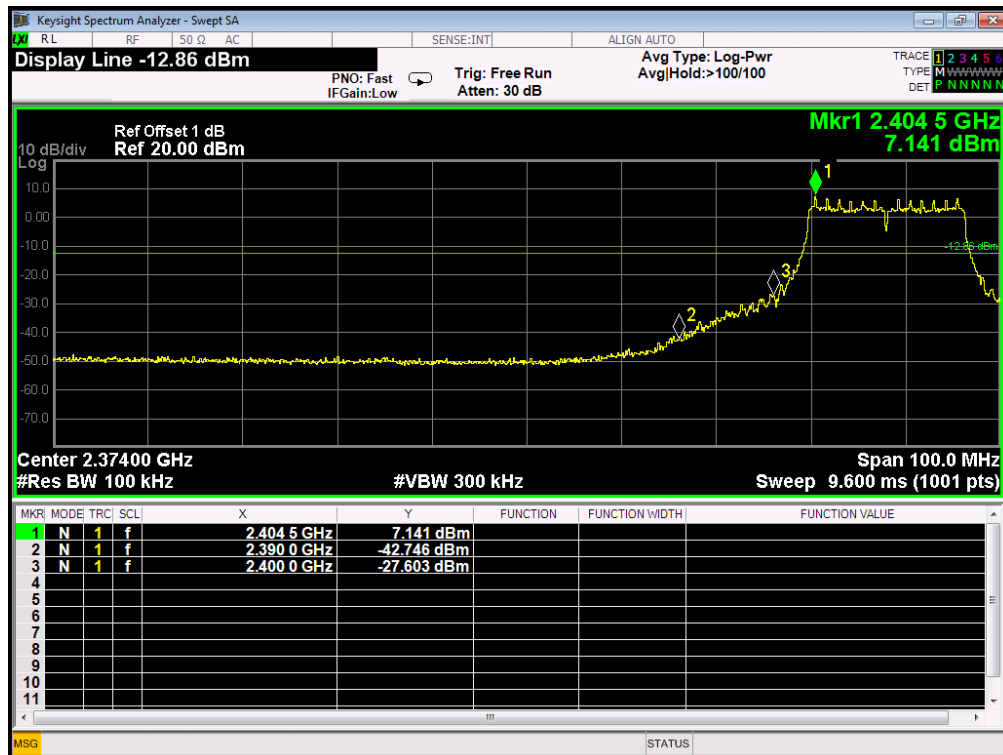



## 802.11 n20 Mode

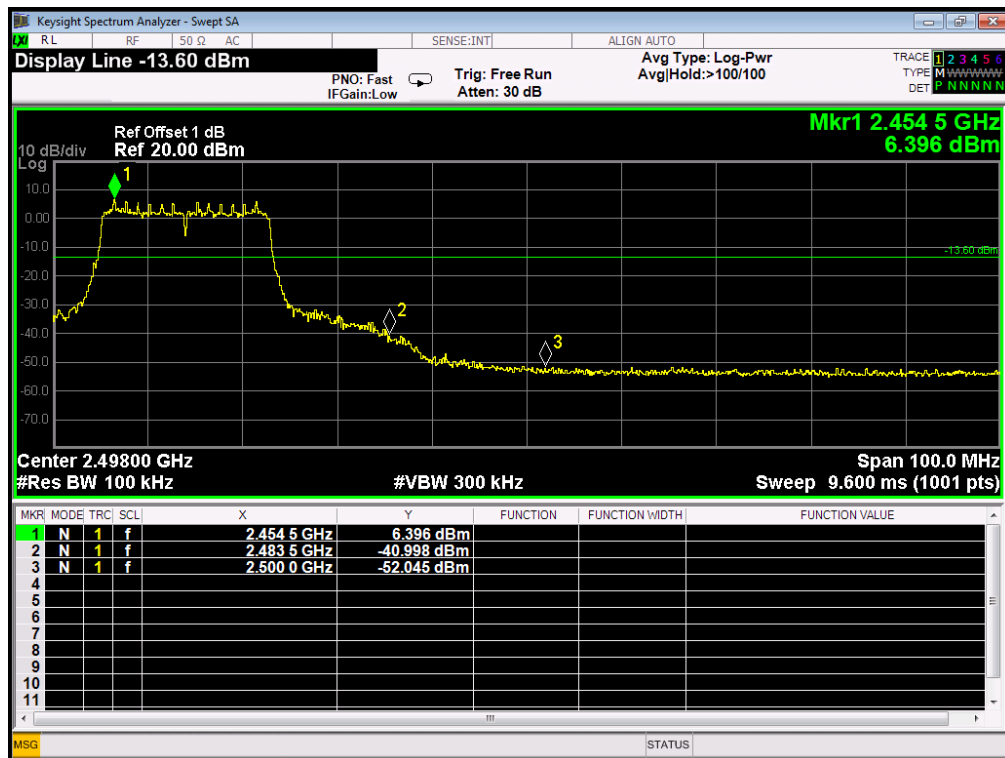
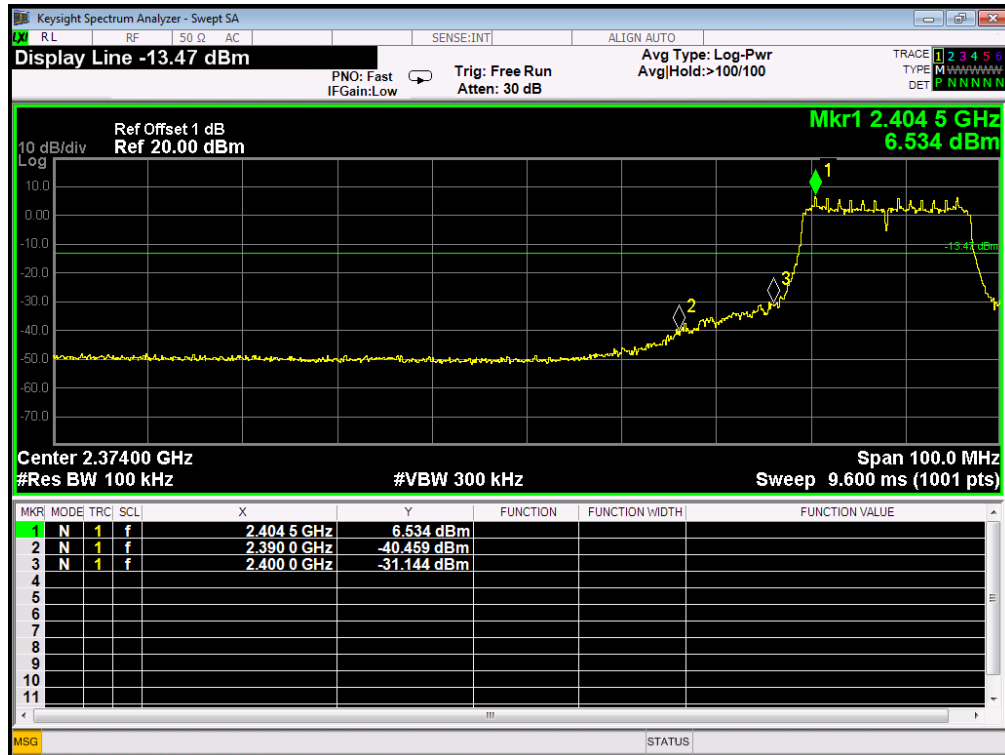

## 802.11 n40 Mode

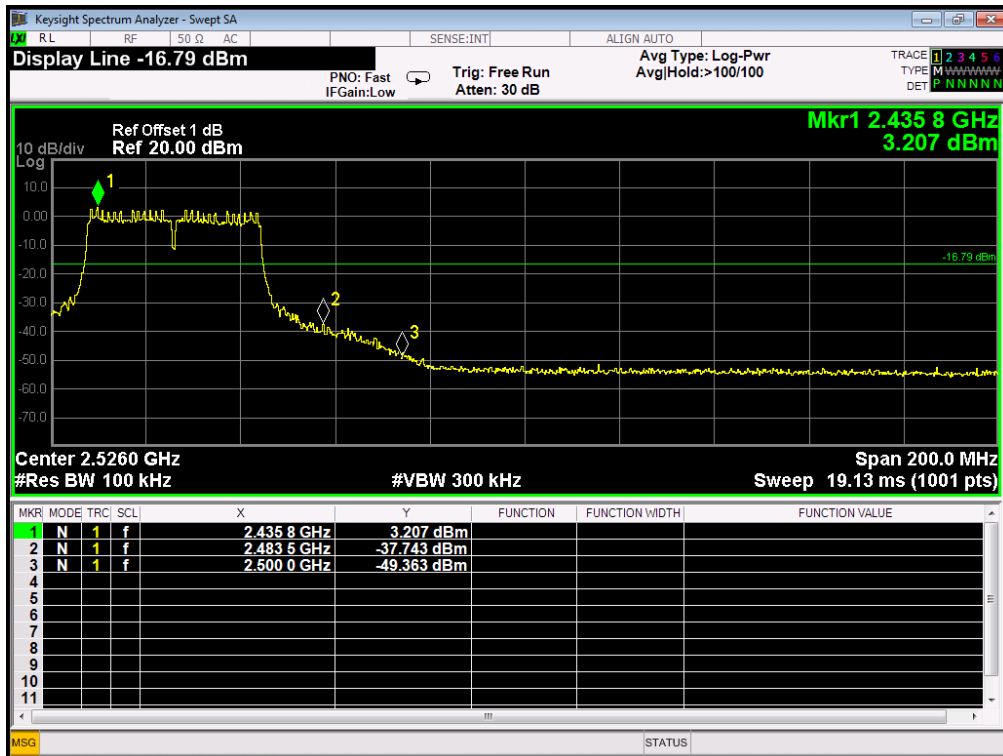
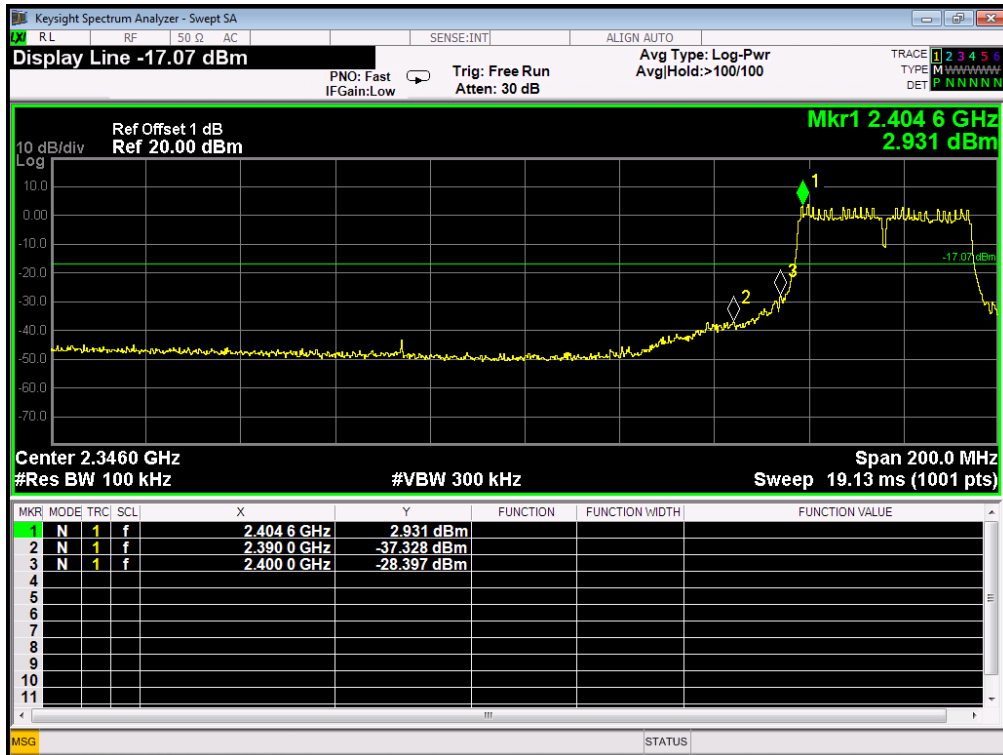

## 8 Power Line Conducted Emission

### 8.1 Test equipment

Item	Equipment	Manufacturer	Model No.	Serial No.	Cal Due.	Cal. Interval
1	Test Receiver	R&S	ESCI	101308	2017/12/18	1 Year
2	LISN 1	AFJ	LS16	16011103219	2017/12/18	1 Year
3	LISN 2	SCHWARZBECK	NSLK 8127	8127-432	2017/12/18	1 Year
4	Pulse Limiter	MTS-systemtechnik	MTS-IMP-136	261115-010-0024	2017/12/18	1 Year
5	CABLE	R&S	EA033	JHW14012068	2017/12/18	1 Year

### 8.2 Block diagram of test setup

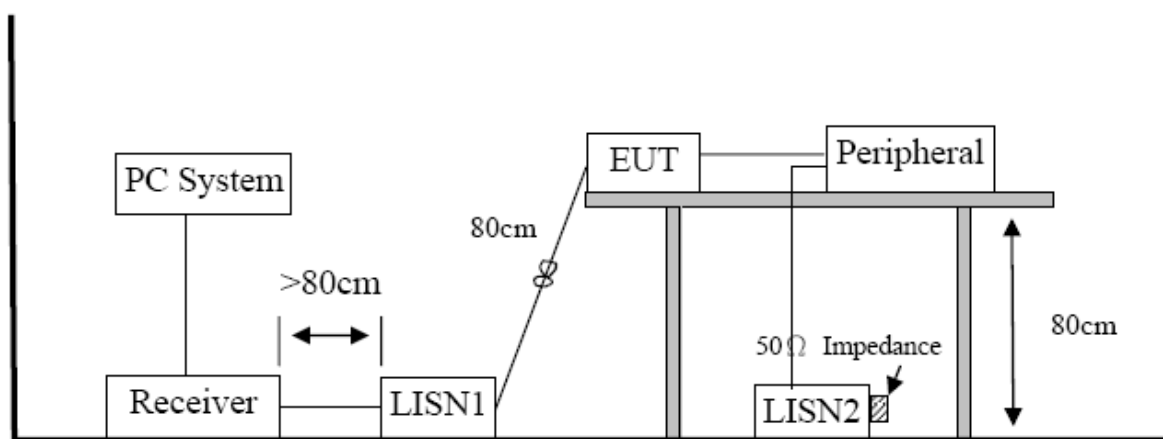

### 8.3 Power Line Conducted Emission Limits(Class B)

Frequency	Quasi-Peak Level dB( $\mu$ V)	Average Level dB( $\mu$ V)
150kHz ~ 500kHz	66 ~ 56*	56 ~ 46*
500kHz ~ 5MHz	56	46
5MHz ~ 30MHz	60	50

Note 1: \* Decreasing linearly with logarithm of frequency.

Note 2: The lower limit shall apply at the transition frequencies.

## 8.4 Test Procedure

The EUT and Support equipment, if needed, were put placed on a non-metallic table, 80cm above the ground plane.

Configuration EUT to simulate typical usage as described in clause 2.4 and test equipment as described in clause 10.2 of this report.

All I/O cables were positioned to simulate typical actual usage as per ANSI C63.4.

All support equipment power received from a second LISN.

Emissions were measured on each current carrying line of the EUT using an EMI Test Receiver connected to the LISN powering the EUT.

The Receiver scanned from 150 kHz to 30MHz for emissions in each of the test modes.

During the above scans, the emissions were maximized by cable manipulation.

The test mode(s) described in clause 2.4 were scanned during the preliminary test.

After the preliminary scan, we found the test mode producing the highest emission level.

The EUT configuration and worse cable configuration of the above highest emission levels were recorded for reference of the final test.

EUT and support equipment were set up on the test bench as per the configuration with highest emission level in the preliminary test.

A scan was taken on both power lines, Neutral and Line, recording at least the six highest emissions.

Emission frequency and amplitude were recorded into a computer in which correction factors were used to calculate the emission level and compare reading to the applicable limit.

The test data of the worst-case condition(s) was recorded.

The bandwidth of test receiver is set at 9 KHz.

## 8.5 Test Result

PASS. (See below detailed test result)

Note1: All emissions not reported below are too low against the prescribed limits.

Note2: “----” means peak detection; “----” mans average detection

<b>EUT:</b>	Smart-Home Wi-Fi System	<b>Model No.:</b>	E05S
<b>Temperature:</b>	24°C	<b>Relative Humidity:</b>	55%
<b>Probe:</b>	N	<b>Test Power:</b>	AC 120V/60Hz
<b>Standard:</b>	FCC PART 15 class B	<b>Test Result:</b>	Pass
<b>Test Mode:</b>	TX	<b>Test By:</b>	Hale
<b>Note:</b>			

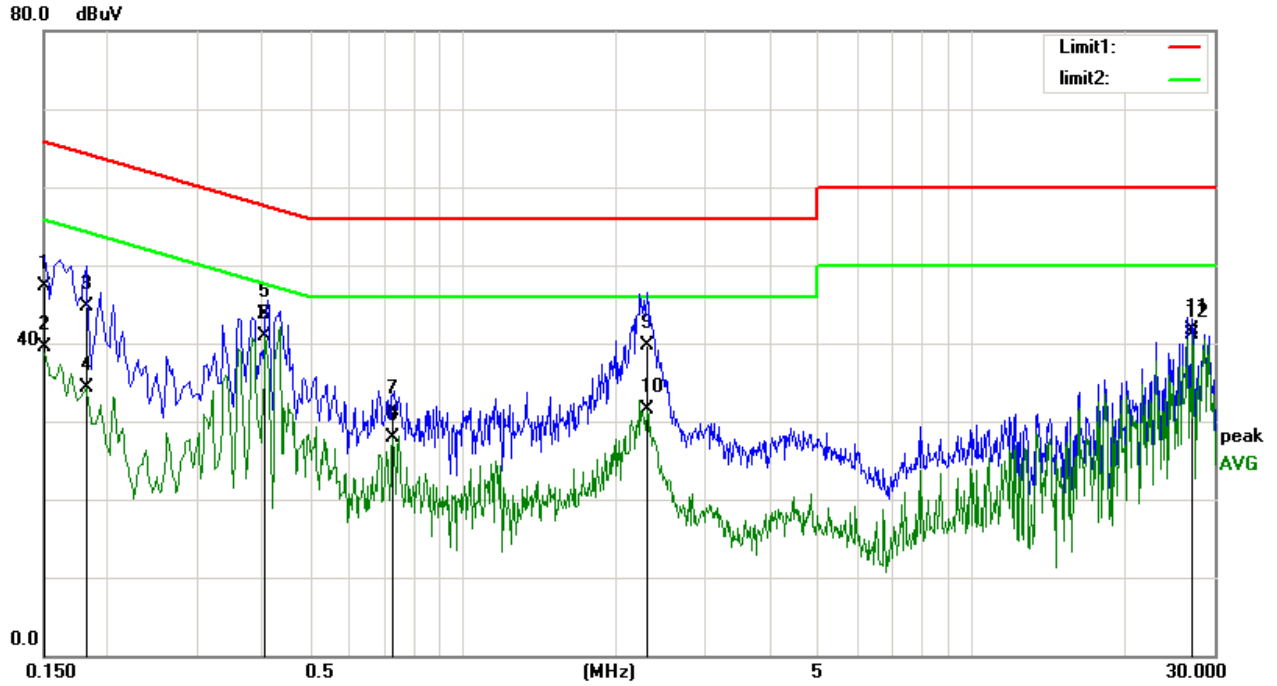

No.	Frequency (MHz)	Reading (dBuV)	Correct Factor(dB)	Result (dBuV)	Limit (dBuV)	Margin (dB)	Remark
1	0.1499	35.87	11.47	47.34	66.00	-18.66	QP
2	0.1499	28.01	11.47	39.48	56.00	-16.52	AVG
3	0.1819	33.47	11.25	44.72	65.09	-20.37	QP
4	0.1819	23.05	11.25	34.30	55.09	-20.79	AVG
5	0.4097	33.31	10.30	43.61	58.58	-14.97	QP
6	0.4097	30.70	10.30	41.00	48.58	-7.58	AVG
7	0.7298	21.15	10.11	31.26	56.00	-24.74	QP
8	0.7298	17.87	10.11	27.98	46.00	-18.02	AVG
9	2.3060	29.60	10.12	39.72	56.00	-16.28	QP
10	2.3060	21.37	10.12	31.49	46.00	-14.51	AVG
11	27.1580	31.47	10.22	41.69	60.00	-18.31	QP
12	27.1580	30.79	10.22	41.01	50.00	-8.99	AVG

<b>EUT:</b>	Smart-Home Wi-Fi System	<b>Model No.:</b>	E05S
<b>Temperature:</b>	24°C	<b>Relative Humidity:</b>	55%
<b>Probe:</b>	L1	<b>Test Power:</b>	AC 120V/60Hz
<b>Standard:</b>	FCC PART 15 class B	<b>Test Result:</b>	Pass
<b>Test Mode:</b>	TX	<b>Test By:</b>	Hale
<b>Note:</b>			

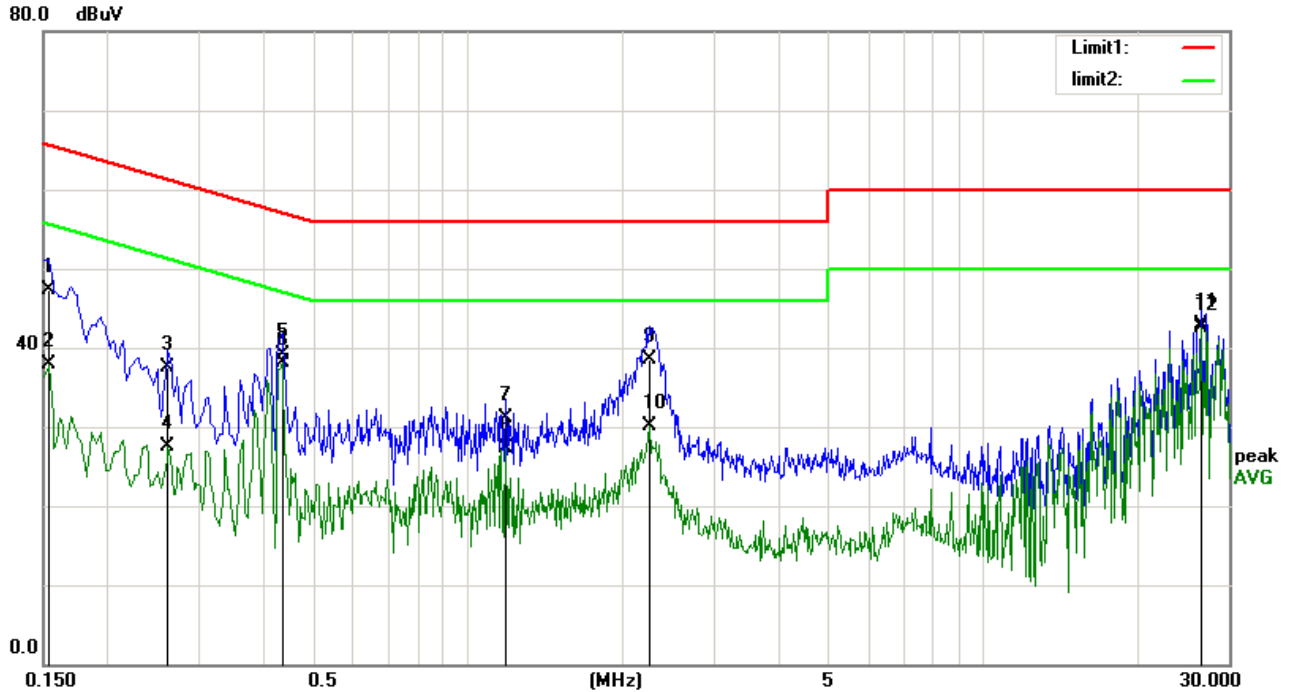

No.	Frequency (MHz)	Reading (dBuV)	Correct Factor(dB)	Result (dBuV)	Limit (dBuV)	Margin (dB)	Remark
1	0.1539	35.90	11.44	47.34	65.89	-18.55	QP
2	0.1539	26.44	11.44	37.88	55.89	-18.01	AVG
3	0.2620	26.83	10.70	37.53	62.80	-25.27	QP
4	0.2620	16.82	10.70	27.52	52.80	-25.28	AVG
5	0.4380	28.91	10.26	39.17	57.77	-18.60	QP
6	0.4380	27.83	10.26	38.09	47.77	-9.68	AVG
7	1.1857	20.93	10.10	31.03	56.00	-24.97	QP
8	1.1857	17.14	10.10	27.24	46.00	-18.76	AVG
9	2.2540	28.40	10.12	38.52	56.00	-17.48	QP
10	2.2540	20.02	10.12	30.14	46.00	-15.86	AVG
11	26.6097	32.60	10.23	42.83	60.00	-17.17	QP
12	26.6097	32.22	10.23	42.45	50.00	-7.55	AVG

## **9. Antenna Requirements**

### **9.1. Limit**

For intentional device, according to FCC 47 CFR Section 15.203, an intentional radiator shall be designed to ensure that no antenna other than that furnished by the responsible party shall be used with the device. And according to FCC 47 CFR Section 15.247 (b), if transmitting antennas of directional gain greater than 6dBi are used, the power shall be reduced by the amount in dB that the directional gain of the antenna exceeds 6dBi.

### **9.2. Result**

SEE 2.2

**END OF REPORT**