

TEST REPORT

Product Name : RFID Reader
Model Number : HZ340, HZ380
FCC ID : 2ANBW-HZ340

Prepared for : SHENZHEN HOPELAND TECHNOLOGIES CO., LTD.
Address : 3F, F5# Bldg., TCL International E-city, Zhongshan Park
Road, Xili Street, Nanshan District, 518052, Shenzhen,
China

Prepared by : EMTEK (SHENZHEN) CO., LTD.
Address : Building 69, Majialong Industry Zone, Nanshan District,
Shenzhen, Guangdong, China

Tel: (0755) 26954280
Fax: (0755) 26954282

Report Number : ENS2302240149W00301R
Date(s) of Tests : February 28, 2023 to April 3, 2023
Date of issue : April 7, 2023

Table of Contents

TEST REPORT	1
1 TEST RESULT CERTIFICATION.....	3
2 EUT TECHNICAL DESCRIPTION	4
3 SUMMARY OF TEST RESULT.....	5
4 TEST METHODOLOGY.....	6
4.1 GENERAL DESCRIPTION OF APPLIED STANDARDS.....	6
4.2 MEASUREMENT EQUIPMENT USED	6
4.3 DESCRIPTION OF TEST MODES	7
5 FACILITIES AND ACCREDITATIONS	8
5.1 FACILITIES.....	8
5.2 LABORATORY ACCREDITATIONS AND LISTINGS.....	8
6 TEST SYSTEM UNCERTAINTY	9
7 SETUP OF EQUIPMENT UNDER TEST.....	10
7.1 RADIO FREQUENCY TEST SETUP 1	10
7.2 RADIO FREQUENCY TEST SETUP 2	10
7.3 CONDUCTED EMISSION TEST SETUP.....	12
7.4 BLOCK DIAGRAM CONFIGURATION OF TEST SYSTEM.....	13
7.5 SUPPORT EQUIPMENT	13
8 TEST REQUIREMENTS.....	14
8.1 20DB BANDWIDTH	14
8.2 CARRIER FREQUENCY SEPARATION.....	17
8.3 NUMBER OF HOPPING FREQUENCIES	20
8.4 AVERAGE TIME OF OCCUPANCY (DWELL TIME).....	22
8.5 MAXIMUM PEAK CONDUCTED OUTPUT POWER.....	24
8.6 CONDUCTED SUPRIIOUS EMISSION.....	27
8.7 RADIATED SPURIOUS EMISSION	34
8.8 CONDUCTED EMISSION TEST.....	44
8.9 ANTENNA APPLICATION	47

1 TEST RESULT CERTIFICATION

Applicant:	SHENZHEN HOPELAND TECHNOLOGIES CO., LTD.
Address:	3F, F5# Bldg., TCL International E-city, Zhongshan Park Road, Xili Street, Nanshan District, 518052, Shenzhen, China
Manufacturer:	SHENZHEN HOPELAND TECHNOLOGIES CO., LTD.
Address:	3F, F5# Bldg., TCL International E-city, Zhongshan Park Road, Xili Street, Nanshan District, 518052, Shenzhen, China
Product Description:	RFID Reader
Model Number:	HZ340, HZ380
Trademark:	

Measurement Procedure Used:

APPLICABLE STANDARDS	
STANDARD	TEST RESULT
FCC 47 CFR Part 2, Subpart J FCC 47 CFR Part 15, Subpart C	PASS

The above equipment was tested by EMTEK(SHENZHEN) CO., LTD. The test data, data evaluation, test procedures, and equipment configurations shown in this report were made in accordance with the procedures given in ANSI C63.10 (2013) and the energy emitted by the sample EUT tested as described in this report is in compliance with the requirements of FCC Rules Part 2 and Part 15.247

The test results of this report relate only to the tested sample identified in this report

Date of Test : February 28, 2023 to April 3, 2023

Prepared by : 
Una Yu /Editor

Reviewer : 
Joe Xia/Supervisor

Approve & Authorized Signer : 
Lisa Wang/Manager



2 EUT TECHNICAL DESCRIPTION

Characteristics	Description
Product :	RFID Reader
Model Number :	HZ340, HZ380
Modulation:	PR-ASK, DSB-ASK
Operating Frequency :	902.75MHz~927.25MHz
Number of Channels:	50
Transmit Power Max:	26.61 dBm
Antenna Type :	External Antenna
Antenna Gain:	8 dBi
Power supply:	Adapter: MODEL NO.:FSP060-DAAN3 AC INPUT:100-240V~,1.8A 50-60Hz DC OUTPUT:24.0V=2.5A 60.0W

Note: for more details, please refer to the User's manual of the EUT.

3 SUMMARY OF TEST RESULT

FCC Part Clause	Test Parameter	Verdict	Remark
15.247(a)(1)	20 dB Bandwidth	PASS	
15.247(a)(1)	Carrier Frequency Separation	PASS	
15.247(a)(1)	Number of Hopping Frequencies	PASS	
15.247(a)(1)	Average Time of Occupancy (Dwell Time)	PASS	
15.247(b)(1)	Maximum Peak Conducted Output Power	PASS	
15.247(c)	Conducted Spurious Emissions	PASS	
15.247(d) 15.209	Radiated Spurious Emissions	PASS	
15.207	Conducted Emission	PASS	
15.203	Antenna Application	PASS	
NOTE: N/A (Not Applicable)			

RELATED SUBMITTAL(S) / GRANT(S):

This submittal(s) (test report) is intended for FCC ID: 2ANBW-HZ340 filing to comply with Section 15.247 of the FCC Part 15, Subpart C Rules.

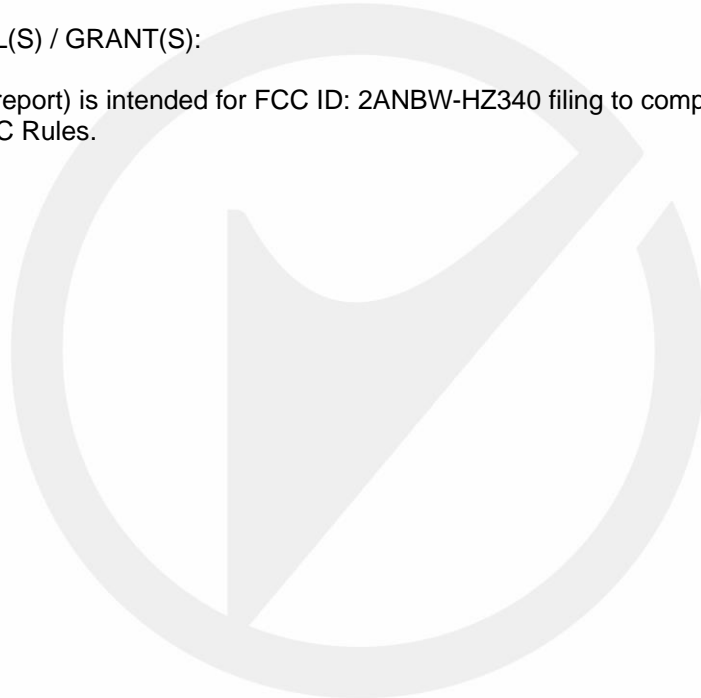

4 TEST METHODOLOGY

4.1 GENERAL DESCRIPTION OF APPLIED STANDARDS

According to its specifications, the EUT must comply with the requirements of the following standards:

FCC 47 CFR Part 2, Subpart J

FCC 47 CFR Part 15, Subpart C

KDB 558074: D01 15.247 Meas Guidance v05r02

4.2 MEASUREMENT EQUIPMENT USED

4.2.1 Conducted Emission Test Equipment

EQUIPMENT TYPE	MFR	MODEL NUMBER	SERIAL NUMBER	LAST CAL.
Test Receiver	Rohde & Schwarz	ESCI	101045	2022/5/14
L.I.S.N.	Schwarzbeck	NNLK8129	8129203	2022/5/15
Pulse Limiter	Rohde & Schwarz	ESH3-Z2	100107	2022/5/14
Voltage Probe	Rohde & Schwarz	TK9416	N/A	2022/5/14
I.S.N	TESEQ	ISN T800	30327	2022/3/18

4.2.2 Radiated Emission Test Equipment

EQUIPMENT TYPE	MFR	MODEL NUMBER	SERIAL NUMBER	LAST CAL.
EMI Test Receiver	Rohde & Schwarz	ESCI	101414	2022/5/14
Pre-Amplifier	HP	8447D	2944A07999	2022/5/14
Bilog Antenna	Schwarzbeck	VULB9163	712	2021/7/5
Loop Antenna	Schwarzbeck	FMZB1519	1519-012	2021/6/12
Horn Antenna	Schwarzbeck	BBHA 9170	9170-399	2021/6/12
Horn Antenna	Schwarzbeck	BBHA9120D	9120D-1178	2021/8/22
Cable	Schwarzbeck	AK9513	ACRX1	2022/5/14
Cable	Rosenberger	N/A	FP2RX2	2022/5/14
Cable	Schwarzbeck	AK9513	CRPX1	2022/5/14
Cable	Schwarzbeck	AK9513	CRRX2	2022/5/14

4.2.3 Radio Frequency Test Equipment

EQUIPMENT TYPE	MFR	MODEL NUMBER	SERIAL NUMBER	LAST CAL.
Wideband Radio Communication Tester	R&S	CMW500	171168	2022/5/3
Frequency Extender	R&S	CMW-Z800A	100430	2022/5/16
Spectrum Analyzer	R&S	FSV3044	MY60242456	2022/4/11
Analog Signal Generator	R&S	SMB100A	MY61252625	2022/4/22
Vector Signal Generator	R&S	SMM100A	MY61252674	2022/5/9
RF Control Unit	Tonscend	JS0806-2	22C8060567	2022/7/20
Temperature&Humidity Chamber	ESPEC	EL-02KA	12107166	2022/7/2

Remark: Each piece of equipment is scheduled for calibration once a year.

4.3 DESCRIPTION OF TEST MODES

The EUT has been tested under its typical operating condition.

The EUT configuration for testing is installed on RF field strength measurement to meet the Commissions requirement and operating in a manner which intends to maximize its emission characteristics in a continuous normal application.

The Transmitter was operated in the normal operating mode. The TX frequency was fixed which was for the purpose of the measurements.

Test of channel included the lowest and middle and highest frequency to perform the test, then record on this report.

Those channels (902.75MHz, 915.25MHz, 927.25MHz) were used for all test.

Pre-defined engineering program for regulatory testing used to control the EUT for staying in continuous transmitting and receiving mode is programmed.

Frequency and Channel list for the EUT:

Channel	Frequency (MHz)	Channel	Frequency (MHz)	Channel	Frequency (MHz)
1	902.75	24	914.25	47	925.75
2	903.25	25	914.75	48	926.25
3	903.75	26	915.25	49	926.75
...	50	927.25
Note: $f_c=902.75\text{MHz}+k*0.5\text{MHz}$ $k(\text{Channel Number})=1$ to 50					

Test Frequency and channel for the EUT:

Lowest Frequency		Middle Frequency		Highest Frequency	
Channel	Frequency (MHz)	Channel	Frequency (MHz)	Channel	Frequency (MHz)
01	902.75	26	915.25	50	927.25

5 FACILITIES AND ACCREDITATIONS

5.1 FACILITIES

All measurement facilities used to collect the measurement data are located at

Building 69, Majialong Industry Zone District, Nanshan District, Shenzhen, China

The sites are constructed in conformance with the requirements of ANSI C63.7, ANSI C63.10 and CISPR Publication 22.

5.2 LABORATORY ACCREDITATIONS AND LISTINGS

Site Description

EMC Lab.

: **Accredited by CNAS**

The Certificate Registration Number is L2291.

The Laboratory has been assessed and proved to be in compliance with CNAS-CL01 (identical to ISO/IEC 17025:2017)

Accredited by FCC

Designation Number: CN1204

Test Firm Registration Number: 882943

Accredited by A2LA

The Certificate Number is 4321.01.

Accredited by Industry Canada

The Conformity Assessment Body Identifier is CN0008

Name of Firm

: EMTEK (SHENZHEN) CO., LTD.

Site Location

: Building 69, Majialong Industry Zone,
Nanshan District, Shenzhen, Guangdong, China

6 TEST SYSTEM UNCERTAINTY

The following measurement uncertainty levels have been estimated for tests performed on the apparatus:

Parameter	Uncertainty
Radio Frequency	$\pm 1 \times 10^{-5}$
Maximum Peak Output Power Test	$\pm 1.0\text{dB}$
Conducted Emissions Test	$\pm 2.0\text{dB}$
Radiated Emission Test	$\pm 2.0\text{dB}$
Occupied Bandwidth Test	$\pm 1.0\text{dB}$
Band Edge Test	$\pm 3\text{dB}$
All emission, radiated	$\pm 3\text{dB}$
Antenna Port Emission	$\pm 3\text{dB}$
Temperature	$\pm 0.5^\circ\text{C}$
Humidity	$\pm 3\%$

Measurement Uncertainty for a level of Confidence of 95%



7 SETUP OF EQUIPMENT UNDER TEST

7.1 RADIO FREQUENCY TEST SETUP 1

The RFID component's antenna ports(s) of the EUT are connected to the measurement instrument per an appropriate attenuator. The EUT is controlled by PC/software to emit the specified signals for the purpose of measurements.

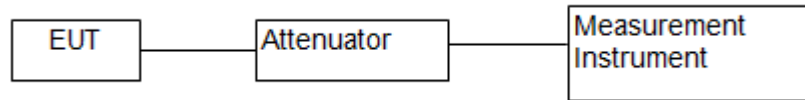

7.2 RADIO FREQUENCY TEST SETUP 2

The test site semi-anechoic chamber has met the requirement of NSA tolerance 4 dB according to the standards: ANSI C63.10. The test distance is 3m. The setup is according to the requirements in Section 13.1.4.1 of ANSI C63.10-2013 and CAN/CSA-CEI/IEC CISPR 22.

Below 30MHz:

The EUT is placed on a turntable 0.8 meters above the ground in the chamber, 3 meter away from the antenna (loop antenna). The Antenna should be positioned with its plane vertical at the specified distance from the EUT and rotated about its vertical axis for maximum response at each azimuth about the EUT. The center of the loop shall be 1 m above the ground. For certain applications, the loop antenna plane may also need to be positioned horizontally at the specified distance from the EUT.

Above 30MHz:

The EUT is placed on a turntable 0.8 meters above the ground in the chamber, 3 meter away from the antenna. The maximal emission value is acquired by adjusting the antenna height, polarisation and turntable azimuth. Normally, the height range of antenna is 1 m to 4 m, the azimuth range of turntable is 0° to 360°, and the receive antenna has two polarizations Vertical (V) and Horizontal (H).

Above 1GHz:

The EUT is placed on a turntable 1.5 meters above the ground in the chamber, 3 meter away from the antenna. The maximal emission value is acquired by adjusting the antenna height, polarisation and turntable azimuth. Normally, the height range of antenna is 1 m to 4 m, the azimuth range of turntable is 0° to 360°, and the receive antenna has two polarizations Vertical (V) and Horizontal (H).

(a) Radiated Emission Test Set-Up, Frequency Below 30MHz

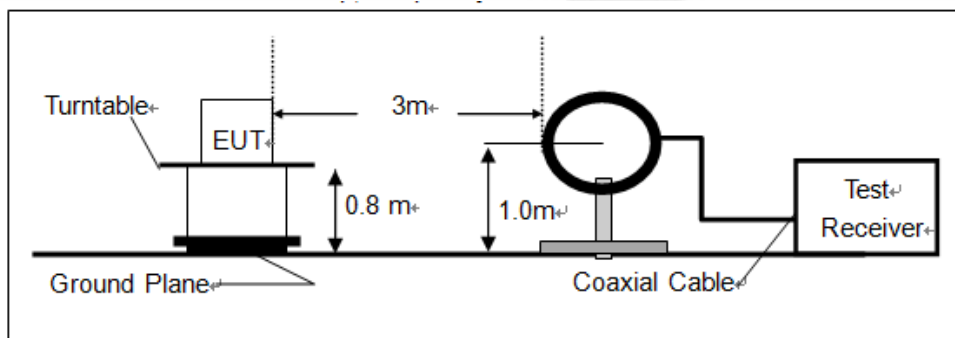

(b) Radiated Emission Test Set-Up, Frequency Below 1000MHz

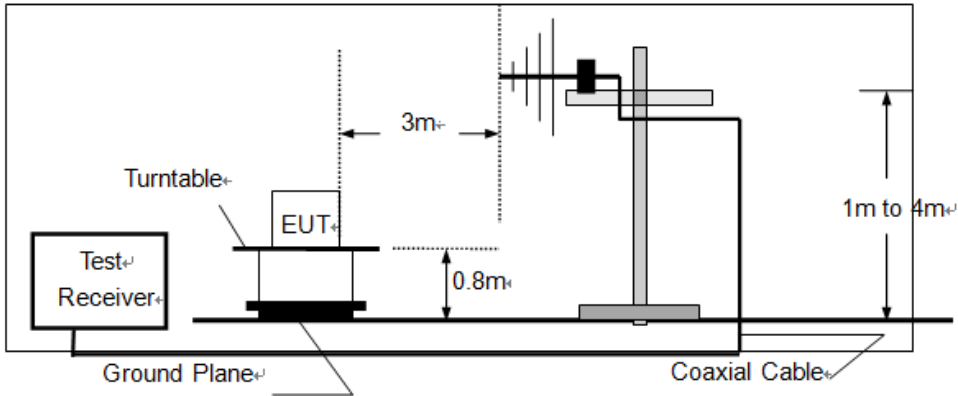

(c) Radiated Emission Test Set-Up, Frequency above 1000MHz

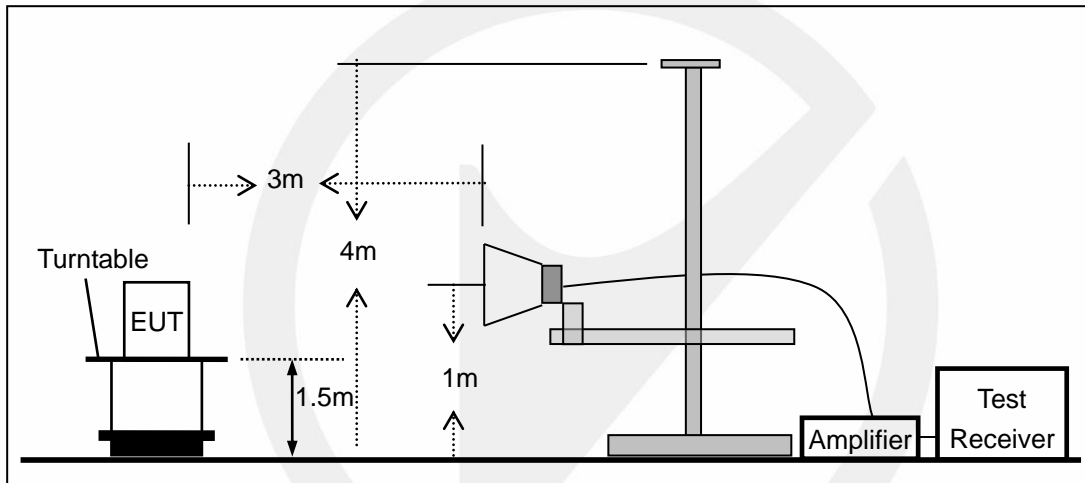

7.3 CONDUCTED EMISSION TEST SETUP

The mains cable of the EUT (UHF RFID Reader Module) must be connected to LISN. The LISN shall be placed 0.8 m from the boundary of EUT and bonded to a ground reference plane for LISN mounted on top of the ground reference plane. This distance is between the closest points of the LISN and the EUT. All other units of the EUT and associated equipment shall be at least 0.8m from the LISN.

Ground connections, where required for safety purposes, shall be connected to the reference ground point of the LISN and, where not otherwise provided or specified by the manufacturer, shall be of same length as the mains cable and run parallel to the mains connection at a separation distance of not more than 0.8 m.

According to the requirements in Section 13.1.4.1 of ANSI C63.10-2013 Conducted emissions from the EUT measured in the frequency range between 0.15 MHz and 30 MHz using CISPR Quasi-Peak and average detector mode.

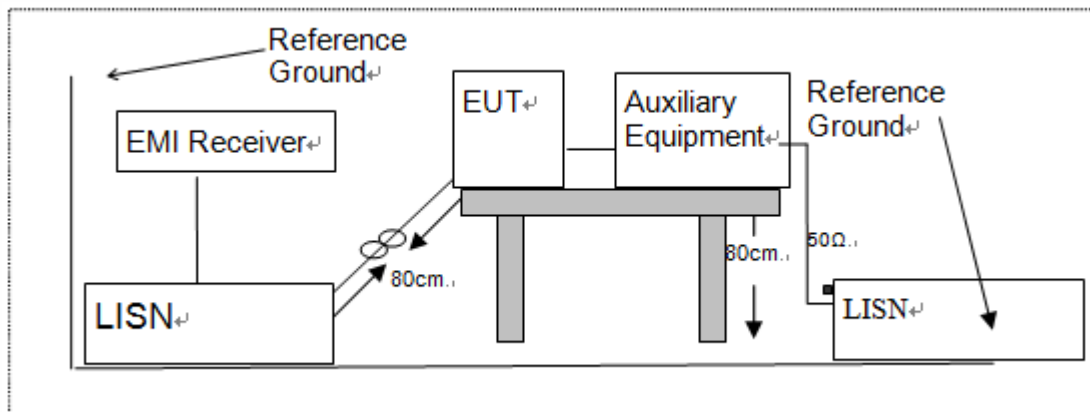

7.4 BLOCK DIAGRAM CONFIGURATION OF TEST SYSTEM

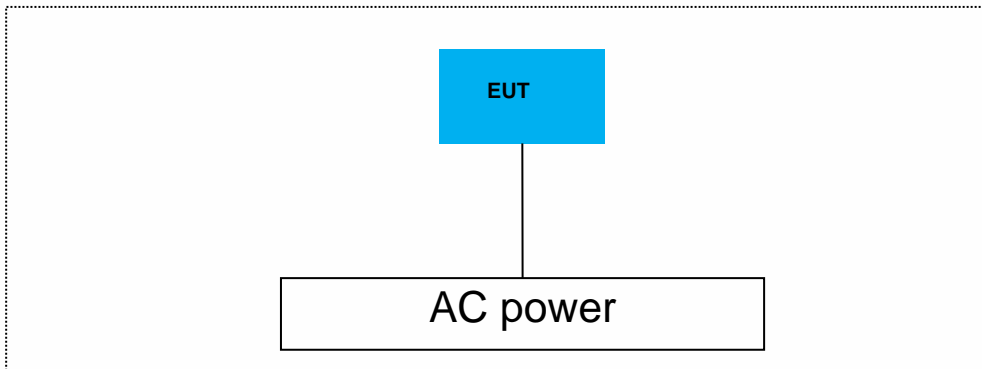

7.5 SUPPORT EQUIPMENT

EUT Cable List and Details			
Cable Description	Length (m)	Shielded/Unshielded	With / Without Ferrite
/	/	/	/

Auxiliary Cable List and Details			
Cable Description	Length (m)	Shielded/Unshielded	With / Without Ferrite
/	/	/	/

Auxiliary Equipment List and Details			
Description	Manufacturer	Model	Serial Number
/	/	/	/

Notes:

1. All the equipment/cables were placed in the worst-case configuration to maximize the emission during the test.
2. Grounding was established in accordance with the manufacturer’s requirements and conditions for the intended use.

8 TEST REQUIREMENTS

8.1 20DB BANDWIDTH

8.1.1 Applicable Standard

According to FCC Part 15.247(a)(1) and KDB 558074: D01 15.247 Meas Guidance v05r02

8.1.2 Conformance Limit

No limit requirement.

8.1.3 Test Configuration

Test according to clause 7.1 radio frequency test setup 1

8.1.4 Test Procedure

The EUT was operating in RFID mode and controlled its channel. Printed out the test result from the spectrum by hard copy function.

The RF output of EUT was connected to the spectrum analyzer by RF cable and attenuator. The path loss was compensated to the results for each measurement.

Set to the maximum power setting and enable the EUT transmit continuously

Set RBW \geq 1% of the 20 dB bandwidth(3KHz)

Set the video bandwidth (VBW) \geq RBW(10KHz).

Set Span= approximately 2 to 3 times the 20 dB bandwidth

Set Detector = Peak.

Set Trace mode = max hold.

Set Sweep = auto couple.

The EUT should be transmitting at its maximum data rate. Allow the trace to stabilize. Use the marker-to-peak function to set the marker to the peak of the emission. Use the marker-delta function to measure 20 dB down one side of the emission. Reset the markerdelta function, and move the marker to the other side of the emission, until it is (as close as possible to) even with the reference marker level. The marker-delta reading at this point is the 20 dB bandwidth of the emission.

If this value varies with different modes of operation (e.g., data rate, modulation format, etc.), repeat this test for each variation.

Measure and record the results in the test report.

Test Results

Temperature:	26° C
Relative Humidity:	54%
ATM Pressure:	1011 mbar

Modulation Mode	Channel Number	Channel Frequency (MHz)	Measurement Bandwidth (kHz)	Limit (kHz)	Verdict
ASK	01	902.75	72.5	\leq 250	PASS
	26	915.25	72.5	\leq 250	PASS
	50	927.25	72.94	\leq 250	PASS

Note: N/A (Not Applicable).

Test Model 20dB Bandwidth
RFID
Channel 1: 902.75MHz

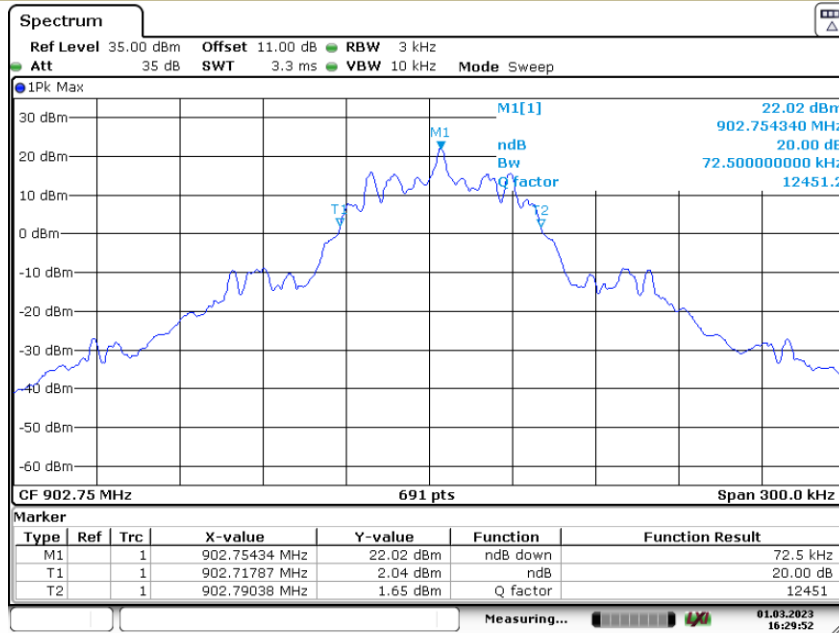

Date: 1.MAR.2023 16:29:52

Test Model 20dB Bandwidth
RFID
Channel 26: 915.25MHz



Date: 1.MAR.2023 16:30:54

Test Model 20dB Bandwidth
RFID
Channel 50: 927.25MHz

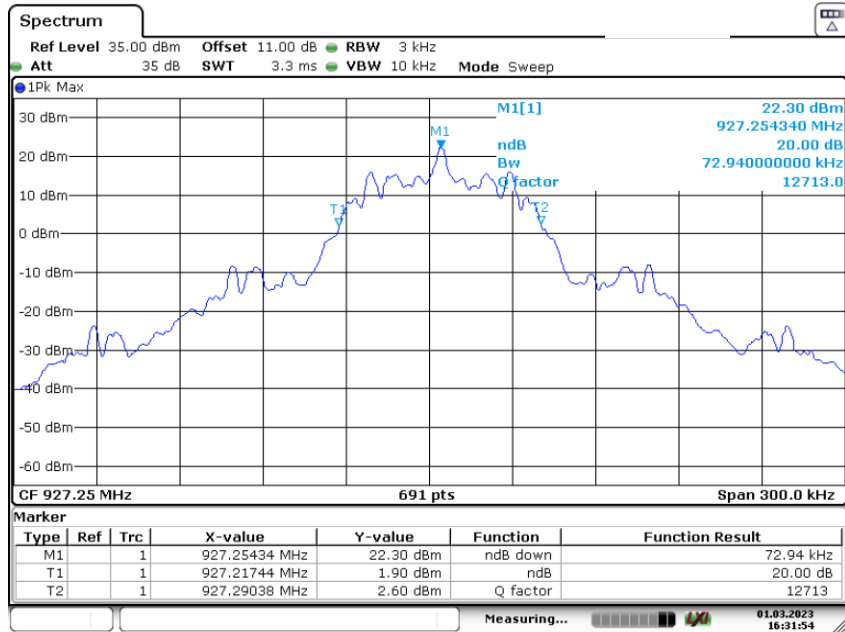

Date: 1.MAR.2023 16:31:53



8.2 CARRIER FREQUENCY SEPARATION

8.2.1 Applicable Standard

According to FCC Part 15.247(a)(1) and KDB 558074: D01 15.247 Meas Guidance v05r02

8.2.2 Conformance Limit

Frequency hopping systems operating in the 902-928MHz band shall have hopping channel carrier frequencies separated by a minimum of 25kHz or the 20dB bandwidth of the hopping channel, whichever is greater. In case of an output power less than 125mW, the frequency hopping system may have channels separated by a minimum of 25kHz or two-thirds of the 20dB bandwidth of the hopping channel, whichever is greater.

8.2.3 Test Configuration

Test according to clause 7.1 radio frequency test setup 1

8.2.4 Test Procedure

- According to FCC Part 15.247(a)(1)
The EUT must have its hopping function enabled. Use the following spectrum analyzer settings:
Set the RBW \geq 1% of the span(100KHz).
Set the VBW \geq RBW(300KHz).
Set the span = wide enough to capture the peaks of two adjacent channels
Set Sweep time = auto couple.
Set Detector = peak.
Set Trace mode = max hold.
Allow the trace to stabilize. Use the marker-delta function to determine the separation between the peaks of the adjacent channels. The limit is specified in one of the subparagraphs of this Section. Submit this plot.

Test Results

Temperature:	26° C
Relative Humidity:	54%
ATM Pressure:	1011 mbar

Modulation Mode	Channel Number	Channel Frequency (MHz)	Measurement Bandwidth (kHz)	Limit (kHz)	Verdict
ASK	01	902.75	495.60	>48.33	PASS
	26	915.25	500.70	>48.33	PASS
	50	927.25	499.30	>48.63	PASS
Note: Limit = 20dB bandwidth.					

Test Model Carrier Frequency Separation
RFID
Channel 1: 902.75MHz

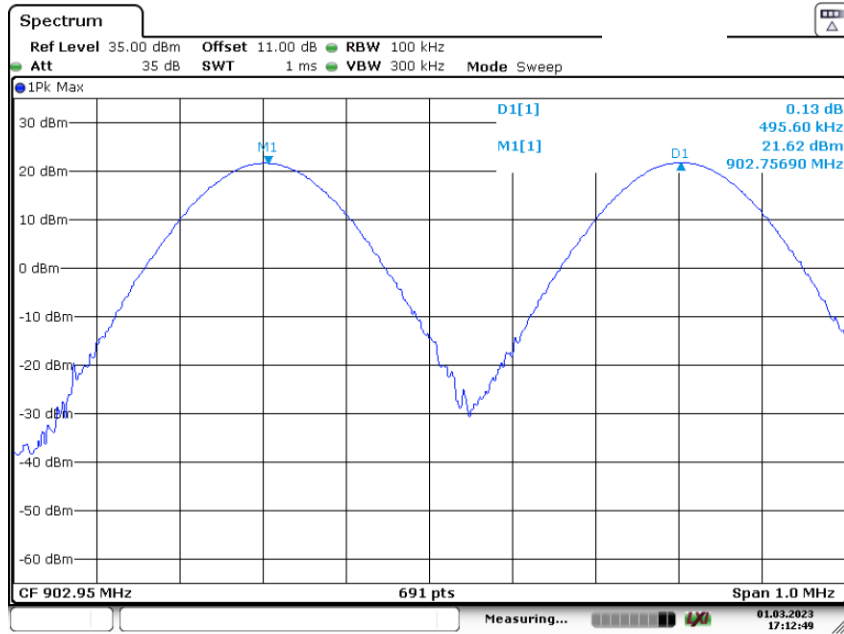

Date: 1.MAR.2023 17:12:50

Test Model Carrier Frequency Separation
RFID
Channel 26: 915.25MHz

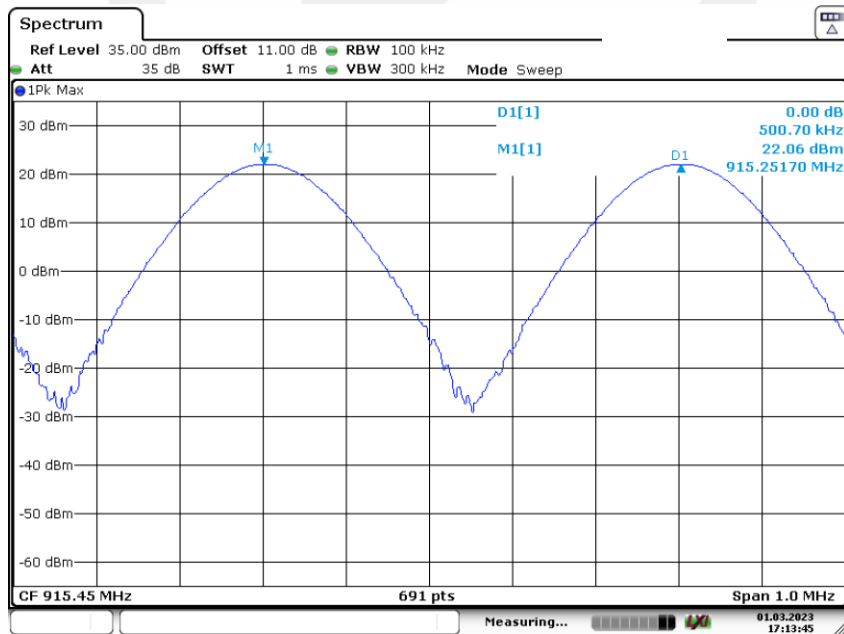

Date: 1.MAR.2023 17:13:46

Test Model Carrier Frequency Separation
RFID
Channel 50: 927.25MHz

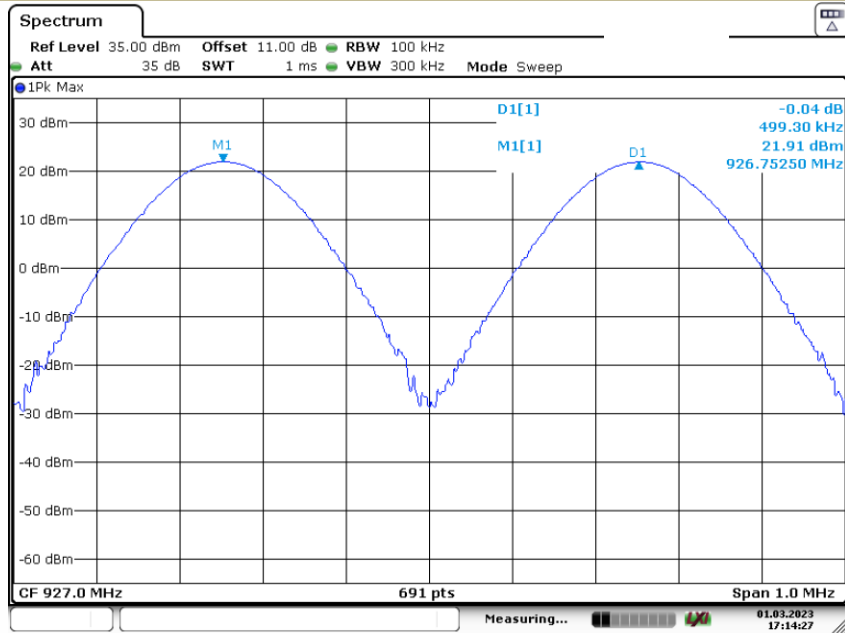

Date: 1.MAR.2023 17:14:27



8.3 NUMBER OF HOPPING FREQUENCIES

8.3.1 Applicable Standard

According to FCC Part 15.247(a)(1) (i)and KDB 558074: D01 15.247 Meas Guidance v05r02

8.3.2 Conformance Limit

Frequency hopping systems operating in the 902-928MHz band shall use at least 50 channels.

8.3.3 Test Configuration

Test according to clause 7.1 radio frequency test setup 1

8.3.4 Test Procedure

- According to FCC Part15.247(a)(1)(iii)

The EUT must have its hopping function enabled. Use the following spectrum analyzer settings:

Span = the frequency band of operation

RBW \geq 1% of the span(100KHz).

VBW \geq RBW(300KHz).

Sweep = auto

Detector function = peak

Trace = max hold

Allow the trace to stabilize. It may prove necessary to break the span up to sections, in order to clearly show all of the hopping frequencies.

Test Results

Temperature:	26° C
Relative Humidity:	54%
ATM Pressure:	1011 mbar

Hopping Channel Frequency Range	Quantity of Hopping Channel	Quantity of Hopping Channel limit
902-928	50	\geq 50

Test Model Number Of Hopping Frequencies
RFID

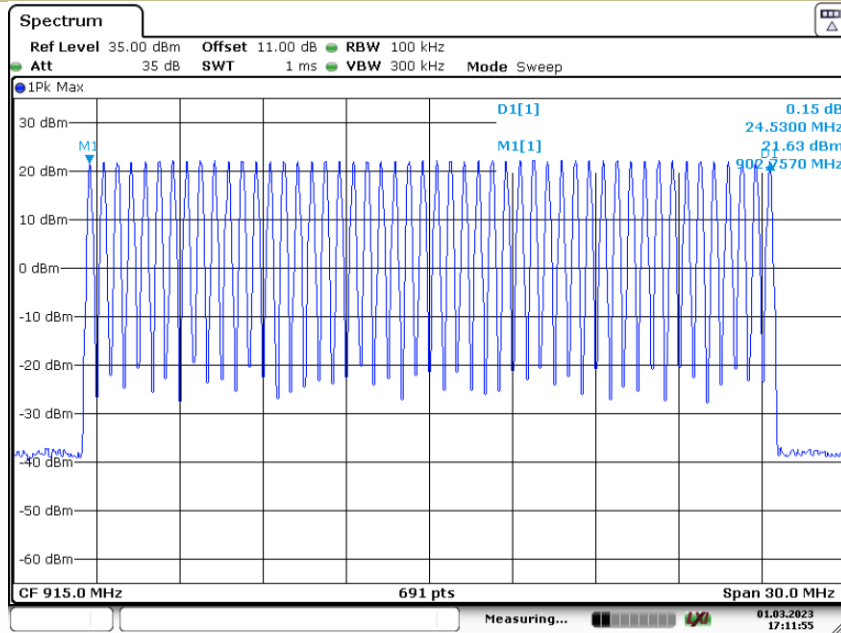

Date: 1.MAR.2023 17:11:55



8.4 AVERAGE TIME OF OCCUPANCY (DWELL TIME)

8.4.1 Applicable Standard

According to FCC Part 15.247(a)(1)(i) and KDB 558074: D01 15.247 Meas Guidance v05r02

8.4.2 Conformance Limit

For frequency hopping systems operating in the 902-928 MHz band: if the 20 dB bandwidth of the hopping channel is less than 250 kHz, the system shall use at least 50 hopping frequencies and the average time of occupancy on any frequency shall not be greater than 0.4 seconds within a 20 second period; if the 20 dB bandwidth of the hopping channel is 250 kHz or greater, the system shall use at least 25 hopping frequencies and the average time of occupancy on any frequency shall not be greater than 0.4 seconds within a 10 second period. The maximum allowed 20 dB bandwidth of the hopping channel is 500 kHz..

8.4.3 Test Configuration

Test according to clause 7.1 radio frequency test setup 1

8.4.4 Test Procedure

■ According to FCC Part 15.247(a)(1)(iii)

The EUT must have its hopping function enabled. Use the following spectrum analyzer settings:

Span = zero span, centered on a hopping channel

RBW = 100 KHz

VBW ≥ RBW

Sweep = as necessary to capture the entire dwell time per hopping channel

Detector function = peak

Trace = max hold

If possible, use the marker-delta function to determine the dwell time. If this value varies with different modes of operation (e.g., data rate, modulation format, etc.), repeat this test for each variation. The limit is specified in one of the subparagraphs of this Section.

8.4.5 Test Results

PASS.

All modes (low, mid, high channels) were tested, the data of the worst mode are described in the following pages.

Temperature:	26° C
Relative Humidity:	54%
ATM Pressure:	1011 mbar

Modulation Mode	Frequency (MHz)	occupied time for each channel	dwell time (ms)	Limit(ms)	Verdict
PR-ASK, DSB-ASK	915.25	31.449ms	314.49 ms	<400	PASS

Note:

occupied time for each channel

31.449ms

Dwell time per 20 seconds

31.449*10=314.49 ms

Test Model Average Time Of Occupancy (Dwell Time)
 RFID
 CH 01: 902.75MHz The number of occupied channels per 2 seconds

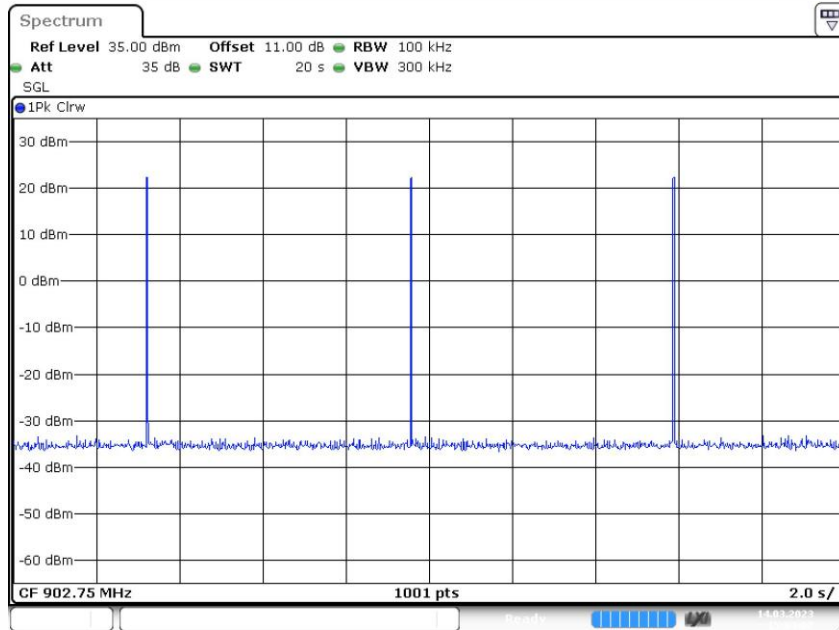

Date: 14.MAR.2023 15:03:06

Test Model Average Time Of Occupancy (Dwell Time)
 RFID
 CH 01: 902.75MHz occupied time for each channel

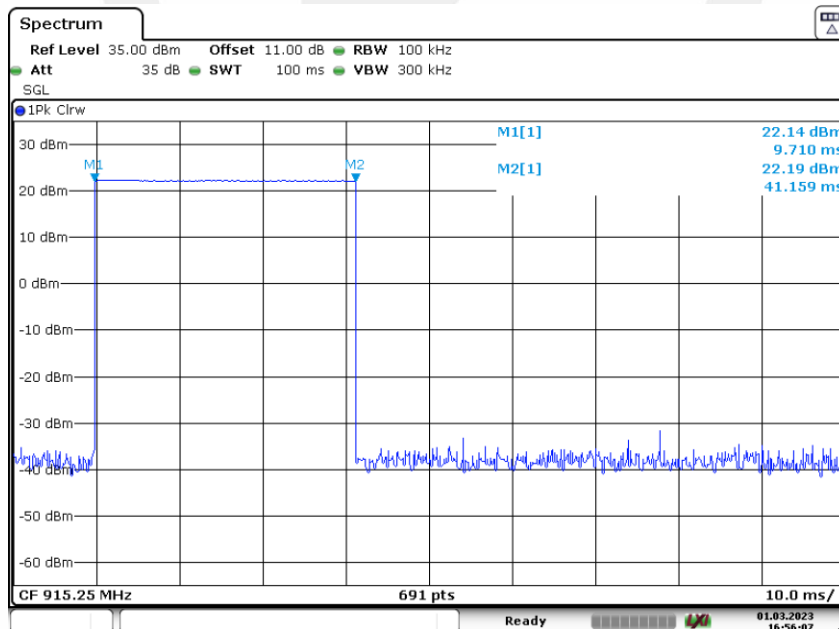

Date: 1.MAR.2023 16:56:07

8.5 MAXIMUM PEAK CONDUCTED OUTPUT POWER

8.5.1 Applicable Standard

According to FCC Part 15.247(b)(1) and KDB 558074: D01 15.247 Meas Guidance v05r02

8.5.2 Conformance Limit

For frequency hopping systems operating in the 902-928 MHz band: 1 watt for systems employing at least 50 hopping channels; and, 0.25 watts for systems employing less than 50 hopping channels, but at least 25 hopping channels, as permitted under paragraph (a)(1)(i) of this section.

8.5.3 Test Configuration

Test according to clause 7.1 radio frequency test setup 1

8.5.4 Test Procedure

■ According to FCC Part 15.247(b)(1)

As an alternative to a peak power measurement, compliance with the limit can be based on a measurement of the maximum conducted output power.

Use the following spectrum analyzer settings:

Set Span = approximately 5 times the 20 dB bandwidth, centered on a hopping channel (about 10MHz)

Set RBW > the 20 dB bandwidth of the emission being measured (about 1MHz)

Set VBW ≥ RBW

Set Sweep = auto

Set Detector function = peak

Set Trace = max hold

Allow the trace to stabilize. Use the marker-to-peak function to set the marker to the peak of the emission to determine the peak amplitude level.

Test Results

Temperature:	26° C
Relative Humidity:	54%
ATM Pressure:	1011 mbar

Operation Mode	Channel Number	Channel Frequency (MHz)	Measurement Level (dBm)	Limit (dBm)	Verdict
ASK	01	902.75	26.49	27	PASS
	26	915.25	26.55	27	PASS
	50	927.25	26.61	27	PASS
Note: N/A					

Test Model Maximum Peak Conducted Output Power
RFID
Channel 01: 902.75MHz

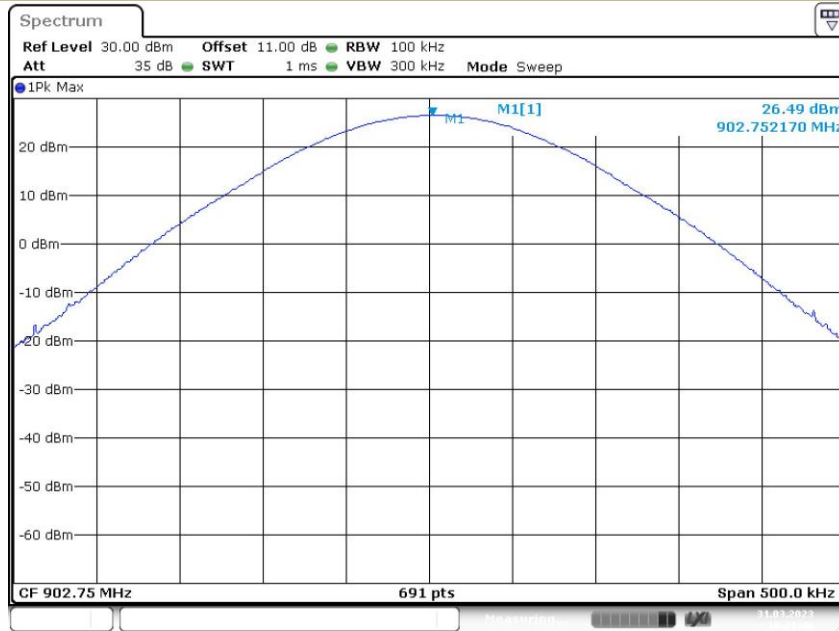

Date: 31.MAR.2023 10:21:40

Test Model Maximum Peak Conducted Output Power
RFID
Channel 26: 915.25MHz



Date: 31.MAR.2023 10:23:16

Test Model Maximum Peak Conducted Output Power
RFID
Channel 50: 927.25MHz

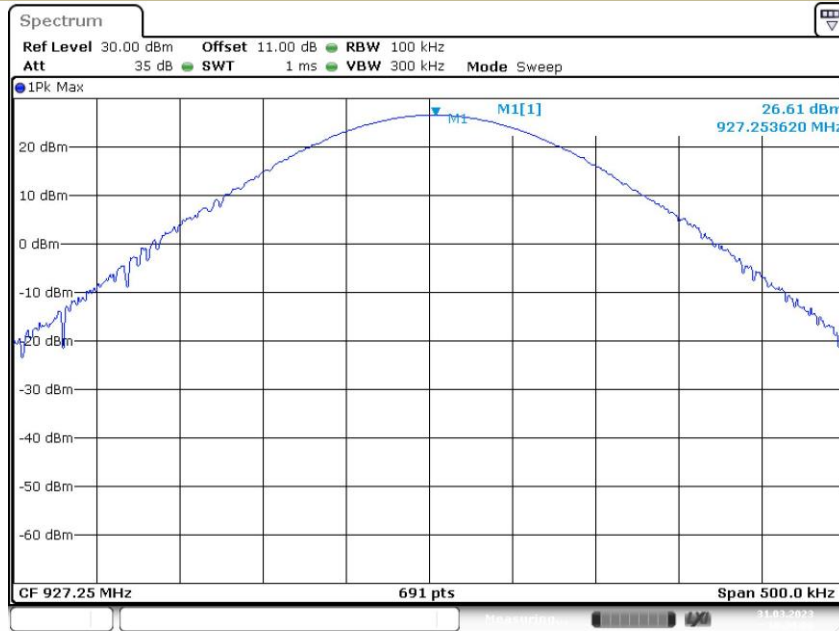

Date: 31.MAR.2023 10:24:36



8.6 CONDUCTED SUPRIIOUS EMISSION

8.6.1 Applicable Standard

According to FCC Part 15.247(d) and KDB 558074: D01 15.247 Meas Guidance v05r02

8.6.2 Conformance Limit

According to FCC Part 15.247(d):

In any 100 kHz bandwidth outside the frequency band in which the spread spectrum intentional radiator is operating, the radio frequency power that is produced by the intentional radiator shall be at least 20 dB below that in the 100 kHz bandwidth within the band that contains the highest level of the desired power, based on either an RF conducted, provided the transmitter demonstrates compliance with the peak conducted power limits.

8.6.3 Test Configuration

Test according to clause 7.1 radio frequency test setup 1

8.6.4 Test Procedure

The transmitter output (antenna port) was connected to the spectrum analyzer

■ Reference level measurement

Establish a reference level by using the following procedure:

Set instrument center frequency to DSS channel center frequency.

Set Span = approximately 5 times the 20 dB bandwidth, centered on a hopping channel.

Set the RBW = 100 kHz. Set the VBW $\geq 3 \times$ RBW.

Set Detector = peak. Set Sweep time = auto couple.

Set Trace mode = max hold. Allow trace to fully stabilize.

Use the peak marker function to determine the maximum Maximum conduceted level.

Note that the channel found to contain the maximum conduceted level can be used to establish the reference level.

■ Band-edge Compliance of RF Conducted Emissions

Use the following spectrum analyzer settings:

Span = wide enough to capture the peak level of the emission operating on the channel closest to the band-edge, as well as any modulation products which fall outside of the authorized band of operation

Set RBW $\geq 1\%$ of the span=100kHz Set VBW \geq RBW

Set Sweep = auto Set Detector function = peak Set Trace = max hold

Allow the trace to stabilize. Set the marker on the emission at the bandedge, or on the highest modulation product outside of the band, if this level is greater than that at the bandedge. Enable the marker-delta function, then use the marker-to-peak function to move the marker to the peak of the in-band emission. The marker-delta value now displayed must comply with the limit specified in this Section.

Now, using the same instrument settings, enable the hopping function of the EUT. Allow the trace to stabilize.

Follow the same procedure listed above to determine if any spurious emissions caused by the hopping function also comply with the specified limit.

■ Conduceted Spurious RF Conducted Emission

Use the following spectrum analyzer settings:

Span = wide enough to capture the peak level of the in-band emission and all spurious emissions (e.g., harmonics) from the lowest frequency generated in the EUT up through the 10th harmonic.(30MHz to 25GHz). Set RBW =

100 kHz Set VBW \geq RBW

Set Sweep = auto Set Detector function = peak Set Trace = max hold

Allow the trace to stabilize. Set the marker on the peak of any spurious emission recorded. The level displayed must comply with the limit specified in this Section.

8.6.5 Test Results

Test Model Maximum Conducted Level RBW=100kHz
RFID
Channel 01: 902.75MHz



Date: 31.MAR.2023 10:35:13

Test Model Conducted Spurious RF Conducted Emission
RFID
Channel 01: 902.75MHz

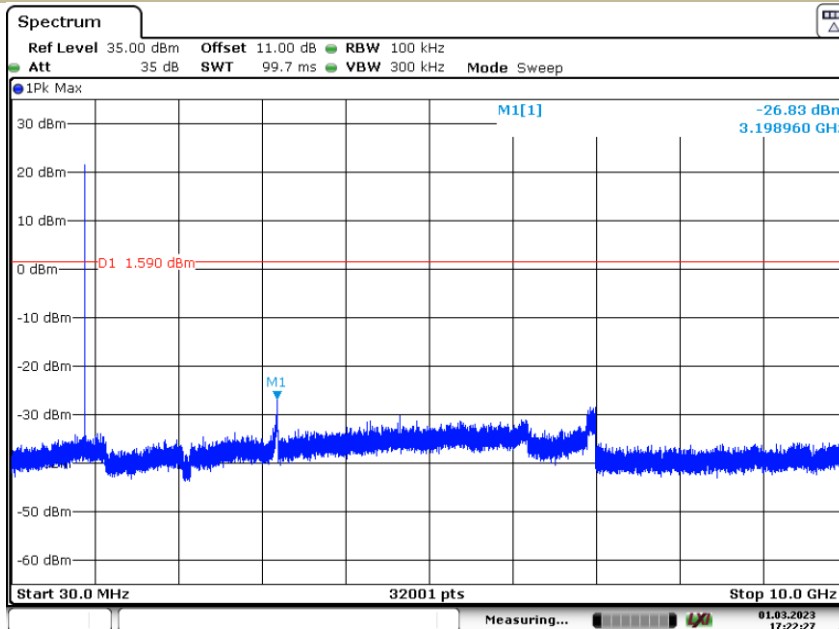

Date: 1.MAR.2023 17:22:27

Test Model Band-edge Conducted Emissions
RFID
Channel 01: 902.75MHz

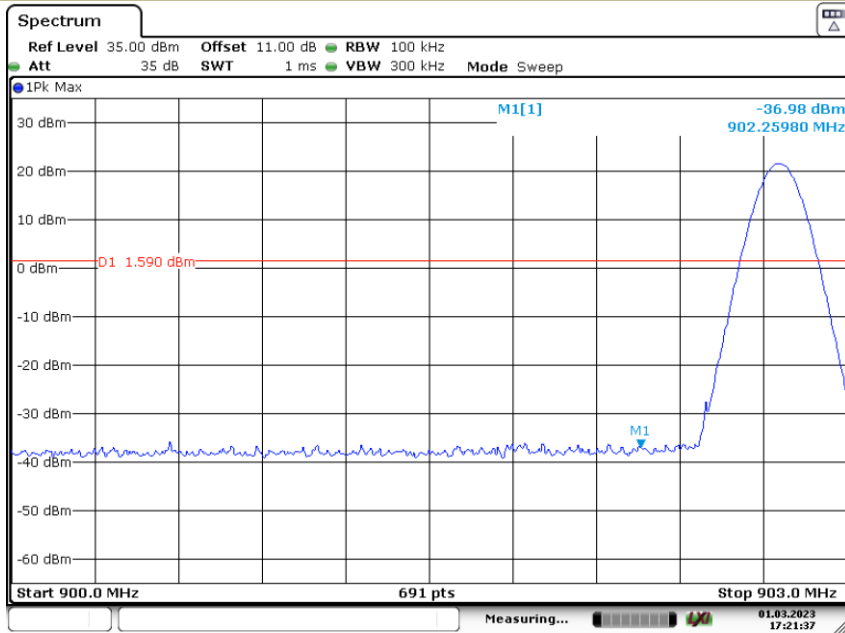

Date: 1.MAR.2023 17:21:37

Test Model Maximum Conducted Level RBW=100kHz
RFID
Channel 26: 915.25MHz



Date: 31.MAR.2023 10:32:46

Test Model **Conduceted Spurious RF Conducted Emission**
RFID
Channel 26: 915.25MHz

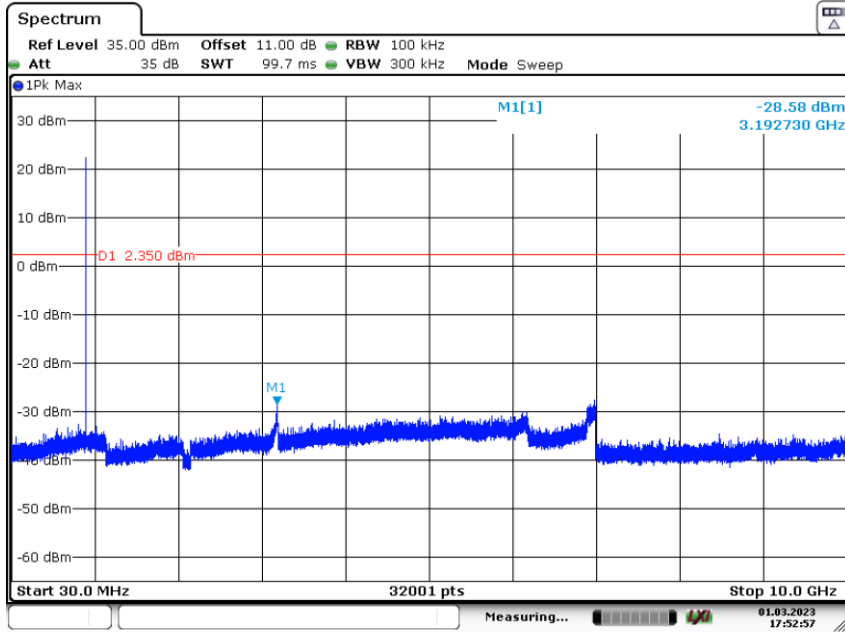

Date: 1.MAR.2023 17:52:57

Test Model **Maximum Conduceted Level RBW=100kHz**
RFID
Channel 50: 927.25MHz

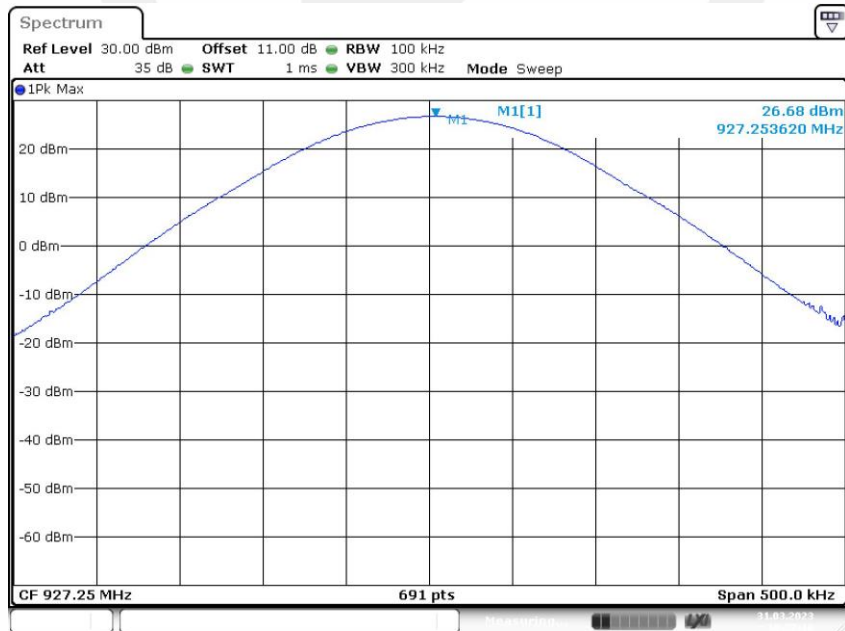

Date: 31.MAR.2023 10:27:16

Test Model **Conducted Spurious RF Conducted Emission**
RFID
Channel 50: 927.25MHz

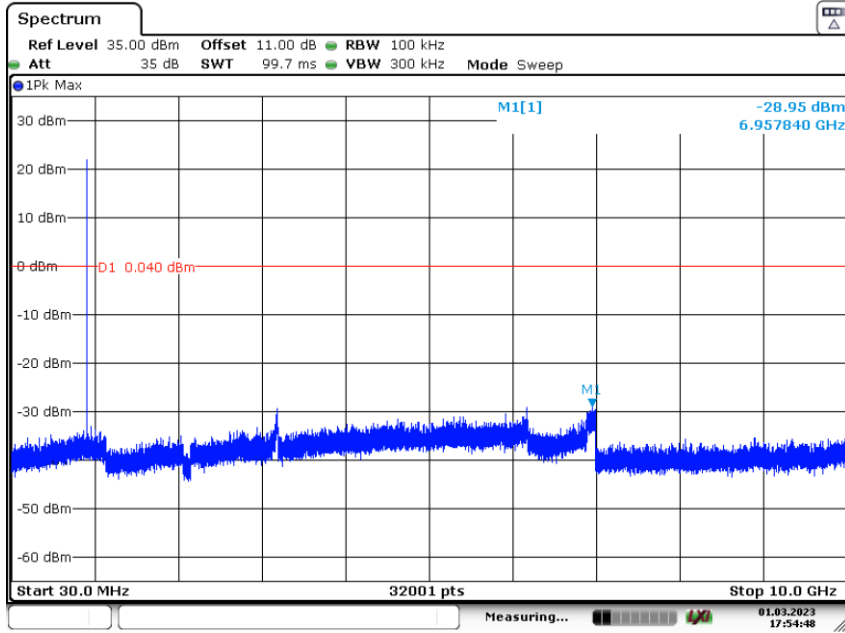

Date: 1.MAR.2023 17:54:48

Test Model **Band-edge Conducted Emissions**
RFID
Channel 50: 927.25MHz

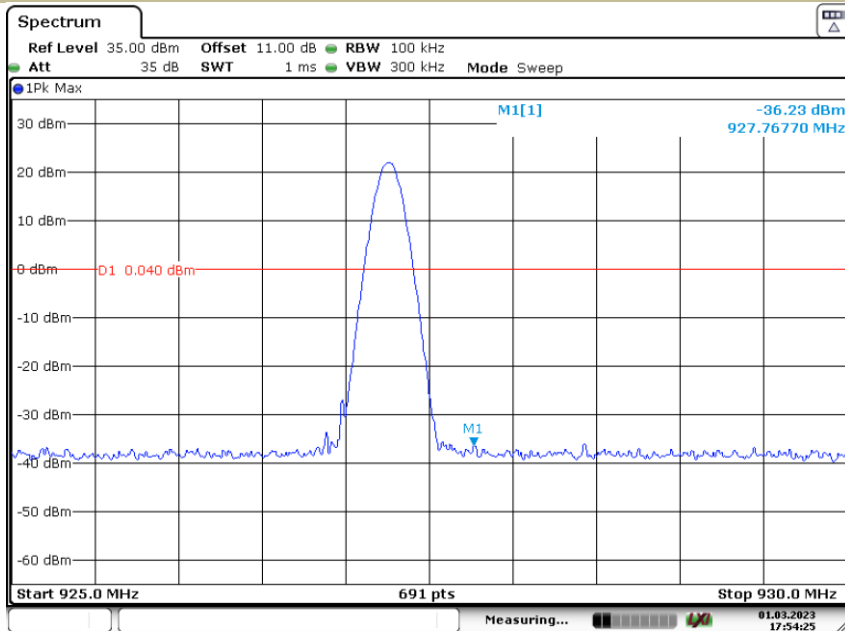

Date: 1.MAR.2023 17:54:24

Test Model Maximum Conduceted Level RBW=100kHz
RFID
Hopping

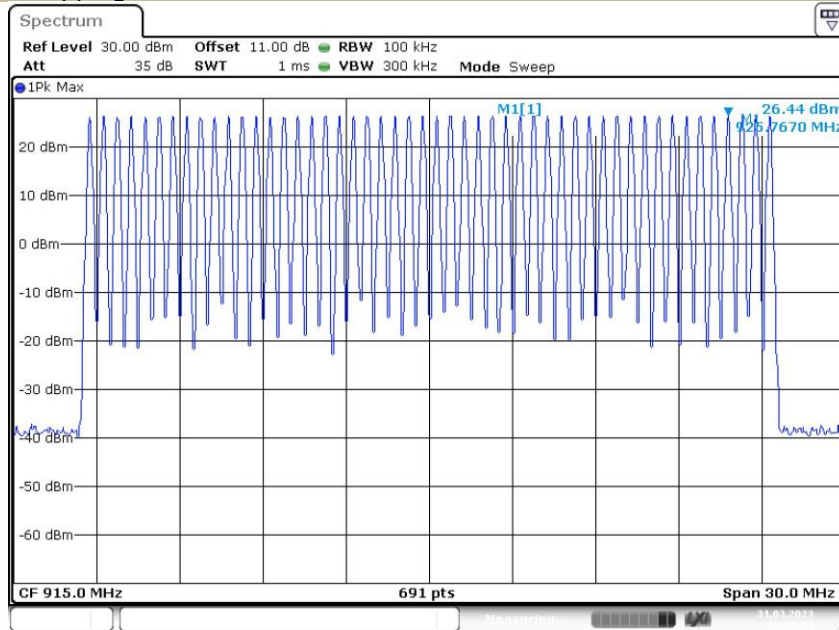

Date: 31.MAR.2023 10:39:05

Test Model Conduceted Spurious RF Conducted Emission
RFID
Hopping

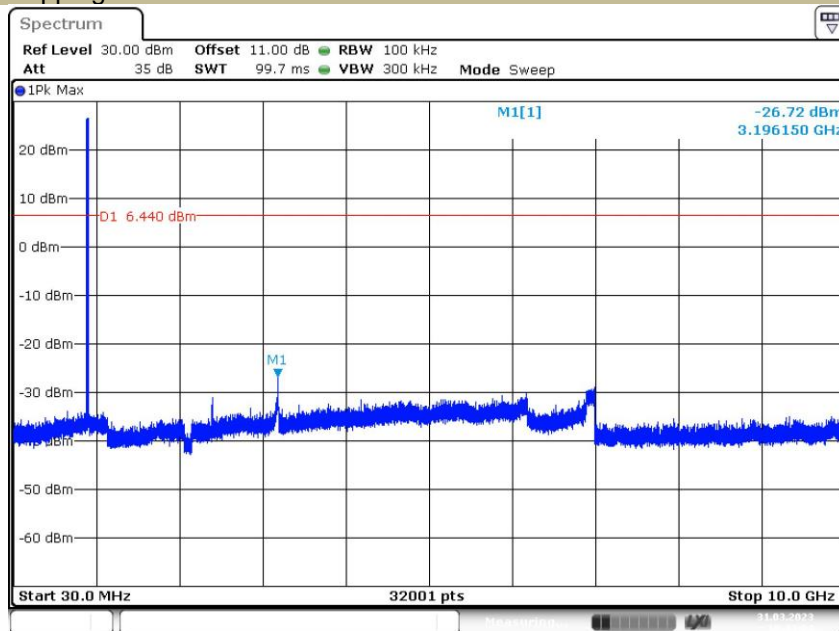

Date: 31.MAR.2023 10:43:04

Test Model Band-edge Conducted Emissions
RFID
Hopping

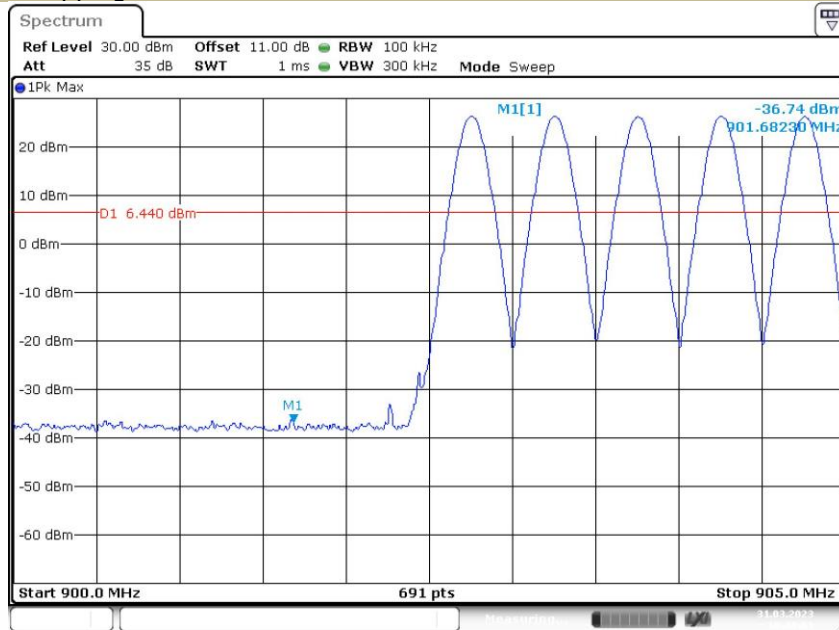

Date: 31.MAR.2023 10:40:51

Test Model Band-edge Conducted Emissions
RFID
Hopping

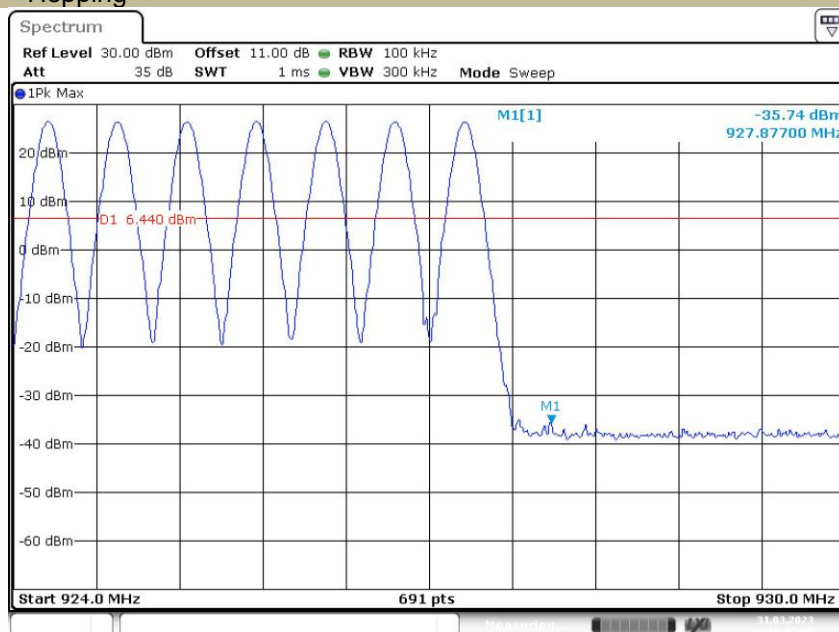

Date: 31.MAR.2023 10:42:07

8.7 RADIATED SPURIOUS EMISSION

8.7.1 Applicable Standard

According to FCC Part 15.247(d) and 15.209 and KDB 558074: D01 15.247 Meas Guidance v05r02

8.7.2 Conformance Limit

According to FCC Part 15.247(d): radiated emissions which fall in the restricted bands, as defined in §15.205(a), must also comply with the radiated emission limits specified in §15.209(a) (see §15.205(c)).

According to FCC Part 15.205, Restricted bands

MHz	MHz	MHz	GHz
0.090-0.110	16.42-16.423	399.9-410	4.5-5.15
10.495-0.505	16.69475-16.69525	608-614	5.35-5.46
2.1735-2.1905	16.80425-16.80475	960-1240	7.25-7.75
4.125-4.128	25.5-25.67	1300-1427	8.025-8.5
4.17725-4.17775	37.5-38.25	1435-1626.5	9.0-9.2
4.20725-4.20775	73-74.6	1645.5-1646.5	9.3-9.5
6.215-6.218	74.8-75.2	1660-1710	10.6-12.7
6.26775-6.26825	123-138	2200-2300	14.47-14.5
8.291-8.294	149.9-150.05	2310-2390	15.35-16.2
8.362-8.366	156.52475-156.52525	2483.5-2500	17.7-21.4
8.37625-8.38675	156.7-156.9	2690-2900	22.01-23.12
8.41425-8.41475	162.0125-167.17	3260-3267	23.6-24.0
12.29-12.293	167.72-173.2	3332-3339	31.2-31.8
12.51975-12.52025	240-285	3345.8-3358	36.43-36.5
12.57675-12.57725	322-335.4	3600-4400	(2)
13.36-13.41			

According to FCC Part 15.205, the level of any transmitter spurious emission in Restricted bands shall not exceed the level of the emission specified in the following table

Restricted Frequency(MHz)	Field Strength (μV/m)	Field Strength (dBμV/m)	Measurement Distance
0.009-0.490	2400/F(KHz)	20 log (uV/m)	300
0.490-1.705	24000/F(KHz)	20 log (uV/m)	30
1.705-30	30	29.5	30
30-88	100	40	3
88-216	150	43.5	3
216-960	200	46	3
Above 960	500	54	3

Remark :1. Emission level in dBuV/m=20 log (uV/m)

2. Measurement was performed at an antenna to the closed point of EUT distance of meters.

3. Distance extrapolation factor =40log(Specific distance/ test distance)(dB);

Limit line=Specific limits(dBuV) + distance extrapolation factor.

for the frequency ranges below 30 MHz, a narrower RBW is used for these ranges but the measured value should add a RBW correction factor (RBWCF) where RBWCF [dB] =10*lg(100 [kHz]/narrower RBW [kHz]). , the narrower RBW is 1 kHz and RBWCF is 20 dB for the frequency 9 kHz to 150 kHz, and the narrower RBW is 10 kHz and RBWCF is 10 dB for the frequency 150 kHz to 30 MHz.

8.7.3 Test Configuration

Test according to clause 7.2 radio frequency test setup 2

8.7.4 Test Procedure

This test is required for any spurious emission that falls in a Restricted Band, as defined in Section 15.205. It must be performed with the highest gain of each type of antenna proposed for use with the EUT. Use the following spectrum analyzer settings:

For Above 1GHz:

The EUT was placed on a turn table which is 0.8m above ground plane.

Maximum procedure was performed on the highest emissions to ensure EUT compliance.

Span = wide enough to fully capture the emission being measured

RBW = 1 MHz

VBW \geq RBW

Sweep = auto

Detector function = peak

Trace = max hold

For Below 1GHz:

The EUT was placed on a turn table which is 0.8m above ground plane.

Maximum procedure was performed on the highest emissions to ensure EUT compliance.

Span = wide enough to fully capture the emission being measured

RBW = 100 kHz for

VBW \geq RBW

Sweep = auto

Detector function = peak

Trace = max hold

For Below 30MHz:

The EUT was placed on a turn table which is 0.8m above ground plane.

Maximum procedure was performed on the highest emissions to ensure EUT compliance.

Span = wide enough to fully capture the emission being measured

RBW = 9kHz

VBW \geq RBW

Sweep = auto

Detector function = peak

Trace = max hold

For Below 150KHz:

The EUT was placed on a turn table which is 0.8m above ground plane.

Maximum procedure was performed on the highest emissions to ensure EUT compliance.

Span = wide enough to fully capture the emission being measured

RBW = 200Hz

VBW \geq RBW

Sweep = auto

Detector function = peak

Trace = max hold

Follow the guidelines in ANSI C63.10-2013 with respect to maximizing the emission by rotating the EUT, measuring the emission while the EUT is situated in three orthogonal planes (if appropriate), adjusting the measurement antenna height and polarization, etc. A pre-amp and a high pass filter are required for this test, in order to provide the measuring system with sufficient sensitivity. Allow the trace to stabilize. The peak reading of the emission, after being corrected by the antenna factor, cable loss, pre-amp gain, etc., is the peak field strength, which must comply with the limit specified in Section 15.35(b). Submit this data.

Now set the VBW to 10 Hz, while maintaining all of the other instrument settings. This peak level, once corrected, must comply with the limit specified in Section 15.209. If the dwell time per channel of the hopping signal is less than 100 ms, then the reading obtained with the 10 Hz VBW may be further adjusted by a "duty cycle correction factor", derived from $20\log(\text{dwell time}/100 \text{ ms})$, in an effort to demonstrate compliance with the 15.209 limit. Submit this data.

Repeat above procedures until all frequency measured was complete.

8.7.5 Test Results

■ Spurious Emission below 30MHz (9KHz to 30MHz)

Temperature:	26° C
Relative Humidity:	54%
ATM Pressure:	1011 mbar

Freq. (MHz)	Ant.Pol. H/V	Emission Level(dBuV/m)		Limit 3m(dBuV/m)		Over(dB)	
		PK	AV	PK	AV	PK	AV
--	--	--	--	--	--	--	--

Note: the amplitude of spurious emission that is attenuated by more than 20dB below the permissible limit has no need to be reported.

Distance extrapolation factor = $40 \log(\text{Specific distance} / \text{test distance})$ (dB);

Limit line = Specific limits(dBuV) + distance extrapolation factor.



■ Spurious Emission Above 1GHz (1GHz to 10GHz)

Test mode: ASK Frequency: Channel 01: 902.75MHz

Freq. (MHz)	Ant.P ol. H/V	Emission Level(dBuV/m)		Limit 3m(dBuV/m)		Over(dB)	
		PK	AV	PK	AV	PK	AV
11348.3	V	60.16	48.79	74	54	13.84	5.21
14561.5	V	63.77	50.30	74	54	10.23	3.70
17984.9	V	68.85	48.54	74	54	5.15	5.46
11498.4	H	60.14	49.87	74	54	13.86	4.13
14561.5	H	64.05	50.30	74	54	9.95	3.70
17969.9	H	68.00	48.35	74	54	6.00	5.65

Test mode: ASK Frequency: Channel 01: 915.75MHz

Freq. (MHz)	Ant.P ol. H/V	Emission Level(dBuV/m)		Limit 3m(dBuV/m)		Over(dB)	
		PK	AV	PK	AV	PK	AV
11498.4	V	60.35	50.17	74	54	13.65	3.83
14681.6	V	63.71	49.72	74	54	10.29	4.28
17594.5	V	68.49	50.72	74	54	5.51	3.28
11498.4	H	60.54	50.31	74	54	13.46	3.69
14681.6	H	64.26	49.70	74	54	9.74	4.30
17624.6	H	68.09	50.23	74	54	5.91	3.77

Test mode: ASK Frequency: Channel 50: 927.25MHz

Freq. (MHz)	Ant.P ol. H/V	Emission Level(dBuV/m)		Limit 3m(dBuV/m)		Over(dB)	
		PK	AV	PK	AV	PK	AV
11378.3	V	59.52	48.68	74	54	14.48	5.32
14756.7	V	63.86	48.99	74	54	10.14	5.01
18000	V	68.95	48.71	74	54	5.05	5.29
11483.4	H	59.59	49.66	74	54	14.41	4.34
14621.6	H	64.15	51.01	74	54	9.85	2.99
17954.9	H	67.81	48.16	74	54	6.19	5.84

- Note:**
- (1) All Readings are Peak Value (VBW=3MHz) and Peak Value (VBW=10Hz).
 - (2) Emission Level= Reading Level+Probe Factor +Cable Loss.
 - (3)The reading of emissions are attenuated more than 20dB below the permissible limits or the field strength is too small to be measured.
 - (4) R* is short for Restricted band, F* is short for Fundamental frequency.

■ Spurious Emission below 1GHz (30MHz to 1GHz)
902.75MHz

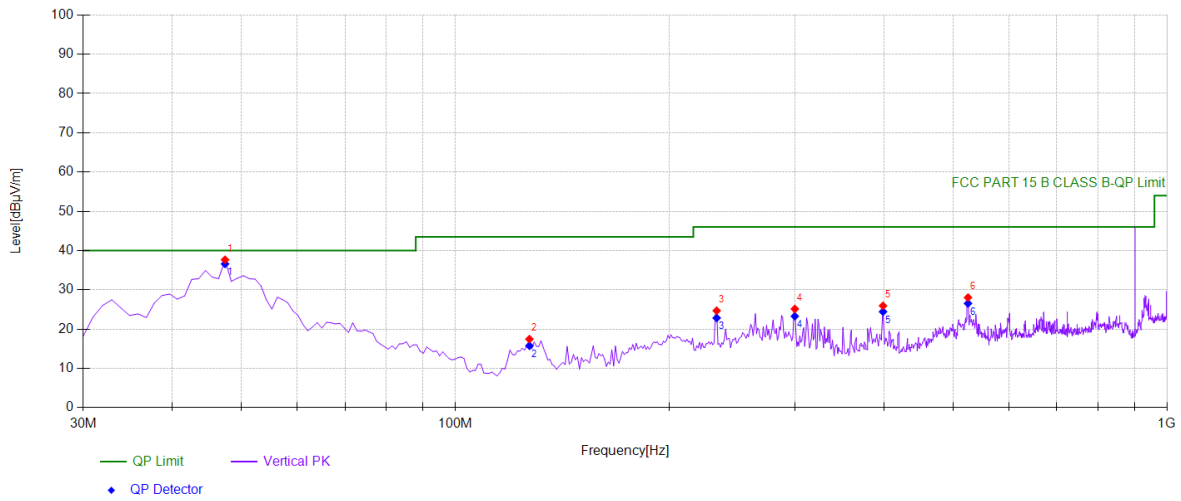

Suspected Data List								
NO.	Freq. [MHz]	Reading [dBµV]	Factor [dB/m]	Level [dBµV/m]	Detector	Limit [dBµV/m]	Margin [dB]	Polarity
1	47.4775	60.84	-23.17	37.67	PK	40.00	2.33	Vertical
2	127.097	41.91	-24.45	17.46	PK	43.50	26.04	Vertical
3	232.932	46.36	-21.66	24.70	PK	46.00	21.30	Vertical
4	299.929	45.08	-19.94	25.14	PK	46.00	20.86	Vertical
5	398.969	43.39	-17.45	25.94	PK	46.00	20.06	Vertical
6	525.195	43.23	-15.18	28.05	PK	46.00	17.95	Vertical

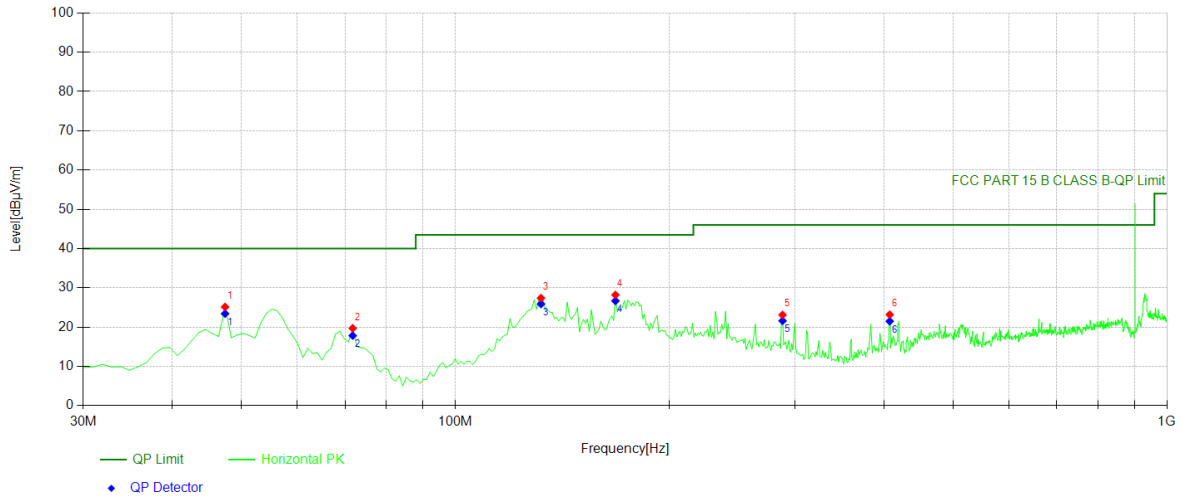

Suspected Data List								
NO.	Freq. [MHz]	Reading [dBµV]	Factor [dB/m]	Level [dBµV/m]	Detector	Limit [dBµV/m]	Margin [dB]	Polarity
1	47.4775	48.31	-23.17	25.14	PK	40.00	14.86	Horizontal
2	71.7518	45.90	-26.19	19.71	PK	40.00	20.29	Horizontal
3	131.952	52.33	-24.93	27.40	PK	43.50	16.10	Horizontal
4	167.877	53.23	-25.03	28.20	PK	43.50	15.30	Horizontal
5	288.278	43.09	-19.97	23.12	PK	46.00	22.88	Horizontal
6	407.707	40.59	-17.41	23.18	PK	46.00	22.82	Horizontal

915.25MHz

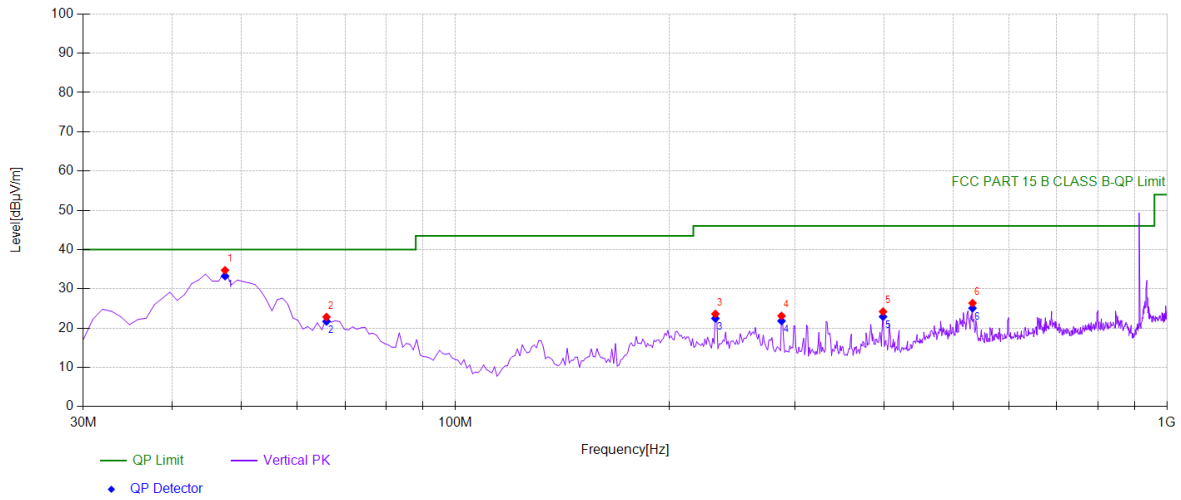

Suspected Data List								
NO.	Freq. [MHz]	Reading [dBµV]	Factor [dB/m]	Level [dBµV/m]	Detector	Limit [dBµV/m]	Margin [dB]	Polarity
1	47.4775	57.91	-23.17	34.74	PK	40.00	5.26	Vertical
2	65.9259	48.18	-25.34	22.84	PK	40.00	17.16	Vertical
3	231.962	45.37	-21.75	23.62	PK	46.00	22.38	Vertical
4	287.307	43.08	-19.96	23.12	PK	46.00	22.88	Vertical
5	398.969	41.66	-17.45	24.21	PK	46.00	21.79	Vertical
6	532.963	41.38	-15.00	26.38	PK	46.00	19.62	Vertical

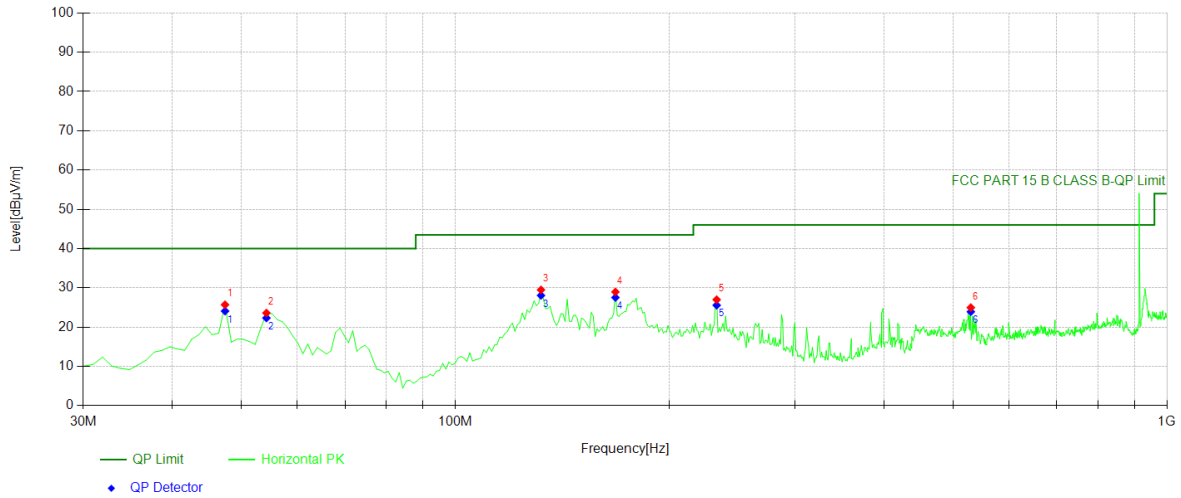

Suspected Data List								
NO.	Freq. [MHz]	Reading [dBµV]	Factor [dB/m]	Level [dBµV/m]	Detector	Limit [dBµV/m]	Margin [dB]	Polarity
1	47.4775	48.88	-23.17	25.71	PK	40.00	14.29	Horizontal
2	54.2743	47.22	-23.62	23.60	PK	40.00	16.40	Horizontal
3	131.952	54.43	-24.93	29.50	PK	43.50	14.00	Horizontal
4	167.877	54.00	-25.03	28.97	PK	43.50	14.53	Horizontal
5	232.932	48.66	-21.66	27.00	PK	46.00	19.00	Horizontal
6	530.050	40.05	-15.06	24.99	PK	46.00	21.01	Horizontal

927.25MHz

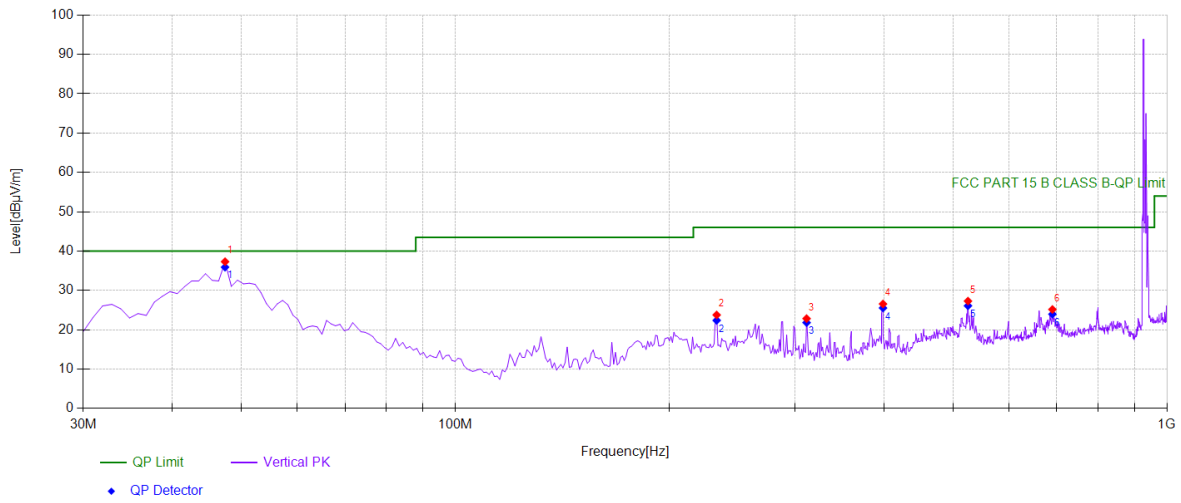

Suspected Data List								
NO.	Freq. [MHz]	Reading [dBµV]	Factor [dB/m]	Level [dBµV/m]	Detector	Limit [dBµV/m]	Margin [dB]	Polarity
1	47.4775	60.48	-23.17	37.31	PK	40.00	2.69	Vertical
2	232.932	45.44	-21.66	23.78	PK	46.00	22.22	Vertical
3	311.581	42.74	-19.89	22.85	PK	46.00	23.15	Vertical
4	398.969	44.02	-17.45	26.57	PK	46.00	19.43	Vertical
5	525.195	42.48	-15.18	27.30	PK	46.00	18.70	Vertical
6	690.260	36.56	-11.39	25.17	PK	46.00	20.83	Vertical

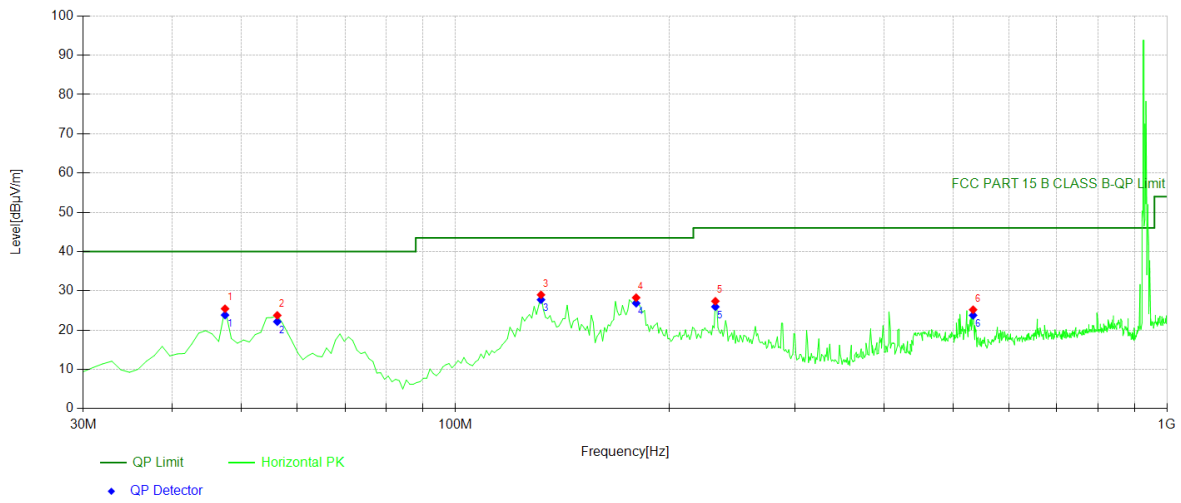

Suspected Data List								
NO.	Freq. [MHz]	Reading [dBμV]	Factor [dB/m]	Level [dBμV/m]	Detector	Limit [dBμV/m]	Margin [dB]	Polarity
1	47.4775	48.62	-23.17	25.45	PK	40.00	14.55	Horizontal
2	56.2162	47.67	-23.91	23.76	PK	40.00	16.24	Horizontal
3	131.952	53.92	-24.93	28.99	PK	43.50	14.51	Horizontal
4	179.529	52.50	-24.23	28.27	PK	43.50	15.23	Horizontal
5	231.962	49.12	-21.75	27.37	PK	46.00	18.63	Horizontal
6	533.933	40.17	-14.97	25.20	PK	46.00	20.80	Horizontal

8.8 CONDUCTED EMISSION TEST

8.8.1 Applicable Standard

According to FCC Part 15.207(a)

8.8.2 Conformance Limit

Conducted Emission Limit		
Frequency(MHz)	Quasi-peak	Average
0.15-0.5	66-56	56-46
0.5-5.0	56	46
5.0-30.0	60	50

Note: 1. The lower limit shall apply at the transition frequencies
 2. The limit decreases in line with the logarithm of the frequency in the range of 0.15 to 0.50MHz.

8.8.3 Test Configuration

Test according to clause 7.3 conducted emission test setup

8.8.4 Test Procedure

The EUT was placed on a table which is 0.8m above ground plane. Maximum procedure was performed on the highest emissions to ensure EUT compliance. Repeat above procedures until all frequency measured were complete.

8.8.5 Test Results

PASS.

Please refer to the following pages.

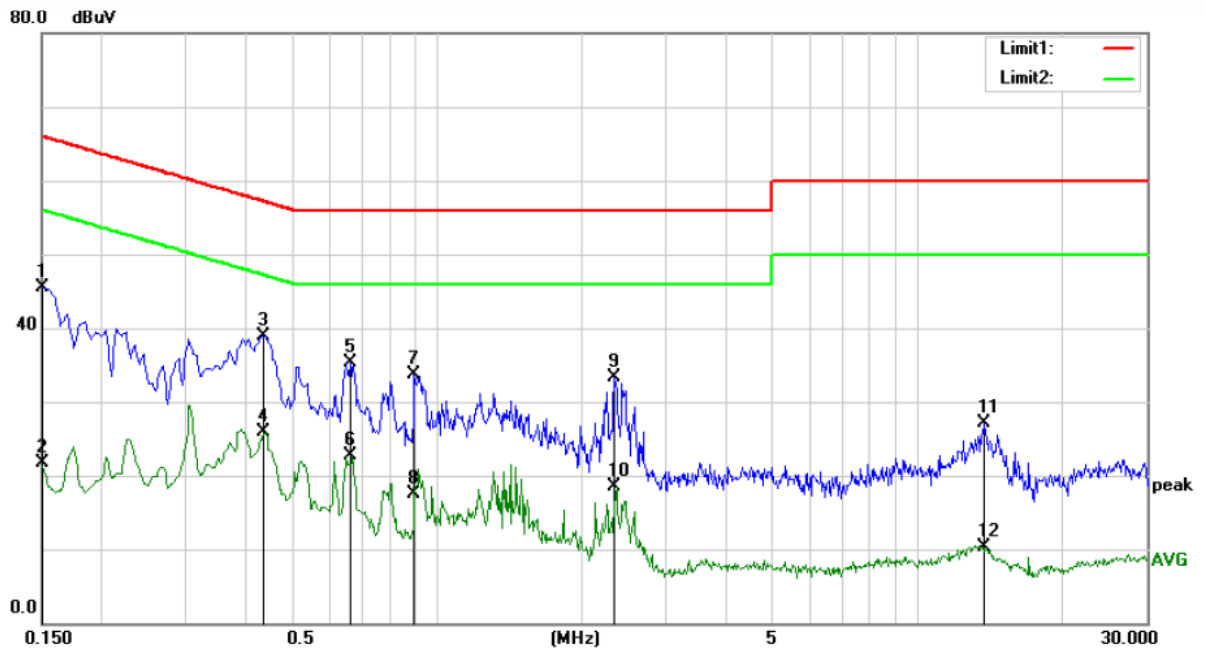

Site Conduction #1

Phase: **N**

Temperature: 21.9

Limit: (CE)FCC PART 15 class B_QP

Power: AC 120V/60Hz

Humidity: 58 %

Mode: RFID Mode

Note:

No.	Mk.	Freq.	Reading Level	Correct Factor	Measurement	Limit	Over	Detector	Comment
		MHz	dBuV	dB	dBuV	dBuV	dB		
1		0.1500	36.00	9.53	45.53	66.00	-20.47	QP	
2		0.1500	12.26	9.53	21.79	56.00	-34.21	AVG	
3	*	0.4350	29.40	9.54	38.94	57.16	-18.22	QP	
4		0.4350	16.34	9.54	25.88	47.16	-21.28	AVG	
5		0.6600	25.68	9.54	35.22	56.00	-20.78	QP	
6		0.6600	13.14	9.54	22.68	46.00	-23.32	AVG	
7		0.8950	24.07	9.55	33.62	56.00	-22.38	QP	
8		0.8950	7.96	9.55	17.51	46.00	-28.49	AVG	
9		2.3450	23.76	9.55	33.31	56.00	-22.69	QP	
10		2.3450	8.96	9.55	18.51	46.00	-27.49	AVG	
11		13.7800	17.34	9.80	27.14	60.00	-32.86	QP	
12		13.7800	0.52	9.80	10.32	50.00	-39.68	AVG	

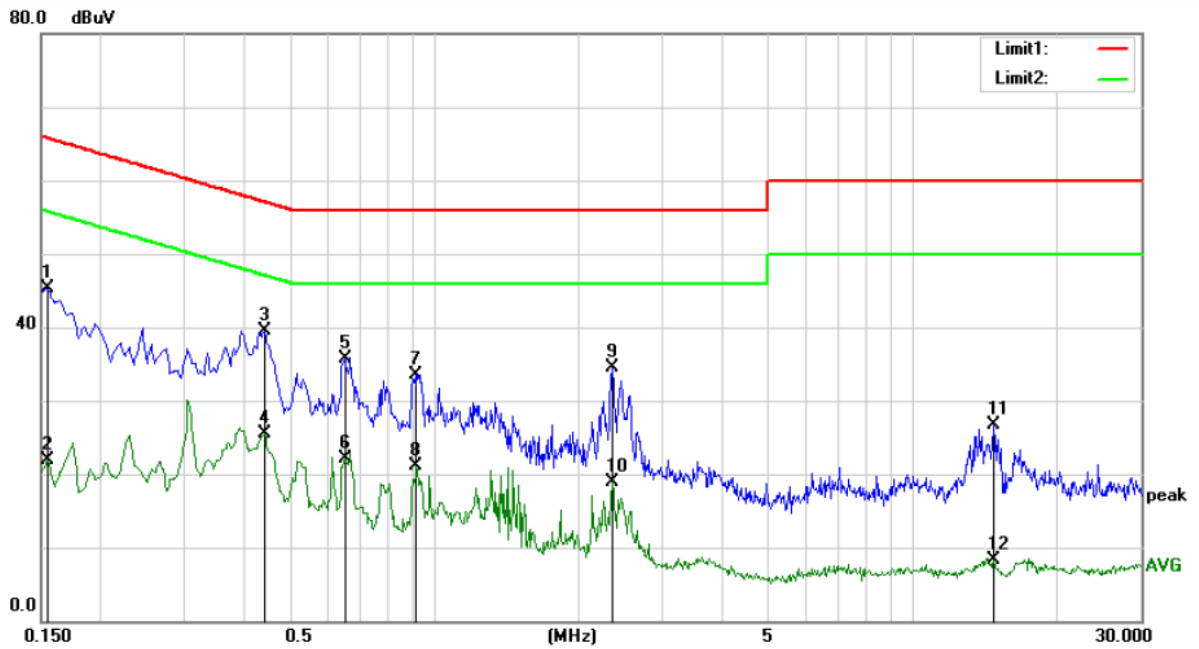

Site Conduction #1

Phase: **L1**

Temperature: 21.9

Limit: (CE)FCC PART 15 class B_QP

Power: AC 120V/60Hz

Humidity: 58 %

Mode: RFID Mode

Note:

No.	Mk.	Freq.	Reading Level	Correct Factor	Measurement	Limit	Over	Detector	Comment
		MHz	dBuV	dB	dBuV	dBuV	dB		
1		0.1550	35.73	9.53	45.26	65.73	-20.47	QP	
2		0.1550	12.31	9.53	21.84	55.73	-33.89	AVG	
3	*	0.4400	29.89	9.54	39.43	57.06	-17.63	QP	
4		0.4400	16.00	9.54	25.54	47.06	-21.52	AVG	
5		0.6500	26.20	9.54	35.74	56.00	-20.26	QP	
6		0.6500	12.55	9.54	22.09	46.00	-23.91	AVG	
7		0.9100	24.02	9.55	33.57	56.00	-22.43	QP	
8		0.9100	11.46	9.55	21.01	46.00	-24.99	AVG	
9		2.3500	24.86	9.55	34.41	56.00	-21.59	QP	
10		2.3500	9.32	9.55	18.87	46.00	-27.13	AVG	
11		14.8050	16.81	9.82	26.63	60.00	-33.37	QP	
12		14.8050	-1.55	9.82	8.27	50.00	-41.73	AVG	

8.9 ANTENNA APPLICATION

8.9.1 Antenna Requirement

Standard	Requirement
FCC CRF Part 15.203	An intentional radiator shall be designed to ensure that no antenna other than that furnished by the responsible party shall be used with the device. The use of a permanently attached antenna or of an antenna that uses a unique coupling to the intentional radiator shall be considered sufficient to comply with the provisions of this section. The manufacturer may design the unit so that a broken antenna can be replaced by the user, but the use of a standard antenna jack or electrical connector is prohibited. This requirement does not apply to carrier current devices or to devices operated under the provisions of §15.211, §15.213, §15.217, §15.219, or §15.221. Further, this requirement does not apply to intentional radiators that must be professionally installed, such as perimeter protection systems and some field disturbance sensors, or to other intentional radiators which, in accordance with §15.31(d), must be measured at the installation site. However, the installer shall be responsible for ensuring that the proper antenna is employed so that the limits in this part are not exceeded.

For intentional device, according to FCC 47 CFR Section 15.203, an intentional radiator shall be designed to ensure that no antenna other than that furnished by the responsible party shall be used with the device. And according to FCC 47 CFR Section 15.247 (b), if transmitting antennas of directional gain greater than 6dBi are used, the power shall be reduced by the amount in dB that the directional gain of the antenna exceeds 6dBi.

8.9.2 Result

PASS.

The EUT antenna is External Antenna, the antenna gain is 8 dBi.

- Note:
- Use of permanent, industrial epoxy, “Loctite” or solder to make the connection permanent prior to shipping.
 - Allow use of standard connector if the transmitter has a sensing circuitry that disables the transmitter if an unauthorized antenna is used. An application should detail how this is accomplished.
Use of a standard connect is also allowed if the connectors is within the transmitter enclosure and can only be accessed by disassembly of the transmitter, where such disassembly is not normally required. The user manual must not show that user has access to the connector.
 - BIOS lock-Radio card and host (e.g., laptop computer) exchange code to ensure only the authorized transmission system works in the host.

which in accordance to section 15.203, please refer to the EUT photos.

Detail of factor for radiated emission

Frequency(MHz)	Ant_F(dB)	Cab_L(dB)	Preamp(dB)	Correct Factor(dB)
0.009	20.6	0.03	\	20.63
0.15	20.7	0.1	\	20.8
1	20.9	0.15	\	21.05
10	20.1	0.28	\	20.38
30	18.8	0.45	\	19.25
30	11.7	0.62	27.9	-15.58
100	12.5	1.02	27.8	-14.28
300	12.9	1.91	27.5	-12.69
600	19.2	2.92	27	-4.88
800	21.1	3.54	26.6	-1.96
1000	22.3	4.17	26.2	0.27
1000	25.6	1.76	41.4	-14.04
3000	28.9	3.27	43.2	-11.03
5000	31.1	4.2	44.6	-9.3
8000	36.2	5.95	44.7	-2.55
10000	38.4	6.3	43.9	0.8
12000	38.5	7.14	42.3	3.34
15000	40.2	8.15	41.4	6.95
18000	45.4	9.02	41.3	13.12
18000	37.9	1.81	47.9	-8.19
21000	37.9	1.95	48.7	-8.85
25000	39.3	2.01	42.8	-1.49
28000	39.6	2.16	46.0	-4.24
31000	41.2	2.24	44.5	-1.06
34000	41.5	2.29	46.6	-2.81
37000	43.8	2.30	46.4	-0.3
40000	43.2	2.50	42.2	3.5

----- End of Report -----