

Test Report

FCC ID:2ANB8-T1

Date of issue: Jun. 26, 2017

Report Number:	MTi170811E068
Sample Description:	getwell Aerobic capacity assessment and muscle oxygen monitoring equipment
Model(s):	T1, T1 Pro, M1
Applicant:	Getwell Health Technology (Wuhu) Co., Ltd.
Address:	4th Building, Service outsourcing park, new and high-tech zone, Yijiang District, Wuhu, Anhui
Date of Test:	Jun. 10, 2017 to Jun. 26, 2017

Shenzhen Microtest Co., Ltd.
<http://www.mtitest.com>



This test report is valid for the tested samples only. It cannot be reproduced except in full without prior written consent of Shenzhen Microtest Co., Ltd.

Tel: (86-755) 88850135

Fax: (86-755) 88850136

Web: <http://www.mtitest.com>

E-mail: mti@51mti.com

Address: No.102A & 302A, East Block, Hengfang Industrial Park, Xingye Road, Xixiang, Bao'an District, Shenzhen, Guangdong, China

TEST RESULT CERTIFICATION	
Applicant's name	Getwell Health Technology (Wuhu) Co., Ltd.
Address	4th Building, Service outsourcing park, new and high-tech zone, Yijiang District, Wuhu, Anhui
Manufacture's Name	Getwell Health Technology (Wuhu) Co., Ltd.
Address	4th Building, Service outsourcing park, new and high-tech zone, Yijiang District, Wuhu, Anhui
Product name	getwell Aerobic capacity assessment and muscle oxygen monitoring equipment
Model and/or type reference :	T1
Serial Model	T1 Pro, M1
Standards	FCC Part15.247
Test procedure	ANSI C63.4-2014 ;ANSI C63.10-2013

This device described above has been tested by Shenzhen Toby Technology Co., Ltd. and the test results show that the equipment under test (EUT) is in compliance with the FCC requirements. And it is applicable only to the tested sample identified in the report.

Tested by:

Amy Lu

Amy Lu

Jun. 26, 2017

Reviewed by:

Smith Chen

Smith Chen

Jun. 26, 2017

Approved by:

Tom Xue

Tom Xue

Jun. 26, 2017

Table of Contents	Page
1 . SUMMARY OF TEST RESULTS	5
1.1 TEST FACILITY	6
1.2 MEASUREMENT UNCERTAINTY	6
2 . GENERAL INFORMATION	7
2.1 GENERAL DESCRIPTION OF EUT	7
2.2 DESCRIPTION OF TEST MODES	9
2.3 BLOCK DIGRAM SHOWING THE CONFIGURATION OF SYSTEM TESTED	10
2.4 DESCRIPTION OF SUPPORT UNITS(CONDUCTED MODE)	11
2.5 EQUIPMENTS LIST FOR ALL TEST ITEMS	12
3 . EMC EMISSION TEST	13
3.1 CONDUCTED EMISSION MEASUREMENT	13
3.1.1 POWER LINE CONDUCTED EMISSION LIMITS	13
3.1.2 TEST PROCEDURE	14
3.1.3 DEVIATION FROM TEST STANDARD	14
3.1.4 TEST SETUP	14
3.1.5 EUT OPERATING CONDITIONS	14
3.1.6 TEST RESULTS	15
3.2 RADIATED EMISSION MEASUREMENT	17
3.2.1 RADIATED EMISSION LIMITS	17
3.2.2 TEST PROCEDURE	17
3.2.3 DEVIATION FROM TEST STANDARD	18
3.2.4 TEST SETUP	19
3.2.5 EUT OPERATING CONDITIONS	20
3.2.6 TEST RESULTS (BETWEEN 9KHZ – 30 MHZ)	21
3.2.7 TEST RESULTS (BETWEEN 30MHZ – 1GHZ)	22
3.2.8 TEST RESULTS (1G-25GHZ)	23
4 . 20 DB OCCUPY BANDWIDTH	28
4.1 APPLIED PROCEDURES / LIMIT	28
4.1.1 TEST PROCEDURE	28
4.1.2 DEVIATION FROM STANDARD	28
4.1.3 TEST SETUP	28
4.1.4 EUT OPERATION CONDITIONS	28
4.1.5 TEST RESULTS	29
5 . CARRIER FREQUENCY SEPARATION TEST	35
5.1 APPLIED PROCEDURES / LIMIT	35

Table of Contents	Page
5.1.1 TEST PROCEDURE	35
5.1.2 DEVIATION FROM STANDARD	35
5.1.3 TEST SETUP	35
5.1.4 EUT OPERATION CONDITIONS	35
5.1.5 TEST RESULTS	36
6 . NUMBER OF HOPPING CHANNEL	38
6.1 APPLIED PROCEDURES / LIMIT	38
6.1.1 TEST PROCEDURE	38
6.1.2 DEVIATION FROM STANDARD	38
6.1.3 TEST SETUP	38
6.1.4 EUT OPERATION CONDITIONS	38
6.1.5 TEST RESULTS	38
7 . DWELL TIME	41
7.1 APPLIED PROCEDURES / LIMIT	41
7.1.1 TEST PROCEDURE	41
7.1.1.1 DEVIATION FROM STANDARD	41
7.1.1.2 TEST SETUP	41
7.1.1.3 EUT OPERATION CONDITIONS	41
7.1.1.4 TEST RESULTS	41
8 . PEAK OUTPUT POWER TEST	49
8.1 APPLIED PROCEDURES / LIMIT	49
8.1.1 TEST PROCEDURE	49
8.1.2 DEVIATION FROM STANDARD	49
8.1.3 TEST SETUP	49
8.1.4 EUT OPERATION CONDITIONS	49
8.1.5 TEST RESULTS	50
9 . 100 KHZ BANDWIDTH OF FREQUENCY BAND EDGE	51
9.1 DEVIATION FROM STANDARD	51
9.2 TEST SETUP	51
9.3 EUT OPERATION CONDITIONS	51
9.4 TEST RESULTS	52
10 . ANTENNA REQUIREMENT	60
10.1 STANDARD REQUIREMENT	60
10.2 EUT ANTENNA	60

1. SUMMARY OF TEST RESULTS

Test procedures according to the technical standards:

FCC Part15 (15.247) , Subpart C			
Standard Section	Test Item	Judgment	Remark
15.203/15.247(c)	Antenna Requirement	PASSED	
15.207	Conducted Emission	PASSED	
15.247(b)(1)	Conducted Peak Output Power	PASSED	
15.247(a)(1)	20dB Occupied Bandwidth	PASSED	
15.247(a)(1)	Carrier Frequencies Separation	PASSED	
15.247(a)(1)	Hopping Channel Number	PASSED	
15.247(a)(1)	Dwell Time	PASSED	
15.205/15.209	Spurious Emission	PASSED	
15.247(d)	Band Edge	PASSED	

NOTE:

(1) "N/A" denotes test is not applicable in this Test Report

1.1 TEST FACILITY

Shenzhen Toby Technology Co., Ltd.
Add.: 10/F.,A Block, Jiada R&D Bldg., No.5 Songpingshan, Road, Science&Technology Park,
Shenzhen, 518057
FCC Registration No.:811562

1.2 MEASUREMENT UNCERTAINTY

The reported uncertainty of measurement $y \pm U$, where expanded uncertainty U is based on a standard uncertainty multiplied by a coverage factor of $k=2$, providing a level of confidence of approximately **95** %.

No.	Item	Uncertainty
1	Conducted Emission Test	$\pm 1.38\text{dB}$
2	RF power, conducted	$\pm 0.16\text{dB}$
3	Spurious emissions, conducted	$\pm 0.21\text{dB}$
4	All emissions, radiated (<1G)	$\pm 4.68\text{dB}$
5	All emissions, radiated (>1G)	$\pm 4.89\text{dB}$
6	Temperature	$\pm 0.5^\circ\text{C}$
7	Humidity	$\pm 2\%$

2. GENERAL INFORMATION

2.1 GENERAL DESCRIPTION OF EUT

Equipment	getwell Aerobic capacity assessment and muscle oxygen monitoring equipment	
Trade Name		
Model Name	T1	
Serial Model	T1 Pro , M1	
Model Difference	Packing accessory, color and pattern are difference	
Product Description	The EUT is a Getwell Aerobic capacity assessment and muscle oxygen monitoring equipment	
	Operation Frequency:	2402-2480MHz
	Modulation Type:	GFSK, $\pi/4$ -DQPSK, 8-DPSK
	Bit Rate of Transmitter	1,2,3Mbps
	Number Of Channel	79CH
	Antenna Designation:	Please see Note 3.
	Output Power(Conducted):	1.95dBm
	Antenna Gain (dBi)	2dBi
	Based on the application, features, or specification exhibited in User's Manual, the EUT is considered as an ITE/Computing Device. More details of EUT technical specification, please refer to the User's Manual.	
Channel List	Please refer to the Note 2.	
Power source:	DC 5V from adapter	
Adapter information:	Model:SK12G-0500100U Input:AC100-240V 50/60Hz 0.2A Max Output:DC 5V 1A	
Battery	DC 3.7V by battery	
Connecting I/O Port(s)	Please refer to the User's Manual	

Note:

- For a more detailed features description, please refer to the manufacturer's specifications or the User's Manual.
- Channel List

Channel	Frequency (MHz)	Channel	Frequency (MHz)	Channel	Frequency (MHz)
00	2402	27	2429	54	2456
01	2403	28	2430	55	2457
02	2404	29	2431	56	2458
03	2405	30	2432	57	2459
04	2406	31	2433	58	2460
05	2407	32	2434	59	2461
06	2408	33	2435	60	2462
07	2409	34	2436	61	2463

08	2410	35	2437	62	2464
09	2411	36	2438	63	2465
10	2412	37	2439	64	2466
11	2413	38	2440	65	2467
12	2414	39	2441	66	2468
13	2415	40	2442	67	2469
14	2416	41	2443	68	2470
15	2417	42	2444	69	2471
16	2418	43	2445	70	2472
17	2419	44	2446	71	2473
18	2420	45	2447	72	2474
19	2421	46	2448	73	2475
20	2422	47	2449	74	2476
21	2423	48	2450	75	2477
22	2424	49	2451	76	2478
23	2425	50	2452	77	2479
24	2426	51	2453	78	2480
25	2427	52	2454		
26	2428	53	2455		
Remark: Channel 0, 39 & 78 selected for GFSK, $\pi/4$ -DQPSK and 8DPSK.					

3. Table for Filed Antenna

Ant	Brand	Model Name	Antenna Type	Connector	Gain (dBi)	NOTE
A	N/A	N/A	External antenna	/	2	BT Antenna

2.2 DESCRIPTION OF TEST MODES

To investigate the maximum EMI emission characteristics generates from EUT, the test system was pre-scanning tested base on the consideration of following EUT operation mode or test configuration mode which possible have effect on EMI emission level. Each of these EUT operation mode(s) or test configuration mode(s) mentioned above was evaluated respectively.

Pretest Mode	Description
Mode 1	GFSK CH1/CH40/CH79
Mode 2	$\pi/4$ -DQPSK CH1/CH40/CH79
Mode 3	8-DPSK CH1/CH40/CH79
Mode 4	TX Mode

For Conducted Emission	
Final Test Mode	Description
Mode 4	TX Mode

For Radiated Emission	
Final Test Mode	Description
Mode 1	GFSK CH1/CH40/CH79
Mode 2	$\pi/4$ -DQPSK CH1/CH40/CH79
Mode 3	8-DPSK CH1/CH40/CH79

Note:

- (1) The measurements are performed at the highest, middle, lowest available channels.
- (2) The measurements are performed at all Bit Rate of Transmitter, the worst data was reported

2.3 BLOCK DIGRAM SHOWING THE CONFIGURATION OF SYSTEM TESTED

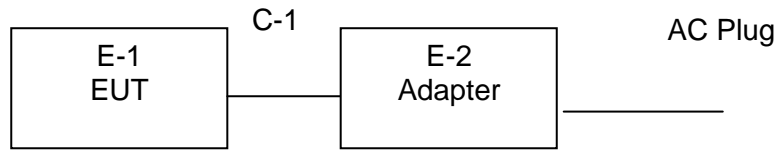

2.4 DESCRIPTION OF SUPPORT UNITS(CONDUCTED MODE)

The EUT has been tested as an independent unit together with other necessary accessories or support units. The following support units or accessories were used to form a representative test configuration during the tests.

Item	Equipment	Brand	Model/Type No.	Series No.	Note
E-1	getwell Aerobic capacity assessment and muscle oxygen monitoring equipment		T1	N/A	EUT
E-2	/	/	/	/	

Item	Shielded Type	Ferrite Core	Length	Note
C-1	NO	NO	1.0m	
C-2	NO	NO	0.8m	

Note:

- (1) The support equipment was authorized by Declaration of Confirmation.
- (2) For detachable type I/O cable should be specified the length in cm in 『Length』 column.

2.5 EQUIPMENTS LIST FOR ALL TEST ITEMS

For RF conducted test:

Equipment	Manufacturer	Model	Serial No.	Calibration Due
Universal Radio Communication Tester	Rohde&schwarz	CMU200	114587	2017/11/4
Spectrum analyzer	Agilent	E4407B	MY41441082	2017/11/4
Dc Power Supply	GW	GPR-6030D	/	2017/11/4
Temperature & Humidity Chamber	GIANT FORCE	GTH-056P	GF-94454-1	2017/11/14
Broadband TRILOG Antenna	Schwarabeck	VULB9163	9163-872	2017/11/14
Horn Antenna	Schwarzbeck	BBHA 9120 D	9120D-1145	2017/11/14
Amplifier	HP	8447D	3113A06150	2017/11/4
Amplifier	Agilent	8449B	3008A02400	2017/7/4
Test Receiver	Schwarabeck	ESPI7	100314	2017/11/4
Spectrum analyzer	Agilent	E4407B	MY41441082	2017/11/4
Signal Generator	R&S	SMT 06	832080/007	2017/11/4
Broadband TRILOG Antenna	Schwarabeck	VULB9163	9163-872	2017/11/14
Horn Antenna	Schwarzbeck	BBHA 9120 D	9120D-1145	2017/11/14
Amplifier	HP	8447D	3113A06150	2017/11/4
Amplifier	Agilent	8449B	3008A02400	2017/7/4
Test Receiver	Schwarabeck	ESPI	100314	2017/11/4
Spectrum analyzer	Agilent	E4407B	MY41441082	2017/11/4
LISN	R&S	ENV216	1001131	2017/9/25
Test Cable	United Microwave	57793	1m	2017/12/05
Test Cable	United Microwave	A30A30-5006	10m	2017/12/05

Note: the calibration interval of the above test instruments is 12 months and the calibrations are traceable to international system unit (SI).

3. EMC EMISSION TEST

3.1 CONDUCTED EMISSION MEASUREMENT

3.1.1 POWER LINE CONDUCTED EMISSION Limits (Frequency Range 150KHz-30MHz)

FREQUENCY (MHz)	Class A (dBuV)		Class B (dBuV)		Standard
	Quasi-peak	Average	Quasi-peak	Average	
0.15 -0.5	79.00	66.00	66 - 56 *	56 - 46 *	CISPR
0.50 -5.0	73.00	60.00	56.00	46.00	CISPR
5.0 -30.0	73.00	60.00	60.00	50.00	CISPR

0.15 -0.5	79.00	66.00	66 - 56 *	56 - 46 *	FCC
0.50 -5.0	73.00	60.00	56.00	46.00	FCC
5.0 -30.0	73.00	60.00	60.00	50.00	FCC

Note:

- (1) The tighter limit applies at the band edges.
- (2) The limit of " * " marked band means the limitation decreases linearly with the logarithm of the frequency in the range.

The following table is the setting of the receiver

Receiver Parameters	Setting
Attenuation	10 dB
Start Frequency	0.15 MHz
Stop Frequency	30 MHz
IF Bandwidth	9 kHz

3.1.2 TEST PROCEDURE

- a. The EUT was placed 0.8 meters from the horizontal ground plane with EUT being connected to the power mains through a line impedance stabilization network (LISN). All other support equipments powered from additional LISN(s). The LISN provide 50 Ohm/ 50uH of coupling impedance for the measuring instrument.
- b. Interconnecting cables that hang closer than 40 cm to the ground plane shall be folded back and forth in the center forming a bundle 30 to 40 cm long.
- c. I/O cables that are not connected to a peripheral shall be bundled in the center. The end of the cable may be terminated, if required, using the correct terminating impedance. The overall length shall not exceed 1 m.
- d. LISN at least 80 cm from nearest part of EUT chassis.
- e. For the actual test configuration, please refer to the related Item –EUT Test Photos.

3.1.3 DEVIATION FROM TEST STANDARD

No deviation

3.1.4 TEST SETUP

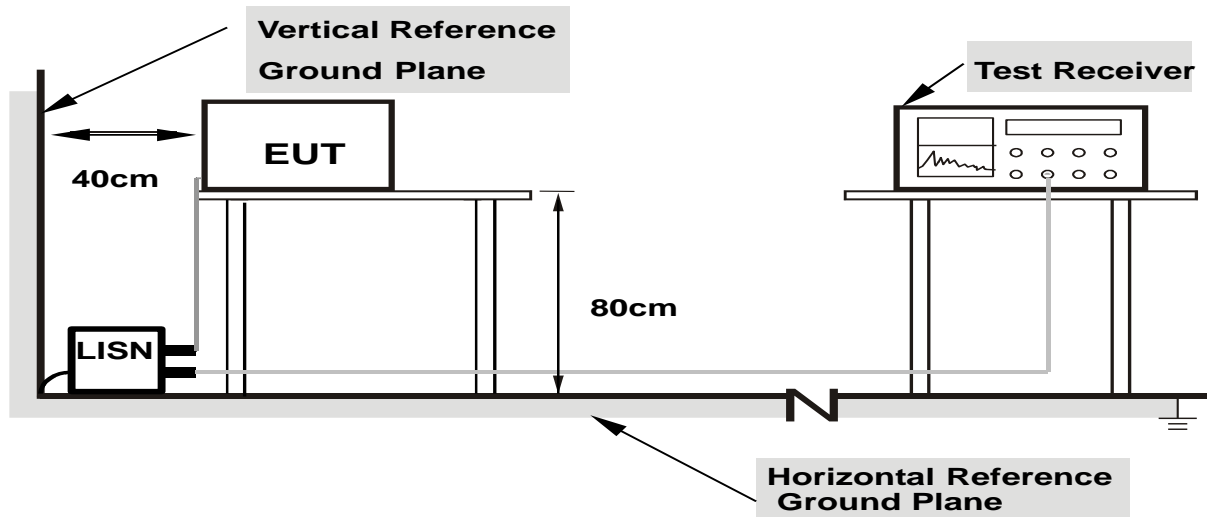

- Note: 1. Support units were connected to second LISN.**
2. Both of LISNs (AMN) are 80 cm from EUT and at least 80 from other units and other metal planes

3.1.5 EUT OPERATING CONDITIONS

The EUT was configured for testing in a typical fashion (as a customer would normally use it). The EUT has been programmed to continuously transmit during test. This operating condition was tested and used to collect the included data.

3.1.6 TEST RESULTS

Temperature :	26 °C	Relative Humidity :	54%
Pressure :	1010hPa	Phase :	L
Test Voltage :	DC 5Vfrom adapter AC 120V/60Hz	Test Mode :	Mode 4

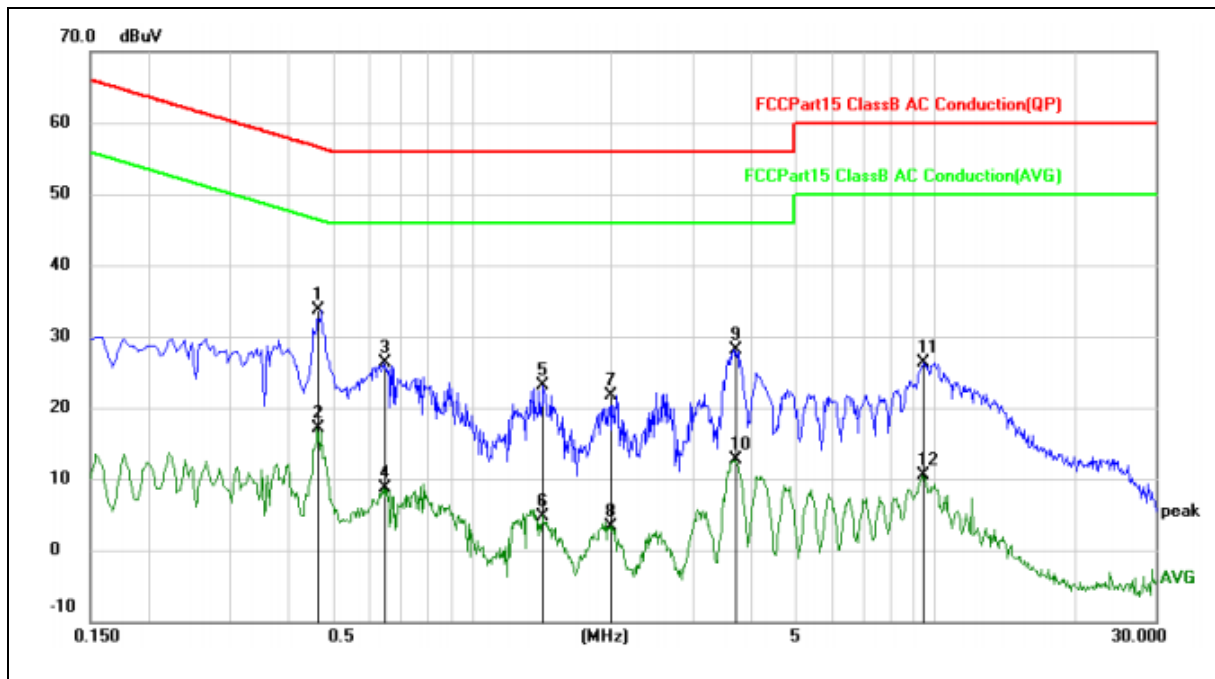

No.	Mk.	Freq. MHz	Reading Level dBuV	Correct Factor dB	Measure- ment dBuV	Limit dBuV	Over dB	Detector	Comment
1	*	0.4650	33.65	-0.03	33.62	56.60	-22.98	QP	
2		0.4650	17.04	-0.03	17.01	46.60	-29.59	AVG	
3		0.6450	26.42	-0.03	26.39	56.00	-29.61	QP	
4		0.6450	8.71	-0.03	8.68	46.00	-37.32	AVG	
5		1.4190	23.15	-0.04	23.11	56.00	-32.89	QP	
6		1.4190	4.84	-0.04	4.80	46.00	-41.20	AVG	
7		1.9860	21.84	-0.05	21.79	56.00	-34.21	QP	
8		1.9860	3.40	-0.05	3.35	46.00	-42.65	AVG	
9		3.7005	28.18	-0.05	28.13	56.00	-27.87	QP	
10		3.7005	12.69	-0.05	12.64	46.00	-33.36	AVG	
11		9.4379	26.46	-0.08	26.38	60.00	-33.62	QP	
12		9.4379	10.63	-0.08	10.55	50.00	-39.45	AVG	

EUT :	Portable High Resolution Music Player	Model Name. :	FX3321
Temperature :	26 °C	Relative Humidity :	54%
Pressure :	1010hPa	Phase :	N
Test Voltage :	DC 5Vfrom adapter AC 120V/60Hz	Test Mode :	Mode 4

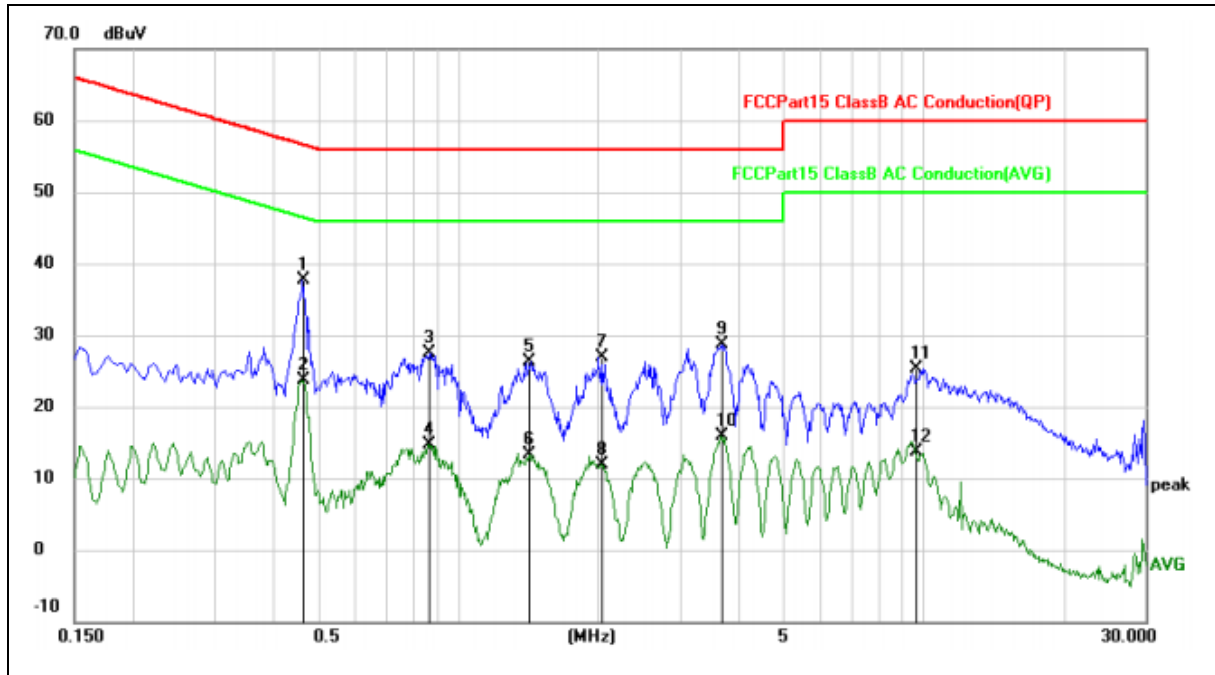

No.	Mk.	Freq. MHz	Reading Level dBuV	Correct Factor dB	Measure- ment dBuV	Limit dBuV	Over dB	Detector	Comment
1	*	0.4650	37.76	-0.03	37.73	56.60	-18.87	QP	
2		0.4650	23.71	-0.03	23.68	46.60	-22.92	AVG	
3		0.8655	27.45	-0.04	27.41	56.00	-28.59	QP	
4		0.8655	14.70	-0.04	14.66	46.00	-31.34	AVG	
5		1.4190	26.38	-0.04	26.34	56.00	-29.66	QP	
6		1.4190	13.32	-0.04	13.28	46.00	-32.72	AVG	
7		2.0310	26.96	-0.05	26.91	56.00	-29.09	QP	
8		2.0310	11.98	-0.05	11.93	46.00	-34.07	AVG	
9		3.6735	28.80	-0.05	28.75	56.00	-27.25	QP	
10		3.6735	15.92	-0.05	15.87	46.00	-30.13	AVG	
11		9.6045	25.44	-0.08	25.36	60.00	-34.64	QP	
12		9.6045	13.72	-0.08	13.64	50.00	-36.36	AVG	

3.2 RADIATED EMISSION MEASUREMENT

3.2.1 RADIATED EMISSION LIMITS (Frequency Range 9kHz-1000MHz)

20dBc in any 100 kHz bandwidth outside the operating frequency band. In case the emission fall within the restricted band specified on 15.205(a), then the 15.209(a) limit in the table below has to be followed.

Frequencies (MHz)	Field Strength (micровolts/meter)	Measurement Distance (meters)
0.009~0.490	2400/F(KHz)	300
0.490~1.705	24000/F(KHz)	30
1.705~30.0	30	30
30~88	100	3
88~216	150	3
216~960	200	3
Above 960	500	3

Spectrum Parameter	Setting
Attenuation	Auto
Start Frequency	1000 MHz
Stop Frequency	10th carrier harmonic
RB / VB (emission in restricted band)	1 MHz / 1 MHz for Peak, 1 MHz / 10Hz for Average

Receiver Parameter	Setting
Attenuation	Auto
Start ~ Stop Frequency	9kHz~150kHz / RB 200Hz for QP
Start ~ Stop Frequency	150kHz~30MHz / RB 9kHz for QP
Start ~ Stop Frequency	30MHz~1000MHz / RB 120kHz for QP

3.2.2 TEST PROCEDURE

- a. The measuring distance of at 3 m shall be used for measurements at frequency up to 1GHz. For frequencies above 1GHz, any suitable measuring distance may be used.
- b. The EUT was placed on the top of a rotating table 0.8 meters above the ground at a 3 meter open area test site. The table was rotated 360 degrees to determine the position of the highest radiation.
- c. The height of the equipment or of the substitution antenna shall be 0.8 m; the height of the test antenna shall vary between 1 m to 4 m. Both horizontal and vertical polarizations of the antenna are set to make the measurement.
- d. The initial step in collecting conducted emission data is a spectrum analyzer peak detector mode pre-scanning the measurement frequency range. Significant peaks are then marked and then Quasi Peak detector mode re-measured.
- e. If the Peak Mode measured value compliance with and lower than Quasi Peak Mode Limit, the EUT shall be deemed to meet QP Limits and then no additional QP Mode measurement performed.

f. For the actual test configuration, please refer to the related Item –EUT Test Photos.

Note:

Both horizontal and vertical antenna polarities were tested and performed pretest to three orthogonal axis. The worst case emissions were reported

3.2.3 DEVIATION FROM TEST STANDARD

No deviation

3.2.4 TEST SETUP

(A) Radiated Emission Test-Up Frequency Below 30MHz

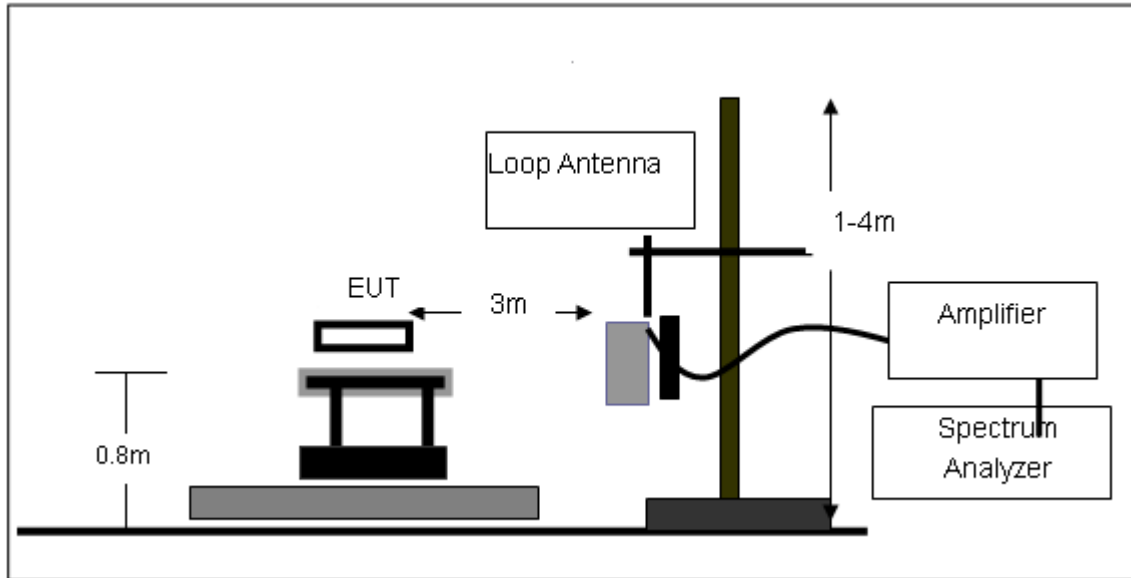

(B) Radiated Emission Test-Up Frequency 30MHz~1GHz

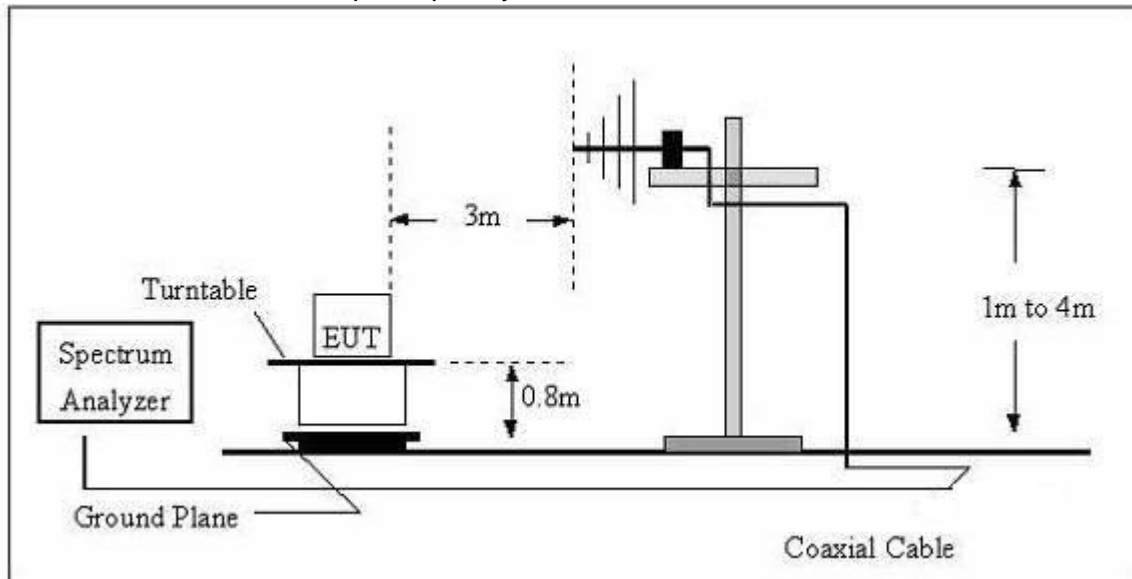

(C) Radiated Emission Test-Up Frequency Above 1GHz

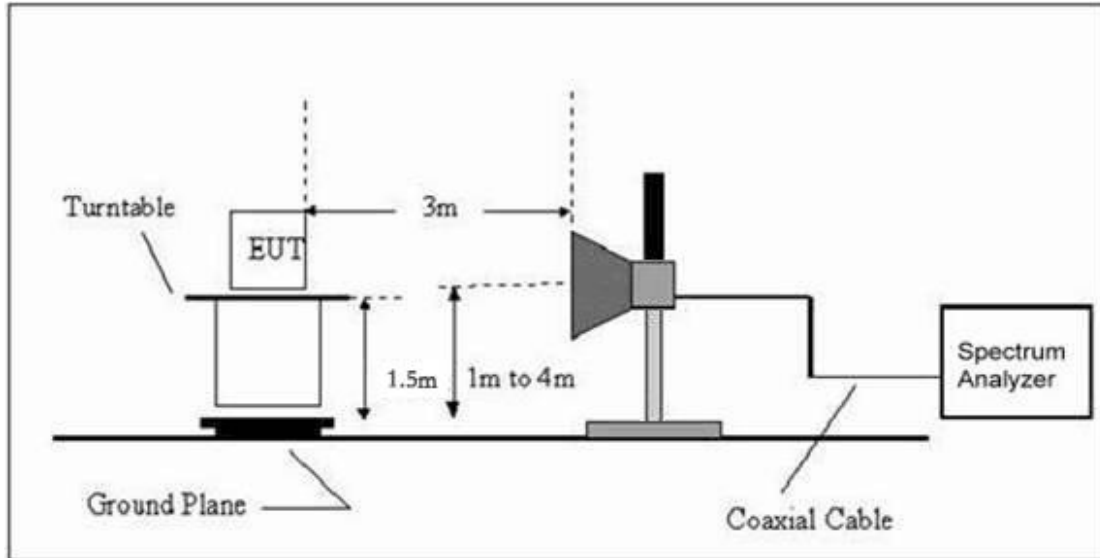

3.2.5 EUT OPERATING CONDITIONS

The EUT tested system was configured as the statements of 2.4 Unless otherwise a special operating condition is specified in the follows during the testing.

3.2.6 TEST RESULTS (BETWEEN 9KHZ – 30 MHZ)

EUT:	getwell Aerobic capacity assessment and muscle oxygen monitoring equipment	Model Name. :	T1
Temperature:	22°C	Relative Humidity:	55%
Pressure:	1010 hPa	Test Voltage :	DC 3.7V by battery
Test Mode :	TX	Polarization :	--

Freq.	Reading	Limit	Margin	State
(MHz)	(dBuV/m)	(dBuV/m)	(dB)	P/F
--	--	--	--	PASS
--	--	--	--	PASS

NOTE:

The amplitude of spurious emissions which are attenuated by more than 20dB below the permissible value has no need to be reported.

Distance extrapolation factor = $40 \log(\text{specific distance/test distance})(\text{dB})$;

Limit line = specific limits(dBuv) + distance extrapolation factor.

3.2.7 TEST RESULTS (BETWEEN 30MHZ – 1GHZ)

EUT :	getwell Aerobic capacity assessment and muscle oxygen monitoring equipment	Model Name :	T1
Temperature :	22°C	Relative Humidity:	55%
Pressure:	1010 hPa	Test Voltage :	DC 3.7V by battery
Test Mode :	TX		

Polar (H/V)	Frequency	Meter Reading	Factor	Emission Level	Limits	Margin	Detector Type
	(MHz)	(dBuV)	(dB)	(dBuV/m)	(dBuV/m)	(dB)	
V	34.1561	37.22	-15.32	21.90	40.00	-18.10	QP
V	52.3912	33.32	-13.02	20.30	40.00	-19.70	QP
V	80.0806	38.78	-18.48	20.30	40.00	-19.70	QP
V	98.4866	34.89	-14.69	20.20	43.50	-23.30	QP
V	357.9287	26.63	-9.43	17.20	46.00	-28.80	QP
V	833.3171	26.99	-2.29	24.70	46.00	-21.30	QP
H	49.7068	25.96	-12.66	13.30	40.00	-26.70	QP
H	101.2885	27.32	-14.42	12.90	43.50	-30.60	QP
H	230.9068	33.38	-12.68	20.70	46.00	-25.30	QP
H	360.4476	25.37	-9.37	16.00	46.00	-30.00	QP
H	499.4247	26.18	-7.08	19.10	46.00	-26.90	QP
H	755.3873	26.23	-3.43	22.80	46.00	-23.20	QP

Remark:
 Absolute Level= ReadingLevel+ Factor, Margin= Absolute Level- Limit
 Factor = Antenna Factor + Cable Loss – Pre-amplifier.
 Factor added by measurement software automatically

3.2.8 TEST RESULTS (1G-25GHZ)

GFSK
Normal

Polar (H/V)	Frequency	Meter Reading	Factor	Emission Level	Limits	Margin	Detector Type
	(MHz)	(dBuV)	(dB)	(dBuV/m)	(dBuV/m)	(dB)	
Low Channel (2402 MHz)							
Vertical	2491.777	59.75	-13.18	46.57	74	27.43	Pk
Horizontal	2498.247	56.65	-13.89	42.76	74	31.24	Pk
Vertical	4804.156	56.75	-3.94	52.81	74	21.19	Pk
Horizontal	4804.156	56.75	-10.55	46.20	74	27.8	Pk
Vertical	1485.838	60.45	-17.87	42.58	74	31.42	Pk
Vertical	1636.784	60.14	-14.85	45.29	74	28.71	Pk
Vertical	2095.928	58.95	-12.38	46.57	74	27.43	Pk
Horizontal	1074.301	60.68	-21.15	39.53	74	34.47	Pk
Horizontal	1483.178	59.67	-15.99	43.68	74	30.32	Pk
Horizontal	1895.832	56.69	-15.46	41.23	74	32.77	Pk
Mid Channel (2441 MHz)							
Vertical	2474.777	56.37	-10.41	45.96	74	28.04	Pk
Horizontal	2474.144	57.06	-10.54	46.52	74	27.48	Pk
Vertical	4882.539	56.44	-5.06	51.38	74	22.62	Pk
Horizontal	4882.539	56.44	-9.16	47.28	74	26.72	Pk
Vertical	1433.535	63.43	-18.29	45.14	74	28.86	Pk
Vertical	1636.784	60.76	-18.05	42.71	74	31.29	Pk
Vertical	2284.166	54.5	-14.23	40.27	74	33.73	Pk
Horizontal	1280.515	60.16	-18.93	41.23	74	32.77	Pk
Horizontal	1636.784	58.99	-17.48	41.51	74	32.49	Pk
Horizontal	1892.438	59.11	-15.46	43.65	74	30.35	Pk
High Channel (2480 MHz)							
Vertical	2453.883	57.03	-13.41	43.62	74	30.38	Pk
Horizontal	2453.839	57.03	-12.27	44.76	74	29.24	Pk
Vertical	4960.256	53.54	-9.68	43.86	74	30.14	Pk
Horizontal	4960.478	53.54	-5.02	48.52	74	25.48	Pk
Vertical	1187.688	58.06	-17.91	40.15	74	33.85	Pk
Vertical	1636.784	56.87	-17.27	39.60	74	34.4	Pk
Vertical	2084.693	54.46	-13.38	41.08	74	32.92	Pk
Horizontal	1534.540	57.12	-17.52	39.60	74	34.4	Pk
Horizontal	1786.985	56.83	-16.27	40.56	74	33.44	Pk
Horizontal	1892.438	56.71	-14.87	41.84	74	32.16	Pk

π/4-DQPSK

Normal Voltage

Polar (H/V)	Frequency	Meter Reading	Factor	Emission Level	Limits	Margin	Detector Type
	(MHz)	(dBuV)	(dB)	(dBuV/m)	(dBuV/m)	(dB)	
operation frequency:2402							
V	4804.428	53.58	-2.56	51.02	74	22.98	Pk
V	4804.428	31.08	-4.57	26.51	54	27.49	AV
H	4804.529	52.77	-4.72	48.05	74	25.95	Pk
H	4804.529	31.82	-3.87	27.95	54	26.05	AV
operation frequency:2441							
V	4882.548	52.17	-6.91	45.26	74	28.74	Pk
V	4882.548	31.24	-4.71	26.53	54	27.47	AV
H	4882.279	51.06	-5.45	45.61	74	28.39	Pk
H	4882.279	31.08	-5.1	25.98	54	28.02	AV
operation frequency:2480							
V	4960.358	52.56	-4.32	48.24	74	25.76	pk
V	4960.358	31.21	-4.54	26.67	54	27.33	AV
H	4960.591	51.64	-3.69	47.95	74	26.05	pk
H	4960.591	31.76	-4.68	27.08	54	26.92	AV
Remark:							
Absolute Level= Reading Level+ Factor, Margin= Absolute Level - Limit							

8-DPSK

Normal Voltage

Polar (H/V)	Frequency	Meter Reading	Factor	Emission Level	Limits	Detector Type
	(MHz)	(dBuV)	(dB)	(dBuV/m)	(dBuV/m)	
operation frequency:2402						
V	4804.428	54.55	-2.51	52.04	74	Pk
H	4804.529	55.26	-4	51.26	74	Pk
operation frequency:2441						
V	4882.548	54.53	-1.9	52.63	74	Pk
H	4882.279	55.45	-4.17	51.28	74	Pk
operation frequency:2480						
V	4960.358	50.37	-2.41	47.96	74	pk
H	4960.591	49.69	-3.16	46.53	74	pk
Remark:						
Absolute Level= Reading Level+ Factor, Margin= Absolute Level - Limit						

Note:The PK value is less than the AV value, AV value is not required
Factor added by measurement software automatically.

BAND EDGE(Radiated)

Frequency (MHz)	Meter Reading (dB μ V)	Factor (dB)	Emission Level (dB μ V/m)	Limits (dB μ V/m)	Margin (dB)	Detector Type	Comment
GFSK							
2390	56.83	-12.56	44.27	74	29.73	peak	Vertical
2390	57.37	-13.69	43.68	74	30.32	peak	Horizontal
2483.5	56.6	-13.36	43.24	74	30.76	peak	Vertical
2483.5	57.47	-13.24	44.23	74	29.77	peak	Horizontal
$\pi/4$-DQPSK							
2390	57.61	-13.76	43.85	74	30.15	peak	Vertical
2390	57.8	-14.42	43.38	74	30.62	peak	Horizontal
2483.5	57.99	-12.3	45.69	74	28.31	peak	Vertical
2483.5	57.1	-11.36	45.74	74	28.26	peak	Horizontal
8-DPSK							
2390	58.04	-12.66	45.38	74	28.62	peak	Vertical
2390	58.5	-14.27	44.23	74	29.77	peak	Horizontal
2483.5	57.72	-12.08	45.64	74	28.36	peak	Vertical
2483.5	56.08	-11.23	44.85	74	29.15	peak	Horizontal

NOTE: The PK value is less than the AV value, AV value is not required.

BAND EDGE(Radiated)(Hopping Mode)

Frequency (MHz)	Meter Reading (dBμV)	Factor (dB)	Emission Level (dBμV/m)	Limits (dBμV/m)	Margin (dB)	Detector Type	Comment
GFSK							
2390	56.56	-11.71	44.85	74	29.15	peak	Vertical
2390	57.19	-12.17	45.02	74	28.98	peak	Horizontal
2483.5	56.51	-11.55	44.96	74	29.04	peak	Vertical
2483.5	53.65	-12.59	41.06	74	32.94	peak	Horizontal
π/4-DQPSK							
2390	56.74	-12.07	44.67	74	29.33	peak	Vertical
2390	57.28	-12.97	44.31	74	29.69	peak	Horizontal
2483.5	56.51	-11.53	44.98	74	29.02	peak	Vertical
2483.5	57.38	-13.73	43.65	74	30.35	peak	Horizontal
8-DPSK							
2390	57.52	-11.61	45.91	74	28.09	peak	Vertical
2390	57.71	-13.36	44.35	74	29.65	peak	Horizontal
2483.5	57.9	-11.08	46.82	74	27.18	peak	Vertical
2483.5	57.01	-11.39	45.62	74	28.38	peak	Horizontal

NOTE: The PK value is less than the AV value, AV value is not required.

4. 20 DB OCCUPY BANDWIDTH

4.1 APPLIED PROCEDURES / LIMIT

FCC Part15 (15.247) , Subpart C				
Section	Test Item	Limit	Frequency Range (MHz)	Result
15.247a(1)	20dB bandwidth	/	2400-2483.5	PASS

4.1.1 TEST PROCEDURE

- (1) The EUT was directly connected to the spectrum analyzer and antenna output port as show in the block diagram above.
- (2) Spectrum Setting:
Bandwidth: RBW=30 kHz, VBW=100 kHz, detector= Peak

4.1.2 DEVIATION FROM STANDARD

No deviation.

4.1.3 TEST SETUP



4.1.4 EUT OPERATION CONDITIONS

The EUT tested system was configured as the statements of 2.1 Unless otherwise a special operating condition is specified in the follows during the testing.

4.1.5 TEST RESULTS

EUT :	getwell Aerobic capacity assessment and muscle oxygen monitoring equipment	Model Name :	T1
Temperature :	22 °C	Relative Humidity:	55%
Pressure :	1015 hPa	Test Voltage :	DC 3.7V by battery
Test Mode :	GFSK Mode /CH01, CH40, CH79		

Frequency	20dB Bandwidth (MHz)	Limit	Result
2402 MHz	0.660	/	PASS
2441 MHz	0.657	/	PASS
2480 MHz	0.659	/	PASS

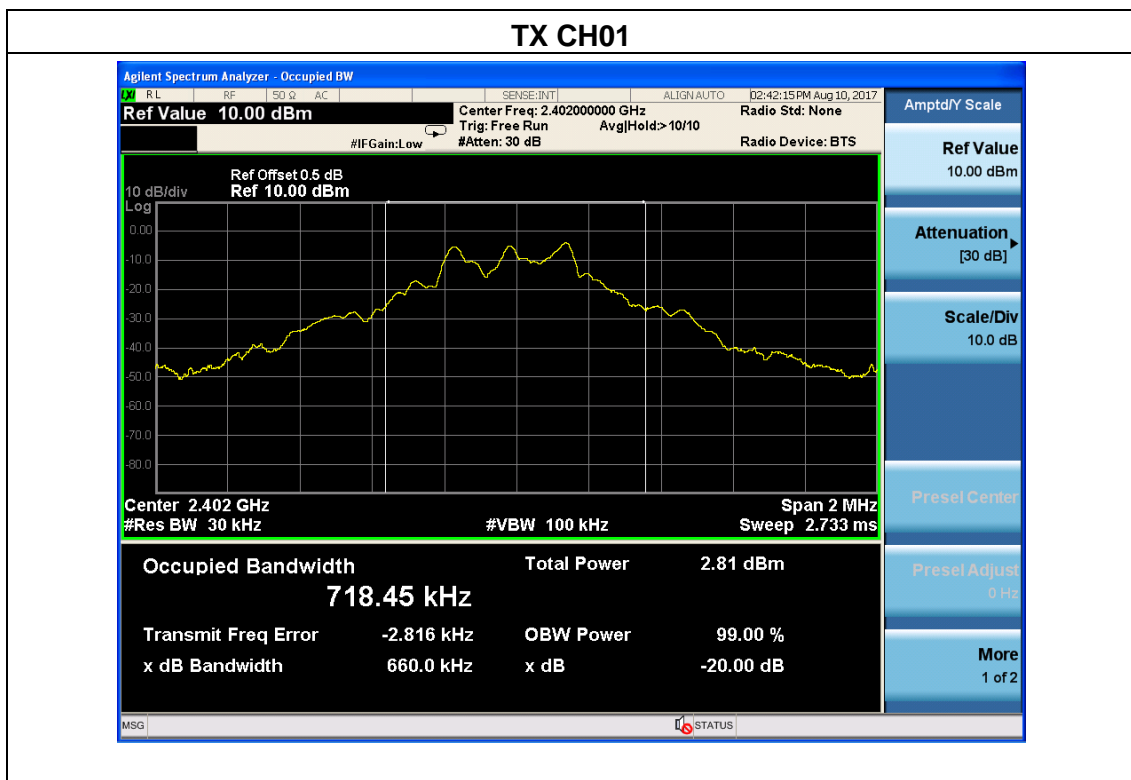

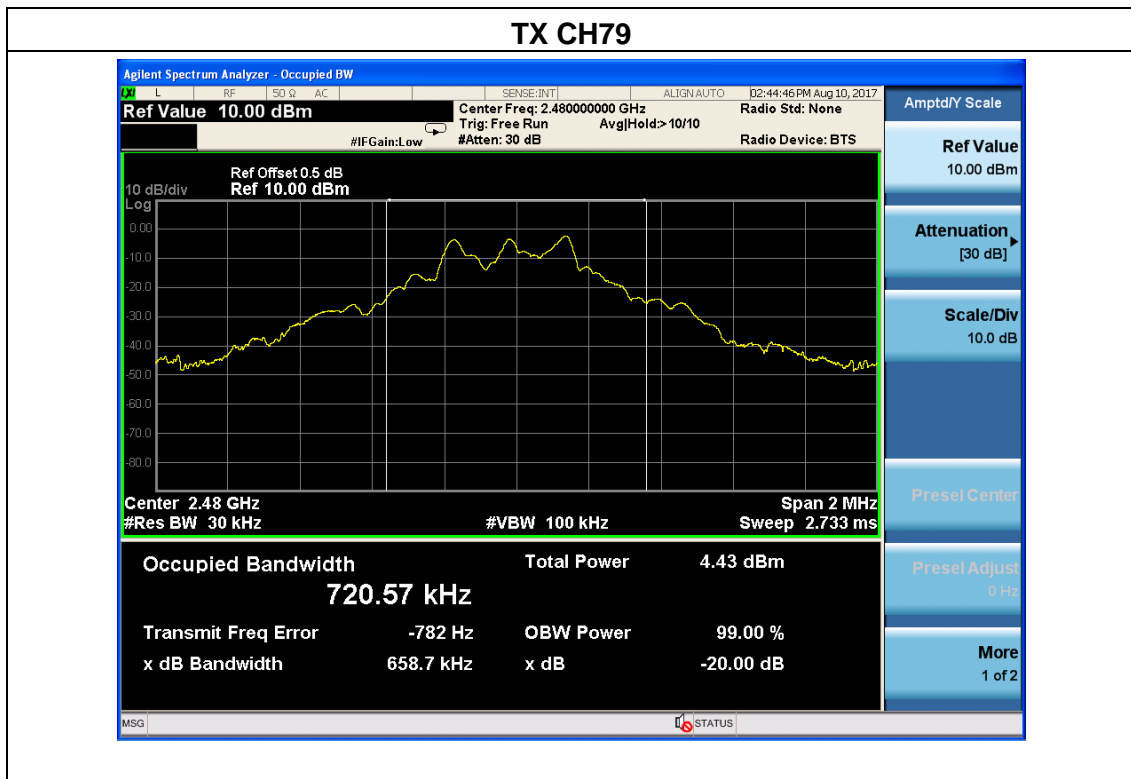
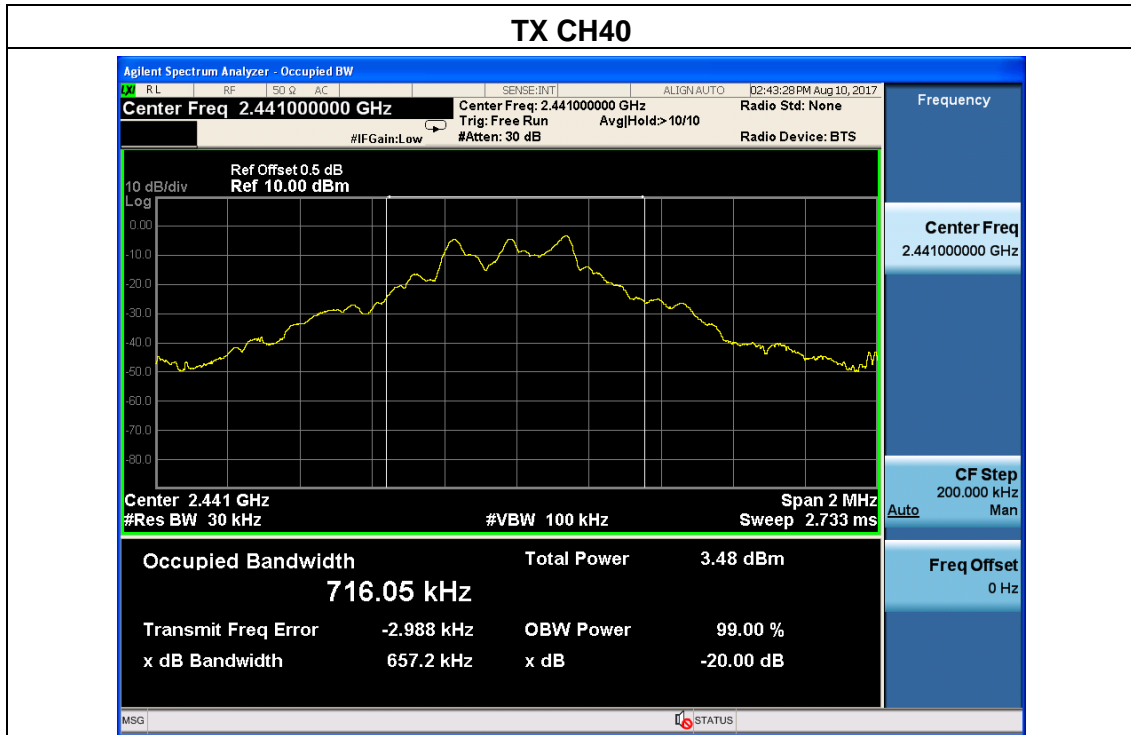

EUT :	getwell Aerobic capacity assessment and muscle oxygen monitoring equipment	Model Name :	T1
Temperature :	22°C	Relative Humidity:	55%
Pressure :	1015 hPa	Test Voltage :	DC 3.7V by battery
Test Mode :	π/4-DQPSK, Mode /CH01, CH40, CH79		

Frequency	20dB Bandwidth (MHz)	Limit	Result
2402 MHz	1.206	/	PASS
2441 MHz	1.205	/	PASS
2480 MHz	1.206	/	PASS

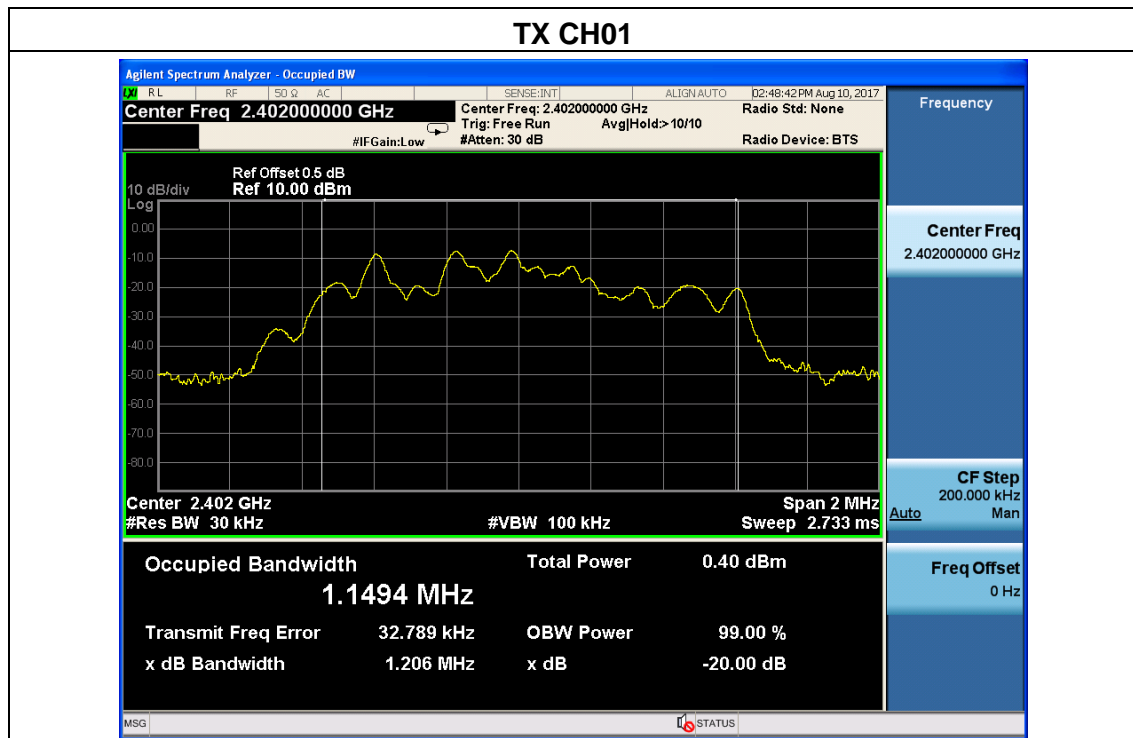

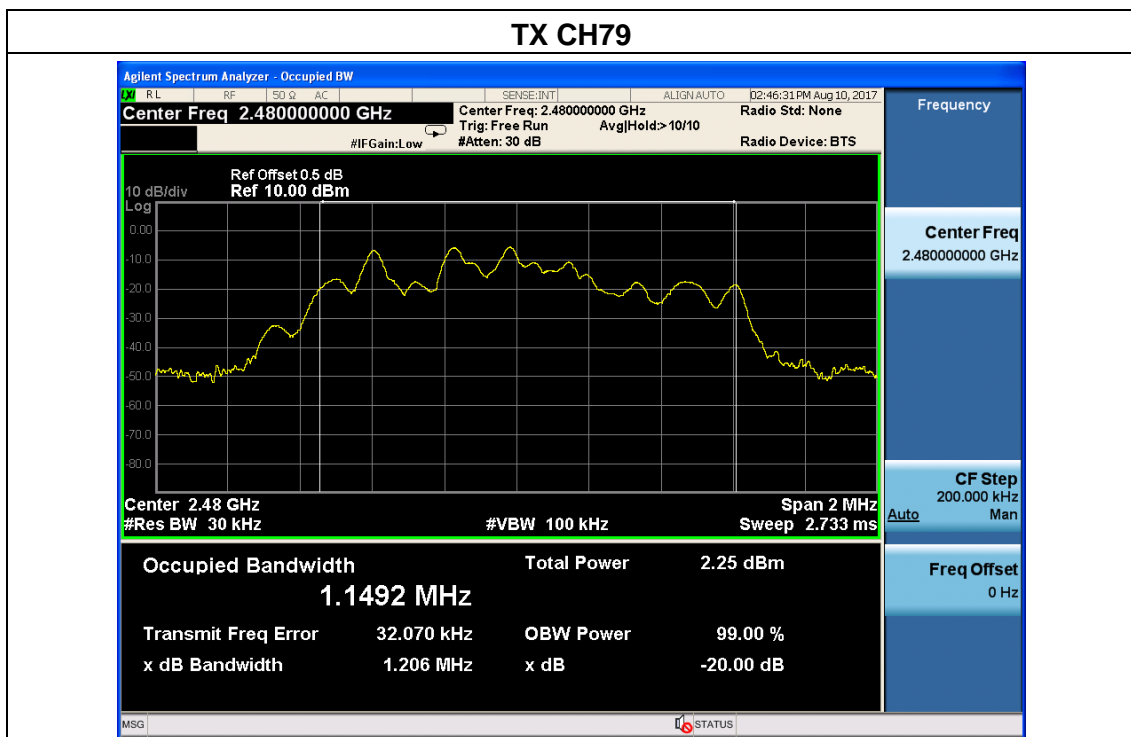
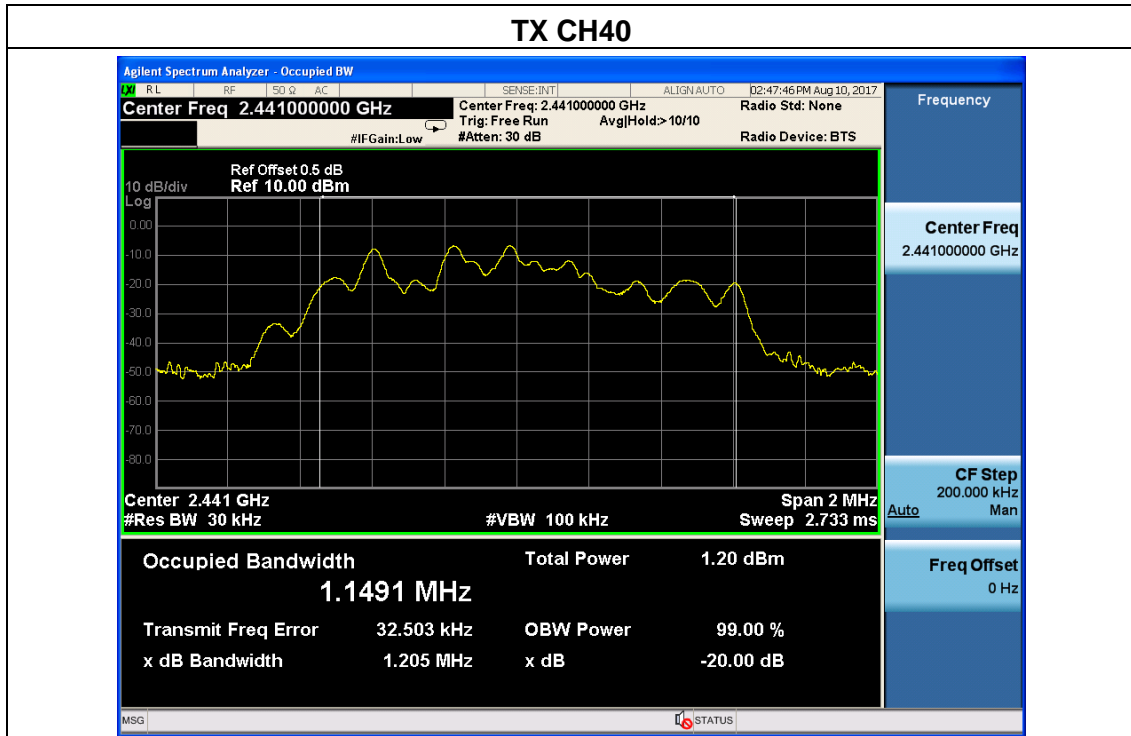

EUT :	getwell Aerobic capacity assessment and muscle oxygen monitoring equipment	Model Name :	T1
Temperature :	22°C	Relative Humidity:	55%
Pressure :	1015 hPa	Test Voltage :	DC 3.7V by battery
Test Mode :	8-DPSK Mode /CH01, CH40, CH79		

Frequency	20dB Bandwidth (KHz)	Limit	Result
2402 MHz	1.233	/	PASS
2441 MHz	1.228	/	PASS
2480 MHz	1.229	/	PASS

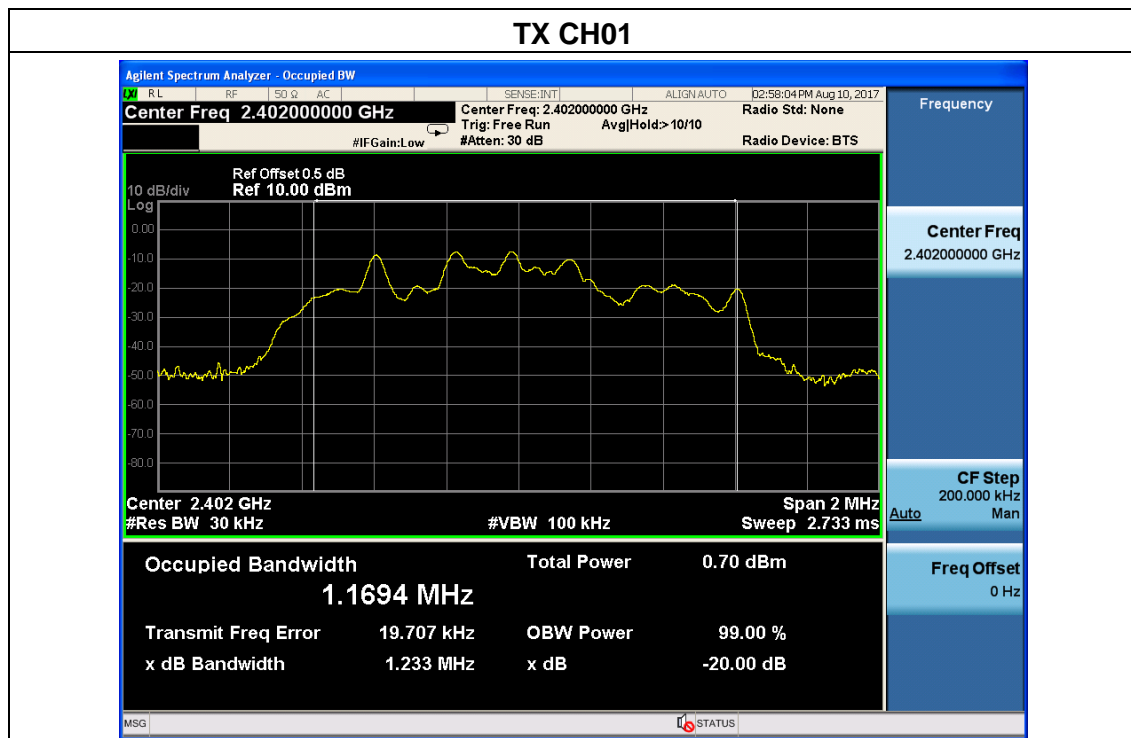

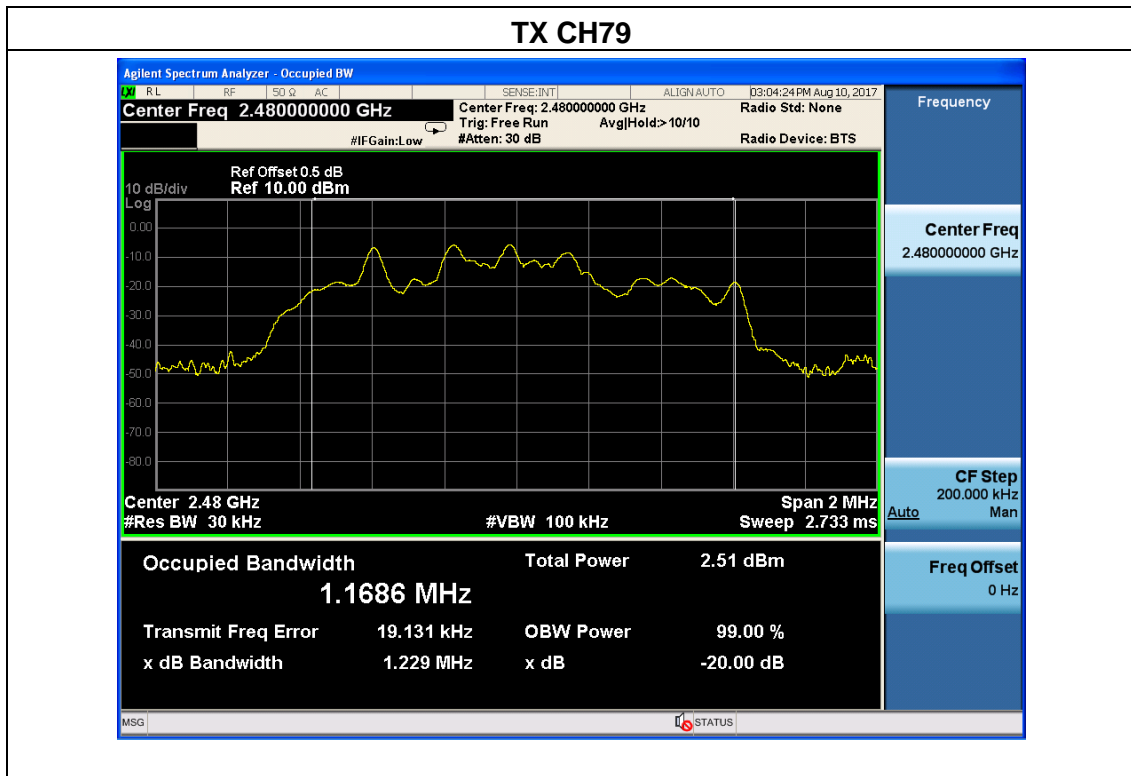
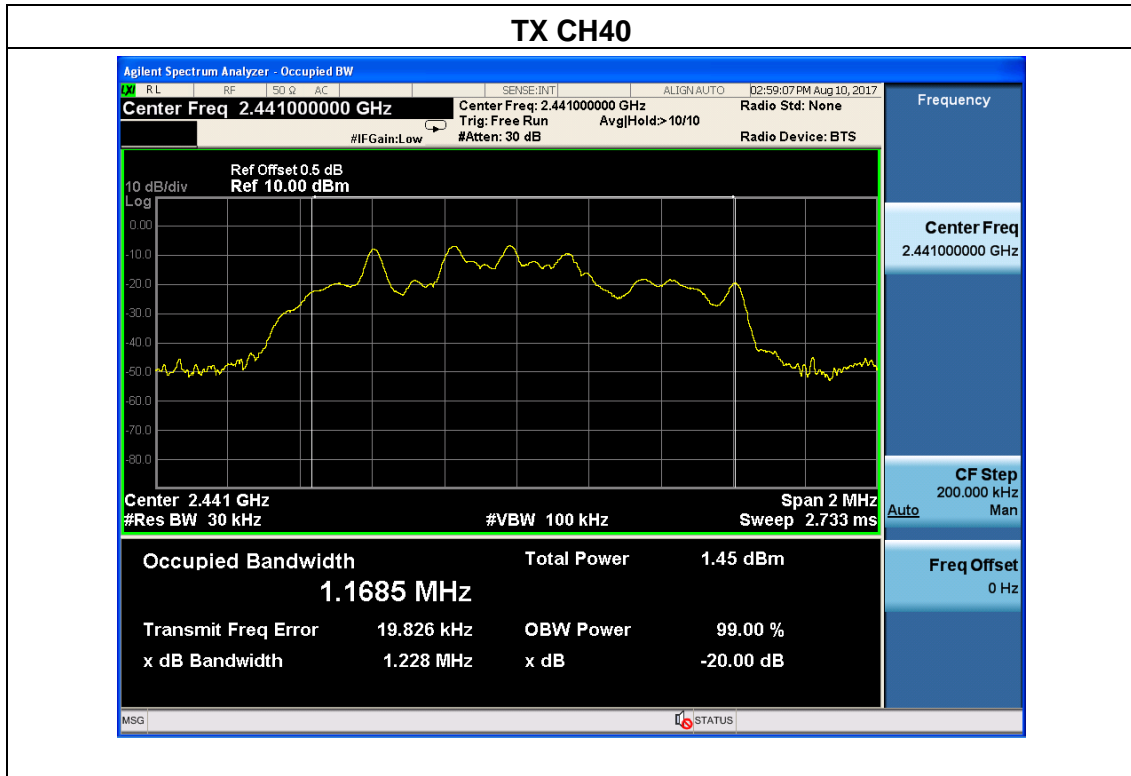

5. CARRIER FREQUENCY SEPARATION TEST

5.1 APPLIED PROCEDURES / LIMIT

FCC Part15 (15.247) , Subpart C				
Section	Test Item	Limit	Frequency Range (MHz)	Result
15.247(a)(1)	Channel Separation	>25KHz or >two-thirds of the 20 dB bandwidth (Which is greater)	2400-2483.5	PASS

5.1.1 TEST PROCEDURE

- (1) The EUT was directly connected to the spectrum analyzer and antenna output port as show in the block diagram above.
- (2) Spectrum Setting:
RBW=100 kHz, VBW=300 kHz, detector= Peak, Sweep Time =auto.
- (3) The EUT was set to the Hopping Mode for Channel Separation Test and continuously transmitting for the Test.

5.1.2 DEVIATION FROM STANDARD

No deviation.

5.1.3 TEST SETUP

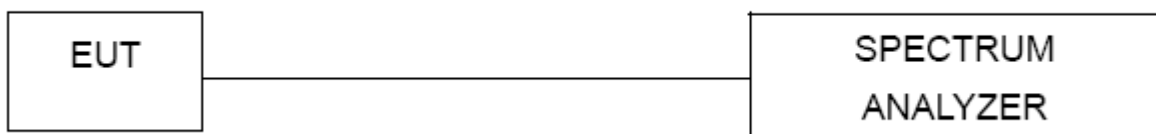

5.1.4 EUT OPERATION CONDITIONS

The EUT tested system was configured as the statements of 2.4 Unless otherwise a special operating condition is specified in the follows during the testing.

5.1.5 TEST RESULTS

EUT :	getwell Aerobic capacity assessment and muscle oxygen monitoring equipment	Model Name :	T1
Temperature :	22°C	Relative Humidity:	55%
Pressure :	1012 hPa	Test Voltage :	DC 3.7V by battery
Test Mode :	GFSK Mode /CH01, CH40, CH79		

Mode	Channel	Frequency (MHz)	Test Result (KHz)	Limit (kHz)	Result
GFSK	Middle	2441	1002	556.867	Pass
$\pi/4$ -DQPSK	Middle	2441	1002	812.667	Pass
8DPSK	Middle	2441	1002	812.667	Pass

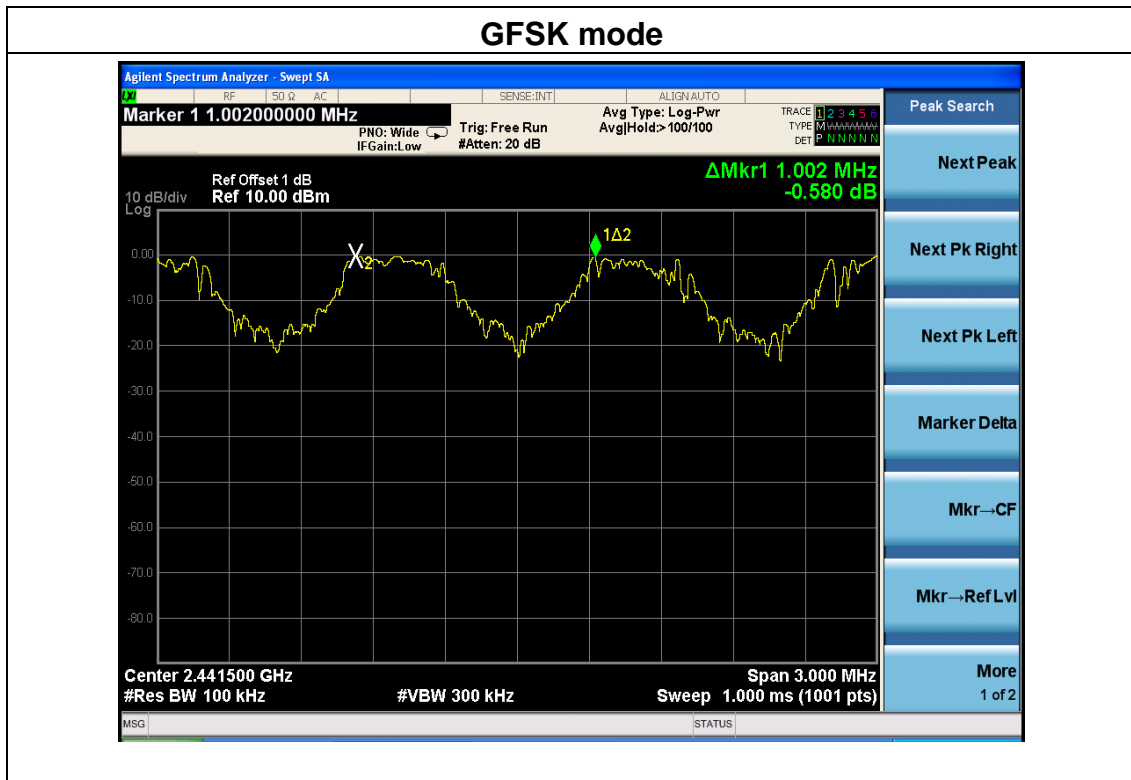

$\pi/4$ -DQPSK mode



8DPSK mode

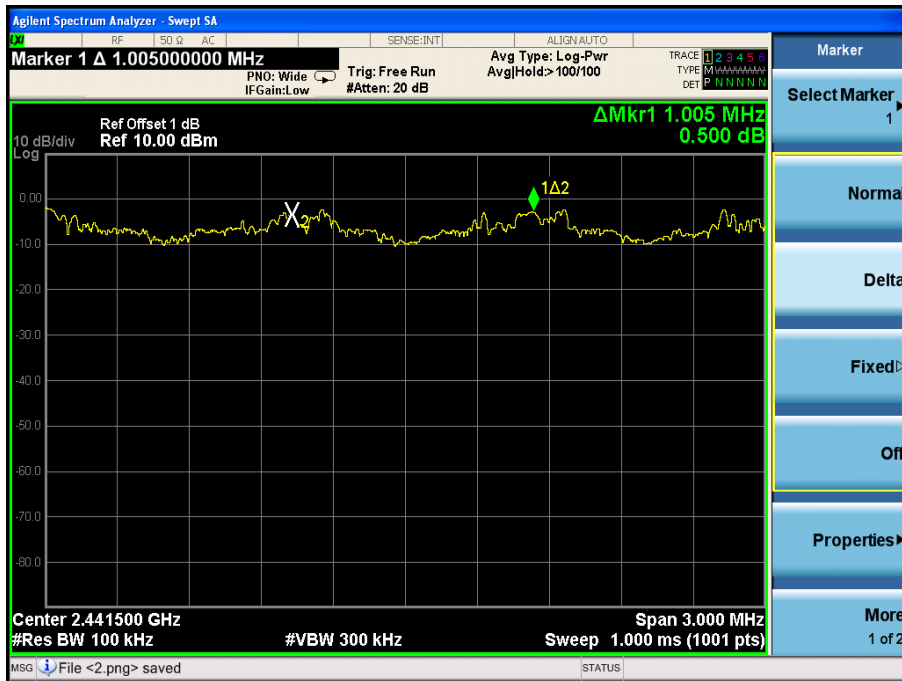

6. NUMBER OF HOPPING CHANNEL

6.1 APPLIED PROCEDURES / LIMIT

FCC Part15 (15.247) , Subpart C				
Section	Test Item	Limit	Frequency Range (MHz)	Result
15.247(a)(a)	Number of Hopping Channel	>15 channels	2400-2483.5	PASS

6.1.1 TEST PROCEDURE

- (1) The EUT was directly connected to the spectrum analyzer and antenna output port as show in the block diagram above.
- (2) Spectrum Setting: RBW=100 kHz, VBW=300 kHz, Detector=Peak, Sweep time= Auto.
- (3) The EUT was set to the Hopping Mode for Channel Separation Test and continuously transmitting for the Test.

6.1.2 DEVIATION FROM STANDARD

No deviation.

6.1.3 TEST SETUP



6.1.4 EUT OPERATION CONDITIONS

The EUT tested system was configured as the statements of 2.4 Unless otherwise a special operating condition is specified in the follows during the testing.

6.1.5 TEST RESULTS

EUT :	getwell Aerobic capacity assessment and muscle oxygen monitoring equipment	Model Name :	T1
Temperature :	22°C	Relative Humidity:	55%
Pressure :	1012 hPa	Test Voltage :	DC 3.7V by battery
Test Mode :	GFSK, $\pi/4$ -DQPSK, 8-DPSK Mode /CH01, CH40, CH79		

Mode	Quantity of Hopping Channel	Limit	Judgment
GFSK, $\pi/4$ -DQPSK, 8DPSK	79	>15	PASSED

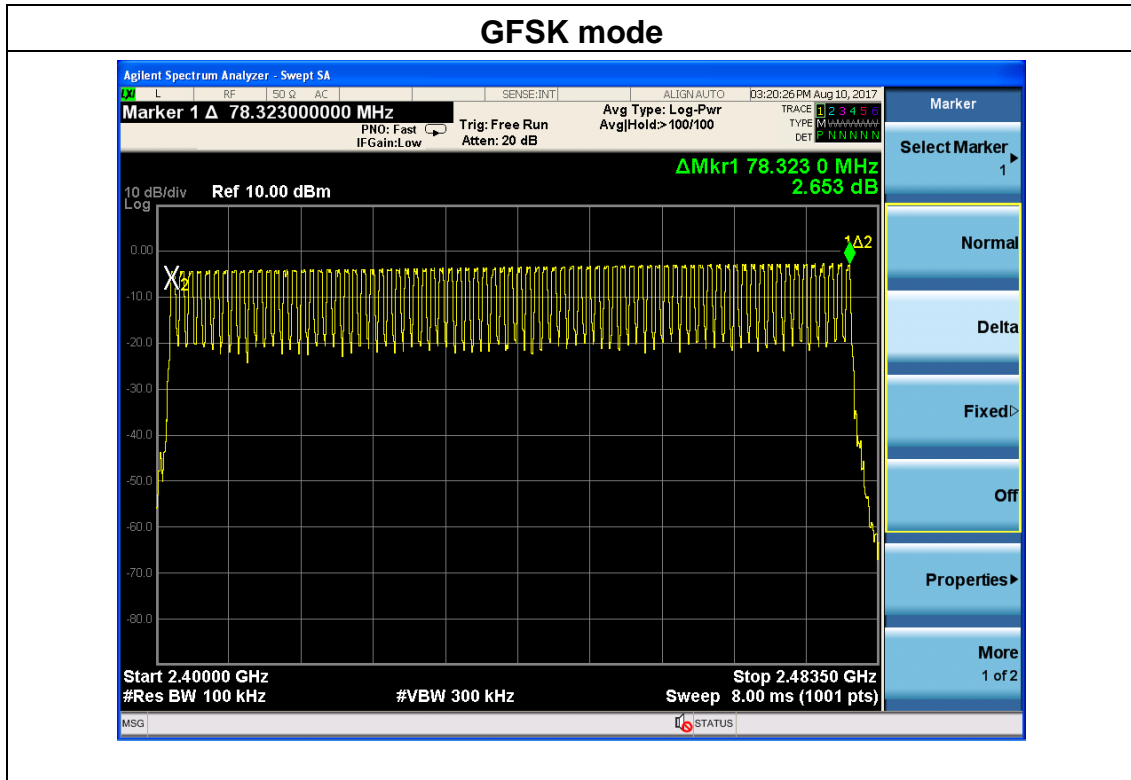

$\pi/4$ -DQPSK mode

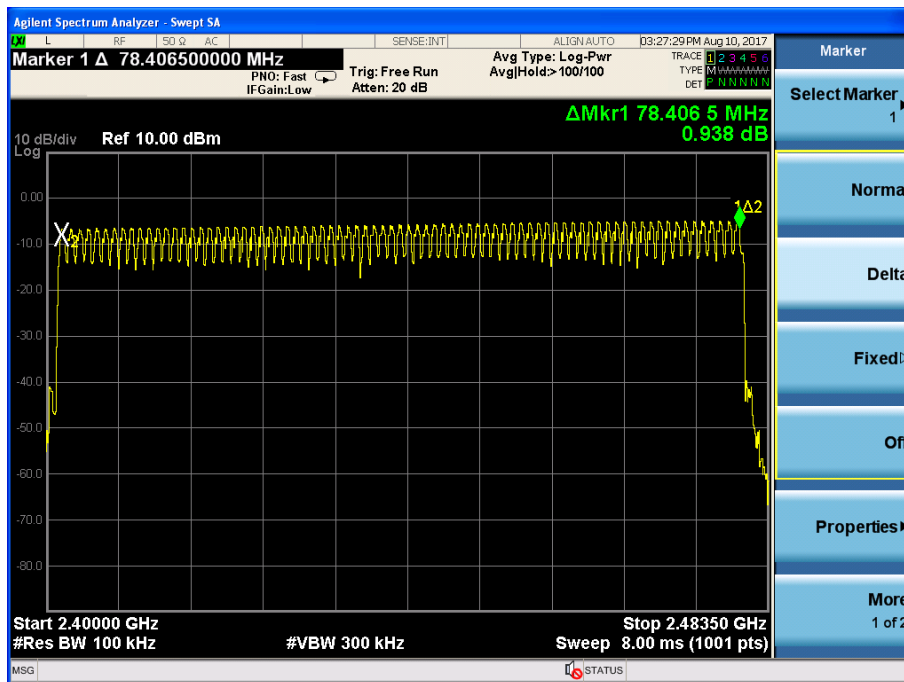

8DPSK mode

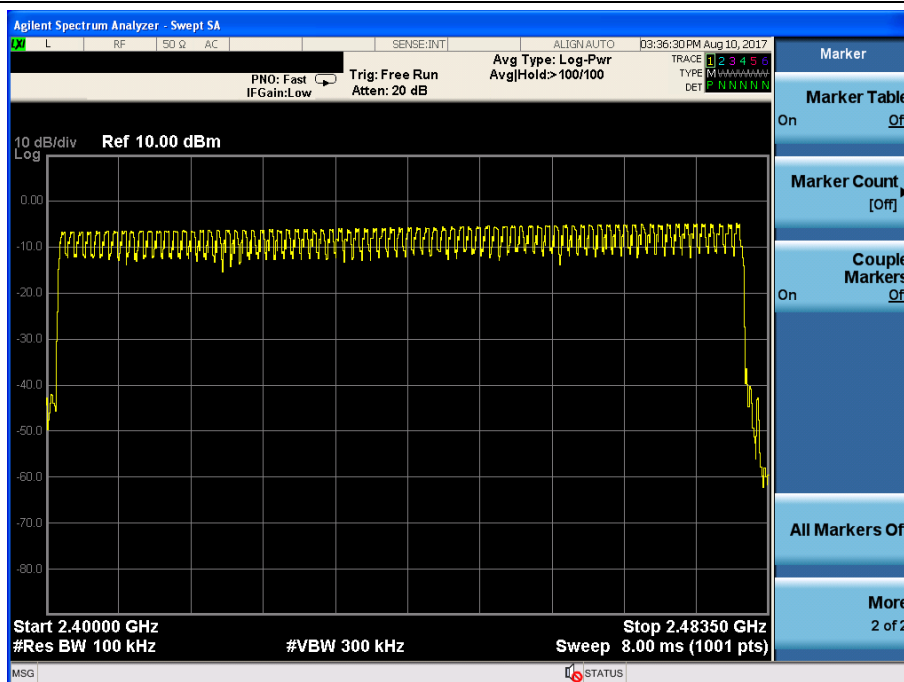

7. DWELL TIME

7.1 APPLIED PROCEDURES / LIMIT

FCC Part15 (15.247) , Subpart C				
Section	Test Item	Limit	Frequency Range (MHz)	Result
15.247(a)(a)	Dwell time	0.4 sec	2400-2483.5	PASS

7.1.1 TEST PROCEDURE

- (1) The EUT was directly connected to the spectrum analyzer and antenna output port as show in the block diagram above.
- (2) Spectrum Setting: RBW=1MHz, VBW=1MHz, Span=0Hz, Detector=Peak
- (3) Use video trigger with the trigger level set to enable triggering only on full pulses.
- (4) Sweep Time is more than once pulse time.
- (5) Set the center frequency on any frequency would be measure and set the frequency span to zero span.
- (6) Measure the maximum time duration of one single pulse.
- (7) Set the EUT for packet transmitting.
- (8) Measure the maximum time duration of one single pulse.
- (9) The EUT was set to the Hopping Mode for Dwell Time Test

7.1.1.1 DEVIATION FROM STANDARD

No deviation.

7.1.1.2 TEST SETUP



7.1.1.3 EUT OPERATION CONDITIONS

The EUT tested system was configured as the statements of 2.4 Unless otherwise a special operating condition is specified in the follows during the testing.

7.1.1.4 TEST RESULTS

EUT :	getwell Aerobic capacity assessment and muscle oxygen monitoring equipment	Model Name :	T1
Temperature :	22°C	Relative Humidity:	55%
Pressure :	1012 hPa	Test Voltage :	DC 3.7V by battery
Test Mode :	GFSK, π/4-DQPSK, 8-DPSK Mode /CH01, CH40, CH79		

For GFSK, $\pi/4$ -DQPSK and 8DPSK:

The test period: $T = 0.4 \text{ Second/Channel} \times 79 \text{ Channel} = 31.6 \text{ s}$

Mode	Data Packet	Frequency (MHz)	Pulse Duration (ms)	Dwell Time (ms)	Limit (s)	Conclusion
GFSK	DH1	2441	0.396	126.72	<0.4	PASS
	DH3	2441	1.652	264.32	<0.4	PASS
	DH5	2441	2.888	308.05	<0.4	PASS
$\pi/4$ DQPSK	DH1	2441	0.404	129.28	<0.4	PASS
	DH3	2441	1.656	264.96	<0.4	PASS
	DH5	2441	2.896	308.91	<0.4	PASS
8- DQPSK	DH1	2441	0.408	130.56	<0.4	PASS
	DH3	2441	1.636	261.76	<0.4	PASS
	DH5	2441	2.900	309.33	<0.4	PASS
<p>Note: 1 A period time = $0.4 \text{ (s)} \times 79 = 31.6 \text{ (s)}$ 2 DH1 time slot = $\text{Pulse Duration} \times (1600/(2 \times 79)) \times \text{A period time}$ DH3 time slot = $\text{Pulse Duration} \times (1600/(4 \times 79)) \times \text{A period time}$ DH5 time slot = $\text{Pulse Duration} \times (1600/(6 \times 79)) \times \text{A period time}$</p>						

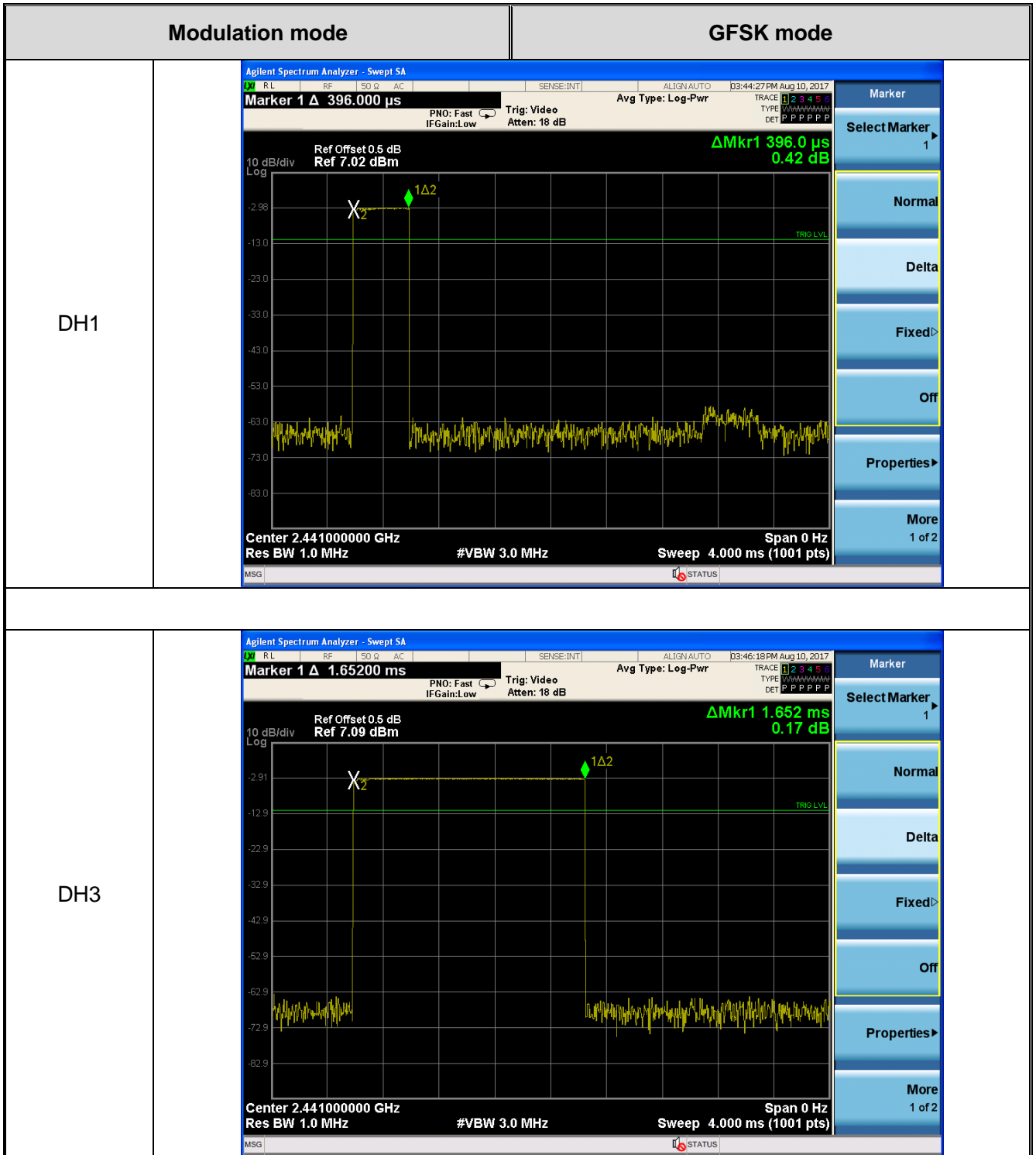

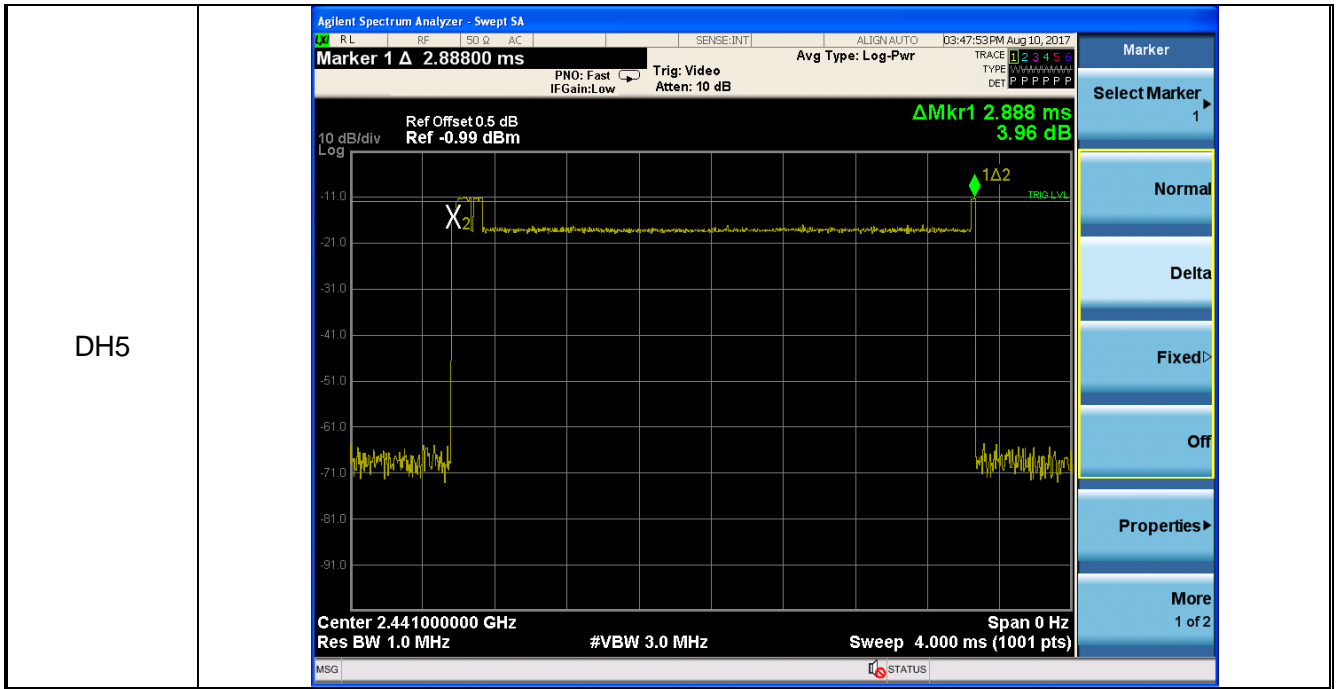

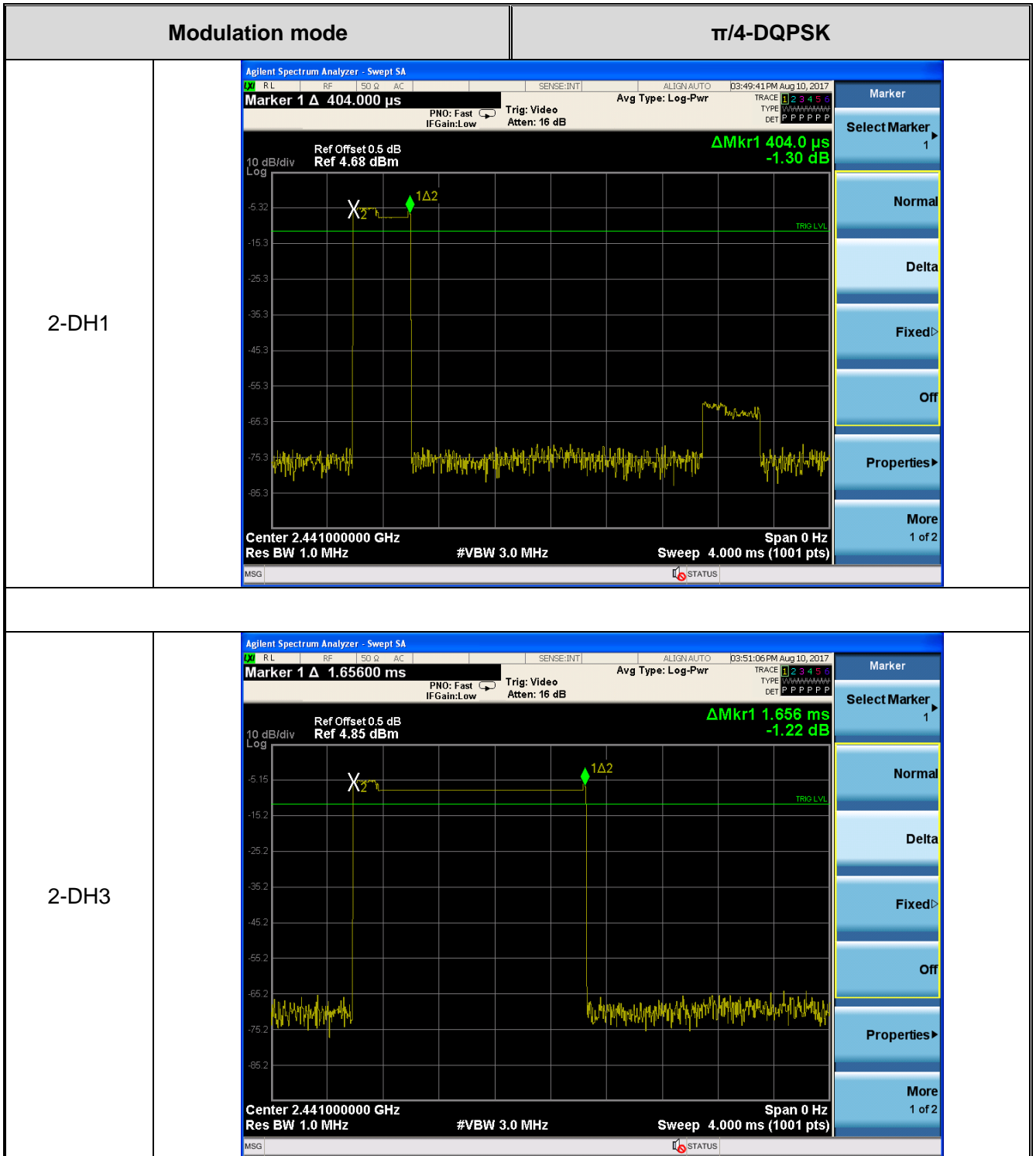

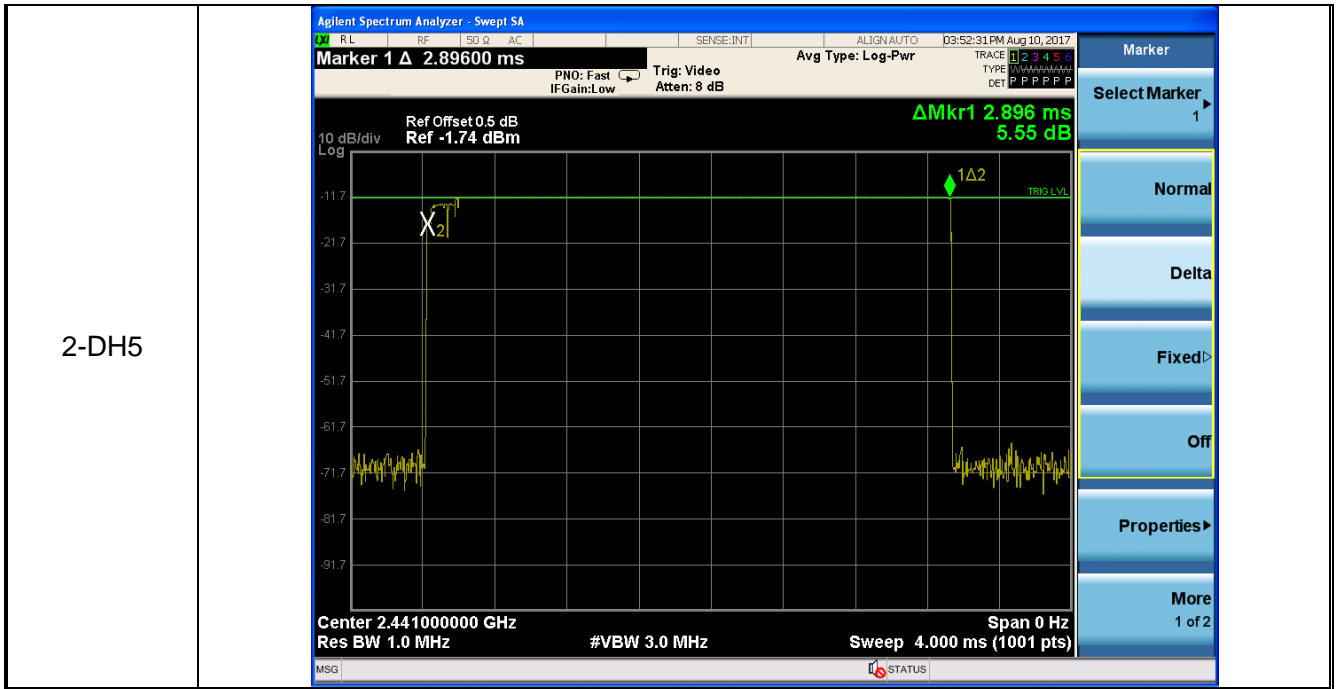

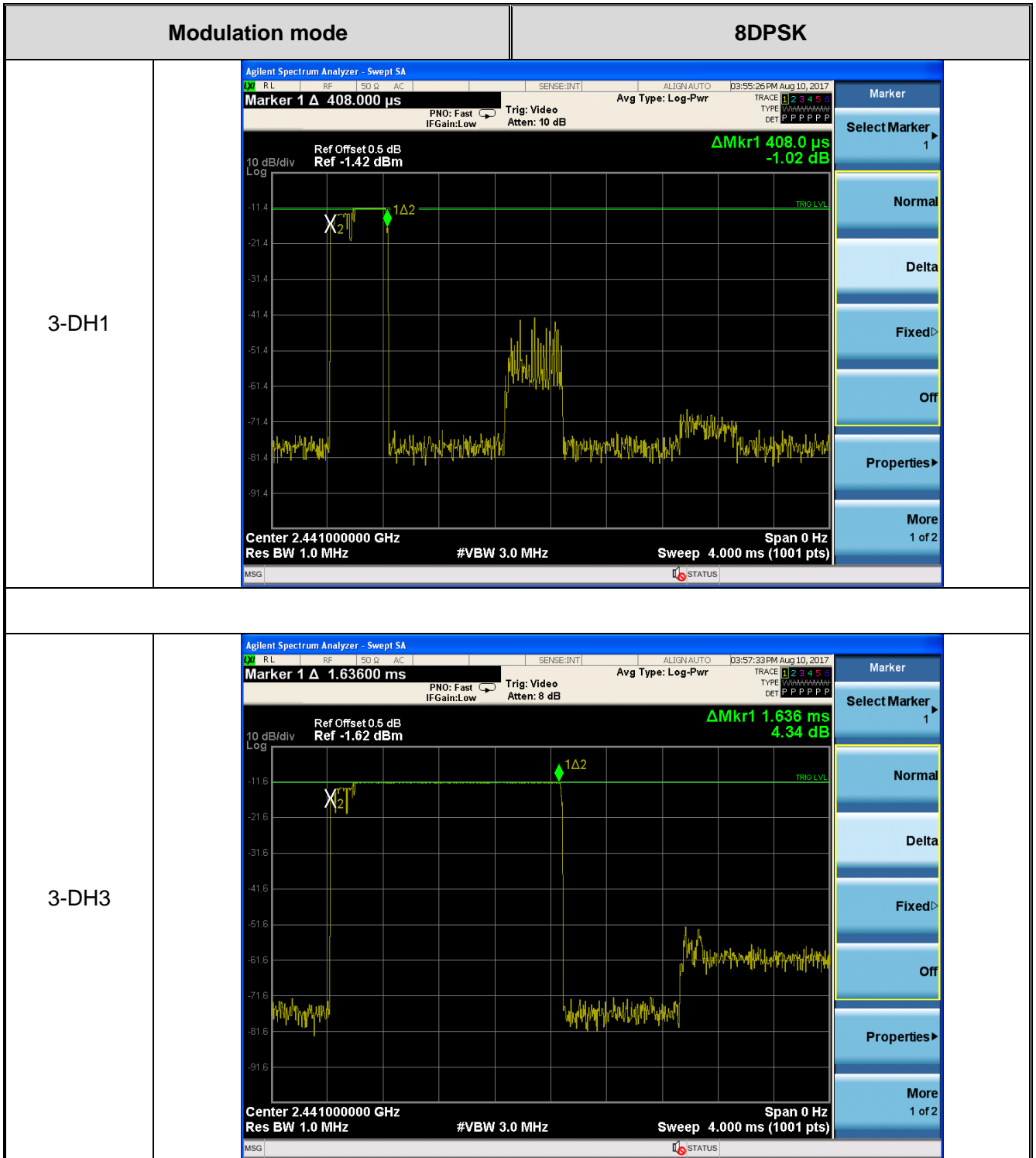

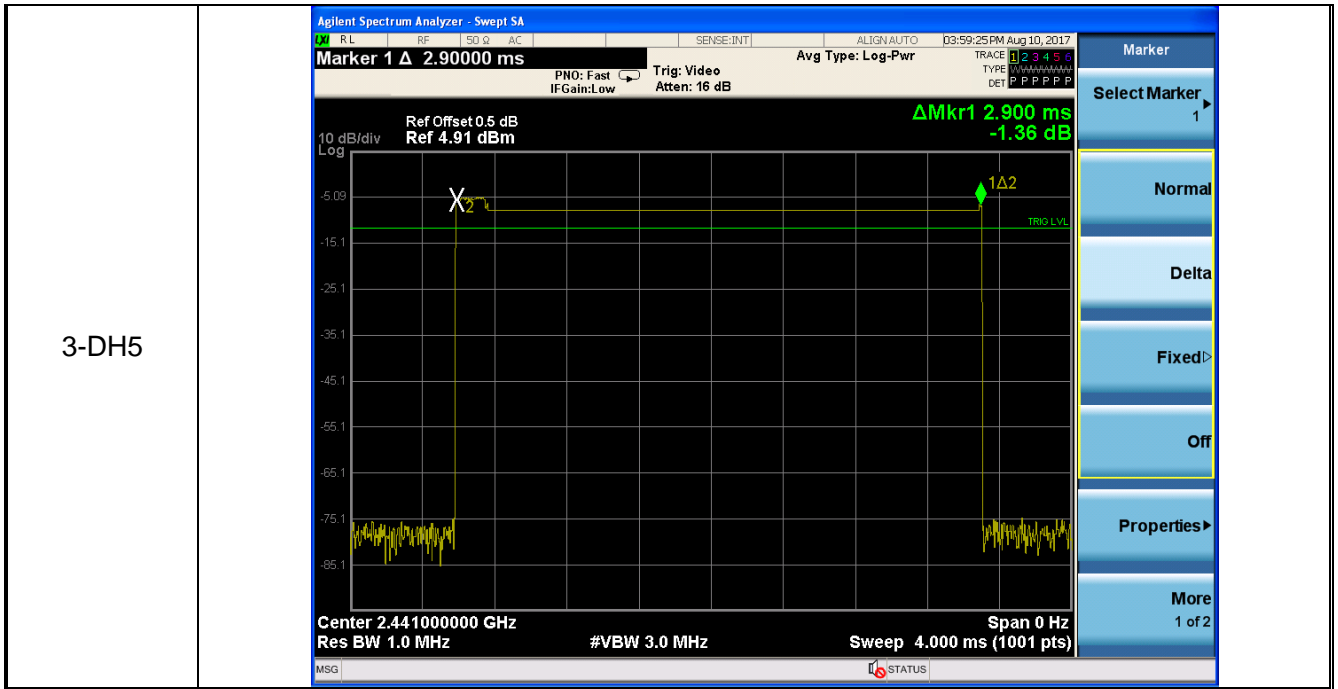

8. PEAK OUTPUT POWER TEST

8.1 APPLIED PROCEDURES / LIMIT

FCC Part15 (15.247) , Subpart C				
Section	Test Item	Limit	Frequency Range (MHz)	Result
15.247(b)(3)	Peak Output Power	Hopping Channels>75 Power<1W(30dBm) Other <125 mW(21dBm)	2400-2483.5	PASS

8.1.1 TEST PROCEDURE

- (1) The EUT was directly connected to the spectrum analyzer and antenna output port as show in the block diagram above.
- (2) Spectrum Setting:
RBW=1MHz, VBW=3MHz, Detector=Peak (If 20dB BW ≤1 MHz)
RBW=3MHz, VBW=10MHz, Detector=Peak (If 20dB BW > 1 MHz)
- (3) The EUT was set to continuously transmitting in the max power during the test.

8.1.2 DEVIATION FROM STANDARD

No deviation.

8.1.3 TEST SETUP



8.1.4 EUT OPERATION CONDITIONS

The EUT tested system was configured as the statements of 2.4 Unless otherwise a special operating condition is specified in the follows during the testing.

8.1.5 TEST RESULTS

EUT :	getwell Aerobic capacity assessment and muscle oxygen monitoring equipment	Model Name :	T1
Temperature :	22°C	Relative Humidity:	55%
Pressure :	1012 hPa	Test Voltage :	DC 3.7V by battery
Test Mode :	GFSK, $\pi/4$ -DQPSK, 8-DPSK Mode /CH01, CH40, CH79		

Test Channe	Frequency	Maximum Conducted Output Power(PK) (dBm)	LIMIT
	(MHz)	TX GFSK Mode	dBm
CH01	2402	1.23	30
CH40	2441	1.95	30
CH79	2480	1.67	30
TX $\pi/4$-DQPSK Mode			
CH01	2402	0.56	30
CH40	2441	0.83	30
CH79	2480	0.62	30
TX 8-DPSK Mode			
CH01	2402	0.22	30
CH40	2441	0.15	30
CH79	2480	0.18	30

||||

9. 100 KHZ BANDWIDTH OF FREQUENCY BAND EDGE

APPLICABLE STANDARD

In any 100 kHz bandwidth outside the frequency band in which the spread spectrum or digitally modulated intentional radiator is operating, the radio frequency power that is produced by the intentional radiator shall be at least 20 dB below that in the 100 kHz bandwidth within the band that contains the highest level of the desired power, based on either an RF conducted or a radiated measurement, provided the transmitter demonstrates compliance with the peak conducted power limits. If the transmitter complies with the conducted power limits based on the use of RMS averaging over a time interval, as permitted under paragraph (b)(3) of this section, the attenuation required under this paragraph shall be 30 dB instead of 20 dB. Attenuation below the general limits specified in §15.209(a) is not required. In addition, radiated emissions which fall in the restricted bands, as defined in §15.205(a), must also comply with the radiated emission limits specified in §15.209(a) (see §15.205(c)).

TEST PROCEDURE

- a) Check the calibration of the measuring instrument using either an internal calibrator or a known signal from an external generator.
- b) Position the EUT without connection to measurement instrument. Turn on the EUT and connect its antenna terminal to measurement instrument via a low loss cable. Then set it to any one measured frequency within its operating range, and make sure the instrument is operated in its linear range.
- c) Set RBW to 100 kHz and VBW of spectrum analyzer to 300 kHz with a convenient frequency span including 100 kHz bandwidth from band edge.
- d) Measure the highest amplitude appearing on spectral display and set it as a reference level. Plot the graph with marking the highest point and edge frequency.
- e) Repeat above procedures until all measured frequencies were complete.

9.1 DEVIATION FROM STANDARD

No deviation.

9.2 TEST SETUP



9.3 EUT OPERATION CONDITIONS

The EUT tested system was configured as the statements of 2.4 Unless otherwise a special operating condition is specified in the follows during the testing.

9.4 TEST RESULTS

EUT :	getwell Aerobic capacity assessment and muscle oxygen monitoring equipment	Model Name :	T1
Temperature :	22 °C	Relative Humidity:	55%
Pressure :	1012 hPa	Test Voltage :	DC 3.7V by battery

Frequency Band	Delta Peak to band emission (dBc)	> Limit (dBc)	Result
GFSK mode			
Left-band	48.03	20	Pass
Right-band	52.97	20	Pass
$\pi/4$ -DQPSK mode			
Left-band	40.21	20	Pass
Right-band	52.21	20	Pass
8-DPSK mode			
Left-band	42.982	20	Pass
Right-band	58.662	20	Pass

GFSK: Band Edge, Left Side

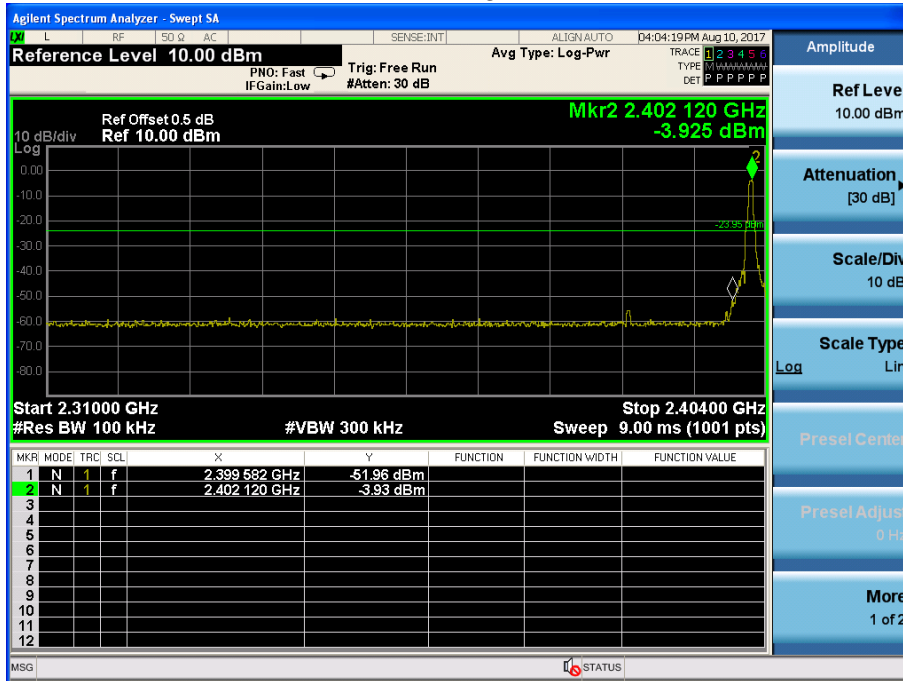

GFSK: Band Edge, Right Side

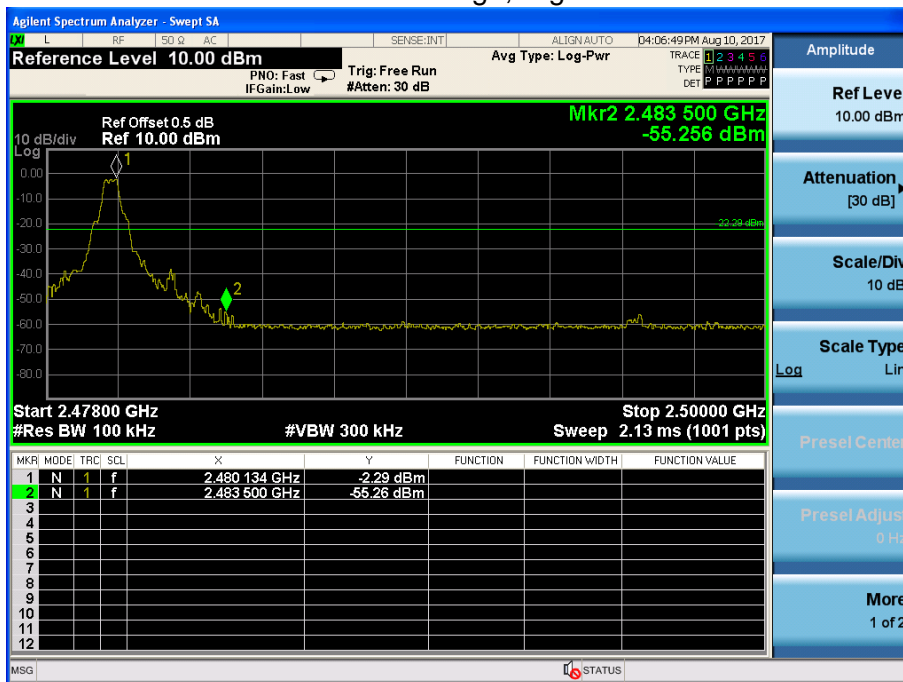

$\pi/4$ -DQPSK: Band Edge, Left Side

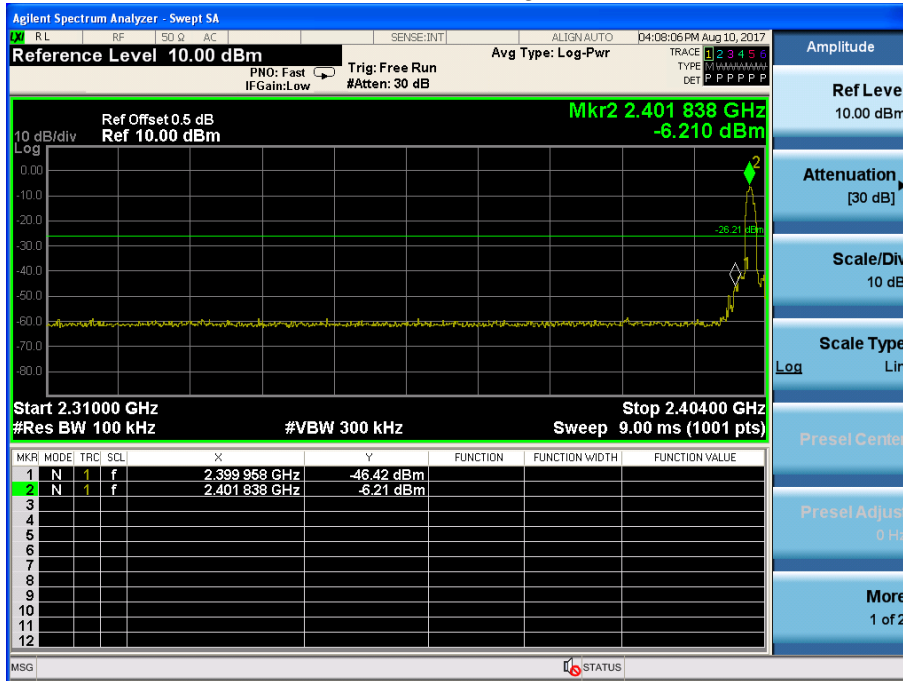

$\pi/4$ -DQPSK: Band Edge, Right Side



8-DPSK: Band Edge, Left Side

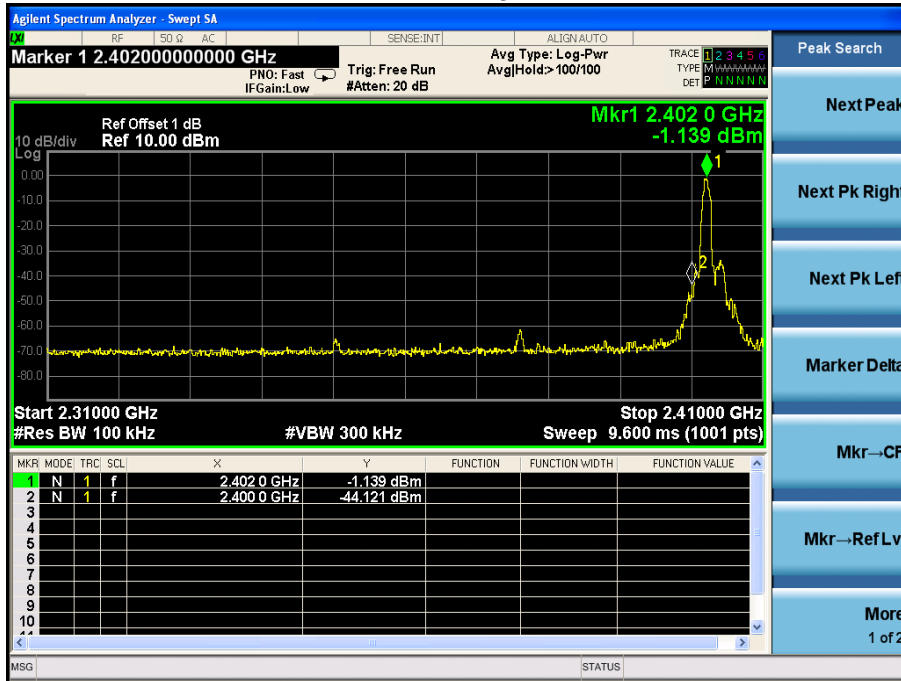

8-DPSK: Band Edge, Right Side

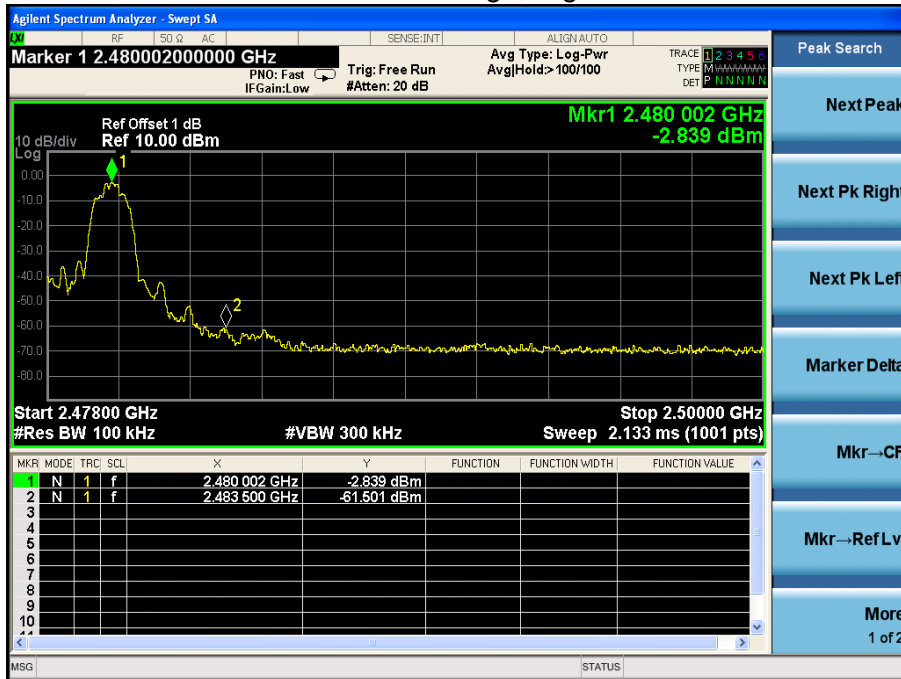

Hopping Mode

Frequency Band	Delta Peak to band emission (dBc)	> Limit (dBc)	Result
GFSK mode			
Left-band	39.735	20	Pass
Right-band	67.626	20	Pass

Note: GFSK , Pi/4QPSK , 8DPSK all have been tested, Only worse case is reported.

GFSK: Band Edge, Left Side

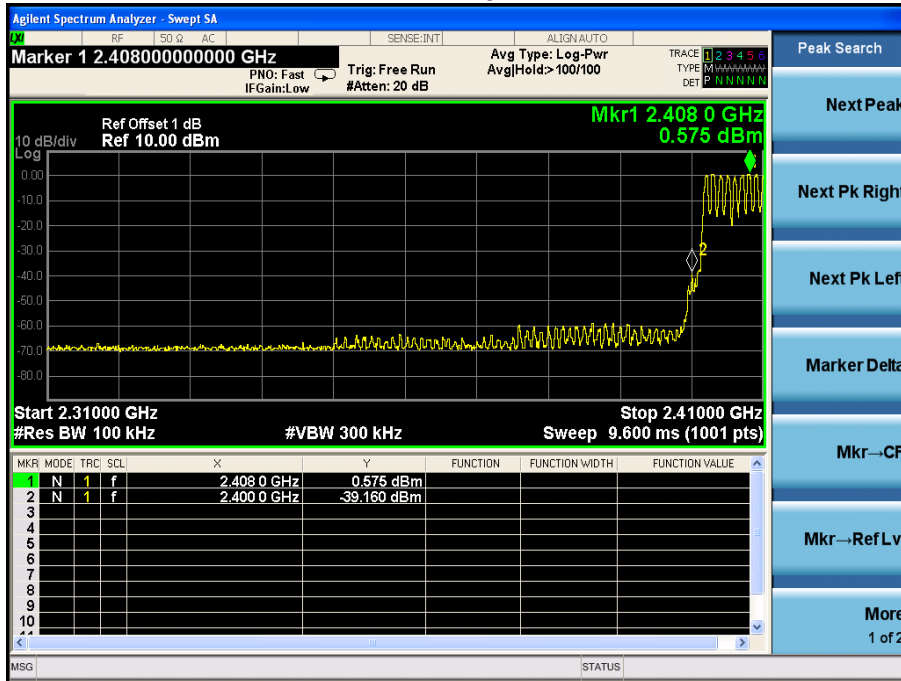

GFSK: Band Edge, Right Side

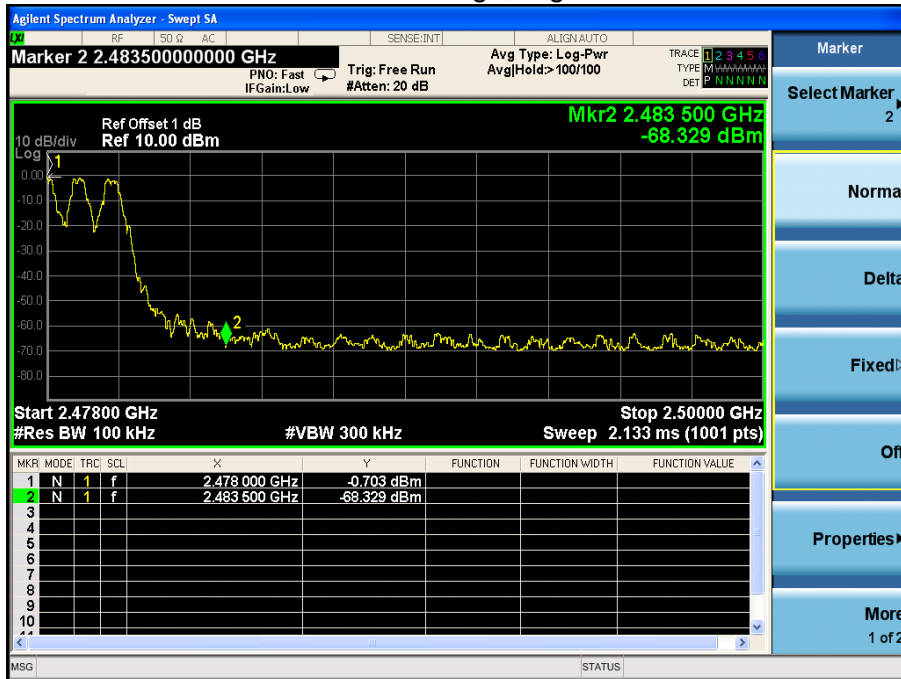

10. ANTENNA REQUIREMENT

10.1 STANDARD REQUIREMENT

15.203 requirement: For intentional device, according to 15.203: an intentional radiator shall be designed to ensure that no antenna other than that furnished by the responsible party shall be used with the device.

10.2 EUT ANTENNA

The EUT antenna is integral antenna.

----END OF REPORT----