

Philips Respironics **TEST REPORT**

SCOPE OF WORK

EMC TESTING – Trilogy Evo Ventilator with OBM

REPORT NUMBER

G103284061-001

ISSUE DATE

January 15, 2018

PAGES

58

DOCUMENT CONTROL NUMBER

Non-Specific Radio Report Shell Rev. December 2017
© 2017 INTERTEK



EMC TEST REPORT (PARTIAL COMPLIANCE)

Report Number: 103284061LAX-001

Project Number: G103284061

Report Issue Date: January 15, 2018

Model(s) Tested: Trilogy Evo Ventilator with OBM

Model(s) Partially Tested: None

Model(s) Not Tested but declared equivalent by the client: Trilogy Evo Ventilator

Standards: FCC CFR47 Part 15 Subpart C, December 2017

Intentional Radiator

§15.247, Operation within the bands 902-928 MHz, 2400-2483.5 MHz, and 5725-5850 MHz

ISED RSS-247 Issue 2, February 2017, Edited March 24, 2017

Digital Transmission Systems (DTSs), Frequency Hopping Systems (FHs) and Licence-Exempt Local Area Network (LE-LAN) Devices

Tested by:
Intertek
25791 Commercentre Drive
Lake Forest, CA 92630
USA

Client:
Philips Respironics
1740 Golden Mile Highway
Monroeville, PA 15146
USA

Report prepared by



Martin Liu
EMC Project Engineer

Report reviewed by



Grace Lin
EMC Staff Engineer

This report is for the exclusive use of Intertek's Client and is provided pursuant to the agreement between Intertek and its Client. Intertek's responsibility and liability are limited to the terms and conditions of the agreement. Intertek assumes no liability to any party, other than to the Client in accordance with the agreement, for any loss, expense or damage occasioned by the use of this report. Only the Client is authorized to permit copying or distribution of this report and then only in its entirety. Any use of the Intertek name or one of its marks for the sale or advertisement of the tested material, product or service must first be approved in writing by Intertek. The observations and test results in this report are relevant only to the sample tested. This report by itself does not imply that the material, product, or service is or has ever been under an Intertek certification program.

Table of Contents

Philips Respironics..... 1

1 Introduction and Conclusion..... 4

2 Test Summary 4

3 Client Information 5

4 Description of Equipment Under Test and Variant Models 5

5 System Setup and Method 8

6 Transmitter Radiated Spurious Emissions 9

7 Revision History..... 58

1 Introduction and Conclusion

The test included in this test report is to support a permissive change for a certified transmitter module, FCC ID: Z64-WL18SBMOD and IC: 4511- WL18SBMOD. The only change from the certified transmitter module was an antenna with a lower antenna gain. There was no other change being made. Transmitter radiated spurious emission test was performed to support the change.

The tests indicated in section 2.0 were performed on the product constructed as described in section 4.0. The remaining test sections are the verbatim text from the actual data sheets used during the investigation. These test sections include the test name, the specified test Method, a list of the actual Test Equipment Used, documentation Photos, Results and raw Data. No additions, deviations, or exclusions have been made from the standard(s) unless specifically noted.

Based on the results of our investigation, we have concluded the product tested **complies** with the requirements of the standard(s) indicated. The results obtained in this test report pertain only to the item(s) tested. Intertek does not make any claims of compliance for samples or variants which were not tested.

2 Test Summary

Section	Test full name	Result
3	Client Information	-
4	Description of Equipment Under Test and Variant Models	-
5	System Setup and Method	-
6	Transmitter Radiated Spurious Emissions ((FCC §15.247(d), §15.209, §15.205; ISED RSS-247§5.5)	Compliant
7	Revision History	-

3 Client Information

This EUT was tested at the request of:

Client: Philips Respironics
1740 Golden Mile Highway
Monroeville, PA 15146
USA

Contact: Jimmy Cheng
Telephone: 724-334-6935
Email: J.Cheng@Philips.com

4 Description of Equipment Under Test and Variant Models

Manufacturer: Philips Respironics
1001 Murry Ridge Lane
Murrysville, PA 15668
USA

Equipment Under Test			
Description	Manufacturer	Model Number	Serial Number
Trilogy Evo Ventilator with OBM	Philips Respironics	Trilogy Evo Ventilator with OBM	HPP1513072E8C
Receive Date:	12/11/2017	Test Started	12/20/2017
Received Condition:	Good	Test Ended	01/08/2018
Type:	Production		

Description of Equipment Under Test (provided by client)

The Trilogy Evo2 Ventilator (Project codename: Helix) provides invasive and non-invasive positive pressure ventilation for the care of newborn (>2.5 kg) through adult patients. The ventilator can measure, display, record, and alarm SpO₂, FiO₂, CO₂, Respiratory Rate, and Heart Rate data when integrated with the appropriate accessories. The ventilator is suitable for use in institutional, home, and transport settings.

The EUT contains a 13.56 MHz NFC transmitter and an FCC and ISED certified transmitter module providing Bluetooth and Wi-Fi functionality.

Equipment Under Test Power Configuration			
Rated Voltage	Rated Current	Rated Frequency	Number of Phases
100 -240 Vac	2.5 A	50 Hz / 60 Hz	1

Operating modes of the EUT:

No.	Descriptions of EUT Exercising
1	Test Mode – Continuously Transmitting

Software used by the EUT:

No.	Descriptions of EUT Exercising
1	Under test mode, the EUT was programmed to transmit continuously during testing.

Radio/Receiver Characteristics	
Frequency Band(s)	2400 – 2483.5 MHz
Modulation Type(s)	(Please refer to the original test report under FCC ID: Z64-WL18SBMOD)
Maximum Output Power	(Please refer to the original test report under FCC ID: Z64-WL18SBMOD)
Test Channels	Lo, Mid, Hi
Occupied Bandwidth	(Please refer to the original test report under FCC ID: Z64-WL18SBMOD)
Frequency Hopper: Number of Hopping Channels	(Please refer to the original test report under FCC ID: Z64-WL18SBMOD)
Frequency Hopper: Channel Dwell Time	(Please refer to the original test report under FCC ID: Z64-WL18SBMOD)
Frequency Hopper: Max interval between two instances of use of the same channel	(Please refer to the original test report under FCC ID: Z64-WL18SBMOD)
MIMO Information (# of Transmit and Receive antenna ports)	Not Applicable
Equipment Type	Standalone
Antenna Type and Gain	Internal PCB Antenna

Variant Models:

The following variant models were not tested as part of this evaluation, but have been identified by the manufacturer as being electrically identical models, depopulated models, or with reasonable similarity to the model(s) tested. Intertek does not make any claims of compliance for samples or variants which were not tested.

Trilogy Evo Ventilator is a base model. Trilogy Evo Ventilator with OBM is a version adding an additional Oxygen Blender module.

The model/Type listed in the following table, in **Bold**, are the variation for the US and Canada markets. The others are wither EU/CE countries or countries with their own radio authorization procedures.

Model No.	Type	Market	Bluetooth	OBM / Muffler	
Homecare w/Muffler					
DS2110X11B	Trilogy Evo Home Ventilator	Domestic / USA	Yes	Muffler	
IN2110X19B		INTL	Yes	Muffler	
IN2110X19		INTL	No	Muffler	
JP2110X16B		Japan	Yes	Muffler	
DE2110X13B		Germany	Yes	Muffler	
AU2110X14B		Australia	Yes	Muffler	
LA2110X19B		Latin American	Yes	Muffler	
CA2110X12B		Canada	Yes	Muffler	
CN2110X17B		China	Yes	Muffler	
BR2110X18B		Brazil	Yes	Muffler	
KR2110X15B		Korea	Yes	Muffler	
PP2110X10B		EU (PP)	Yes	Muffler	
PP2110X10		EU (PP)	No	Muffler	
PP2310X10B		Private Label Evo Home Ventilator	XX (PP)	Yes	Muffler
Stockpile					
DS2000X11B	Trilogy Evo Universal Ventilator	Domestic / USA	Yes	OBM	
Homecare w/OBM					
DS2100X11B	Trilogy Evo2 Home Ventilator	Domestic / USA	Yes	OBM	
IN2100X19B		INTL	Yes	OBM	
IN2100X19		INTL	No	OBM	
JP2100X16B		Japan	Yes	OBM	
DE2100X13B		Germany	Yes	OBM	
AU2100X14B		Australia	Yes	OBM	
LA2100X19B		Latin American	Yes	OBM	
CA2100X12B		Canada	Yes	OBM	
CN2100X17B		China	Yes	OBM	
BR2100X18B		Brazil	Yes	OBM	
KR2100X15B		Korea	Yes	OBM	
Hospital					
DS2200X11B		Trilogy Evo Hospital Ventilator	Domestic / USA	Yes	OBM
IN2200X19B			INTL	Yes	OBM
JP2200X16B	Japan		Yes	OBM	
DE2200X13B	Germany		Yes	OBM	
CA2200X12B	Canada		Yes	OBM	
CN2200X17B	China		Yes	OBM	
BR2200X18B	Brazil		Yes	OBM	
KR2200X15B	Korea		Yes	OBM	

Model/Type Reference:

5 System Setup and Method

Cables					
ID	Description	Length (m)	Shielding	Ferrites	Termination
1	Capnostat Cable with attached eTCO2 adaptor. USB connector	3.4	Yes	Yes	Yes
2	USB Pulse Oximeter Cable with attached Pulse Oximeter. USB connector	2.2	Yes	Yes	Yes
3	EFS Cable. Circular connector (Vent side), pogo pins to sensor (other end)	2.5	No	Yes	Yes
4	Remote Alarm Cable. Phone jack	61	No	No	Yes
5	DC Power Cable. Circular connector (Vent side), ring terminals (other end)	1.8	No	No	Yes
6	AC Line Cord	4.3	No	No	Yes

Support Equipment			
Description	Manufacturer	Model Number	Serial Number
BT Eval board:	Silicon Labs	EBWT12-K	161920
Laptop	Lenovo	80UD	MP147DKQ

5.1 Method:

Configuration as required by ANSI C63.10-2013 and FCC KDB 558074 D01 v04.

5.2 Test Setup Block Diagram:

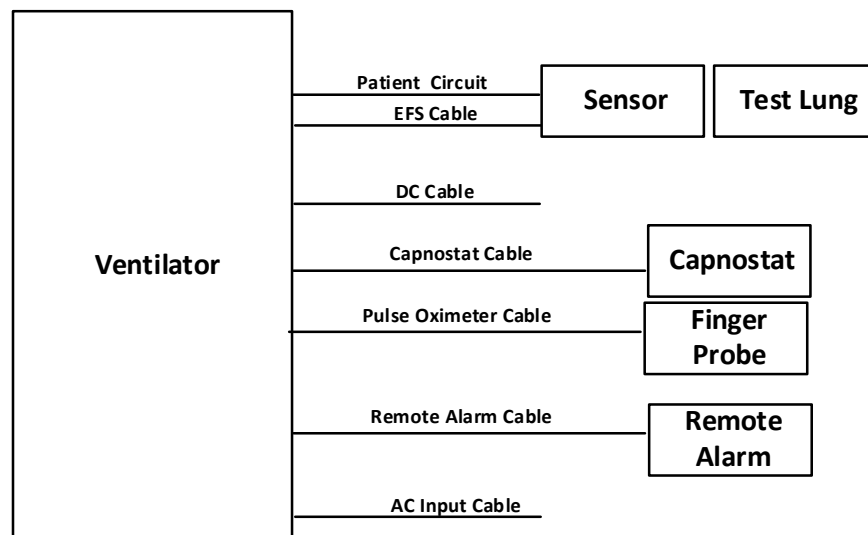

6 Transmitter Radiated Spurious Emissions

6.1 Method

Tests are performed in accordance with ANSI C63.10-2013 and FCC KDB D01 v04.

EUT was configured to transmit continuously. Radiated emission measurements were performed from 30 MHz to 25 GHz according to the procedure described in ANSI C64.10. Spectrum analyzer resolution bandwidth is 120 kHz for frequencies 30 MHz to 1000 MHz. Above 1 GHz, both Peak and Average measurements were performed. The peak level of radiated emissions was measured with a resolution bandwidth (RBW) of 1 MHz, a video bandwidth (VBW) of 3 MHz, and a Peak detector. The average level of radiated emissions was measured with a resolution bandwidth (RBW) of 1 MHz, a video bandwidth (VBW) of 3 MHz, and a RMS detector with trace averaging.

The EUT is placed on a plastic turntable that is 80 cm in height for frequencies 30 MHz to 1000 MHz, 1.5 meters for frequency above 1000 MHz. If the EUT attaches to peripherals, they are connected and operational (as typical as possible). During testing, all cables were manipulated to produce worst-case emissions. The signal is maximized through rotation. The antenna height and polarization are varied during the search for maximum signal level. The antenna height is varied from 1 to 4 meters.

Radiated emissions are taken at 3 meters for frequencies below 18 GHz and 1 meter for frequencies above 18 GHz.

Data included is representative of the worst-case configuration (the configuration which resulted in the highest emission levels). Plots below are corrected for distance, cables, preamp, filters and antenna factors then compared to the limits.

TEST SITE:

The test is performed in the 3 meter semi-anechoic chamber located at 25791 Commercentre Drive, Lake Forest, California 92630 USA. This test facility meets the requirements of CISPR 16-1-4 and has been accredited by A2LA. IC test site registration number is 2042T.

Measurement Uncertainty

Measurement	Frequency Range	Expanded Uncertainty (k=2)	U _{cispr}
Radiated Emissions, 3m	30-1000 MHz	4.3	6.3 dB
Radiated Emissions, 3m	1-18 GHz	5.5	5.2 dB
Radiated Emissions, 1m	18-26.5 GHz	4.5	5.5 dB

As shown in the table above our radiated emissions U_{lab} is less than the corresponding U_{CISPR} reference value in CISPR 16-4-2 Table 1, hence the compliance of the product is only based on the measured value, and no measurement uncertainty correction is required, based on CISPR 22 and CISPR 11 (for 2006 and later revisions) Clause 11.

Sample Calculation

The field strength is calculated by adding the Antenna Factor and Cable Factor, and subtracting the Amplifier Gain (if any) from the measured reading. The basic equation with a sample calculation is as follows:

$$FS = RA + AF + CF - AG$$

Where

- FS = Field Strength in dB μ V/m
- RA = Receiver Amplitude (including preamplifier) in dB μ V
- CF = Cable Attenuation Factor in dB
- AF = Antenna Factor in dB
- AG = Amplifier Gain in dB

In the following table(s), the reading shown on the data table reflects the preamplifier gain. An example for the calculations in the following table is as follows.

Assume a receiver reading of 52.0 dB μ V is obtained. The antenna factor of 7.4 dB and cable factor of 1.6 dB is added. The amplifier gain of 29 dB is subtracted, giving a field strength of 32 dB μ V/m. This value in dB μ V/m was converted to its corresponding level in μ V/m.

RA = 52.0 dB μ V
AF = 7.4 dB/m
CF = 1.6 dB
AG = 29.0 dB
FS = 32 dB μ V/m

To convert from dB μ V to μ V or mV the following was used:

$UF = 10^{(NF / 20)}$ where UF = Net Reading in μ V
NF = Net Reading in dB μ V

Example:

$FS = RA + AF + CF - AG = 52.0 + 7.4 + 1.6 - 29.0 = 32.0$
 $UF = 10^{(32 \text{ dB}\mu\text{V} / 20)} = 39.8 \mu\text{V/m}$

6.2 Test Equipment Used:

Asset	Description	Manufacturer	Model	Serial	Cal Date	Cal Due
637	3m Semi-anechoic Chamber	Panashield	3 meter	25 331-D-Z	December 2015	December 2018
1669	EMI Test Receiver	R&S	ESW44	101636	07/14/2017	07/14/2018
1140	EMI Test Receiver	R&S	ESCI7	100825	02/21/2017	02/21/2018
1147	Bilog Antenna	TESEQ Gmbh	CBL 6112D	32852	11/16/2017	11/16/2018
1568	Pre-amp	Rhode & Schwarz	TS-PR1	102061	12/28/2016	12/28/2017
1556	Pre-amp	Rhode & Schwarz	TS-PR18	102144	07/29/2017	07/29/2018
1557	Pre-amp	Rhode & Schwarz	TS-PR1840	100054	07/29/2017	07/29/2018
1515	Horn Antenna	ETS-Lindgren	3115	00161631	03/15/2017	03/15/2018
1517	Cable	R&S	TSPR-B7	101528	07/13/2017	07/13/2018
1518	Cable	R&S	TSPR-B7	101529	07/13/2017	07/13/2018
1002	Barometer Temp/Humidity	Omega	IBTHX-W	0440776	01/22/2017	01/22/2018

Software Utilized:

Name	Manufacturer	Version	Profile
Tile	Quantum Change	4.1	FCC 30 to 1000 FCC Part 15 1-18GHz

6.3 Results:

The sample tested was found to Comply.

6.4 Setup Diagram:

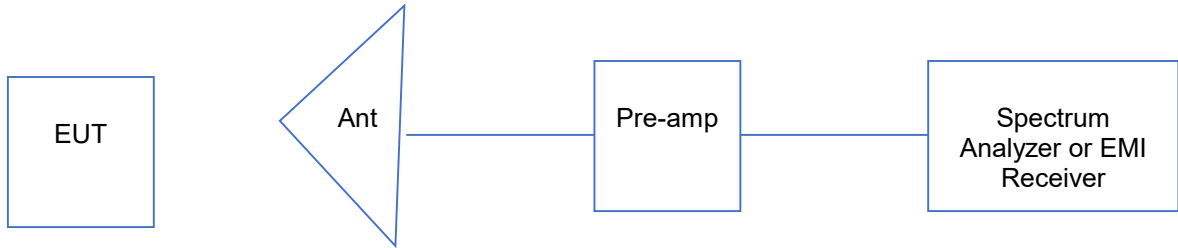

6.5 Plots/Data:

30 – 1000 MHz

802.11b Low channel:

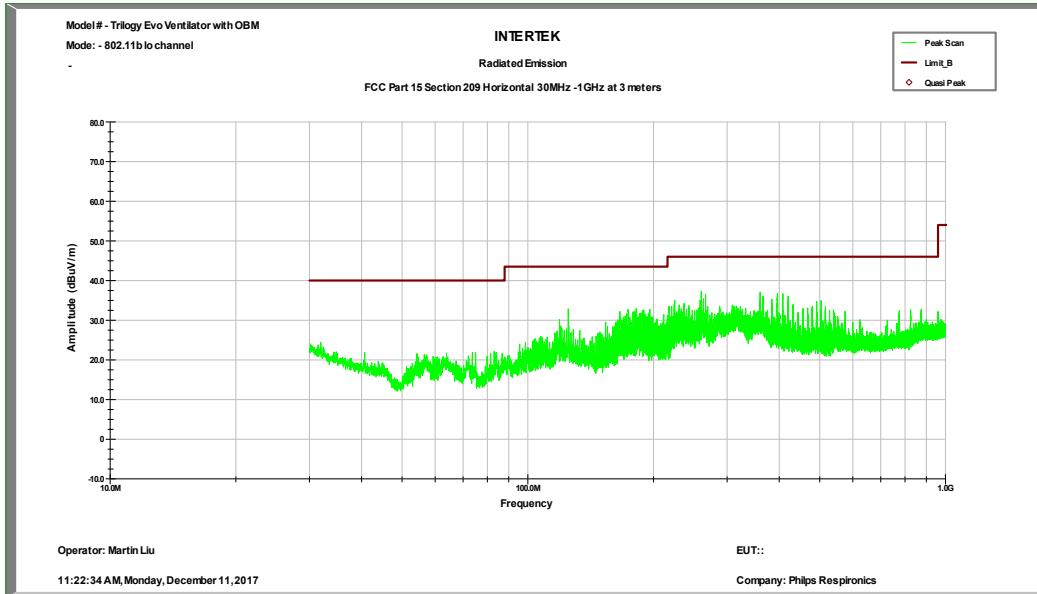

Horizontal Scan

Frequency MHz	Peak FS dB(uV/m)	Limit@3m dB(uV/m)	Margin dB	RA dB	AG dB	AF dB	CF dB
260.1	37.3	46.0	-8.7	44.3	29.6	20.4	2.2
266.5	36.5	46.0	-9.5	44.6	29.6	19.3	2.2
360.0	37.1	46.0	-8.9	43.7	29.7	20.9	2.2
396.3	36.7	46.0	-9.3	42.5	29.7	21.6	2.3
408.0	36.6	46.0	-9.4	41.8	29.8	22.3	2.3
420.0	36.0	46.0	-10.0	40.8	29.8	22.7	2.4

30 – 1000 MHz

802.11b Low channel:

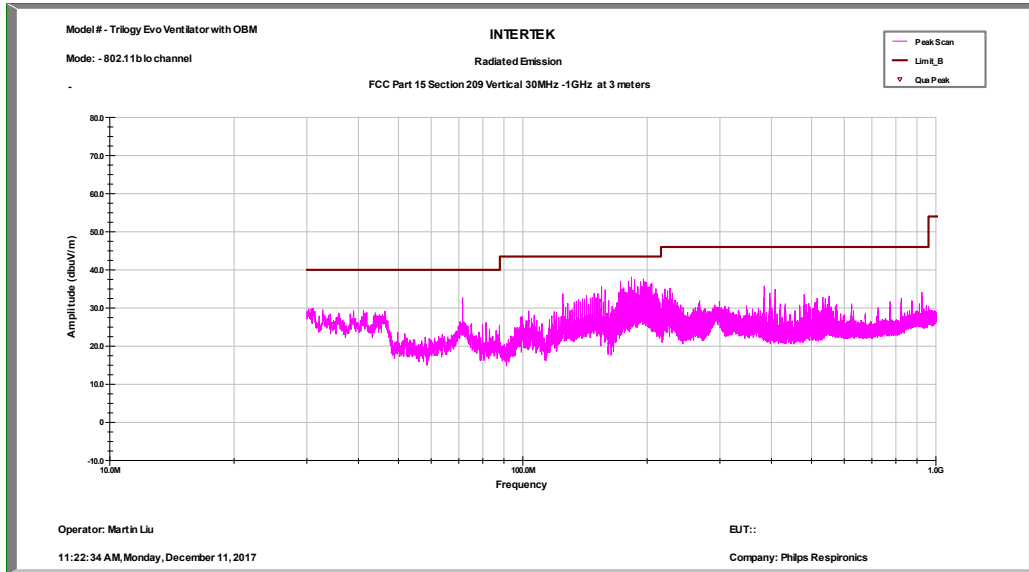

Vertical Scan

Frequency MHz	Peak FS dB(uV/m)	Limit@3m dB(uV/m)	Margin dB	RA dB	AG dB	AF dB	CF dB
172.4	37.0	43.5	-6.5	49.1	29.9	15.6	2.2
180.2	37.1	43.5	-6.4	49.4	29.7	15.2	2.2
183.3	38.1	43.5	-5.4	50.6	29.7	15.1	2.1
186.5	37.5	43.5	-6.0	50.1	29.7	15.0	2.1
195.9	37.6	43.5	-5.9	49.9	29.6	15.2	2.1
197.5	36.9	43.5	-6.6	49.3	29.8	15.3	2.1

30 – 1000 MHz

802.11b Middle channel:

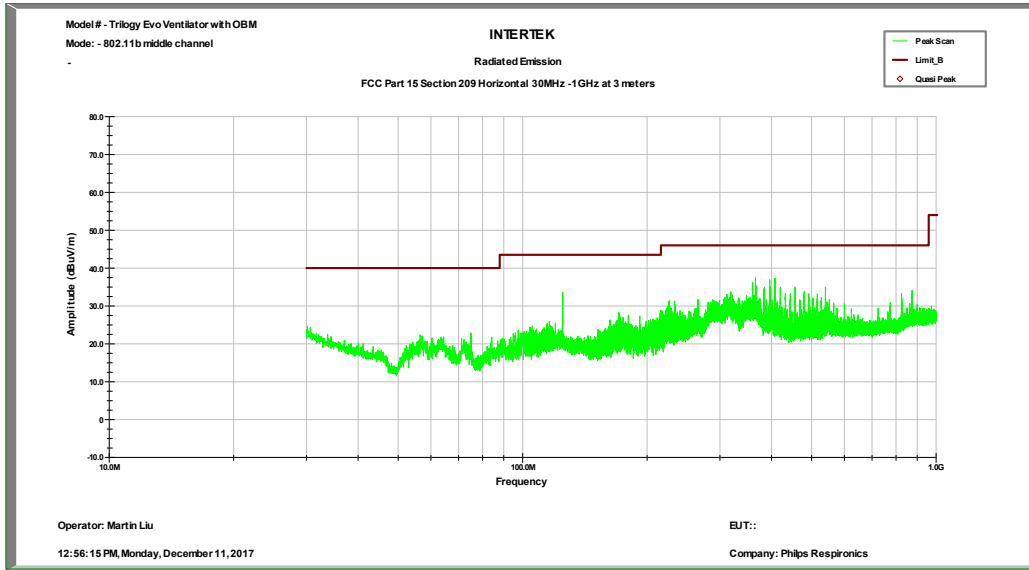

Horizontal Scan

Frequency MHz	Peak FS dB(uV/m)	Limit@3m dB(uV/m)	Margin dB	RA dB	AG dB	AF dB	CF dB
360.0	36.2	46.0	-9.8	42.8	29.7	20.9	2.2
365.7	37.6	46.0	-8.4	44.1	29.7	21.0	2.2
366.6	35.3	46.0	-10.7	41.9	29.7	20.9	2.2
395.9	36.9	46.0	-9.1	42.8	29.7	21.6	2.3
407.8	37.2	46.0	-8.8	42.4	29.7	22.3	2.3
455.5	35.0	46.0	-11.0	39.6	29.8	22.8	2.4

30 – 1000 MHz

802.11b Middle channel:

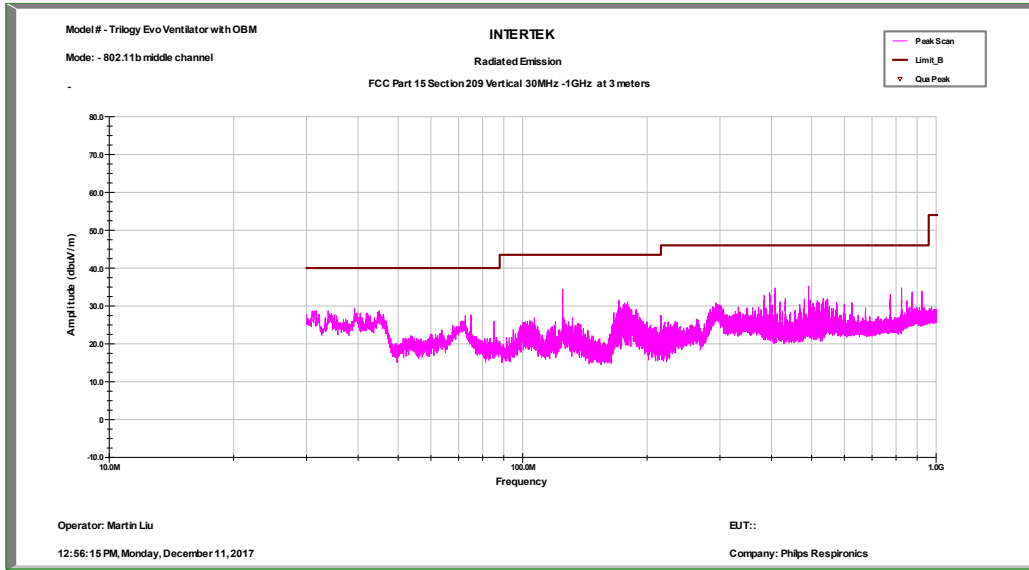

Vertical Scan

Frequency MHz	Peak FS dB(uV/m)	Limit@3m dB(uV/m)	Margin dB	RA dB	AG dB	AF dB	CF dB
125.0	34.5	43.5	-9.1	43.6	30.0	18.2	2.7
408.0	34.7	46.0	-11.3	39.8	29.7	22.3	2.3
491.7	35.2	46.0	-10.8	39.3	29.9	23.4	2.4
825.0	34.7	46.0	-11.3	35.8	29.7	26.0	2.6
874.9	33.7	46.0	-12.3	33.5	29.2	26.7	2.7
925.0	33.9	46.0	-12.1	33.9	29.3	26.7	2.7

30 – 1000 MHz

802.11b High channel:

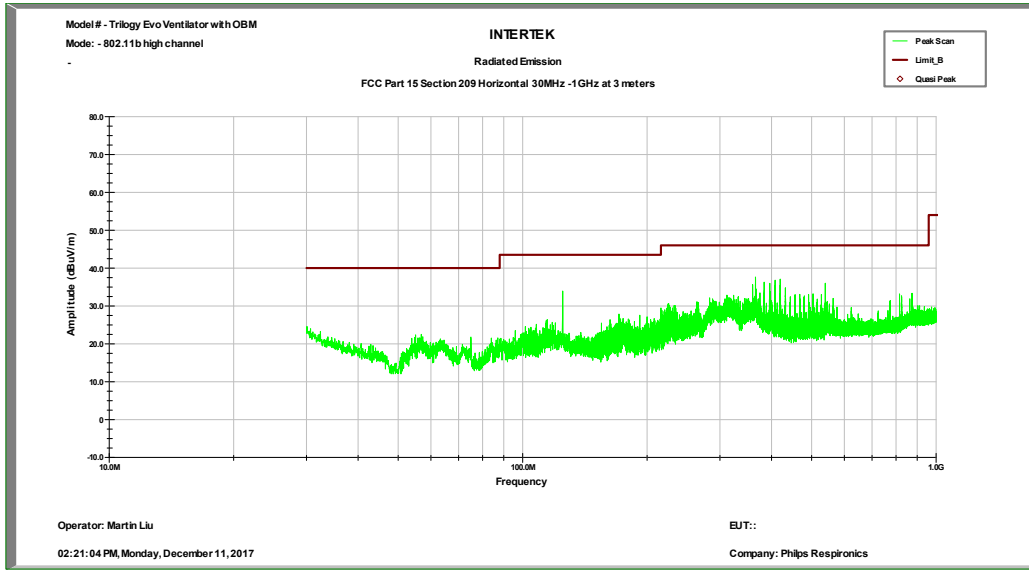

Horizontal Scan

Frequency MHz	Peak FS dB(uV/m)	Limit@3m dB(uV/m)	Margin dB	RA dB	AG dB	AF dB	CF dB
365.8	37.6	46.0	-8.4	44.2	29.7	21.0	2.2
383.9	36.3	46.0	-9.7	42.6	29.7	21.1	2.2
396.0	36.0	46.0	-10.0	41.8	29.7	21.6	2.3
407.9	36.8	46.0	-9.2	41.9	29.7	22.3	2.3
419.8	37.1	46.0	-8.9	41.8	29.8	22.7	2.4
539.5	36.0	46.0	-10.0	39.0	30.0	24.5	2.5

30 – 1000 MHz

802.11b High channel:

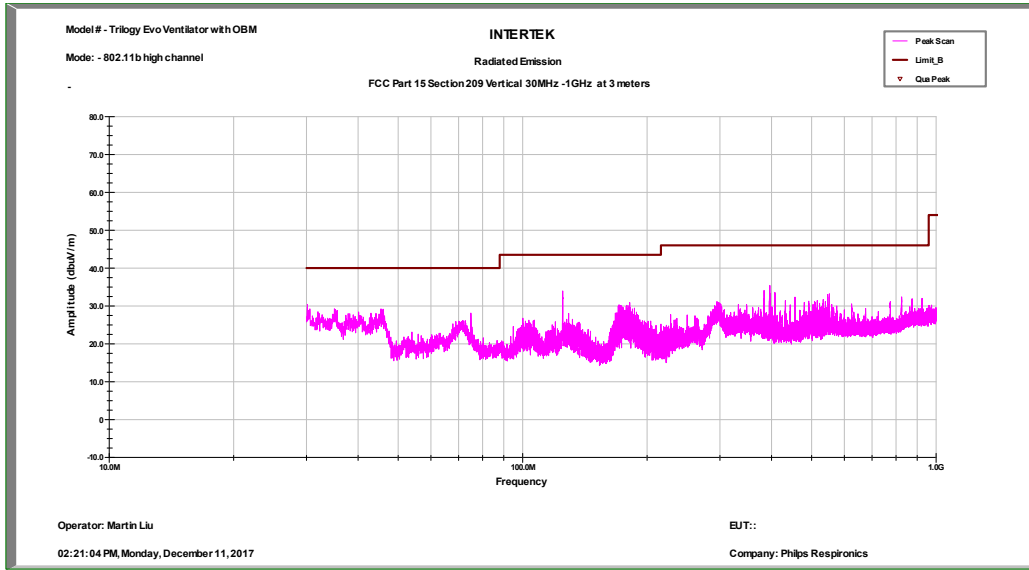

Vertical Scan

Frequency MHz	Peak FS dB(uV/m)	Limit@3m dB(uV/m)	Margin dB	RA dB	AG dB	AF dB	CF dB
125.0	34.0	43.5	-9.5	43.1	30.0	18.2	2.7
383.7	34.1	46.0	-11.9	40.5	29.7	21.1	2.2
396.2	35.4	46.0	-10.6	41.2	29.7	21.6	2.3
407.5	33.6	46.0	-12.4	38.7	29.7	22.3	2.3
546.7	33.0	46.0	-13.0	35.4	30.0	25.1	2.5
551.8	33.2	46.0	-12.8	35.7	30.0	25.0	2.5

30 – 1000 MHz

802.11g Low channel:

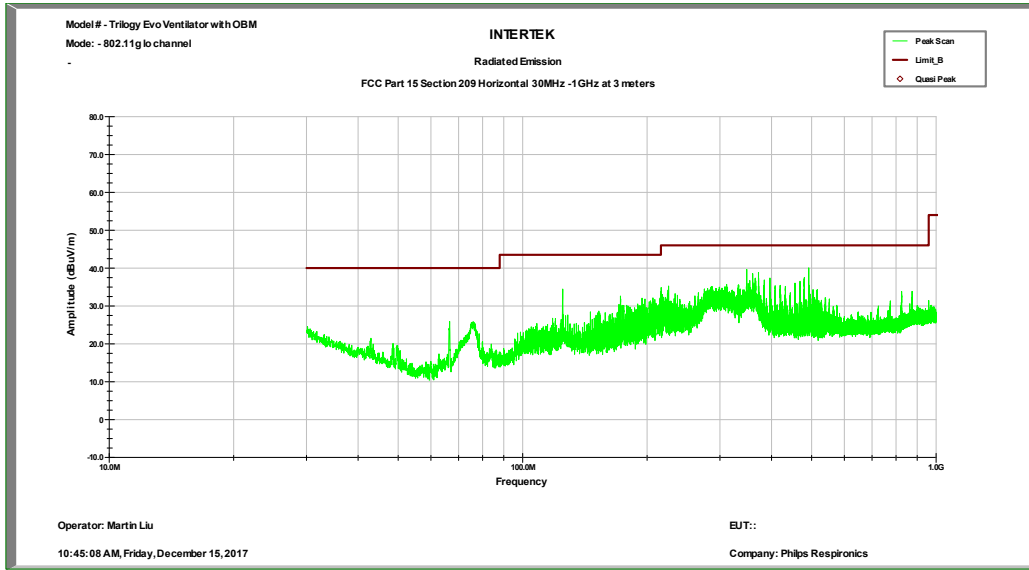

Horizontal Scan

Frequency MHz	Peak FS dB(uV/m)	Limit@3m dB(uV/m)	Margin dB	RA dB	AG dB	AF dB	CF dB
348.3	39.6	46.0	-6.4	46.7	29.6	20.3	2.2
359.8	38.5	46.0	-7.5	45.1	29.7	20.9	2.2
365.3	37.3	46.0	-8.7	43.8	29.7	21.0	2.2
372.0	38.8	46.0	-7.2	45.5	29.7	20.9	2.2
480.0	37.4	46.0	-8.6	41.5	29.9	23.4	2.4
492.0	40.0	46.0	-6.0	44.1	29.8	23.4	2.4

30 – 1000 MHz

802.11g Low channel:

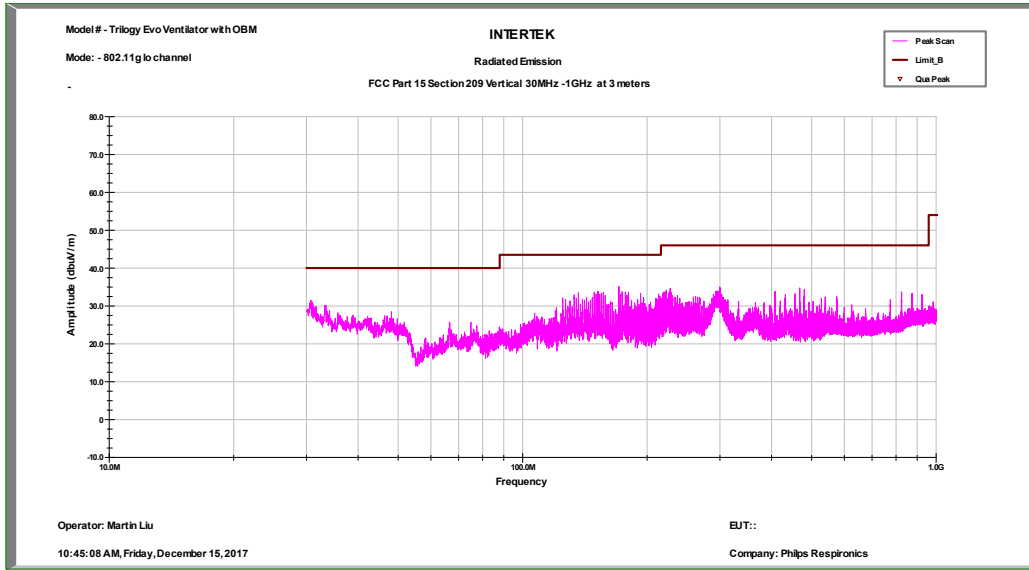

Vertical Scan

Frequency MHz	Peak FS dB(uV/m)	Limit@3m dB(uV/m)	Margin dB	RA dB	AG dB	AF dB	CF dB
171.0	35.1	43.5	-8.4	47.1	29.8	15.6	2.2
222.7	34.2	46.0	-11.8	46.4	29.7	15.5	2.0
227.5	34.7	46.0	-11.3	46.5	29.7	15.9	2.0
299.7	35.0	46.0	-11.0	43.2	29.6	19.2	2.2
468.0	34.7	46.0	-11.3	39.2	29.9	23.0	2.4
480.0	34.3	46.0	-11.7	38.4	29.9	23.4	2.4

30 – 1000 MHz

802.11g Middle channel:

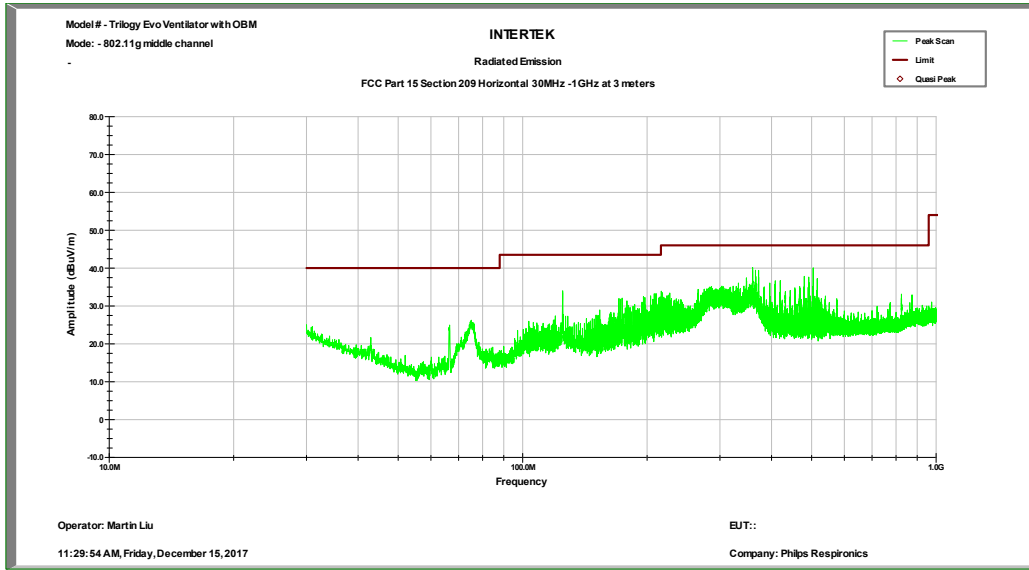

Horizontal Scan

Frequency MHz	Peak FS dB(uV/m)	Limit@3m dB(uV/m)	Margin dB	RA dB	AG dB	AF dB	CF dB
360.0	40.1	46.0	-5.9	46.7	29.7	20.9	2.2
365.7	39.4	46.0	-6.6	45.9	29.7	21.0	2.2
366.4	37.7	46.0	-8.3	44.3	29.7	21.0	2.2
372.2	39.4	46.0	-6.6	46.0	29.7	20.9	2.2
480.0	37.8	46.0	-8.2	41.9	29.9	23.4	2.4
504.4	40.0	46.0	-6.0	44.1	29.9	23.4	2.4

30 – 1000 MHz

802.11g Middle channel:

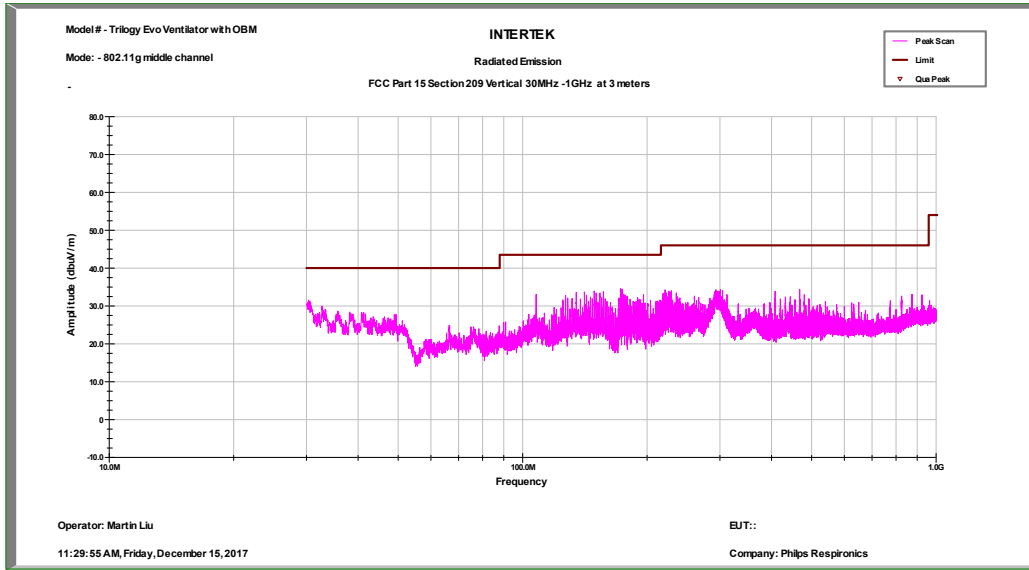

Vertical Scan

Frequency MHz	Peak FS dB(uV/m)	Limit@3m dB(uV/m)	Margin dB	RA dB	AG dB	AF dB	CF dB
172.5	34.7	43.5	-8.8	46.7	29.9	15.6	2.2
174.0	34.4	43.5	-9.1	46.5	29.7	15.5	2.2
221.1	34.3	46.0	-11.7	46.6	29.7	15.3	2.0
300.8	34.3	46.0	-11.7	42.4	29.5	19.2	2.2
304.5	34.1	46.0	-11.9	42.2	29.7	19.3	2.2
467.8	34.3	46.0	-11.7	38.8	29.9	23.0	2.4

30 – 1000 MHz

802.11g High channel:

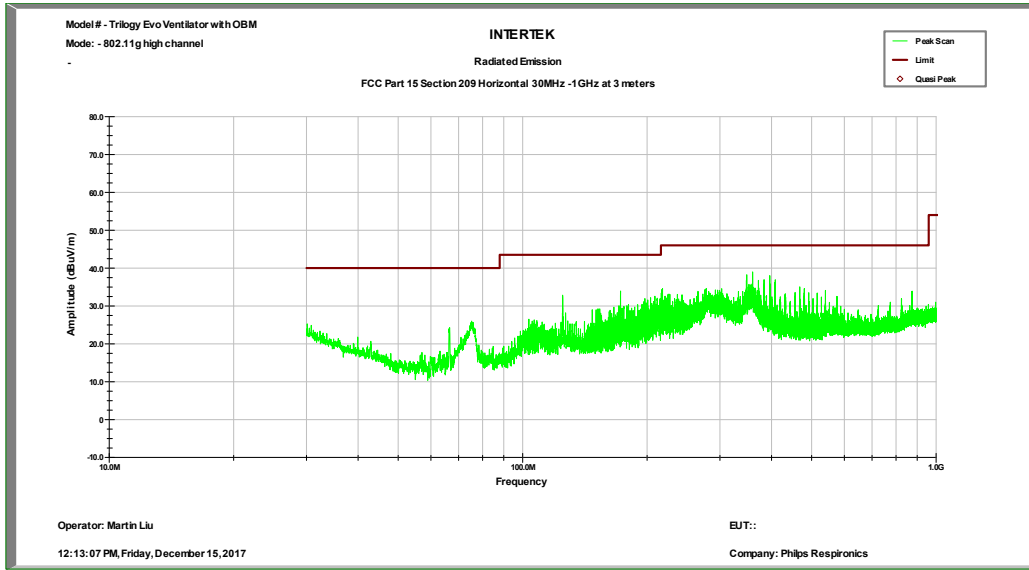

Horizontal Scan

Frequency MHz	Peak FS dB(uV/m)	Limit@3m dB(uV/m)	Margin dB	RA dB	AG dB	AF dB	CF dB
348.4	38.2	46.0	-7.8	45.4	29.6	20.3	2.2
360.0	39.0	46.0	-7.0	45.6	29.7	20.9	2.2
371.8	36.8	46.0	-9.2	43.4	29.7	20.9	2.2
383.7	36.9	46.0	-9.1	43.3	29.7	21.1	2.2
396.1	38.0	46.0	-8.0	43.8	29.7	21.6	2.3
408.3	36.9	46.0	-9.1	42.0	29.8	22.3	2.3

30 – 1000 MHz

802.11g High channel:

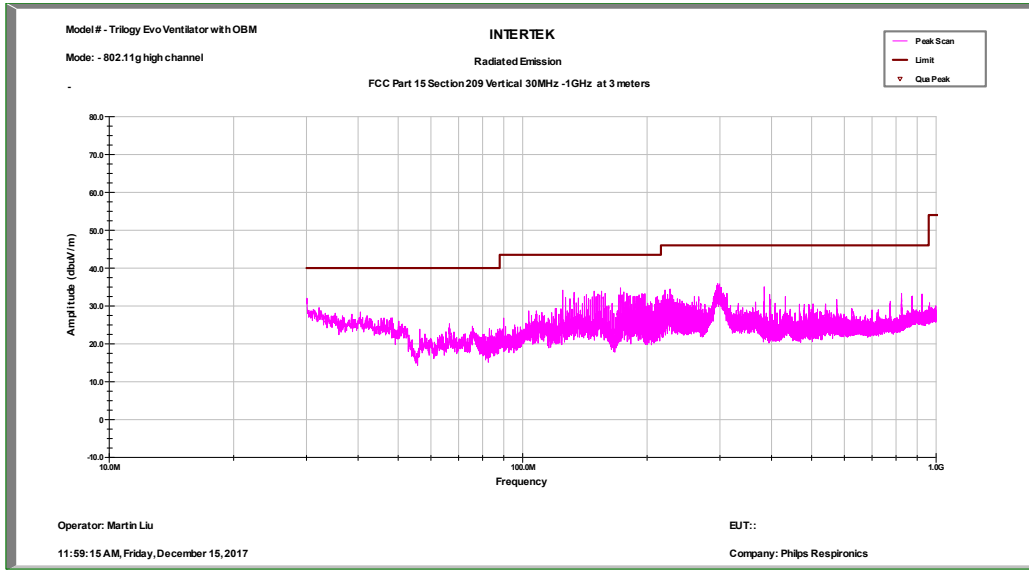

Vertical Scan

Frequency MHz	Peak FS dB(uV/m)	Limit@3m dB(uV/m)	Margin dB	RA dB	AG dB	AF dB	CF dB
125.0	34.2	43.5	-9.3	43.3	30.0	18.2	2.7
172.5	34.8	43.5	-8.7	46.8	29.9	15.6	2.2
221.0	34.2	46.0	-11.8	46.6	29.7	15.3	2.0
227.3	34.4	46.0	-11.6	46.3	29.7	15.9	2.0
296.4	35.9	46.0	-10.1	44.2	29.7	19.1	2.2
384.1	35.1	46.0	-10.9	41.4	29.7	21.1	2.2

30 – 1000 MHz

802.11n Low channel:

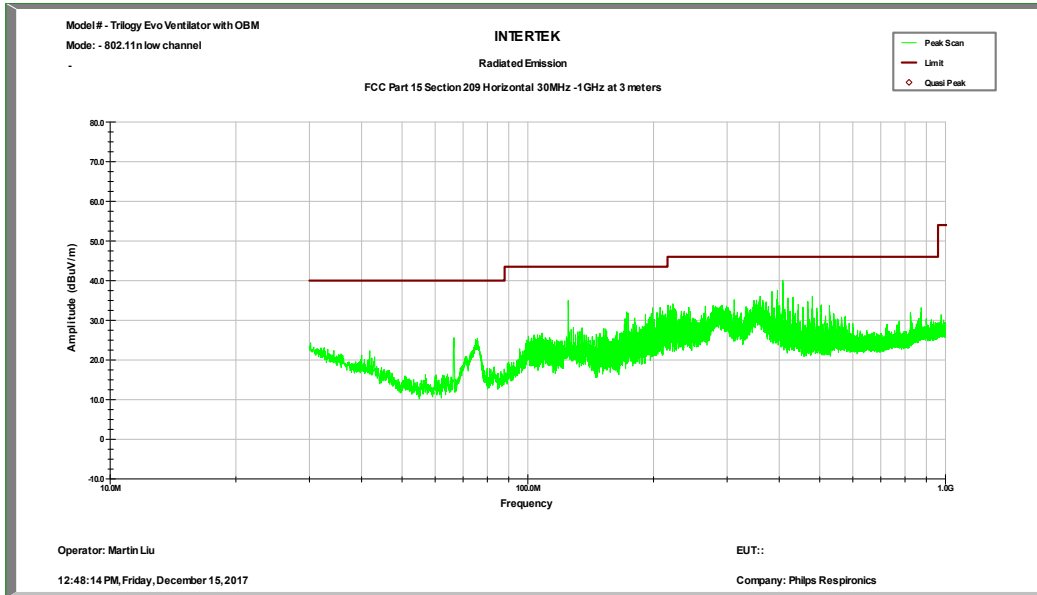

Horizontal Scan

Frequency MHz	Peak FS dB(uV/m)	Limit@3m dB(uV/m)	Margin dB	RA dB	AG dB	AF dB	CF dB
360.0	36.0	46.0	-10.0	42.6	29.7	20.9	2.2
384.3	37.3	46.0	-8.7	43.6	29.7	21.1	2.2
396.1	37.4	46.0	-8.6	43.2	29.7	21.6	2.3
408.0	40.0	46.0	-6.0	45.2	29.7	22.3	2.3
432.0	35.8	46.0	-10.2	40.7	29.8	22.5	2.4
480.1	36.0	46.0	-10.0	40.1	29.9	23.4	2.4

30 – 1000 MHz

802.11n Low channel:

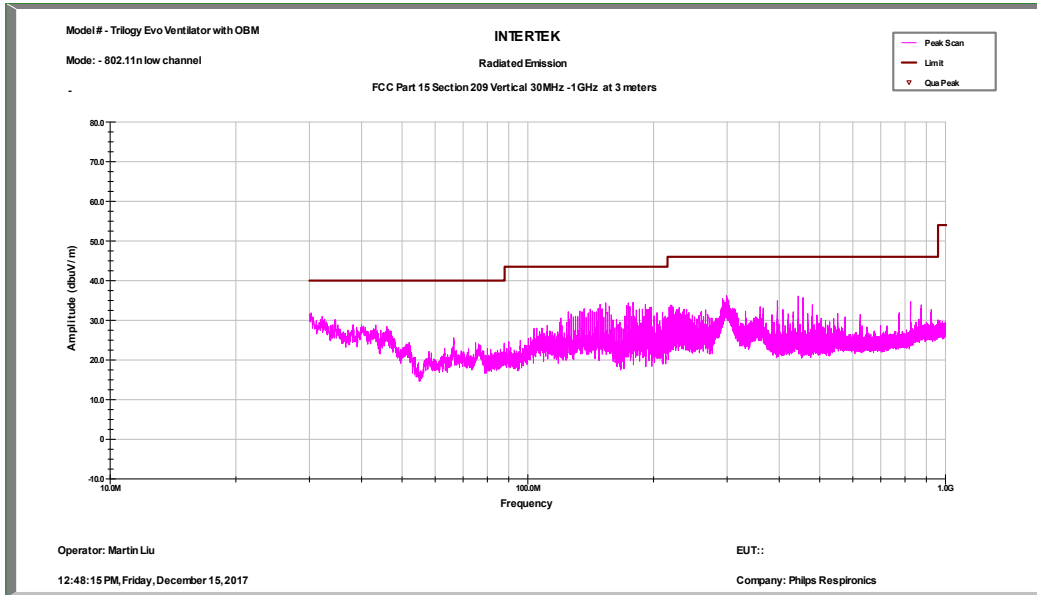

Vertical Scan

Frequency	Peak FS	Limit@3m	Margin	RA	AG	AF	CF
MHz	dB(uV/m)	dB(uV/m)	dB	dB	dB	dB	dB
292.6	35.5	46.0	-10.5	43.9	29.6	19.0	2.2
299.0	36.2	46.0	-9.8	44.3	29.6	19.2	2.2
396.0	34.9	46.0	-11.1	40.7	29.7	21.6	2.3
443.9	36.1	46.0	-9.9	41.0	29.8	22.6	2.4
456.1	35.7	46.0	-10.3	40.3	29.8	22.8	2.4
825.0	34.6	46.0	-11.4	35.7	29.7	26.0	2.6

30 – 1000 MHz

802.11n Middle channel:

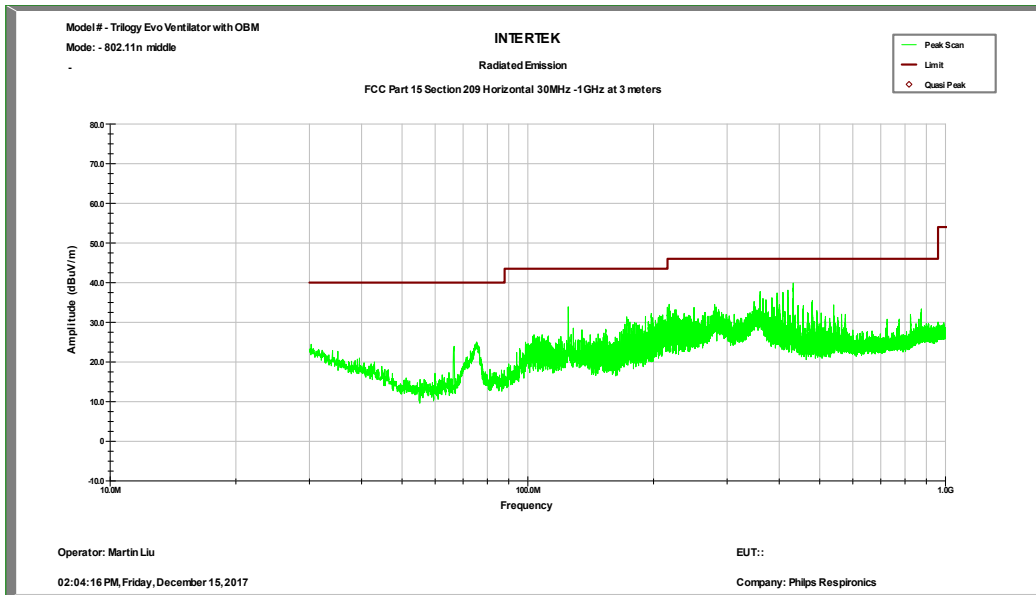

Horizontal Scan

Frequency MHz	Peak FS dB(uV/m)	Limit@3m dB(uV/m)	Margin dB	RA dB	AG dB	AF dB	CF dB
359.9	37.7	46.0	-8.3	44.3	29.7	20.9	2.2
395.3	37.4	46.0	-8.6	43.3	29.7	21.6	2.3
395.5	36.4	46.0	-9.6	42.3	29.7	21.6	2.3
408.2	37.5	46.0	-8.5	42.7	29.8	22.3	2.3
419.6	38.1	46.0	-7.9	42.8	29.8	22.7	2.4
431.9	39.9	46.0	-6.1	44.8	29.8	22.5	2.4

30 – 1000 MHz

802.11n Middle channel:

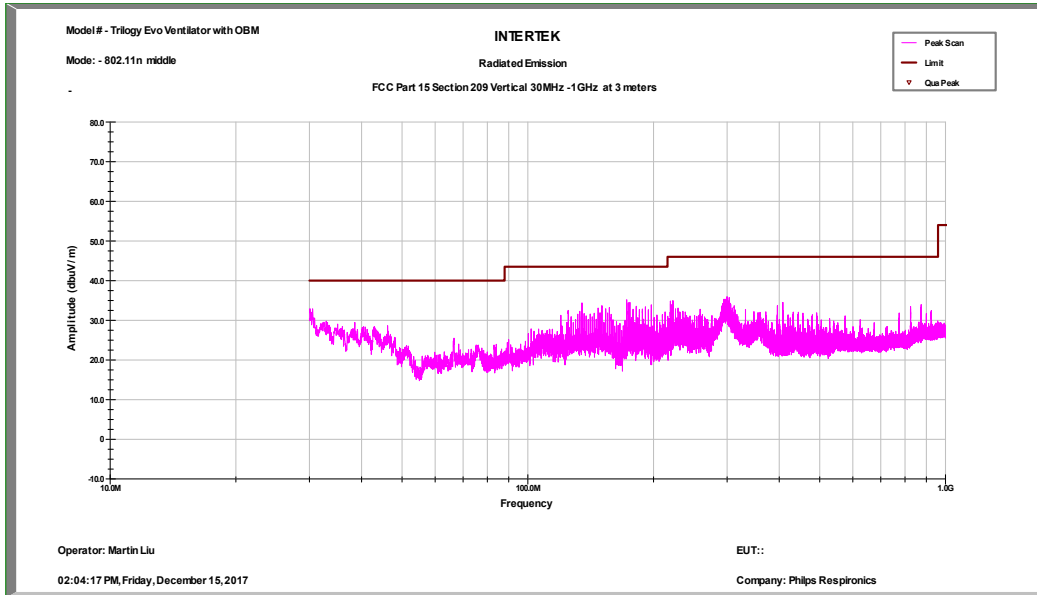

Vertical Scan

Frequency	Peak FS	Limit@3m	Margin	RA	AG	AF	CF
MHz	dB(uV/m)	dB(uV/m)	dB	dB	dB	dB	dB
172.5	35.2	43.5	-8.3	47.2	29.9	15.6	2.2
219.5	34.9	46.0	-11.1	47.3	29.7	15.2	2.0
222.6	35.0	46.0	-11.0	47.2	29.7	15.5	2.0
295.1	35.3	46.0	-10.7	43.7	29.7	19.1	2.2
299.9	36.0	46.0	-10.0	44.1	29.6	19.2	2.2
303.5	35.7	46.0	-10.3	43.8	29.6	19.3	2.2

30 – 1000 MHz

802.11n High channel:

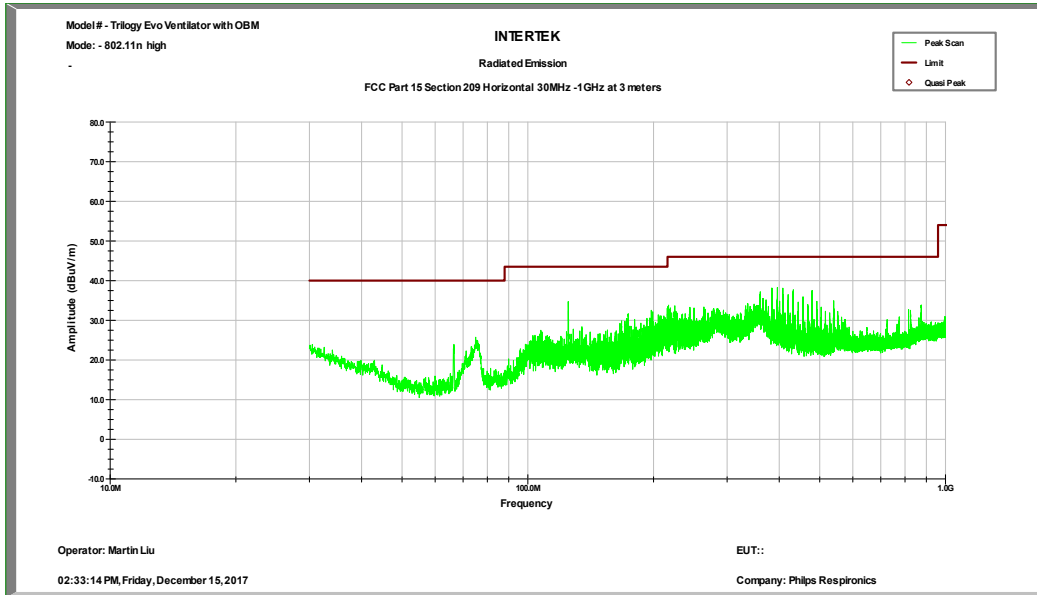

Horizontal Scan

Frequency MHz	Peak FS dB(uV/m)	Limit@3m dB(uV/m)	Margin dB	RA dB	AG dB	AF dB	CF dB
384.1	38.1	46.0	-7.9	44.5	29.7	21.1	2.2
395.9	38.3	46.0	-7.7	44.1	29.7	21.6	2.3
408.0	38.1	46.0	-7.9	43.2	29.7	22.3	2.3
432.1	37.7	46.0	-8.3	42.6	29.8	22.5	2.4
479.2	37.5	46.0	-8.5	41.6	29.8	23.3	2.4
479.8	37.3	46.0	-8.7	41.4	29.9	23.4	2.4

30 – 1000 MHz

802.11n High channel:

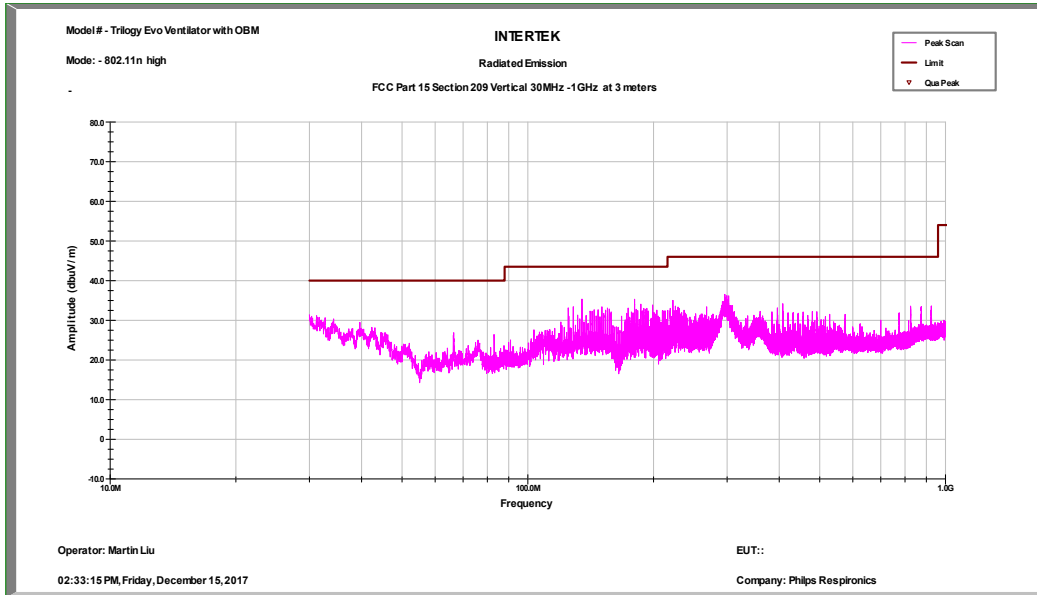

Vertical Scan

Frequency MHz	Peak FS dB(uV/m)	Limit@3m dB(uV/m)	Margin dB	RA dB	AG dB	AF dB	CF dB
134.8	35.4	43.5	-8.1	45.0	30.0	17.7	2.6
180.1	35.3	43.5	-8.2	47.7	29.7	15.2	2.2
222.5	35.0	46.0	-11.0	47.2	29.7	15.5	2.0
296.4	36.5	46.0	-9.5	44.8	29.7	19.1	2.2
302.7	36.2	46.0	-9.9	44.2	29.6	19.3	2.2
407.9	34.1	46.0	-11.9	39.3	29.7	22.3	2.3

30 – 1000 MHz

BT V3.0 Low channel:

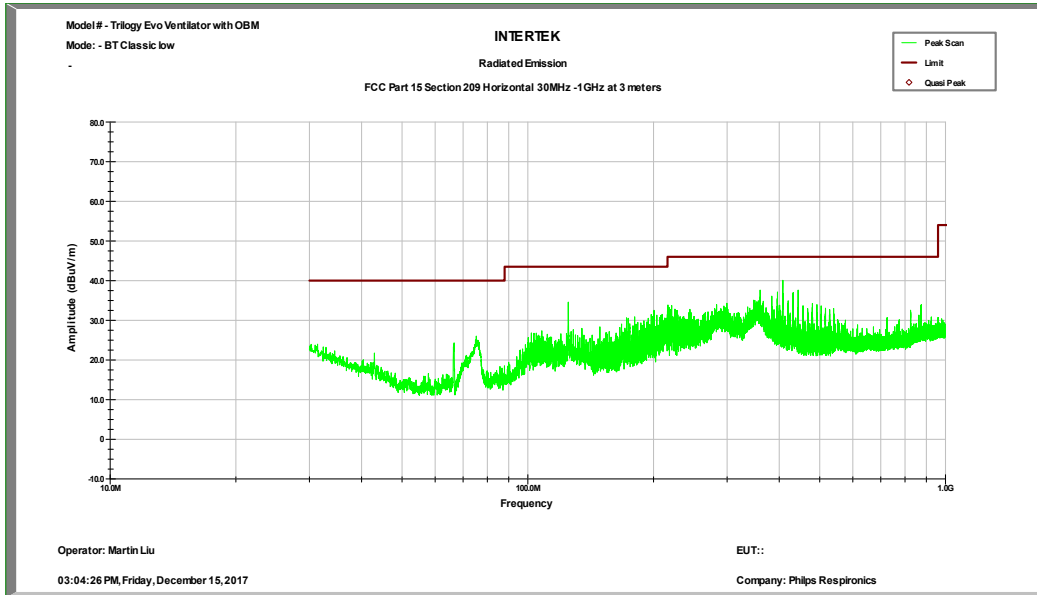

Horizontal Scan

Frequency MHz	Peak FS dB(uV/m)	Limit@3m dB(uV/m)	Margin dB	RA dB	AG dB	AF dB	CF dB
360.0	37.6	46.0	-8.4	44.2	29.7	20.9	2.2
383.9	36.1	46.0	-9.9	42.5	29.7	21.1	2.2
396.0	37.1	46.0	-8.9	42.9	29.7	21.6	2.3
408.0	40.1	46.0	-5.9	45.2	29.7	22.3	2.3
432.1	36.9	46.0	-9.1	41.9	29.8	22.5	2.4
443.9	37.6	46.0	-8.4	42.4	29.8	22.6	2.4

30 – 1000 MHz

BT V3.0 Low channel:

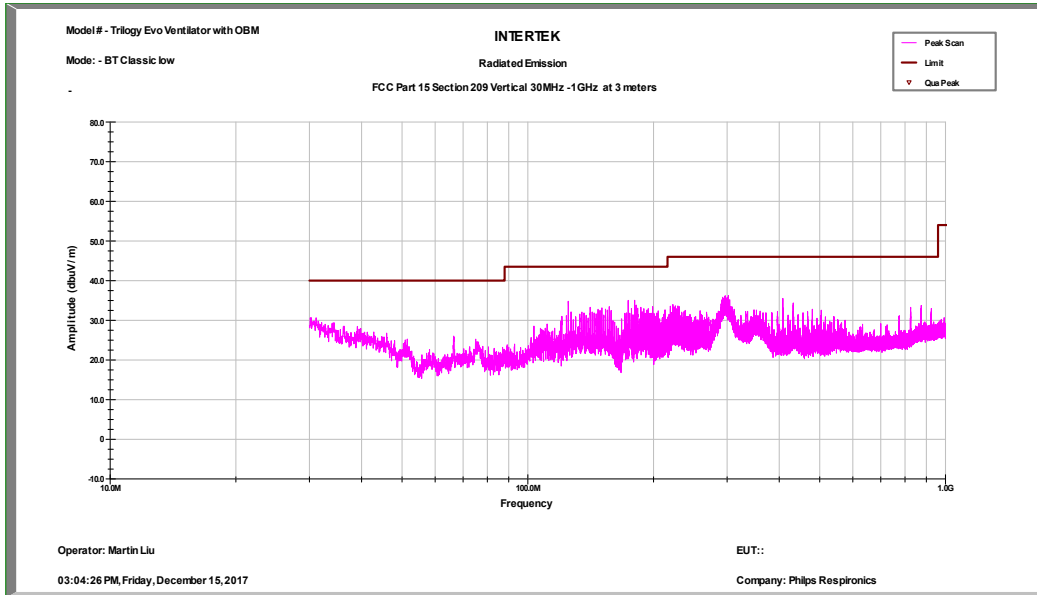

Vertical Scan

Frequency MHz	Peak FS dB(uV/m)	Limit@3m dB(uV/m)	Margin dB	RA dB	AG dB	AF dB	CF dB
125.0	34.8	43.5	-8.7	44.0	30.0	18.2	2.7
174.0	35.0	43.5	-8.5	47.1	29.7	15.5	2.2
180.2	35.0	43.5	-8.5	47.4	29.7	15.2	2.2
296.9	36.2	46.0	-9.8	44.4	29.6	19.1	2.2
302.0	36.2	46.0	-9.8	44.3	29.6	19.2	2.2
407.9	35.5	46.0	-10.5	40.6	29.7	22.3	2.3

30 – 1000 MHz

BT V3.0 Middle channel:

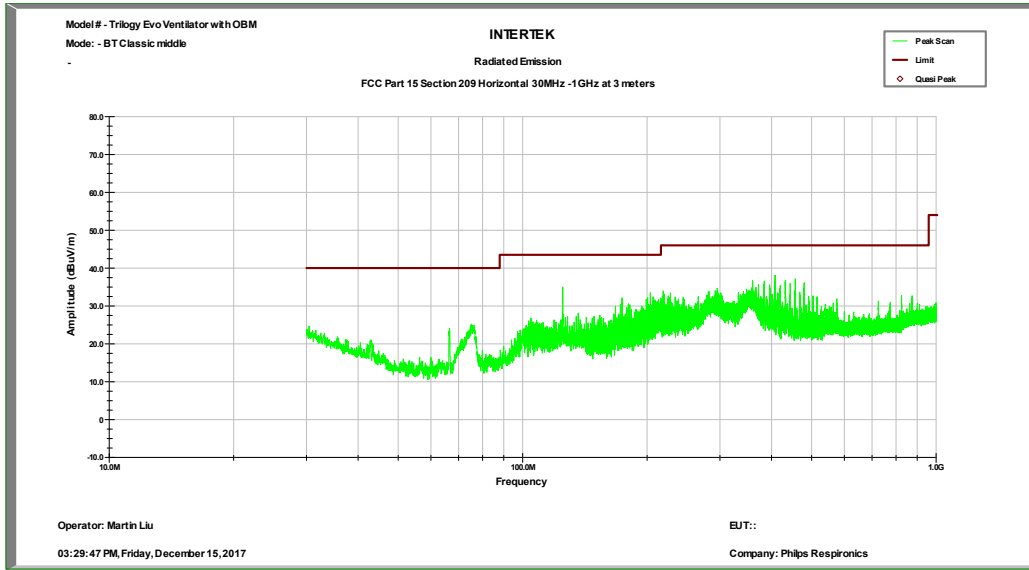

Horizontal Scan

Frequency MHz	Peak FS dB(uV/m)	Limit@3m dB(uV/m)	Margin dB	RA dB	AG dB	AF dB	CF dB
360.0	36.6	46.0	-9.4	43.2	29.7	20.9	2.2
384.1	36.5	46.0	-9.5	42.9	29.7	21.1	2.2
408.0	38.1	46.0	-7.9	43.2	29.8	22.3	2.3
432.0	36.8	46.0	-9.2	41.7	29.8	22.5	2.4
456.5	37.2	46.0	-8.8	41.8	29.8	22.8	2.4
480.5	36.1	46.0	-9.9	40.2	29.9	23.4	2.4

30 – 1000 MHz

BT V3.0 Middle channel:

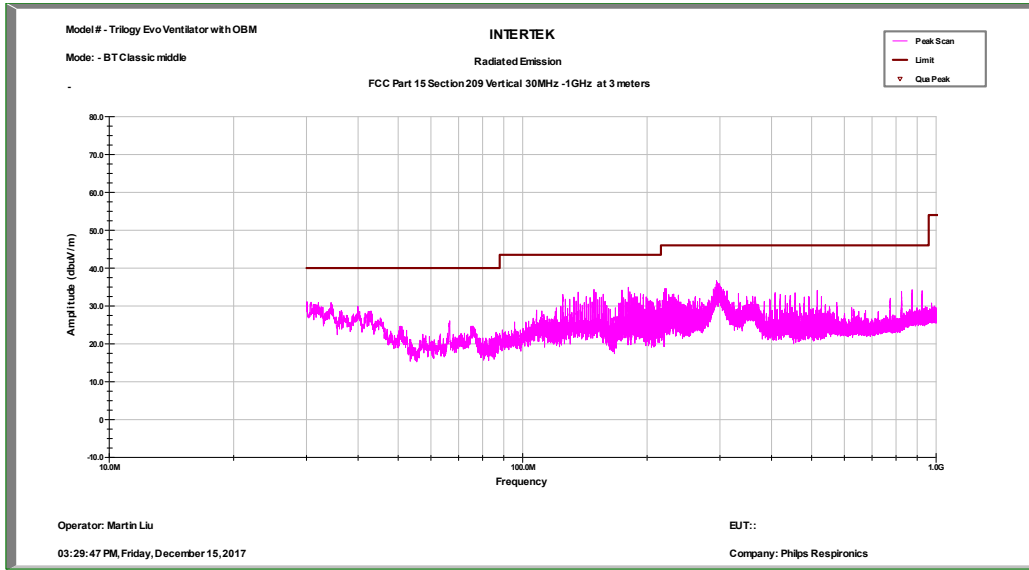

Vertical Scan

Frequency MHz	Peak FS dB(uV/m)	Limit@3m dB(uV/m)	Margin dB	RA dB	AG dB	AF dB	CF dB
148.8	34.4	43.5	-9.1	45.3	29.9	16.6	2.4
180.2	34.9	43.5	-8.6	47.3	29.7	15.2	2.2
220.9	34.6	46.0	-11.4	47.0	29.7	15.3	2.0
222.5	34.6	46.0	-11.4	46.8	29.6	15.4	2.0
294.4	36.7	46.0	-9.3	45.0	29.6	19.0	2.2
298.5	35.9	46.0	-10.1	44.1	29.6	19.1	2.2

30 – 1000 MHz

BT V3.0 High channel:

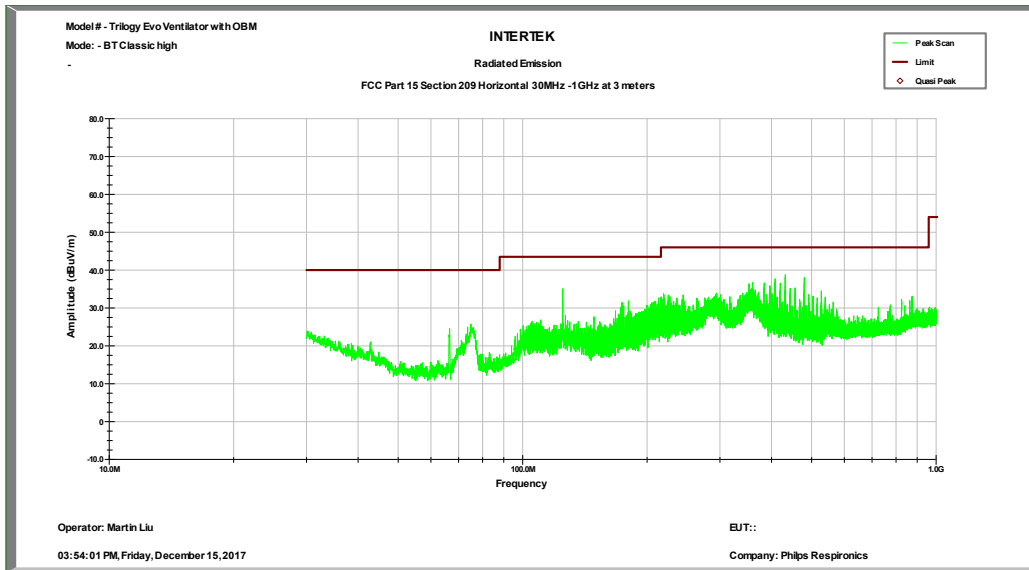

Horizontal Scan

Frequency MHz	Peak FS dB(uV/m)	Limit@3m dB(uV/m)	Margin dB	RA dB	AG dB	AF dB	CF dB
360.0	36.6	46.0	-9.4	43.3	29.7	20.9	2.2
383.9	36.6	46.0	-9.4	43.0	29.7	21.1	2.2
408.0	37.7	46.0	-8.3	42.8	29.8	22.3	2.3
419.9	36.5	46.0	-9.5	41.3	29.8	22.7	2.4
431.8	38.7	46.0	-7.3	43.7	29.8	22.5	2.4
480.0	38.0	46.0	-8.0	42.0	29.9	23.4	2.4

30 – 1000 MHz

BT V3.0 High channel:

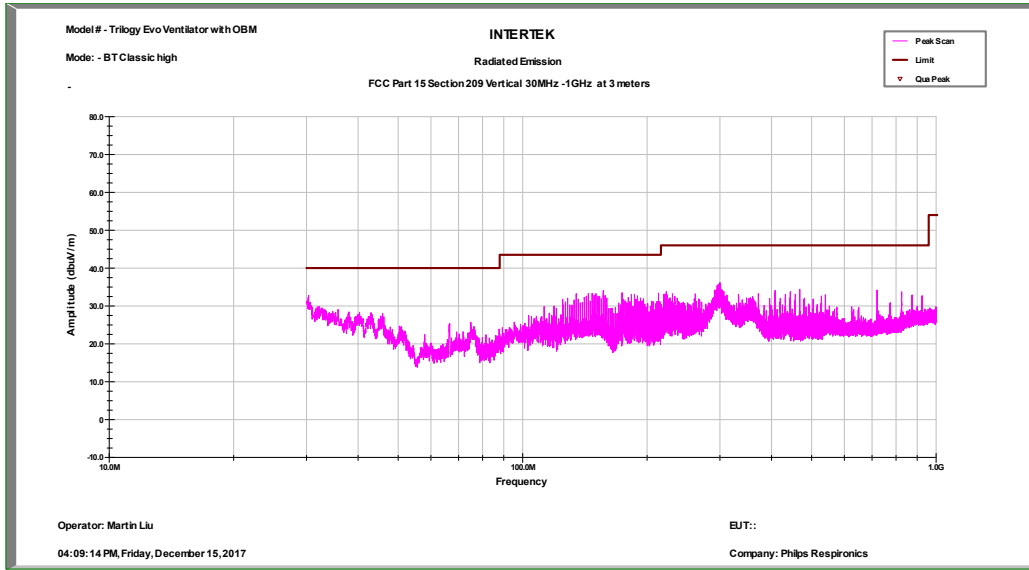

Vertical Scan

Frequency MHz	Peak FS dB(uV/m)	Limit@3m dB(uV/m)	Margin dB	RA dB	AG dB	AF dB	CF dB
297.3	35.7	46.0	-10.3	44.0	29.6	19.1	2.2
300.0	36.2	46.0	-9.8	44.3	29.6	19.2	2.2
304.1	34.2	46.0	-11.8	42.2	29.6	19.3	2.2
407.9	34.1	46.0	-11.9	39.2	29.7	22.3	2.3
468.1	34.4	46.0	-11.6	38.9	29.9	23.0	2.4
720.0	34.2	46.0	-11.8	36.4	30.1	25.3	2.6

30 – 1000 MHz

BT V4.0 Low channel:

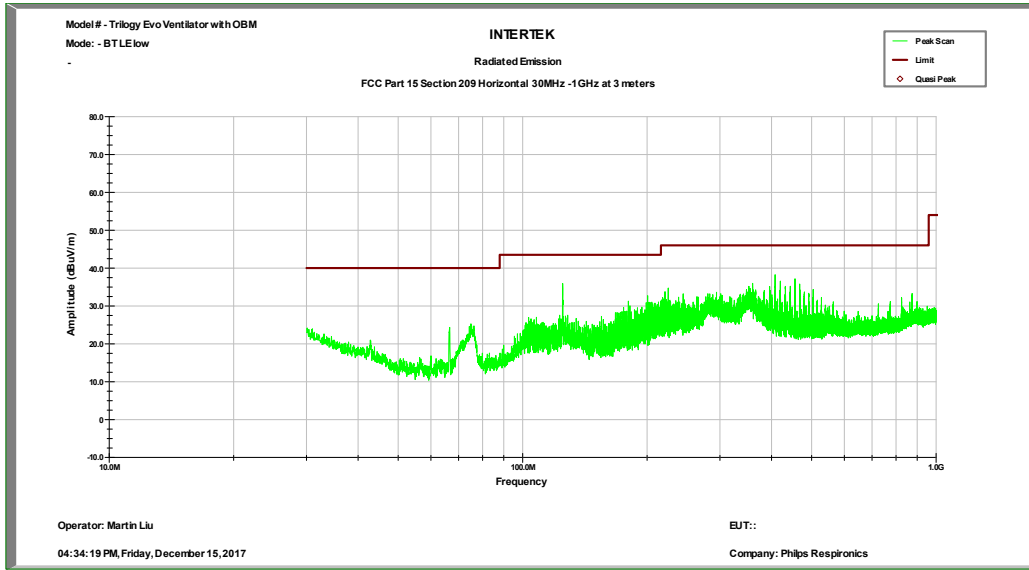

Horizontal Scan

Frequency MHz	Peak FS dB(uV/m)	Limit@3m dB(uV/m)	Margin dB	RA dB	AG dB	AF dB	CF dB
125.0	35.9	43.5	-7.6	45.1	30.0	18.2	2.7
360.0	36.0	46.0	-10.0	42.6	29.7	20.9	2.2
407.9	38.2	46.0	-7.8	43.4	29.7	22.3	2.3
420.0	36.6	46.0	-9.4	41.3	29.8	22.7	2.4
455.8	37.1	46.0	-8.9	41.8	29.8	22.8	2.4
467.8	35.8	46.0	-10.2	40.2	29.9	23.0	2.4

30 – 1000 MHz

BT V4.0 Low channel:

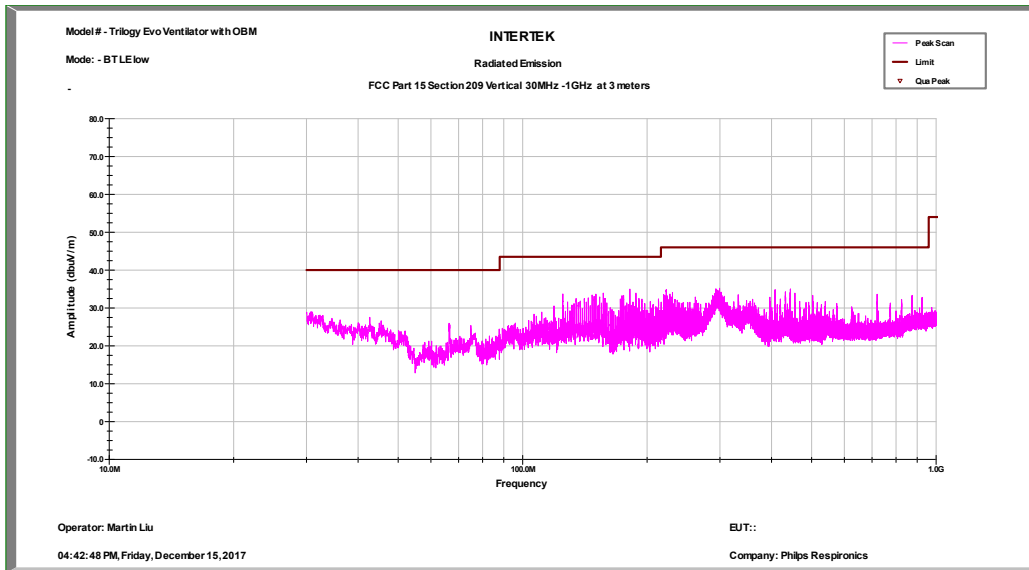

Vertical Scan

Frequency MHz	Peak FS dB(uV/m)	Limit@3m dB(uV/m)	Margin dB	RA dB	AG dB	AF dB	CF dB
181.7	35.0	43.5	-8.5	47.5	29.8	15.1	2.2
222.6	34.8	46.0	-11.2	47.0	29.7	15.5	2.0
299.5	35.2	46.0	-10.8	43.3	29.6	19.2	2.2
408.0	34.8	46.0	-11.2	39.9	29.8	22.3	2.3
431.9	34.2	46.0	-11.8	39.2	29.8	22.5	2.4
444.2	35.0	46.0	-11.0	39.8	29.8	22.6	2.4

30 – 1000 MHz

BT V4.0 Middle channel:

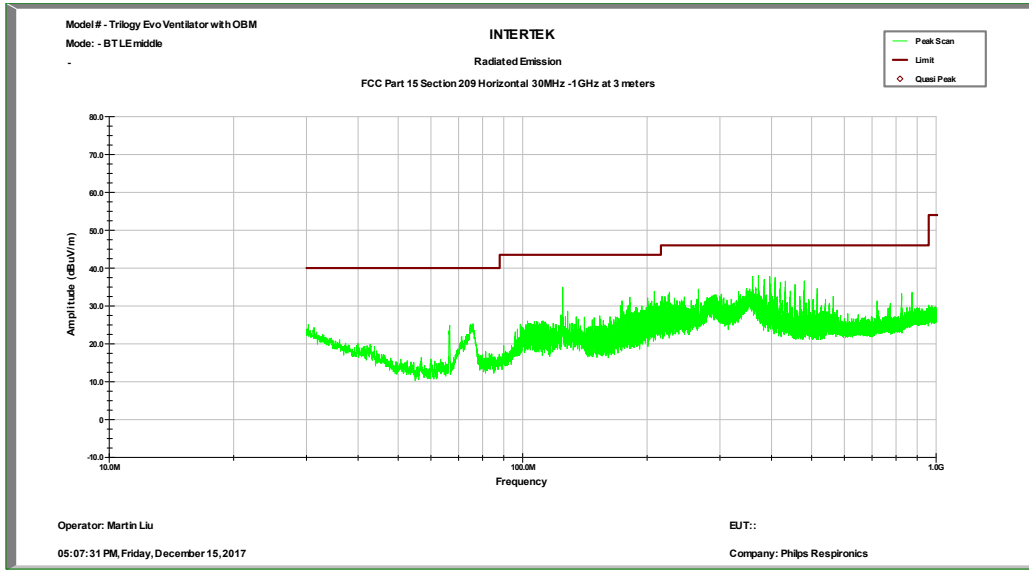

Horizontal Scan

Frequency MHz	Peak FS dB(uV/m)	Limit@3m dB(uV/m)	Margin dB	RA dB	AG dB	AF dB	CF dB
360.0	37.8	46.0	-8.2	44.4	29.7	20.9	2.2
371.8	38.0	46.0	-8.0	44.6	29.7	20.9	2.2
384.0	36.9	46.0	-9.1	43.3	29.7	21.1	2.2
396.1	37.7	46.0	-8.3	43.5	29.7	21.6	2.3
408.0	37.5	46.0	-8.5	42.6	29.8	22.3	2.3
480.0	36.6	46.0	-9.4	40.6	29.9	23.4	2.4

30 – 1000 MHz

BT V4.0 Middle channel:

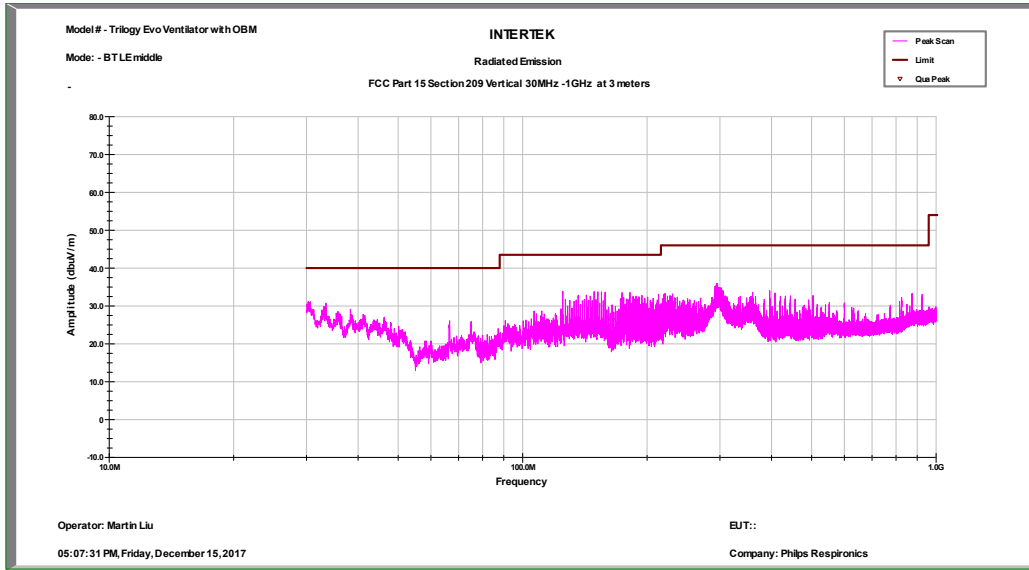

Vertical Scan

Frequency MHz	Peak FS dB(uV/m)	Limit@3m dB(uV/m)	Margin dB	RA dB	AG dB	AF dB	CF dB
292.0	35.3	46.0	-10.7	43.6	29.6	19.0	2.2
294.6	35.9	46.0	-10.1	44.2	29.6	19.1	2.2
296.1	35.9	46.0	-10.1	44.2	29.7	19.1	2.2
301.6	34.8	46.0	-11.2	42.9	29.5	19.2	2.2
305.3	34.0	46.0	-12.0	42.1	29.7	19.3	2.2
396.0	34.0	46.0	-12.0	39.8	29.7	21.6	2.3

30 – 1000 MHz

BT V4.0 High channel:

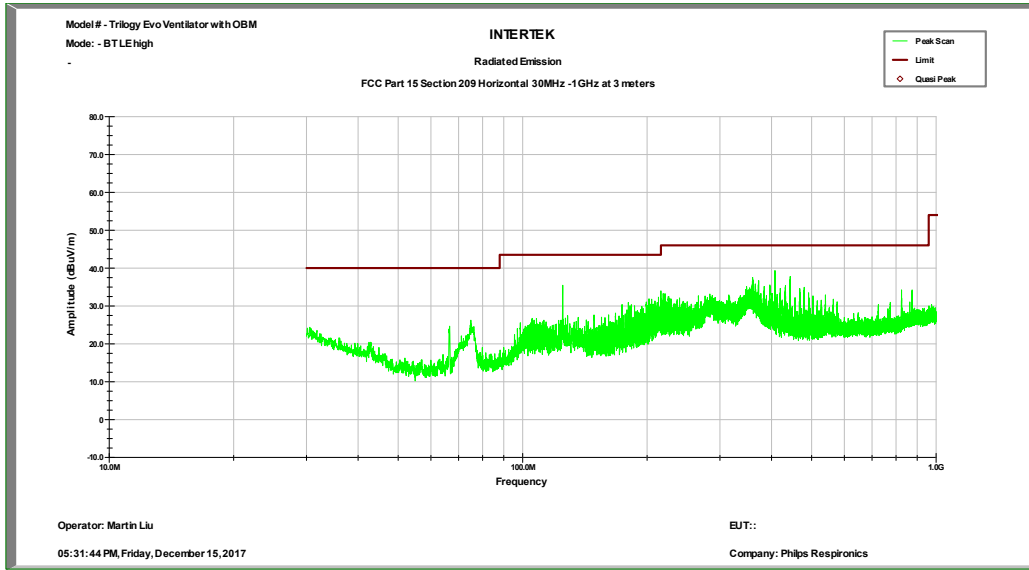

Horizontal Scan

Frequency MHz	Peak FS dB(uV/m)	Limit@3m dB(uV/m)	Margin dB	RA dB	AG dB	AF dB	CF dB
359.9	37.5	46.0	-8.5	44.1	29.7	20.9	2.2
360.4	36.9	46.0	-9.1	43.4	29.7	20.9	2.2
365.3	35.8	46.0	-10.2	42.3	29.7	21.0	2.2
372.2	36.7	46.0	-9.3	43.3	29.7	20.9	2.2
407.6	39.3	46.0	-6.7	44.4	29.7	22.3	2.3
443.8	37.7	46.0	-8.3	42.6	29.8	22.6	2.4

30 – 1000 MHz

BT V4.0 High channel:

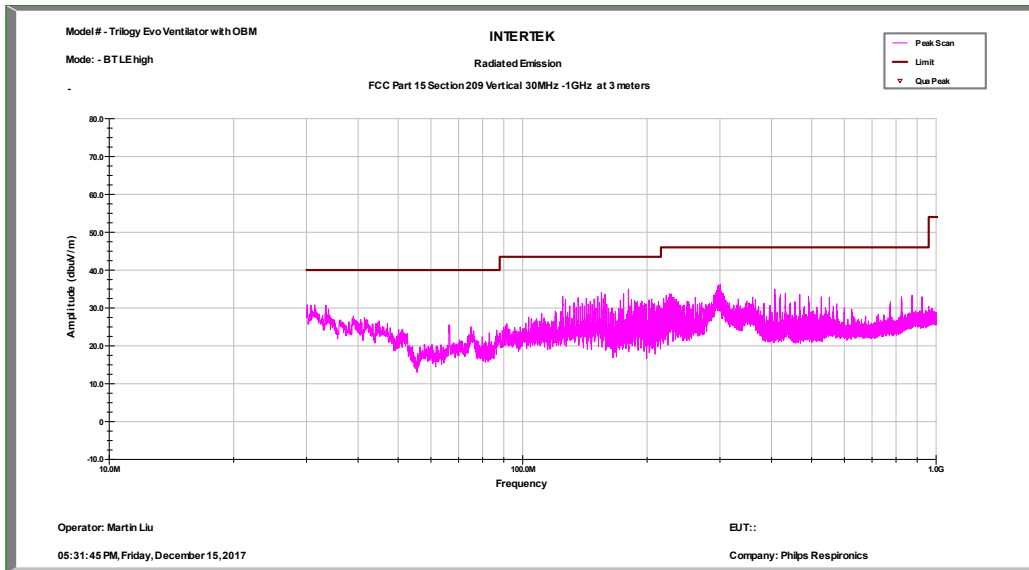

Vertical Scan

Frequency MHz	Peak FS dB(uV/m)	Limit@3m dB(uV/m)	Margin dB	RA dB	AG dB	AF dB	CF dB
155.1	34.1	43.5	-9.4	45.3	29.9	16.3	2.4
180.2	35.0	43.5	-8.5	47.4	29.7	15.2	2.2
296.0	35.7	46.0	-10.3	44.0	29.7	19.1	2.2
298.2	36.1	46.0	-9.9	44.3	29.6	19.1	2.2
300.9	36.2	46.0	-9.8	44.3	29.5	19.2	2.2
407.3	34.9	46.0	-11.1	40.0	29.7	22.3	2.3

1 – 18 GHz

802.11b Low channel

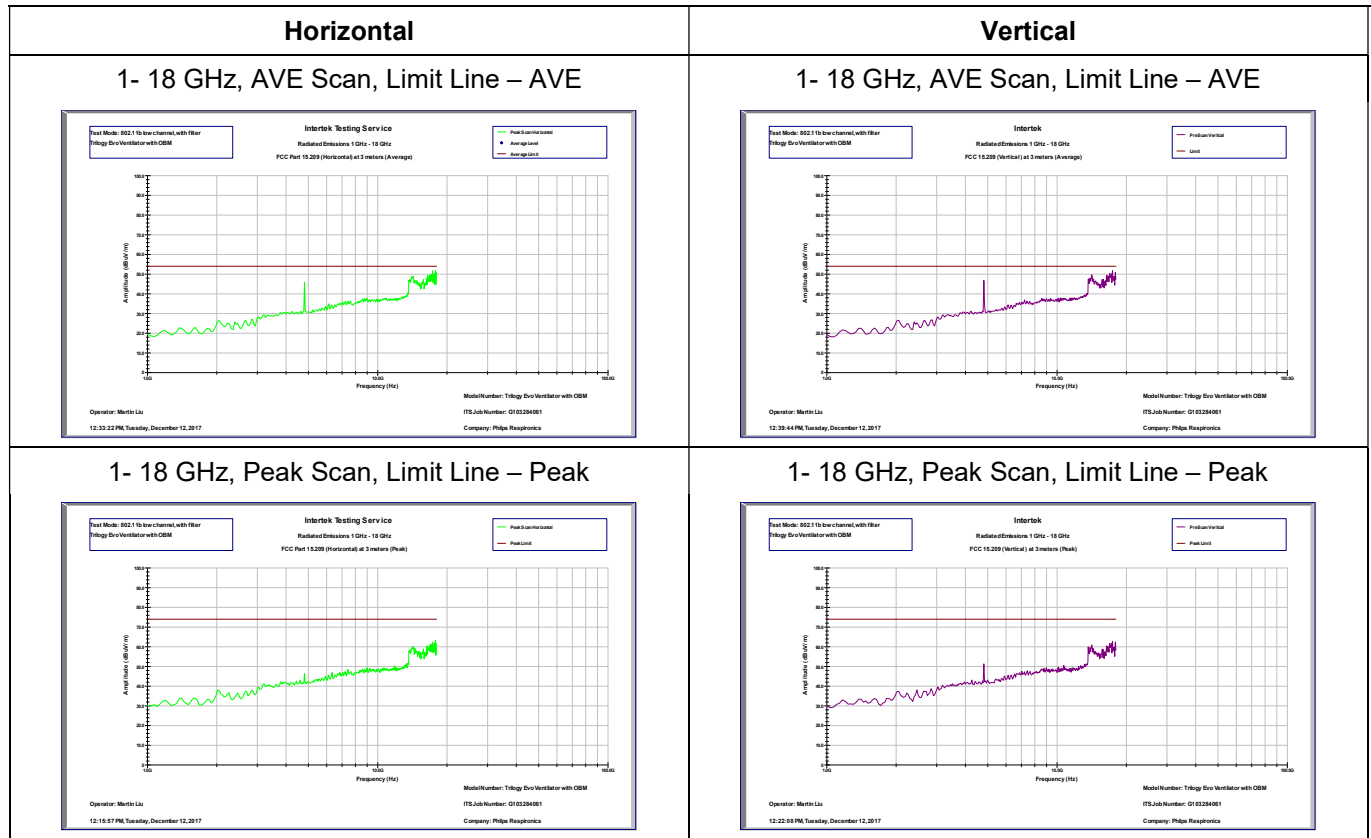

Note: Radiated emission measurements were performed up to 25 GHz. No emissions were identified when scanned from 18-25 GHz.

Antenna Polarization	Frequency (MHz)	Channel No.	Measured Data (dBuV/m)	Limit (dBuV/m)	Margin (dB)	Turntable Degree	Antenna Height (cm)	Detector
H	2390*	1	62.01	74	-12.00	254	200	Peak
H	2390*	1	49.37	54	-4.64	254	200	RMS

1 – 18 GHz

802.11b Middle channel

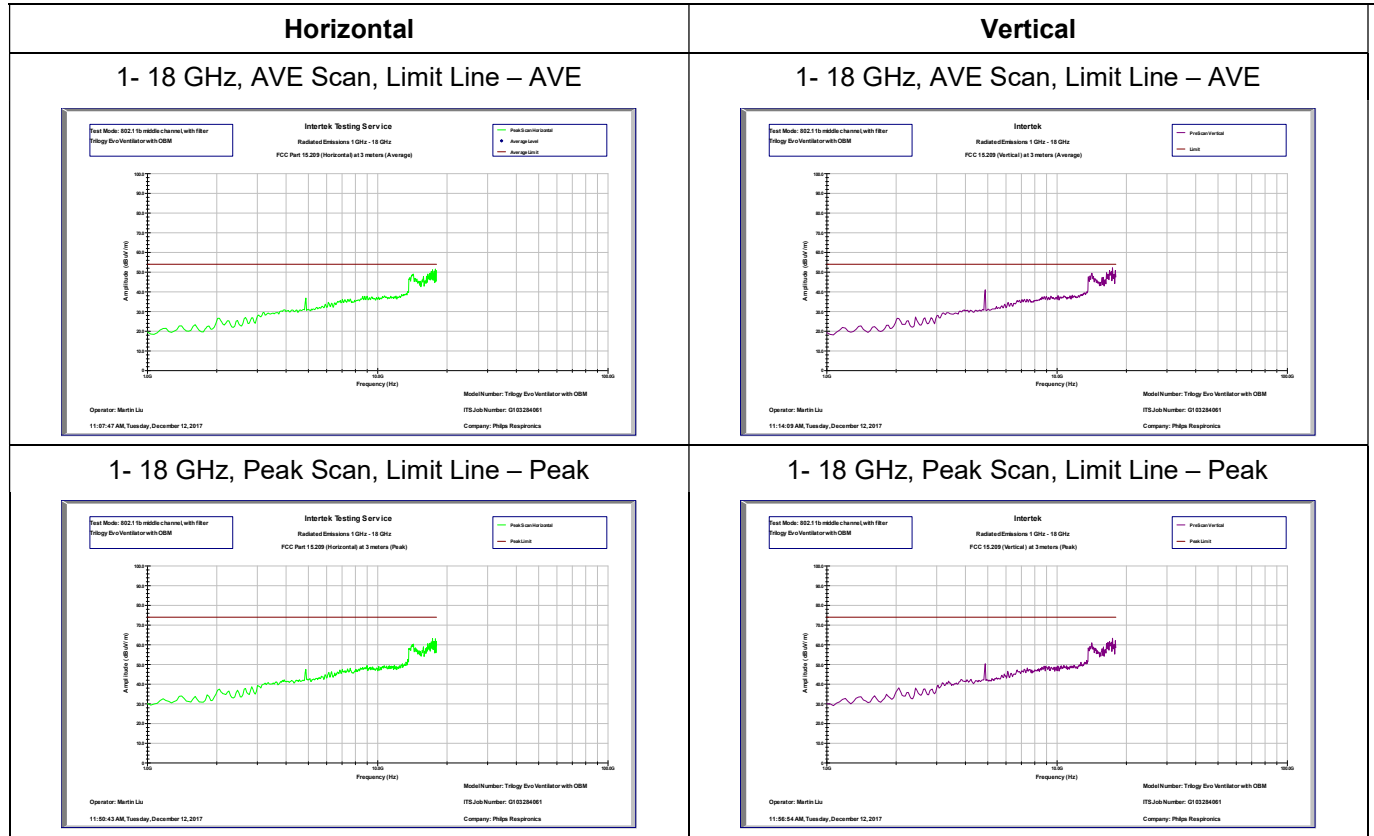

Note: Radiated emission measurements were performed up to 25 GHz. No emissions were identified when scanned from 18-25 GHz.

1 – 18 GHz

802.11b High channel

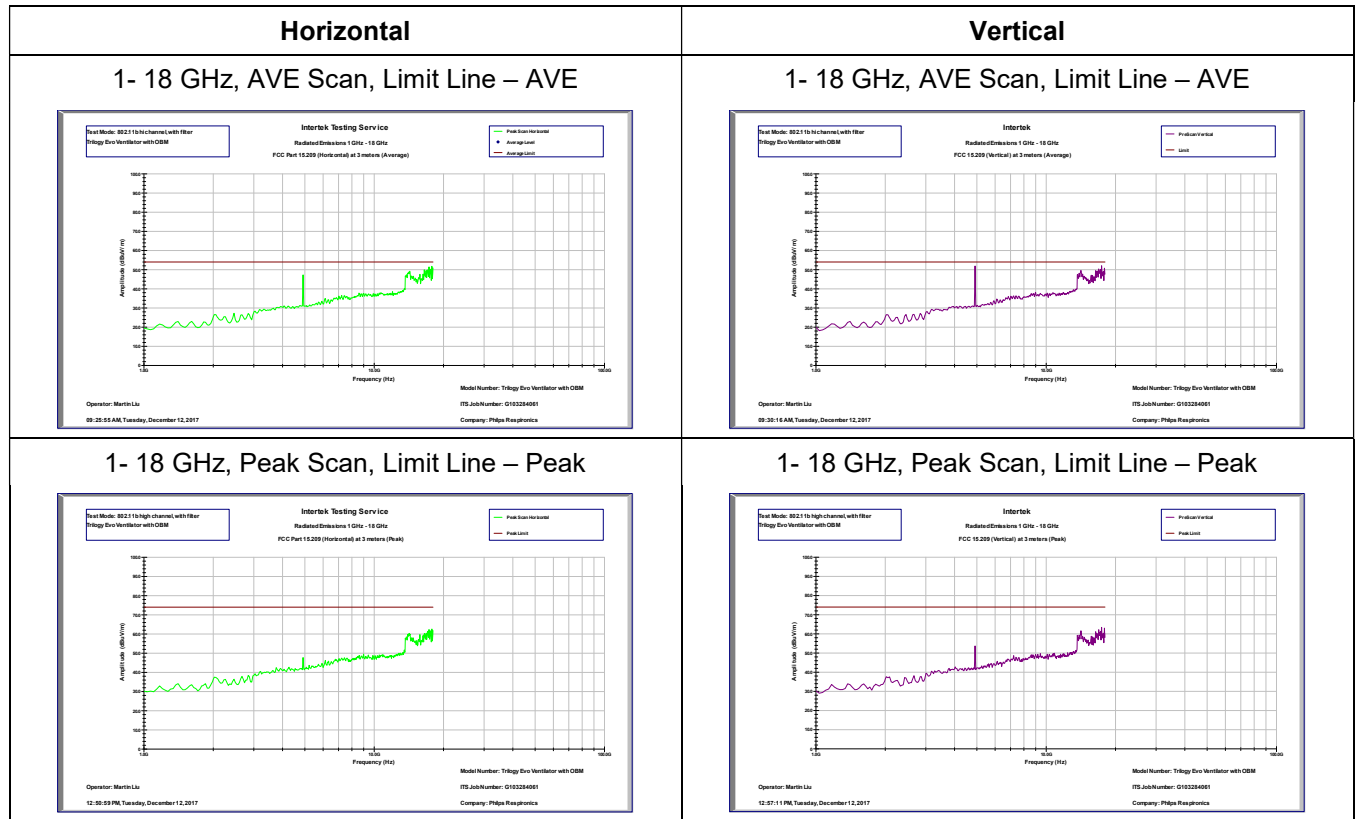

Note: Radiated emission measurements were performed up to 25 GHz. No emissions were identified when scanned from 18-25 GHz.

Antenna Polarization	Frequency (MHz)	Channel No.	Measured Data (dBuV/m)	Limit (dBuV/m)	Margin (dB)	Turntable Degree	Antenna Height (cm)	Detector
H	2483.5	11	57.52	74	-16.48	264	153	Peak
H	2483.5	11	48.11	54	-5.89	264	153	RMS
V	4924	11	55.36	74	-18.64	360	166	Peak
V	4924	11	46.77	54	-7.23	360	166	RMS

1 – 18 GHz

802/11g Low channel

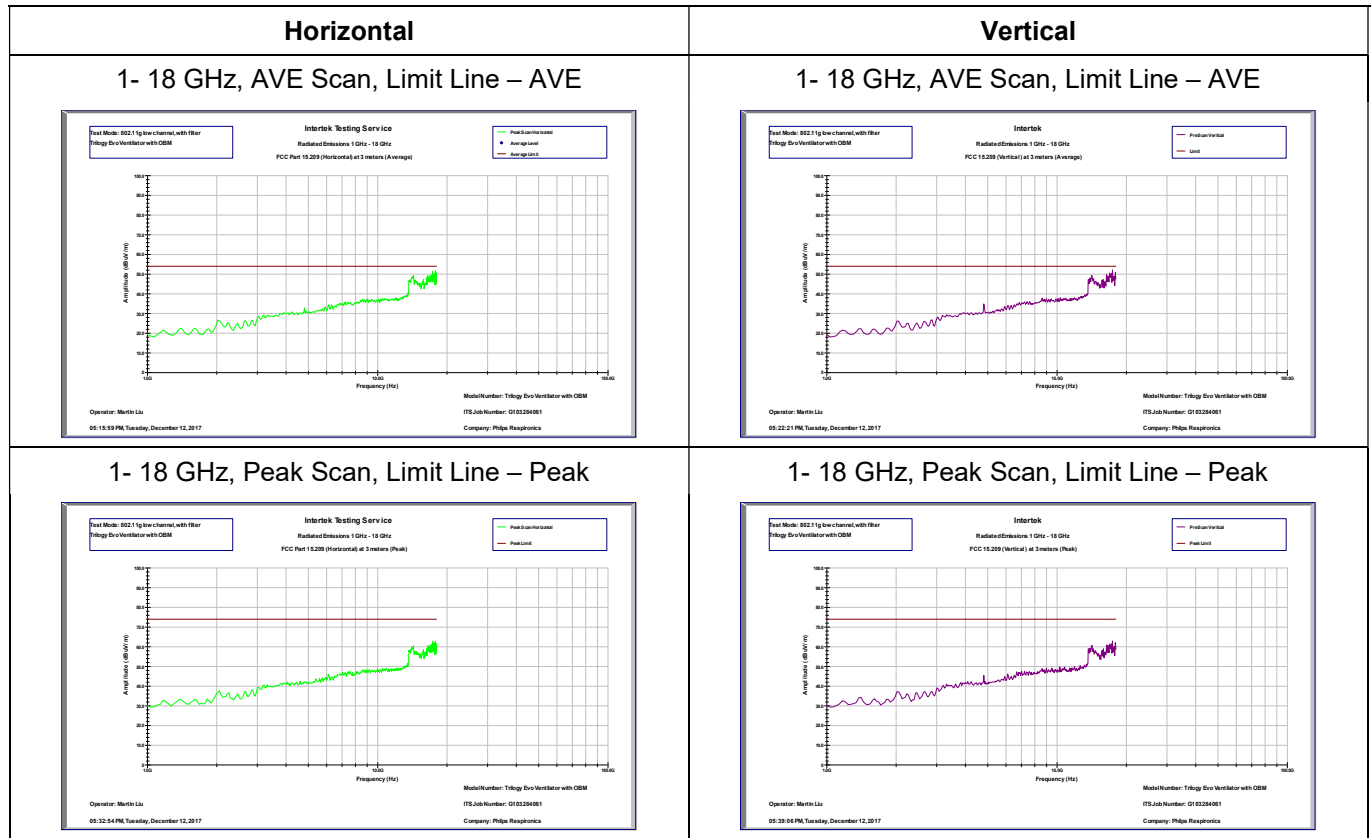

Note: Radiated emission measurements were performed up to 25 GHz. No emissions were identified when scanned from 18-25 GHz.

Antenna Polarization	Frequency (MHz)	Channel No.	Measured Data (dBuV/m)	Limit (dBuV/m)	Margin (dB)	Turntable Degree	Antenna Height (cm)	Detector
H	2390	1	64.05	74	-9.96	264	153	Peak
H	2390	1	49.45	54	-4.56	264	153	RMS

1 – 18 GHz

802.11g Middle channel

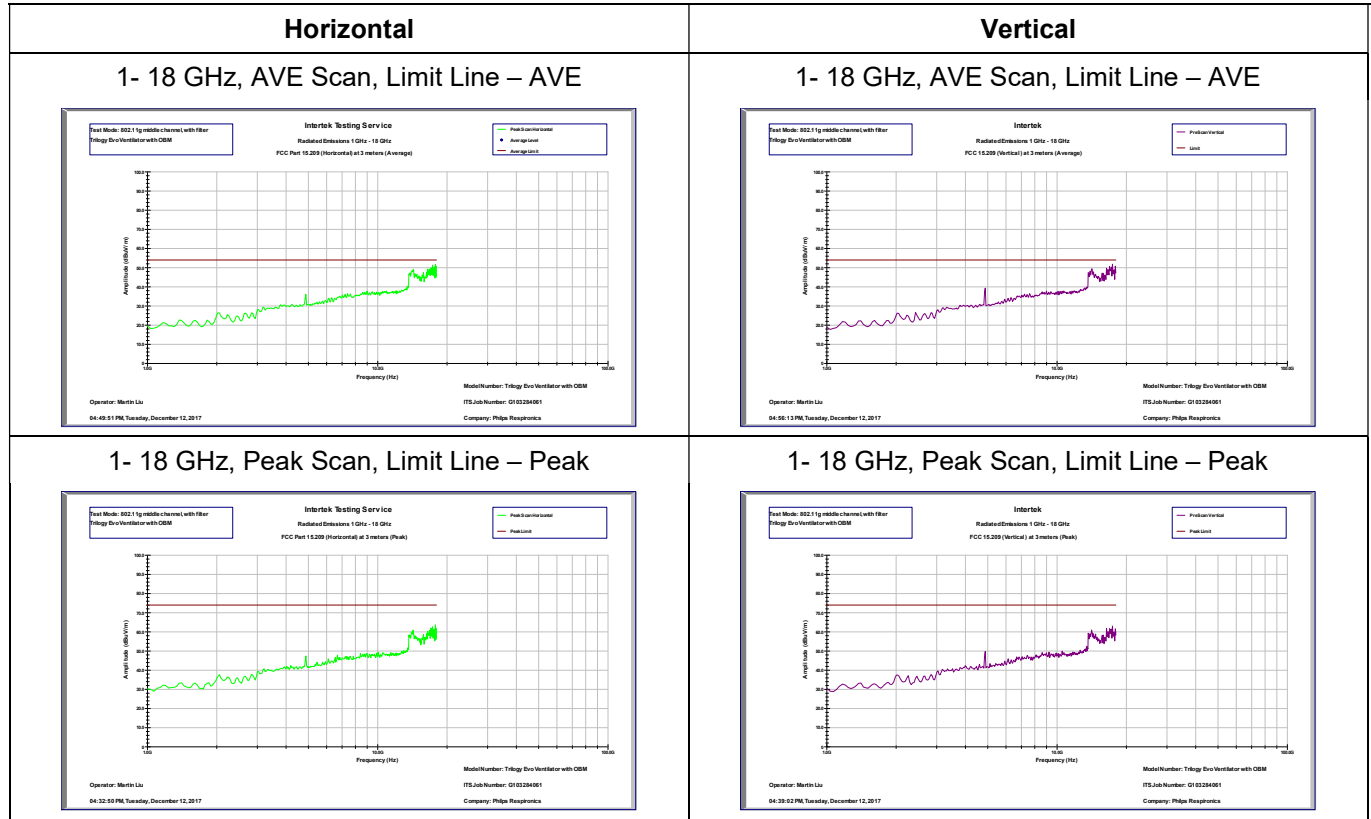

Note: Radiated emission measurements were performed up to 25 GHz. No emissions were identified when scanned from 18-25 GHz.

Antenna Polarization	Frequency (MHz)	Channel No.	Measured Data (dBuV/m)	Limit (dBuV/m)	Margin (dB)	Turntable Degree	Antenna Height (cm)	Detector
V	4874	6	53.70	74	-20.3	360	166	Peak
V	4874	6	52.61	54	-1.39	360	166	RMS

1 – 18 GHz

802.11g High channel

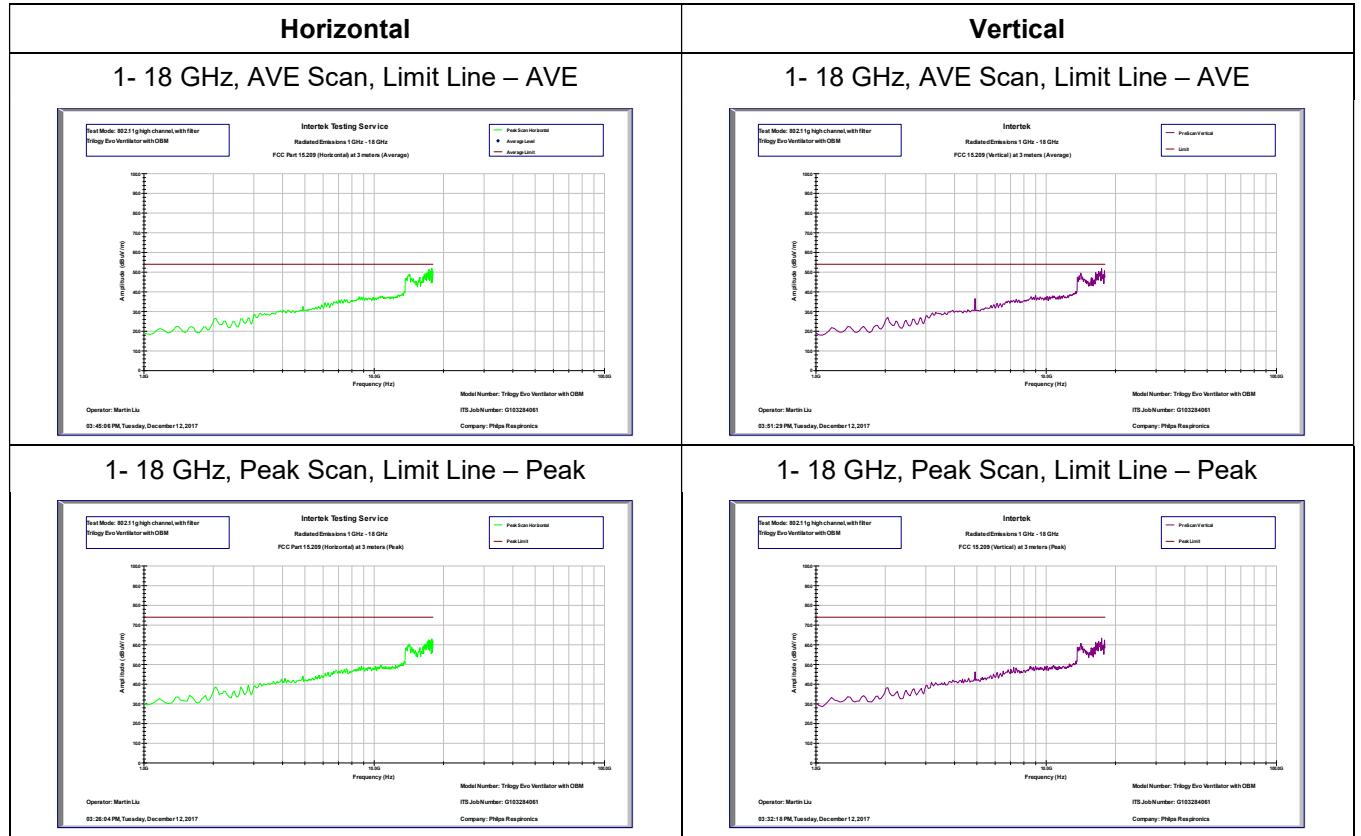

Note: Radiated emission measurements were performed up to 25 GHz. No emissions were identified when scanned from 18-25 GHz.

Antenna Polarization	Frequency (MHz)	Channel No.	Measured Data (dBuV/m)	Limit (dBuV/m)	Margin (dB)	Turntable Degree	Antenna Height (cm)	Detector
H	2483.5	11	62.36	74	-11.64	256	177	Peak
H	2483.5	11	51.44	54	-2.56	256	177	RMS

1 – 18 GHz

802.11n Low channel

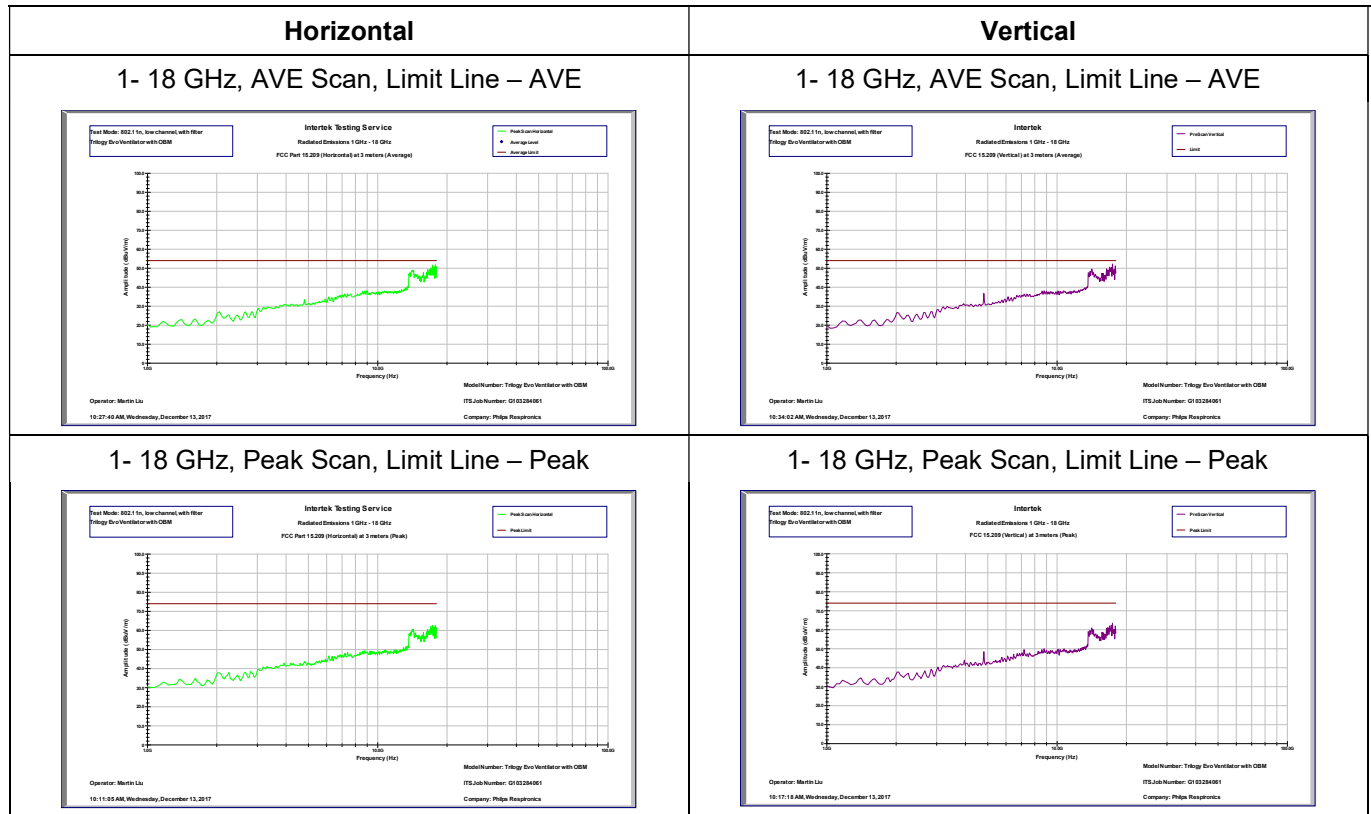

Note: Radiated emission measurements were performed up to 25 GHz. No emissions were identified when scanned from 18-25 GHz.

Antenna Polarization	Frequency (MHz)	Channel No.	Measured Data (dBuV/m)	Limit (dBuV/m)	Margin (dB)	Turntable Degree	Antenna Height (cm)	Detector
H	2390	1	67.72	74	-6.29	256	177	Peak
H	2390	1	49.64	54	-4.37	256	177	RMS

1 – 18 GHz

802.11n Middle channel

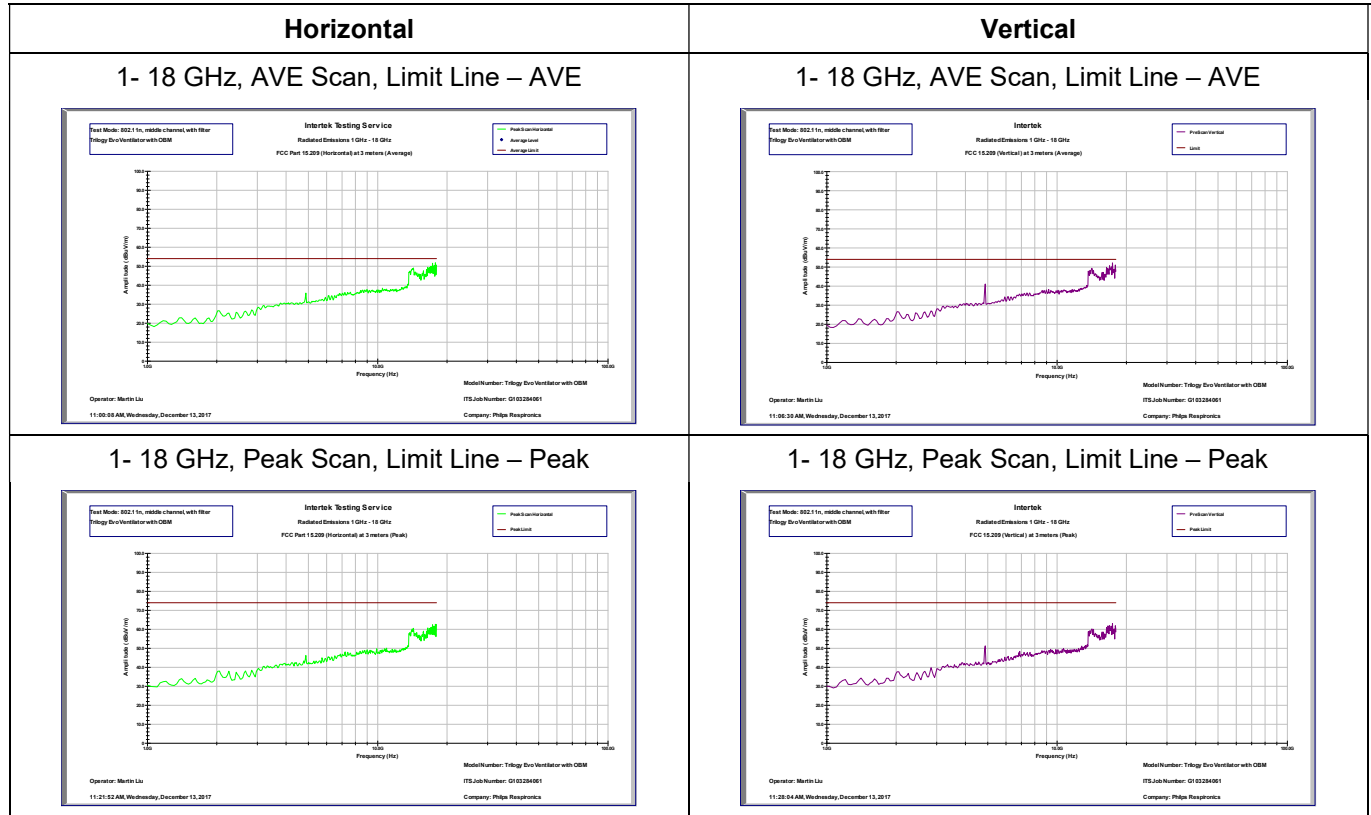

Note: Radiated emission measurements were performed up to 25 GHz. No emissions were identified when scanned from 18-25 GHz.

Antenna Polarization	Frequency (MHz)	Channel No.	Measured Data (dBµV/m)	Limit (dBµV/m)	Margin (dB)	Turntable Degree	Antenna Height (cm)	Detector
V	4874	6	53.66	74	-20.34	360	166	Peak
V	4874	6	52.03	54	-1.97	360	166	RMS

1 – 18 GHz

802.11n High channel

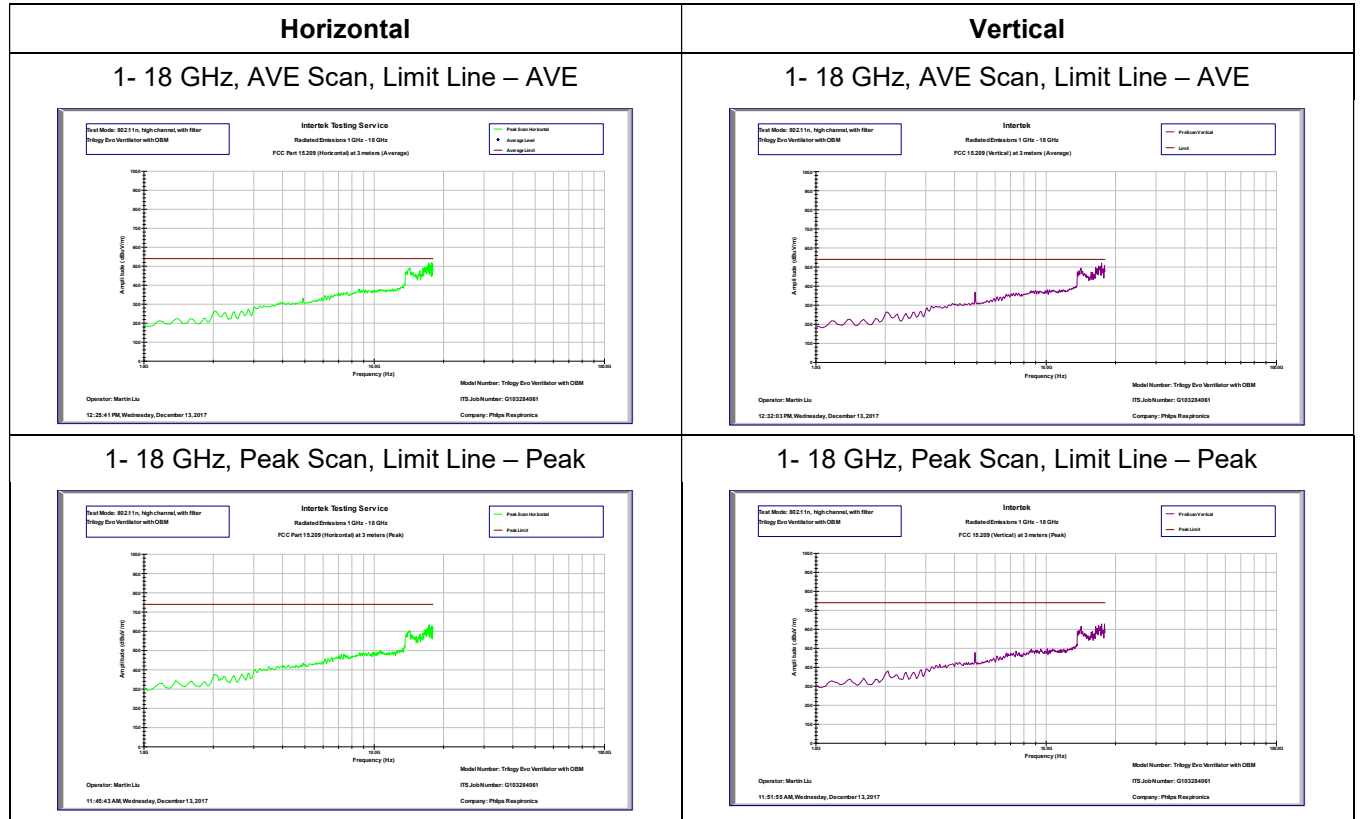

Note: Radiated emission measurements were performed up to 25 GHz. No emissions were identified when scanned from 18-25 GHz.

Antenna Polarization	Frequency (MHz)	Channel No.	Measured Data (dBuV/m)	Limit (dBuV/m)	Margin (dB)	Turntable Degree	Antenna Height (cm)	Detector
H	2483.5	11	65.30	74	-8.70	254	181	Peak
H	2483.5	11	52.94	54	-1.06	254	181	RMS

1 – 18 GHz

BT V3.0 Low channel

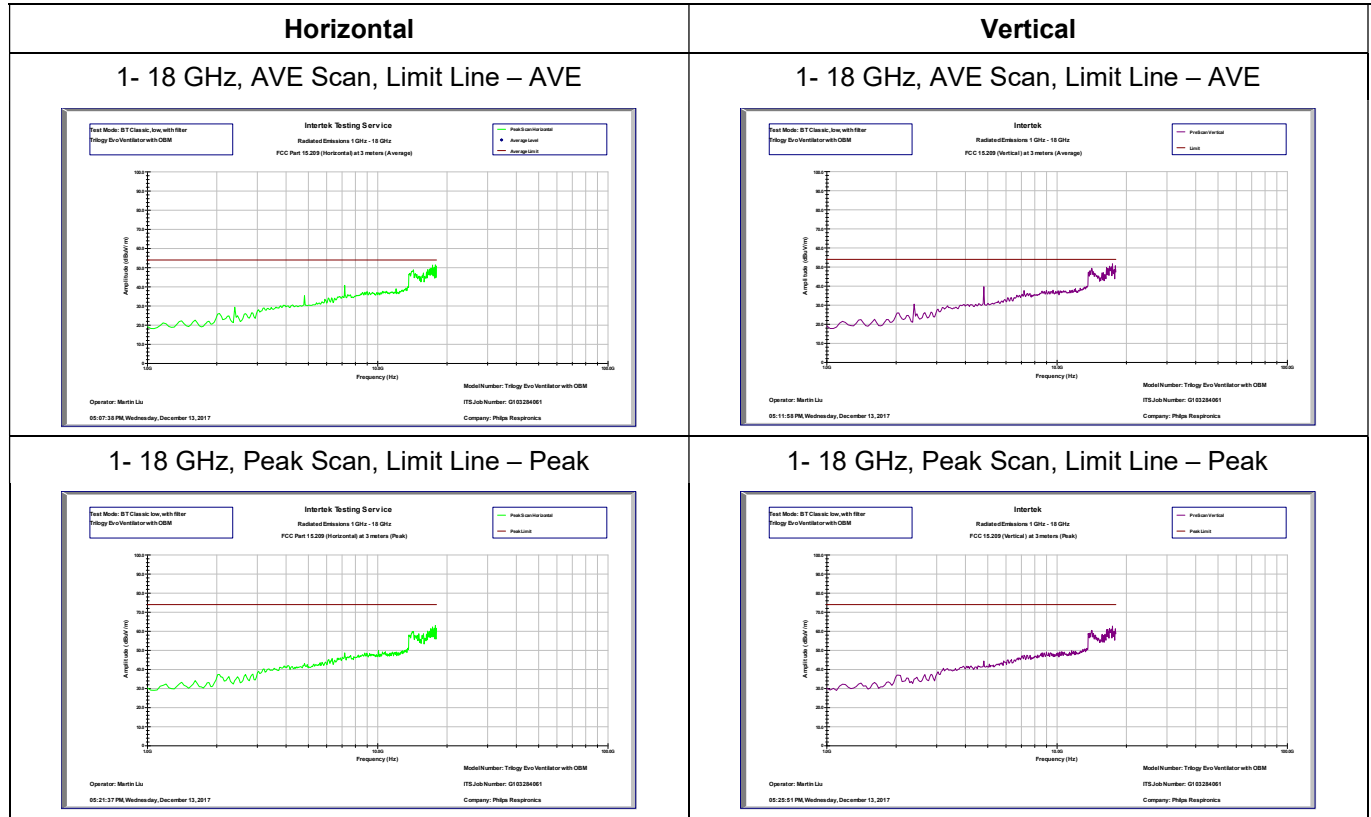

Note: Radiated emission measurements were performed up to 25 GHz. No emissions were identified when scanned from 18-25 GHz.

Antenna Polarization	Frequency (MHz)	Channel No.	Measured Data (dBuV/m)	Limit (dBuV/m)	Margin (dB)	Turntable Degree	Antenna Height (cm)	Detector
H	2390	1	36.29	74	-37.72	254	174	Peak
H	2390	1	25.27	54	-28.74	254	174	RMS

1 – 18 GHz

BT V3.0 Middle channel

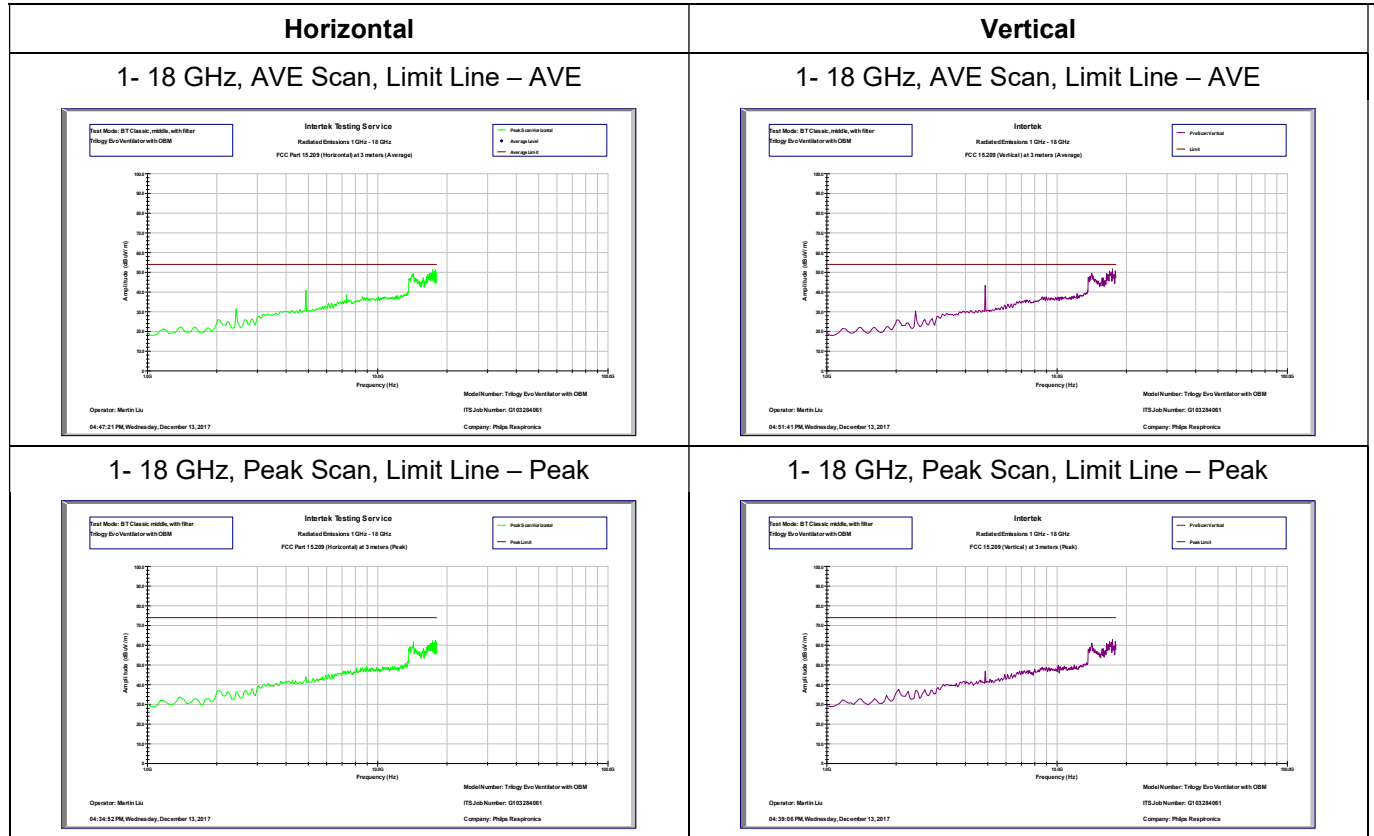

Note: Radiated emission measurements were performed up to 25 GHz. No emissions were identified when scanned from 18-25 GHz.

1 – 18 GHz

BT V3.0 High channel

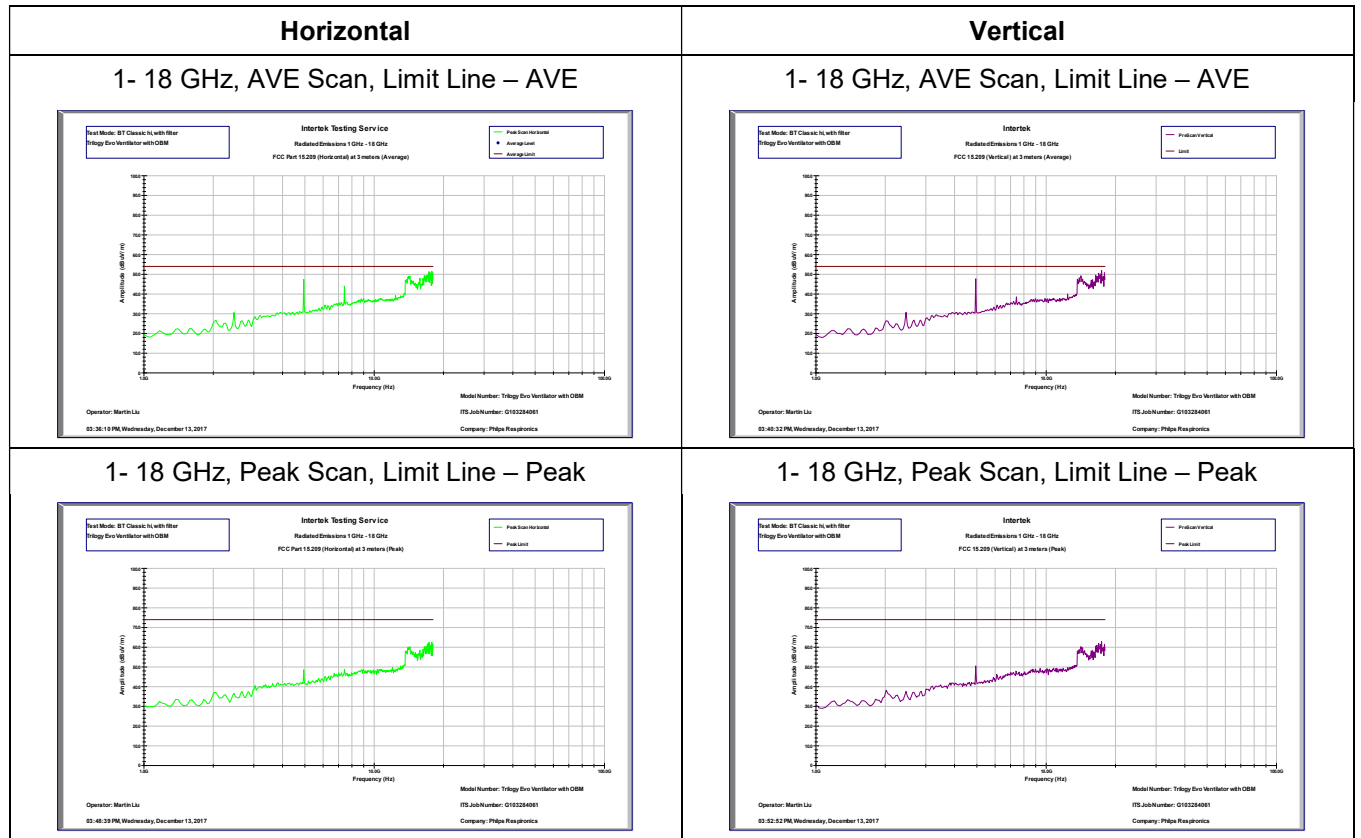

Note: Radiated emission measurements were performed up to 25 GHz. No emissions were identified when scanned from 18-25 GHz.

Antenna Polarization	Frequency (MHz)	Channel No.	Measured Data (dBuV/m)	Limit (dBuV/m)	Margin (dB)	Turntable Degree	Antenna Height (cm)	Detector
H	7440	11	51.32	74	-22.68	34	158	Peak
H	7440	11	41.67	54	-12.33	34	158	RMS
V	4960	11	52.25	74	-21.75	10	180	Peak
V	4960	11	47.68	54	-6.32	10	180	RMS
V	2483.5	11	47.20	74	-26.80	258	165	Peak
V	2483.5	11	39.36	54	-14.64	258	165	RMS

1 – 18 GHz

BT V4.0 Low channel

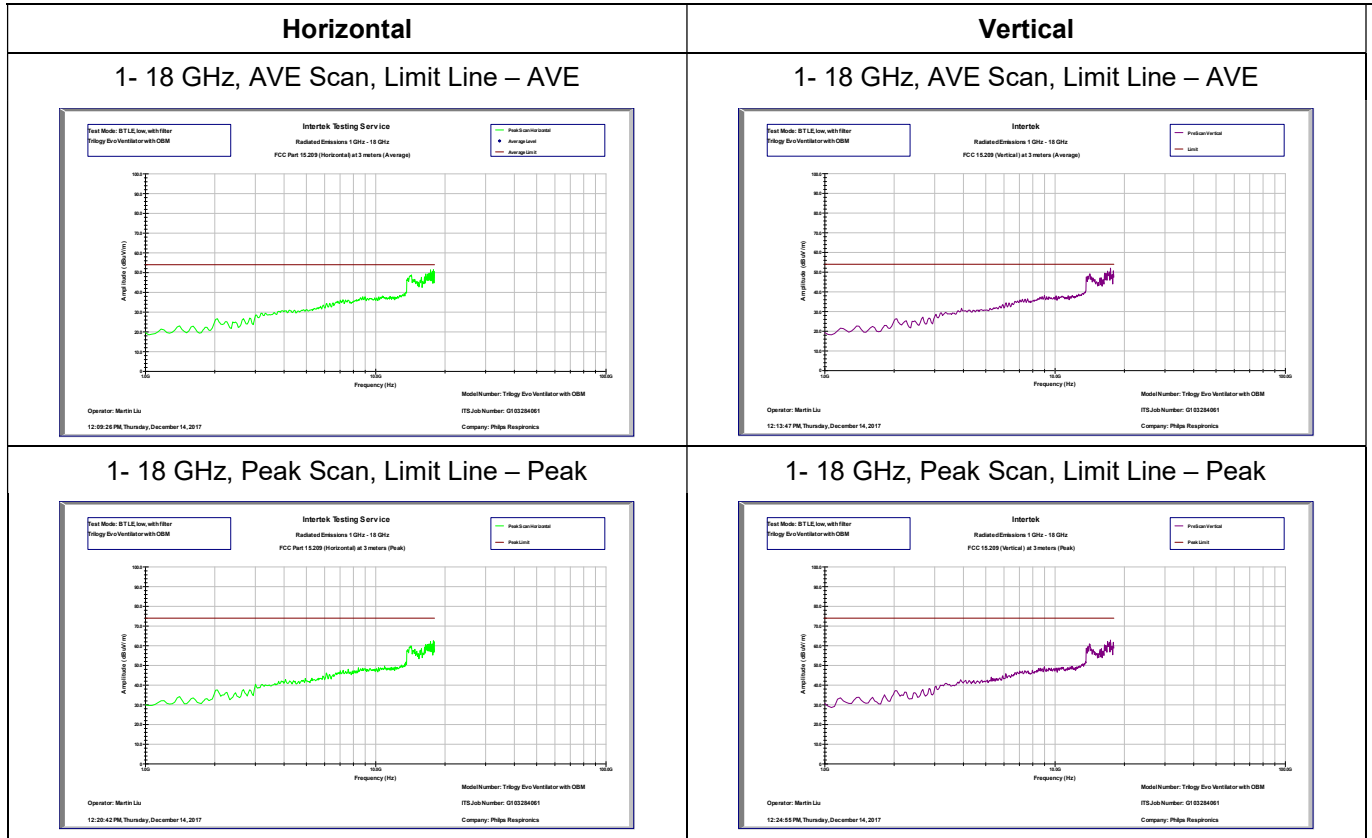

Note: Radiated emission measurements were performed up to 25 GHz. No emissions were identified when scanned from 18-25 GHz.

Antenna Polarization	Frequency (MHz)	Channel No.	Measured Data (dBuV/m)	Limit (dBuV/m)	Margin (dB)	Turntable Degree	Antenna Height (cm)	Detector
H	2390	1	39.25	74	-34.76	260	166	Peak
H	2390	1	28.14	54	-25.87	260	166	RMS

Note: Radiated emission measurements were performed up to 25 GHz. No emissions were identified when scanned from 18-25 GHz.

1 – 18 GHz

BT V4.0 Middle channel

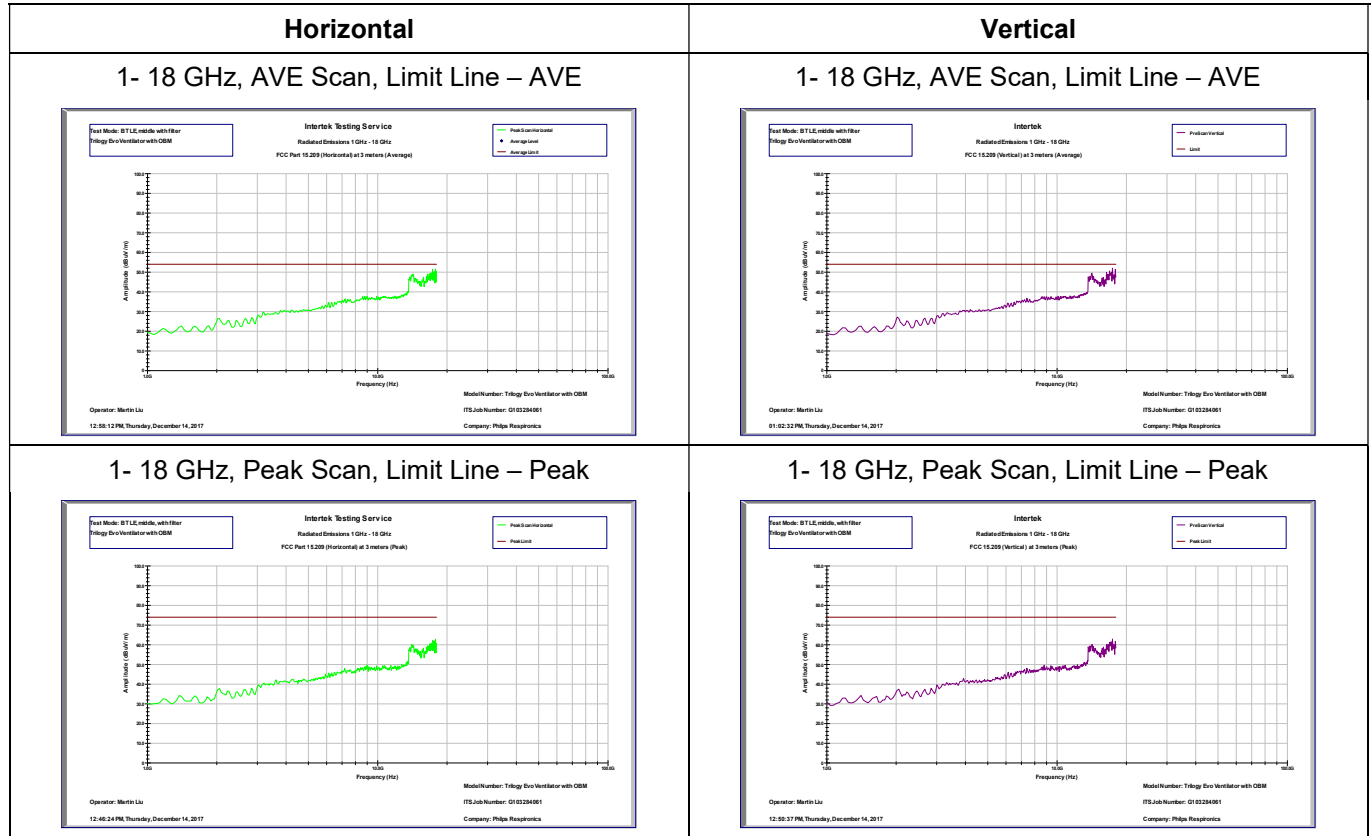

Note: Radiated emission measurements were performed up to 25 GHz. No emissions were identified when scanned from 18-25 GHz.

1 – 18 GHz

BT V4.0 High channel

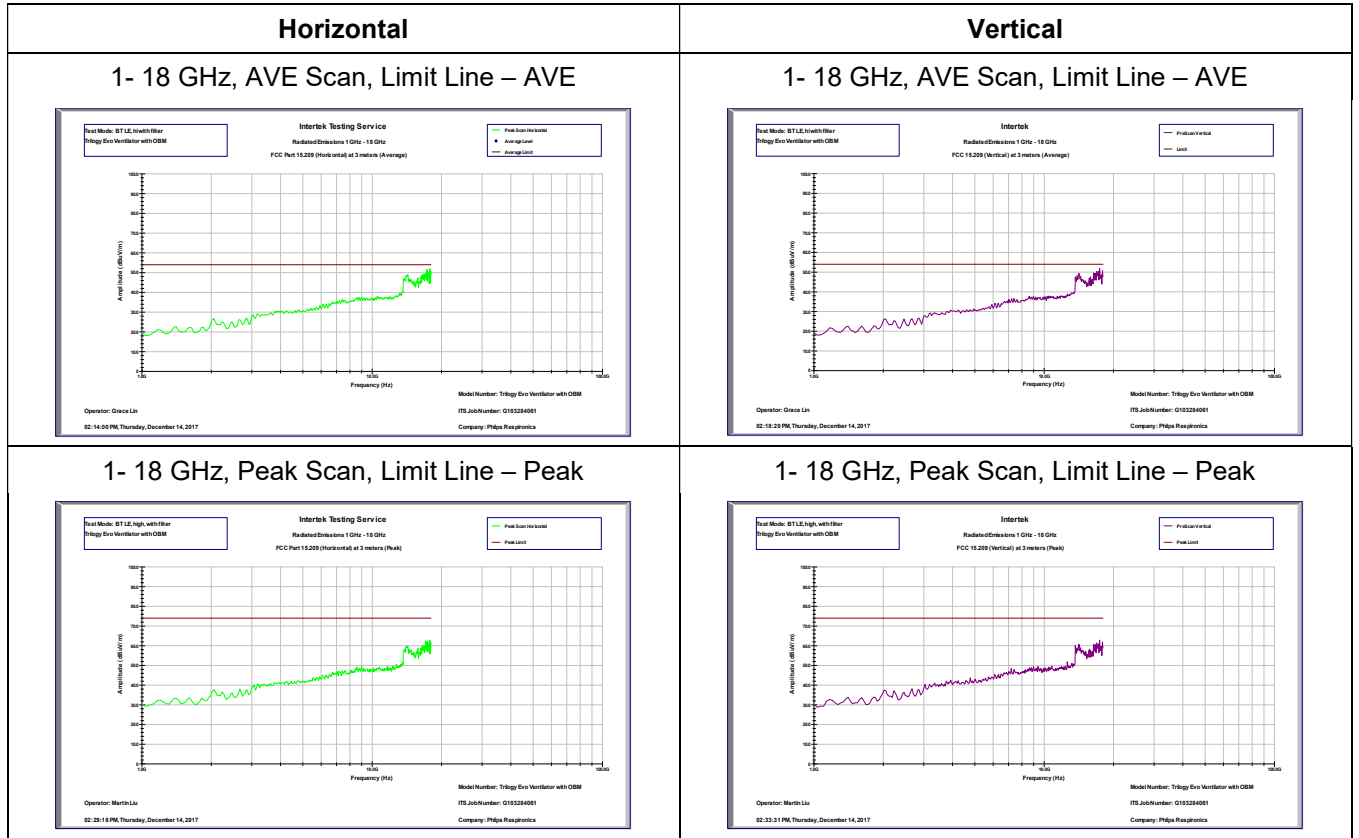

Note: Radiated emission measurements were performed up to 25 GHz. No emissions were identified when scanned from 18-25 GHz.

Antenna Polarization	Frequency (MHz)	Channel No.	Measured Data (dBuV/m)	Limit (dBuV/m)	Margin (dB)	Turntable Degree	Antenna Height (cm)	Detector
H	2483.5	11	56.21	74	-17.79	252	156	Peak
H	2483.5	11	46.34	54	-7.66	252	156	RMS

Test Personnel: Martin Liu
 Supervising/Reviewing Engineer: Grace Lin
 Product Standard: FCC §15.247, ISSED RSS-247 i2
 Input Voltage: 120Vac
 Pretest Verification w/ BB Source: Yes

Test Date: 12/11/2017 – 12/19/2017
 Limit Applied: FCC §15.209
 Ambient Temperature: 20.5 °C
 Relative Humidity: 31.3 %
 Atmospheric Pressure: 996.1 mbars

Deviations, Additions, or Exclusions: None

7 Revision History

Revision Level	Date	Report Number	Prepared By	Reviewed By	Notes
0	January 15, 2018	103284061LAX-001	ML	GL	Original Issue