

Trilogy Evo Universal Instructions for Use

For Technical Support and Customer Service, contact Philips Customer Service:

USA

Respironics Inc.

1001 Murry Ridge Lane Murrysville, PA 15668

Email: service@philips.com, clinical@philips.com

Web: www.philips.com/healthcare

Authorized European Representative:

Respironics Deutschland GmbH & Co. KG

Gewerbestrasse 17

D-82211 Herrsching Germany

+49 8152 93060

Copyright © 2018 Koninklijke Philips N.V. All rights reserved.

This work is protected under Title 17 of the United States copyright code and is the sole property of Philips Respironics. No part of this document may be copied or otherwise reproduced, or stored in any electronic information retrieval system, except as specifically permitted under United States copyright law, without the prior written consent of Philips Respironics.

Trilogy Evo Universal is the registered trademark of Respironics Inc.

The Bluetooth® word mark and logos are registered trademarks owned by Bluetooth SIG, Inc. and any use of such marks by Philips Respironics is under license.

Dawn Ultra is a registered trademark of Procter & Gamble.

Other trademarks and trade names are those of their respective owners.

Illustrations and screen images in this document are representative depictions.

Contents

1. Introduction	4	6. Alarms and System Messages	41
Intended Use.....	4	Overview	41
Environments of Use.....	4	About Alarms.....	41
Contraindications.....	4	The Alarm List.....	42
Package Contents.....	5	Setting and Changing Alarms.....	42
Warnings.....	5	Setting the Alarm Volume	43
Symbols Glossary	9	Responding to an Alarm	43
How to Contact Philips Respironics	11	Resetting Alarms	43
2. About Trilogy Evo Universal	12	Alarms and System Messages	44
Parts of Trilogy Evo Universal.....	12	Prescription Alarm Availability by Therapy Mode	60
Parts of the User Interface.....	14	Testing Alarms.....	60
Monitoring Window.....	15	Alarm and Event Log	63
3. Therapy Modes and Controls.....	17	7. Device Options	65
Overview	17	Device Settings	65
Control Modes	19	Calibration	66
Spontaneous Modes	21	Data Transfer.....	68
Mixed Modes	23	Information	70
Therapy Features	25	8. Cleaning and Disinfection	71
Therapy Actions	27	Exterior Cleaning and Disinfection	71
Therapy Control Settings	27	Cleaning the Detachable Battery.....	72
Dynamic Therapy Parameters.....	29	Rinsing the Air-Inlet Foam Filter	72
4. Device Setup	31	External Active Exhalation Valve Cleaning and Disinfection	73
Setup Overview.....	31	9. Service and Maintenance	75
Placement.....	31	Service	75
Connecting AC Power	31	Disposal	75
Installing Filters.....	31	Routine Maintenance.....	75
Connecting a Circuit.....	33	Replacing the Air-Inlet Foam Filter	75
Adding Oxygen.....	35	Replacing the Particulate Filter	76
Starting Trilogy Evo Universal	36	Preparing the Device for a Use by a Different Patient..	76
5. Device Operation	37	10. Trilogy Evo Universal Accessories.....	77
Clinical Assessment.....	37	Power Accessories.....	77
Entering New Patient Information.....	37	Patient Monitors	77
About Prescriptions	37	Filters.....	80
Starting and Stopping Ventilation.....	39	Patient Circuits	81
Actions during Ventilation	39	Circuit Accessories.....	81
		Dual Limb Active Exhalation Valve	82
		Oxygen	82
		Portability and Travel Accessories.....	83

11. Power Management	84	Specifications	88
Power Sources	84	Standards Compliance.....	91
Battery Power Indicator.....	84	Pneumatic Diagram	92
Battery Status Indicator.....	84	EMC Information.....	92
AC Power.....	84	13. Wireless Connectivity.....	96
External Battery	85	Bluetooth Actions.....	96
Detachable Battery	85	NFC Actions	97
Internal Battery	86	Troubleshooting	97
Power Loss.....	86	14. Glossary.....	98
Power Indicator Icons	86	15. Warranty	100
12. Technical Specifications	88		

DRAFT 01/26/2018

1. Introduction

The Trilogy Evo Universal ventilator is a medical device intended for use by qualified, trained personnel under the direction of a physician according to its technical specifications.

Intended Use

The Trilogy Evo Universal ventilator provides invasive and non-invasive positive pressure ventilation for the care of patients ≥ 2.5 kg through adults. The ventilator can measure, display, record, and alarm SpO₂, FiO₂, CO₂, respiratory rate, and pulse rate data when integrated with the appropriate accessories. The ventilator is suitable for use in institutional and hospital settings and non-emergency transport settings; for example, wheelchair, personal vehicle, or ambulance.

Environments of Use

The Trilogy Evo Universal ventilator is intended to be used:

- In institutional environments.
- While attached to a wheelchair, bedrail, gurney, roll stand, or sitting on a flat surface such as a table or nightstand.
- While transporting patients within and between facilities such as automobile or commercial aircraft.

Contraindications

If the patient has any of the following conditions, consult the patient's health care professional before using noninvasive ventilation:

- An inability to maintain a patent airway or adequately clear secretions
- At risk to aspirate gastric contents
- Acute sinusitis or otitis media
- Epistaxis, causing pulmonary aspiration of blood
- Hypotension

Package Contents

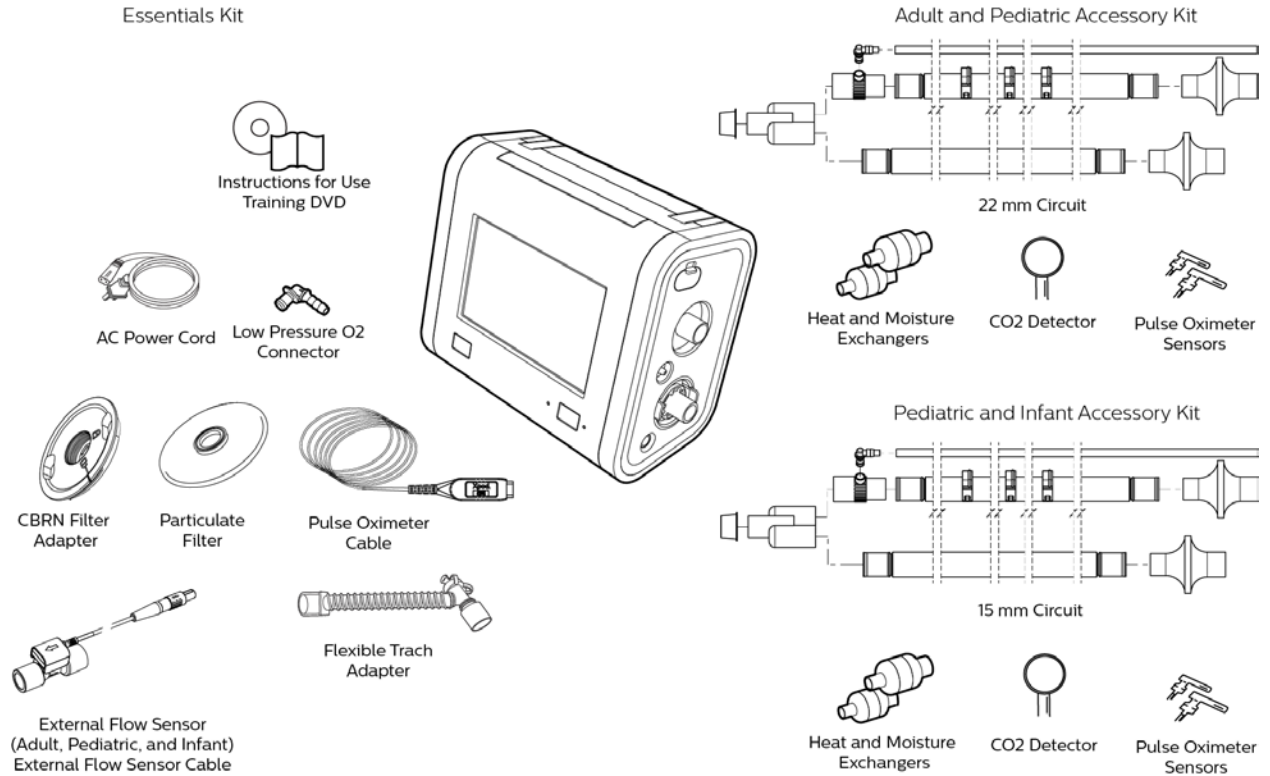

Warnings



Environmental

- You should not operate Trilogy Evo Universal in the presence of flammable gasses.
- Do not cover the ventilator or place in a position that affects proper operation.
- Do not block the cooling and intake air vents.
- Do not operate Trilogy Evo Universal in an environment that is outside the specified ranges. Using the ventilator outside of this temperature range or above this altitude can affect the ventilator performance.
- The blower warms the temperature of the airflow. Use of the device at room temperatures warmer than 40°C may cause thermal irritation.
- Do not expose the device or detachable battery to temperatures above 60° C (140° F) during use or above 70° C (158° F) during storage. This will reduce battery life and may increase the risk of fire or damage the battery.
- The Trilogy Evo Universal is not intended for MRI or anesthesia applications, and is not intended to be permanently mounted in EMS vehicles.
- When disposing of this device or any accessories, ensure you comply with your local regulations. Dispose of any potentially biohazardous waste according to your local regulations.

- This device is intended for use in the electromagnetic environment specified in the “EMC Information” chapter. Ensure the environment is compatible. Portable and mobile RF communications equipment, including cables, should be no closer to any part of the device than the recommended separation distance indicated in the “EMC Information” chapter.
- This device is not made with natural rubber latex.
- Do not use the ventilator in a hyperbaric chamber.
- Do not use the ventilator in the presence of nitric or nitrous oxide.
- Do not use the ventilator with helium or in the presence of mixtures in combination with helium.
- Route all cables in a manner to prevent injury, such as tripping or strangulation, to the patient and caregiver.

Clinical

- Before placing a patient on the ventilator, perform a clinical assessment. Considerations should include:
 - Choosing alarm settings
 - Whether alternative ventilation equipment is required
 - Whether alternative monitors are required, such as Vte monitoring for Active PAP circuit, pulse oximeter or respiratory monitor with alarm
- Trilogy Evo Universal is a restricted medical device. It is designed for use by respiratory therapists or other trained and qualified caregivers under the supervision of a physician. Only the supervising physician’s orders authorize changes to the prescription and other device settings. Before using Trilogy Evo Universal, you must read and understand this manual.
- When using the ActivePAP circuit, CO₂ monitoring is required to measure exhaled carbon dioxide, in accordance with ISO 80601-2-55.
- Unintentional leaks cause exhaled volume and expired CO₂ values to differ from actual patient values.
- The caregiver or health care professional is responsible for verifying any changes to the device, prescription, or other settings before applying changes. The caregiver or health care professional is responsible for ensuring settings are correct and compatible with the patient. Using the wrong prescription for a patient may result in improper therapy, lack of appropriate safety monitoring, or risk of death or injury to the patient.

Alternate Ventilation

- To avoid patient death or serious injury, ventilator-dependent patients require immediate access to alternate ventilation equipment, such as a back-up ventilator or manual resuscitator.
- Qualified personnel should monitor ventilator-dependent patients continuously. Personnel should be prepared to provide alternate therapy in the event of ventilator failure or inoperative equipment.

Alarms

- Do not rely on any single alarm to detect a disconnected circuit.
- Respond immediately to any high priority alarm. It may indicate a potentially life-threatening condition.
- Visually monitor the patient and ventilator at all times during an Alarm Silence period. Allowing alarms to continue without intervention may result in harm to the patient.
- If the high-priority Low Battery alarm occurs, immediately connect the ventilator to an alternate power source. If no alternate power source is available, immediately place the patient on an alternate source of ventilation.
- When using a remote alarm, make sure you fully test the remote alarm connector and cable by verifying that:
 - You can hear the ventilator’s audible alarms on the remote alarm.
 - The remote alarm signals when you disconnect the remote alarm cable from the ventilator or from the remote alarm
- Test the operation of the circuit disconnect function daily and whenever the patient circuit is changed. An increase in circuit resistance can prevent proper operation of some alarms.

- Speaking valves, heat moisture exchangers (HMEs), humidifiers, and filters create additional circuit resistance and may affect the performance of alarms chosen for circuit disconnect protection.
- Do not set the Low Peak Inspiratory Pressure alarm too low, or the system may not detect large circuit leaks or a patient disconnect.

Accessories

- Use Trilogy Evo Universal only with accessories intended for use with this device. Otherwise, adverse performance including increased electromagnetic emissions or decreased electromagnetic immunity of this equipment can occur. For a list of accessories, such as patient interfaces, circuits, exhalation ports, and cables, see the Trilogy Evo Universal accessories guide. Ensure accessories and parts are compatible before you connect a patient to the device. Consult the accessory's instructions before use.
- The air-inlet foam filter is required to protect the ventilator from dirt and dust. See the "Service and Maintenance" chapter for maintenance instructions.
- Be certain that any breathing system filter used with this device complies with ISO 23328-1 and ISO 23328-2. To prevent patient or ventilator contamination, we recommend you use a Respiroics-approved main flow bacteria filter (Part Number 342077) on the patient gas outlet port. Filters not approved by Respiroics may degrade system performance.
- When adding any components (such as humidifiers, speaking valves, heat moisture exchangers, and filters) to the breathing system, consider the flow resistance and dead space in relation to the potential for adverse effects on the patient's ventilator management and device alarms.
- Nebulization or humidification can increase the resistance of breathing system filters. Monitor the breathing system frequently for increased resistance and blockage.
- Gas added by the use of a pneumatic nebulizer can adversely affect ventilator accuracy.
- When using a passive circuit an exhalation port is required. At low expiratory pressures, the flow through the exhalation port may be inadequate to clear all exhaled gas from the tubing – some rebreathing may occur.
- Do not use antistatic or conductive hoses or conductive patient tubing with the device.
- The ventilator system (used with patient circuit accessories, such as patient interface devices, humidifiers, water traps, and circuit tubing) may contain small parts that could result in a choking hazard.
- Be certain that any humidifier in use, including any heated breathing tube, complies with ISO 8185.

Oxygen

- This device is equipped with an oxygen blender that can deliver oxygen to the patient within a range of 21-100% concentration.
- To ensure accuracy of oxygen administration when using the oxygen blender, use the internal FiO₂ accessory or an external oxygen monitor that complies with ISO 80601-2-55 to verify the oxygen concentration in the delivered gas.
- Substantial leaks may reduce the inspired oxygen concentration to less than the expected value. Use appropriate patient monitoring, as medically indicated, such as an alarming pulse oximeter.
- Do not connect the device to an unregulated oxygen source.
- Do not use oxygen while smoking or in the presence of an open flame.
- Turn off the oxygen flow when the device is not in use.

Cleaning and Maintenance

- To avoid electric shock, do not remove the enclosure cover. Only service personnel should remove the enclosure.
- Do not immerse the device or allow liquids into any of the controls or the interior of the enclosure as the device may be damaged. If this occurs, contact your equipment provider for assistance. Use only the agents and methods described in

this manual to clean and disinfect the device. After cleaning and disinfecting, ensure the device is completely dry before reattaching accessories and connectors and before reconnecting it to a power source. Do not use solvents, polishes, or any oily substances on the device, as they are flammable.

- If the device has been exposed to rain or dampness, dry the device including the area around the power cord connection with the power cord disconnected from the device before applying AC power.
- Repairs and adjustments must be performed by service personnel only. Unauthorized service could cause death or injury, invalidate the warranty, or result in costly device damage.
- If you notice any unexplained changes in the performance of the device, if it is making unusual sounds, if the device or detachable battery is dropped, if water is spilled into the enclosure, or if the enclosure is cracked or broken, discontinue use and contact Philips Respironics.
- To avoid electrical shock, always unplug the power cord from the wall outlet before cleaning the ventilator.
- Periodically inspect electrical cords, cables, and the detachable battery pack for damage or signs of wear. Discontinue use and replace if damaged.
- No modification of this equipment is allowed. Any changes or modifications made to the device that are not expressly approved by Respironics may void the user's authority to operate the equipment.























Power





















- Do not connect the ventilator to the battery of a battery-powered wheelchair as this can affect the ventilator performance, which can result in patient death.
- An external battery should only be connected to the ventilator using the Philips Respironics approved External Battery Cable. This cable is fused, pre-wired, and properly terminated to ensure safe connection



Symbols Glossary



This glossary contains the symbols on the model label and on the device exterior. Software symbol explanations appear throughout this book. For a complete explanation of symbols appearing on the device and associated labels, go to the following web address:

<http://www.symbols.philips.com>

Symbol	Definition
Symbols on the Model and Warning Label	
	Refer to instruction manual
	Prescription device
	Not made with natural rubber latex
	For airline use. Complies with RTCA D0160 section 21, category M
	Bluetooth symbol
	This equipment includes RF transmitters.
IP22	IP22: protection against finger-sized objects and protected against dripping water when tilted up to 15 degrees.
	Catalog number
	Batch code
	Serial number
	Manufacturer
	Date of manufacture
	Class II equipment
	BF applied part
	LI-ion recycling
	Waste electrical & electronic equipment
	Humidity limit
	Temperature limit
Symbols on the Device	
	On/Off (Standby) button
	Alarm Silence button
	USB connection
	Nurse call connection
	DC power (direct current)
	AC power (alternating current)

Symbol	Definition
	Oxygen inlet
	Low flow oxygen inlet
	Flow sensor cable connection
	Proximal pressure out
	AEV control line
	Patient in
	Patient out
Symbols on the Screen - General	
	Prescription settings
	Home screen
	Options
	Help
	Manual breath
	Deliver 100% oxygen
	Delete prescription
	Patient type indicators
	Touch screen lock
	Edit
	Wi-Fi
Symbols on the Screen - Alarms	
	Alarms tab
	Alarm Silence
	High priority alarm

	Medium or low priority alarm
	System message
 Reset	Alarm reset
Symbols on the Screen – Monitoring Views	
See chapter 2, “About Trilogy Evo.”	
Symbols on the Screen - Power	
See the Power Management chapter.	
Symbols on the Screen –Connectivity	

	Bluetooth enabled
	Bluetooth connected
	USB is exporting data

DRAFT 01/26/2018

How to Contact Philips Respironics

If you need help setting up, using or maintaining Trilogy Evo Universal, or if this device does not perform as expected, contact Philips Respironics. Call Philips Respironics Customer Service at:

- 1-724-387-4000
- 1-800-345-6443 (toll-free)
- +49 8152 93060 (international)

Respironics Inc.
1001 Murry Ridge Lane
Murrysville, PA 15668 USA



Respironics Deutschland
Gewerbestrasse 17
82211 Herrsching, Germany



DRAFT 01/26/2018

2. About Trilogy Evo Universal

Parts of Trilogy Evo Universal

Front Panel

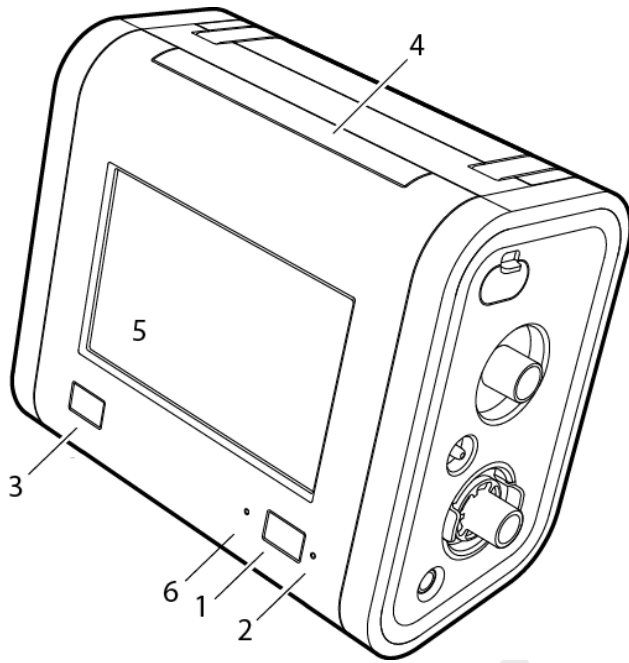

1. On/off (standby) button
2. AC power indicator
3. Alarm indicator/alarm silence
4. Alarm bar
5. Touch screen
6. Ambient light sensor

Back Panel

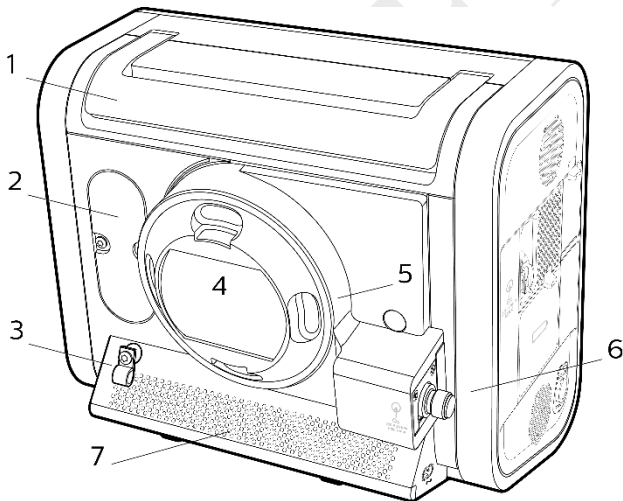

1. Carrying handle
2. FiO₂ sensor access panel
3. Power cord retention clip
4. Air inlet
5. Oxygen blender
6. High pressure oxygen inlet
7. Air vents

Patient Panel

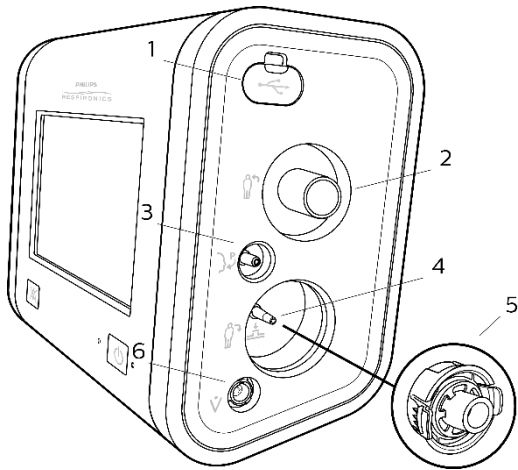

1. Accessory USB port
(pulse oximeter, CO₂ monitor)
2. Inspiratory port (*to* patient)
3. Proximal pressure port
4. Active exhalation valve line connection for
ActivePAP and Active Flow circuits
5. Dual limb active exhalation valve connection (*from*
patient)
6. Flow sensor cable connector

Utility Panel

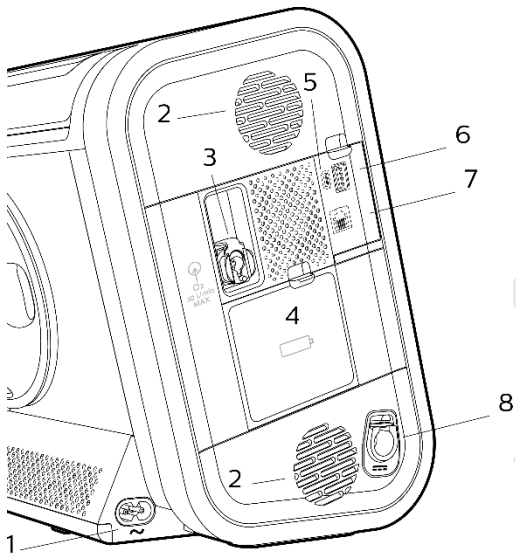

1. AC power connector
2. Air vents
3. Low flow oxygen inlet
4. Detachable battery access door
5. Micro USB Port for device service
6. Accessory USB Port (USB external storage
device, communication cables)
7. Remote alarm or nurse call connector (RJ9)
8. DC power connector

Parts of the User Interface

Standard Screen Elements



1. Menu bar
2. Main window
3. Monitored parameters pane
4. Status bar

Menu Bar



Use the menu bar to navigate, manage alarms, and see the active prescription at a glance.

1. Home: view the main window
2. Prescriptions: manage patient prescriptions
3. Options:
 - Device Settings
 - Calibration
 - Data Transfer
 - Information
 - Alarm & Event Log
4. Patient type indicator

Main Window

The main window contents vary depending on the action you are performing. The main window can show the standby window, prescription window, monitoring window, and others.

Monitored Parameters Pane

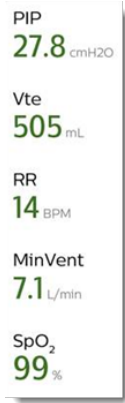

Use the monitored parameters pane to see measured and calculated values while delivering therapy. These values vary based on the circuit, therapy mode, and accessory type.

Depending on the accessories you use, values such as SpO₂ appear during active ventilation and during standby.

Parameters that may appear are:

- PIP: peak inspiratory pressure
- Vte: exhaled tidal volume
- RR: respiratory rate
- MinVent: minute ventilation
- SpO₂: saturation of peripheral oxygen
- Pulse Rate
- etCO₂: end tidal carbon dioxide

Status Bar



Use the status bar to monitor device status and the availability of manual therapeutic actions.

1	Manual breath	8	Wi-Fi
2	Deliver 100% Oxygen	9	Alarm silence
3	100% Oxygen timer	10	Power sources and their status
4	CMD	11	
5	USB data transfer	12	
6	Bluetooth	13	Device Actions Menu
7	Bluetooth data transfer	14	System time

Monitoring Window

During ventilation, a monitoring window, or home screen, contains information such as measured parameters and battery status. You can select the type of information you want to see.

Selecting a Monitoring View

To select a monitoring view during ventilation:













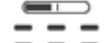



1. In the **Menu Bar**, tap the **Home** button. 
2. In the monitoring window, tap the **Views** button



3. In the **Views** menu, tap the type of view you want to use.

Types of monitoring windows

Monitoring windows may vary based on your model.

Views menu icon	Monitoring window contents										
 Small manometer	<ul style="list-style-type: none"> - Manometer pressure indicator - Set parameters 										
 Measured and calculated parameters	<ul style="list-style-type: none"> - Set parameters - Measured and calculated parameters - Additional parameters based on the prescription (including accessories) - <i>This is the default view.</i> An explanation of dynamic parameters is in chapter 3, "Therapy Modes."										
 Large manometer	<ul style="list-style-type: none"> - Large manometer pressure indicator - Six measured and calculated parameters 										
 Waveform graphs	<ul style="list-style-type: none"> - Customizable scalar waveform graphs To customize the graphs, use the buttons in the window as follows: <table border="1" data-bbox="349 861 998 1239"> <thead> <tr> <th data-bbox="349 861 617 892">Button</th> <th data-bbox="617 861 998 892">Description</th> </tr> </thead> <tbody> <tr> <td data-bbox="349 892 617 1008">  </td> <td data-bbox="617 892 998 1008"> Select the waveforms to graph. On the Select Waveforms dialog box, select data for the top and bottom graphs. </td> </tr> <tr> <td data-bbox="349 1008 617 1081">  </td> <td data-bbox="617 1008 998 1081"> Pause graphing. </td> </tr> <tr> <td data-bbox="349 1081 617 1155">  </td> <td data-bbox="617 1081 998 1155"> Automatically size the vertical scale to fit the data. </td> </tr> <tr> <td data-bbox="349 1155 617 1239">  </td> <td data-bbox="617 1155 998 1239"> Tap to change the time scale, and then select a new time scale from the list. </td> </tr> </tbody> </table>	Button	Description		Select the waveforms to graph. On the Select Waveforms dialog box, select data for the top and bottom graphs.		Pause graphing.		Automatically size the vertical scale to fit the data.		Tap to change the time scale, and then select a new time scale from the list.
Button	Description										
	Select the waveforms to graph. On the Select Waveforms dialog box, select data for the top and bottom graphs.										
	Pause graphing.										
	Automatically size the vertical scale to fit the data.										
	Tap to change the time scale, and then select a new time scale from the list.										

3. Therapy Modes and Controls

Overview

Trilogy Evo Universal therapy modes can be used for invasive and noninvasive ventilation with all circuit types, including mouthpiece ventilation.

Breath Types

Trilogy Evo Universal can deliver the following breath types:

- *Mandatory*: Ventilator-initiated, time-cycled
- *Assist-Control*: Patient-initiated, time-cycled
- *Spontaneous*: Patient-initiated, patient-cycled

Triggering and Cycling

Patient triggers

Auto-Trak is a flow trigger with rules that make patient-triggering and cycling more comfortable for the patient. The system uses multiple algorithms to detect the start and end of the breath. Also, it automatically adjusts the trigger and cycle sensitivity to optimize synchronization between the patient and the ventilator.

Sensitive Auto-Trak is a more sensitive version of Auto-Trak

Flow trigger initiates a breath when the patient's inspiratory effort creates a flow equal to or greater than the flow trigger sensitivity setting. A lower number is more sensitive. As inspiratory flow begins to decrease, the device cycles to expiration when the patient flow is less than the percentage of peak flow, based on the flow-cycle sensitivity setting.

Ventilator trigger

Time Trigger is time-based, defined by the Breath Rate setting.

Flow patterns

Ramp wave pattern: airflow starts high and decreases throughout inspiration of the breath.

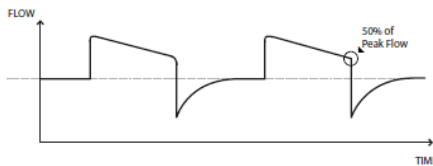

Square wave pattern: airflow is generally constant throughout inspiration of the breath.

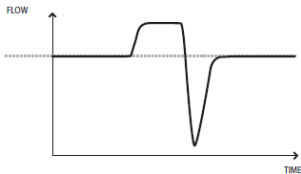

Therapy Modes Overview

Control Modes: breaths are assist-control or mandatory.

- A/C-PC: Assist control – assist-control and mandatory breaths with pressure control
- A/C-VC: Assist control – assist control and mandatory breaths with volume control

Spontaneous modes: the patient initiates all breaths.

- CPAP: Continuous positive airway pressure
- PSV: Pressure support ventilation

Mixed modes: breaths are spontaneous, assist-control, or mandatory.

- S/T: Spontaneous/timed ventilation – spontaneous breaths with pressure support and mandatory breaths with pressure control
- SIMV-PC: Synchronized intermittent mandatory ventilation (pressure control) – spontaneous breaths with pressure support, assist–control breaths and mandatory breaths with pressure control
- SIMV-VC: Synchronized intermittent mandatory ventilation (volume control) – spontaneous breaths with pressure support, assist–control breaths and mandatory breaths with volume control

Low Tidal Volume Therapy

For low tidal volume therapy, use the infant/pediatric external flow sensor. See the instructions included with the sensor.

When setting volumes greater than or equal to 50ml, use any circuit type.

When setting volumes greater than or equal to 35ml, use either the active flow or dual limb circuits.

The following pressure modes are available for patients who require a tidal volume less than 35ml:

- A/C-PC
- PSV
- S/T
- SIMV-PC

Therapy Mode Comparison Table

For all modes, the breath type varies based on time of patient inspiration. The breath type is always ventilator-initiated and mandatory when the Trigger Type is set to Off.

Mode	Breath Types	Trigger Source	Inspiration	Cycle	Exhalation
Control Modes					
A/C-PC	Assist-Control	Patient	Pressure Control + PEEP	Inspiratory Time	PEEP
	Mandatory	Ventilator (Breath Rate)			
A/C-VC	Assist-Control	Patient	Tidal Volume	Inspiratory Time	PEEP
	Mandatory	Ventilator (Breath Rate)			
Spontaneous Modes					
CPAP	Spontaneous	Patient	CPAP	Patient	CPAP
PSV	Spontaneous	Patient	Pressure Support + PEEP	Patient	PEEP
Mixed Modes					
S/T	Spontaneous	Patient	IPAP	Patient	EPAP
	Mandatory	Ventilator (Breath Rate)		Inspiratory Time	
SIMV-PC	Spontaneous	Patient	Pressure Support + PEEP	Patient	PEEP
	Assist-Control	Patient	Pressure Control + PEEP	Inspiratory Time	PEEP
	Mandatory	Ventilator (Breath Rate)			
SIMV-VC	Spontaneous	Patient	Pressure Support + PEEP	Patient	PEEP
	Assist-Control	Patient	Tidal Volume	Inspiratory Time	PEEP
	Mandatory	Ventilator (Breath Rate)			

Control Modes

A/C-PC: Assisted/Control-Pressure Control

DESCRIPTION:

The A/C-PC mode provides pressure-controlled mandatory or assist-control breaths. When the Trigger Type is set to *Off*, the ventilator triggers and cycles all breaths. When the Trigger Type is not set to *Off*, then the ventilator or the patient can trigger a breath, and the ventilator cycles all breaths.

SETTINGS:

Setting Name	Description
Pressure Control	Inspiratory pressure above PEEP
PEEP	Positive end expiratory pressure
Rise Time	Time required for the ventilator to change from the expiratory pressure setting to the inspiratory pressure setting when the breath is triggered.
Breath Rate	Minimum rate of breaths per minute
Inspiratory Time	Length of the inspiratory phase
Trigger Type	<ul style="list-style-type: none"> • Auto-Trak (passive circuits only) • Sensitive Auto-Trak (passive circuits only) • Flow Trigger (Passive, Active PAP, Active Flow, or Dual Limb circuits) • Off
Flow Trigger Sensitivity	This control is available when the trigger type is Flow Trigger. The flow trigger initiates when the patient's inspiratory effort creates a flow equal to or greater than the flow trigger sensitivity setting.
Flow Cycle Sensitivity	This control is available when the trigger type is Flow Trigger. As flow begins to decrease during inspiration, if the patient flow is less than the flow cycle set point, the device cycles to expiration.
FiO ₂ (optional)	Requires model with oxygen blender

SETTABLE ALARMS:

- Circuit disconnect
- High tidal volume
- Low tidal volume
- High minute ventilation
- Low minute ventilation
- High respiratory rate
- Low respiratory rate

ILLUSTRATION

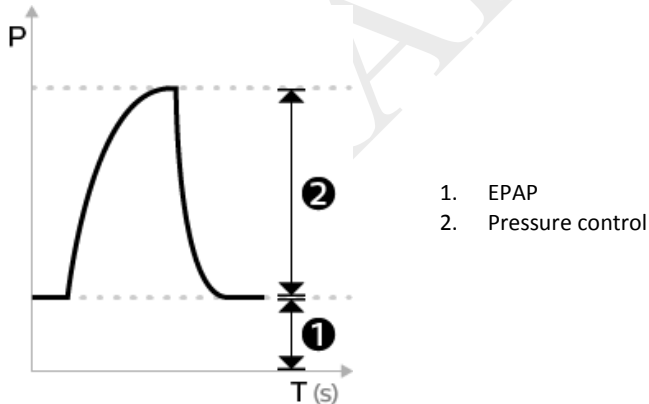

A/C-VC: Assisted/Control-Volume Control

DESCRIPTION:

The A/C-VC mode provides volume-controlled mandatory and assist breaths. When the Trigger Type is set to Off, both triggering and cycling are performed by the ventilator. When the Trigger Type is not Off, then the trigger can be performed by the vent or patient and the cycle is always performed by the ventilator. To deliver the set volume in the set time, the ventilator alters the flow rate. The flow pattern setting defines the shape of the flow delivery pattern.

SETTINGS:

Setting Name	Description
Tidal Volume	Set inspiratory volume
PEEP	Positive end expiratory pressure
Inspiratory Time	Length of the inspiratory phase
Breath Rate	Minimum rate of mandatory breaths per minute
Flow Pattern	Sets the shape of the waveform as a ramp or square
Trigger Type	<ul style="list-style-type: none"> • Auto-Trak • Sensitive Auto-Trak (passive circuits only) • Flow Trigger (Passive, Active PAP, Active Flow, or Dual Limb circuits) • Off
Flow Trigger Sensitivity	This control is available when the trigger type is Flow Trigger. The flow trigger initiates when the patient's inspiratory effort creates a flow equal to or greater than the flow trigger sensitivity setting.
Flow Cycle Sensitivity	This control is available when the trigger type is Flow Trigger. As flow begins to decrease during inspiration, if the patient flow is less than the flow cycle set point, the device cycles to expiration.

SETTABLE ALARMS:

- Circuit disconnected
- High tidal volume
- Low tidal volume
- High minute ventilation
- Low minute ventilation
- High respiratory rate
- Low respiratory rate
- High inspiratory pressure
- Low inspiratory pressure

ILLUSTRATION

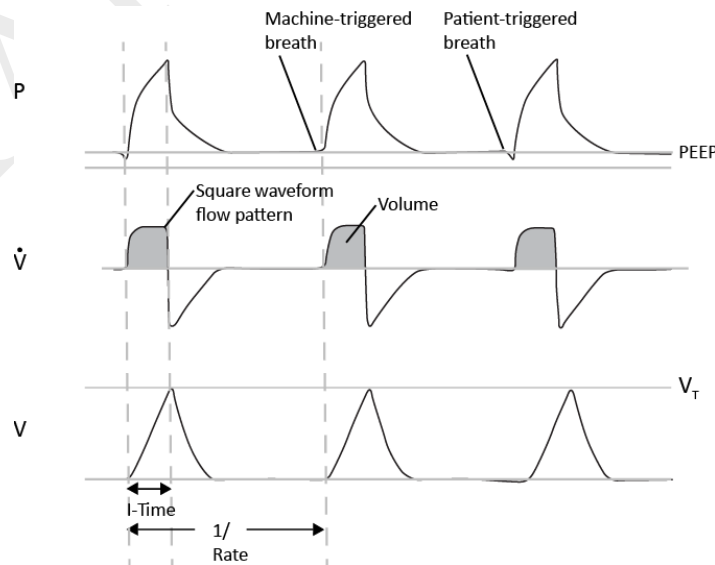

Spontaneous Modes

CPAP: Continuous Positive Airway Pressure

DESCRIPTION:

In CPAP mode, the pressure delivered to the patient during both inhalation and exhalation is the CPAP pressure setting. All breaths in this mode are spontaneous breaths. The ventilator monitors inspiratory and expiratory tidal volume.

SETTINGS:

Setting Name	Description
CPAP	Continuous positive airway pressure range
Trigger Type	<ul style="list-style-type: none"> • Auto-Trak • Sensitive Auto-Trak (passive circuits only) • Flow Trigger (Passive, Active PAP, Active Flow, or Dual Limb circuits)
Flow Trigger Sensitivity	This control is available when the trigger type is Flow Trigger. The flow trigger initiates when the patient's inspiratory effort creates a flow equal to or greater than the flow trigger sensitivity setting.
Flow Cycle Sensitivity	This control is available when the trigger type is Flow Trigger. As flow begins to decrease during inspiration, if the patient flow is less than the flow cycle set point, the device cycles to expiration.

SETTABLE ALARMS:

- Circuit disconnected
- High tidal volume
- Low tidal volume
- High minute ventilation
- Low minute ventilation
- High respiratory rate
- Low respiratory rate

ILLUSTRATION

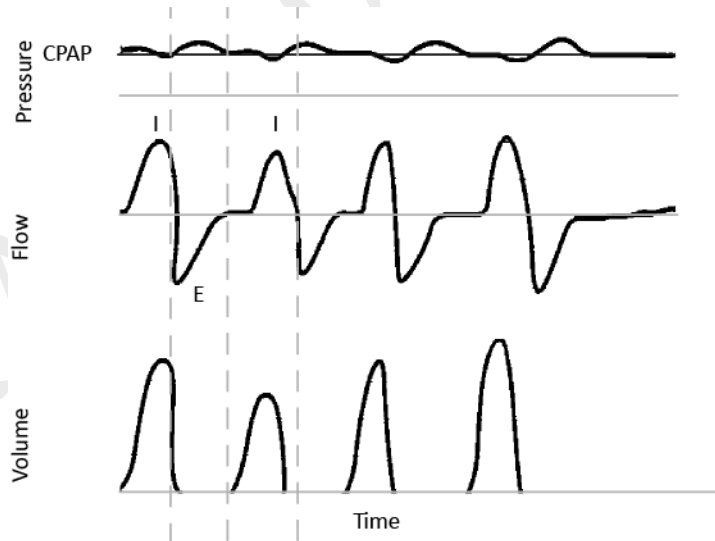

PSV: Pressure Support Ventilation

DESCRIPTION:

PSV mode is patient-triggered, pressure-limited, and flow-cycled. With this strategy, breaths are assisted by a set inspiratory pressure that is delivered until inspiratory flow drops below a set threshold.

In the PSV mode, the ventilator delivers spontaneous, pressure-supported, breaths and user-initiated mandatory breaths. The ventilator functions as a demand flow system, with the patient triggering breaths and determining their timing and volume. The ventilator can support the breaths with the set pressure support.

The Pressure Control setting defines the applied pressure above PEEP. The patient determines the breath timing. As in other dual limb modes, you also set PEEP, inspiratory trigger, and O₂. It is recommended that you set backup ventilation in PSV mode.

SETTINGS:

Setting Name	Description
Pressure Support	Target pressure that the device delivers during the inspiratory phase of a spontaneous breath
PEEP	Positive end expiratory pressure
Rise Time	Time required for the ventilator to change from the expiratory pressure setting to the inspiratory pressure setting when the breath is triggered.
Trigger Type	<ul style="list-style-type: none"> • Auto-Trak • Sensitive Auto-Trak (passive circuits only) • Flow Trigger (Passive, Active PAP, Active Flow, or Dual Limb circuits)
Flow Trigger Sensitivity	This control is available when the trigger type is Flow Trigger. The flow trigger initiates when the patient's inspiratory effort creates a flow equal to or greater than the flow trigger sensitivity setting.
Flow Cycle Sensitivity	This control is available when the trigger type is Flow Trigger. As flow begins to decrease during inspiration, if the patient flow is less than the flow cycle set point, the device cycles to expiration.

SETTABLE ALARMS:

- Circuit disconnected
- High tidal volume
- Low tidal volume
- High minute ventilation
- Low minute ventilation
- High respiratory rate
- Low respiratory rate

ILLUSTRATION:

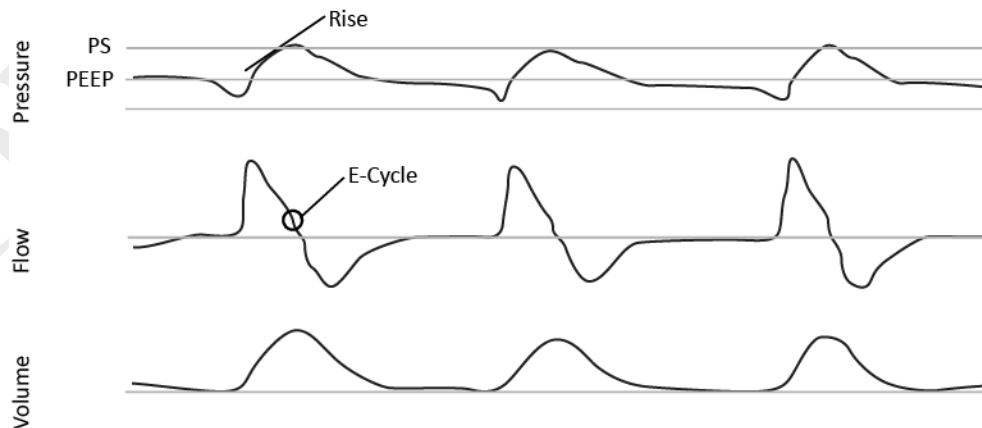

Mixed Modes

S/T: Spontaneous/Timed

DESCRIPTION:

A bi-level therapy mode where each breath is patient-triggered and patient-cycled or ventilator-triggered and ventilator-cycled. In this mode, an IPAP is delivered during inhalation and a lower EPAP is delivered during exhalation. The duration of a spontaneous breath is determined by the patient effort. The duration of a mandatory breath is determined by the inspiratory time setting. Remember that the IPAP setting is the maximum pressure the ventilator will deliver; it is not in addition to the EPAP setting.

SETTINGS:

Setting Name	Description
IPAP	Inspiratory positive airway pressure Must be greater than or equal to EPAP
EPAP	Expiratory positive airway pressure
Rise Time	Time required for the ventilator to change from the expiratory pressure setting to the inspiratory pressure setting when the breath is triggered.
Breath Rate	Minimum rate of breaths per minute. If the patient doesn't trigger a breath within this time, the ventilator triggers the breath.
Inspiratory Time	For a mandatory breath, length of the inspiratory phase
Trigger Type	<ul style="list-style-type: none"> Auto-Trak Sensitive Auto-Trak (passive circuits only) Flow Trigger (Passive, Active PAP, Active Flow, or Dual Limb circuits)
Flow Trigger Sensitivity	This control is available when the trigger type is Flow Trigger. The flow trigger initiates when the patient's inspiratory effort creates a flow equal to or greater than the flow trigger sensitivity setting.
Flow Cycle Sensitivity	This control is available when the trigger type is Flow Trigger As flow begins to decrease during inspiration, if the patient flow is less than the flow cycle set point, the device cycles to expiration.

SETTABLE ALARMS:

- Circuit disconnect
- High tidal volume
- Low tidal volume
- High minute ventilation
- Low minute ventilation
- High respiratory rate
- Low respiratory rate

ILLUSTRATION:

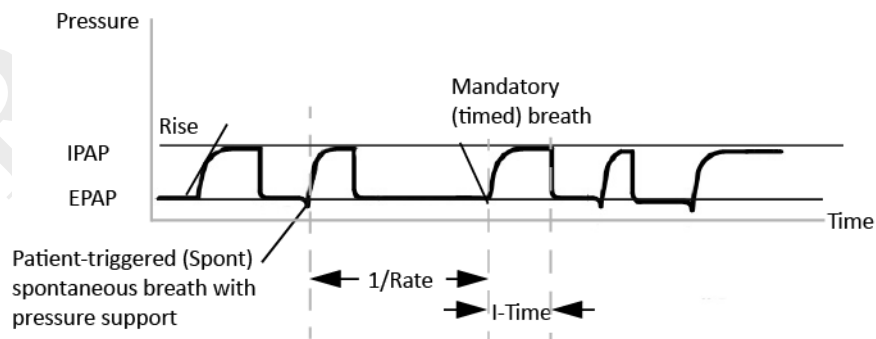

SIMV-PC: Synchronous Intermittent Mandatory Ventilation- Pressure Control

DESCRIPTION:

SIMV-PC mode is a pressure control mode that provides a mixture of mandatory and spontaneous breaths. SIMV-PC mode guarantees one mandatory breath in each cycle. Spontaneous breaths can be delivered with pressure support. The breath rate determines the length of the cycle. The first phase of the cycle is reserved for synchronizing a mandatory breath with patient effort. If the patient triggers a breath during this phase of the cycle, the ventilator delivers a synchronized mandatory breath. If a patient does *not* trigger a breath during the mandatory phase of the cycle, then the ventilator delivers a mandatory breath. Breaths triggered by the patient after the mandatory breath in the cycle are spontaneous breaths. This process is repeated at the start of every cycle.

SETTINGS:

Setting Name	Description
Pressure Control	Defines the applied pressure for all breaths
Pressure Support	Target pressure that the device delivers during the inspiratory phase of a spontaneous breath
PEEP	Positive end expiratory pressure Positive pressure maintained in the patient circuit during exhalation: must be less than or equal to the pressure setting.
Inspiratory Time	For a mandatory breath, length of the inspiratory phase
Rise Time	Time required for the ventilator to change from the expiratory pressure setting to the inspiratory pressure setting when the breath is triggered.
Breath Rate	Minimum rate of mandatory breaths per minute
Trigger Type	<ul style="list-style-type: none"> • Auto-Trak • Sensitive Auto-Trak (passive circuits only) • Flow Trigger (Passive, Active PAP, Active Flow, or Dual Limb circuits)
Flow Trigger Sensitivity	This control is available when the trigger type is Flow Trigger. The flow trigger initiates when the patient's inspiratory effort creates a flow equal to or greater than the flow trigger sensitivity setting.
Flow Cycle Sensitivity	This control is available when the trigger type is Flow Trigger As flow begins to decrease during inspiration, if the patient flow is less than the flow cycle set point, the device cycles to expiration.

SETTABLE ALARMS:

- Circuit disconnect
- High tidal volume
- Low tidal volume
- High minute ventilation
- Low minute ventilation
- High respiratory rate
- Low respiratory rate

ILLUSTRATION

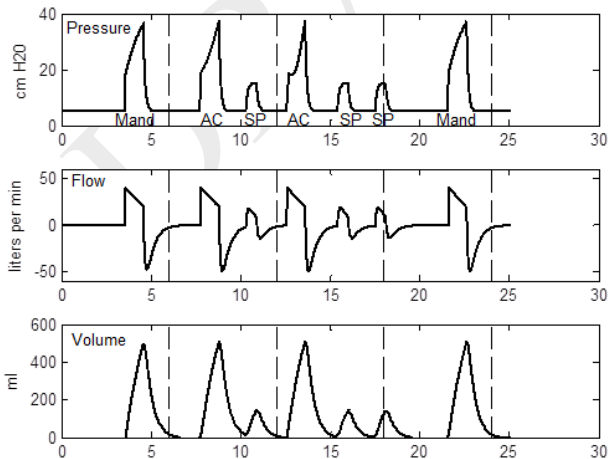

SIMV-VC: Synchronous Intermittent Mandatory Ventilation- Volume Control

DESCRIPTION:

Similar to SIMV-PC, but with volume control.

SETTINGS:

Setting Name	Description
Tidal Volume	Target gas volume that the device delivers during a spontaneous breath
Pressure Support	Target pressure that the device delivers during the inspiratory phase of a spontaneous breath
PEEP	Positive end expiratory pressure Positive pressure maintained in the patient circuit during exhalation: must be less than or equal to the pressure setting.
Inspiratory Time	For a mandatory breath, length of the inspiratory phase
Rise Time	Time required for the ventilator to change from the expiratory pressure setting to the inspiratory pressure setting when the breath is triggered.
Breath Rate	Minimum rate of mandatory breaths per minute
Flow Pattern	Sets the flow-pressure waveform
Trigger Type	<ul style="list-style-type: none"> • Auto-Trak • Sensitive Auto-Trak (passive circuits only) • Flow Trigger (Passive, Active PAP, Active Flow, or Dual Limb circuits)
Flow Trigger Sensitivity	This control is available when the trigger type is Flow Trigger. The flow trigger initiates when the patient's inspiratory effort creates a flow equal to or greater than the flow trigger sensitivity setting.
Flow Cycle Sensitivity	This control is available when the trigger type is Flow Trigger As flow begins to decrease during inspiration, if the patient flow is less than the flow cycle set point, the device cycles to expiration.

SETTABLE ALARMS:

- Circuit disconnect
- High tidal volume
- Low tidal volume
- High minute ventilation
- Low minute ventilation
- High respiratory rate
- Low respiratory rate
- High inspiratory pressure
- Low inspiratory pressure

ILLUSTRATION

See SIMV-PC.

Therapy Features

The following features are available in addition to the therapy modes.

Backup Ventilation Enable

DESCRIPTION

Set the device to deliver ventilator-initiated breaths when patient-initiated breaths are not detected, based on the Apnea alarm interval. When you turn Backup Ventilation on, set an Apnea interval in the alarm settings tab. Within the apnea interval; if no breaths are triggered by the patient, the ventilator delivers breaths at the set pressure or volume based on the Backup Rate. When an Apnea alarm occurs, the ventilator automatically starts backup ventilation. When two consecutive patient-initiated breaths are detected, the ventilator automatically reverts to patient-initiated breaths.

Backup ventilation settings take precedence over standard therapy mode settings.

SETTINGS:

- Backup Ventilation (On/Off): when you turn this setting On, set an Apnea interval in the alarm settings tab.
- Backup Rate: when in backup ventilation, the backup breath rate takes precedence over any breath rate set in the therapy mode. The rate cannot be less than the Breath Rate set in the current therapy mode.
- Backup Inspiration Time (CPAP and PSV modes only) when in backup ventilation the Back Up Tinsp controls the duration of inspiration.
- Backup PS (CPAP mode only)
- Backup Rise Time (CPAP mode only)

To access the Backup Ventilation feature, in the **Prescription** window, tap **Advanced**. When you turn the feature on, the additional settings appear in the prescription window.

If Trigger Type is Off, this feature is unavailable.

APPLICABLE THERAPY MODES

- A/C-PC
- A/C-VC
- CPAP
- PSV
- S/T
- SIMV-PC
- SIMV-VC

Insp Time Min/Max Enable

DESCRIPTION

Set the minimum and maximum inspiratory time for pressure support breath types. This feature changes inspiration time from a constant to a variable value so you can select a range for the inspiration time.

The range allows the patient to have a chance to cycle. When the maximum time has passed with no patient-initiated breath, then the ventilator automatically cycles the breath.

To access this feature, in the **Prescription** window, tap **Advanced**. When you turn the feature on, the additional settings appear in the prescription window.

APPLICABLE THERAPY MODES

- PSV
- S/T
- SIMV-PC
- SIMV-VC

Sigh Enable

DESCRIPTION

Delivers a periodic, larger volume breath.

SETTINGS:

- Sigh (On/Off)
- Sigh Volume
- Sigh Frequency (deliver a sigh after X number of patient- or ventilator- triggered breaths)

To access the Sigh feature, in the **Prescription** window, tap **Advanced**. When you turn the feature on, the additional settings appear in the prescription window.

APPLICABLE THERAPY MODE

- A/C-VC

Therapy Actions

Oxygen Flush

DESCRIPTION

This feature requires the oxygen blender. When active, the device delivers 100% oxygen for two minutes. This feature functions independent of any oxygen blending setting. During an oxygen flush, the High FiO₂ alarm is disabled.

WORKING WITH OXYGEN FLUSH

To start an oxygen flush:

Tap 100% O₂ in the status bar and then tap Start. A timer appears that counts down the two minutes.

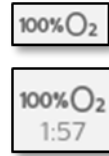

To stop an oxygen flush:

Tap 100% O₂ in the status bar and then tap Stop.

APPLICABLE THERAPY MODES

All

Manual Breath

DESCRIPTION

Delivers a breath based on the current therapy mode settings.

To deliver a manual breath:

Tap the Manual Breath button in the status bar and then tap Start.



APPLICABLE THERAPY MODES

- A/C-PC
- A/C-VC
- PSV
- S/T
- SIMV-PC
- SIMV-VC

Therapy Control Settings

Therapy control settings can be interdependent. For guidance, see the previous therapy mode descriptions.

Setting Name	Setting Range/Increment
Backup Pressure Support	Adult patient type: <ul style="list-style-type: none"> • All circuits but passive: 0-60 cmH₂O • Passive circuit: 0-57 cmH₂O • Increments: 1 cmH₂O
	Pediatric patient type: <ul style="list-style-type: none"> • All circuits: 0-30 cmH₂O • Increments: 1 cmH₂O
	Infant patient type:

Setting Name	Setting Range/Increment
	<ul style="list-style-type: none"> All circuits: 0-20 cmH₂O Increments: 1 cmH₂O
Breath Rate	Adult patient type: 0-80 BPM, 1BPM increments Pediatric patient type: 0-60 BPM, 1BPM increments Infant patient type: 0-40 BPM, 1 BPM increments
CPAP	Adult and pediatric patient types: 3-25 cmH ₂ O, 1 cm H ₂ O increments Infant patient type: 3-15 cmH ₂ O, 1 cm H ₂ O increments
EPAP Min/Max	Adult and pediatric patient types: 3-25 cmH ₂ O, 1 cm H ₂ O increments Infant patient type: 3-15 cmH ₂ O, 1 cm H ₂ O increments
FiO ₂	21-100%, 1% increments (21% = ambient condition, no control)
Flow Cycle Sensitivity	10-90%, 1% increments
Flow Pattern	Square: airflow is constant Ramp: inspiration airflow starts high and decreases
Flow Trigger Sensitivity	0.5 (high sensitivity) to 9 L/min (low sensitivity)
Inspiratory Time	Adult patient type: 0.5-5.0 seconds, 0.1 second increments Pediatric patient type: 0.3-2.0 seconds, 0.1 second increments Infant patient type: 0.3-1.0 seconds, 0.1 second increments
IPAP	Adult patient type: 3-60 cmH ₂ O, 1 cmH ₂ O increments Pediatric patient type: 3-45 cmH ₂ O, 1 cmH ₂ O increments Infant patient type: 3-35 cmH ₂ O, 1 cmH ₂ O increments
Max Pressure	<ul style="list-style-type: none"> 6-60 cmH₂O, 1 cmH₂O increments
PEEP	Adult patient type: <ul style="list-style-type: none"> Active circuit: 0-35 cmH₂O Passive circuit: 3-25 cmH₂O Increments: 1 cmH₂O
	Pediatric patient type: <ul style="list-style-type: none"> Active circuit: 0-25 cmH₂O Passive circuit: 3-25 cmH₂O Increments: 1 cmH₂O
	Infant patient type: <ul style="list-style-type: none"> Active circuit: 0-15 cmH₂O Passive circuit: 3-15 cmH₂O Increments: 1 cmH₂O
Pressure Control	Adult patient type: <ul style="list-style-type: none"> All circuits but passive: 0-60 cmH₂O Passive circuit: 0-57 cmH₂O Increments: 1 cmH₂O
	Pediatric patient type: <ul style="list-style-type: none"> All circuits: 0-30 cmH₂O Increments: 1 cmH₂O
	Infant patient type: <ul style="list-style-type: none"> All circuits: 0-20 cmH₂O Increments: 1 cmH₂O
Pressure Support	Adult patient type: <ul style="list-style-type: none"> All circuits but passive: 0-60 cmH₂O Passive circuit: 0-57 cmH₂O Increments: 1 cmH₂O
	Pediatric patient type: <ul style="list-style-type: none"> All circuits: 0-30 cmH₂O Increments: 1 cmH₂O
	Infant patient type: <ul style="list-style-type: none"> All circuits: 0-20 cmH₂O Increments: 1 cmH₂O
PS Min/Max	<ul style="list-style-type: none"> All circuits but passive: 0-60 cmH₂O Passive circuit: 0-57 cmH₂O Increments: 1 cmH₂O
Rise Time	0 (faster) to 6 (slower)
Tidal Volume	Adult patient type: 70-1200 ml Increment: 5 ml

Setting Name	Setting Range/Increment
	Pediatric patient type: Dual limb or active flow: 35-400 ml Passive or Active PAP: 50-400 ml Increment: 5 ml
Trigger Type	<ul style="list-style-type: none"> • Auto-Trak (passive circuits only) • Sensitive Auto-Trak (passive circuits only) • Flow Trigger (all circuits) • Off

Dynamic Therapy Parameters

It is unnecessary to perform an inspiratory hold to assess the plateau pressure and other lung parameters. The advanced measurement system of Trilogy Evo estimates lung compliance, airway resistance, AutoPEEP and plateau pressure during normal mechanical ventilation without requiring a static maneuver.

Dyn R

Airway resistance is the opposition to the motion of gas within the airways. In the Measured and Calculated Parameters window, this value is **Dyn R** (dynamic resistance), so named because it is estimated without requiring a static maneuver.

At the end of inhalation, Trilogy Evo estimates the airway resistance by computing the ratio between the driving pressure from within the lung to the air flow. The flow term is corrected to take into account the contributions of the following:

- Intrinsic PEEP, by subtracting the expiratory flow at the end of exhalation
- The elastic recoil of the lungs, by adding the tidal volume divided by the respiratory time constant, τ . (Respiratory time constant is the airway resistance times the summed compliance of the lung and chest wall)

Trilogy Evo calculates Dyn R using the following formula:

$$Dyn R = \frac{PIP - PEEP_e}{Q_p(t = EOI) - Q_p(t = EOE) + \frac{V_t}{\tau}}$$

Where:

- PIP is the peak inspiratory pressure (pressure at the end of inhalation)
- $PEEP_e$ is the extrinsic pressure (pressure applied by the ventilator) at the end of the breath
- V_t is the tidal volume
- $Q_p(t = EOE)$ is the patient flow at the end of the exhalation (EOE)
- $Q_p(t = EOI)$ is the patient flow at the end of inhalation (EOI)

To understand the calculations adopted to compute Dyn R, note that the above equation can be rewritten as the classic equation for airway resistance:

$$PIP - (PEEP + PEEP_i + V_t / Dyn C) = Dyn R * Q_p(SOE)$$

That is to say, pressure across the resistance equal to resistance times flow, where:

- $PEEP_i = -DynR * Q_p(EOE)$ this value is the intrinsic PEEP or AutoPEEP (see the section, "AutoPEEP" below)
- $PEEP + PEEP_i$ is the total pressure (extrinsic plus intrinsic) at the end of the breath

Dyn C

Lung Compliance is the ratio between the tidal volume and the changes in pressure. In the Measured and Calculated Parameters window, this value is Dyn C (dynamic compliance), so named because it is estimated without requiring a static maneuver.

Trilogy Evo estimates the integrated compliance of the pulmonary system, (the summed compliance of the lung and chest wall). The compliance of the respiratory system can be derived from the measurement of plateau pressure, P_{plat} , using the relationship between the tidal volume, V_t , and the difference between the P_{plat} and PEEP.

Trilogy Evo calculates Dyn C using the following formula:

$$Dyn C = \frac{V_t}{P_{plat} - PEEP}$$

Where:

- $PEEP$ is the total pressure (intrinsic plus extrinsic) at the start of the breath ($PEEP = PEEP_e + PEEP_i$)
- V_t is the tidal volume

Note that the compliance is related to the airway resistance by the respiratory time constant, τ , by the relationship described above.

$$Dyn C = \frac{\tau}{Dyn R}$$

Dyn Pplat

Plateau pressure is the pressure applied to small airways and alveoli during positive-pressure mechanical ventilation. In the Measured and Calculated Parameters window, this value is Dyn Pplat. Having already estimated the compliance (Dyn R and Dyn C above), Trilogy Evo calculates Dyn Pplat as follows:

$$P_{plat} = \frac{V_t}{Dyn C} + PEEP + PEEP_i$$

Where:

- V_t is the tidal volume
- $Dyn C$ is dynamic compliance
- $PEEP$ is the total pressure (intrinsic plus extrinsic) at the start of the breath ($PEEP = PEEP_e + PEEP_i$)
- $PEEP_i = -DynR * Q_p(EOE)$ this value is the intrinsic PEEP or AutoPEEP

AutoPEEP

Intrinsic PEEP, $PEEP_i$, is the resistive pressure at the end of exhalation (EOE), that occurs when a new breath is initiated before the previous breath is completed. In the Measured and Calculated Parameters window, this value is AutoPEEP. AutoPEEP can be used as a guide to detect the presence of dynamic hyperinflation. In most cases, this number represents the pressure in the small airways at the start of the breath in excess of the PEEP applied by the ventilator. In some cases, such as a ventilated, complex, COPD patient, the displayed pressure may not be accurate. However, in these complex cases, any non-zero pressure displayed (accurate or not) indicates the presence of AutoPEEP. When Auto PEEP is zero, this indicates that there is no intrinsic PEEP.

Trilogy Evo calculates AutoPEEP using the following formula:

$$PEEP_i = -Dyn R * Q_p(t = EOE)$$

Where:

- $Dyn R$ is the dynamic resistance (explained in a previous section, “Dyn R” above)
- $Q_p(t = EOE)$ is the patient flow at the end of the exhalation (EOE)

4. Device Setup

Setup Overview

To set up Trilogy Evo, follow the steps shown below. See the accompanying section for instructions.

Step	Section	Page
1. Place the device.	Placement	31
2. Connect AC power.	Connecting AC Power	31
3. Install filters.	Installing Filters	32
4. Connect a circuit.	Connecting a Circuit	32
5. Add oxygen (optional).	Adding Oxygen	35
6. Start the device.	Starting Trilogy Evo Universal	36

Placement

Place Trilogy Evo on a stable, flat, hard surface. Air must flow freely. Do not block the air vents with items such as bedding or curtains. Do not place Trilogy Evo near any heating or cooling equipment or air supplies such as forced air vents, radiators, or air conditioners. Ensure the USB and detachable battery panel doors remain closed when not in use.

If the device has been stored outside the normal operating temperature stated in “Technical Specifications,” ensure the device reaches operating temperature before connecting power.

See the “EMC Information” chapter for guidance on possible electromagnetic interference.

Connecting AC Power

Use the AC cord provided to connect AC power before pressing the power button. Verify Trilogy Evo Universal is using AC power, indicated by the green LED light next to the power button.

To use other power sources, such as the detachable battery or an external battery, see the “Power Management” chapter.

Installing Filters

CBRN Filter

To install the CBRN filter:

1. Ensure the CBRN filter adapter gasket is securely seated.
2. Place the filter adapter onto the bayonet mount and twist clockwise to lock in place.

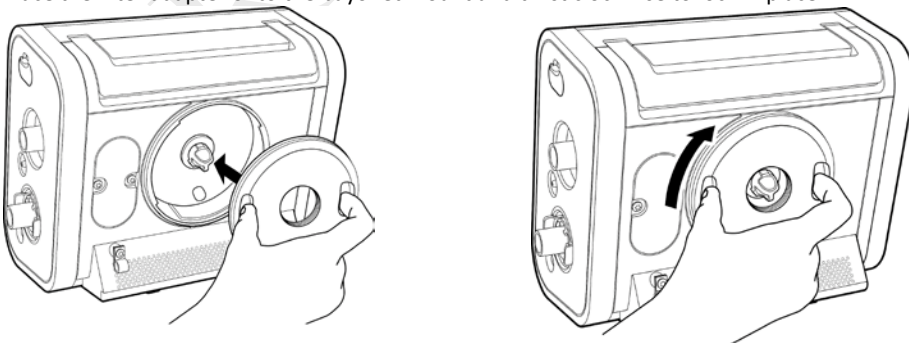

3. Screw the CBRN filter onto the filter adapter.

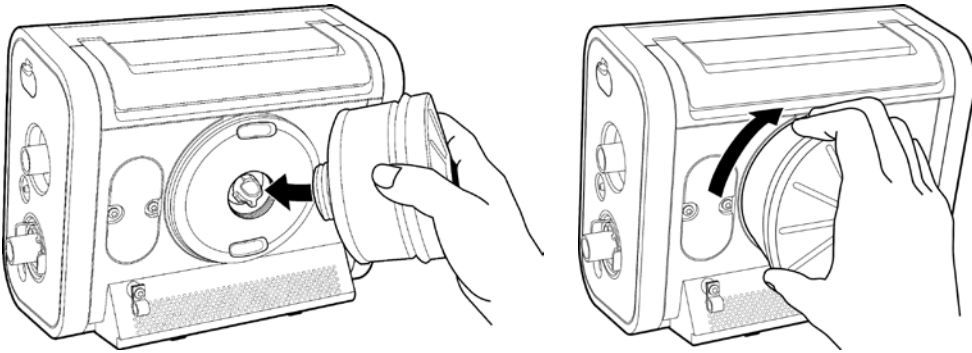

Air-Inlet Foam Filter

Ensure the air-inlet foam filter is installed correctly.

To install the air-inlet foam filter, pinch the filter as you press it into the filter cover as shown. Position it securely behind the top and bottom restraints.

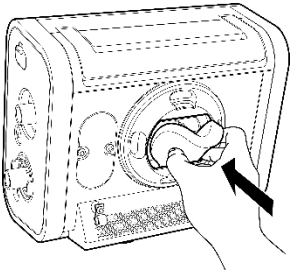

Particulate Filter

To install a particulate filter:

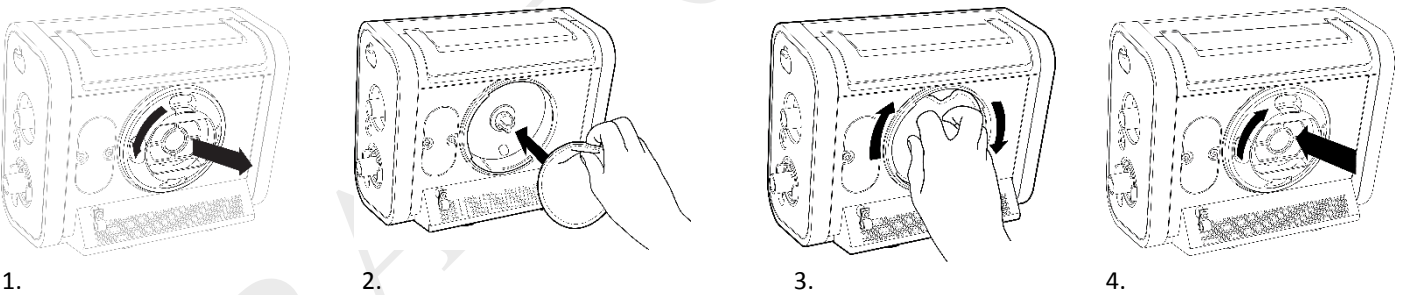

1. Twist the filter cover counterclockwise and pull out to remove it.
2. Place the filter over the bayonet mount.
3. Twist clockwise a quarter of a turn.
4. Replace the filter cover and turn clockwise to secure.

Connecting a Circuit

Be certain that any breathing system filter used with this device complies with ISO 23328-1 and ISO 23328-2. To prevent patient or ventilator contamination, we recommend you use a Respiration-approved main flow bacteria filter (Part Number 342077) on the patient gas outlet port. Filters not approved by Respiration may degrade system performance. Note: A leak device is mandatory during invasive ventilation or when using a circuit with a non-vented mask.

After you connect the circuit, you may calibrate the circuit. See chapter 7, “Device Options, Calibration.”

For low tidal volumes, see the “Therapy Modes chapter”, section titled “Low Tidal Volume Therapy.”

Passive Single Limb Circuits

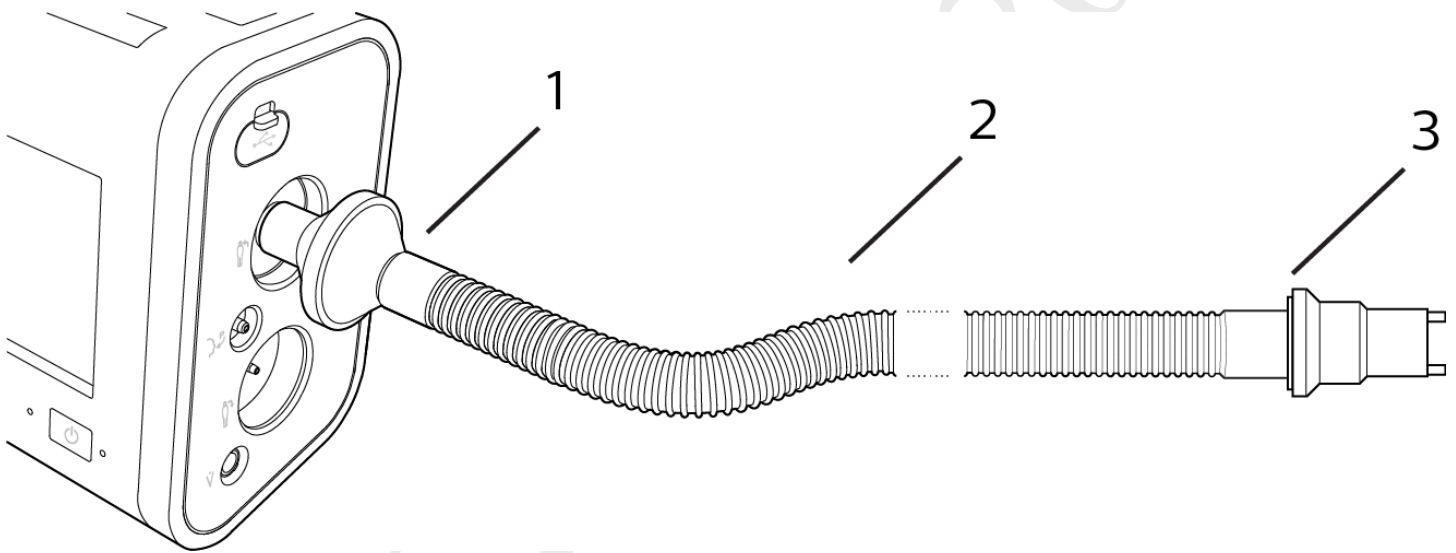

1	Bacteria filter
2	Tubing
3	Exhalation port

1. Connect the bacteria filter (1) on the circuit to the Inspiratory Port.

Active PAP Circuits

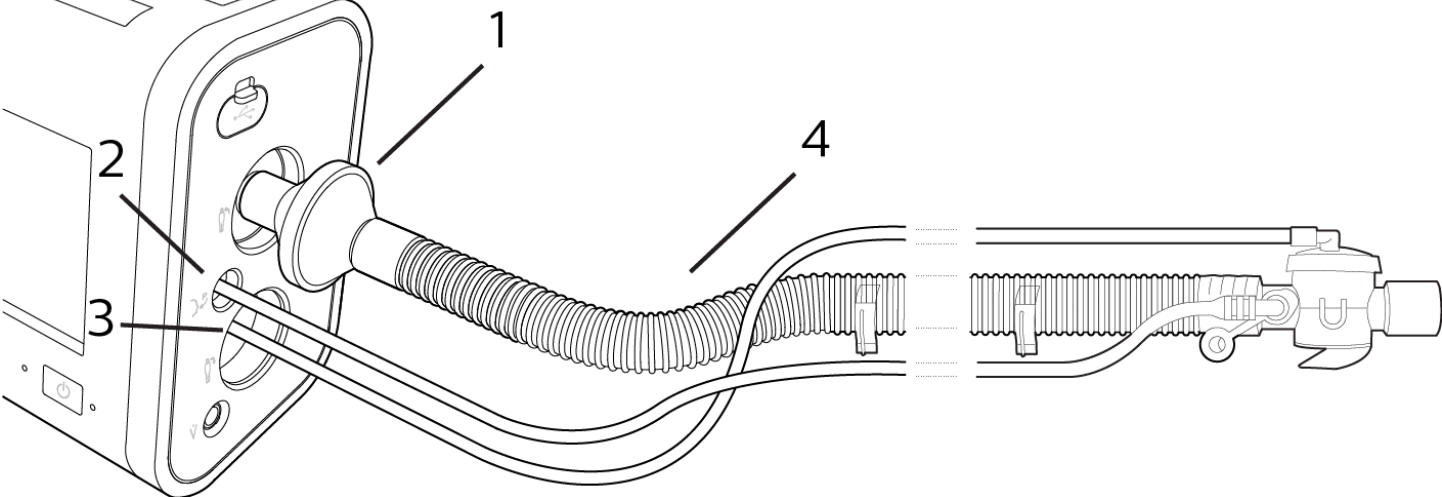

1	Bacteria filter
2	Proximal pressure port
3	Active exhalation valve line connection
4	Tubing

1. Connect the bacteria filter (1) on the circuit to the Inspiratory Port.
2. Connect the proximal pressure line to the Proximal Pressure Port (2).
3. Connect the active exhalation valve pressure line to the active exhalation valve line connection (3).

Active Flow Circuits

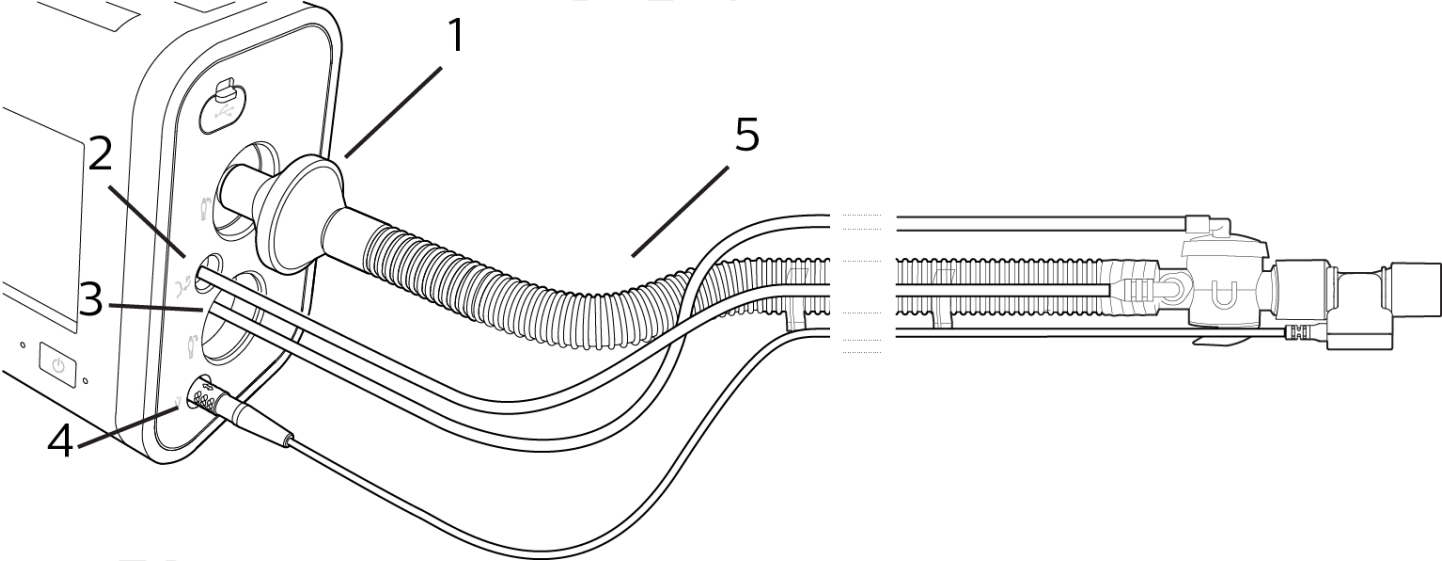

1	Bacteria filter
2	Proximal pressure port
3	Active exhalation valve line connection
4	Flow sensor cable connector
5	Tubing

1. Connect the bacteria filter (1) on the circuit to the Inspiratory Port.
2. Connect the proximal pressure line to the Proximal Pressure Port (2).
3. Connect the active exhalation valve pressure line to the active exhalation valve line connection (3).

4. Connect the flow sensor to the Flow Sensor Cable Connector (4).

Dual Limb Circuits

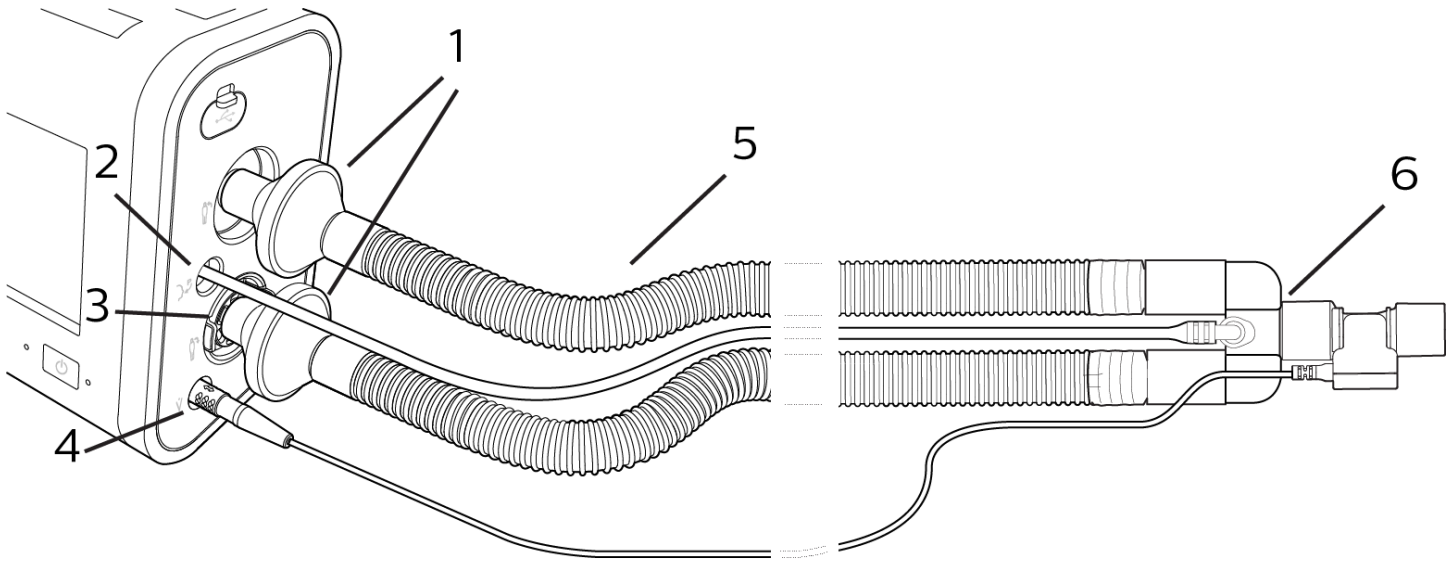

1	Bacteria filters
2	Proximal pressure port
3	Active exhalation valve connection
4	Flow sensor cable connector
5	Tubing
6	Flow sensor connected to circuit

1. Attach the bacteria filter (1) end of the colored inspiratory tube to the Inspiratory Port.
2. Attach the proximal pressure line (2) to the Proximal Pressure Port.
3. Install the external active exhalation valve (AEV) according to the instructions provided with it (3).
4. Attach the bacteria filter end of the clear expiratory tube to the AEV (3).
5. Attach the flow sensor to the flow Sensor Cable Connector (4).
6. Attach the flow sensor to the Y-shaped connector on the circuit (6).

Low Tidal Volume Ventilation

When using volumes between 35 and 50 ml, use the infant/pediatric external flow sensor with either the active flow or dual limb circuits. See the operating instruction sheets included with those accessories.

Adding Oxygen

High Pressure Oxygen

To ensure accurate oxygen administration and to monitor for the presence of contamination, use an FiO_2 sensor or external oxygen monitor to verify the oxygen concentration in the delivered gas.

To connect high-pressure oxygen: Connect an oxygen hose to the high-pressure oxygen connector on the back panel, and then connect the other end of the hose to the source. After you have completed the connection, calibrate the O_2 sensor. See chapter 7, "Device Options, O_2 Sensor Calibration." To maintain accuracy, calibrate the oxygen sensor daily.

Low Flow Oxygen

To connect low flow oxygen:

1. Connect the oxygen tubing to the O₂ adapter supplied with the device.
2. Connect the O₂ adapter to the low flow oxygen inlet on the Utility Panel by pressing down on the valve.

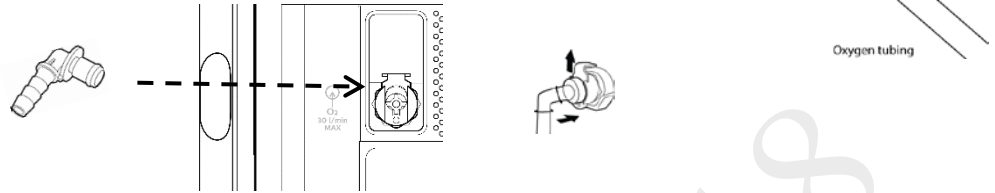

Oxygen-Related Alarms

After the oxygen is connected, set the oxygen-related alarms. See chapter 6, “Alarms and System Messages” for instructions.

Oxygen alarms are as follows:

- Oxygen Regulation
- Low SpO₂
- High SpO₂
- Low FiO₂
- High FiO₂
- Low Oxygen Input Pressure
- High Oxygen Input Pressure

Starting Trilogy Evo Universal

To start Trilogy Evo Universal:

1. Visually inspect Trilogy Evo Universal and all accessories, cords, and tubes attached to the device.
2. Verify that circuit connections are secure.
3. Press the On/Off (Standby) button.
4. Listen for a minimum of three beeps as Trilogy Evo Universal performs system start up checks. The beeps test all alarm signals to ensure proper functioning. Ensure no system messages appear.
5. Watch as the light bar and Alarm Silence button blink once red and once yellow.
6. Confirm that the power sources you have connected are functioning properly and that power is sufficient. For help, see the “Power Management” chapter.

5. Device Operation

Clinical Assessment

Warning

Before placing a patient on the ventilator, perform a clinical assessment. Considerations should include:

- Choosing alarm settings
- Assessing whether alternative ventilation equipment is required
- Selecting additional accessories, including the patient monitoring accessories you will use

For ventilator-dependent patients, always have alternate ventilation equipment, such as a back-up ventilator or manual resuscitator available.

Ventilator-dependent patients should be continuously monitored by qualified personnel. These personnel should be prepared to provide alternate therapy in the event of ventilator failure or inoperative equipment.

Entering New Patient Information

To enter new patient information

1. In the **Home** window, tap the **New Patient** button. This button clears all existing patient data.
2. In the **New Patient** window, select a **Patient Type**:
 - **Infant**
 - **Pediatric**
 - **Adult**
3. Select the **Patient Sex**.
4. For infant patients, in the **Weight** section, use the slider or the plus and minus buttons to select the patient's *weight*.
For pediatric or adult patients, in the **Height** section, select the patient's height.
Note: this information is used to establish default therapy and alarm settings, including tidal volume and alarms based on tidal volume.
5. In the title bar, tap **Accept** to save your choices.
6. Acknowledge the reminder to ensure a viral/bacterial filter is installed on the outlet of the device.
7. Edit the prescription settings according to the procedure in the next section, "About Prescriptions." Therapy and alarm settings differ based on Patient Type. See the "Therapy Modes and Controls" and "Alarms" chapters.



About Prescriptions

System Timeout

When working in the Prescription Settings window, ensure you save your changes. After a period of inactivity, the system reverts to the previous setting and your changes are not saved. If you are making changes during therapy delivery, the period of inactivity is 30 seconds. If you are making changes when the system is in standby, the period of inactivity is 5 minutes.

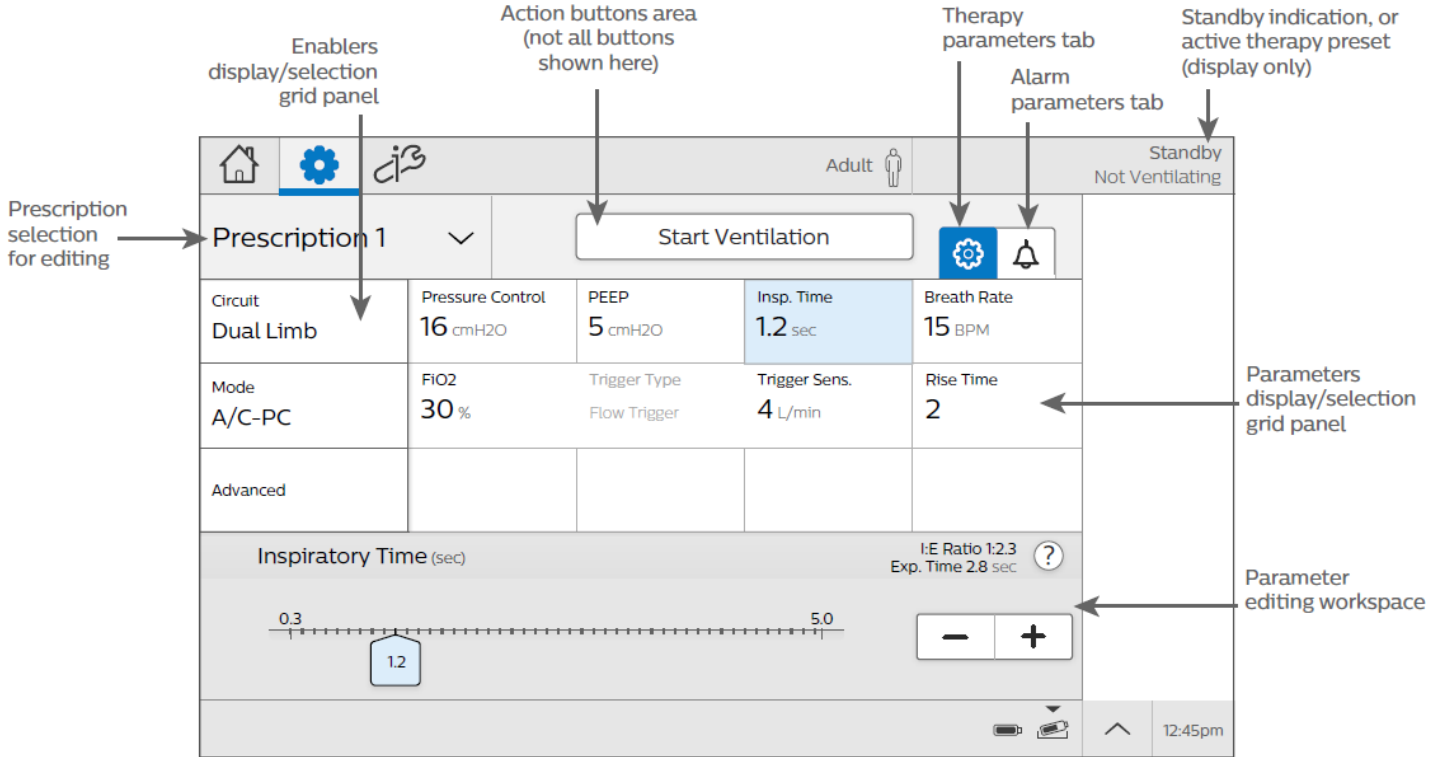

Parts of the Prescription Settings Window



7-1: Parts of the Prescription Settings Window

Editing Prescription and Alarm Settings

To edit prescription settings:

1. In the menu bar, tap the prescription settings icon. 
2. In the prescription grid, tap **Circuit**. In the workspace below the grid, select the circuit **Type** and **Size**.
3. If you are using a humidifier, in the **Active Humidification** section, tap **Yes**. Otherwise, tap **No**.
4. To save your changes, tap **Accept**.
5. In the prescription grid, tap **Mode**. In the workspace below the grid, select the mode.
6. Tap a prescription parameter. In the lower pane, move the slider or use the plus and minus buttons to change the parameter value.
7. Tap the Alarm tab to view and edit the associated alarm settings.
For more information about alarms, including details about each alarm, see “chapter 6: Alarms.”
8. Change the alarm parameters in the lower pane and then click **Accept** at the top of the window. 
9. Continue editing prescription and alarm parameters.
To work with advanced options, tap **Advanced**.
10. Test the alarms. See “Testing Alarms” in chapter 6.
11. When you are finished, tap **Accept** to save your changes.

Adding a Prescription

If you want to add another prescription:

1. In the menu bar, tap the prescription settings icon. 
2. Tap the **Prescription** list to expand it and then tap **Add New**.
3. On the **Select Prescription Name** dialog box, tap the prescription name that you want to use.
4. Edit the prescription settings as you would for a new prescription.

Deleting a Prescription

To delete a prescription: In the **Home** window, tap the prescription you want to delete and then tap the trashcan icon. 

Starting and Stopping Ventilation

To *start* ventilation:

In the **Prescription Settings** window, select the prescription you want to use and then tap **Start Therapy**.

To stop ventilation and put the ventilator on *standby*:

Press the On/Off (Standby) button on the front panel. On the confirmation window, tap **Standby**.

To turn the device *off*:

Press the On/Off (Standby) button on the front panel. On the confirmation window, tap **Power Off**.

Actions during Ventilation

Using Different Prescriptions

If a clinician has set up more than one prescription; for example, a daytime and nighttime prescription, you can use the prescription list to change the active prescription.

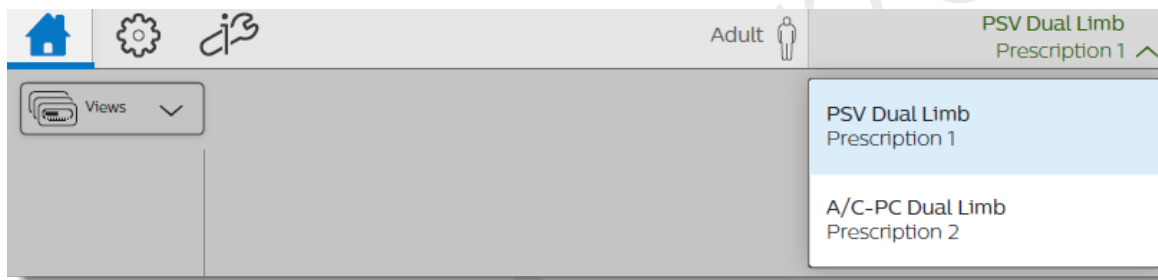

To select a prescription that uses a circuit type that is *different from the current prescription*:

1. Press the On/Off (Standby) button on the front panel. On the confirmation window, tap **Standby**.
2. Attach the circuit type that corresponds to the prescription.
3. On the menu bar, tap the active prescription to expand the prescription list.
4. Tap the prescription you want to use and then confirm your choice.
5. Tap **Start Therapy**.

To select a prescription that uses a circuit type that is the *same as the current prescription*:

1. On the menu bar tap the active prescription to expand the prescription list.
2. Tap the prescription you want to use and then confirm your choice.
3. Tap **Start Therapy**.

Locking and Unlocking the Screen

To lock the screen, expand the **Device Actions Menu** then tap the **Lock Screen** button.



To unlock the screen, tap the screen. On the screen unlock dialog box, tap and hold **Yes** for three seconds.

When an alarm or system message becomes active, the screen saver is stopped and the automatic screen lock is disabled. For more information, see the “Alarms” chapter.

Delivering a Manual Breath

To deliver a manual breath, tap the **Manual Breath** icon in the **Status Bar**. 

Delivering 100% Oxygen

To deliver 100% oxygen for two minutes, tap the **100% O₂** icon in the **Status Bar**. 

To stop delivery, tap the icon again and then tap **Stop**.

DRAFT 01/26/2018

6. Alarms and System Messages

Overview

Trilogy Evo Universal generates audible and visual alarms to alert you when conditions require attention.

Warning: To prevent death or serious injury, monitor the patient and the ventilator regularly in order to determine the need to provide emergency ventilation when an alarm sounds or the ventilator malfunctions. Always test the alarms after changing the circuit or prescription.

An increase in circuit resistance can prevent proper operation of some alarms.

Speaking valves, heat moisture exchangers (HMEs), and filters create additional circuit resistance and may affect the performance of alarms chosen for circuit disconnect protection.

Alarm settings are retained when power is lost.

Do not rely on any single alarm to detect a disconnected circuit. Certain components may affect the performance of the alarms chosen to signal that a circuit is disconnected. Use the apnea, low tidal volume, low minute ventilation, and low respiratory rate alarms in conjunction with the circuit disconnect alarm. Test these alarms daily and after you change ventilator settings.

About Alarms

When an alarm is active, the following indicators occur:

- An Alarm List appears in the menu bar.
- An Alarm light bar flashes red or yellow, or glows steady yellow, depending on the alarm level (To configure this indicator, see chapter 7, “Device Options.”)
- The Alarm Silence button on the device flashes red or yellow, or glows steady yellow, depending on the alarm level
- An audible alarm sounds.

Trilogy Evo Universal uses three alarm levels:



- High Priority – Requires an immediate response
- Medium Priority – Requires a prompt response
- Low Priority – Requires awareness.



Trilogy Evo Universal also shows system messages to inform you about changing conditions. These messages are described in “Alarms and System Messages.”

When an alarm or system message becomes active, Trilogy Evo Universal stops the screen saver and disables the automatic screen lock.

When external monitors are used, such as an FiO₂ sensor or SpO₂ sensor, associated alarm settings only appear when the ventilator detects sensor connection. Alarm settings are stored in the system so if a sensor becomes disconnected, the alarm settings are restored upon reconnection. To delete external monitor alarm settings, clear all patient data according to the procedure described in the “Device Operation” chapter.

Some patient-related alarms have configurable settings, while others have fixed settings. All system and power alarm settings are fixed. Trilogy Evo Universal also shows system messages to inform you about changing conditions. Alarm and system message details appear in the “Alarms and System Messages” section in this chapter.

Alarm and Message Indicators		
Icon	Description	Light and sound indicators
	High alarm	Light bar flashes red Audible alarm repeats rapidly
	Medium alarm	Light bar flashes yellow Audible alarm repeats moderately

Alarm and Message Indicators		
Icon	Description	Light and sound indicators
	Low alarm	Light bar glows steady yellow Audible alarm repeats slowly
	Message	Single beep
	Resolved alarm or message	None

The Alarm List

The Alarm List appears in the menu bar. Tap the list to expand it and view the alarms. Tap the up and down arrows to navigate through the list.

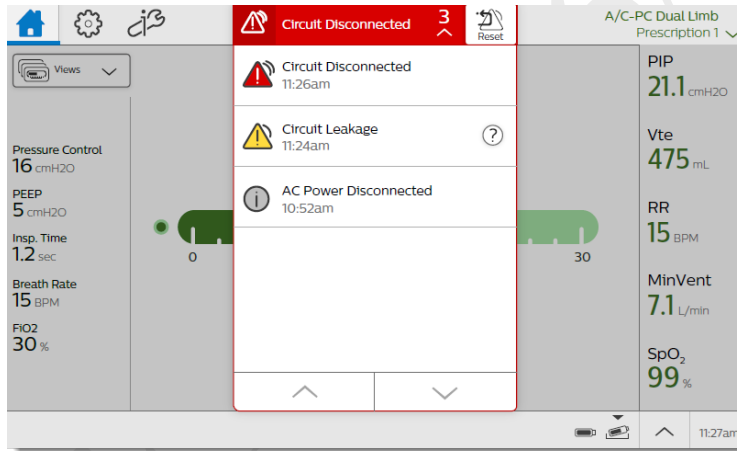

The list is ordered by priority and then by time. The most urgent, most recent alarm appears at the top of the list. An alarm counter shows the number of active alarms.

Setting and Changing Alarms

Warning: A hazard can exist if different alarms are used for the same or similar equipment in any single area. Ensure all alarms are appropriate for the patient before use.

You can change alarm settings when creating a new prescription or when editing an existing prescription. To change an alarm setting:

1. On the menu bar, tap the **Prescription** icon. 
2. In the **Prescriptions** window, tap the **Alarm** tab.





3. Select the alarm you want to change.
4. Adjust the parameters in the lower pane.
5. To undo changes, tap the Undo button in the lower pane. 
6. When you are ready to save your changes, tap **Accept**.

Setting the Alarm Volume

Warning:

Ensure the alarm volume is set loud enough for the caregiver to hear it. Consider the use of a remote alarm. If you do use a remote alarm, test it before starting ventilation.

To set the alarm volume:



1. In the menu bar, tap the **Options** icon. 
2. In the **Options** window, tap **Device Settings**.
3. In the **Device Settings** window, tap **Alarm Volume**.
4. In the setting dialog box, make your selection.
5. On the **Alarm Volume** dialog box, select the volume you want and then tap the **Accept** checkmark. 

Responding to an Alarm

Warning

Visually monitor the patient and ventilator at all times during an Alarm Silence period. Allowing alarms to continue without intervention may result in harm to the patient.

When an alarm occurs:

1. Ensure the patient has adequate ventilation and oxygen. If required, provide an alternate method of ventilation.
2. Tap the **Alarm List** to view all alarms and messages. If you see the help icon , you can tap it for more information.
3. Press the **Alarm Silence** button on the device to pause all audible alarms for 2 minutes. 
4. Take action to resolve the alarm. For help on specific alarms, see the “Alarms and System Messages” section.

Resetting Alarms



The **Alarm Reset** icon resets all active and resolved alarms.

When an alarm-triggering condition is no longer present, the alarm status changes to Resolved and the alarm or message remains in the list. Tap the **Alarm Reset** icon to reset the alarm list. 

Alarms and System Messages

This section contains the details of each alarm and system message:

Alarm	See page
High-priority System Alarms	45
Ventilator Inoperative	45
Ventilator Service Required	45
Obstruction	45
High Expiratory Pressure	45
High Inspiratory Pressure	46
External Flow Sensor Failure	46
External Flow Sensor Cable Disconnected	46
External Flow Sensor Not Connected	46
External Flow Sensor Reversed	47
Active Exhalation Valve Failed	47
Check Active Exhalation Pressure Control Line	47
Proximal Pressure Line Disconnected	47
Oxygen Regulation	48
High-priority Patient Alarms with Variable Settings	48
Apnea	48
Circuit Disconnected	48
Low Minute Ventilation	48
Low Respiratory Rate	49
High Inspiratory Pressure	49
Medium-priority System Alarms	49
Circuit Leakage	49
Rebreathing Detected	50
Volume Under Delivery	50
Loss of CO ₂ Signal	51
Loss of SpO ₂ Signal	51
CO ₂ Sensor Adapter Zero Required	51
Check/Change CO ₂ Airway Adapter	51
CO ₂ Sensor Failure	51
Low Expiratory Pressure	52
Low Inspiratory Pressure	52

Alarm	See page
Low Oxygen Input Pressure	52
High Oxygen Input Pressure	53
Medium-priority Patient Alarms with Variable Settings	53
High Tidal Volume	53
Low Tidal Volume	53
High Minute Ventilation	54
High Respiratory Rate	54
Low Inspiratory Pressure Alarm	55
Low SpO ₂	55
High SpO ₂	55
Low EtCO ₂	55
High EtCO ₂	55
Low FiO ₂	56
High FiO ₂	56
Low-priority System Alarms	56
Stuck Key	56
Inlet Filter Blocked	56
Check Proximal Pressure Line	57
Low-priority Patient Alarms with Variable Settings	57
Low Pulse Rate	57
High Pulse Rate	57
Power Alarms	57
Loss of All Power	57
Low Battery	58
AC Power Disconnected	58
Internal Battery in Use	58
Replace Detachable Battery	58
Internal Battery Depleted	59
System Messages	59

High-priority System Alarms

VENTILATOR INOPERATIVE

Priority	High
Why it occurs	The system self-test indicates a failure or malfunction of a component that causes therapy to stop or not meet essential performance criteria.
What to do	Contact Philips Respironics Customer Service
Device performance during active alarm	Therapy is stopped and both audible and visual alarms are continuous. Depending on the systems impacted, you may or may not see a message on the screen.

VENTILATOR SERVICE REQUIRED

Priority	High
Why it occurs	This alarm occurs when the system self-test indicates an error that does not affect the ability of the ventilator to meet essential performance criteria.
What to do	Contact Philips Respironics Customer Service
Device performance during active alarm	The device continues to operate (possibly in a reduced capacity mode). If the problem is not corrected, the device will generate a reminder message until the issue is corrected. Additionally, if therapy is stopped, a reminder message will immediately appear when therapy is turned on again.

OBSTRUCTION

Priority	High
Why it occurs	The ventilator detects an obstruction in the patient's inhalation path, exhalation path, or external flow sensor. The ventilator detects that the exhalation port is missing.
What to do	<ul style="list-style-type: none"> • Check the circuit for kinked or pinched tubing. • Check the bacteria filter or HME for a blockage or occlusion. • Ensure that the exhalation port is not occluded or missing. • Check the external flow sensor for a blockage or occlusion.
Requirements	Passive, dual limb, active PAP, or active flow circuit
Device performance during active alarm	The device will automatically open the active exhalation valve and continue to operate.
Algorithm summary	<p>Any circuit, inhalation limb: an obstruction is detected when either of the following conditions exist:</p> <ul style="list-style-type: none"> • The flow exiting the machine is less than 0.5 lpm for 5 seconds continuously • The flow exiting the machine during inspiration is less than 1 lpm for 5 seconds, 2 breaths, or 65 seconds for very low breath rates. <p>Any circuit: The expiratory port is missing and causes an obstruction alarm if the average flow is less than 1 lpm for 2 breaths or 60 seconds.</p> <p>Active flow or dual limb circuit: an obstruction is detected when the external flow sensor measures less than 0.5 lpm for 65 continuous seconds.</p>

HIGH EXPIRATORY PRESSURE

Priority	High
Why it occurs	During the expiratory phase, the delivered pressure exceeds the target patient pressure by 5 cmH ₂ O or more.
What to do	<ul style="list-style-type: none"> • Check the circuit for kinked or pinched tubing. • Ensure that the leak device is not blocked or occluded. <p>Note: This alarm condition may be due to pinched tubing or the patient having a fast breath rate.</p>

Requirements	
Device performance during active alarm	The alarm is automatically resolved when the delivered pressure comes within 5 cmH ₂ O of the target patient pressure during the expiratory phase. Device will continue to operate.

HIGH INSPIRATORY PRESSURE

Priority	High
Why it occurs	During the inspiratory phase, the delivered pressure exceeds the target patient pressure by 5 cmH ₂ O or more
What to do	<ul style="list-style-type: none"> • Check the patient for: <ul style="list-style-type: none"> ○ Coughing or excessive secretions ○ Bronchospasms ○ Tracheotomy tube stability • Check the ventilator for: <ul style="list-style-type: none"> ○ Kinked, pinched, or blocked tubing ○ Blocked leak device or blocked exhalation device ○ Secretions in the HME
Requirements	Therapy mode must be SIMV-VC or A/C-VC
Device performance during active alarm	The alarm is automatically resolved when the delivered pressure falls within 5 cmH ₂ O of the target patient pressure during the inspiratory phase. The device will automatically cycle to the expiratory phase and continue to operate.

EXTERNAL FLOW SENSOR FAILED

Priority	High
Why it occurs	A flow sensor offset or sensor failure is detected when the device is in standby or delivering therapy.
What to do	Ensure the sensor and cable are connected properly and are not damaged. Clean if needed. Replace if necessary.
Requirements	Active flow or dual limb circuit
Device performance during active alarm	The alarm remains active until the flow sensor is replaced or reconnected. If the alarm occurs when delivering therapy, the device will continue to operate. If the alarm occurs when the device is in standby, you cannot start therapy.

EXTERNAL FLOW SENSOR CABLE DISCONNECTED

Priority	High
Why it occurs	The external flow sensor cable becomes disconnected from the ventilator during active therapy. Active flow or dual limb circuit is selected and an external flow sensor cable is not connected.
What to do	Ensure the sensor and cable are connected properly and are not damaged. Replace if necessary.
Requirements	Active flow or dual limb circuit
Device performance during active alarm	Prohibits starting therapy if the external flow sensor cable is not connected to the ventilator when the active flow or dual limb circuit is selected

EXTERNAL FLOW SENSOR NOT CONNECTED

Priority	High
Why it occurs	The external flow sensor becomes disconnected from the external flow sensor cable during active therapy.
What to do	Ensure the sensor and cable are connected properly and are not damaged. Replace if necessary.
Requirements	Active flow or dual limb circuit
Device performance	Device continues to provide therapy at the set breath rate. Device will not trigger on a patient initiated breath.

during active alarm	Monitored parameters and alarms that use the flow measurement such as tidal volume will not function. Monitored parameters and alarms that use the pressure measurement will continue to function.
---------------------	---

EXTERNAL FLOW SENSOR REVERSED

Priority	High
Why it occurs	The external flow sensor is connected backwards during active therapy.
What to do	Check the sensor position. The arrow direction should align with the air delivered to the patient.
Requirements	Active flow or dual limb circuit
Device performance during active alarm	In volume modes, device will not accurately control volume. The peak inspiratory pressure will continue to increase. In pressure modes, therapy will be unaffected. All monitored parameters and alarms will continue to function.

ACTIVE EXHALATION VALVE FAILED

Priority	High
Why it occurs	The active exhalation valve is stuck closed.
What to do	<ul style="list-style-type: none"> For a single-limb active circuit, check all connections to the valve and check that the valve is clear. For a dual limb circuit, check that the valve is clear..
Requirements	Active flow or dual limb circuit
Device performance during active alarm	The alarm is automatically resolved and the device continues to operate.

CHECK ACTIVE EXHALATION PRESSURE CONTROL LINE

Priority	High
Why it occurs	The active-exhalation pressure control line is not connected, becomes disconnected, or contains water droplets that affect the active exhalation valve line pressure reading.
What to do	Inspect the line. Empty or replace it if necessary.
Requirements	Active flow or dual limb circuit
Device performance during active alarm	Therapy delivery will be compromised. All monitored parameters and alarms will continue to function.

PROXIMAL PRESSURE LINE DISCONNECTED

Priority	High
Why it occurs	The proximal pressure line is not connected.
What to do	<ul style="list-style-type: none"> Verify the proximal pressure line is connected properly at both ends and the line is clean and untangled. Ensure the main circuit is connected properly and does not have large leaks. Ensure the exhalation valve is intact.
Requirements	Dual limb, active PAP, or active flow circuit
Device performance during active alarm	The alarm is automatically resolved when the proximal pressure line is connected properly. The device continues to operate.

OXYGEN REGULATION

Priority	High
Why it occurs	The flow measured FiO ₂ is not within 10% ± 3% of the FiO ₂ setting.
What to do	<ul style="list-style-type: none"> Verify the oxygen blender is connected properly.

	<ul style="list-style-type: none"> • Ensure that the oxygen source is appropriate. • Contact Philips Respironics Customer Service
Requirements	Oxygen source
Device performance during active alarm	Device will continue to operate.
Algorithm summary	The controller cannot regulate flow to guarantee FiO ₂ accuracy within 10% ± 3% of the FiO ₂ setting.

High-priority Patient Alarms with Variable Settings

APNEA

Priority	High
Why it occurs	Time between patient-initiated breaths is greater than the Apnea Interval setting.
What to do	<ul style="list-style-type: none"> • Ensure the circuit is properly connected to the patient. • Check the circuit for a leak or disconnect. • Check the circuit for kinked or pinched tubing..
Device performance during active alarm	<p>The alarm is automatically resolved when two patient breaths are detected that occur within set interval.</p> <p>Device will continue to operate.</p>
Alarm Settings	5 to 60 seconds in increments of 5 seconds Available when Backup Ventilation is enabled

CIRCUIT DISCONNECTED

Warning: You should not rely on any single alarm to detect a circuit disconnect condition. The Low Tidal Volume, Low Minute Ventilation, Low Respiratory Rate, and Apnea alarms should be used in conjunction with the Circuit Disconnected alarm.

Priority	High
Why it occurs	The patient is not properly connected to the ventilator breathing circuit or there is a large leak.
What to do	Ensure the circuit is properly connected to both the patient and the ventilator and that a large unintentional leak does not exist.
Device performance during active alarm	<p>The alarm is automatically resolved when the circuit is reconnected or the excessive leak is fixed.</p> <p>Device will continue to operate.</p>
Alarm Settings	Off, 5 to 60 seconds in increments of 5 seconds.
Algorithm summary	<p>The alarm occurs when either of the following conditions are met:</p> <ul style="list-style-type: none"> • The flow out of the device is excessive for a time greater than the alarm setting. • The ventilator examines all expiratory flow for a minimum of three breaths or amount of time greater than the alarm setting and determines that the circuit is disconnected or obstructed.

LOW MINUTE VENTILATION

Priority	High
Why it occurs	The patient's minute ventilation is less than or equal to the Low Minute Ventilation alarm setting. Or, no breath has occurred for 15 seconds.
What to do	<ul style="list-style-type: none"> • Check the circuit for kinked or pinched tubing. • Check the circuit for a leak or disconnect. • Remove excessive water from the tubing. • Ensure the bacteria filter is not blocked, occluded, or disconnected. • Ensure the leak device is not blocked, occluded, or disconnected. <p>Note: A patient that is sleeping or medicated may breathe at a lower rate or with lower tidal volumes. These conditions may contribute to lower minute ventilation.</p>

Device performance during active alarm	The alarm is automatically resolved when the calculated minute ventilation is greater than the low minute ventilation alarm setting. volume under delivery Device will continue to operate.
Alarm Settings	Adult and Pediatric patient types: 0.2 to 30 LPM in increments of 0.1 LPM. Infant patient type: 0.2 to 10 LPM in increments of 0.1 LPM.

LOW RESPIRATORY RATE

Priority	High
Why it occurs	The patient's respiratory rate is less than or equal to the low respiratory rate alarm setting. Or, no breath has occurred for 15 seconds.
What to do	<ul style="list-style-type: none"> Check the circuit for kinked or pinched tubing. Check the circuit for a leak or disconnect. <p>Note: A patient that is sleeping or medicated may breathe at a lower rate.</p>
Device performance during active alarm	The alarm is automatically resolved when the measured respiratory rate is greater than the low respiratory rate alarm setting. Device will continue to operate.
Alarm Settings	Off, 1 to 80 BPM in increments of 1 BPM.

HIGH INSPIRATORY PRESSURE

Priority	Variable
Why it occurs	The alarm will sound if the measured patient pressure exceeds the high inspiratory pressure alarm setting. Occurs in stages, escalating from an audible single beep for the first two occurrences to an audible medium priority on the third occurrence, and then to a high priority alarm if the condition continues. Occurrences must be consecutive.
What to do	<ul style="list-style-type: none"> Check the patient status Check the ventilator for the following potential causes for this alarm: <ul style="list-style-type: none"> Kinked, pinched, or blocked tubing Blocked leak device or blocked exhalation device Secretions in the HME
Device performance during active alarm	Inspiration is cycled to PEEP with this alarm Device will continue to operate. The alarm is automatically resolved when the peak inspiratory pressure is less than or equal to the high inspiratory pressure alarm setting. The device will cycle out of the breath.
Alarm Settings	10 to 90 cmH ₂ O in increments of 1 cmH ₂ O.
Algorithm summary	The High Inspiratory Pressure alarm shall generate a High Priority alarm on the 10 th consecutive breath or if 30 seconds has elapsed since a previous breath and the Peak Inspiratory pressure from the current breath is greater than or equal to the alarm setting

Medium-priority System Alarms

CIRCUIT LEAKAGE

Priority	Medium
Why it occurs	In the Active PAP circuit, a leak in the active exhalation valve is detected
What to do	<ul style="list-style-type: none"> Check the valve and both lines for kinked or pinched tubing. Check the circuit and both lines for a leak or disconnect at both ends. Check that the valve is not damaged and can properly seal and open.
Requirements	Active PAP circuit is selected
Device performance during active alarm	The alarm is automatically resolved when the circuit is reconnected or the valve is fixed. Device will continue to operate.

Algorithm summary	The flow from the device at the end of the expiratory phase is greater than a threshold based on a typical flow that would result if a 0.25" diameter orifice leak were present in the circuit.
-------------------	---

REBREATHING DETECTED

Priority	Medium
Why it occurs	The ventilator detects the potential for the inhalation of exhaled gases. Rebreathing is detected at 3 consecutive breaths for passive circuits and 6 consecutive breaths for Active PAP, Active Flow, or Dual Limb circuits.
What to do	Check for a partially occluded exhalation port or increase expiratory leak flow. Ensure the exhalation valve is attached.
Device performance during active alarm	The alarm is automatically resolved when exhaled air returns to a non-hazardous level for 6 consecutive breaths. Device will continue to operate.
Algorithm summary	<p>This alarm is based on an estimation of the inhaled fraction of carbon dioxide (FiCO₂). For each breath, the ventilator assigns a percentage of FiCO₂. When the sum of the percentages for the most recent breaths exceeds 30%, the alarm is announced. This method of using a running sum of concentration for the alarm reporting results in a shorter alarm delay when there are higher concentrations of FiCO₂. The concentration estimate is based on nominal volumetric capnography curves, measured flow in the inhalation limb, and patient tidal volume. Any three breaths without rebreathing resets the sum of percentages to zero.</p> <p>This figure shows the assumed shape of the capnograph for a given volume of exhaled gases.</p>

VOLUME UNDER DELIVERY

Priority	Medium
Why it occurs	A system limit is reached and the set volume cannot be reached for 3 consecutive breaths.
What to do	Check the patient. Verify that the circuit and airway are clear of obstruction. Verify that the high pressure alarm limit is sufficient. Review all settings including Inspiratory Time, Tidal Volume, and Flow Pattern. Verify that patient and ventilator are synchronous by examining the waveforms and adjusting the trigger settings.
Requirements	The mode is A/C-VC or SIMV-VC.
Device performance during active alarm	Device will continue to operate, attempting to deliver the set therapy All monitored parameters and alarms will continue to function.
Algorithm summary	In modes designed to regulate the tidal volume on each breath such as AC-VC or SIMV-VC, the alarm is generated when the inhaled tidal volume is less than or equal to 85% of the tidal volume setting for 3 consecutive breaths.

LOSS OF CO₂ SIGNAL

Priority	Medium
Why it occurs	The EtCO ₂ sensor is reporting invalid data, the sensor signal is lost, or no breaths are detected for more than 10 seconds while the device is delivering therapy.
What to do	Ensure that the EtCO ₂ sensor is properly attached to the ventilator and the patient circuit.
Requirements	The High EtCO ₂ alarm or Low EtCO ₂ alarm is enabled and the sensor was previously reporting valid data for 3 continuous seconds..
Device performance during active alarm	The alarm is automatically resolved when the EtCO ₂ sensor is properly attached to the ventilator and the patient and the sensor reports data. Device will continue to operate.

LOSS OF SPO₂ SIGNAL

Priority	Medium
Why it occurs	The oximeter is reporting invalid data or the oximeter is disconnected for more than 10 seconds while the device is delivering therapy or is in standby.
What to do	<ul style="list-style-type: none"> • Ensure that the SpO₂ probe is properly attached to the ventilator and the patient. • Reposition the probe on the patient, if necessary.
Requirements	Low SpO ₂ , high SpO ₂ , low pulse rate, or high pulse rate alarm is enabled and the oximeter was previously reporting valid data for 3 continuous seconds.
Device performance during active alarm	The alarm is automatically resolved when the SpO ₂ probe is properly attached to the ventilator and to the patient and the oximeter reports data for more than 10 seconds. Device will continue to operate.

CO₂ SENSOR ADAPTER ZERO REQUIRED

Priority	Medium
Why it occurs	The CO ₂ sensor requests a zero when the device is delivering therapy.
What to do	Reestablish the baseline CO ₂ level. Follow the “CO ₂ Sensor Adapter Zero” procedure in the “Device Options” chapter.
Requirements	CO ₂ sensor
Device performance during active alarm	Device will continue to operate. CO ₂ monitored parameters and alarms will not function

CHECK/CHANGE CO₂ AIRWAY ADAPTER

Priority	Medium
Why it occurs	The CO ₂ sensor reports that a check is required when the device is delivering therapy.
What to do	Check the CO ₂ sensor
Requirements	CO ₂ airway adapter
Device performance during active alarm	Device will continue to operate. CO ₂ monitored parameters and alarms will not function

CO₂ SENSOR FAILURE

Priority	Medium
Why it occurs	The CO ₂ sensor reports a fault while the device is delivering therapy.
What to do	<ul style="list-style-type: none"> • Disconnect and then reconnect the sensor. • Replace the sensor.
Requirements	CO ₂ sensor
Device performance	Device will continue to operate. CO ₂ monitored parameters and alarms will not function

during active alarm	
---------------------	--

LOW EXPIRATORY PRESSURE

Priority	Medium
Why it occurs	During the expiratory phase, the delivered pressure is 5 cmH ₂ O or more below the target patient pressure.
What to do	<ul style="list-style-type: none"> • Check the circuit for a leak or disconnect. • Check the circuit for kinked, pinched, or blocked tubing.
Device performance during active alarm	The alarm is automatically resolved when the delivered pressure comes within 5 cmH ₂ O of the target patient pressure during the expiratory phase. Device will continue to operate.

LOW INSPIRATORY PRESSURE

Priority	Medium
Why it occurs	During the inspiratory phase, the delivered pressure is 5 cmH ₂ O or more below the target patient pressure.
What to do	<ul style="list-style-type: none"> • Check the patient for excessive inspiratory effort • Check the ventilator for: <ul style="list-style-type: none"> ○ Kinked, pinched, or blocked tubing ○ Circuit leak or disconnect
Device performance during active alarm	The alarm is automatically resolved when the delivered pressure comes within 5 cmH ₂ O of the target patient pressure during the inspiratory phase. Device will continue to operate.

LOW OXYGEN INPUT PRESSURE

Priority	Medium																		
Why it occurs	The pressure at the O ₂ inlet is too low to support the FiO ₂ setting.																		
What to do	Check the O ₂ source.																		
Requirements	Additional oxygen																		
Device performance during active alarm	Device will continue to operate. FiO ₂ delivery may be inaccurate.																		
Algorithm summary	<p>The machine assigns a minimum pressure threshold for oxygen based on the flow setting to support the FiO₂ set point. The following table illustrates the threshold based on flow. The alarm occurs when the inlet pressure is less than or equal to 5psig or the Inlet Pressure value from the table for six consecutive breaths.</p> <table border="1" style="margin-left: auto; margin-right: auto;"> <thead> <tr> <th>Inlet Pressure [psig]</th> <th>Maximum Flow [slpm]</th> </tr> </thead> <tbody> <tr><td>10</td><td>66.4</td></tr> <tr><td>20</td><td>96.1</td></tr> <tr><td>30</td><td>126.1</td></tr> <tr><td>40</td><td>156.7</td></tr> <tr><td>50</td><td>188.1</td></tr> <tr><td>60</td><td>219.4</td></tr> <tr><td>70</td><td>251.7</td></tr> <tr><td>80</td><td>279.9</td></tr> </tbody> </table>	Inlet Pressure [psig]	Maximum Flow [slpm]	10	66.4	20	96.1	30	126.1	40	156.7	50	188.1	60	219.4	70	251.7	80	279.9
Inlet Pressure [psig]	Maximum Flow [slpm]																		
10	66.4																		
20	96.1																		
30	126.1																		
40	156.7																		
50	188.1																		
60	219.4																		
70	251.7																		
80	279.9																		

HIGH OXYGEN INPUT PRESSURE

Priority	Medium
Why it occurs	The measured oxygen inlet pressure is greater than or equal to 87psig.
What to do	Check the O ₂ source.
Requirements	Additional oxygen
Device performance during active alarm	Device will continue to operate.

Medium-priority Patient Alarms with Variable Settings

HIGH TIDAL VOLUME

Priority	Medium
Why it occurs	<p><i>Passive, active flow, or dual limb circuit types:</i> The estimated exhaled tidal volume is greater than or equal to the High Vte alarm setting for a number of consecutive breaths. The number depends on the therapy mode as follows. Three consecutive breaths: A/C-PC, CPAP, PSV, S/T, SIMV-VC, and SIMV-PC. Six consecutive breaths: A/C-VC</p> <p><i>Active PAP circuit type:</i> The delivered tidal volume is greater than or equal to the High Vti alarm setting for three consecutive breaths.</p>
What to do	<ul style="list-style-type: none"> • Check the patient for pain or anxiety. • Check the circuit for kinked or pinched tubing. • Ensure that the active exhalation valve is attached. <p>Note: For active flow and dual limb, low flow O₂ or the use of a nebulizer may increase tidal volumes beyond the alarm setting.</p>
Device performance during active alarm	<p>The alarm is automatically resolved when a breath occurs in which the exhaled tidal volume does not reach the High Vte alarm setting.</p> <p>Device will continue to operate.</p>
Alarm Settings	10 to 2000 ml in increments of 5 ml.

LOW TIDAL VOLUME

Priority	Medium
Why it occurs	<p><i>Passive, active flow, or dual limb circuit types:</i> The estimated exhaled tidal volume is less than or equal to the low tidal volume alarm setting for a number of consecutive breaths. The number depends on the therapy mode as follows. Three consecutive breaths: A/C-PC, CPAP, PSV, S/T, SIMV-VC, and SIMV-PC. Six consecutive breaths: A/C-VC</p> <p><i>Active PAP circuit type:</i> The delivered tidal volume is less than or equal to the low tidal volume setting.</p>
What to do	<ul style="list-style-type: none"> • Check the circuit for kinked, pinched, or blocked tubing. • Ensure the leak device is not blocked, occluded, or disconnected. • Ensure the diaphragm in the active exhalation device is inserted correctly. • Check the mask fit or change the mask.
Requirements	<p><i>Passive, active flow, or dual limb circuit types:</i> The alarm is automatically resolved when a breath occurs in which the exhaled tidal volume exceeds the low tidal volume alarm setting.</p> <p>Device will continue to operate.</p> <p><i>Active PAP circuit type:</i></p>

	The alarm is automatically resolved when a breath occurs in which the exhaled tidal volume exceeds the low tidal volume alarm setting. Device will continue to operate.
Alarm Settings	10 to 2000 ml in increments of 5 ml.

HIGH MINUTE VENTILATION

Priority	Medium
Why it occurs	The patient's minute ventilation is greater than or equal to the high minute ventilation alarm setting.
What to do	Check if the patient is in pain or in an anxious state. Note: A patient in pain or in an anxious state may breathe at a higher rate or at a higher tidal volume. Such conditions may contribute to higher minute ventilation.
Device performance during active alarm	The alarm is automatically resolved when the calculated minute ventilation is less than the high minute ventilation alarm setting. Device will continue to operate.
Alarm Settings	Adult and Pediatric patient types: 0.2 to 30 LPM in minimum increments of 0.1 LPM. Infant patient type: 0.2 to 10 LPM in minimum increments of 0.1 LPM.

HIGH RESPIRATORY RATE

Priority	Medium
Why it occurs	The respiratory rate is greater than the High Respiratory Rate alarm setting. When the trigger type is 'Off' then the spontaneous respiratory rate will not trigger the alarm.
What to do	<ul style="list-style-type: none"> • Check the patient for pain or anxiety • Check the ventilator for auto-triggering Note: A patient in pain or in an anxious state may breathe at a higher rate.
Device performance during active alarm	The alarm is automatically resolved when the measured respiratory rate is less than the high respiratory rate alarm setting. Device will continue to operate.
Alarm Settings	Off, 1 to 90 BPM in increments of 1 BPM.

LOW INSPIRATORY PRESSURE ALARM

Priority	Medium
Why it occurs	The measured peak inspiratory pressure is less than or equal to the low inspiratory pressure alarm setting.
What to do	<ul style="list-style-type: none"> • Check the patient for changes that may cause this alarm, such as excessive patient inspiratory effort • Check the ventilator for <ul style="list-style-type: none"> ○ Kinked, pinched, or blocked tubing ○ Circuit leak or disconnect
Requirements	<i>Volume Modes:</i> - CV - SIMV-VC - AC
Device performance during active alarm	Device will continue to operate. The alarm is automatically resolved when the measured peak inspiratory pressure is greater than the low inspiratory pressure alarm setting.
Alarm Settings	PEEP+1 to 89 cmH ₂ O in increments of 1 cmH ₂ O.

LOW SpO₂

Priority	Medium
Why it occurs	The measured SpO ₂ is less than or equal to the Low SpO ₂ alarm setting while the device is delivering therapy or is in standby.
What to do	<ul style="list-style-type: none"> • Ensure that oxygen tubing is attached to the ventilator and the oxygen source. • Ensure that the oxygen source is providing oxygen. • Increase oxygen flow or increase FiO₂.
Requirements	<i>Requires pulse oximeter</i>
Device performance during active alarm	The alarm is automatically resolved when the measured SpO ₂ rises above the Low SpO ₂ alarm setting. Device will continue to operate.
Alarm Settings	50 to 95% in increments of 1%.

HIGH SpO₂

Priority	Medium
Why it occurs	The measured SpO ₂ is greater than or equal to the High SpO ₂ alarm setting.
What to do	<ul style="list-style-type: none"> • Ensure that the oxygen source is appropriate. • Decrease percentage of oxygen delivery.
Requirements	<i>Requires pulse oximeter</i>
Device performance during active alarm	The alarm is automatically resolved when the measured SpO ₂ falls below the High SpO ₂ alarm setting. Device will continue to operate.
Alarm Settings	90 to 100% in increments of 1%.

LOW EtCO₂

Priority	Medium
Why it occurs	The measured EtCO ₂ is less than or equal to the Low EtCO ₂ alarm setting for 10 seconds while the device is delivering therapy.
What to do	Check the patient. If there is a tracheal tube, verify it is properly inserted. Verify that leak is not excessive. High leak will reduce the measured EtCO ₂ . Review the ventilation parameters including tidal volume, minute ventilation and respiratory rate and verify that they are appropriate.
Requirements	CO ₂ sensor
Device performance during active alarm	The alarm is automatically resolved when the measured EtCO ₂ falls below the High EtCO ₂ alarm setting. Device will continue to operate.
Alarm Settings	1 to 100 mmHg in increments of 1 mmHg.

HIGH EtCO₂

Priority	Medium
Why it occurs	The measured EtCO ₂ is greater than or equal to the high EtCO ₂ alarm setting for 10 seconds while the device is delivering therapy.
What to do	<ul style="list-style-type: none"> • Passive circuit: check for an insufficient leak • Active and dual limb circuits: ensure the valve is operable
Requirements	CO ₂ sensor
Device performance during active alarm	The alarm is automatically resolved when the measured EtCO ₂ falls below the high EtCO ₂ alarm setting. Device will continue to operate.
Alarm Settings	1 to 100 mmHg in increments of 1 mmHg.

LOW FIO₂

Priority	Medium
Why it occurs	The measured FiO ₂ is less than or equal to the low FiO ₂ alarm setting for 10 seconds in active therapy.
What to do	<ul style="list-style-type: none"> • Confirm proper connection of the oxygen source. • When using low-flow oxygen, check for unnecessary leaks. Increase flow rate if possible. • When using high pressure oxygen, check for excessive leaks. • If the alarm persists, calibrate the oxygen sensor. See “chapter 7, Device Options.”
Requirements	FiO ₂ sensor
Device performance during active alarm	The alarm is automatically resolved when the measured FiO ₂ exceeds the low FiO ₂ alarm setting in active therapy. Device will continue to operate.
Alarm Settings	21 to 95% in increments of 1%.

HIGH FIO₂

Priority	Medium
Why it occurs	The measured FiO ₂ is greater than or equal to the high FiO ₂ alarm setting for 10 seconds.
What to do	<ul style="list-style-type: none"> • Confirm proper connection of the oxygen source. • When using low-flow oxygen, decrease the flow rate if possible. • If the alarm persists, calibrate the oxygen sensor. See “chapter 7, Device Options.”
Requirements	FiO ₂ sensor 100% O ₂ must not be active. This alarm is disabled when 100% O ₂ is active
Device performance during active alarm	The alarm is automatically resolved when the measured FiO ₂ falls below the high FiO ₂ alarm setting in active therapy (for 10 consecutive seconds). Device will continue to operate.
Alarm Settings	27 to 100% in increments of 1%

Low-priority System Alarms

STUCK KEY

Priority	Medium
Why it occurs	A stuck On/Off (Standby) button or Alarm Silence button has been detected for at least 120 seconds.
What to do	Contact Philips Respironics Customer Service
Device performance during active alarm	Device will continue to operate.

INLET FILTER BLOCKED

Priority	Low
Why it occurs	The inlet filter becomes blocked and delivered therapy is reduced.
What to do	Remove the filter. If the filter is the air-inlet foam filter, rinse it according to the instructions in the “Cleaning and Disinfection” chapter. Otherwise, replace the filter.
Requirements	Inlet filter installed
Device performance during active alarm	Device will continue to operate.
Algorithm summary	Because the inlet filter is blocked, the pressure generated by the ventilator is less than 75% of the estimated outlet pressure based on the nominal performance characteristics of the device.

CHECK PROXIMAL PRESSURE LINE

Priority	Low
----------	-----

Why it occurs	The proximal pressure line may be improperly connected or it may contain water droplets that affect the pressure reading.
What to do	<ul style="list-style-type: none"> Verify the proximal pressure line is connected properly at both ends and the line is clean and untangled. If necessary, clear the line and reconnect.
Requirements	Proximal pressure line attached
Device performance during active alarm	Device will continue to operate. Monitored parameters and alarms that use the pressure measurement will not function Monitored parameters and alarms that use the flow measurement, such as tidal volume, will continue to function
Algorithm summary	During periods of the breath when there is low flow in the inhalation limb, the pressure measured at the outlet of the device is compared to the pressure measured by the proximal line. When the difference is greater than 5 cm H ₂ O at low flow for three consecutive breaths, the alarm occurs.

Low-priority Patient Alarms with Variable Settings

LOW PULSE RATE

Priority	Low
Why it occurs	In the standby and therapy states, the measured pulse rate is less than or equal to the low-pulse-rate alarm setting.
What to do	Check probe placement and reposition
Requirements	Pulse oximeter reporting correctly for the previous three seconds
Device performance during active alarm	The alarm is automatically resolved when the measured heart rate exceeds the low pulse rate alarm setting. Device will continue to operate.
Alarm Settings	18 to 300 beats per minute in increments of 1 beat per minute.

HIGH PULSE RATE

Priority	Low
Why it occurs	In the standby and therapy states, the measured pulse rate is greater than or equal to the high-pulse-rate alarm setting.
What to do	<ul style="list-style-type: none"> Check oxygen flow to the ventilator
Requirements	Pulse oximeter reporting correctly for the previous three seconds.
Device performance during active alarm	The alarm is automatically resolved when the measured heart rate falls below the high pulse rate alarm setting. Device will continue to operate.
Alarm Settings	18 to 300 beats per minute in increments of 1 beat per minute.



Power Alarms

LOW BATTERY

Warning:

If the high-priority “Low Battery” alarm occurs, immediately connect the ventilator to an alternate power source. If no alternate power source is available, immediately place the patient on an alternate source of ventilation.

Priority	Medium priority when the last available battery is the detachable or internal battery and can provide at least 20 minutes of therapy and no more than 45 minutes of therapy Medium priority when the last available battery is the external DC source and can provide at least 20 minutes of therapy. High priority when the last available battery can provide at least 10 minutes of therapy.
Why it occurs	The last battery available is low or nearly depleted. This includes the internal battery.

	The alarm is medium priority and the icons are yellow when 25 minutes of time remains.	
	The alarm is high priority and the icons are red when 15 minutes of time remains.	
What to do	Switch to alternate battery or AC power to recharge the low battery. If the low battery is recharged and the alarm continues, replace the battery.	
Device performance during active alarm	Device will continue to operate.	

AC DISCONNECTED

Priority	Low	
Why it occurs	AC power is disconnected while the ventilator is providing therapy or in standby using AC power.	
What to do	<ul style="list-style-type: none"> • Switch to alternate power source. • Check AC connection 	
Device performance during active alarm	Device will continue to operate.	

INTERNAL BATTERY IN USE

Priority	Low	
Why it occurs	The power source has switched to the internal battery. You start therapy on internal battery power.	
What to do	<ul style="list-style-type: none"> • Confirm the remaining battery capacity. This is the last available power source. • Prepare an alternative power source such as AC power or an external battery. 	
Device performance during active alarm	Device will continue to operate.	

REPLACE DETACHABLE BATTERY

Priority	Low	
Why it occurs	The detachable battery has failed or the battery state of health is less than or equal to 60%.	
What to do	<ul style="list-style-type: none"> • Replace the detachable battery. • If the alarm continues, plug the device into an alternate AC power source. 	
Device performance during active alarm	Device will continue to operate. If the condition still exists 60 minutes after you manually reset the alarm, the alarm repeats.	

INTERNAL BATTERY DEPLETED

Priority	Low	
Why it occurs	The internal battery is depleted.	
What to do	Plug the device into an alternate AC power source, or connect to a fully charged detachable or external battery.	
Device performance during active alarm	Device will continue to operate.	

System Messages

Message	Cause
External DC Source Disconnected	Power is supplied from an external DC source and that power source is disconnected or depleted.
Depleted External DC	The external DC power source is depleted.
Check External DC	An external battery is connected but cannot supply sufficient power. Check for a faulty cable, bad connection, or bad battery.
Depleted Detachable Battery	The detachable battery is depleted.
Internal Battery Not Charging – Temperature	The system is unable to charge the internal battery due to temperature.
Internal Battery Not Discharging – Temperature	The internal battery is unable to power the device due to high or low temperature. Change the environmental temperature or relocate the device.
Detachable Battery Not Charging – Temperature	The system is unable to charge the detachable battery due to temperature.
Detachable Battery Not Discharging – Temperature	The system is unable to charge the detachable battery due to temperature.
Start On Battery	Trilogy Evo Universal is turned on and AC power is not detected. Reconnect AC power. Power is restored after losing all power and AC power is not detected. Reconnect AC power.
Circuit Mismatch <i>ActivePAP, passive, or dual limb/active flow circuits only</i>	The circuit type selected for use does not match the circuit connected to Trilogy Evo Universal for 3 consecutive breaths. Check the circuit type. Connect a circuit that matches the prescription.
Unsupported Accessory Connected	An unsupported accessory is connected to Trilogy Evo Universal.
FiO ₂ sensor not calibrated	When FiO ₂ monitoring is enabled and an FiO ₂ sensor is connected but was not calibrated
Replace FiO ₂ sensor	The FiO ₂ sensor is at the end of life or is no longer functioning.
Pulse Oximeter Connected	Indicates a pulse oximeter is now connected.
Mainstream Capnography Sensor Connected	Indicates a Mainstream Capnography Sensor is now connected

Prescription Alarm Availability by Therapy Mode

Most alarms operate regardless of the therapy mode being delivered. However, certain alarms operate only when certain therapy modes are being delivered.

The chart below lists those alarms and the therapy modes in which the alarms are available.

Alarm	A/C-PC	A/C-VC	CPAP	PSV	S/T	SIMV-PC	SIMV-VC
Apnea (requires Backup Ventilation)	X	X	X	X	X	X	X
Circuit Disconnect	X	X	X	X	X	X	X
High Tidal Volume	X	X	X	X	X	X	X
Low Tidal Volume	X	X	X	X	X	X	X
High Minute Ventilation	X	X	X	X	X	X	X
Low Minute Ventilation	X	X	X	X	X	X	X
High Respiratory Rate	X	X	X	X	X	X	X
Low Respiratory Rate	X	X	X	X	X	X	X
High Inspiratory Pressure		X					X
Low Inspiratory Pressure		X					X
High SpO ₂	X	X	X	X	X	X	X
Low SpO ₂	X	X	X	X	X	X	X
High Pulse Rate	X	X	X	X	X	X	X
Low Pulse Rate	X	X	X	X	X	X	X
High etCO ₂	X	X	X	X	X	X	X
Low etCO ₂	X	X	X	X	X	X	X
High FiO ₂	X	X	X	X	X	X	X
Low FiO ₂	X	X	X	X	X	X	X

Testing Alarms

Test alarms any time you make a significant change to the system.

Testing Circuit Disconnection Alarms

For ventilator-dependent patients, do not rely on any single alarm to detect when a circuit is disconnected. One or more of the following alarms may indicate a disconnected circuit.

- Circuit Disconnected
- Low Tidal Volume
- Low Minute Ventilation
- Low Respiratory Rate
- Low Peak Inspiratory Pressure alarms (user settable for volume modes)
- Leakage alarm (Active PAP circuit only)

To test that these alarms detect a circuit disconnection:

1. Ensure that the patient is connected to the ventilator and that ventilation is stabilized. Ensure that none of the alarms above are active.
2. Disconnect the circuit at the patient end of the circuit. Remove the leak device (passive circuits) and any humidifiers or other circuit accessories at the patient end of the circuit. Only the circuit tube should remain.
3. Confirm that one or more of the above-listed alarms activate.
4. Reconnect the circuit and confirm that any active alarm automatically resets.

Testing Circuit Obstruction Alarms

For ventilator-dependent patients, do not rely on any single alarm to detect when a circuit is obstructed. One or more of the following alarms may indicate an obstructed circuit.

- Obstruction
- High Inspiratory Pressure

- Circuit Disconnected
- Low Tidal Volume
- Low Minute Ventilation
- Low Respiratory Rate
- Low Peak Inspiratory Pressure alarms (user settable for volume modes)
- Leakage alarm (Active PAP circuit only)
- Rebreathing Detected

To test that these alarms detect a circuit obstruction:

1. Ensure that the patient is connected to the ventilator and that ventilation is stabilized.
2. **For a Passive circuit:** Disconnect the circuit at patient connection port and remove the leak device and block the end of the circuit.
For Active circuit: Disconnect the circuit at patient connection port and block the end of the circuit.
3. Confirm that one or more of the above-listed alarms activate.
4. Reconnect the circuit and confirm that any active alarm automatically resets.

Testing the Leakage Alarm

For an Active PAP circuit, the Leakage alarm detects a leak in the active exhalation valve (AEV).

To test the Leakage alarm:

1. Ensure that the patient is connected to the ventilator and that ventilation is stabilized.
2. Disconnect the AEV control line from the ventilator.
3. Confirm that the Circuit Leakage, and/or Check Active Exhalation Valve Line alarm activates.
4. Reconnect the AEV control line and confirm that the alarm automatically resets.

Testing the Low FiO₂ Alarm

The Low FiO₂ alarm requires an FiO₂ sensor to be connected and the FiO₂ sensor setting to be turned on.

To test the Low FiO₂ alarm:

1. Ensure that the patient is connected to the ventilator and that ventilation is stabilized.
2. Disconnect the oxygen from the ventilator
3. Confirm that the Low FiO₂ alarm activates.
4. Reconnect the oxygen and confirm that the alarm automatically clears, which may take 30 seconds or more.

Testing Power Alarms

Power indicators in the Status Bar:

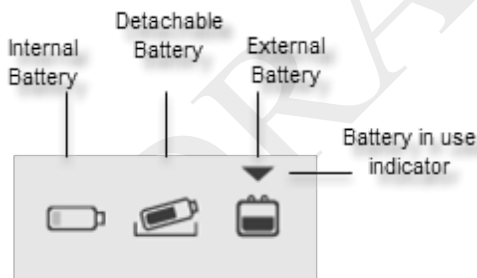

To test power alarms:

1. Connect Trilogy Evo Universal to AC power.
2. Ensure Trilogy Evo Universal is using AC power. You should see the green LED light next to the power button.
3. Disconnect AC power (pull the power cord out of the outlet).
4. Confirm that the AC Disconnected alarm activates.
5. If connected to an external battery, go to the next step. Otherwise go to step 9.
6. Confirm that the device continues to operate, the external battery icon appears in the Status Bar, and that the Battery-in-use Indicator is pointing to the external battery icon.

7. Disconnect the external battery.
8. Confirm that the External DC Source Disconnected system message appears.
9. Confirm that the device continues to operate, the detachable battery icon appears in the Status Bar, and that the Battery-in-use Indicator is pointing to the detachable battery.
10. Remove the detachable battery.
11. Confirm that the Internal Battery in Use alarm activates.
12. Confirm that the device continues to operate, that the internal battery icon appears in the Status Bar, and that the Battery-in-use indicator is pointing to the internal battery.

To test the low battery alarm:

1. Ensure that AC power is available.
2. Disconnect all power sources and remove the detachable battery.
3. Allow the device to use internal battery power.
4. Confirm that the medium-priority Low Battery alarm activates and that the device continues to operate.
5. Continue to allow the device to use internal battery power.
6. Confirm that the high-priority Low Battery alarm activates and that the device continues to operate.
7. Insert the detachable battery and reconnect AC power to recharge the batteries.

Testing Therapy Setting Alarms

When testing alarms, remember that you can use the Alarm Silence button. To test alarms related to therapy settings:

1. Set the therapy mode to A/C-VC.
2. Connect a circuit to the device and to a test lung.
3. Observe the measured values.

4. Set the High Tidal Volume alarm limit below the measured tidal volume value.
5. Confirm that the High Tidal Volume alarm activates.
6. Restore the alarm limit.

7. Set the Low Tidal Volume alarm limit above the measured tidal volume value.
8. Confirm the Low Tidal Volume alarm activates.
9. Restore the alarm limit.

10. Set the High Minute Ventilation alarm limit below the measured minute ventilation value.
11. Confirm that the High Minute Ventilation alarm activates.
12. Restore the alarm limit.

13. Set the Low Minute Ventilation alarm limit above the measured minute ventilation value.
14. Confirm that the Low Minute Ventilation alarm activates.
15. Restore the alarm limit.

16. Set the High Respiratory Rate alarm limit below the measured respiratory rate value.
17. Confirm that the High Respiratory Rate alarm activates.
18. Restore the alarm limit.

19. Set the Low Respiratory Rate alarm limit above the measured respiratory rate value.
20. Confirm that the Low Respiratory Rate alarm activates.
21. Restore the alarm limit.

22. Set the High Inspiratory Pressure alarm limit below the measured PIP value.
23. Confirm that the High Inspiratory Pressure alarm activates.
24. Restore the alarm limit.

25. Set the Low Inspiratory Pressure alarm limit above the measured PIP value.
26. Confirm that the Low Inspiratory Pressure alarm activates.
27. Restore the alarm limit.

Testing Patient-Monitoring Alarms

Before testing these alarms, ensure that the patient is connected to the ventilator and that ventilation is stabilized. Ensure that the monitor is connected and functional. To test alarms related to patient monitoring where the alarm limits are settable:

ETCO₂

1. Set the High ETCO₂ alarm limit below the measured ETCO₂ value.
2. Confirm that the High ETCO₂ alarm activates.
3. Restore the alarm limit.
4. Set the Low ETCO₂ alarm limit above the measured ETCO₂ value.
5. Confirm the Low ETCO₂ alarm activates.
6. Restore the alarm limit.

PULSE RATE

1. Set the High Pulse Rate alarm limit below the measured Pulse Rate value.
2. Confirm that the High Pulse Rate alarm activates.
3. Restore the alarm limit.
4. Set the Low Pulse Rate alarm limit above the measured Pulse Rate value.
5. Confirm the Low Pulse Rate alarm activates.
6. Restore the alarm limit.

SPO₂

1. Set the High SpO₂ alarm limit below the measured SpO₂ value.
2. Confirm that the High SpO₂ alarm activates.
3. Restore the alarm limit.
4. Set the Low SpO₂ alarm limit above the measured SpO₂ value.
5. Confirm the Low SpO₂ alarm activates.
6. Restore the alarm limit.

Alarm and Event Log

The Alarm and Event Log is a record of all events related to the device and to therapy. The log shows each event, when it occurred, and a brief description. Information is retained even when you shut off the device or when power is lost. The log stores the most recent 6-months of information with the exception of the event log, which stores the most recent 10,000 records. Older records are overwritten.

To access the Alarm and Event Log:

1. In the menu bar, tap the **Options** icon. 
2. In the **Options** window, tap **Alarm & Event Log**.

Parts of the Alarm and Event Log

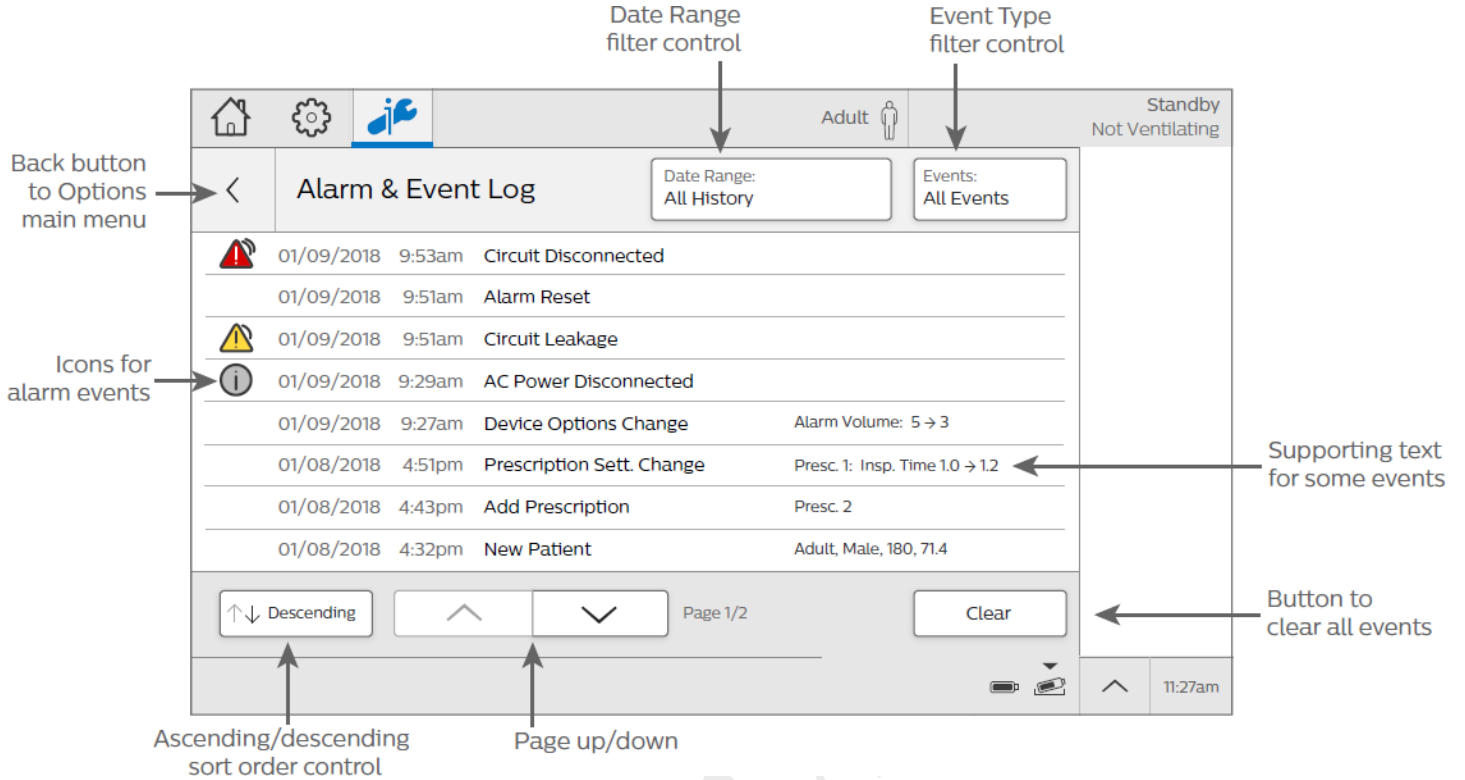

Item	Description														
1. Date Range	Tap to filter events by date. On the Select Date Range dialog box, select the date range and then tap Accept .														
2. Events	Tap to filter events so only alarms appear in the list. Tap again to view all event types.														
3. Alarm and event list	<table border="1"> <thead> <tr> <th>Event Type</th> <th>Icon</th> </tr> </thead> <tbody> <tr> <td>High-Priority Alarm</td> <td></td> </tr> <tr> <td>Medium-Priority Alarm</td> <td></td> </tr> <tr> <td>Low-Priority Alarm</td> <td></td> </tr> <tr> <td>Info-Type Alarm</td> <td></td> </tr> <tr> <td>Event</td> <td></td> </tr> <tr> <td colspan="2"> <ul style="list-style-type: none"> • Power or battery • Physical button press • Calibration event • Change to therapy setting, alarm setting, or device option • Data transfers </td> </tr> </tbody> </table>	Event Type	Icon	High-Priority Alarm		Medium-Priority Alarm		Low-Priority Alarm		Info-Type Alarm		Event		<ul style="list-style-type: none"> • Power or battery • Physical button press • Calibration event • Change to therapy setting, alarm setting, or device option • Data transfers 	
Event Type	Icon														
High-Priority Alarm															
Medium-Priority Alarm															
Low-Priority Alarm															
Info-Type Alarm															
Event															
<ul style="list-style-type: none"> • Power or battery • Physical button press • Calibration event • Change to therapy setting, alarm setting, or device option • Data transfers 															
4. Ascending/Descending button	Sort the list by date and time.														
5. Page up and down	Tap to scroll through the log.														
6. Clear	Clear all events from the screen.														

7. Device Options

Use the features contained in the Options window to change device settings, run calibrations and tests, and view and work with data.

Device options include the following features:

- Device Settings
- Calibration
- Data Transfer
- Alarm & Event Log – see the “Alarms and System Messages” chapter
- Information

Device Settings

Use the Device Settings feature to customize Trilogy Evo Universal. When working with settings, ensure you save your changes. After 30 seconds of inactivity, the system reverts to the previous setting and your changes are not saved.

To change a setting:

1. In the menu bar, tap the **Options** icon. 
2. In the **Options** window, tap **Device Settings**.
3. In the **Device Settings** window, tap the setting you want to change.
4. In the setting dialog box, make your selection.
5. When your selection is complete, on the title bar, tap the **Accept** checkmark.

Setting	Description
Language	Set the device language.
Alarm Volume	Set system alarm loudness.
Screen Brightness	Set screen brightness.
Light Bar	Turn the light bar on or off.
Automatic Touchscreen Lock	Automatically locks the screen after five minutes of inactivity. The screen automatically unlocks during an alarm.
Screen Saver	Select the type of screen saver that you want to use.
Date and Format	Set the system date and format.
Time and Format	Set the system time and select 12- or 24-hour format.
Manual Breath	Turn the manual breath feature on or off.
FiO ₂ Sensor	Turn the FiO ₂ sensor on or off.
NFC	Turn nearfield communication on or off.
CMD	Turn CMD (communication means device) status on or off.
Device Units	Select the pressure and CO ₂ measurement units.
Patient Units	Select metric or imperial measurement units.
Bluetooth	<ul style="list-style-type: none"> - <i>To enable a Bluetooth connection:</i> tap Bluetooth. On the dialog box, tap On. Note that a Bluetooth symbol appears in the Status Bar to indicate when devices are connected. - <i>To disable the Bluetooth connection:</i> tap Bluetooth. On the dialog box, tap Off. - <i>To clear all devices from memory:</i> tap Bluetooth. On the dialog box, tap Forget All Devices. (Disabled when Bluetooth is not enabled.) Note: Bluetooth functionality may not be present in all models.

Calibration

Circuit Calibration Concepts

The Trilogy Evo Universal is optimized for circuits that are within the specifications shown in the Circuit section of the Accessories chapter. If you want to use a different circuit, you can perform an optional Circuit Calibration, intended to characterize compliance and resistance. The circuit calibration process includes the following procedures, based on the type of prescription:

Depending on the circuit type:

- Active circuits: calibrates according to the results of the leak test, compliance, and resistance
- Passive circuits: calibrates according to the compliance and resistance

When you start the circuit calibration, follow the instructions on the screen as the system completes the tests.

If the calibration is successful, then you will see a confirmation message.

If the circuit fails any part of the test, the reason appears in the window. Adjust the circuit and repeat the calibration. If you repeat the calibration but the circuit still fails, you can either replace the circuit and try again or you can use the default settings.

Information about the circuit calibration is recorded in the Event Log. For more information about the Event Log, see “Alarm and Event Log” in the “Alarms” chapter.

CALIBRATING A CIRCUIT

Requirements:

- The patient’s demographics and prescription are entered into the system
- The patient interface is not attached to the circuit.

To calibrate a circuit:

1. In the menu bar, tap the **Options** icon. 

- In the **Options** window, tap **Calibration & Setup**.

2. In the **Calibration & Setup** window, tap **Circuit Calibration**.

3. In the **Calibrate Circuit** window, in the **Current Prescriptions** list, locate the prescription you want to calibrate and then tap **Calibrate**.

4. Follow the instructions on the screen.
 - If any part of the test fails, correct the issue suggested on the screen and then tap **Retest** to continue the test.
 - To cancel the test, tap the Close icon at the top of the window.

USING DEFAULT SETTINGS

If you want to stop using calibrated settings and return to the default settings, follow these instructions:

1. In the menu bar, tap the **Options** icon. 

- In the **Options** window, tap **Calibration & Setup**.

2. In the **Calibration & Setup** window, tap **Circuit Calibration**.

3. In the **Calibrate Circuit** window, in the **Current Prescriptions** list, locate the prescription you want to calibrate and then tap **Set to Defaults**.

4. On the confirmation window, tap **Yes**.

Leak Test

A leak test is available for times when you want to perform only a leak test and not complete an entire circuit calibration.

Prerequisites:

- Ensure the prescription is for an active circuit:
 - Active Flow
 - Active PAP
 - Dual Limb
- Remove the patient interface from the circuit.
- Block the end of the circuit where the patient interface would be.
- If the circuit includes a heated humidifier, ensure the humidifier chamber is filled.
- Ensure the external active exhalation valve is properly assembled and connected.

To perform a leak test:

1. In the menu bar, tap the **Options** icon. 

- In the **Options** window, tap **Calibration and Setup**.

2. In the **Calibration & Setup** window, tap **Leak Test**.

3. Review the prerequisites and then tap **Start**.

4. The system performs the test. The results appear in the test progress pane. If the test:
 - *Fails*: Review the failure reasons. If you want to try again, tap **Retest**; otherwise, tap the cancel button at the top of the window.
 - *Passes*: tap **OK**.

O₂ Sensor Calibration

Prerequisites:

- Ensure the patient circuit is connected.
- Remove the patient interface from the circuit.
- Remove any passive exhalation device.
- Connect high-pressure O₂.
- Ensure that low-flow O₂ is not connected.

To calibrate the O₂ sensor:

1. In the menu bar, tap the **Options** icon. 

2. In the **Options** window, tap **Calibration and Setup**.

3. In the **Calibration & Setup** window, tap **O₂ Sensor Calibration**.

4. Review the prerequisites and then tap **Start**.

5. The system performs the Circuit Flush test. The results appear in the progress pane. If the test:
 - *Fails*: Review the failure reasons. If you want to try again, tap **Retest**; otherwise, tap **Quit**.
 - *Passes*: go to the next step.

6. Block the end of the circuit and then tap **Continue**.

7. The system performs the 21% Calibration test. The results appear in the progress pane. If the test:
 - *Fails*: Review the failure reasons. If you want to try again, tap **Retest**; otherwise, tap **Quit**.
 - *Passes*: go to the next step.

8. If you are using an oxygen-blending module, confirm that high-pressure O₂ is connected and the circuit outlet is blocked and then tap **Continue**. Otherwise, the test is complete.

9. The system performs the test. The results appear in the test progress pane. If the test:
 - Fails: Review the failure reasons. If you want to try again, tap **Retest**; otherwise, tap **Quit**. To deactivate the FiO₂ sensor, turn off the FiO₂ sensor in Device Options, Device Settings.
 - Passes: tap **OK**.

CO₂ Sensor Adapter Zero

Perform this task when installing a CO₂ sensor (capnograph)

To establish a baseline CO₂ level:

1. Place the CO₂ sensor onto a clean and dry airway adapter that is exposed to room air, but is away from all CO₂ sources including the ventilator, your breath, and the patient's breath.
2. In the menu bar, tap the Options icon.
3. In the Options window, tap Calibration and Setup.
4. In the **Calibration & Setup** window, tap **CO₂ Sensor Adapter Zero**.
5. Review the prerequisites and then tap **Start**.
6. The system performs the test. The results appear in the test progress pane. If the test:
 - Fails: Review the failure reasons. If you want to try again, tap **Retest**; otherwise, tap the **Quit**.
 - Passes: tap **OK**.

Data Transfer

Use data transfer functions to import and export various sets of data. When working with patient data, ensure the data is kept secure. When working with an external storage device that contains patient information, such as a USB flash drive, ensure you delete that data by reformatting the storage device.

To access the data transfer functions:

1. Connect a data storage device to the USB port on the Service Panel.
2. In the menu bar, tap the **Options** icon.
3. In the **Options** window, tap **Data Transfer**.

4. In the **Data Transfer** window, tap the procedure you would like to perform and then follow the prompts on the screen:

Function	Description								
Export Data - USB	Export details about the patient’s therapy to a storage device connected to the USB port. Data is identified by the device serial number.								
	<table border="1"> <thead> <tr> <th>Data type</th> <th>Data stored</th> </tr> </thead> <tbody> <tr> <td>Changes to the ventilator, alarms, prescriptions, accessories and oxygen</td> <td rowspan="2">6 months</td> </tr> <tr> <td>30-second averages of each therapy parameter related to the therapy provided to the patient</td> </tr> <tr> <td>Waveform data including pressure, flow, volume, and total leak</td> <td rowspan="2">31 days</td> </tr> <tr> <td> Patient monitors: <ul style="list-style-type: none"> - CO₂ monitor data - Oximeter data - FiO₂ monitor data </td> </tr> </tbody> </table>	Data type	Data stored	Changes to the ventilator, alarms, prescriptions, accessories and oxygen	6 months	30-second averages of each therapy parameter related to the therapy provided to the patient	Waveform data including pressure, flow, volume, and total leak	31 days	Patient monitors: <ul style="list-style-type: none"> - CO₂ monitor data - Oximeter data - FiO₂ monitor data
	Data type	Data stored							
	Changes to the ventilator, alarms, prescriptions, accessories and oxygen	6 months							
	30-second averages of each therapy parameter related to the therapy provided to the patient								
Waveform data including pressure, flow, volume, and total leak	31 days								
Patient monitors: <ul style="list-style-type: none"> - CO₂ monitor data - Oximeter data - FiO₂ monitor data 									
Export Data - Bluetooth	Export details about the patient’s therapy to a storage device connected through Bluetooth. Data is identified by the device serial number.								
Export Alarm & Event Log	Export the alarm and event logs. If two storage devices are connected, the logs are saved to the device that was connected first.								
	Install Prescriptions	Installs prescriptions that were previously exported.							
	Install Software Update	Ensure the version number that you are installing is higher than the current software version. After installing the update, the system automatically restarts.							

As data is transferred, a data transfer icon appears in the Status Bar.

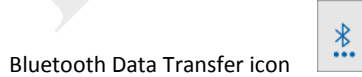

Information

The information window shows general information about the Trilogy Evo Universal device, including the following:

To change pages, tap the page icons at the bottom of the window. To view software licenses and photography credits, tap the item you want to view.

Page 1	
<ul style="list-style-type: none"> - DME Representative Name - DME Contact Phone - DME Contact Email - DME Company 	<ul style="list-style-type: none"> - Model Number - Serial Number - Software Version Number - Hardware Version Number
Page 2	
<ul style="list-style-type: none"> - Internal Battery State of Health - Detachable Battery State of Health - Internal Battery Serial Number - Detachable Battery Serial Number 	<ul style="list-style-type: none"> - Operational Hours – Total Blower Hours - Operational Hours – Total Patient Hours
Page 3	
<ul style="list-style-type: none"> - Software licenses - Photography credits 	

DRAFT 01/26/2018

8. Cleaning and Disinfection

This chapter contains instructions for cleaning and disinfecting Trilogy Evo Universal, and cleaning, disinfecting, and sterilizing Trilogy Evo Universal accessories. Because Trilogy Evo Universal is intended for multi-patient use, ensure you follow the cleaning, disinfection, and sterilization instructions in this chapter.

Exterior Cleaning and Disinfection

Warning: To avoid electric shock, do not remove the enclosure cover. Only service personnel should remove the enclosure. After cleaning and disinfecting, ensure the device is completely dry before reattaching accessories and connectors and before reconnecting it to a power source. To avoid electrical shock, always unplug the power cord from the wall outlet before cleaning the ventilator. If the device has been exposed to rain or dampness, dry the device including the area around the power cord connection with the power cord disconnected from the device before applying AC power.

Caution: Do not immerse the device or allow liquids into any of the controls or the interior of the enclosure as the device may be damaged. If this occurs, contact your equipment provider for assistance. Use only the cleaning agents and methods described in this section to clean and disinfect the device.

Cleaning the Exterior

Frequency: Clean Trilogy Evo Universal's exterior surface weekly and between patients.

Requirements: lint-free cloth, soft-bristle brush, and liquid dishwashing detergent solution: 1 teaspoon of liquid dishwashing detergent (such as Dawn Ultra Dishwashing Liquid®) per gallon of water

1. Turn Trilogy Evo Universal off and disconnect it from the power source.
2. Detach all accessories and connectors.
3. Use a lint-free cloth dampened (not dripping) with a liquid dishwashing detergent solution to clean the exterior of the enclosure.
4. Use a soft-bristle brush in the areas around the screen, buttons, and any other areas where soil may be difficult to remove. Ensure you remove all visible soil.
5. Use a lint-free cloth dampened (not dripping) with clear water to remove all detergent residue.
6. Use a lint-free cloth to dry the enclosure.
7. Inspect the device for cleanliness.
8. Repeat the cleaning steps until the surfaces are visibly clean.
9. Inspect the device for damage after cleaning. If any parts are damaged, contact Philips Respironics Customer Service.

Disinfecting the Exterior

Frequency: Disinfect Trilogy Evo Universal's exterior surface weekly and between patients.

Prerequisite: Before disinfecting Trilogy Evo Universal's exterior, ensure you have cleaned Trilogy Evo Universal as instructed in the previous section, "Cleaning the Exterior."

ISOPROPYL ALCOHOL

Use a minimum of 70% isopropyl alcohol but no more than 91% by volume.

1. Use a lint-free cloth dampened with alcohol to clear visible soil from the surfaces.
2. Use a second lint-free cloth to wipe the alcohol onto the exterior, thoroughly wetting the surfaces.
3. Keep wet 10 minutes.
4. Allow to air dry.

CHLORINE BLEACH

Use a household chlorine bleach containing 8.25% sodium hypochlorite.

1. Combine 10 parts water to 1 part bleach.
2. Use a lint-free cloth dampened with the bleach solution to clear visible soil from the surfaces.
3. Use a second lint-free cloth to wipe the bleach solution onto the exterior, thoroughly wetting the surfaces.
4. Keep wet 10 minutes.
5. Allow to air dry.

Cleaning the Detachable Battery

Frequency: Clean the detachable battery monthly and between patients.

Requirements: lint-free cloth, soft-bristle brush, and liquid dishwashing detergent solution: 1 teaspoon of liquid dishwashing detergent (such as Dawn Ultra Dishwashing Liquid) per gallon of water

1. Remove the detachable battery.
Open the detachable battery access door. Lift the battery handle and pull the battery to remove it from the battery bay.



2. Use a lint-free cloth dampened (not dripping) with a liquid dishwashing detergent solution to wipe the battery. Ensure you remove all visible soil.
3. Use a soft-bristle brush to clean any small areas, such as crevices or small openings that are not accessible with the cloth.
4. Use a lint-free cloth dampened (not dripping) with clear water to remove all detergent residue.
5. Allow the battery to air dry completely.
6. Inspect the battery for damage after cleaning. If any part is damaged, contact Philips Respironics Customer Service.
7. Replace the battery.
Open the detachable battery access door. Slide the battery into the bay until you hear a click.

Rinsing the Air-Inlet Foam Filter

The air-inlet foam filter is the gray foam located on the back panel. It protects Trilogy Evo Universal from dirt and dust. Only use Philips Respironics-supplied filters. Ventilation can continue while you are replacing the filter.

Frequency: For invasive ventilation, rinse daily and dispose monthly. For non-invasive ventilation, rinse monthly and dispose yearly. Dispose between patients.

Requirements: replacement filter, water

To rinse the disposable inlet filter:

1. Ensure you have a replacement filter nearby.
2. Pinch the filter and pull it out of the filter cover.
3. Insert the clean replacement filter into the filter cover. Ensure it is positioned securely.
4. Visually inspect the filter you just removed from the device.
5. If it is damaged, discard it according to your local regulations. Otherwise, proceed to the next step.
6. Rinse the dirty filter in clear water. Inspect the filter for cleanliness and repeat previous step until the filter is clean.
7. Allow the filter to air dry completely before reinstalling it.

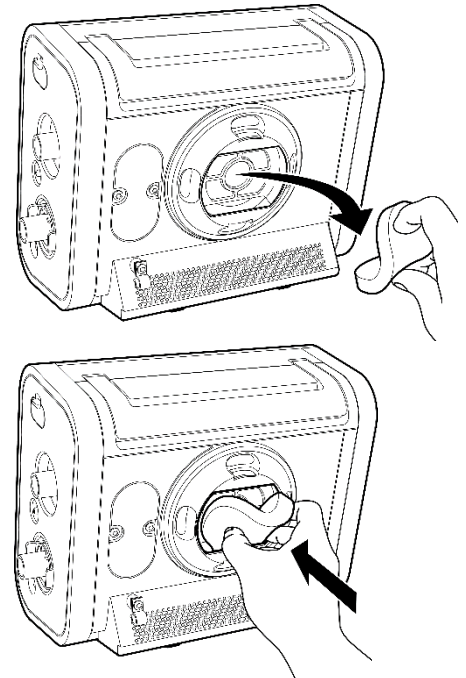

External Active Exhalation Valve Cleaning and Disinfection

Frequency: Clean the active exhalation valve weekly. Clean and disinfect or sterilize the active exhalation valve between patients. Replace the silicon diaphragm each time you disinfect or sterilize the valve.

Cleaning the External Active Exhalation Valve

Requirements: Lint-free cloth or cotton swab, soft-bristle brush, liquid dishwashing detergent solution, such as Dawn Ultra Dishwashing Liquid: 1 teaspoon detergent to 1 gallon of water

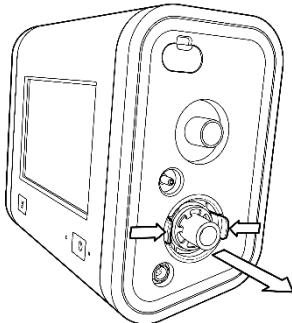

Figure 2

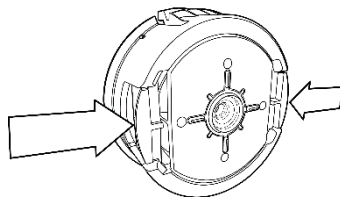

Figure 3

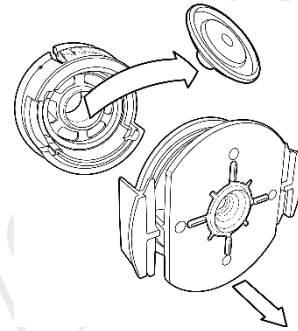

Figure 4

1. Remove the valve from Trilogi Evo Universal: Squeeze the two tabs and pull out from the device (Figure 1).
2. Open the valve: Squeeze the two tabs (Figure 2) and pull apart (Figure 3).
3. Detach the silicon diaphragm. (If you are going to disinfect or sterilize the valve, discard the diaphragm according to your local regulations on discarding biohazardous waste.)
4. Submerge the valve parts in warm water with a liquid dishwashing detergent solution.
5. Agitate the parts to ensure all internal and external surfaces are saturated with the solution.
6. Use a lint-free cloth or cotton swab to remove all visible soil.
7. Use a soft-bristle brush to clean any small areas, such as crevices or small openings that are not accessible with the cloth or swab.
8. Rinse thoroughly with clear water to remove all detergent residue.
9. Allow the valve to air dry completely before reinstalling it.
10. Examine the valve. If it is damaged, discard it. If you are going to disinfect the valve, go to “Disinfecting the External Active Exhalation Valve.” Otherwise, continue to the next step.
11. Replace the diaphragm as shown in the illustration. Ensure you have positioned the diaphragm correctly.
12. Reassemble the valve and replace it as shown in Figures 4 and 5.

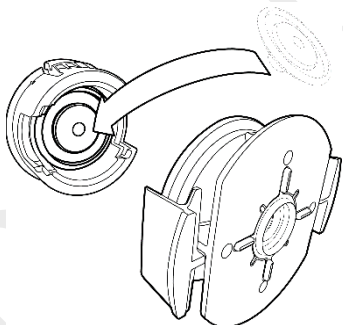

Figure 5

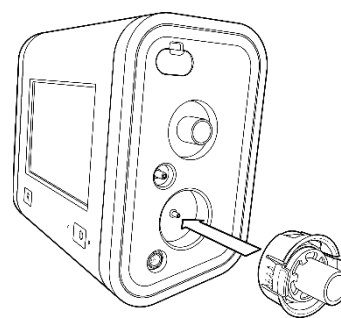

Figure 6

Disinfecting the External Active Exhalation Valve

Requirements:

- Replacement silicon diaphragm
- 2.4% Activated Glutaraldehyde Solution (CIDEX®)
- Distilled water

To disinfect the valve:

1. Disassemble the valve, discarding the silicon diaphragm according to your local regulations on discarding biohazardous waste. Then proceed to clean and dry the valve according to the instructions in the previous section, "Cleaning the External Active Exhalation Valve."
2. Read and follow the manufacturer's instructions on how to prepare, activate, use, and dispose of the Cidex solution. Follow all safety precautions.
3. Submerge the clean and dry valve in Cidex solution. Agitate the parts to ensure all internal and external surfaces are saturated with the solution. Soak the valve in Cidex for 45 minutes at 20°C.
4. Remove the valve from the solution and pour excess cleaning agent from the valve.
5. Rinse thoroughly with clear water.
6. Allow the valve to dry entirely.
7. Examine the valve. Replace any part that is damaged (visible cracks, distorted parts, or altered color).
8. Insert a new diaphragm as shown in the illustration. Ensure you have positioned the diaphragm correctly.
9. Reassemble the valve and replace it as shown in *Figures 4 and 5* in the previous section.

Sterilizing the External Active Exhalation Valve

You can sterilize the external active exhalation valve using a hydrogen peroxide gas plasma sterilizer, such as Sterrad®.

Requirements: Replacement silicon diaphragm

To sterilize the valve:

1. Disassemble the valve, discarding the silicon diaphragm according to your local regulations on discarding biohazardous waste. Then proceed to clean and dry the valve according to the instructions in the previous section, "Cleaning the External Active Exhalation Valve."
2. Read and follow the instructions of your sterilization device. Follow all safety precautions.
1. Allow the valve to cool and dry entirely in a clean and dry environment.
Caution: Allow any liquid to evaporate entirely before reconnecting the valve.
2. Examine the valve. Replace any part that is damaged (visible cracks, distorted parts, or altered color).
3. Insert a new diaphragm as shown in the illustration. Ensure you have positioned the diaphragm correctly.
4. Reassemble the valve and replace it as shown in *Figures 4 and 5* in the previous section.

9. Service and Maintenance

Service

Repairs and adjustments must be performed by service personnel only. Unauthorized service could cause death or injury, invalidate the warranty, or result in costly device damage. Service technicians can request circuit diagrams, component part lists, descriptions, and calibration instructions to help service the device. See the service manual.

The device should be serviced for preventive maintenance every 24 months or 10,000 blower hours. To see the blower hours: in the menu bar, tap the **Device Options** icon, and then in the **Options** window, tap **Information**.

Trilogy Evo Universal's expected service life is 10 years.

Disposal

Separate collection for electrical and electronic equipment per EC Directive 2012/19/EU. Dispose according to local regulations. If you need help, contact Philips Respironics.

Routine Maintenance

Conduct basic maintenance according to the table below.

Daily	Visually inspect accessories for damage or signs of wear. Discontinue use and replace if damaged. When using oxygen, to maintain accuracy, calibrate the oxygen sensor daily. See "O ₂ Sensor Calibration" in the "Device Options" chapter.
Monthly	Replace the particulate filter (when in use) For invasive ventilation, dispose of the air-inlet foam filter.
Every six months	Ensure the internal battery has been charged at least once in the previous six months. The internal battery charges when connected to AC power.
Yearly	For non-invasive ventilation, dispose of the air-inlet foam filter.

Replacing the Air-Inlet Foam Filter

The air-inlet foam filter is the gray foam located on the back panel. It protects Trilogy Evo Universal from dirt and dust. This filter is for single patient use.

For invasive ventilation, dispose monthly. For non-invasive ventilation, dispose yearly. Only use Philips Respironics-supplied filters. Dispose according to local regulations. Ventilation can continue while you are replacing the filter.

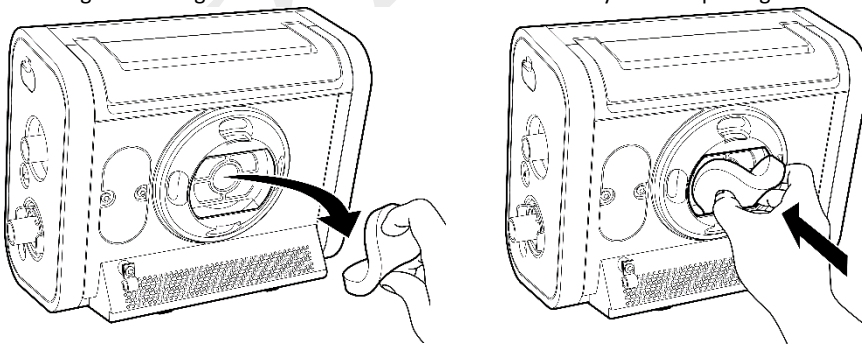

To replace the disposable inlet filter:

1. Ensure you have a replacement filter nearby.
2. Pinch the filter and pull it out of the filter cover.
3. Insert the clean replacement filter into the filter cover. Ensure it is positioned securely.

Replacing the Particulate Filter

The particulate filter is an optional filter that protects Trilogy Evo from dirt and dust. Replace the particulate filter monthly and between patients. Ventilation can continue while you replace the filter.

Twist the filter cover counterclockwise a quarter of a turn, and then pull straight out to remove.

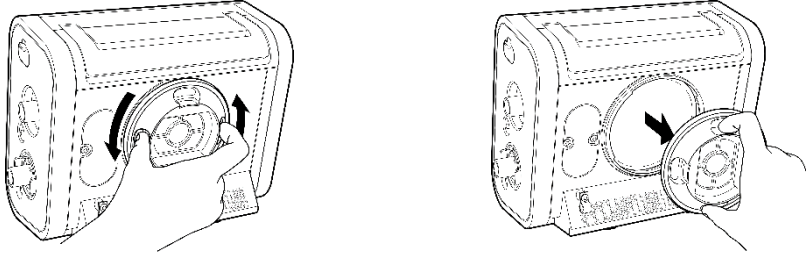

Twist the filter counterclockwise a quarter of a turn, and then pull straight out to remove.

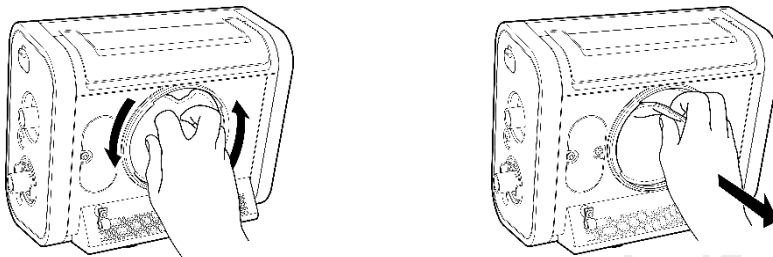

Place a new filter onto the bayonet mount then twist the filter clockwise a quarter of a turn while pressing in to secure.

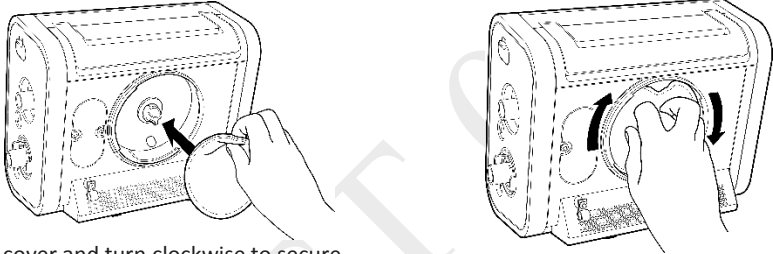

Replace the filter cover and turn clockwise to secure.

Preparing the Device for a Use by a Different Patient

If you are setting up a prescription for a different patient, before creating a new prescription, in the **Home** window, tap the **New Patient** button to reset to the default prescription settings, reset the patient operational hours to zero, and clear all existing patient data, including the following: event and alarm logs, circuit calibration, and historical data. Additionally, tapping New Patient deletes all Bluetooth settings.

If you used an external storage device that contains patient information, such as a USB flash drive, ensure you delete that data by reformatting the storage device.

Before using Trilogy Evo Universal with a new patient, perform the following actions. Cleaning and disinfection instructions are in the “Cleaning and Disinfection” chapter.

- Replace the circuit, including the bacteria filter.
- Clean and disinfect the active exhalation valve
- Clean and disinfect the external flow sensor
- Clean and disinfect the exterior surface and detachable battery.
- Replace the air inlet foam filter and particulate filter
- Clear the old patient data from the system: In the **Home** window, tap the **New Patient** button.
- If you used an external storage device that contains patient information, such as a USB flash drive, ensure you delete that data by reformatting the storage device.

10. Trilogy Evo Universal Accessories

To prevent adverse performance, use Trilogy Evo Universal only with accessories intended for use with this device, including all patient interfaces, masks, circuits, exhalation ports, and carrying cases. For a list of accessories, see the Trilogy Evo Universal accessories guide at: <https://www.usa.philips.com/healthcare/product/HCD52110X11B/trilogyevo>.

You must ensure accessories and parts are compatible before you connect a patient to the device. If you are using a remote alarm or nurse call, ensure you test the accessory before starting ventilation.

The accessories described in this chapter are those included in your device package. For all other accessories, see the accessory's instructions.

Power Accessories

For instructions, see "Power Management."

Patient Monitors

FiO₂ sensor

An FiO₂ sensor is installed in your device. For instructions on calibrating the sensor, see "Trilogy Evo Universal Options, O₂ Sensor Calibration"

Intended Use: The Philips Respironics FiO₂ Sensor is an oxygen sensor device that is used for measuring the fraction of inspired oxygen (oxygen concentration in a percentage) delivered from the oxygen source to the airway of a patient circuit (such as hose and mask).

Storage and Handling

- Avoid rough handling that would damage the sensor.
- Avoid exposing sensor(s) to rapid changes in pressure.
- Avoid puncturing or damaging sensor membrane(s).

Accidental release measures: The oxygen sensors contain a strong basic solution encapsulated in a plastic housing. Under normal operating conditions, the solution (electrolyte) is never exposed. In case of a leak, please observe the following instructions:

Personal precautions, protective equipment, and emergency procedures

Use personal protective equipment. Avoid dust formation. Avoid breathing vapors, mist, or gas. Ensure adequate ventilation. Evacuate personnel to safe areas. Avoid breathing dust.

Personal protective equipment

Eye/face protection: Safety glasses with side-shields or goggles conforming to appropriate government standards such as ANSI (US) or EN 166(EU)

Skin protection: Handle with nitrile gloves. Gloves must be inspected prior to use. Use proper glove removal technique (without touching glove's outer surface) to avoid skin contact with this product. Dispose of contaminated gloves after use in accordance with applicable laws and good laboratory practices. Wash and dry hands.

Respiratory and body protection: Wear respiratory protection and full protective clothing tested and approved under appropriate government standards such as ANSI (US) or CEN (EU).

Environmental precautions

Prevent further leakage or spillage if safe to do so. Do not let product enter drains. Discharge into the environment must be avoided.

Methods and materials for containment and cleaning up in case of leaking or spilling

Contain spillage. Neutralize spill with soda ash or lime. Carefully place material into clean dry container and cover. Flush spill area with water. Avoid creating dust.

Disposal

Because this sensor contains lead and a corrosive solution, contact a licensed professional waste disposal service for disposal.

Specifications:

Range Of Measurement:	0 TO 100%
Output Range:	9.0 TO 16.0 mV
Zero Offset:	0.250 mV when exposed to 100% nitrogen
90% Response Time:	512 seconds
Linearity:	3% full scale error maximum
Drift:	1% volume O ₂ per month in air
Accuracy	±(2.5% FiO ₂ +2.5% of actual FiO ₂)
Expected Lifetime:	>1,000,000 %O ₂ hours
Temperature Compensation:	NTC
Operational Temperature Range:	10° TO 40°C
Storage Temperature Range:	-20° TO 50°C
Humidity Range:	0% TO 99% RH, non-condensing
Ambient Pressure Range:	700-1250mBAR
Interference:	Per EN ISO 80601-2-55
Influence Of Humidity:	-0.03%REL. O ₂ reading per %RH
Electrical Interface:	3 pin Molex
Shelf life	2 year warranty / >1,000,000 %O ₂ hours

DRAFT 01/26/2018

To replace the sensor:

Tools required:

- T20 Torx screwdriver
- Scratch awl or similar slender, pointed tool

To remove the FiO₂ sensor:

1. Using a T20 Torx screwdriver, unscrew the FiO₂ sensor cover and set aside. Note that the cover is also the FiO₂ sensor driver.

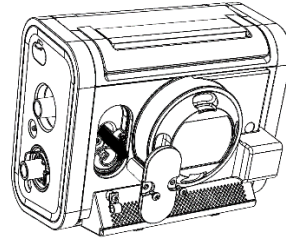

2. Use the awl to pull the tab lock away from the plug to the unlock position.
3. While holding the tab in the unlock position, pull the white connector straight out. Do not use the wires to pull the connector.
4. Place the FiO₂ driver on the sensor and twist counterclockwise to remove the sensor from the device.
5. Because this sensor contains lead and a corrosive solution, contact a licensed professional waste disposal service to dispose of this material.

To install a new FiO₂ sensor:

1. Place the sensor in the FiO₂ socket.

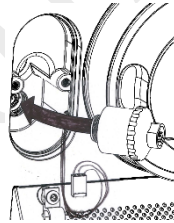

2. Place the FiO₂ driver on the sensor and twist clockwise to secure the sensor in the receptacle.



3. Push the connector onto the pins on the sensor. Ensure you have aligned the pins with the receptacles on the connector.

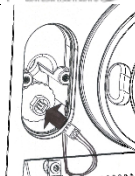

4. Replace the FiO₂ sensor cover and secure with the screws.

External Flow Sensor and Cable

Intended Use:

The Philips Respironics External Flow Sensor is intended for use with Trilogy Evo Universal-series ventilators. It measures the gas (air, oxygen or carbon dioxide) flow rate in the airway from the patient circuit to the patient's lung during inhalation and exhalation. One side of the sensor device is attached to the patient circuit while the other side is connected to the ventilator.

Two sizes of this sensor are included in the case: adult/pediatric, and pediatric/infant.

To use the sensor, follow the instructions provided with the sensor. To connect the external flow sensor to Trilogy Evo Universal, see Figure 1 and Figure 2.

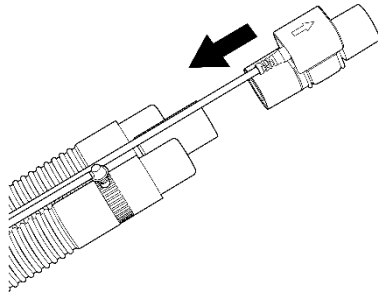

Figure 8: Attaching the sensor to a circuit

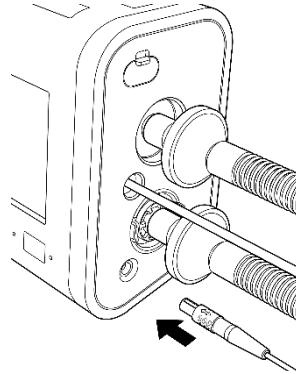

Figure 7: Attaching the sensor to Trilogy Evo

Colorimetric CO₂ detector

Two sizes of this detector are included in the package. To use the detector, see the detector's instructions.

External Pulse Oximeter and Sensors

Three disposable pulse oximeter sensors are included in the package: adult, pediatric, and infant.

Instructions for Use:

To use the oximeter sensors, follow the instructions provided with the sensors. To connect the oximeter to Trilogy Evo Universal, plug the USB connector into the USB port on the Patient Panel



Filters

Air-inlet foam filter

The air-inlet foam filter protects Trilogy Evo Universal from dirt and dust. This filter is for single patient use. For instructions on rinsing the filter, see the "Cleaning and Disinfection" chapter. For instructions on replacing the filter, see the "Service and Maintenance" chapter.

Particulate filter

The particulate filter protects Trilogy Evo Universal from fine particulates. This filter is for single patient use. For instructions on replacing the filter, see the "Service and Maintenance" chapter.

CBRN filter adapter

Use the CBRN filter adapter when using a CBRN filter in place of the disposable inlet filter. For instructions on installing the filter adapter, see the "Device Setup" chapter.

Patient Circuits

For instructions on attaching circuits to the ventilator, see the “Device Setup” chapter.

Circuit Principles

Each patient circuit has a different compliance and resistance. During Circuit Calibration, the ventilator verifies that the maximum pressure drop does not exceed the specifications below. For optimal performance, calibrate the circuit before using it with a patient. See “Circuit Calibration” in the “Device Options” chapter.

When adding any components to the breathing system, the flow resistance and dead space of the added components such as humidifiers, speaking valves, Heat Moisture Exchangers (HMEs) and filters should be carefully considered in relation to the potential for adverse effects on the patient’s ventilator management and device alarms.

If a breathing system filter is exposed to nebulization or humidification, to prevent increased resistance or blockage, the breathing system filter requires replacement more frequently.

Circuit Requirements

For safe operation, the ventilator requires a patient circuit and filter(s) that meet the following requirements.

Compliance: up to 4 ml/cmH₂O

Inspiratory/Expiratory Resistance

- Pediatric/adult circuit (20-22 mm): less than 5 cmH₂O at 30 l/min
- Pediatric/adult circuit (19 mm): less than 5 cmH₂O at 15 l/min
- Infant/pediatric circuit (14-16 mm): less than 5 cmH₂O at 15 l/min
- Infant/pediatric circuit (9-13 mm): less than 5 cmH₂O at 2.5 l/min

Leak Compensation

The passive circuit provides leak compensation for inhaled and exhaled tidal volume measurements. This includes compensation for intentional leak in the patient circuit and leaks that occur at the patient interface, such as cuff leak or mask leak.

The active flow and dual limb circuits compensate for leak that occurs between the ventilator and the external flow sensor. Leaks that are downstream of the external flow sensor are not compensated for in measurement of inhaled or exhaled tidal volume.

Leak compensation is not available in the active PAP circuit.

Circuit Accessories

HMEs

Three Heat and Moisture Exchangers (HMEs) are included in this package: adult, pediatric, and infant.

Follow the instructions provided with the sensors.

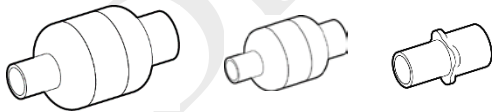

Flexible Trach Adapter

Adult Endo-trach adapter with port for suctioning. Follow the instructions provided with the adapter.

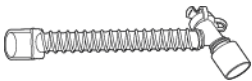

Dual Limb Active Exhalation Valve

The Philips Respironics Dual Limb Active Exhalation Valve is a dual limb circuit accessory. The valve will close during inspiration and open during exhalation to divert flow into the expiratory limb for venting outside of the breathing circuit. This device is intended for multi-patient use. Clean and disinfect or clean and sterilize this item between uses on different patients.

For help setting up, using, or maintaining this device, contact Philips Respironics.

Warnings:

- To reduce the likelihood of disconnection, and to prevent degraded or adverse ventilator performance, use this accessory only with a compatible ventilator. This device is compatible and validated for use with Philips Respironics Trilogy Evo Universal-series ventilators. Before use, ensure the compatibility of the ventilator and all of the parts, materials, and accessories you plan to use to connect to the patient.
- Do not modify this equipment.
- This product may become contaminated by bodily fluids and expired gases. Dispose according to your local regulations.

Storage and Handling: Avoid direct sunlight.

Disposal: This product may become contaminated by bodily fluids and expired gases. Dispose according to your local regulations.

Instructions for Use: Install according to the illustration. For cleaning and disinfection instructions, see the “Cleaning and Disinfection” chapter.

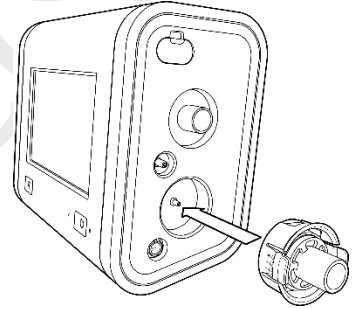

Oxygen

Adding Oxygen to the Device

Delivered oxygen concentration varies with changes in flow in the circuit. The following may have an impact on oxygen concentration:

- Pressure settings
- Patient Tidal Volume
- Peak Inspiratory Flow
- I:E Ratio
- Respiratory rate
- Circuit leak rate
- Oxygen flow rate

Low Flow Oxygen Warnings

- When administering fixed-flow supplemental oxygen, the oxygen concentration may not be constant. The inspired oxygen concentration will vary, depending on the pressures, patient flow, and circuit leak. Substantial leaks may reduce the inspired oxygen concentration to less than the expected value. Use appropriate patient monitoring, such as pulse oximeter with alarm, as medically indicated.
- This device DOES NOT alarm for loss of the low flow oxygen supply.
- Do not connect the device to an unregulated or high-pressure oxygen source.
- The device may result in incorrect flow and tidal volume measurements and improper operation of related alarms if you add low flow oxygen directly into the patient circuit or mask instead of directly adding it into the oxygen inlet on the back of the ventilator.
- Turn off oxygen when the device is not in use. When the device is not in operation and the oxygen flow remains on, oxygen delivered into the tubing may accumulate within the device’s enclosure.
- Do not operate the ventilator in the presence of flammable gasses. This could cause a fire or explosion.

To add oxygen to the circuit, the oxygen supply must comply with the local regulations for medical oxygen. The oxygen flow into the oxygen valve cannot exceed 30 l/min and the pressure cannot exceed 10 psi. For instructions, see the “Device Setup” chapter.

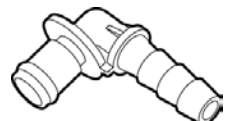

Portability and Travel Accessories

When using mounting hardware, confirm that the ventilator is secured to the wheelchair mount or roll stand mount. See the instructions that accompany the accessory.

Remote Alarms

If you are using a remote alarm or nurse call, ensure you test the accessory before starting ventilation. Ensure that you can hear the ventilator's audible alarms on the remote alarm. Ensure the remote alarm signals when the remote alarm cable is disconnected. To use the alarm, see the alarm's instructions. Use the RJ9 connection on the Utility Panel to connect to this ventilator.

DRAFT 01/26/2018

11. Power Management

Power Sources

Trilogy Evo Universal can operate on AC (wall outlet) or DC (battery) power from several sources listed in descending priority below.

1. AC Power
2. External 24- or 12-volt battery (DC) such as a vehicle battery – requires an external battery cable
3. Detachable battery (DC)
4. Internal battery (DC)

Battery Power Indicator

The battery power indicator appears in the status bar at the bottom of the window. The indicator shows the status of batteries in use.

Battery operating time depends on the characteristics of the battery and usage of the device. The capacity of the battery shown on the Battery Power Indicator is only an estimate.

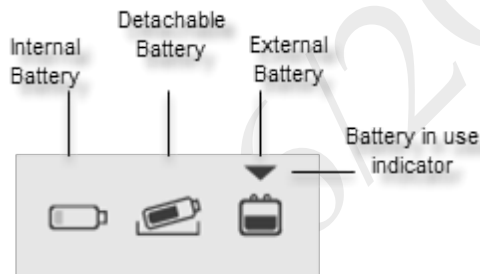

You can also view battery status in the following locations:

- The battery status Monitoring Window – see “Monitoring Window” in the “About Trilogy Evo Universal” chapter.
- The device information window: In the menu bar, tap the **Options** icon. In the **Options** window, tap **Information**.

Battery Status Indicator

To view the battery status indicator, tap the battery power indicator in the Status Bar:



Battery status

This indicator shows:

- Battery status
- Estimated battery time remaining (for internal and detachable batteries)
- Estimated remaining battery power shown as a percent of total capacity (for external battery)

AC Power

AC power has the highest priority. When AC power is present, Trilogy Evo Universal uses that power to run the device and to charge the detachable and internal batteries.

To use AC power:

1. Plug the socket end of the AC power cord into Trilogy Evo Universal’s power inlet.
2. Plug the pronged end of the power cord into an electrical outlet that is not controlled by a wall switch.
3. Secure the cord to the device using the retention clip.
4. Verify Trilogy Evo Universal is using AC power. You should see the green LED light next to the power button. If you do not see this light, contact Philips customer service.

Periodically inspect the power cord for damage or signs of wear. Discontinue use and replace if damaged.

To remove AC power, disconnect the power supply cord from the electrical outlet.

External Battery

You can use an external DC power source, such as a vehicle battery, to power Trilogy Evo. You must use the Philips Respironics External Battery Cable to connect the battery to the device. Do not use any other cable or improper operation of the device may occur. This cable is pre-wired and properly terminated to ensure safe connection of an external battery to the ventilator. See the instructions included with the battery cable. The external battery will power the device when Trilogy Evo is disconnected from AC power.

Battery operating time depends on the characteristics of the battery and usage of the device. The capacity of the external battery shown on the Battery Power Indicator is only an estimate of the actual remaining capacity.

The external battery is installed correctly when the external battery icon appears in the Battery Power Indicator on the Status Bar.

Detachable Battery

Trilogy Evo Universal detachable battery pack will power the ventilator, if attached, when Trilogy Evo Universal is disconnected from AC or external battery power. The detachable battery automatically charges when plugged into AC power.

Battery operating time depends on the characteristics of the battery and usage of the device. The capacity of the external battery shown on the Battery Power Indicator is only an estimate of the actual remaining capacity. Refer to the Technical Specifications included in this manual for more information on the detachable battery.

The battery includes an LED charge indicator. To view the percentage of charge, press the battery button. Green lights appear to indicate how much charge remains in the battery.

To remove the detachable battery: open the detachable battery access door. Lift the battery handle and pull the battery to remove it from the battery bay.

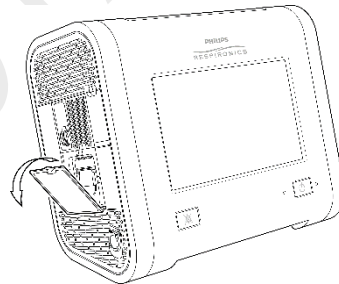

To replace the detachable battery: open the detachable battery access door. Slide the battery into the battery bay until you hear a click.

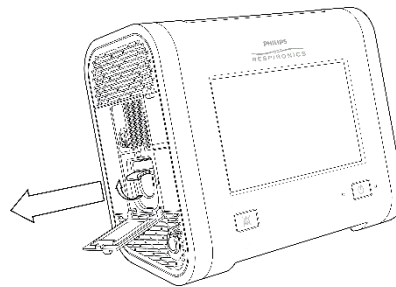

The detachable battery is installed correctly when the detachable battery icon appears in the Battery Power Indicator at the bottom of the screen.

Internal Battery

Internal battery power is the lowest priority power source.

The internal battery is functioning correctly when the internal battery icon appears in the Battery Power Indicator at the bottom of the screen in a fully charged state. For help, see the following section titled, “Battery Power Indicator.” The detachable battery automatically charges when plugged into AC power.

The expected life of the internal battery is two years. Replace the internal battery every two years or when there is a noticeable reduction in usage time when fully charged. When storing the device, ensure that internal battery is recharged once every six months.

See the Technical Specifications included in this manual for internal battery specifications.

Power Loss





Several alarms are related to power management and power loss. For information about these alarms and how to test them, see the “Alarms” chapter.





If all power sources are lost while Trilogy Evo Universal is delivering therapy, as soon as a power source is connected, the device will begin to deliver therapy again. All alarm settings are retained and restored.

Power Indicator Icons

Internal Battery	Status	Capacity remaining
	Charging	0% capacity
	Charging	Nearly depleted
	Charging	Low power remaining
	Charging	01-20% capacity
	Charging	21-40% capacity
	Charging	41-60% capacity
	Charging	61-80% capacity
	Charging	81-100% capacity
	Discharging	81-100% capacity
	Discharging	61-80% capacity
	Discharging	41-60% capacity
	Discharging	21-40% capacity
	Discharging	01-20% capacity
	Discharging	Low power remaining
	Discharging	Nearly depleted
	Depleted, not charging	0% capacity or failed

Detachable Battery	Status	Capacity remaining
	Charging	0% capacity
	Charging	Nearly depleted
	Charging	Low power remaining
	Charging	01-20% capacity
	Charging	21-40% capacity
	Charging	41-60% capacity
	Charging	61-80% capacity
	Charging	81-100% capacity
	Discharging	81-100% capacity
	Discharging	61-80% capacity
	Discharging	41-60% capacity
	Discharging	21-40% capacity
	Discharging	01-20% capacity
	Discharging	Low power remaining

	Discharging	Nearly depleted
	Depleted, not charging	0% capacity or failed
External Battery	Status	Capacity remaining
	Discharging	81-100% capacity
	Discharging	61-80% capacity
	Discharging	41-60% capacity

	Discharging	21-40% capacity
	Discharging	01-20% capacity
	Discharging	Low power remaining
	Discharging	Nearly depleted
	Discharging	0% capacity

DRAFT 01/26/2018

12. Technical Specifications

Specifications

Ventilation types and modes	
<ul style="list-style-type: none"> • A/C-PC: Assist control (pressure control) • A/C-VC: Assist control (volume control) • CPAP: Continuous positive airway pressure • PSV: Pressure support ventilation • S/T: Spontaneous/timed ventilation • SIMV-PC: Synchronized intermittent mandatory ventilation (pressure control) - mandatory breaths are synchronized to a patient’s inspiratory efforts • SIMV-VC: Synchronized intermittent mandatory ventilation (volume control) - mandatory breaths are synchronized to a patient’s inspiratory efforts 	
Controls	
Delivered tidal volume	35 – 1,200 ml
Breath rate	0 – 80 BPM with a resolution of 1 BPM
PEEP	0 – 35 cm H ₂ O for active exhaust circuits 3 – 25 cm H ₂ O for passive circuits
EPAP/CPAP	3 – 25 cm H ₂ O
IPAP	3 – 60 cm H ₂ O
Pressure support/pressure control	0 – 60 cm H ₂ O, Patient pressure limited to 60cmH ₂ O
Inspiratory time	0.3 – 5.0s, constrained to prohibit an inverse I:E ratio
Rise time	0, 1, 2, 3, 4, 5, 6
Triggering and cycling	AutoTrak, Sensitive AutoTrak, and Flow Trigger
Flow trigger sensitivity	0.5 – 9 l/min
Flow cycle	10% – 90% of peak flow
Flow pattern	Square, Ramp
FiO ₂	21% – 100% when available
Measured and Displayed Patient Parameters	
Tidal volume (V _{ti} or V _{te})	0 to 2000 ml with a resolution of 1 ml
Minute ventilation (MinVent)	0 to 30 l/min with a resolution of 0.1 l/min
Leak	0 to 200 l/min with a resolution of 0.1 l/min
Respiratory rate (RR)	0 to 90 BPM with a resolution of 1 BPM
Peak inspiratory flow	0 to 200 l/min with a resolution of 0.1 l/min
Peak inspiratory pressure (PIP)	0 to 90 cmH ₂ O with a resolution of 0.1 cmH ₂ O
Mean airway pressure	0 to 90 cmH ₂ O with a resolution of 0.1 cmH ₂ O
Percentage spontaneous triggered breaths	0 to 100% with a resolution of 1%
I:E ratio	9.9:1 to 1:9.9
Dynamic compliance	0.5 to 200 ml/cmH ₂ O with a resolution of 0.1 ml/cmH ₂ O
Dynamic resistance	2 to 200 cmH ₂ O/l/sec with a resolution of 0.1 cmH ₂ O/l/sec
Dynamic plateau pressure	0 to 90 cmH ₂ O with a resolution of 0.1 cmH ₂ O
Auto-PEEP	0 to 90 cmH ₂ O with a resolution of 0.1 cmH ₂ O
FiO ₂	21% to 100% with a resolution of 1%
SpO ₂ with pulse oximeter accessory	0 to 100% with a resolution of 1%
Pulse rate with pulse oximeter accessory	25 to 240 beats per minute with a resolution of 1 beat per minute
etCO ₂ with end tidal CO ₂ accessory	0 to 150 mmHg with a resolution of 1 mmHg

Environmental	
Operating	Temperature: 0°C to 40°C Relative humidity: 5% to 90% RH, non-condensing Atmospheric pressure: 62 to 106 kPa Altitude: -1261 to 12,971 feet Battery charging temperature: 5°C to 40°C
Transient operating temperature, excluding high pressure oxygen blending	-20°C to 50°C
Storage temperature	-25°C to 70°C 5% to 93% RH, non-condensing
Physical	
Weight	6.3 Kg (13.9 lbs)
Size	19.3 cm D x 28.6 cm W x 24.5 cm H 7.6" D x 11.25" W x 9.65" H
Screen dimensions	8", 20.32 cm
Ingress protection	IP22: protection against finger-sized objects and protected against dripping water when tilted up to 15 degrees.
IEC 60601-1 classification	Type of protection against electric shock: Class II equipment Degree of protection against electric shock – type BF applied part
Composition	This device does not contain natural latex rubber or dry natural rubber.
Expected service life	10 years
Internal memory capacity	2Gb
Mode of operation	Continuous
Maximum limited pressure	90 cmH ₂ O
Electrical	
AC input voltage	100V – 240V - 50/60 Hz 1.7A
DC input voltage	12/24V 6.5A
Internal and detachable Li-ion batteries	7.5 hours nominal total run time per method in IEC 80601-2-72 (each battery) Charge time for detachable and internal battery from 0% to 80%: 2.5 hours from 0% to 100%: 3.5 hours
Degree of protection against electric shock	Type BF Applied Part
Audio	
Alarm sound pressure level	Lowest setting: ≥ 53.9 dBA Highest setting: ≥ 85.5 dBA
Sound pressure level - ventilator, circuit and exhalation device	43.7 dBA as measured according to ISO 80601-2-12
Sound power level -ventilator, circuit and exhalation device	51.6 dBA as measured according to ISO 80601-2-12
Oxygen	
Low flow	0 to 30 l/min; maximum 10 psi
High pressure	280 to 600 kPa (41 to 87 psi)
Ventilator response to a 21 -90% increase in oxygen concentration	< 30 seconds
Control Accuracy	
Pressure	±(2 cmH ₂ O + 4% of the setting)
Tidal volume	±(4 ml + 15% of setting)
FiO ₂	±5 % FiO ₂

Monitored Parameter Accuracy	
Airway pressure	$\pm(2 \text{ cmH}_2\text{O} + 4\% \text{ of actual})$
Tidal volume	$\pm (4 \text{ ml} + 15\% \text{ of actual})$ for volumes $\geq 35 \text{ ml}$ $\pm 10 \text{ ml}$ for volumes $< 35 \text{ ml}$
FiO ₂	$\pm(2.5\% \text{ FiO}_2 + 2.5\% \text{ of actual reading})$ within a 24-hour 2-point calibration period, or a change in altitude
EtCO ₂ (with Mainstream CO ₂ sensor)	$\pm(\text{volume fraction of } 0.43\% + 8\% \text{ of gas level})$
SpO ₂ and pulse rate	See the sensor manufacturer's operating instruction sheet.
Operational range of the Patient Circuit and Circuit accessories	
Inspiratory/expiratory resistance	<ul style="list-style-type: none"> Pediatric/adult circuit (20-22 mm): less than 5 cmH₂O at 30 l/min Pediatric/adult circuit (19 mm): less than 5 cmH₂O at 15 l/min Infant/pediatric circuit (14-16 mm): less than 5 cmH₂O at 15 l/min Infant/pediatric circuit (9-13 mm): less than 5 cmH₂O at 2.5 l/min
Compliance	Up to 4 ml/cmH ₂ O
Wireless	
Bluetooth	
Operating frequency range	2402-2480 MHz
Channel bandwidth	1 MHz/2 MHz
Maximum output power	12.0 dBm
Modulation	GFSK, Pi/4 DQPSK, 8DQPSK
Near-field communication (NFC)	
Operating frequency	13.56 MHz
Receiving section bandwidth	1.4 MHz
Maximum output power	23.0 dBm
Modulation	ASK, OOK
Wi-Fi	
Operating frequency range	2402-2480 MHz
Channel bandwidth	20 MHz/40MHz
Maximum output power	17 dBm
Modulation	DSSS, OFDM, DBPSK, DQPSK, CCK, 16-QAM
Security	Wpa2

All flows and volumes are expressed in BTPS.

Measurement Uncertainty for Control and Performance Specifications

The stated tolerances account for the measurement uncertainty of the test equipment used to verify performance:

- Pressure: $\pm 0.75\% \text{ cmH}_2\text{O}$
- Tidal Volume: $\pm 2 \text{ ml}$
- Oxygen: $\pm 1\% \text{ FiO}_2$

Standards Compliance

This device conforms to the following standards:

Standards	
General	<ul style="list-style-type: none"> IEC 60601-1-1 Medical electrical equipment. Part 1-1: General requirements for safety. Collateral standard: Safety requirements for medical electrical systems
Collateral	<ul style="list-style-type: none"> IEC 60601-1-11 Home Health Care Environment according to transit-operable usage
Particular	<ul style="list-style-type: none"> Device essential performance is specified in each of the following standards: ISO 80601-2-12: Medical electrical equipment. Part 2-12: Particular requirements for basic safety and essential performance of critical care ventilators ISO 80601-2-61 Medical electrical equipment. Part 2-61: Particular requirements for basic safety and essential performance of pulse oximeter equipment ISO 80601-2-55 Medical electrical equipment. Part 2-55: Particular requirements for the basic safety and essential performance of respiratory gas monitors
Wireless communication	<ul style="list-style-type: none"> Bluetooth Core Specification version 4.1 ISO/IEC 18092:2013: Information technology. Telecommunications and information exchange between systems. Near Field Communication. Interface and Protocol (NFCIP-1) ISO IEC 21481 Ed 2.0: Information technology. Telecommunications and information exchange between systems. Near Field Communication Interface and Protocol -2 (NFCIP-2) ISO/IEC 14443 Ed 2.0: Identification cards. Contactless integrated circuit cards. Proximity cards. WLAN Standard: IEEE 802.11 (2012) b/g/n: Information technology. Telecommunications and information exchange between systems. Local and metropolitan area networks. Specific requirements. Part 11: Wireless LAN Medium Access Control (MAC) and Physical Layer (PHY) Specifications Hereby, Respiration Inc. declares that this class 1 radio equipment is in compliance with Directive 2014/53/EU. The full text of the EU declaration of conformity is available at the following internet address: http://incenter.medical.philips.com/PMSPublic

DRAFT

Pneumatic Diagram

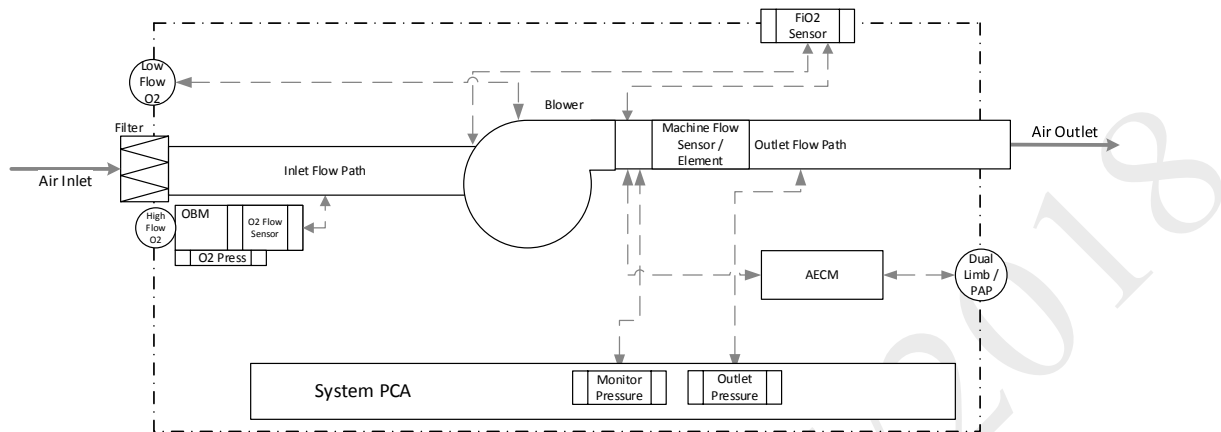

EMC Information

This ventilator generates audible and visual alarms to alert you if it is not able to provide ventilation or if external monitoring is lost during an EMC disturbance.

Warnings

Avoid using this equipment adjacent to or stacked with other equipment because it could result in improper operation. Although the other equipment may comply with EMC standard requirements, interference can occur. If such use is necessary, observe this equipment and the other equipment to verify that both are operating normally.

This device is unsuitable for use in a magnetic resonance imaging (MRI) environment.

The use of accessories, transducers and/or cables other than those specified, with the exception of those sold by the manufacturer as replacement parts for internal components, may result in increased emissions or decreased immunity of the equipment or system.

Guidance and Manufacturer's Declaration - Electromagnetic Emissions

This device is intended for use in the electromagnetic environment specified below. The user of this device should make sure it is used in such an environment.

Emissions Test	Compliance	Electromagnetic Environment - Guidance
RF emissions CISPR 11 Industrial, scientific and medical equipment. Radio-frequency disturbance characteristics. Limits and methods of measurement	Group 1	The device uses RF energy only for its internal function. Therefore, its RF emissions are very low and are not likely to cause any interference in nearby electronic equipment.
RF emissions CISPR 11	Class B	The device is suitable for use in all establishments, including domestic establishments and those directly connected to the public low-voltage power supply network.
Harmonic emissions IEC 61000-3-2 Electromagnetic compatibility (EMC). Part 3-2: Limits. Limits for harmonic current emissions (equipment input current smaller than or equal to 16 A per phase)	Class A	
Voltage fluctuations/Flicker emissions IEC 61000-3-3 Electromagnetic compatibility (EMC) - Part 3-3: Limits - Limitation of voltage changes, voltage fluctuations and flicker in public low-voltage supply systems, for equipment with rated current ≤ 16 A per phase and not subject to conditional connection	Complies	
Emission of Radio Frequency Energy RTCA/DO-160G Section 21	Category M	This device is suitable for use onboard commercial airplanes inside passenger cabin.

Guidance and Manufacturer’s Declaration - Electromagnetic Immunity

This device is intended for use in the electromagnetic environment specified below. The user of this device should make sure it is used in such an environment.

Immunity Test	IEC 60601 Test Level	Compliance Level	Electromagnetic Environment - Guidance
IEC 61000-4-2 Electromagnetic compatibility (EMC). Part 4-2: Testing and measurement techniques. Electrostatic discharge immunity test	±8 kV contact ±2 kV, ±4 kV, ±8 kV, and ±15 kV air	±8 kV contact ±2 kV, ±4 kV, ±8 kV, and ±15 kV air	Floors should be wood, concrete, or ceramic tile. If floors are covered with synthetic material, the relative humidity should be at least 30%.
IEC 61000-4-4 Electromagnetic compatibility (EMC). Part 4-4: Testing and measurement techniques. Electrical fast transient/burst immunity test	±2 kV for power supply lines ±1 kV for input-output lines	±2 kV for supply mains ±1 kV for input/output lines	Mains power quality should be that of a typical home or hospital environment.
IEC 61000-4-5 Electromagnetic compatibility (EMC) - Part 4-5 Testing and measurement techniques. Surge immunity test	±1 kV line to ground ±2 kV line to ground	±1 kV line to line N/A - this Class II device does not connect to earth ground	Mains power quality should be that of a typical home or hospital environment.
IEC 61000-4-11 Electromagnetic compatibility (EMC). Part 4-11: Testing and measurement techniques. Voltage dips, short interruptions and voltage variations immunity tests	0% U _T 0.5 cycle at 45 degree increments 0% U _T 1 cycle 70% U _T 25 cycles (30 cycles if US) 0% U _T 5 sec	0% U _T 0.5 cycle at 45 degree increments 0% U _T 1 cycle 70% U _T 25 cycles (30 cycles if US) 0% U _T 5 sec	Mains power quality should be that of a typical home or hospital environment. If the user of the device requires continued operation during power mains interruptions, it is recommended that the device be powered from an uninterruptible power supply or a battery.

Immunity Test	IEC 60601 Test Level	Compliance Level	Electromagnetic Environment - Guidance
IEC 61000-4-8 Electromagnetic compatibility (EMC). Part 4-8: Testing and measurement techniques. Power frequency (50/60 Hz) magnetic field immunity test	30 A/m	30 A/m	Power frequency magnetic fields should be at levels characteristic of a typical location in a typical hospital or home environment.
NOTE: UT is the AC mains voltage prior to application of the test level.			

Guidance and Manufacturer’s Declaration - Electromagnetic Immunity

This device is intended for use in the electromagnetic environment specified below. The user of this device should make sure it is used in such an environment.

Immunity Test	IEC 60601 Test Level	Compliance Level	Electromagnetic Environment - Guidance
Conducted RF IEC 61000-4-6 Electromagnetic compatibility (EMC). Part 4-6: Testing and measurement techniques. Immunity to conducted disturbances, induced by radio-frequency fields.	3 Vrms 150 kHz to 80 MHz	3 Vrms 150 kHz to 80 MHz	Portable and mobile RF communications equipment should be used no closer to any part of the device, including cables, than the recommended 30 cm separation distance.
	6 Vrms Amateur Radio & ISM Bands between 150 kHz and 80 MHz	6 Vrms Amateur Radio & ISM Bands between 150 kHz and 80 MHz	
Radiated RF IEC 61000-4-3 Electromagnetic compatibility (EMC) - Part 4-3: Testing and measurement techniques - Radiated, radio-frequency, electromagnetic field immunity test	10 V/m 80 MHz to 2.7 GHz	10 V/m	
	Up to 28V/m in telecommunication bands as specified in clause 8.10 of IEC 60601-1-2	Up to 28V/m in telecommunication bands as specified in clause 8.10 of IEC 60601-1-2	

13. Wireless Connectivity

This device has Bluetooth SmartReady wireless technology, which includes Bluetooth Classic and Low Energy Bluetooth. Bluetooth allows Trilogy Evo to communicate with a compatible Bluetooth device approved by Philips. Bluetooth functionality may not be present in all models.

Warning: Other equipment may interfere with this device, even if the other equipment complies with CISPR8 emission requirements.

The Health Industry Manufacturers Association recommends that a minimum separation of six inches be maintained between a wireless phone and a pacemaker to avoid potential interference with the pacemaker. The Trilogy Evo on-board Bluetooth communication should be considered a wireless phone in this regard.

Caution: When traveling by air, inform the airline of the presence of wireless technology in this device. Ensure such devices are permitted.

Notices: The Bluetooth® word mark and logos are registered trademarks owned by Bluetooth SIG, Inc. and any use of such marks by Philips Respironics is under license. Other trademarks and trade names are those of their respective owners.

The Trilogy Evo device transmits data between the therapy device and a mobile device, but it does not store any of your personal data. This connection between the therapy device and a mobile device is encrypted.

This device contains a certified Bluetooth/Wi-Fi radio – FCC ID: 2AN9Z-1127941BT, IC ID: 3234B-1127941BT. Nearfield communication (NFC) is certified under FCC ID: 2AN9Z-1127941, IC ID: 3234B-1127941.

Use of non-original manufacturer-approved accessories may violate your local RF exposure guidelines and should be avoided.

This device complies with part 15 of the FCC Rules. Operation is subject to the following two conditions: (1) This device may not cause harmful interference, and (2) this device must accept any interference received, including interference that may cause undesired operation. This equipment has been tested and found to comply with the limits for a Class B digital device, pursuant to Part 15 of the FCC Rules. These limits are designed to provide reasonable protection against harmful interference in a residential installation. This equipment generates, uses, and can radiate radio frequency energy and, if not installed and used in accordance with the instructions, may cause harmful interference to radio communications. However, there is no guarantee that interference will not occur in a particular installation. If this equipment does cause harmful interference to radio, TV reception, or other devices which can be determined by turning the equipment on and off, the user is encouraged to try to correct the interference by one or more of the following measures:

- Reorient or relocate the receiving antenna (on the radio, TV, or other device).
- Increase the separation between the equipment and receiver.
- Connect the equipment into an outlet on a circuit different from that to which the receiver is connected.
- Consult the dealer of the device for help.

Bluetooth Actions

To access the Bluetooth window:

1. In the menu bar, tap the **Options** icon. 
2. In the **Options** window, tap **Device Settings**.
3. In the **Device Settings** window, tap **Bluetooth**.

To enable Bluetooth connections, in the **Bluetooth** window, tap **On**.

To view connection status, in the Bluetooth window view the connection status indicator, including the MAC address of the current or most recently connected device.

NFC Actions

To access the NFC window:

1. In the menu bar, tap the **Options** icon. 
2. In the **Options** window, tap **Device Settings**.
3. In the **Device Settings** window, tap **Bluetooth**.

To enable NFC connections, in the **Near-Field Communication** window, tap **On**.
To disable NFC connections, in the **Near-Field Communication** window, tap **Off**.

Troubleshooting

If the device's display is erratic:

Relocate the device to an area away from electronic equipment (such as cellular phones, cordless phones, computers, TVs, electronic games, or hair dryers)

DRAFT 01/26/2018

14. Glossary

The following terms and acronyms appear throughout this manual.

Term	Definition
Active Circuit	Circuit that includes an active exhalation device
Airway Pressure	Pressure measured at the patient connection port.
Apnea	Temporary cessation of breathing.
Blower Hours	The total number of hours that the blower has been on over the life of the device. This value helps determine when the ventilator needs to be serviced. You cannot reset this value. It can only be reset by a service center.
BPM	Breaths per minute or beats per minute
BTPS	Body Temperature and Pressure Saturated; A standardization for lung volumes and flows to barometric pressure at sea level, body temperature, and saturated with water vapor reflecting the condition of air in the lung.
CPAP	Continuous Positive Airway Pressure
EPAP	Expiratory positive airway pressure
ESD	Electrostatic Discharge
etCO ₂	End tidal carbon dioxide. The amount of carbon dioxide at the end of exhalation.
FiO ₂	Fractionally Inspired Oxygen (the percentage of oxygen in the air inhaled)
I:E Ratio	The ratio of inspiratory time to expiratory time.
Infant	Full term newborn up to one month in age with mass that is greater than or equal to 2.5 kg.
IPAP	Inspiratory Positive Airway Pressure
l/min	Liters Per Minute
Mandatory Breath	Mandatory Breath is completely controlled by the ventilator.
Minute Ventilation (MinVent)	The volume of gas that moves in and out of the lungs in one minute. It is calculated by multiplying the tidal volume by the respiratory rate.
Patient Circuit	Consists of the tubing, filtration, exhaust valves (passive or active), and flow sensor external to the ventilator.
Peak Flow	Maximum flow rate (in liters per minute) reached during a breath.
Peak Inspiratory Pressure (PIP)	Highest pressure reached during inspiration.
PEEP	Positive End Expiratory Pressure is the pressure control setting in expiration.
Prescription	A given set of therapy mode control settings, alarm settings, and patient circuit type.
Pressure Control	Ventilation in which breaths are controlled by operator-defined pressure, inspiratory time, and rise time.
PS	Pressure Support
Ramp	The ramp feature reduces pressure and then gradually increases the pressure to the prescription setting.
Rise Time	The time it takes the ventilator to change from expiration to inspiration.
RR	Respiratory Rate (the number of breaths per minute).
Sigh	Delivers a periodic, larger volume breath. Settings adjust the frequency and volume.
SIMV	Synchronous intermittent mandatory ventilation
SpO ₂	Saturation of peripheral oxygen
Spontaneous Breath	Breath type in which the breath is patient-triggered.
Spontaneous/Timed (S/T) Mode	Therapy mode that is similar to S mode, except that it can also deliver a mandatory breath if the patient does not spontaneously breathe within a set time.
Square	With a square wave pattern, airflow is generally constant throughout inspiration of the breath.
Tidal Volume	The amount of air passing in and out of the lungs for each breath.

Term	Definition
VBS	Ventilator breathing system; inspiratory or expiratory pathways through which gas flows at respiratory pressures and bounded by the port through which fresh gas enters, the patient connection port and the exhaust port.
Volume Control	Ventilation in which breaths are controlled by an operator-defined volume, flow pattern, breath rate, and inspiratory time.
Vte	Exhaled Tidal Volume
Vti	Inhaled Tidal Volume

DRAFT 01/26/2018

15. Warranty

WARRANTY

Respironics, Inc. (Philips Respironics) warrants that defects in the Product due to faulty materials and workmanship will be repaired or replaced at Respironics' expense if convincing proof of purchase within the Warranty Period (as defined herein) is provided. Philips Respironics warrants that the Product will be free from defects in material and workmanship under normal and proper use in accordance with applicable instructions for a period of ninety (90) days ("Warranty Period") from the date of shipment by Philips Respironics to the original purchaser. Accessories and replacement parts are not covered under this warranty. However, Philips Respironics warrants that the internal battery in the Product will be free from defects in material and workmanship, under normal and proper use and when correctly maintained, for a period of 90 days from the date of shipment by Philips Respironics to the original purchaser.

Contact our Consumer Care Center at 1-800-682-7664 (North America), outside North America contact your local Respironics, Inc. Consumer Care Center. Internet information: www.philips.com\healthcare (North America)

or www.philips.com (outside North America).

LIMITATIONS

If any Product purchased from Philips Respironics fails to conform to the warranties set forth herein during the Warranty Period as determined by Philips Respironics, in its sole discretion, Philips Respironics may discharge its warranty obligation by choosing to repair or replace the Product. This may be accomplished by installing new or remanufactured assemblies or components, or by other repairs deemed appropriate in the sole discretion of Philips Respironics. The choice of repair or replacement by Philips Respironics will be the sole and exclusive remedy of the original purchaser. Philips Respironics reserves the right, in its sole discretion, to refund the purchase price in lieu of repair or replacement of the Product. In no event will Philips Respironics' maximum liability under these warranties exceed the price paid to Philips Respironics by the original purchaser for the Product.

CONDITIONS

This warranty does not cover damage or injury whether to the Product or to personal property or persons caused by accident, misuse, abuse, negligence, failure to install in accordance with Philips Respironics' installation instructions, failure to operate under conditions of normal use and in accordance with the terms of the operating manual and instructions, failure to maintain in accordance with the applicable service manuals, or alteration or any defects not related to materials or workmanship of the Product. This warranty does not cover damage which may occur in shipment and does not apply to the device if dropped, misused, altered or otherwise damaged after shipment. This warranty does not apply to any Product or individual part of a Product that may have been repaired or altered by anyone other than Philips Respironics or an authorized Philips Respironics service center. This warranty does not apply to any Product which is not purchased new.

DISCLAIMERS

EXCEPT AS SET FORTH IN THIS LIMITED WARRANTY, PHILIPS RESPIRONICS MAKES NO WARRANTIES, EXPRESSED OR IMPLIED, STATUTORY OR OTHERWISE, REGARDING THE PRODUCT, ITS QUALITY OR PERFORMANCE. PHILIPS RESPIRONICS SPECIFICALLY DISCLAIMS THE IMPLIED WARRANTY OF MERCHANTABILITY AND THE IMPLIED WARRANTY OF FITNESS FOR A PARTICULAR PURPOSE. IN NO EVENT WILL PHILIPS RESPIRONICS BE LIABLE FOR THE COST OF PROCUREMENT OF SUBSTITUTE PRODUCTS OR FOR ANY INDIRECT, SPECIAL, CONSEQUENTIAL, PUNITIVE, EXEMPLARY OR INCIDENTAL DAMAGES (INCLUDING, BUT NOT LIMITED TO, COMMERCIAL LOSS OR LOST REVENUES), FOR ANY CAUSE OF ACTION, WHETHER IN CONTRACT OR TORT, AND WHETHER OR NOT PHILIPS RESPIRONICS WAS AWARE OR SHOULD HAVE BEEN AWARE OF THE POSSIBILITY OF THESE DAMAGES. EXCEPT FOR THE OBLIGATIONS UNDER THIS LIMITED WARRANTY, PHILIPS RESPIRONICS WILL NOT HAVE ANY OBLIGATION OR LIABILITY FOR ANY OTHER LOSS, DAMAGE OR INJURY RESULTING DIRECTLY OR INDIRECTLY FROM THE PRODUCT. PURCHASER'S SOLE AND EXCLUSIVE REMEDY FOR BREACH OF THE WARRANTIES SET FORTH IN THIS DOCUMENT WILL BE AS PROVIDED IN THE PARAGRAPH DESCRIBING LIMITATIONS.

Purchaser is cautioned that no person or entity is authorized to make any warranties on behalf of Philips Respironics and any such alleged warranties are hereby disclaimed by Philips Respironics.