



TEST REPORT

Report No. : **CHEW21110135** Report Verification: 

Project No..... : **SHT2105014205EW**

FCC ID..... : **2AN9S-ABX00053**

Applicant's name..... : **Arduino S.r.l.**

Address..... : Via Andrea Appiani, 25
20900 MONZA (Italy)

Test item description : **Nano RP2040 Connect**

Trade Mark : Arduino

Model/Type reference..... : ABX00053

Listed Model(s) : ABX00052

Standard : **FCC CFR Title 47 Part 15 Subpart C Section 15.247**

Date of receipt of test sample..... : May 19, 2021

Date of testing..... : May 19, 2021- Nov.15, 2021

Date of issue..... : Nov.16, 2021

Result..... : **PASS**

Compiled by
 (Position+Printed name+Signature): File administrator Echo Wei

Supervised by
 (Position+Printed name+Signature): Project Engineer Aaron Fang

Approved by
 (Position+Printed name+Signature): RF Manager Hans Hu

Echo Wei

Aaron.Fang

Hans Hu

Testing Laboratory Name : **Shenzhen Huatongwei International Inspection Co., Ltd.**

Address..... : 1/F, Bldg 3, Hongfa Hi-tech Industrial Park, Genyu Road,
Tianliao, Gongming, Shenzhen, China

Shenzhen Huatongwei International Inspection Co., Ltd. All rights reserved.

This publication may be reproduced in whole or in part for non-commercial purposes as long as the Shenzhen Huatongwei International Inspection Co., Ltd. is acknowledged as copyright owner and source of the material. Shenzhen Huatongwei International Inspection Co., Ltd. takes no responsibility for and will not assume liability for damages resulting from the reader's interpretation of the reproduced material due to its placement and context.

The test report merely correspond to the test sample.

Contents

| | | |
|-----------|--|-----------|
| 1. | TEST STANDARDS AND REPORT VERSION | 3 |
| 1.1. | Test Standards | 3 |
| 1.2. | Report version | 3 |
| 2. | TEST DESCRIPTION | 4 |
| 3. | SUMMARY | 5 |
| 3.1. | Client Information | 5 |
| 3.2. | Product Description | 5 |
| 3.3. | Radio Specification Description | 5 |
| 3.4. | Testing Laboratory Information | 5 |
| 4. | TEST CONFIGURATION | 6 |
| 4.1. | Test frequency list | 6 |
| 4.2. | Descriptions of Test mode | 6 |
| 4.3. | Test mode | 6 |
| 4.4. | Support unit used in test configuration and system | 7 |
| 4.5. | Testing environmental condition | 7 |
| 4.6. | Measurement uncertainty | 7 |
| 4.7. | Equipment Used during the Test | 8 |
| 5. | TEST CONDITIONS AND RESULTS | 10 |
| 5.1. | Antenna Requirement | 10 |
| 5.2. | AC Conducted Emission | 11 |
| 5.3. | Peak Output Power | 14 |
| 5.4. | 20 dB Bandwidth | 15 |
| 5.5. | 99% Occupied Bandwidth | 16 |
| 5.6. | Carrier Frequencies Separation | 17 |
| 5.7. | Hopping Channel Number | 18 |
| 5.8. | Dwell Time | 19 |
| 5.9. | Duty Cycle Correction Factor (DCCF) | 20 |
| 5.10. | Pseudorandom Frequency Hopping Sequence | 21 |
| 5.11. | Conducted Band edge and Spurious Emission | 22 |
| 5.12. | Radiated Band edge Emission | 23 |
| 5.13. | Radiated Spurious Emission | 25 |
| 6. | TEST SETUP PHOTOS | 29 |
| 7. | EXTERANAL AND INTERNAL PHOTOS | 30 |
| 8. | APPENDIX REPORT | 30 |

1. TEST STANDARDS AND REPORT VERSION

1.1. Test Standards

The tests were performed according to following standards:

- [FCC Rules Part 15.247](#): Frequency Hopping, Direct Spread Spectrum and Hybrid Systems that are in operation within the bands of 902-928 MHz, 2400-2483.5 MHz, and 5725-5850 MHz
- [ANSI C63.10:2013](#): American National Standard for Testing Unlicensed Wireless Devices
- [KDB 558074 D01 15.247 Meas Guidance v05r02](#): Guidance for Compliance Measurements on Digital Transmission System, Frequency Hopping Spread Spectrum System, and Hybrid System Devices Operating under Section 15.247 of The FCC Rules

1.2. Report version

| Revision No. | Date of issue | Description |
|--------------|---------------|-------------|
| N/A | 2021-11-16 | Original |
| | | |
| | | |
| | | |
| | | |

2. TEST DESCRIPTION

| Report clause | Test Items | Standard Requirement | Result |
|---------------|---|-------------------------|--------------------|
| 5.1 | Antenna Requirement | 15.203/15.247 (c) | PASS |
| 5.2 | AC Conducted Emission | 15.207 | PASS |
| 5.3 | Peak Output Power | 15.247 (b)(1) | PASS |
| 5.4 | 20 dB Bandwidth | 15.247 (a)(1) | PASS |
| 5.5 | 99% Occupied Bandwidth | - | PASS ^{*1} |
| 5.6 | Carrier Frequency Separation | 15.247 (a)(1) | PASS |
| 5.7 | Hopping Channel Number | 15.247 (a)(1) | PASS |
| 5.8 | Dwell Time | 15.247 (a)(1) | PASS |
| 5.9 | Duty Cycle Correction Factor | - | PASS ^{*1} |
| 5.10 | Pseudorandom Frequency Hopping Sequence | 15.247(b)(4) | PASS |
| 5.11 | Conducted Band Edge and Spurious Emission | 15.247(d)/15.205 | PASS |
| 5.12 | Radiated Band Edge Emission | 15.205/15.209 | PASS |
| 5.13 | Radiated Spurious Emission | 15.247(d)/15.205/15.209 | PASS |

Note:

- The measurement uncertainty is not included in the test result.
- ^{*1}: No requirement on standard, only report these test data.

3. SUMMARY

3.1. Client Information

| | |
|---------------|---|
| Applicant: | Arduino S.r.l. |
| Address: | Via Andrea Appiani, 25 20900 MONZA (Italy) |
| Manufacturer: | Arduino S.r.l. |
| Address: | Via Andrea Appiani, 25 20900 MONZA (Italy) |

3.2. Product Description

| | |
|-------------------|---------------------|
| Name of EUT: | Nano RP2040 Connect |
| Trade Mark: | Arduino |
| Model No.: | ABX00053 |
| Listed Model(s): | ABX00052 |
| Power supply: | DC 5V |
| Hardware version: | 3.4 |
| Software version: | 2.0.1 |

3.3. Radio Specification Description

| | |
|----------------------------------|----------------------------|
| Bluetooth version: | V5.0 |
| Support function ^{*2} : | EDR |
| Modulation: | GFSK, $\pi/4$ DQPSK, 8DPSK |
| Operation frequency: | 2402MHz~2480MHz |
| Channel number: | 79 |
| Channel separation: | 1MHz |
| Antenna type: | internal PIFA antenna |
| Antenna gain: | -3.20 dBi |

Note:

*2: only show the RF function associated with this report.

3.4. Testing Laboratory Information

| | | |
|----------------------|---|----------------------|
| Laboratory Name | Shenzhen Huatongwei International Inspection Co., Ltd. | |
| Laboratory Location | 1/F, Bldg 3, Hongfa Hi-tech Industrial Park, Genyu Road, Tianliao, Gongming, Shenzhen, China | |
| Connect information: | Phone: 86-755-26715499 E-mail: cs@szhtw.com.cn http://www.szhtw.com.cn | |
| Qualifications | Type | Accreditation Number |
| | FCC | 762235 |

4. TEST CONFIGURATION

4.1. Test frequency list

According to section 15.31(m), regards to the operating frequency range over 10 MHz, must select three channels which were tested. The Lowest frequency, the middle frequency, and the highest frequency of channel were selected to perform the test, please see the below blue front.

| Channel | Frequency (MHz) |
|---------|-----------------|
| 00 | 2402 |
| 01 | 2403 |
| ⋮ | ⋮ |
| 39 | 2441 |
| ⋮ | ⋮ |
| 77 | 2479 |
| 78 | 2480 |

4.2. Descriptions of Test mode

Preliminary tests were performed in different data rates and recorded the RF output power in the clause 5.3

Note:

- 1) The manufacturer declare that the maximum power value of the product is set as a default value in the enter test mode software.
- 2) All the test data for each data rate were verified, found 8DPSK Modulation which is worse case mode

4.3. Test mode

| For RF test items: | | | |
|---|------------------------|------------------------|----------------|
| The engineering test program was provided and enabled to make EUT continuous transmitting. | | | |
| Test Item | Modulation / Data Rate | | |
| | GFSK 1Mbps | $\pi/4$ DQPSK 2Mbps | 8DPSK 3Mbps |
| Conducted test item | ✓ | ✓ | ✓ |
| Radiated test item | - | - | ✓ |
| Remark: | | | |
| <ul style="list-style-type: none"> - For radiated test item, the worst mode data rate 3Mbps was reported only, because this data rate has the highest RF output power at preliminary tests. - The EUT in each of three orthogonal axis emissions had been tested, but only the worst case (X axis) data recorded in the report. | | | |

4.4. Support unit used in test configuration and system

The EUT has been associated with peripherals and configuration operated in a manner tended to maximize its emission characteristics in a typical application.

The following peripheral devices and interface cables were connected during the measurement:

| Whether support unit is used? | | | |
|-------------------------------|-----------|------------|-------------|
| ✓ Yes | | | |
| Item | Equipment | Trade Name | Model No. |
| 1 | Laptop | DELL | Vostro 5590 |
| 2 | | | |

4.5. Testing environmental condition

| Type | Requirement | Actual |
|--------------------|--------------|----------|
| Temperature: | 15~35°C | 25°C |
| Relative Humidity: | 25~75% | 50% |
| Air Pressure: | 860~1060mbar | 1000mbar |

4.6. Measurement uncertainty

| Test Item | Measurement Uncertainty |
|--------------------------------------|-----------------------------------|
| AC Conducted Emission (150kHz~30MHz) | 3.00 dB |
| Radiated Emission (30MHz~1000MHz) | 4.36 dB |
| Radiated Emissions (1GHz~25GHz) | 5.10 dB |
| Peak Output Power | 0.77dB |
| Power Spectral Density | 0.77dB |
| Conducted Spurious Emission | 0.77dB |
| 6dB Bandwidth | 70Hz for <1GHz 130Hz for >1GHz |

This uncertainty represents an expanded uncertainty expressed at approximately the 95% confidence level using a coverage factor of k=1.96.

4.7. Equipment Used during the Test

| ● Conducted Emission | | | | | | | |
|----------------------|---------------------|--------------------|---------------|-----------------|---------------|---------------------------|---------------------------|
| Used | Test Equipment | Manufacturer | Equipment No. | Model No. | Serial No. | Last Cal. Date (YY-MM-DD) | Next Cal. Date (YY-MM-DD) |
| ● | Shielded Room | Albatross projects | HTWE0114 | N/A | N/A | 2018/09/28 | 2023/09/27 |
| ● | EMI Test Receiver | R&S | HTWE0111 | ESCI | 101247 | 2021/9/14 | 2022/9/13 |
| ● | Artificial Mains | SCHWARZBECK | HTWE0113 | NNLK 8121 | 573 | 2021/9/17 | 2022/9/16 |
| ● | Pulse Limiter | R&S | HTWE0033 | ESH3-Z2 | 100499 | 2021/9/13 | 2022/9/12 |
| ● | RF Connection Cable | HUBER+SUHNER | HTWE0113-02 | ENVIROFLE X_142 | EF-NM-BNCM-2M | 2021/9/17 | 2022/9/16 |
| ● | Test Software | R&S | N/A | ES-K1 | N/A | N/A | N/A |

| ● Radiated emission-6th test site | | | | | | | |
|-----------------------------------|-------------------------|--------------------|---------------|-------------|------------|---------------------------|---------------------------|
| Used | Test Equipment | Manufacturer | Equipment No. | Model No. | Serial No. | Last Cal. Date (YY-MM-DD) | Next Cal. Date (YY-MM-DD) |
| ● | Semi-Anechoic Chamber | Albatross projects | HTWE0127 | SAC-3m-02 | C11121 | 2018/09/30 | 2022/09/29 |
| ● | EMI Test Receiver | R&S | HTWE0099 | ESCI | 100900 | 2021/9/14 | 2022/9/13 |
| ● | Loop Antenna | R&S | HTWE0170 | HFH2-Z2 | 100020 | 2021/04/06 | 2022/04/05 |
| ● | Ultra-Broadband Antenna | SCHWARZBECK | HTWE0123 | VULB9163 | 538 | 2021/04/06 | 2022/04/05 |
| ● | Pre-Amplifier | SCHWARZBECK | HTWE0295 | BBV 9742 | N/A | 2020/11/13 | 2021/11/12 |
| ● | RF Connection Cable | HUBER+SUHNER | HTWE0062-01 | N/A | N/A | 2021/02/26 | 2022/02/25 |
| ● | RF Connection Cable | HUBER+SUHNER | HTWE0062-02 | SUCOFLEX104 | 501184/4 | 2021/02/26 | 2022/02/25 |
| ● | Test Software | R&S | N/A | ES-K1 | N/A | N/A | N/A |

| ● Radiated emission-7th test site | | | | | | | |
|-----------------------------------|-------------------------|--------------------|---------------|-------------------|-------------|---------------------------|---------------------------|
| Used | Test Equipment | Manufacturer | Equipment No. | Model No. | Serial No. | Last Cal. Date (YY-MM-DD) | Next Cal. Date (YY-MM-DD) |
| ● | Semi-Anechoic Chamber | Albatross projects | HTWE0122 | SAC-3m-01 | N/A | 2018/09/27 | 2022/09/26 |
| ● | Spectrum Analyzer | R&S | HTWE0098 | FSP40 | 100597 | 2021/9/13 | 2022/9/12 |
| ● | Horn Antenna | SCHWARZBECK | HTWE0126 | 9120D | 1011 | 2020/04/01 | 2023/03/31 |
| ● | Broadband Horn Antenna | SCHWARZBECK | HTWE0103 | BBHA9170 | BBHA9170472 | 2020/4/27 | 2023/4/27 |
| ● | Pre-amplifier | CD | HTWE0071 | PAP-0102 | 12004 | 2020/11/13 | 2021/11/12 |
| ● | Broadband Pre-amplifier | SCHWARZBECK | HTWE0201 | BBV 9718 | 9718-248 | 2021/03/05 | 2022/03/04 |
| ● | RF Connection Cable | HUBER+SUHNER | HTWE0120-01 | 6m 18GHz S Serisa | N/A | 2021/02/26 | 2022/02/25 |
| ● | RF Connection Cable | HUBER+SUHNER | HTWE0120-02 | 6m 3GHz RG Serisa | N/A | 2021/02/26 | 2022/02/25 |
| ● | RF Connection Cable | HUBER+SUHNER | HTWE0119-05 | 6m 3GHz RG Serisa | N/A | 2021/02/26 | 2022/02/25 |
| ● | RF Connection Cable | HUBER+SUHNER | HTWE0120-04 | 6m 3GHz RG Serisa | N/A | 2021/02/26 | 2022/02/25 |
| ● | RF Connection Cable | HUBER+SUHNER | HTWE0121-01 | 6m 18GHz S Serisa | N/A | 2021/02/26 | 2022/02/25 |
| ● | Test Software | Audix | N/A | E3 | N/A | N/A | N/A |

| ● RF Conducted Method | | | | | | |
|-----------------------|------------------------------|--------------|-----------|------------|---------------------------|---------------------------|
| Used | Test Equipment | Manufacturer | Model No. | Serial No. | Last Cal. Date (YY-MM-DD) | Next Cal. Date (YY-MM-DD) |
| ● | Signal and spectrum Analyzer | R&S | FSV40 | 100048 | 2021/9/13 | 2022/9/12 |
| ● | Spectrum Analyzer | Agilent | N9020A | MY50510187 | 2021/9/13 | 2022/9/12 |
| ● | Power Meter | Anritsu | ML249A | N/A | 2021/9/13 | 2022/9/12 |
| ○ | Radio communication tester | R&S | CMW500 | 137688-Lv | 2021/9/13 | 2022/9/12 |

5. TEST CONDITIONS AND RESULTS

5.1. Antenna Requirement

Requirement

FCC CFR Title 47 Part 15 Subpart C Section 15.203:

An intentional radiator shall be designed to ensure that no antenna other than that furnished by the responsible party shall be used with the device. The use of a permanently attached antenna or of an antenna that uses a unique coupling to the intentional radiator, the manufacturer may design the unit so that a broken antenna can be replaced by the user, but the use of a standard antenna jack or electrical connector is prohibited.

FCC CFR Title 47 Part 15 Subpart C Section 15.247(c) (1)(i):

(i) Systems operating in the 2400-2483.5 MHz band that is used exclusively for fixed. Point-to-point operations may employ transmitting antennas with directional gain greater than 6 dBi provided the maximum conducted output power of the intentional radiator is reduced by 1 dB for every 3 dB that the directional gain of the antenna exceeds 6 dBi.

TEST RESULT

Passed **Not Applicable**

The antenna type is an internal PIFA antenna, the directional gain of the antenna less than 6 dBi, please refer to the below antenna photo.

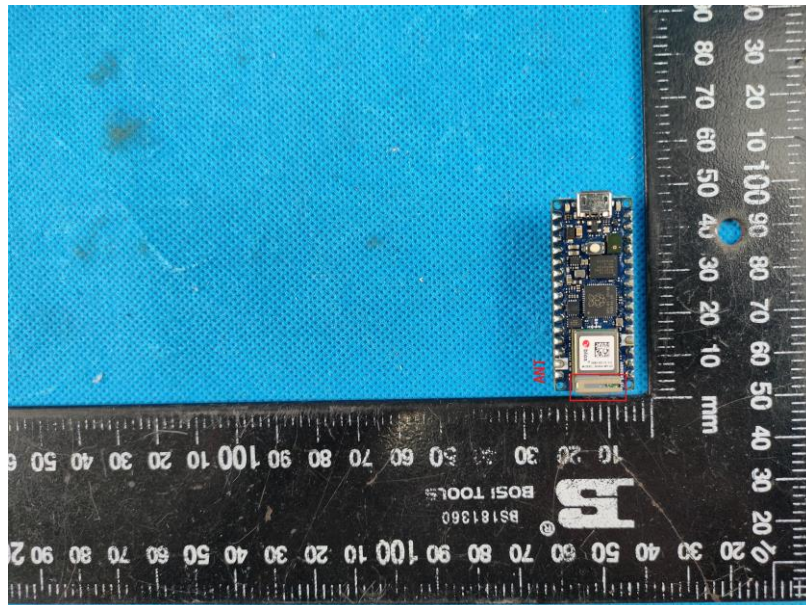

5.2. AC Conducted Emission

LIMIT

FCC CFR Title 47 Part 15 Subpart C Section 15.207

| Frequency range (MHz) | Limit (dBuV) | |
|-----------------------|--------------|-----------|
| | Quasi-peak | Average |
| 0.15-0.5 | 66 to 56* | 56 to 46* |
| 0.5-5 | 56 | 46 |
| 5-30 | 60 | 50 |

* Decreases with the logarithm of the frequency.

TEST CONFIGURATION

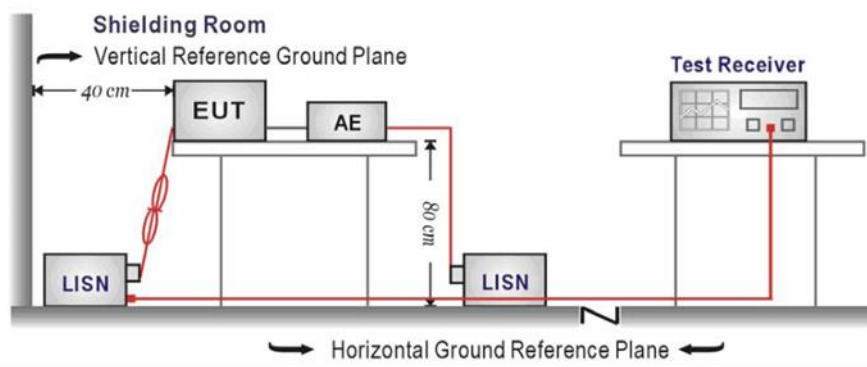

TEST PROCEDURE

1. The EUT was setup according to ANSI C63.10 requirements.
2. The EUT was placed on a platform of nominal size, 1 m by 1.5 m, raised 80 cm above the conducting ground plane. The vertical conducting plane was located 40 cm to the rear of the EUT. All other surfaces of EUT were at least 80 cm from any other grounded conducting surface.
3. The EUT and simulators are connected to the main power through a line impedances stabilization network (LISN). The LISN provides a 50 ohm /50uH coupling impedance for the measuring equipment.
4. The peripheral devices are also connected to the main power through a LISN. (Please refer to the block diagram of the test setup and photographs)
5. Each current-carrying conductor of the EUT power cord, except the ground (safety) conductor, was individually connected through a LISN to the input power source.
6. The excess length of the power cord between the EUT and the LISN receptacle were folded back and forth at the center of the lead to form a bundle not exceeding 40 cm in length.
7. Conducted emissions were investigated over the frequency range from 0.15MHz to 30MHz using a receiver bandwidth of 9 kHz.
8. During the above scans, the emissions were maximized by cable manipulation.

TEST MODE:

Please refer to the clause 4.3

TEST RESULT

Passed Not Applicable

Test Line:

L

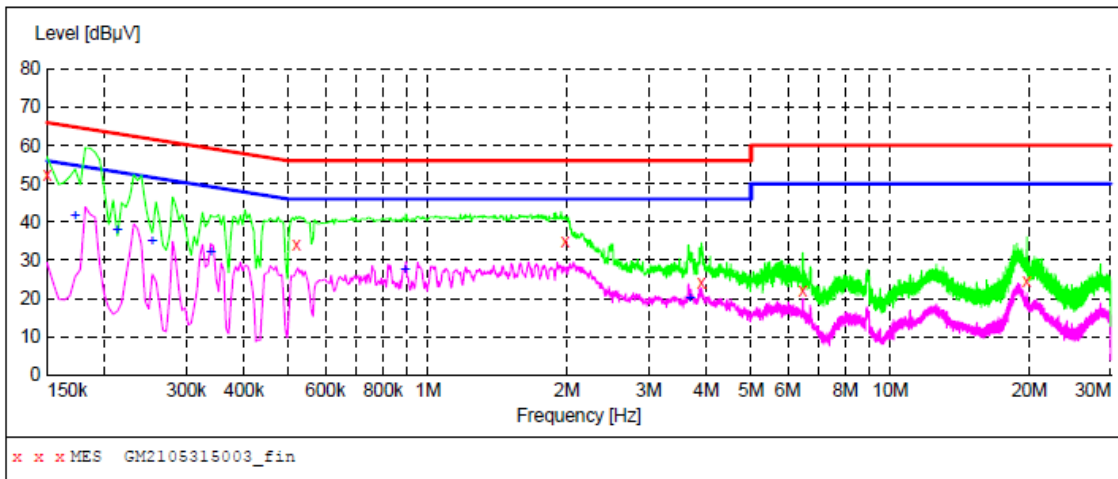

MEASUREMENT RESULT: "GM2105315003_fin"

5/31/2021 9:41AM

| Frequency MHz | Level dBµV | Transd dB | Limit dBµV | Margin dB | Detector | Line | PE |
|------------------|---------------|--------------|---------------|--------------|----------|------|-----|
| 0.150000 | 52.50 | 10.2 | 66 | 13.5 | QP | L1 | GND |
| 0.519000 | 34.20 | 10.2 | 56 | 21.8 | QP | L1 | GND |
| 1.981500 | 35.00 | 10.2 | 56 | 21.0 | QP | L1 | GND |
| 3.907500 | 24.00 | 10.2 | 56 | 32.0 | QP | L1 | GND |
| 6.468000 | 21.90 | 10.2 | 60 | 38.1 | QP | L1 | GND |
| 19.743000 | 24.60 | 10.5 | 60 | 35.4 | QP | L1 | GND |

MEASUREMENT RESULT: "GM2105315003_fin2"

5/31/2021 9:41AM

| Frequency MHz | Level dBµV | Transd dB | Limit dBµV | Margin dB | Detector | Line | PE |
|------------------|---------------|--------------|---------------|--------------|----------|------|-----|
| 0.172500 | 41.50 | 10.2 | 55 | 13.3 | AV | L1 | GND |
| 0.213000 | 37.90 | 10.2 | 53 | 15.2 | AV | L1 | GND |
| 0.253500 | 35.00 | 10.2 | 52 | 16.6 | AV | L1 | GND |
| 0.339000 | 32.10 | 10.2 | 49 | 17.1 | AV | L1 | GND |
| 0.892500 | 27.60 | 10.2 | 46 | 18.4 | AV | L1 | GND |
| 3.687000 | 20.00 | 10.2 | 46 | 26.0 | AV | L1 | GND |

Test Line:

N

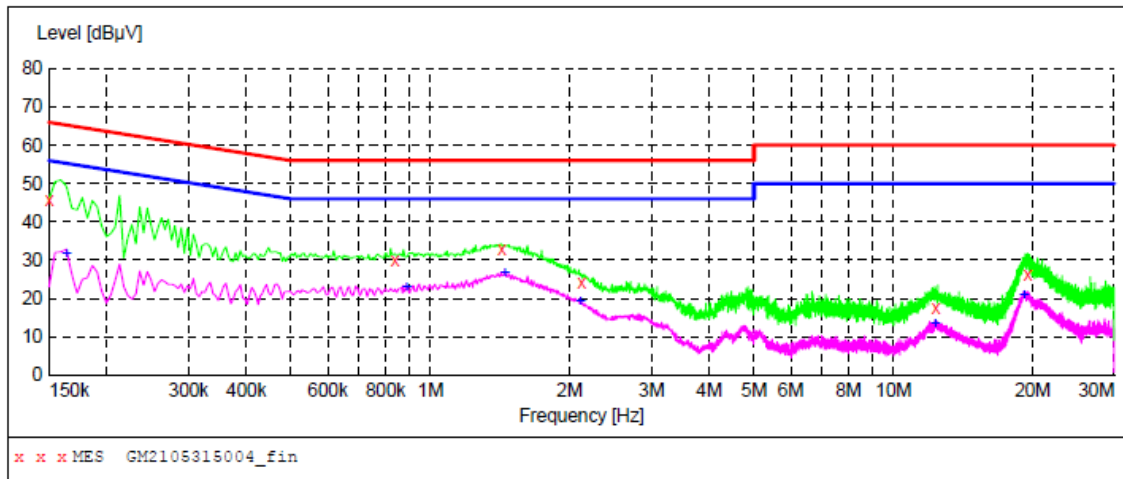

MEASUREMENT RESULT: "GM2105315004_fin"

5/31/2021 9:44AM

| Frequency MHz | Level dBµV | Transd dB | Limit dBµV | Margin dB | Detector | Line | PE |
|------------------|---------------|--------------|---------------|--------------|----------|------|-----|
| 0.150000 | 45.80 | 10.2 | 66 | 20.2 | QP | N | GND |
| 0.838500 | 29.80 | 10.2 | 56 | 26.2 | QP | N | GND |
| 1.423500 | 32.80 | 10.2 | 56 | 23.2 | QP | N | GND |
| 2.121000 | 24.30 | 10.2 | 56 | 31.7 | QP | N | GND |
| 12.349500 | 17.60 | 10.4 | 60 | 42.4 | QP | N | GND |
| 19.491000 | 26.40 | 10.5 | 60 | 33.6 | QP | N | GND |

MEASUREMENT RESULT: "GM2105315004_fin2"

5/31/2021 9:44AM

| Frequency MHz | Level dBµV | Transd dB | Limit dBµV | Margin dB | Detector | Line | PE |
|------------------|---------------|--------------|---------------|--------------|----------|------|-----|
| 0.163500 | 31.70 | 10.2 | 55 | 23.6 | AV | N | GND |
| 0.888000 | 23.00 | 10.2 | 46 | 23.0 | AV | N | GND |
| 1.446000 | 26.70 | 10.2 | 46 | 19.3 | AV | N | GND |
| 2.107500 | 19.40 | 10.2 | 46 | 26.6 | AV | N | GND |
| 12.322500 | 13.30 | 10.4 | 50 | 36.7 | AV | N | GND |
| 19.171500 | 21.00 | 10.5 | 50 | 29.0 | AV | N | GND |

5.3. Peak Output Power

LIMIT

FCC CFR Title 47 Part 15 Subpart C Section 15.247 (b)(1):

For frequency hopping systems operating in the 2400-2483.5 MHz band employing at least 75 non-overlapping hopping channels, and all frequency hopping systems in the 5725-5850 MHz band: 1 watt.
For all other frequency hopping systems in the 2400-2483.5 MHz band: 0.125 watts.

TEST CONFIGURATION

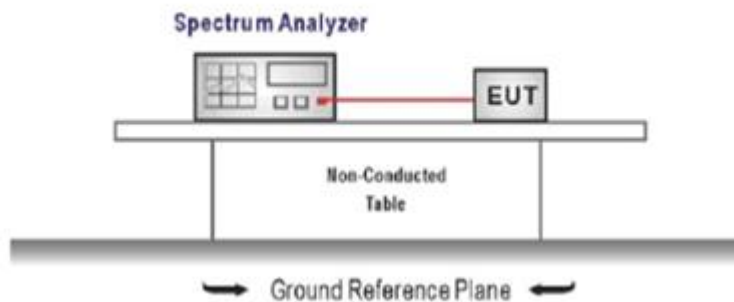

TEST PROCEDURE

1. The transmitter output was connected to the spectrum analyzer through an attenuator, the pathloss was compensated to the results for each measurement.
2. Set to the maximum power setting and enable the EUT transmit continuously
3. Use the following spectrum analyzer settings:
Span = approximately 5 times the 20 dB bandwidth, centered on a hopping channel
RBW \geq the 20 dB bandwidth of the emission being measured, VBW \geq RBW
Sweep = auto, Detector function = peak, Trace = max hold
4. Measure and record the results in the test report.

TEST MODE:

Please refer to the clause 4.3

TEST RESULT

Passed Not Applicable

TEST Data

Please refer to appendix A on the appendix report

5.4. 20 dB Bandwidth

LIMIT

N/A

TEST CONFIGURATION

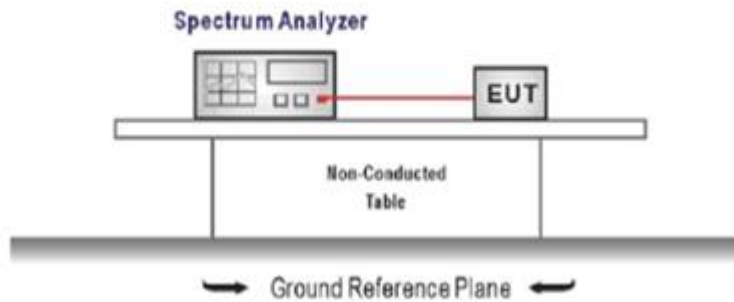

TEST PROCEDURE

1. The transmitter output was connected to the spectrum analyzer through an attenuator, the path loss was compensated to the results for each measurement.
2. Set to the maximum power setting and enable the EUT transmit continuously
3. Use the following spectrum analyzer settings:
Span = approximately 2 to 3 times the 20 dB bandwidth, centered on a hopping channel
RBW \geq 1% of the 20 dB bandwidth, VBW \geq RBW
Sweep = auto, Detector function = peak, Trace = max hold
4. Measure and record the results in the test report.

TEST MODE:

Please refer to the clause 4.3

TEST RESULT

Passed Not Applicable

TEST Data

Please refer to appendix B on the appendix report

5.5. 99% Occupied Bandwidth

LIMIT

N/A

TEST CONFIGURATION

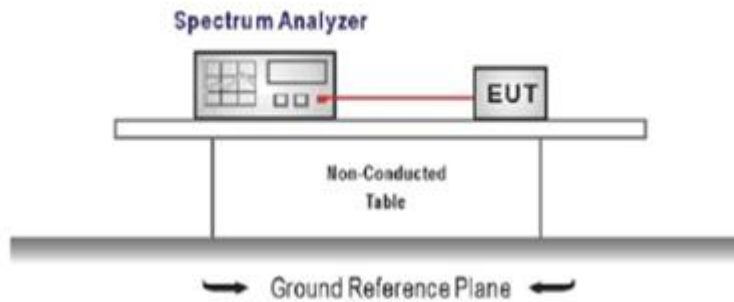

TEST PROCEDURE

1. Connect the antenna port(s) to the spectrum analyzer input.
2. Configure the spectrum analyzer as shown below (enter all losses between the transmitter output and the spectrum analyzer).
Center Frequency = channel center frequency
Span $\geq 1.5 \times$ OBW
RBW = 1%~5%OBW
VBW $\geq 3 \times$ RBW
Sweep time = auto couple
Detector = Peak
Trace mode = max hold
3. Place the radio in continuous transmit mode, allow the trace to stabilize, view the transmitter waveform on the spectrum analyzer.

TEST MODE:

Please refer to the clause 4.3

TEST RESULT

Passed Not Applicable

TEST Data

Please refer to appendix C on the appendix report

5.6. Carrier Frequencies Separation

LIMIT

FCC CFR Title 47 Part 15 Subpart C Section 15.247 (a)(1):

Frequency hopping systems shall have hopping channel carrier frequencies separated by a minimum of 25kHz or the 20 dB bandwidth of the hopping channel, whichever is greater. Alternatively, Frequency hopping systems operating in the 2400-2483.5 MHz band may have hopping channel carrier frequencies that are separated by 25 kHz or two-thirds of the 20 dB bandwidth of the hopping channel, whichever is greater, provided the systems operate with an output power no greater than 125 mW.

TEST CONFIGURATION

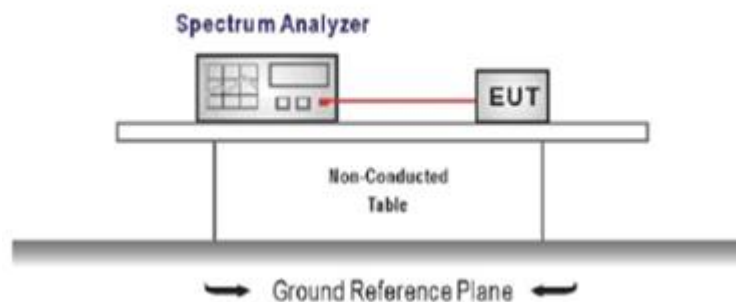

TEST PROCEDURE

1. The transmitter output was connected to the spectrum analyzer through an attenuator, the path loss was compensated to the results for each measurement.
2. Set to the maximum power setting and enable the EUT transmit continuously
3. Use the following spectrum analyzer settings:
 - Span = wide enough to capture the peaks of two adjacent channels
 - RBW \geq 1% of the span, VBW \geq RBW
 - Sweep = auto, Detector function = peak, Trace = max hold
4. Measure and record the results in the test report.

TEST MODE:

Please refer to the clause 4.3

TEST RESULTS

Passed Not Applicable

TEST Data

Please refer to appendix D on the appendix report

5.7. Hopping Channel Number

LIMIT

FCC CFR Title 47 Part 15 Subpart C Section 15.247 (a)(1):

Frequency hopping systems in the 2400–2483.5 MHz band shall use at least **15** channels.

TEST CONFIGURATION

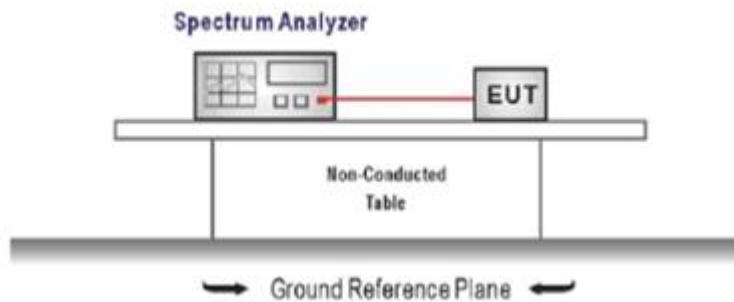

TEST PROCEDURE

1. The transmitter output was connected to the spectrum analyzer through an attenuator, the path loss was compensated to the results for each measurement.
2. Set to the maximum power setting and enable the EUT transmit continuously
3. Use the following spectrum analyzer settings:
Span = the frequency band of operation
RBW \geq 1% of the span, VBW \geq RBW
Sweep = auto, Detector function = peak, Trace = max hold
4. Measure and record the results in the test report.

TEST MODE:

Please refer to the clause 4.3

TEST RESULTS

Passed Not Applicable

TEST Data

Please refer to appendix E on the appendix report

5.8. Dwell Time

LIMIT

FCC CFR Title 47 Part 15 Subpart C Section 15.247 (a)(1):The average time of occupancy on any channel shall not be greater than 0.4 seconds within a pe-riod of 0.4 seconds multiplied by the number of hopping channels employed.

TEST CONFIGURATION

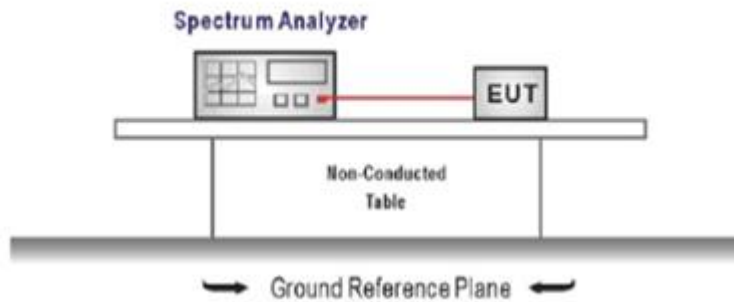

TEST PROCEDURE

1. The transmitter output was connected to the spectrum analyzer through an attenuator, the path loss was compensated to the results for each measurement.
2. Set to the maximum power setting and enable the EUT transmit continuously
3. Use the following spectrum analyzer settings:
Span = zero span, centered on a hopping channel, RBW= 1 MHz, VBW \geq RBW
Sweep = as necessary to capture the entire dwell time per hopping channel,
Detector function = peak, Trace = max hold
4. Measure and record the results in the test report.

TEST MODE:

Please refer to the clause 4.3

TEST RESULTS

Passed Not Applicable

TEST Data

Please refer to appendix F on the appendix report

5.9. Duty Cycle Correction Factor (DCCF)

LIMIT

N/A

TEST CONFIGURATION

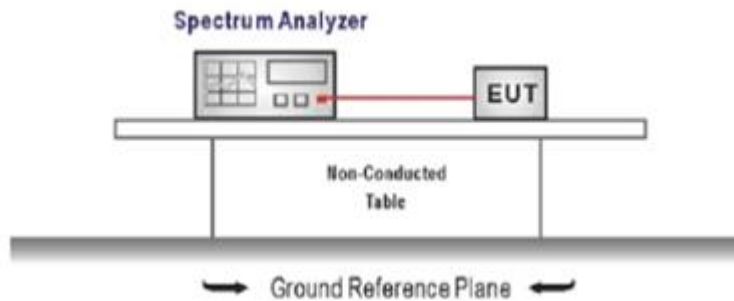

TEST PROCEDURE

1. The transmitter output was connected to the spectrum analyzer through an attenuator, the path loss was compensated to the results for each measurement.
2. Set to the maximum power setting and enable the EUT transmit continuously
3. Use the following spectrum analyzer settings:
Span = zero span, centered on a hopping channel, RBW= 1 MHz, VBW \geq RBW
Sweep = as necessary to capture the entire dwell time per hopping channel,
Detector function = peak, Trigger mode
4. Measure and record the duty cycle data

TEST MODE:

Please refer to the clause 4.3

TEST Data

Please refer to appendix G on the appendix report

5.10. Pseudorandom Frequency Hopping Sequence

LIMIT

FCC CFR Title 47 Part 15 Subpart C Section 15.247 (a)(1):Frequency hopping systems shall have hopping channel carrier frequencies separated by a minimum of 25 kHz or the 20 dB bandwidth of the hopping channel, whichever is greater. Alternatively, frequency hopping systems operating in the 2400–2483.5 MHz band may have hopping channel carrier frequencies that are separated by 25 kHz or two-thirds of the 20 dB bandwidth of the hopping channel, whichever is greater, provided the systems operate with an output power no greater than 125 mW. The system shall hop to channel frequencies that are selected at the system hopping rate from a pseudo-randomly ordered list of hopping frequencies. Each frequency must be used equally on the average by each transmitter. The system receivers shall have input bandwidths that match the hopping channel bandwidths of their corresponding transmitters and shall shift frequencies in synchronization with the transmitted signals.

TEST RESULTS

The pseudorandom frequency hopping sequence may be generated in a nine-stage shift register whose 5th and 9th stage outputs are added in a modulo-two addition stage. And the result is fed back to the input of the first stage. The sequence begins with the first one of 9 consecutive ones, for example: the shift register is initialized with nine ones.

- Number of shift register stages: 9
- Length of pseudo-random sequence: $2^9 - 1 = 511$ bits
- Longest sequence of zeros: 8 (non-inverted signal)

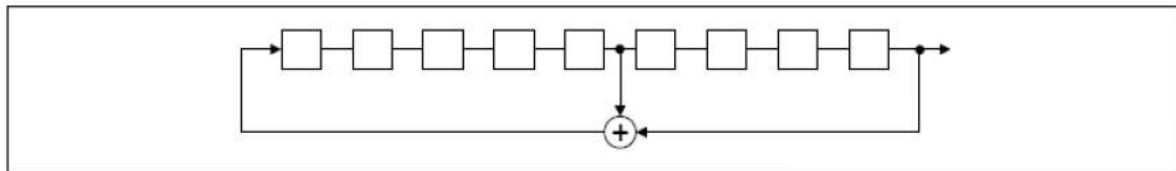

Linear Feedback Shift Register for Generation of the PRBS sequence

An example of pseudorandom frequency hopping sequence as follows:

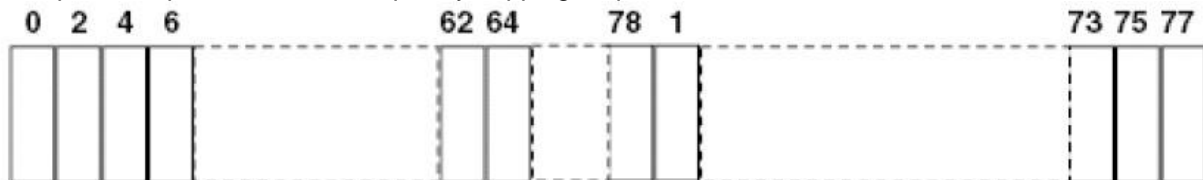

Each frequency used equally on the average by each transmitter. The system receiver has input bandwidths that match the hopping channel bandwidths of their corresponding transmitter and shift frequencies in synchronization with the transmitted signals.

5.11. Conducted Band edge and Spurious Emission

LIMIT

FCC CFR Title 47 Part 15 Subpart C Section 15.247 (d): In any 100 kHz bandwidth outside the frequency band in which the spread spectrum intentional radiator is operating, the radio frequency power that is produced by the intentional radiator shall be at least 20 dB below that in the 100 kHz bandwidth within the band that contains the highest level of the desired power, based on either an RF conducted or a radiated measurement.

TEST CONFIGURATION

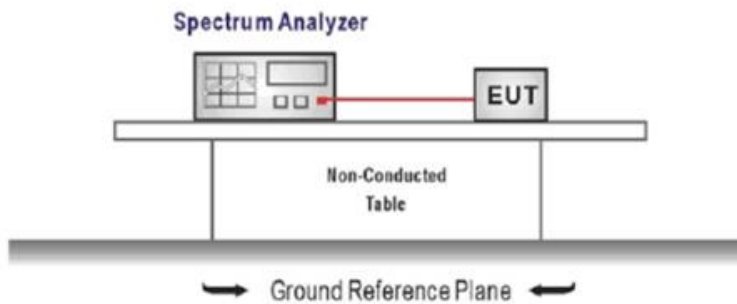

TEST PROCEDURE

1. Connect the antenna port(s) to the spectrum analyzer input.
2. Emission level measurement
Set the center frequency and span to encompass frequency range to be measured
RBW = 100 kHz, VBW \geq 3 x RBW
Detector = peak, Sweep time = auto couple, Trace mode = max hold
Allow trace to fully stabilize
Use the peak marker function to determine the maximum amplitude level.
3. Place the radio in continuous transmit mode, allow the trace to stabilize, view the transmitter waveform on the spectrum analyzer.
4. Ensure that the amplitude of all unwanted emission outside of the authorized frequency band excluding restricted frequency bands) are attenuated by at least the minimum requirements specified (at least 20 dB relative to the maximum in-band peak PSD level in 100 kHz). Report the three highest emission relative to the limit.

TEST MODE:

Please refer to the clause 4.3

TEST RESULT

Passed Not Applicable

TEST Data

Please refer to appendix H on the appendix report

5.12. Radiated Band edge Emission

LIMIT

FCC CFR Title 47 Part 15 Subpart C Section 15.247 (d):

In any 100 kHz bandwidth outside the frequency band in which the spread spectrum or digitally modulated intentional radiator is operating, Radiated Emissions which fall in the restricted bands, as defined in §15.205(a), must also comply with the Radiated Emissions limits specified in §15.209(a) (see §15.205(c)).

TEST CONFIGURATION

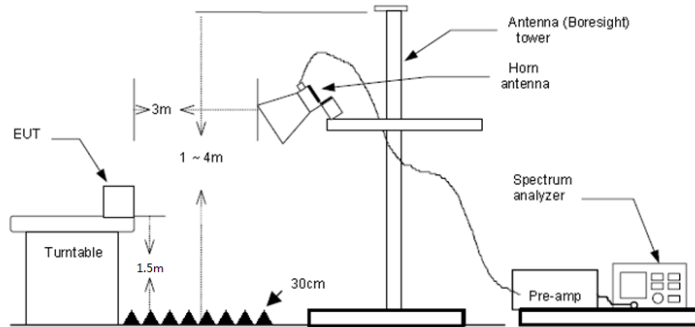

TEST PROCEDURE

1. The EUT was setup and tested according to ANSI C63.10 .
2. The EUT is placed on a turn table which is 1.5 meter above ground. The turn table is rotated 360 degrees to determine the position of the maximum emission level.
3. The EUT was positioned such that the distance from antenna to the EUT was 3 meters.
4. The antenna is scanned from 1 meter to 4 meters to find out the maximum emission level. This is repeated for both horizontal and vertical polarization of the antenna. In order to find the maximum emission, all of the interface cables were manipulated according to ANSI C63.10 on radiated measurement.
5. Use the following spectrum analyzer settings:
 - a) Span shall wide enough to fully capture the emission being measured
 - b) Set RBW=100kHz for <1GHz, VBW=3*RBW, Sweep time=auto, Detector=peak, Trace=max hold
 - c) Set RBW=1MHz, VBW=3MHz for >1GHz, Sweep time=auto, Detector=peak, Trace=max hold for Peak measurement

For average measurement: use duty cycle correction factor method (DCCF)
 Averager level = Peak level + DCCF

TEST MODE:

Please refer to the clause 4.3

TEST RESULT

Passed Not Applicable

Note:

- 1) Level= Reading + Factor; Factor =Antenna Factor+ Cable Loss- Preamp Factor
- 2) Over Limit = Level- Limit
- 3) Average measurement was not performed if peak level is lower than average limit(54 dBuV/m).

| Test channel: | | CH00 | | | Polarity | | Horizontal | | |
|---------------|------------------|-------------------|---------------|-------------|--------------|-----------------|-----------------|---------------|--------|
| Mark | Frequency MHz | Reading dBuV/m | Antenna dB | Cable dB | Preamp dB | Level dBuV/m | Limit dBuV/m | Over limit | Remark |
| 1 | 2310.00 | 37.83 | 27.96 | 7.30 | 37.56 | 35.53 | 74.00 | -38.47 | Peak |
| 2 | 2390.03 | 41.81 | 27.72 | 7.72 | 37.45 | 39.80 | 74.00 | -34.20 | Peak |

| Test channel: | | CH00 | | | Polarity | | Vertical | | |
|---------------|------------------|-------------------|---------------|-------------|--------------|-----------------|-----------------|---------------|--------|
| Mark | Frequency MHz | Reading dBuV/m | Antenna dB | Cable dB | Preamp dB | Level dBuV/m | Limit dBuV/m | Over limit | Remark |
| 1 | 2310.00 | 38.05 | 27.96 | 7.30 | 37.56 | 35.75 | 74.00 | -38.25 | Peak |
| 2 | 2390.03 | 41.80 | 27.72 | 7.72 | 37.45 | 39.79 | 74.00 | -34.21 | Peak |

| Test channel: | | CH78 | | | Polarity | | Horizontal | | |
|---------------|------------------|-------------------|---------------|-------------|--------------|-----------------|-----------------|---------------|--------|
| Mark | Frequency MHz | Reading dBuV/m | Antenna dB | Cable dB | Preamp dB | Level dBuV/m | Limit dBuV/m | Over limit | Remark |
| 1 | 2483.50 | 51.86 | 27.43 | 7.80 | 37.26 | 49.83 | 74.00 | -24.17 | Peak |
| 2 | 2500.00 | 32.91 | 27.40 | 7.81 | 37.26 | 30.86 | 74.00 | -43.14 | Peak |

| Test channel: | | CH78 | | | Polarity | | Vertical | | |
|---------------|------------------|-------------------|---------------|-------------|--------------|-----------------|-----------------|---------------|--------|
| Mark | Frequency MHz | Reading dBuV/m | Antenna dB | Cable dB | Preamp dB | Level dBuV/m | Limit dBuV/m | Over limit | Remark |
| 1 | 2483.50 | 49.66 | 27.43 | 7.80 | 37.26 | 47.63 | 74.00 | -26.37 | Peak |
| 2 | 2500.00 | 32.68 | 27.40 | 7.81 | 37.26 | 30.63 | 74.00 | -43.37 | Peak |

5.13. Radiated Spurious Emission

LIMIT

FCC CFR Title 47 Part 15 Subpart C Section 15.209

| Frequency | Limit (dBuV/m) | Value |
|----------------------|-------------------|------------|
| 0.009 MHz ~0.49 MHz | 2400/F(kHz) @300m | Quasi-peak |
| 0.49 MHz ~ 1.705 MHz | 24000/F(kHz) @30m | Quasi-peak |
| 1.705 MHz ~30 MHz | 30 @30m | Quasi-peak |

Note: Limit dBuV/m @3m = Limit dBuV/m @300m + 40*log(300/3)= Limit dBuV/m @300m +80,

Limit dBuV/m @3m = Limit dBuV/m @30m +40*log(30/3)= Limit dBuV/m @30m + 40.

| Frequency | Limit (dBuV/m @3m) | Value |
|---------------|--------------------|------------|
| 30MHz~88MHz | 40.00 | Quasi-peak |
| 88MHz~216MHz | 43.50 | Quasi-peak |
| 216MHz~960MHz | 46.00 | Quasi-peak |
| 960MHz~1GHz | 54.00 | Quasi-peak |
| Above 1GHz | 54.00 | Average |
| | 74.00 | Peak |

TEST CONFIGURATION

- 9 kHz ~ 30 MHz

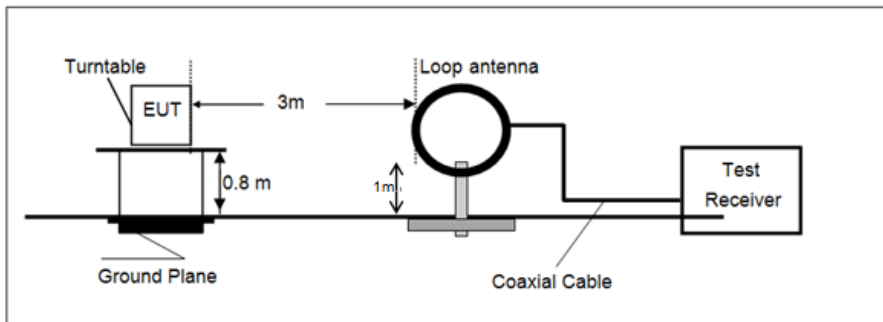

- 30 MHz ~ 1 GHz

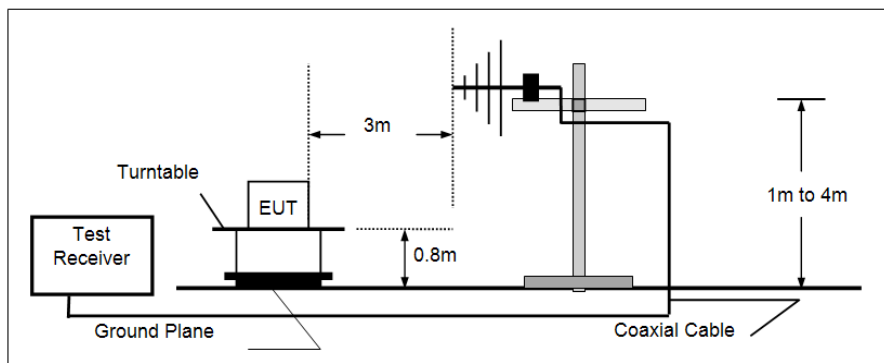

- Above 1 GHz

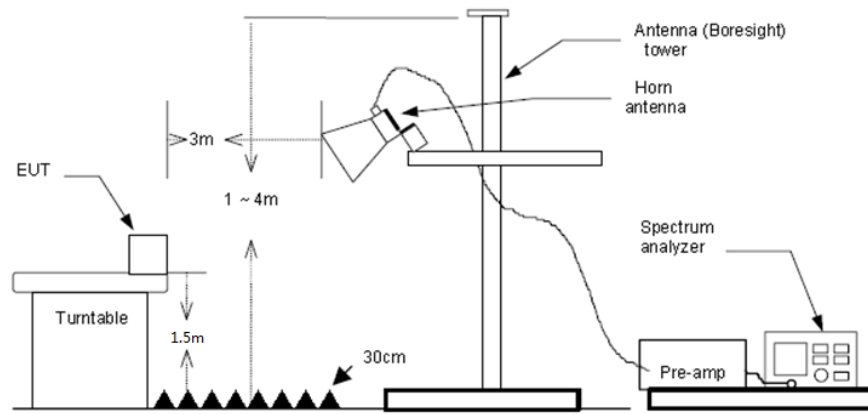

TEST PROCEDURE

1. The EUT was setup and tested according to ANSI C63.10 .
2. The EUT is placed on a turn table which is 0.8 meter above ground for below 1 GHz, and 1.5 m for above 1 GHz. The turn table is rotated 360 degrees to determine the position of the maximum emission level.
3. The EUT was set 3 meters from the receiving antenna, which was mounted on the top of a variable height antenna tower.
4. For each suspected emission, the EUT was arranged to its worst case and then tune the Antenna tower (from 1 m to 4 m) and turntable (from 0 degree to 360 degrees) to find the maximum reading. A pre-amp and a high pass filter are used for the test in order to get better signal level to comply with the guidelines.
5. Set to the maximum power setting and enable the EUT transmit continuously.
6. Use the following spectrum analyzer settings
 - a) Span shall wide enough to fully capture the emission being measured;
 - b) Below 1 GHz:
 - RBW=120 kHz, VBW=300 kHz, Sweep=auto, Detector function=peak, Trace=max hold;
 - If the emission level of the EUT measured by the peak detector is 3 dB lower than the applicable limit, the peak emission level will be reported. Otherwise, the emission measurement will be repeated using the quasi-peak detector and reported.
 - c) Set RBW=1MHz, VBW=3MHz for >1GHz, Sweep time=auto, Detector=peak, Trace=max hold for Peak measurement
 - For average measurement: use duty cycle correction factor method (DCCF)
 - Averager level = Peak level + DCCF

TEST MODE:

Please refer to the clause 4.3

TEST RESULT

Passed **Not Applicable**

Note:

- 1) Level= Reading + Factor/Transd; Factor/Transd =Antenna Factor+ Cable Loss- Preamp Factor
- 2) Over Limit = Level- Limit
- 3) Average measurement was not performed if peak level is lower than average limit(54 dBuV/m) for above 1GHz.

TEST DATA FOR 9 kHz ~ 30 MHz

The EUT was pre-scanned this frequency band, found the radiated level 20dB lower than the limit, so don't show data on this report.

TEST DATA FOR 30 MHz ~ 1000 MHz

Have pre-scan all test channel, found CH39 which it was worst case, so only show the worst case's data on this report.

Polarization:

Horizontal

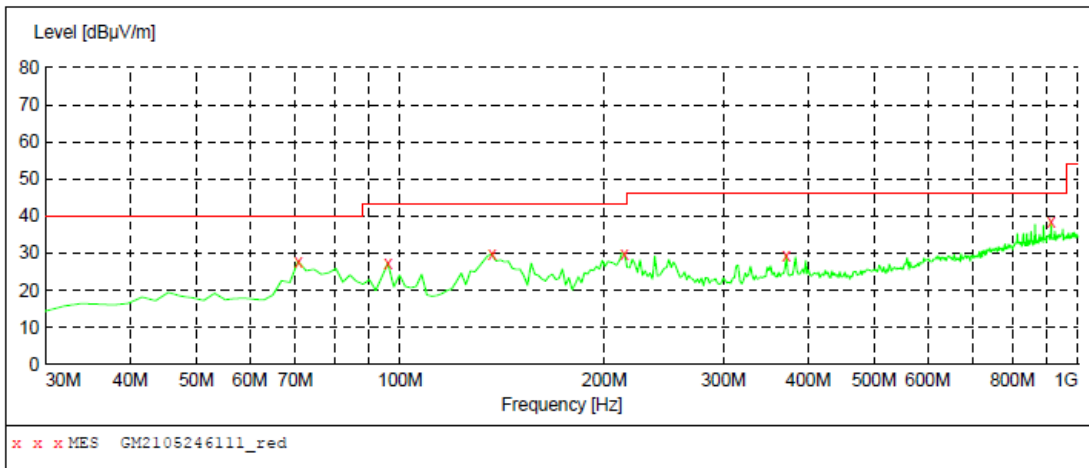

MEASUREMENT RESULT: "GM2105246111_red"

5/24/2021 10:23PM

| Frequency MHz | Level dBµV/m | Transd dB | Limit dBµV/m | Margin dB | Det. | Height cm | Azimuth deg | Polarization |
|---------------|--------------|-----------|--------------|-----------|------|-----------|-------------|--------------|
| 70.740000 | 27.90 | -13.3 | 40.0 | 12.1 | QP | 300.0 | 11.00 | HORIZONTAL |
| 95.960000 | 27.30 | -11.2 | 43.5 | 16.2 | QP | 300.0 | 360.00 | HORIZONTAL |
| 136.700000 | 29.70 | -14.0 | 43.5 | 13.8 | QP | 300.0 | 0.00 | HORIZONTAL |
| 214.300000 | 30.00 | -10.3 | 43.5 | 13.5 | QP | 100.0 | 51.00 | HORIZONTAL |
| 371.440000 | 29.50 | -5.1 | 46.0 | 16.5 | QP | 100.0 | 77.00 | HORIZONTAL |
| 912.700000 | 38.30 | 7.4 | 46.0 | 7.7 | QP | 100.0 | 124.00 | HORIZONTAL |

Polarization:

Vertical

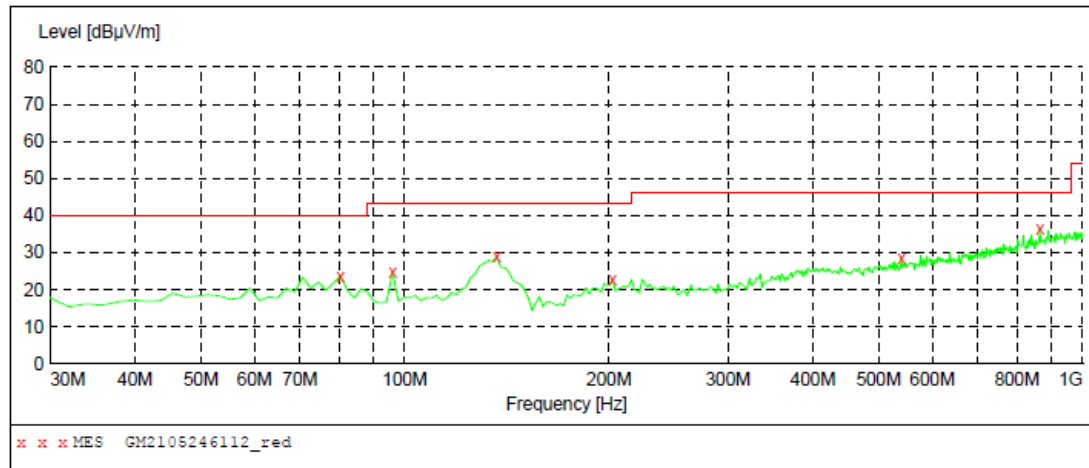

MEASUREMENT RESULT: "GM2105246112_red"

5/24/2021 10:26PM

| Frequency MHz | Level dBµV/m | Transd dB | Limit dBµV/m | Margin dB | Det. | Height cm | Azimuth deg | Polarization |
|---------------|--------------|-----------|--------------|-----------|------|-----------|-------------|--------------|
| 80.440000 | 23.70 | -15.7 | 40.0 | 16.3 | QP | 100.0 | 86.00 | VERTICAL |
| 95.960000 | 24.80 | -11.2 | 43.5 | 18.7 | QP | 100.0 | 63.00 | VERTICAL |
| 136.700000 | 28.90 | -14.0 | 43.5 | 14.6 | QP | 100.0 | 110.00 | VERTICAL |
| 202.660000 | 22.70 | -10.3 | 43.5 | 20.8 | QP | 100.0 | 38.00 | VERTICAL |
| 540.220000 | 28.40 | -0.9 | 46.0 | 17.6 | QP | 100.0 | 159.00 | VERTICAL |
| 864.200000 | 36.60 | 6.4 | 46.0 | 9.4 | QP | 100.0 | 0.00 | VERTICAL |

TEST DATA FOR 1 GHz ~ 25 GHz

| Test channel | | CH00 | | | Polarity | | Horizontal | | |
|--------------|------------------|-------------------|---------------|-------------|--------------|-----------------|-----------------|---------------|--------|
| Mark | Frequency MHz | Reading dBuV/m | Antenna dB | Cable dB | Preamp dB | Level dBuV/m | Limit dBuV/m | Over limit | Remark |
| 1 | 1267.10 | 35.37 | 25.93 | 5.31 | 36.43 | 30.18 | 74.00 | -43.82 | Peak |
| 2 | 3662.78 | 33.46 | 29.40 | 9.90 | 37.02 | 35.74 | 74.00 | -38.26 | Peak |
| 3 | 7961.43 | 31.54 | 36.95 | 14.41 | 33.32 | 49.58 | 74.00 | -24.42 | Peak |
| 4 | 10971.98 | 30.00 | 40.60 | 16.73 | 36.69 | 50.64 | 74.00 | -23.36 | Peak |

| Test channel | | CH00 | | | Polarity | | Vertical | | |
|--------------|------------------|-------------------|---------------|-------------|--------------|-----------------|-----------------|---------------|--------|
| Mark | Frequency MHz | Reading dBuV/m | Antenna dB | Cable dB | Preamp dB | Level dBuV/m | Limit dBuV/m | Over limit | Remark |
| 1 | 1254.27 | 35.70 | 25.91 | 5.27 | 36.48 | 30.40 | 74.00 | -43.60 | Peak |
| 2 | 3662.78 | 33.15 | 29.40 | 9.90 | 37.02 | 35.43 | 74.00 | -38.57 | Peak |
| 3 | 8022.46 | 30.76 | 37.14 | 14.29 | 33.31 | 48.88 | 74.00 | -25.12 | Peak |
| 4 | 10860.83 | 30.15 | 40.48 | 16.67 | 36.78 | 50.52 | 74.00 | -23.48 | Peak |

| Test channel | | CH39 | | | Polarity | | Horizontal | | |
|--------------|------------------|-------------------|---------------|-------------|--------------|-----------------|-----------------|---------------|--------|
| Mark | Frequency MHz | Reading dBuV/m | Antenna dB | Cable dB | Preamp dB | Level dBuV/m | Limit dBuV/m | Over limit | Remark |
| 1 | 1241.56 | 35.14 | 25.85 | 5.23 | 36.53 | 29.69 | 74.00 | -44.31 | Peak |
| 2 | 3644.18 | 33.14 | 29.40 | 9.96 | 37.01 | 35.49 | 74.00 | -38.51 | Peak |
| 3 | 7860.74 | 31.52 | 36.64 | 14.49 | 33.28 | 49.37 | 74.00 | -24.63 | Peak |
| 4 | 10916.26 | 29.65 | 40.60 | 16.70 | 36.74 | 50.21 | 74.00 | -23.79 | Peak |

| Test channel | | CH39 | | | Polarity | | Vertical | | |
|--------------|------------------|-------------------|---------------|-------------|--------------|-----------------|-----------------|---------------|--------|
| Mark | Frequency MHz | Reading dBuV/m | Antenna dB | Cable dB | Preamp dB | Level dBuV/m | Limit dBuV/m | Over limit | Remark |
| 1 | 1273.57 | 35.90 | 25.95 | 5.34 | 36.40 | 30.79 | 74.00 | -43.21 | Peak |
| 2 | 4004.08 | 32.50 | 29.91 | 10.18 | 36.34 | 36.25 | 74.00 | -37.75 | Peak |
| 3 | 8042.90 | 30.82 | 37.19 | 14.28 | 33.31 | 48.98 | 74.00 | -25.02 | Peak |
| 4 | 11545.04 | 29.92 | 40.76 | 16.72 | 36.37 | 51.03 | 74.00 | -22.97 | Peak |

| Test channel | | CH78 | | | Polarity | | Horizontal | | |
|--------------|------------------|-------------------|---------------|-------------|--------------|-----------------|-----------------|---------------|--------|
| Mark | Frequency MHz | Reading dBuV/m | Antenna dB | Cable dB | Preamp dB | Level dBuV/m | Limit dBuV/m | Over limit | Remark |
| 1 | 1098.76 | 36.83 | 25.40 | 4.97 | 36.89 | 30.31 | 74.00 | -43.69 | Peak |
| 2 | 4958.68 | 33.75 | 31.57 | 11.54 | 35.20 | 41.66 | 74.00 | -32.34 | Peak |
| 3 | 8022.46 | 31.36 | 37.14 | 14.29 | 33.31 | 49.48 | 74.00 | -24.52 | Peak |
| 4 | 10860.83 | 30.05 | 40.48 | 16.67 | 36.78 | 50.42 | 74.00 | -23.58 | Peak |

| Test channel | | CH78 | | | Polarity | | Vertical | | |
|--------------|------------------|-------------------|---------------|-------------|--------------|-----------------|-----------------|---------------|--------|
| Mark | Frequency MHz | Reading dBuV/m | Antenna dB | Cable dB | Preamp dB | Level dBuV/m | Limit dBuV/m | Over limit | Remark |
| 1 | 1112.84 | 36.09 | 25.40 | 4.99 | 36.86 | 29.62 | 74.00 | -44.38 | Peak |
| 2 | 4958.68 | 31.91 | 31.57 | 11.54 | 35.20 | 39.82 | 74.00 | -34.18 | Peak |
| 3 | 8022.46 | 30.28 | 37.14 | 14.29 | 33.31 | 48.40 | 74.00 | -25.60 | Peak |
| 4 | 10916.26 | 30.03 | 40.60 | 16.70 | 36.74 | 50.59 | 74.00 | -23.41 | Peak |

6. TEST SETUP PHOTOS

Radiated Emission

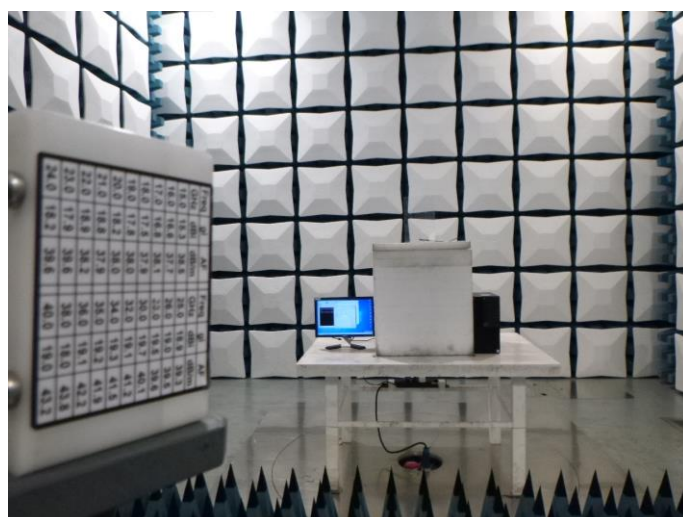
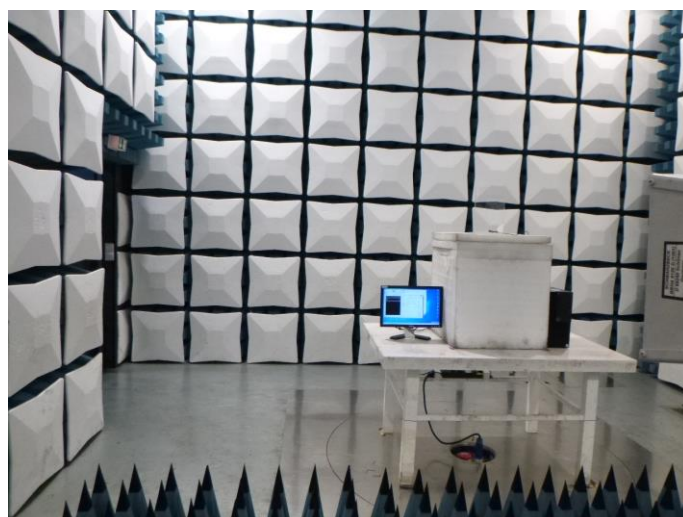
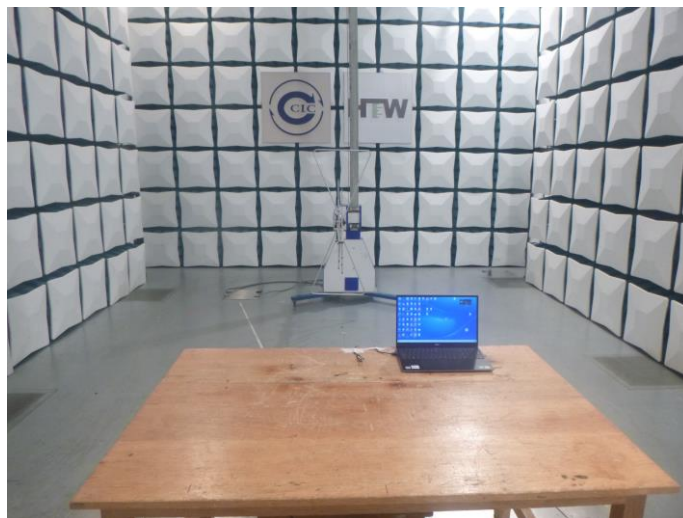

AC Conducted Emission

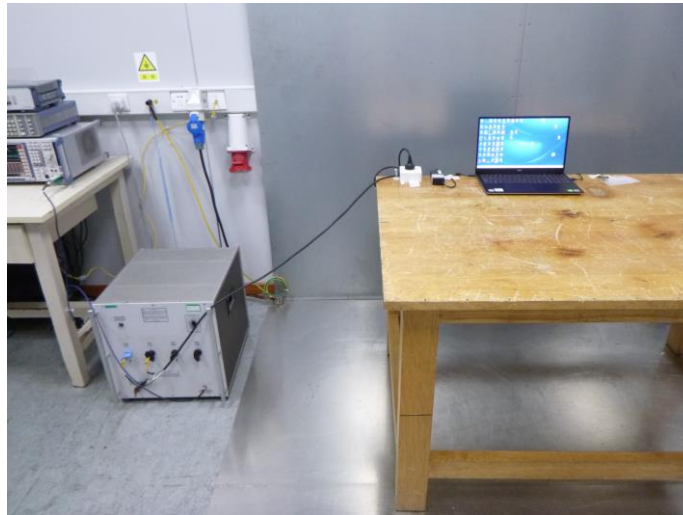

7. EXTERANAL AND INTERNAL PHOTOS

Reference to the test report No. : CHTEW21110133.

8. APPENDIX REPORT