



# TEST REPORT

**Report No.** ..... : **CHTEW20120031**      Report Verification: 

**Project No.**..... : **SHT2009048102EW**

**FCC ID**..... : **2AN9S-ABX00029**

**Applicant's name**..... : **Arduino S.r.l.**

**Address**..... : Via Andrea Appiani,25  
20900 MONZA (Italy)

**Test item description** ..... : **MKR WAN 1310**

**Trade Mark** ..... : Arduino

**Model/Type reference**..... : ABX00029

**Listed Model(s)** ..... : -

**Standard** ..... : **FCC CFR Title 47 Part 15 Subpart C Section 15.247**

**Date of receipt of test sample**..... : Sept.21, 2020

**Date of testing**..... : Sept.21, 2020- Dec.04, 2020

**Date of issue**..... : Dec.07, 2020

**Result**..... : **PASS**

Compiled by  
 ( Position+Printed name+Signature): File administrator Echo Wei

*Echo Wei*

Supervised by  
 (Position+Printed name+Signature): Project Engineer Kiki Kong

*Kiki Kong*

Approved by  
 (Position+Printed name+Signature): RF Manager Hans Hu

*Hans Hu*

**Testing Laboratory Name** ..... : **Shenzhen Huatongwei International Inspection Co., Ltd.**

**Address**..... : 1/F, Bldg 3, Hongfa Hi-tech Industrial Park, Genyu Road,  
Tianliao, Gongming, Shenzhen, China

**Shenzhen Huatongwei International Inspection Co., Ltd. All rights reserved.**

This publication may be reproduced in whole or in part for non-commercial purposes as long as the Shenzhen Huatongwei International Inspection Co., Ltd. is acknowledged as copyright owner and source of the material. Shenzhen Huatongwei International Inspection Co., Ltd. takes no responsibility for and will not assume liability for damages resulting from the reader's interpretation of the reproduced material due to its placement and context.

The test report merely correspond to the test sample.

## Contents

|           |  |           |
|-----------|--|-----------|
| <b>1.</b> | <b>TEST STANDARDS AND REPORT VERSION</b>           | <b>3</b>  |
| 1.1.      | Test Standards                                     | 3         |
| 1.2.      | Report version                                     | 3         |
| <b>2.</b> | <b>TEST DESCRIPTION</b>                            | <b>4</b>  |
| <b>3.</b> | <b>SUMMARY</b>                                     | <b>5</b>  |
| 3.1.      | Client Information                                 | 5         |
| 3.2.      | Product Description                                | 5         |
| 3.3.      | Radio Specification Description                    | 5         |
| 3.4.      | Testing Laboratory Information                     | 6         |
| <b>4.</b> | <b>TEST CONFIGURATION</b>                          | <b>7</b>  |
| 4.1.      | Test frequency list                                | 7         |
| 4.2.      | Descriptions of Test mode                          | 7         |
| 4.3.      | Support unit used in test configuration and system | 7         |
| 4.4.      | Testing environmental condition                    | 7         |
| 4.5.      | Measurement uncertainty                            | 8         |
| 4.6.      | Equipment Used during the Test                     | 9         |
| <b>5.</b> | <b>TEST CONDITIONS AND RESULTS</b>                 | <b>11</b> |
| 5.1.      | Antenna Requirement                                | 11        |
| 5.2.      | AC Conducted Emission                              | 12        |
| 5.3.      | Peak Output Power                                  | 15        |
| 5.4.      | 20 dB Bandwidth                                    | 16        |
| 5.5.      | 99% Occupied Bandwidth                             | 17        |
| 5.6.      | Carrier Frequencies Separation                     | 18        |
| 5.7.      | Hopping Channel Number                             | 19        |
| 5.8.      | Dwell Time   | 20        |
| 5.9.      | Duty Cycle Correction Factor (DCCF)                | 21        |
| 5.10.     | Pseudorandom Frequency Hopping Sequence            | 22        |
| 5.11.     | Conducted Band edge and Spurious Emission          | 23        |
| 5.12.     | Radiated Band edge Emission                        | 25        |
| 5.13.     | Radiated Spurious Emission                         | 27        |
| <b>6.</b> | <b>TEST SETUP PHOTOS</b>                           | <b>32</b> |
| <b>7.</b> | <b>EXTERANAL AND INTERNAL PHOTOS</b>               | <b>33</b> |
| <b>8.</b> | <b>APPENDIX REPORT</b>                             | <b>33</b> |

# 1. TEST STANDARDS AND REPORT VERSION

## 1.1. Test Standards

The tests were performed according to following standards:

- [FCC Rules Part 15.247](#): Frequency Hopping, Direct Spread Spectrum and Hybrid Systems that are in operation within the bands of 902-928 MHz, 2400-2483.5 MHz, and 5725-5850 MHz
- [ANSI C63.10:2013](#): American National Standard for Testing Unlicensed Wireless Devices
- [KDB 558074 D01 15.247 Meas Guidance v05r02](#): Guidance for Compliance Measurements on Digital Transmission System, Frequency Hopping Spread Spectrum System, and Hybrid System Devices Operating under Section 15.247 of The FCC Rules

## 1.2. Report version

| Revision No. | Date of issue | Description |
|--------------|---------------|-------------|
| N/A          | 2020-12-07    | Original    |
|              |               |             |
|              |               |             |
|              |               |             |
|              |               |             |

## 2. TEST DESCRIPTION

| Report clause | Test Items                                | Standard Requirement    | Result             |
|---------------|---|-------------------------|--------------------|
| 5.1           | Antenna Requirement                       | 15.203/15.247 (c)       | PASS               |
| 5.2           | AC Conducted Emission                     | 15.207                  | PASS               |
| 5.3           | Peak Output Power                         | 15.247 (b)(1)           | PASS               |
| 5.4           | 20 dB Bandwidth                           | 15.247 (a)(1)           | PASS               |
| 5.5           | 99% Occupied Bandwidth                    | -                       | PASS <sup>*1</sup> |
| 5.6           | Carrier Frequency Separation              | 15.247 (a)(1)           | PASS               |
| 5.7           | Hopping Channel Number                    | 15.247 (a)(1)           | PASS               |
| 5.8           | Dwell Time                                | 15.247 (a)(1)           | PASS               |
| 5.9           | Duty Cycle Correction Factor              | -                       | PASS <sup>*1</sup> |
| 5.10          | Pseudorandom Frequency Hopping Sequence   | 15.247(b)(4)            | PASS               |
| 5.11          | Conducted Band Edge and Spurious Emission | 15.247(d)/15.205        | PASS               |
| 5.12          | Radiated Band Edge Emission               | 15.205/15.209           | PASS               |
| 5.13          | Radiated Spurious Emission                | 15.247(d)/15.205/15.209 | PASS               |

Note:

- The measurement uncertainty is not included in the test result.
- \*1: No requirement on standard, only report these test data.

### 3. SUMMARY

#### 3.1. Client Information

|               |  |
|---------------|--|
| Applicant:    | Arduino S.r.l.                               |
| Address:      | Via Andrea Appiani,25<br>20900 MONZA (Italy) |
| Manufacturer: | Arduino S.r.l.                               |
| Address:      | Via Andrea Appiani,25<br>20900 MONZA (Italy) |

#### 3.2. Product Description

|                   |              |
|-------------------|--------------|
| Name of EUT:      | MKR WAN 1310 |
| Trade Mark:       | Arduino      |
| Model No.:        | ABX00029     |
| Listed Model(s):  | -            |
| Power supply:     | DC 5V        |
| Hardware version: | 3.0          |
| Software version: | 1.1.9        |

#### 3.3. Radio Specification Description

|                                  |   |
|----------------------------------|---|
| Support function <sup>*2</sup> : | LORA                                    |
| Modulation:                      | LORA                                    |
| Operation frequency:             | 902.3MHz~914.9MHz                       |
| Channel number:                  | 64                                      |
| Channel separation:              | 200kHz                                  |
| Antenna type:                    | external omnidirectional dipole antenna |
| Antenna gain:                    | -1dBi                                   |

Note:

\*2: only show the RF function associated with this report.

### 3.4. Testing Laboratory Information

|                     |  |                      |
|---------------------|--|----------------------|
| Laboratory Name     | Shenzhen Huatongwei International Inspection Co., Ltd.                                       |                      |
| Laboratory Location | 1/F, Bldg 3, Hongfa Hi-tech Industrial Park, Genyu Road, Tianliao, Gongming, Shenzhen, China |                      |
| Qualifications      | Type   | Accreditation Number |
|                     | CNAS   | L1225                |
|                     | A2LA   | 3902.01              |
|                     | FCC  | 762235               |
|                     | Canada   | 5377A                |

## 4. TEST CONFIGURATION

### 4.1. Test frequency list

According to section 15.31(m), regards to the operating frequency range over 10 MHz, must select three channels which were tested. The Lowest frequency, the middle frequency, and the highest frequency of channel were selected to perform the test, please see the below blue front.

| Channel | Frequency (MHz) |
|---------|-----------------|
| CH-L    | 902.3           |
| CH-M    | 908.5           |
| CH-H    | 914.9           |

### 4.2. Descriptions of Test mode

|  |
|--|
| For RF test items  |
| The engineering test program was provided and enabled to make EUT continuous transmit.   |
| For AC power line conducted emissions:   |
| The EUT connect to laptop by USB cable.the laptop control LORA transmitting.   |
| For Radiated suprious emissions test item:   |
| The engineering test program was provided and enabled to make EUT continuous transmit. The EUT in each of three orthogonal axis emissions had been tested ,but only the worst case (X axis) data Recorded in the report. |

### 4.3. Support unit used in test configuration and system

The EUT has been associated with peripherals and configuration operated in a manner tended to maximize its emission characteristics in a typical application.

The following peripheral devices and interface cables were connected during the measurement:

| Whether support unit is used? |            |            |                  |        |            |
|-------------------------------|------------|------------|------------------|--------|------------|
| ✓ Yes                         |            |            |                  |        |            |
| Item                          | Equipement | Trade Name | Model No.        | FCC ID | Power cord |
| 1                             | Laptop     | DELL       | Inspiron 13-5378 | -      | -          |
| 2                             |            |            |                  |        |            |

### 4.4. Testing environmental condition

| Type               | Requirement  | Actual   |
|--------------------|--------------|----------|
| Temperature:       | 15~35°C      | 25°C     |
| Relative Humidity: | 25~75%       | 50%      |
| Air Pressure:      | 860~1060mbar | 1000mbar |

#### 4.5. Measurement uncertainty

| Test Item                            | Measurement Uncertainty |
|--------------------------------------|-------------------------|
| AC Conducted Emission (150kHz~30MHz) | 3.02 dB                 |
| Radiated Emission (30MHz~1000MHz)    | 4.90 dB                 |
| Radiated Emissions (1GHz~25GHz)      | 4.96 dB                 |
| Peak Output Power                    | 0.51 dB                 |
| Power Spectral Density               | 0.51 dB                 |
| Conducted Spurious Emission          | 0.51 dB                 |
| 6dB Bandwidth                        | 70 Hz                   |

This uncertainty represents an expanded uncertainty expressed at approximately the 95% confidence level using a coverage factor of  $k=1.96$ .



#### 4.6. Equipment Used during the Test

| ● Conducted Emission |                     |                    |               |                 |               |                           |                           |
|----------------------|---------------------|--------------------|---------------|-----------------|---------------|---------------------------|---------------------------|
| Used                 | Test Equipment      | Manufacturer       | Equipment No. | Model No.       | Serial No.    | Last Cal. Date (YY-MM-DD) | Next Cal. Date (YY-MM-DD) |
| ●                    | Shielded Room       | Albatross projects | HTWE0114      | N/A             | N/A           | 2018/09/28                | 2023/09/27                |
| ●                    | EMI Test Receiver   | R&S                | HTWE0111      | ESCI            | 101247        | 2020/10/19                | 2021/10/18                |
| ●                    | Artificial Mains    | SCHWARZBECK        | HTWE0113      | NNLK 8121       | 573           | 2020/10/15                | 2021/10/14                |
| ●                    | Pulse Limiter       | R&S                | HTWE0033      | ESH3-Z2         | 100499        | 2020/10/15                | 2021/10/14                |
| ●                    | RF Connection Cable | HUBER+SUHNER       | HTWE0113-02   | ENVIROFLE X_142 | EF-NM-BNCM-2M | 2020/10/15                | 2021/10/14                |
| ●                    | Test Software       | R&S                | N/A           | ES-K1           | N/A           | N/A                       | N/A                       |

| ● Radiated emission-6th test site |                         |                    |               |              |            |                           |                           |
|-----------------------------------|-------------------------|--------------------|---------------|--------------|------------|---------------------------|---------------------------|
| Used                              | Test Equipment          | Manufacturer       | Equipment No. | Model No.    | Serial No. | Last Cal. Date (YY-MM-DD) | Next Cal. Date (YY-MM-DD) |
| ●                                 | Semi-Anechoic Chamber   | Albatross projects | HTWE0127      | SAC-3m-02    | C11121     | 2018/09/30                | 2021/09/29                |
| ●                                 | EMI Test Receiver       | R&S                | HTWE0099      | ESCI         | 100900     | 2020/10/19                | 2021/10/18                |
| ●                                 | Loop Antenna            | R&S                | HTWE0170      | HFH2-Z2      | 100020     | 2018/04/02                | 2021/04/01                |
| ●                                 | Ultra-Broadband Antenna | SCHWARZBECK        | HTWE0123      | VULB9163     | 538        | 2018/04/04                | 2021/04/03                |
| ●                                 | Pre-Amplifier           | SCHWARZBECK        | HTWE0295      | BBV 9742     | N/A        | 2020/11/13                | 2021/11/12                |
| ●                                 | RF Connection Cable     | HUBER+SUHNER       | HTWE0062-01   | N/A          | N/A        | 2020/05/27                | 2021/05/26                |
| ●                                 | RF Connection Cable     | HUBER+SUHNER       | HTWE0062-02   | SUCOFLEX 104 | 501184/4   | 2020/05/27                | 2021/05/26                |
| ●                                 | Test Software           | R&S                | N/A           | ES-K1        | N/A        | N/A                       | N/A                       |

| ● Radiated emission-7th test site |                         |                    |               |                   |             |                           |                           |
|-----------------------------------|-------------------------|--------------------|---------------|-------------------|-------------|---------------------------|---------------------------|
| Used                              | Test Equipment          | Manufacturer       | Equipment No. | Model No.         | Serial No.  | Last Cal. Date (YY-MM-DD) | Next Cal. Date (YY-MM-DD) |
| ●                                 | Semi-Anechoic Chamber   | Albatross projects | HTWE0122      | SAC-3m-01         | N/A         | 2018/09/27                | 2021/09/26                |
| ●                                 | Spectrum Analyzer       | R&S                | HTWE0098      | FSP40             | 100597      | 2020/10/20                | 2021/10/19                |
| ●                                 | Horn Antenna            | SCHWARZBECK        | HTWE0126      | 9120D             | 1011        | 2020/04/01                | 2023/03/31                |
| ●                                 | Broadband Horn Antenna  | SCHWARZBECK        | HTWE0103      | BBHA9170          | BBHA9170472 | 2018/10/11                | 2021/10/11                |
| ●                                 | Pre-amplifier           | CD                 | HTWE0071      | PAP-0102          | 12004       | 2020/11/13                | 2021/11/12                |
| ●                                 | Broadband Pre-amplifier | SCHWARZBECK        | HTWE0201      | BBV 9718          | 9718-248    | 2020/05/23                | 2021/05/22                |
| ●                                 | RF Connection Cable     | HUBER+SUHNER       | HTWE0120-01   | 6m 18GHz S Serisa | N/A         | 2020/05/10                | 2021/05/09                |
| ●                                 | RF Connection Cable     | HUBER+SUHNER       | HTWE0120-02   | 6m 3GHz RG Serisa | N/A         | 2020/05/10                | 2021/05/09                |
| ●                                 | RF Connection Cable     | HUBER+SUHNER       | HTWE0120-03   | 6m 3GHz RG Serisa | N/A         | 2020/05/10                | 2021/05/09                |
| ●                                 | RF Connection Cable     | HUBER+SUHNER       | HTWE0120-04   | 6m 3GHz RG Serisa | N/A         | 2020/05/10                | 2021/05/09                |
| ●                                 | RF Connection Cable     | HUBER+SUHNER       | HTWE0121-01   | 6m 18GHz S Serisa | N/A         | 2020/05/10                | 2021/05/09                |
| ●                                 | Test Software           | Audix              | N/A           | E3                | N/A         | N/A                       | N/A                       |

| ● RF Conducted Method |                              |              |           |            |                           |                           |
|-----------------------|------------------------------|--------------|-----------|------------|---------------------------|---------------------------|
| Used                  | Test Equipment               | Manufacturer | Model No. | Serial No. | Last Cal. Date (YY-MM-DD) | Next Cal. Date (YY-MM-DD) |
| ●                     | Signal and spectrum Analyzer | R&S          | FSV40     | 100048     | 2020/10/19                | 2021/10/18                |
| ●                     | Spectrum Analyzer            | Agilent      | N9020A    | MY50510187 | 2020/10/19                | 2021/10/18                |
| ○                     | Power Meter                  | Anritsu      | ML249A    | N/A        | 2020/10/19                | 2021/10/18                |
| ○                     | Radio communication tester   | R&S          | CMW500    | 137688-Lv  | 2020/10/19                | 2021/10/18                |

## 5. TEST CONDITIONS AND RESULTS

### 5.1. Antenna Requirement

#### Requirement

##### **FCC CFR Title 47 Part 15 Subpart C Section 15.203:**

An intentional radiator shall be designed to ensure that no antenna other than that furnished by the responsible party shall be used with the device. The use of a permanently attached antenna or of an antenna that uses a unique coupling to the intentional radiator, the manufacturer may design the unit so that a broken antenna can be replaced by the user, but the use of a standard antenna jack or electrical connector is prohibited.

##### **FCC CFR Title 47 Part 15 Subpart C Section 15.247(c) (1)(i):**

(i) Systems operating in the 2400-2483.5 MHz band that is used exclusively for fixed. Point-to-point operations may employ transmitting antennas with directional gain greater than 6 dBi provided the maximum conducted output power of the intentional radiator is reduced by 1 dB for every 3 dB that the directional gain of the antenna exceeds 6 dBi.

#### TEST RESULT

Passed       Not Applicable

The antenna type is a external omnidirectional dipole antenna, the directional gain of the antenna less than 6 dBi, please refer to the below antenna photo.

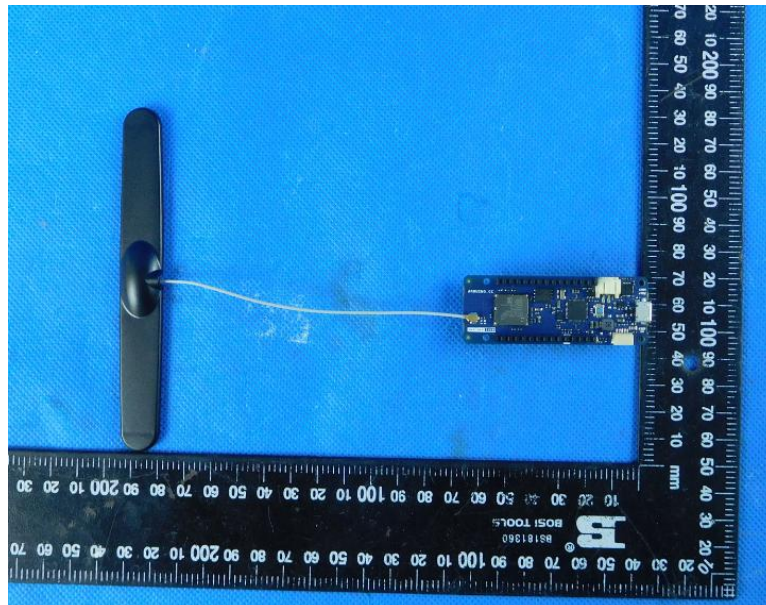

## 5.2. AC Conducted Emission

### LIMIT

#### FCC CFR Title 47 Part 15 Subpart C Section 15.207

| Frequency range (MHz) | Limit (dBuV) |           |
|-----------------------|--------------|-----------|
|                       | Quasi-peak   | Average   |
| 0.15-0.5              | 66 to 56*    | 56 to 46* |
| 0.5-5                 | 56           | 46        |
| 5-30                  | 60           | 50        |

\* Decreases with the logarithm of the frequency.

### TEST CONFIGURATION

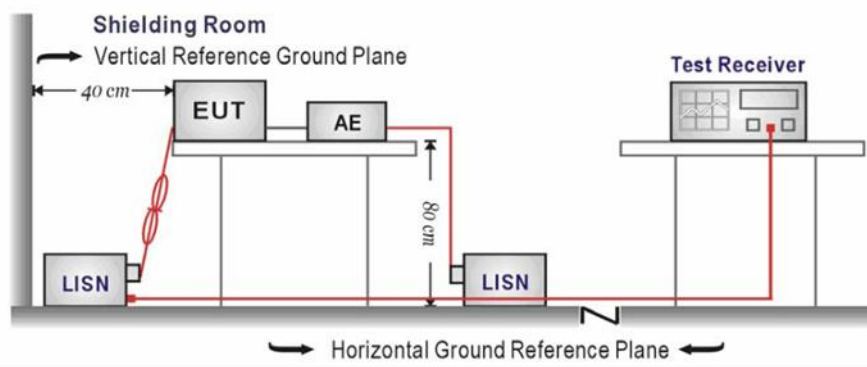

### TEST PROCEDURE

1. The EUT was setup according to ANSI C63.10 requirements.
2. The EUT was placed on a platform of nominal size, 1 m by 1.5 m, raised 80 cm above the conducting ground plane. The vertical conducting plane was located 40 cm to the rear of the EUT. All other surfaces of EUT were at least 80 cm from any other grounded conducting surface.
3. The EUT and simulators are connected to the main power through a line impedances stabilization network (LISN). The LISN provides a 50 ohm /50uH coupling impedance for the measuring equipment.
4. The peripheral devices are also connected to the main power through a LISN. (Please refer to the block diagram of the test setup and photographs)
5. Each current-carrying conductor of the EUT power cord, except the ground (safety) conductor, was individually connected through a LISN to the input power source.
6. The excess length of the power cord between the EUT and the LISN receptacle were folded back and forth at the center of the lead to form a bundle not exceeding 40 cm in length.
7. Conducted emissions were investigated over the frequency range from 0.15MHz to 30MHz using a receiver bandwidth of 9 kHz.
8. During the above scans, the emissions were maximized by cable manipulation.

### TEST MODE:

Please refer to the clause 4.3

### TEST RESULT

Passed       Not Applicable

Test Line:

L

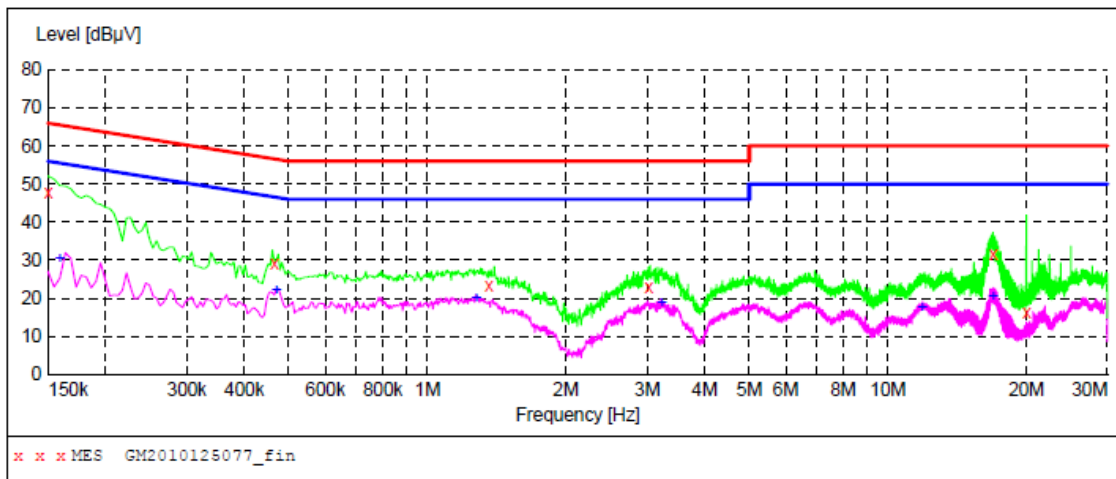

**MEASUREMENT RESULT: "GM2010125077\_fin"**

10/12/2020 6:00PM

| Frequency MHz | Level dBµV | Transd dB | Limit dBµV | Margin dB | Detector | Line | PE  |
|---------------|------------|-----------|------------|-----------|----------|------|-----|
| 0.150000      | 47.70      | 10.0      | 66         | 18.3      | QP       | L1   | GND |
| 0.465000      | 29.00      | 10.1      | 57         | 27.6      | QP       | L1   | GND |
| 1.360500      | 23.30      | 10.1      | 56         | 32.7      | QP       | L1   | GND |
| 3.021000      | 23.00      | 10.2      | 56         | 33.0      | QP       | L1   | GND |
| 16.944000     | 31.50      | 10.5      | 60         | 28.5      | QP       | L1   | GND |
| 20.022000     | 16.20      | 10.5      | 60         | 43.8      | QP       | L1   | GND |

**MEASUREMENT RESULT: "GM2010125077\_fin2"**

10/12/2020 6:00PM

| Frequency MHz | Level dBµV | Transd dB | Limit dBµV | Margin dB | Detector | Line | PE  |
|---------------|------------|-----------|------------|-----------|----------|------|-----|
| 0.159000      | 30.30      | 10.0      | 56         | 25.2      | AV       | L1   | GND |
| 0.469500      | 22.10      | 10.1      | 47         | 24.4      | AV       | L1   | GND |
| 1.275000      | 19.90      | 10.1      | 46         | 26.1      | AV       | L1   | GND |
| 3.228000      | 18.80      | 10.2      | 46         | 27.2      | AV       | L1   | GND |
| 11.872500     | 17.60      | 10.4      | 50         | 32.4      | AV       | L1   | GND |
| 16.912500     | 20.50      | 10.5      | 50         | 29.5      | AV       | L1   | GND |

Test Line:

N

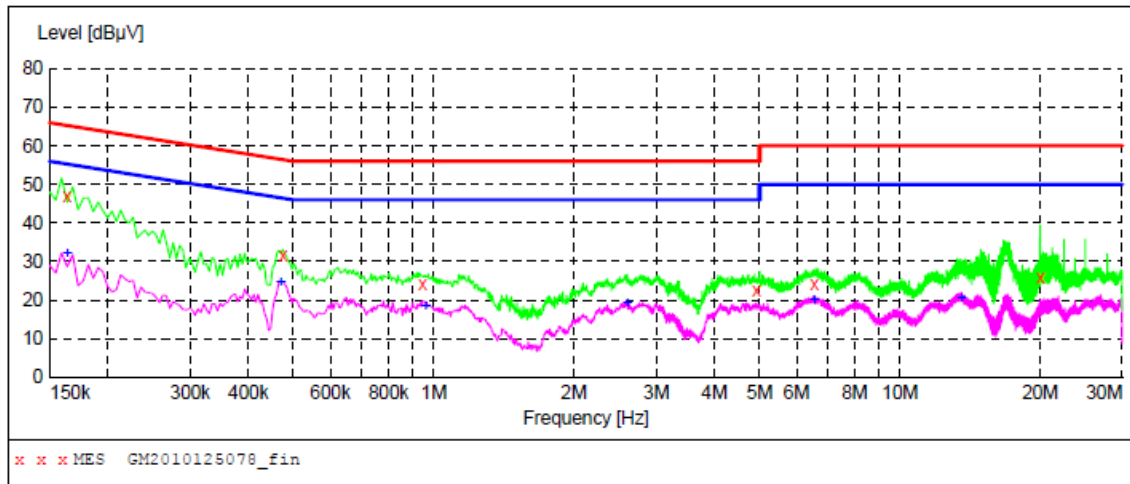

**MEASUREMENT RESULT: "GM2010125078\_fin"**

10/12/2020 6:02PM

| Frequency<br>MHz | Level<br>dBuV | Transd<br>dB | Limit<br>dBuV | Margin<br>dB | Detector | Line | PE  |
|------------------|---------------|--------------|---------------|--------------|----------|------|-----|
| 0.163500         | 47.10         | 10.0         | 65            | 18.2         | QP       | N    | GND |
| 0.474000         | 31.50         | 10.1         | 56            | 24.9         | QP       | N    | GND |
| 0.946500         | 24.20         | 10.1         | 56            | 31.8         | QP       | N    | GND |
| 4.915500         | 22.30         | 10.2         | 56            | 33.7         | QP       | N    | GND |
| 6.558000         | 24.20         | 10.2         | 60            | 35.8         | QP       | N    | GND |
| 20.017500        | 25.90         | 10.5         | 60            | 34.1         | QP       | N    | GND |

**MEASUREMENT RESULT: "GM2010125078\_fin2"**

10/12/2020 6:02PM

| Frequency<br>MHz | Level<br>dBuV | Transd<br>dB | Limit<br>dBuV | Margin<br>dB | Detector | Line | PE  |
|------------------|---------------|--------------|---------------|--------------|----------|------|-----|
| 0.163500         | 32.10         | 10.0         | 55            | 23.2         | AV       | N    | GND |
| 0.469500         | 24.60         | 10.1         | 47            | 21.9         | AV       | N    | GND |
| 0.960000         | 18.50         | 10.1         | 46            | 27.5         | AV       | N    | GND |
| 2.602500         | 19.30         | 10.2         | 46            | 26.7         | AV       | N    | GND |
| 6.553500         | 20.20         | 10.2         | 50            | 29.8         | AV       | N    | GND |
| 13.569000        | 20.40         | 10.4         | 50            | 29.6         | AV       | N    | GND |

### 5.3. Peak Output Power

#### LIMIT

#### **FCC CFR Title 47 Part 15 Subpart C Section 15.247 (b)(1):**

For frequency hopping systems operating in the 902-928 MHz band: 1 watt for systems employing at least 50 hopping channels; and, 0.25 watts for systems employing less than 50 hopping channels, but at least 25 hopping channels, as permitted under paragraph (a)(1)(i) of this section.

#### TEST CONFIGURATION

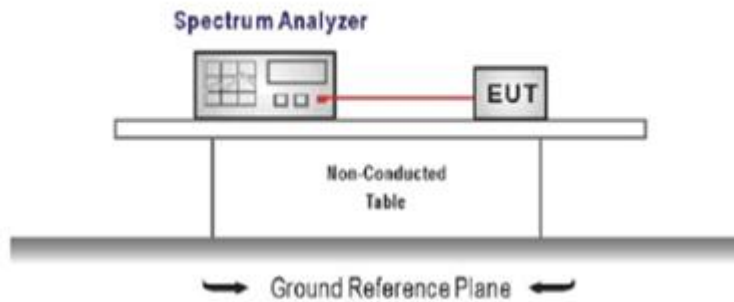

#### TEST PROCEDURE

1. The transmitter output was connected to the spectrum analyzer through an attenuator, the pathloss was compensated to the results for each measurement.
2. Set to the maximum power setting and enable the EUT transmit continuously
3. Use the following spectrum analyzer settings:  
Span = approximately 5 times the 20 dB bandwidth, centered on a hopping channel  
RBW  $\geq$  the 20 dB bandwidth of the emission being measured, VBW  $\geq$  RBW  
Sweep = auto, Detector function = peak, Trace = max hold
4. Measure and record the results in the test report.

#### TEST MODE:

Please refer to the clause 4.3

#### TEST RESULT

Passed       Not Applicable

#### TEST Data

Please refer to appendix A on the appendix report

## 5.4. 20 dB Bandwidth

### LIMIT

The maximum allowed 20 dB bandwidth of the hopping channel is 500 kHz

### TEST CONFIGURATION

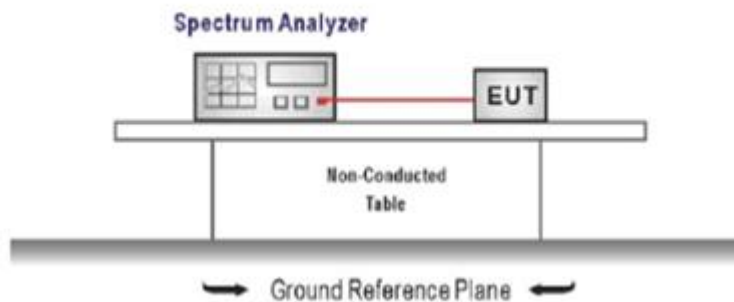

### TEST PROCEDURE

1. The transmitter output was connected to the spectrum analyzer through an attenuator, the path loss was compensated to the results for each measurement.
2. Set to the maximum power setting and enable the EUT transmit continuously
3. Use the following spectrum analyzer settings:  
Span = approximately 2 to 3 times the 20 dB bandwidth, centered on a hopping channel  
RBW  $\geq$  1% of the 20 dB bandwidth, VBW  $\geq$  RBW  
Sweep = auto, Detector function = peak, Trace = max hold
4. Measure and record the results in the test report.

### TEST MODE:

Please refer to the clause 4.3

### TEST RESULT

Passed       Not Applicable

### TEST Data

Please refer to appendix B on the appendix report



## 5.5. 99% Occupied Bandwidth

### LIMIT

N/A

### TEST CONFIGURATION

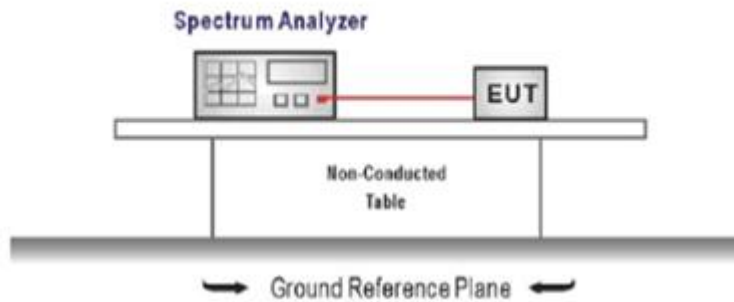

### TEST PROCEDURE

1. Connect the antenna port(s) to the spectrum analyzer input.
2. Configure the spectrum analyzer as shown below (enter all losses between the transmitter output and the spectrum analyzer).  
Center Frequency = channel center frequency  
Span  $\geq 1.5 \times$  OBW  
RBW = 1%~5%OBW  
VBW  $\geq 3 \times$  RBW  
Sweep time = auto couple  
Detector = Peak  
Trace mode = max hold
3. Place the radio in continuous transmit mode, allow the trace to stabilize, view the transmitter waveform on the spectrum analyzer.

### TEST MODE:

Please refer to the clause 4.3

### TEST RESULT

Passed       Not Applicable

### TEST Data

Please refer to appendix C on the appendix report

## 5.6. Carrier Frequencies Separation

### LIMIT

#### FCC CFR Title 47 Part 15 Subpart C Section 15.247 (a):

Frequency hopping systems shall have hopping channel carrier frequencies separated by a minimum of 25kHz or the 20 dB bandwidth of the hopping channel, whichever is greater.

### TEST CONFIGURATION

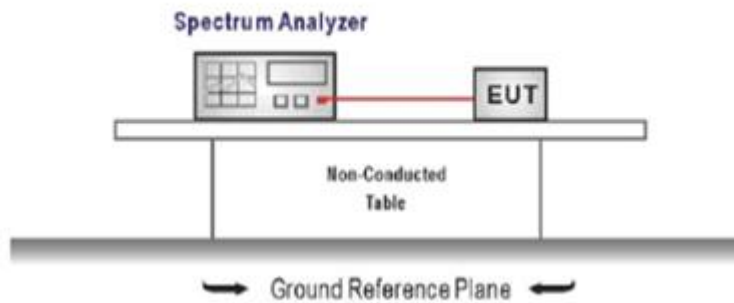

### TEST PROCEDURE

1. The transmitter output was connected to the spectrum analyzer through an attenuator, the path loss was compensated to the results for each measurement.
2. Set to the maximum power setting and enable the EUT transmit continuously
3. Use the following spectrum analyzer settings:  
Span = wide enough to capture the peaks of two adjacent channels  
RBW  $\geq$  1% of the span, VBW  $\geq$  RBW  
Sweep = auto, Detector function = peak, Trace = max hold
4. Measure and record the results in the test report.

### TEST MODE:

Please refer to the clause 4.3

### TEST RESULTS

Passed       Not Applicable

### TEST Data

Please refer to appendix D on the appendix report

## 5.7. Hopping Channel Number

### LIMIT

#### **FCC CFR Title 47 Part 15 Subpart C Section 15.247 (a)(1):**

For frequency hopping systems operating in the 902-928 MHz band: if the 20 dB bandwidth of the hopping channel is less than 250 kHz, the system shall use at least 50 hopping frequencies and the average time of occupancy on any frequency shall not be greater than 0.4 seconds within a 20 second period; if the 20 dB bandwidth of the hopping channel is 250 kHz or greater, the system shall use at least 25 hopping frequencies and the average time of occupancy on any frequency shall not be greater than 0.4 seconds within a 10 second period.

### TEST CONFIGURATION

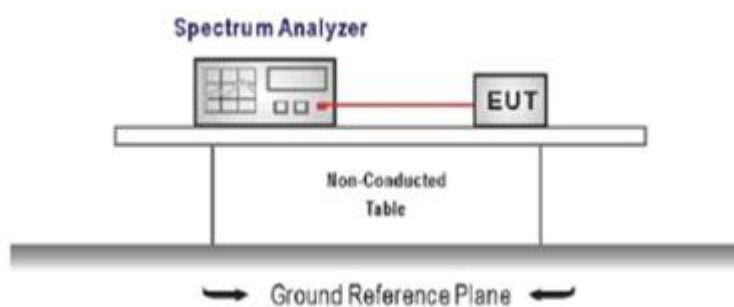

### TEST PROCEDURE

1. The transmitter output was connected to the spectrum analyzer through an attenuator, the path loss was compensated to the results for each measurement.
2. Set to the maximum power setting and enable the EUT transmit continuously
3. Use the following spectrum analyzer settings:  
Span = the frequency band of operation  
RBW  $\geq$  1% of the span, VBW  $\geq$  RBW  
Sweep = auto, Detector function = peak, Trace = max hold
4. Measure and record the results in the test report.

### TEST MODE:

Please refer to the clause 4.3

### TEST RESULTS

Passed       Not Applicable

### TEST Data

Please refer to appendix E on the appendix report

## 5.8. Dwell Time

### LIMIT

For frequency hopping systems operating in the 902-928 MHz band: if the 20 dB bandwidth of the hopping channel is less than 250 kHz, the system shall use at least 50 hopping frequencies and the average time of occupancy on any frequency shall not be greater than 0.4 seconds within a 20 second period; if the 20 dB bandwidth of the hopping channel is 250 kHz or greater, the system shall use at least 25 hopping frequencies and the average time of occupancy on any frequency shall not be greater than 0.4 seconds within a 10 second period..

### TEST CONFIGURATION

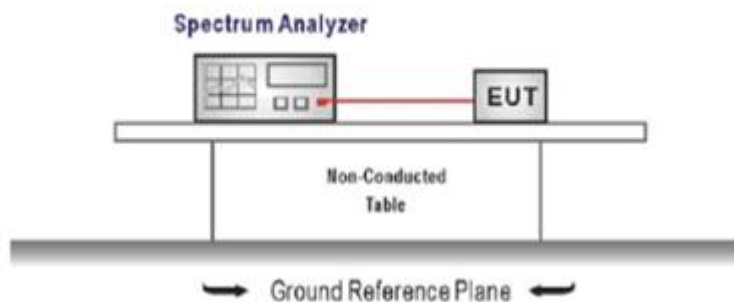

### TEST PROCEDURE

1. The transmitter output was connected to the spectrum analyzer through an attenuator, the path loss was compensated to the results for each measurement.
2. Set to the maximum power setting and enable the EUT transmit continuously
3. Use the following spectrum analyzer settings:  
Span = zero span, centered on a hopping channel, RBW= 1 MHz, VBW  $\geq$  RBW  
Sweep = as necessary to capture the entire dwell time per hopping channel,  
Detector function = peak, Trace = max hold
4. Measure and record the results in the test report.

### TEST MODE:

Please refer to the clause 4.3

### TEST RESULTS

Passed       Not Applicable

### TEST Data

Please refer to appendix F on the appendix report

## 5.9. Duty Cycle Correction Factor (DCCF)

### LIMIT

N/A

### TEST CONFIGURATION

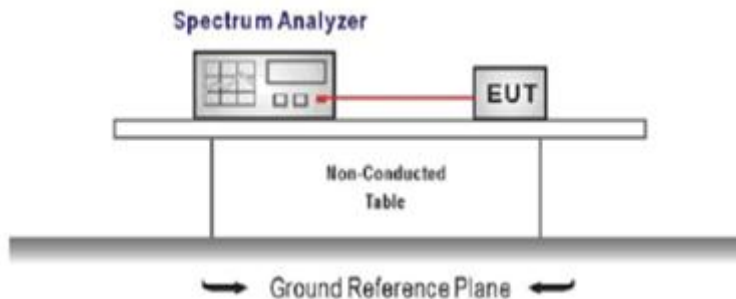

### TEST PROCEDURE

1. The transmitter output was connected to the spectrum analyzer through an attenuator, the path loss was compensated to the results for each measurement.
2. Set to the maximum power setting and enable the EUT transmit continuously
3. Use the following spectrum analyzer settings:  
Span = zero span, centered on a hopping channel, RBW= 1 MHz, VBW  $\geq$  RBW  
Sweep = as necessary to capture the entire dwell time per hopping channel,  
Detector function = peak, Trigger mode
4. Measure and record the duty cycle data

### TEST MODE:

Please refer to the clause 4.3

### TEST Data

Please refer to appendix G on the appendix report

## 5.10. Pseudorandom Frequency Hopping Sequence

### LIMIT

For frequency hopping systems operating in the 902-928 MHz band: if the 20 dB bandwidth of the hopping channel is less than 250 kHz, the system shall use at least 50 hopping frequencies and the average time of occupancy on any frequency shall not be greater than 0.4 seconds within a 20 second period; if the 20 dB bandwidth of the hopping channel is 250 kHz or greater, the system shall use at least 25 hopping frequencies and the average time of occupancy on any frequency shall not be greater than 0.4 seconds within a 10 second period. The maximum allowed 20 dB bandwidth of the hopping channel is 500 kHz

### TEST RESULTS

The pseudorandom frequency hopping sequence may be generated in a nine-stage shift register whose 5<sup>th</sup> and 9<sup>th</sup> stage outputs are added in a modulo-two addition stage. And the result is fed back to the input of the first stage. The sequence begins with the first one of 9 consecutive ones, for example: the shift register is initialized with nine ones.

- Number of shift register stages: 9
- Length of pseudo-random sequence:  $2^9 - 1 = 511$  bits
- Longest sequence of zeros: 8 (non-inverted signal)

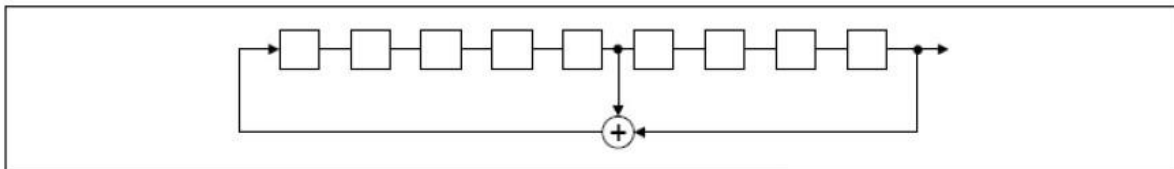

*Linear Feedback Shift Register for Generation of the PRBS sequence*

An example of pseudorandom frequency hopping sequence as follows:

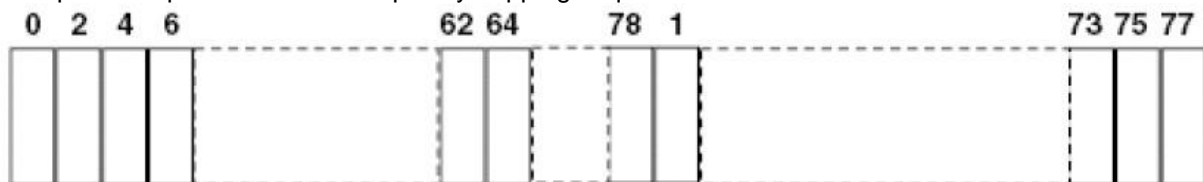

Each frequency used equally one the average by each transmitter.

The system receiver have input bandwidths that match the hopping channel bandwidths of their corresponding transmitter and shift frequencies in synchronization with the transmitted signals.

## 5.11. Conducted Band edge and Spurious Emission

### LIMIT

**FCC CFR Title 47 Part 15 Subpart C Section 15.247 (d):** In any 100 kHz bandwidth outside the frequency band in which the spread spectrum intentional radiator is operating, the radio frequency power that is produced by the intentional radiator shall be at least 20 dB below that in the 100 kHz bandwidth within the band that contains the highest level of the desired power, based on either an RF conducted or a radiated measurement.

### TEST CONFIGURATION

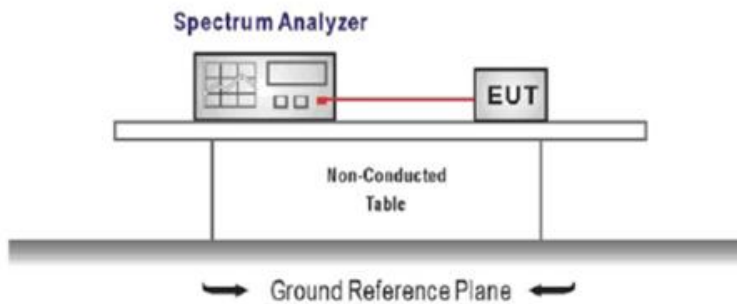

### TEST PROCEDURE

1. Connect the antenna port(s) to the spectrum analyzer input.
2. Emission level measurement  
Set the center frequency and span to encompass frequency range to be measured  
RBW = 100 kHz, VBW  $\geq 3 \times$  RBW  
Detector = peak, Sweep time = auto couple, Trace mode = max hold  
Allow trace to fully stabilize  
Use the peak marker function to determine the maximum amplitude level.
3. Place the radio in continuous transmit mode, allow the trace to stabilize, view the transmitter waveform on the spectrum analyzer.
4. Ensure that the amplitude of all unwanted emission outside of the authorized frequency band excluding restricted frequency bands) are attenuated by at least the minimum requirements specified (at least 20 dB relative to the maximum in-band peak PSD level in 100 kHz). Report the three highest emission relative to the limit.

### TEST MODE:

Please refer to the clause 4.3

**TEST RESULT**

**Passed**       **Not Applicable**

**TEST Data**

Please refer to appendix H on the appendix report



## 5.12. Radiated Band edge Emission

### LIMIT

#### **FCC CFR Title 47 Part 15 Subpart C Section 15.247 (d):**

In any 100 kHz bandwidth outside the frequency band in which the spread spectrum or digitally modulated intentional radiator is operating, Radiated Emissions which fall in the restricted bands, as defined in §15.205(a), must also comply with the Radiated Emissions limits specified in §15.209(a) (see §15.205(c)).

### TEST CONFIGURATION

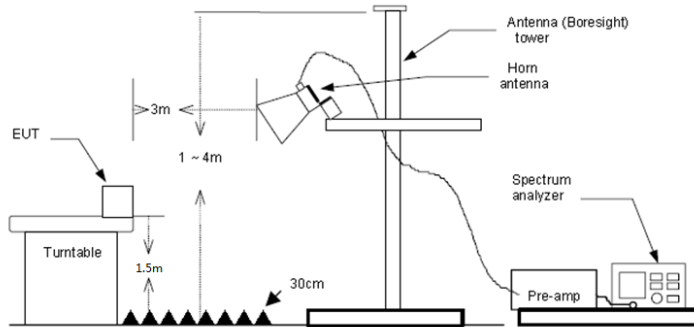

### TEST PROCEDURE

1. The EUT was setup and tested according to ANSI C63.10 .
2. The EUT is placed on a turn table which is 1.5 meter above ground. The turn table is rotated 360 degrees to determine the position of the maximum emission level.
3. The EUT was positioned such that the distance from antenna to the EUT was 3 meters.
4. The antenna is scanned from 1 meter to 4 meters to find out the maximum emission level. This is repeated for both horizontal and vertical polarization of the antenna. In order to find the maximum emission, all of the interface cables were manipulated according to ANSI C63.10 on radiated measurement.
5. Use the following spectrum analyzer settings:
  - a) Span shall wide enough to fully capture the emission being measured
  - b) Set RBW=100kHz for <1GHz, VBW=3\*RBW, Sweep time=auto, Detector=peak, Trace=max hold
  - c) Set RBW=1MHz, VBW=3MHz for >1GHz, Sweep time=auto, Detector=peak, Trace=max hold for Peak measurement

For average measurement: use duty cycle correction factor method (DCCF)  
 Averager level = Peak level + DCCF

### TEST MODE:

Please refer to the clause 4.3

### TEST RESULT

Passed       Not Applicable

Note:

- 1) Level= Reading + Factor; Factor =Antenna Factor+ Cable Loss- Preamp Factor
- 2) Over Limit = Level- Limit
- 3) Average measurement was not performed if peak level is lower than average limit(54 dBuV/m).

| Test channel: |                  | CH-L              |               | Polarity    |              |                 | Horizontal      |               |        |
|---------------|------------------|-------------------|---------------|-------------|--------------|-----------------|-----------------|---------------|--------|
| Mark          | Frequency<br>MHz | Reading<br>dBuV/m | Antenna<br>dB | Cable<br>dB | Preamp<br>dB | Level<br>dBuV/m | Limit<br>dBuV/m | Over<br>limit | Remark |
| 1             | 902.00           | 50.83             | 22.60         | 9.83        | 29.47        | 53.79           | 81.24           | -27.45        | Peak   |
| 2             | 902.23           | 98.28             | 22.60         | 9.83        | 29.47        | 101.24          |                 |               |        |
| Test channel: |                  | CH-L              |               | Polarity    |              |                 | Vertical        |               |        |
| Mark          | Frequency<br>MHz | Reading<br>dBuV/m | Antenna<br>dB | Cable<br>dB | Preamp<br>dB | Level<br>dBuV/m | Limit<br>dBuV/m | Over<br>limit | Remark |
| 1             | 902.00           | 40.87             | 22.60         | 9.83        | 29.47        | 43.83           | 71.81           | -27.98        | Peak   |
| 2             | 902.28           | 88.85             | 22.60         | 9.83        | 29.47        | 91.81           |                 |               |        |

| Test channel: |                  | CH-H              |               | Polarity    |              |                 | Horizontal      |               |        |
|---------------|------------------|-------------------|---------------|-------------|--------------|-----------------|-----------------|---------------|--------|
| Mark          | Frequency<br>MHz | Reading<br>dBuV/m | Antenna<br>dB | Cable<br>dB | Preamp<br>dB | Level<br>dBuV/m | Limit<br>dBuV/m | Over<br>limit | Remark |
| 1             | 914.93           | 97.96             | 22.61         | 9.89        | 29.41        | 101.05          |                 |               |        |
| 2             | 928.00           | 28.94             | 22.63         | 9.96        | 29.36        | 32.17           | 81.05           | -48.88        | Peak   |
| Test channel: |                  | CH-H              |               | Polarity    |              |                 | Vertical        |               |        |
| Mark          | Frequency<br>MHz | Reading<br>dBuV/m | Antenna<br>dB | Cable<br>dB | Preamp<br>dB | Level<br>dBuV/m | Limit<br>dBuV/m | Over<br>limit | Remark |
| 1             | 914.88           | 88.78             | 22.61         | 9.89        | 29.41        | 91.87           |                 |               |        |
| 2             | 928.00           | 28.43             | 22.63         | 9.96        | 29.36        | 31.66           | 71.87           | -40.21        | Peak   |

NOTE: The limit is calculated by 20dB down from fundamental peak

### 5.13. Radiated Spurious Emission

**LIMIT**

**FCC CFR Title 47 Part 15 Subpart C Section 15.209**

| Frequency            | Limit (dBuV/m)    | Value      |
|----------------------|-------------------|------------|
| 0.009 MHz ~0.49 MHz  | 2400/F(kHz) @300m | Quasi-peak |
| 0.49 MHz ~ 1.705 MHz | 24000/F(kHz) @30m | Quasi-peak |
| 1.705 MHz ~30 MHz    | 30 @30m           | Quasi-peak |

Note: Limit dBuV/m @3m = Limit dBuV/m @300m + 40\*log(300/3)= Limit dBuV/m @300m +80,

Limit dBuV/m @3m = Limit dBuV/m @30m +40\*log(30/3)= Limit dBuV/m @30m + 40.

| Frequency     | Limit (dBuV/m @3m) | Value      |
|---------------|--------------------|------------|
| 30MHz~88MHz   | 40.00              | Quasi-peak |
| 88MHz~216MHz  | 43.50              | Quasi-peak |
| 216MHz~960MHz | 46.00              | Quasi-peak |
| 960MHz~1GHz   | 54.00              | Quasi-peak |
| Above 1GHz    | 54.00              | Average    |
|               | 74.00              | Peak       |

**TEST CONFIGURATION**

- 9 kHz ~ 30 MHz

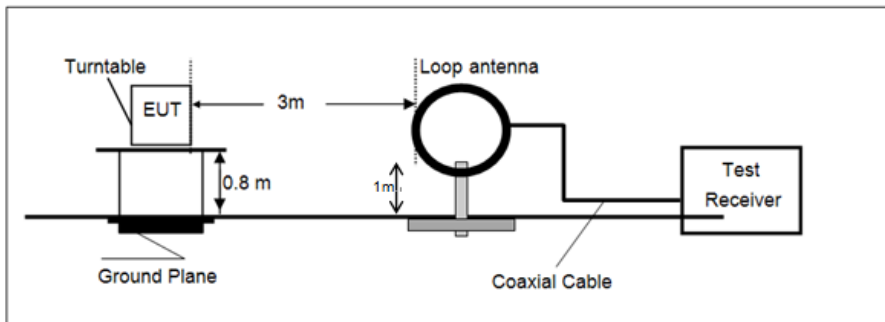

- 30 MHz ~ 1 GHz

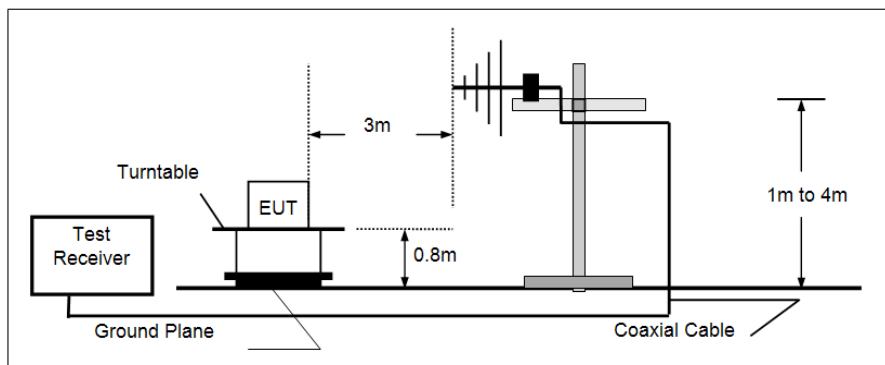

- Above 1 GHz

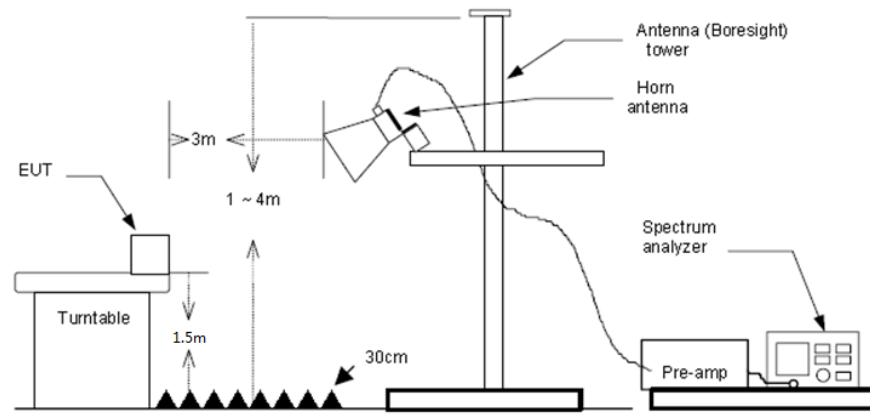

### **TEST PROCEDURE**

1. The EUT was setup and tested according to ANSI C63.10 .
2. The EUT is placed on a turn table which is 0.8 meter above ground for below 1 GHz, and 1.5 m for above 1 GHz. The turn table is rotated 360 degrees to determine the position of the maximum emission level.
3. The EUT was set 3 meters from the receiving antenna, which was mounted on the top of a variable height antenna tower.
4. For each suspected emission, the EUT was arranged to its worst case and then tune the Antenna tower (from 1 m to 4 m) and turntable (from 0 degree to 360 degrees) to find the maximum reading. A pre-amp and a high pass filter are used for the test in order to get better signal level to comply with the guidelines.
5. Set to the maximum power setting and enable the EUT transmit continuously.
6. Use the following spectrum analyzer settings
  - a) Span shall wide enough to fully capture the emission being measured;
  - b) Below 1 GHz:
    - RBW=120 kHz, VBW=300 kHz, Sweep=auto, Detector function=peak, Trace=max hold;
    - If the emission level of the EUT measured by the peak detector is 3 dB lower than the applicable limit, the peak emission level will be reported. Otherwise, the emission measurement will be repeated using the quasi-peak detector and reported.
  - c) Set RBW=1MHz, VBW=3MHz for >1GHz, Sweep time=auto, Detector=peak, Trace=max hold for Peak measurement

For average measurement: use duty cycle correction factor method (DCCF)  
 Averager level = Peak level + DCCF

### **TEST MODE:**

Please refer to the clause 4.3

### **TEST RESULT**

**Passed**       **Not Applicable**

Note:

- 1) Level= Reading + Factor/Transd; Factor/Transd =Antenna Factor+ Cable Loss- Preamp Factor
- 2) Over Limit = Level- Limit
- 3) Average measurement was not performed if peak level is lower than average limit(54 dBuV/m) for above 1GHz.

**TEST DATA FOR 9 kHz ~ 30 MHz**

The EUT was pre-scanned this frequency band, found the radiated level 20dB lower than the limit, so don't show data on this report.

**TEST DATA FOR 30 MHz ~ 1000 MHz**

Have pre-scan all test channel, found CH-L which it was worst case, so only show the worst case's data on this report.

Polarization:

Horizontal

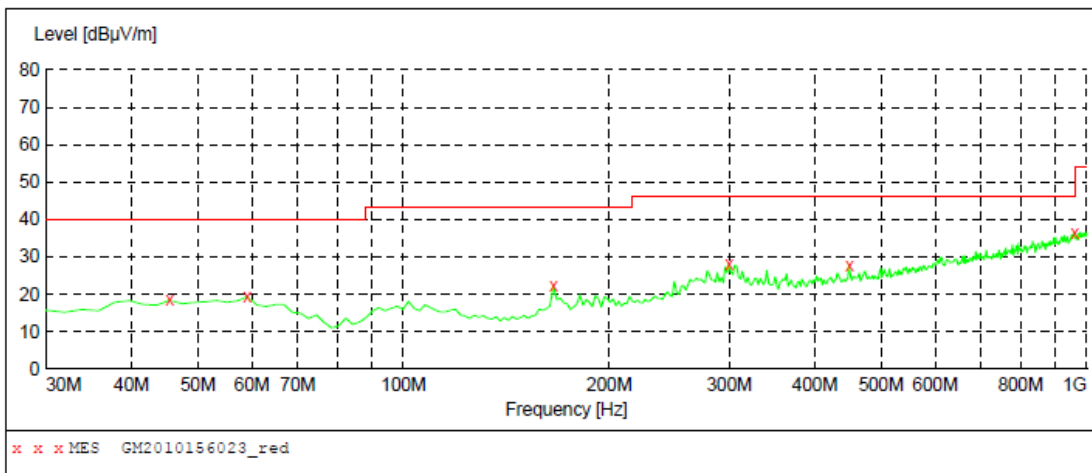

**MEASUREMENT RESULT: "GM2010156023\_red"**

10/15/2020 1:28PM

| Frequency<br>MHz | Level<br>dBµV/m | Transd<br>dB | Limit<br>dBµV/m | Margin<br>dB | Det. | Height<br>cm | Azimuth<br>deg | Polarization |
|------------------|-----------------|--------------|-----------------|--------------|------|--------------|----------------|--------------|
| 45.520000        | 18.40           | -8.2         | 40.0            | 21.6         | QP   | 100.0        | 38.00          | HORIZONTAL   |
| 59.100000        | 19.40           | -8.9         | 40.0            | 20.6         | QP   | 100.0        | 341.00         | HORIZONTAL   |
| 165.800000       | 22.20           | -12.3        | 43.5            | 21.3         | QP   | 100.0        | 176.00         | HORIZONTAL   |
| 299.660000       | 28.00           | -6.1         | 46.0            | 18.0         | QP   | 100.0        | 329.00         | HORIZONTAL   |
| 449.040000       | 27.90           | -2.1         | 46.0            | 18.1         | QP   | 100.0        | 290.00         | HORIZONTAL   |
| 959.260000       | 36.30           | 8.9          | 46.0            | 9.7          | QP   | 100.0        | 139.00         | HORIZONTAL   |

Polarization:

Vertical

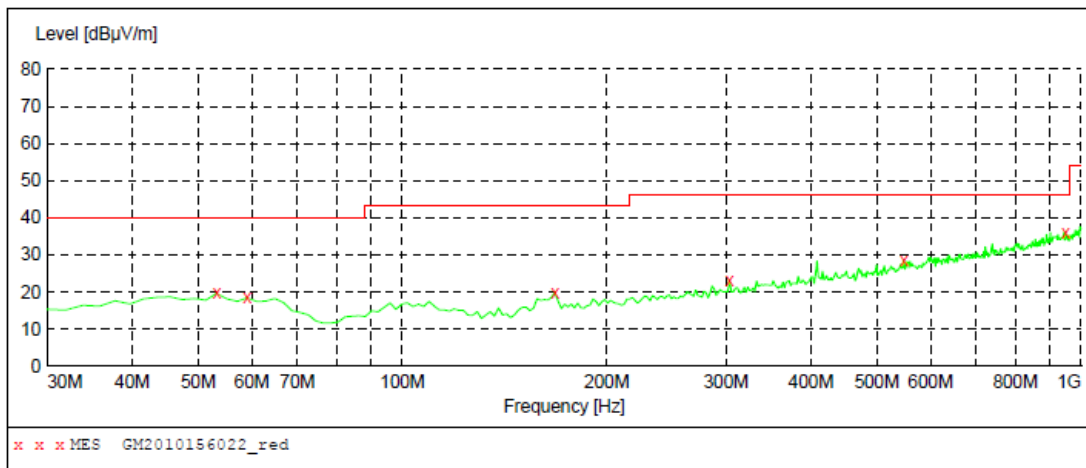

**MEASUREMENT RESULT: "GM2010156022\_red"**

10/15/2020 1:25PM

| Frequency<br>MHz | Level<br>dBµV/m | Transd<br>dB | Limit<br>dBµV/m | Margin<br>dB | Det. | Height<br>cm | Azimuth<br>deg | Polarization |
|------------------|-----------------|--------------|-----------------|--------------|------|--------------|----------------|--------------|
| 53.280000        | 19.70           | -8.3         | 40.0            | 20.3         | QP   | 100.0        | 3.00           | VERTICAL     |
| 59.100000        | 18.50           | -8.9         | 40.0            | 21.5         | QP   | 100.0        | 350.00         | VERTICAL     |
| 167.740000       | 19.90           | -12.3        | 43.5            | 23.6         | QP   | 100.0        | 313.00         | VERTICAL     |
| 303.540000       | 23.10           | -6.2         | 46.0            | 22.9         | QP   | 100.0        | 39.00          | VERTICAL     |
| 547.980000       | 28.50           | 0.4          | 46.0            | 17.5         | QP   | 100.0        | 27.00          | VERTICAL     |
| 947.620000       | 36.20           | 8.7          | 46.0            | 9.8          | QP   | 100.0        | 3.00           | VERTICAL     |

NOTE: For blocking the fundamental A Notch filter was used in the testing



**TEST DATA FOR 1 GHz ~ 25 GHz**

| Test channel |                  | CH-L              |               |             | Polarity     |                 | Horizontal      |               |        |
|--------------|------------------|-------------------|---------------|-------------|--------------|-----------------|-----------------|---------------|--------|
| Mark         | Frequency<br>MHz | Reading<br>dBuV/m | Antenna<br>dB | Cable<br>dB | Preamp<br>dB | Level<br>dBuV/m | Limit<br>dBuV/m | Over<br>limit | Remark |
| 1            | 2195.85          | 33.64             | 28.16         | 7.19        | 37.41        | 31.58           | 74.00           | -42.42        | Peak   |
| 2            | 3607.26          | 34.87             | 29.40         | 10.08       | 36.96        | 37.39           | 74.00           | -36.61        | Peak   |
| 3            | 5022.19          | 32.41             | 32.03         | 11.54       | 35.30        | 40.68           | 74.00           | -33.32        | Peak   |
| 4            | 6347.47          | 31.80             | 33.09         | 13.35       | 34.61        | 43.63           | 74.00           | -30.37        | Peak   |

| Test channel |                  | CH-L              |               |             | Polarity     |                 | Vertical        |               |        |
|--------------|------------------|-------------------|---------------|-------------|--------------|-----------------|-----------------|---------------|--------|
| Mark         | Frequency<br>MHz | Reading<br>dBuV/m | Antenna<br>dB | Cable<br>dB | Preamp<br>dB | Level<br>dBuV/m | Limit<br>dBuV/m | Over<br>limit | Remark |
| 1            | 2113.59          | 35.55             | 27.26         | 7.02        | 37.27        | 32.56           | 74.00           | -41.44        | Peak   |
| 2            | 2987.92          | 47.04             | 28.70         | 8.44        | 37.47        | 46.71           | 74.00           | -27.29        | Peak   |
| 3            | 4512.97          | 33.72             | 30.83         | 10.68       | 36.30        | 38.93           | 74.00           | -35.07        | Peak   |
| 4            | 6299.18          | 31.31             | 33.00         | 13.57       | 34.56        | 43.32           | 74.00           | -30.68        | Peak   |

| Test channel |                  | CH-M              |               |             | Polarity     |                 | Horizontal      |               |        |
|--------------|------------------|-------------------|---------------|-------------|--------------|-----------------|-----------------|---------------|--------|
| Mark         | Frequency<br>MHz | Reading<br>dBuV/m | Antenna<br>dB | Cable<br>dB | Preamp<br>dB | Level<br>dBuV/m | Limit<br>dBuV/m | Over<br>limit | Remark |
| 1            | 2241.03          | 33.46             | 28.12         | 7.22        | 37.42        | 31.38           | 74.00           | -42.62        | Peak   |
| 2            | 3634.91          | 34.71             | 29.40         | 9.99        | 37.00        | 37.10           | 74.00           | -36.90        | Peak   |
| 3            | 5034.99          | 32.64             | 32.11         | 11.52       | 35.34        | 40.93           | 74.00           | -33.07        | Peak   |
| 4            | 6662.01          | 31.67             | 34.30         | 13.58       | 34.52        | 45.03           | 74.00           | -28.97        | Peak   |

| Test channel |                  | CH-M              |               |             | Polarity     |                 | Vertical        |               |        |
|--------------|------------------|-------------------|---------------|-------------|--------------|-----------------|-----------------|---------------|--------|
| Mark         | Frequency<br>MHz | Reading<br>dBuV/m | Antenna<br>dB | Cable<br>dB | Preamp<br>dB | Level<br>dBuV/m | Limit<br>dBuV/m | Over<br>limit | Remark |
| 1            | 2207.06          | 34.67             | 28.19         | 7.20        | 37.41        | 32.65           | 74.00           | -41.35        | Peak   |
| 2            | 2995.54          | 44.90             | 28.70         | 8.45        | 37.47        | 44.58           | 74.00           | -29.42        | Peak   |
| 3            | 3993.90          | 35.66             | 29.90         | 10.17       | 36.37        | 39.36           | 74.00           | -34.64        | Peak   |
| 4            | 4983.99          | 38.00             | 31.77         | 11.56       | 35.22        | 46.11           | 74.00           | -27.89        | Peak   |

| Test channel |                  | CH-H              |               |             | Polarity     |                 | Horizontal      |               |        |
|--------------|------------------|-------------------|---------------|-------------|--------------|-----------------|-----------------|---------------|--------|
| Mark         | Frequency<br>MHz | Reading<br>dBuV/m | Antenna<br>dB | Cable<br>dB | Preamp<br>dB | Level<br>dBuV/m | Limit<br>dBuV/m | Over<br>limit | Remark |
| 1            | 1213.44          | 36.38             | 25.68         | 5.14        | 36.63        | 30.57           | 74.00           | -43.43        | Peak   |
| 2            | 2218.32          | 33.19             | 28.16         | 7.21        | 37.41        | 31.15           | 74.00           | -42.85        | Peak   |
| 3            | 3662.78          | 35.63             | 29.40         | 9.90        | 37.02        | 37.91           | 74.00           | -36.09        | Peak   |
| 4            | 5588.88          | 33.02             | 31.88         | 12.39       | 35.18        | 42.11           | 74.00           | -31.89        | Peak   |

| Test channel |                  | CH-H              |               |             | Polarity     |                 | Vertical        |               |        |
|--------------|------------------|-------------------|---------------|-------------|--------------|-----------------|-----------------|---------------|--------|
| Mark         | Frequency<br>MHz | Reading<br>dBuV/m | Antenna<br>dB | Cable<br>dB | Preamp<br>dB | Level<br>dBuV/m | Limit<br>dBuV/m | Over<br>limit | Remark |
| 1            | 2246.74          | 34.91             | 28.11         | 7.22        | 37.42        | 32.82           | 74.00           | -41.18        | Peak   |
| 2            | 2995.54          | 44.03             | 28.70         | 8.45        | 37.47        | 43.71           | 74.00           | -30.29        | Peak   |
| 3            | 3993.90          | 35.66             | 29.90         | 10.17       | 36.37        | 39.36           | 74.00           | -34.64        | Peak   |
| 4            | 4996.69          | 35.93             | 31.87         | 11.57       | 35.24        | 44.13           | 74.00           | -29.87        | Peak   |

## 6. TEST SETUP PHOTOS

Radiated Emission



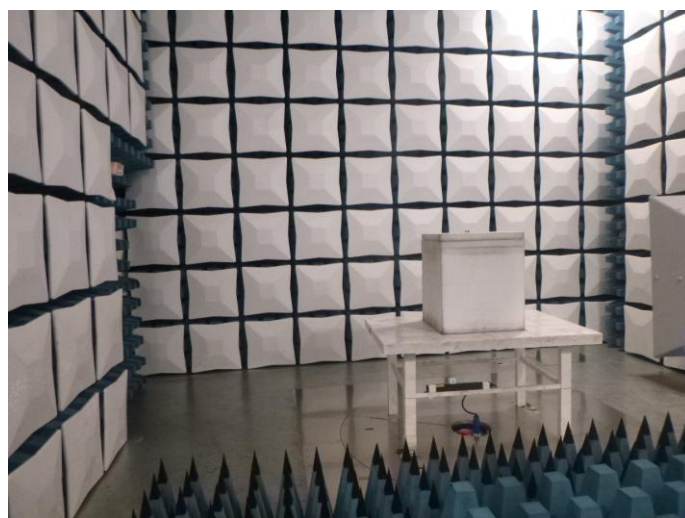

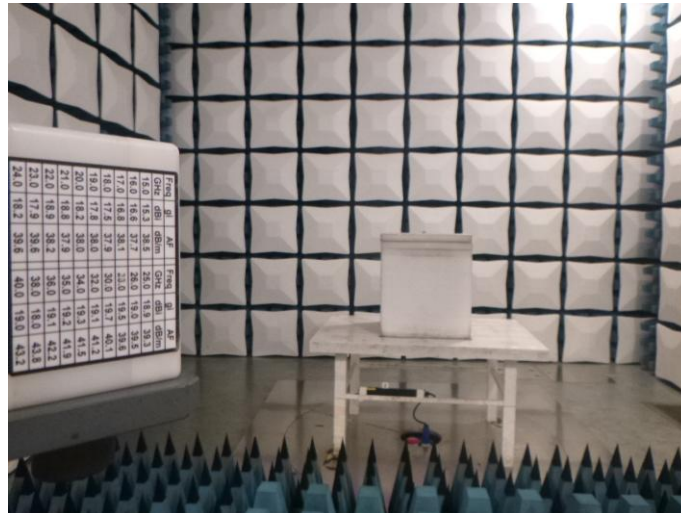

## AC Conducted Emission

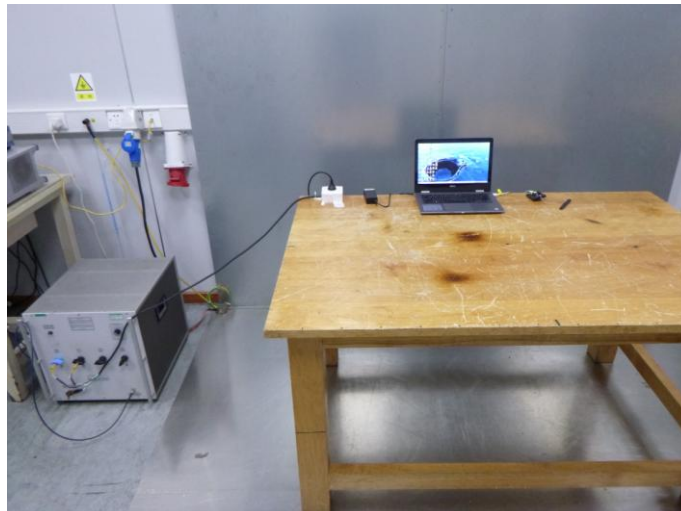

## 7. EXTERANAL AND INTERNAL PHOTOS

Reference to the test report No. : CHTEW20120030.

## 8. APPENDIX REPORT