



FCC TEST REPORT

FCC ID: 2AN8N-CDRZ14

Product Name:	Wireless Charger
Trademark:	Humixx
Model Number:	CDRZ14
Prepared For :	Shenzhen Hui Yu E-Commerce Co., Ltd.
Address :	No.150-3 Hao 209, Jinyun Road, Buji Street, Longgang Distric, shenzhen, Guangdong, 518116, China
Prepared By :	Shenzhen BCTC Testing Co., Ltd.
Address :	BCTC Building & 1-2F, East of B Building, Pengzhou Industrial, Fuyuan 1st Road, Qiaotou Community, Fuyong Street, Bao'an District, Shenzhen, China
Test Date:	Jan. 29 - Feb. 05, 2018
Date of Report :	Feb. 29, 2018
Report No.:	BCTC-FY180100398-1E



TABLE OF CONTENTS

TEST REPORT DECLARATION	3
1.GENERAL INFORMATION	4
1.1. Report information.....	4
1.2. Measurement Uncertainty.....	4
1.3. Test Facility.....	4
1.4. Test Uncertainty.....	4
2.PRODUCT DESCRIPTION	5
2.1. EUT Description.....	5
2.2. Block Diagram of EUT Configuration.....	5
2.3. Test Conditions.....	5
2.4. Description Of Support Units (Conducted Mode)	6
3.TEST RESULTS SUMMARY	6
4.TEST EQUIPMENT USED	7
4.1. For Conducted Emission Test.....	7
4.2. For Radiated Emission Measurement.....	7
5.CONDUCTED EMISSION TEST	8
5.1. Block Diagram of Test Setup	8
5.2. Test Standard.....	8
5.3. Conducted Emission Limit.....	8
5.4. EUT Configuration on Test.....	8
5.5. Operating Condition of EUT	9
5.6. Test Procedure.....	9
5.7. Test Result.....	9
6.RADIATED EMISSION MEASUREMENT	14
6.1. Block Diagram of Test Setup	14
6.2. Test Standard.....	14
6.3. EMI Test Receiver Setup	14
6.4. Test Procedure.....	15
6.5. Test Result.....	15
7. EUT TEST PHOTOS.....	21
8. EUT PHOTOS	23



TEST REPORT DECLARATION

Applicant : Shenzhen Hui Yu E-Commerce Co., Ltd.
Address : No.150-3 Hao 209, Jinyun Road, Buji Street, Longgang Distric, shenzhen, Guangdong, 518116, China
EUT Description : Wireless Charger
Model Number CDRZ14

Test Standards:

FCC Part 15 C: 2015

This device described above has been tested by BCTC, and the test results show that the equipment under And it is applicable only to the tested sample identified in the report.

This report shall not be reproduced except in full, without the written approval of BCTC, this document may be altered or revised by BCTC, personal only, and shall be noted in the revision of the document.

Prepared by(Engineer): Eric Yang
Reviewer(Supervisor): Jade Yang
Approved(Manager): Carson Zhang

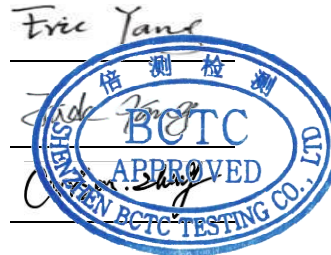



1. GENERAL INFORMATION

1.1. Report information

- 1.1.1. This report is not a certificate of quality; it only applies to the sample of the specific product/equipment given at the time of its testing. The results are not used to indicate or imply that they are application to the similar items. In addition, such results must not be used to indicate or imply that BCTC approves recommends or endorses the manufacture, supplier or use of such product/equipment, or that BCTC in any way guarantees the later performance of the product/equipment.
- 1.1.2. The sample/s mentioned in this report is/are supplied by Applicant, BCTC therefore assumes no responsibility for the accuracy of information on the brand name, model number, origin of manufacture or any information supplied.
- 1.1.3. Additional copies of the report are available to the Applicant at an additional fee. No third part can obtain a copy of this report through BCTC, unless the applicant has authorized BCTC in writing to do so.

1.2. Measurement Uncertainty

Available upon request.

1.3. Test Facility

Site Description
Name of Firm : Shenzhen BCTC Testing Co., Ltd.

Site Location : BCTC Building & 1-2F, East of B Building,
Pengzhou Industrial, Fuyuan 1st Road, Qiaotou
Community, Fuyong Street, Bao'an District,
Shenzhen, China

1.4. Test Uncertainty

Conducted Emission = ± 2.66 dB
Uncertainty
Radiated Emission Uncertainty = ± 4.15 dB

2. PRODUCT DESCRIPTION

2.1.EUT Description

Description : **Wireless Charger**

Applicant : **Shenzhen Hui Yu E-Commerce Co., Ltd.**
No.150-3 Hao 209, Jinyun Road, Buji Street, Longgang Distric,
shenzhen, Guangdong, 518116, China

Manufacturer : **Shenzhen Hui Yu E-Commerce Co., Ltd.**
No.150-3 Hao 209, Jinyun Road, Buji Street, Longgang Distric,
shenzhen, Guangdong, 518116, China

Trademark **Humixx**

Model Number : CDRZ14

Serial Model : N/A

Model : N/A

Difference

Power Supply Input: DC 5V2A/9V1.8A
Output: DC5V1A/9V1.5A

Work Frequency : 110-205KHz

2.2.Block Diagram of EUT Configuration

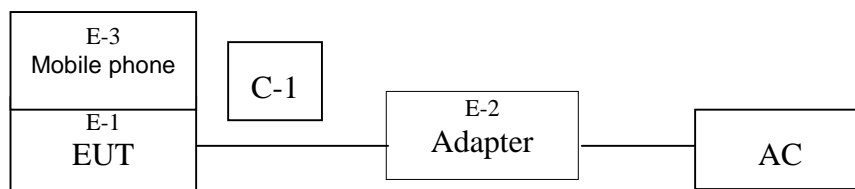

2.3.Test Conditions

Temperature: 23~25°C

Relative Humidity: 55~63 %



2.4. Description Of Support Units (Conducted Mode)

The EUT has been tested as an independent unit together with other necessary accessories or support units. The following support units or accessories were used to form a representative test configuration during the tests.

Item	Equipment	Mfr/Brand	Model/Type No.	Series No.	Note
E-1	Wireless Charger	Humixx	CDRZ14	N/A	EUT
E-2	Adapter	UGreen	CD122	N/A	AC100-240V 50/60Hz 500mA Output: 5V $\overline{\text{---}}$ 3A 9V $\overline{\text{---}}$ 2A, 12V $\overline{\text{---}}$ 1.5A
E-3	Mobile phone	N/A	Samsung Galaxy S7 edge	N/A	

Item	Shielded Type	Ferrite Core	Length	Note
C-1	NO	NO	0.8M	USB cable unshielded

Note:

- (1) The support equipment was authorized by Declaration of Confirmation.
- (2) For detachable type I/O cable should be specified the length in cm in 『Length』 column.
- (3) “YES” is means “shielded” “with core”; “NO” is means “unshielded” “without core”.

3. TEST RESULTS SUMMARY

Table 1 Test Results Summary

Test Items	Test Results
Conducted disturbance	Pass
Radiated disturbance	Pass

Remark: “N/A” means “Not applicable.”



4. TEST EQUIPMENT USED

4.1. For Conducted Emission Test

Item	Equipment	Manufacturer	Type No.	Serial No.	Last calibration	Calibrated until
1	Test Receiver	R&S	ESCI	1166.5950K03-1 01165-ha	2017.08.27	2018.08.26
2	LISN	SCHWARZBECK	NSLK8127	8127739	2017.08.27	2018.08.26
3	LISN	R&S	NSLK8126	8126487	2017.08.27	2018.08.26
4	RF cables	R&S	R204	R20X	2017.08.27	2018.08.26
5	Attenuator	R&S	ESH3-Z2	143206	2017.08.27	2018.08.26

4.2. For Radiated Emission Measurement

Item	Equipment	Manufacturer	Type No.	Serial No.	Last calibration	Calibrated until
5	Horn Antenna (14GHz-40GHz)	SCHWARZBECK	BBHA 9170	9170-181	2017.09.03	2018.09.02
6	Amplifier (9KHz-6GHz)	SCHWARZBECK	BBV9744	9744-0037	2017.08.27	2018.08.26
7	Amplifier (1GHz-18GHz)	SCHWARZBECK	BBV9718	9718-309	2017.08.27	2018.08.26
8	Amplifier (18GHz-40GHz)	SCHWARZBECK	BBV 9721	9721-205	2017.08.27	2018.08.26
9	Loop Antenna (9KHz-30MHz)	SCHWARZBECK	FMZB1519B	00014	2017.09.03	2018.09.02
10	RF cables1 (9kHz-1GHz)	R&S	R203	R20X	2017.08.27	2018.08.26
11	RF cables2 (1GHz-40GHz)	R&S	R204	R21X	2017.08.27	2018.08.26
12	Antenna connector	Florida RF Labs	N/A	RF 01#	2017.08.27	2018.08.26
13	Power Metter	ANRITSU	ML2487A	6K00001568	2017.08.27	2018.08.26
14	Power Sensor (AV)	ANRITSU	ML2491A	030989	2017.08.27	2018.08.26
15	Signal Analyzer 9kHz-26.5GHz	Agilent	N9010A	MY48030494	2017.08.27	2018.08.26
16	Test Receiver 20kHz-40GHz	R&S	ESU 40	100376	2017.08.27	2018.08.26
17	D.C. Power Supply	LongWei	PS-305D	010964729	2017.08.27	2018.08.26

5. CONDUCTED EMISSION TEST

5.1. Block Diagram of Test Setup

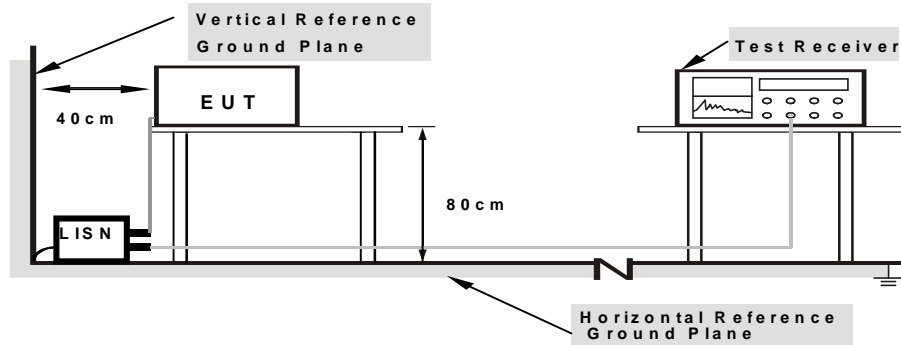

Note: 1.Support units were connected to second LISN.
 2.Both of LISNs (AMN) are 80 cm from EUT and at least 80 cm from other units and other metal planes

The setup of EUT is according with per ANSI C63.10-2013 measurement procedure. The specification used was with the FCC Part 15.207 limits.

(EUT: **Wireless Charger**)

5.2. Test Standard

FCC§15.207

5.3. Conducted Emission Limit

Frequency MHz	Limits dB(μV)	
	Quasi-peak Level	Average Level
0.15 ~ 0.50	66 ~ 56*	56 ~ 46*
0.50 ~ 5.00	56	46
5.00 ~ 30.00	60	50

Notes: 1. *Decreasing linearly with logarithm of frequency.

5.4. EUT Configuration on Test

The following equipments are installed on conducted emission test to meet FCC Part 15.207 requirement and operating in a manner, which tends to maximize its emission characteristics in a normal application.

5.4.1. milestone dual

Model Number: **CDRZ14**



5.5. Operating Condition of EUT

5.5.1. Setup the EUT and simulators as shown in Section 5.1.

5.5.2. Turn on the power of all equipments.

5.5.3. Let the EUT work in test modes (EUT Working) and test it.

5.6. Test Procedure

The EUT is put on a table of non-conducting material that is 80cm high. The vertical conducting wall of shielding is located 40cm to the rear of the EUT. The power line of the EUT is connected to the AC mains through a Artificial Mains Network (A.M.N.). A EMI test receiver (R&S Test Receiver ESHS30) is used to test the emissions form both sides of AC line. The bandwidth of EMI test receiver is set at 9kHz.

The bandwidth of the test receiver (R&S Test Receiver ESHS30) is set at 10KHz.

We pretest AC 120V and AC 240V, the worst voltage was AC 120V and the data recording in the report.

5.7. Test Result

PASS

Please refer to the following pages.



EUT:	Wireless Charger	Model Name :	CDRZ14
Temperature:	26 °C	Relative Humidity:	54%
Pressure:	1010hPa	Phase :	L
Test Voltage :	DC 5V For Adapter (adapter intpu:AC120V/60Hz)	Test Mode:	Normal Link

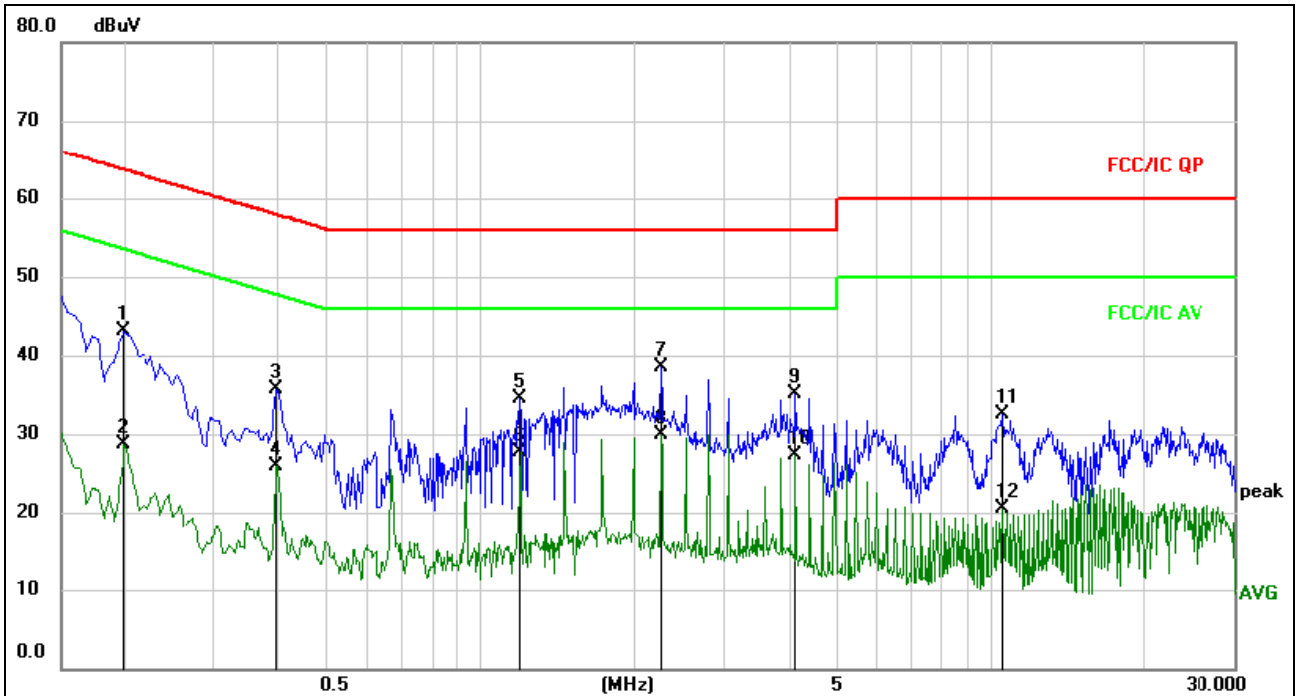

Remark:

1. All readings are Quasi-Peak and Average values.
2. Factor = Insertion Loss + Cable Loss.

No.	Mk.	Freq. MHz	Reading Level dBuV	Correct Factor dB	Measure- ment dBuV	Limit dBuV	Over dB	Detector	Comment
1		0.1995	33.39	9.65	43.04	63.63	-20.59	QP	
2		0.1995	19.06	9.65	28.71	53.63	-24.92	AVG	
3		0.3975	26.02	9.67	35.69	57.91	-22.22	QP	
4		0.3975	16.30	9.67	25.97	47.91	-21.94	AVG	
5		1.1940	24.78	9.69	34.47	56.00	-21.53	QP	
6		1.1940	18.06	9.69	27.75	46.00	-18.25	AVG	
7		2.2605	28.77	9.72	38.49	56.00	-17.51	QP	
8	*	2.2605	20.09	9.72	29.81	46.00	-16.19	AVG	
9		4.1235	25.37	9.73	35.10	56.00	-20.90	QP	
10		4.1235	17.56	9.73	27.29	46.00	-18.71	AVG	
11		10.5135	22.65	9.82	32.47	60.00	-27.53	QP	
12		10.5135	10.76	9.82	20.58	50.00	-29.42	AVG	



EUT:	Wireless Charger	Model Name. :	CDRZ14
Temperature:	26 °C	Relative Humidity:	54%
Pressure:	1010hPa	Phase :	N
Test Voltage :	DC 5V For Adapter (adapter intpu:AC120V/60Hz)	Test Mode:	Normal Link

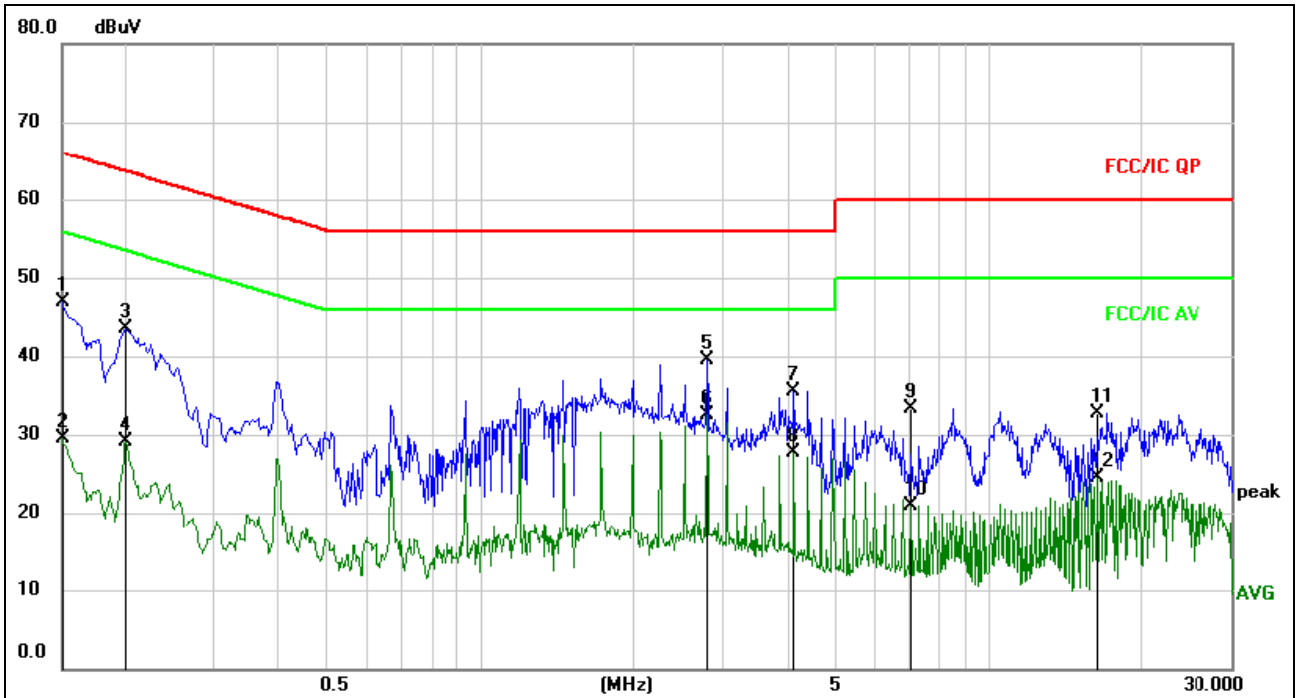

Remark:
 1. All readings are Quasi-Peak and Average values.
 2. Factor = Insertion Loss + Cable Loss.

No.	Mk.	Freq. MHz	Reading Level dBuV	Correct Factor dB	Measure- ment dBuV	Limit dBuV	Over dB	Detector	Comment
1		0.1500	37.24	9.67	46.91	66.00	-19.09	QP	
2		0.1500	19.88	9.67	29.55	56.00	-26.45	AVG	
3		0.1996	33.77	9.65	43.42	63.63	-20.21	QP	
4		0.1996	19.43	9.65	29.08	53.63	-24.55	AVG	
5		2.7869	29.71	9.72	39.43	56.00	-16.57	QP	
6	*	2.7869	22.77	9.72	32.49	46.00	-13.51	AVG	
7		4.1235	25.87	9.73	35.60	56.00	-20.40	QP	
8		4.1235	18.06	9.73	27.79	46.00	-18.21	AVG	
9		7.0485	23.42	9.80	33.22	60.00	-26.78	QP	
10		7.0485	11.16	9.80	20.96	50.00	-29.04	AVG	
11		16.3635	22.88	9.88	32.76	60.00	-27.24	QP	
12		16.3635	14.71	9.88	24.59	50.00	-25.41	AVG	



EUT:	Wireless Charger	Model Name :	CDRZ14
Temperature:	26 °C	Relative Humidity:	54%
Pressure:	1010hPa	Phase :	L
Test Voltage :	DC 9V For Adapter (adapter intpu:AC120V/60Hz)	Test Mode:	Charging

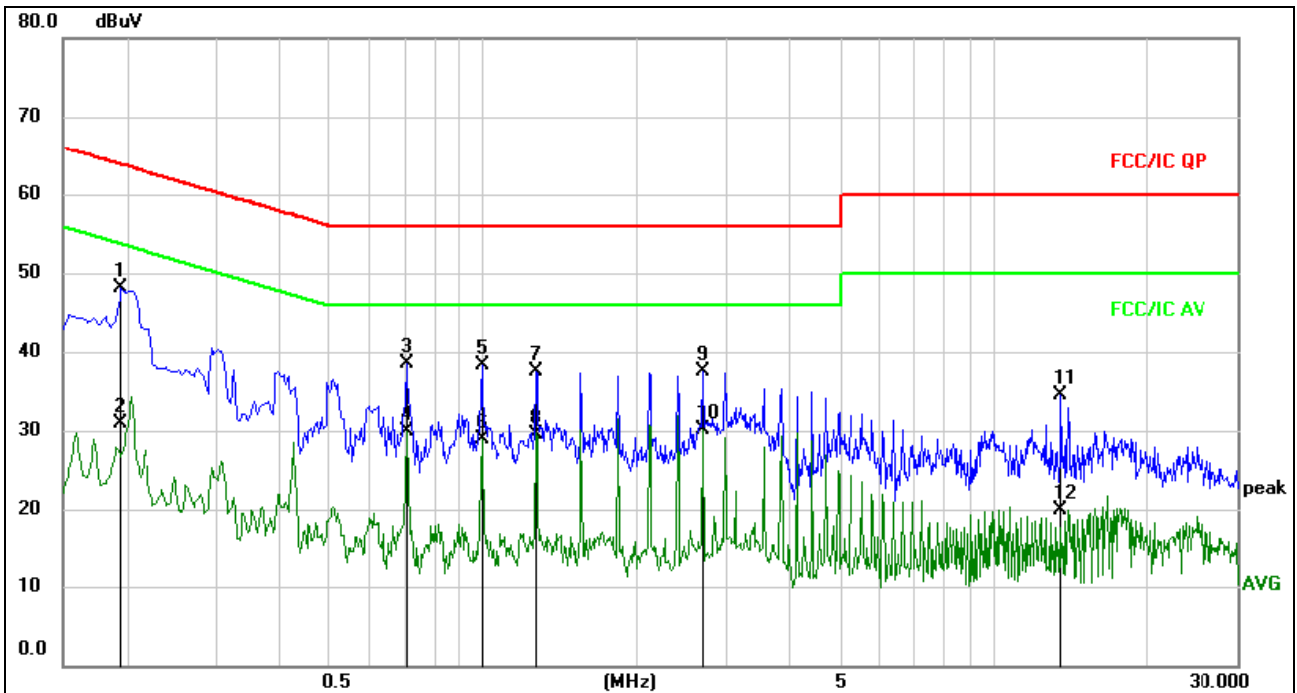

Remark:
 1. All readings are Quasi-Peak and Average values.
 2. Factor = Insertion Loss + Cable Loss.

No.	Mk.	Freq. MHz	Reading Level dBuV	Correct Factor dB	Measure- ment dBuV	Limit dBuV	Over dB	Detector	Comment
1	*	0.1949	38.41	9.65	48.06	63.83	-15.77	QP	
2		0.1949	21.19	9.65	30.84	53.83	-22.99	AVG	
3		0.7080	28.85	9.68	38.53	56.00	-17.47	QP	
4		0.7080	20.32	9.68	30.00	46.00	-16.00	AVG	
5		0.9915	28.56	9.69	38.25	56.00	-17.75	QP	
6		0.9915	19.16	9.69	28.85	46.00	-17.15	AVG	
7		1.2750	27.79	9.70	37.49	56.00	-18.51	QP	
8		1.2750	19.90	9.70	29.60	46.00	-16.40	AVG	
9		2.6880	27.85	9.72	37.57	56.00	-18.43	QP	
10		2.6880	20.48	9.72	30.20	46.00	-15.80	AVG	
11		13.4925	24.59	9.84	34.43	60.00	-25.57	QP	
12		13.4925	9.99	9.84	19.83	50.00	-30.17	AVG	



EUT:	Wireless Charger	Model Name :	CDRZ14
Temperature:	26 °C	Relative Humidity:	54%
Pressure:	1010hPa	Phase :	N
Test Voltage :	DC 9V For Adapter (adapter intpu:AC120V/60Hz)	Test Mode:	Charging

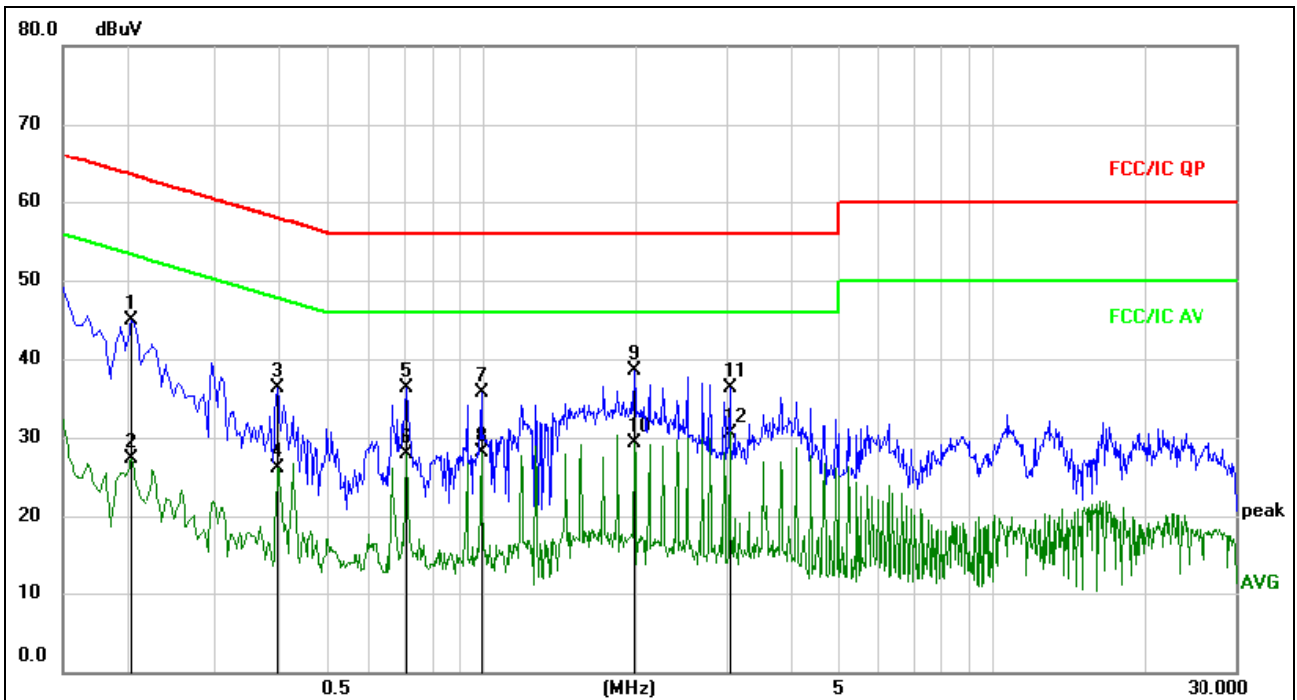

Remark:
 1. All readings are Quasi-Peak and Average values.
 2. Factor = Insertion Loss + Cable Loss.

No.	Mk.	Freq. MHz	Reading Level dBuV	Correct Factor dB	Measure- ment dBuV	Limit dBuV	Over dB	Detector	Comment
1		0.2040	35.34	9.65	44.99	63.45	-18.46	QP	
2		0.2040	17.74	9.65	27.39	53.45	-26.06	AVG	
3		0.3975	26.58	9.67	36.25	57.91	-21.66	QP	
4		0.3975	16.45	9.67	26.12	47.91	-21.79	AVG	
5		0.7080	26.65	9.68	36.33	56.00	-19.67	QP	
6		0.7080	18.26	9.68	27.94	46.00	-18.06	AVG	
7		0.9915	25.99	9.69	35.68	56.00	-20.32	QP	
8		0.9915	18.38	9.69	28.07	46.00	-17.93	AVG	
9		1.9905	28.77	9.71	38.48	56.00	-17.52	QP	
10		1.9905	19.69	9.71	29.40	46.00	-16.60	AVG	
11		3.0525	26.62	9.72	36.34	56.00	-19.66	QP	
12	*	3.0525	20.88	9.72	30.60	46.00	-15.40	AVG	

6. RADIATED EMISSION MEASUREMENT

6.1. Block Diagram of Test Setup

6.1.1. Block Diagram of connection between the EUT and the simulators

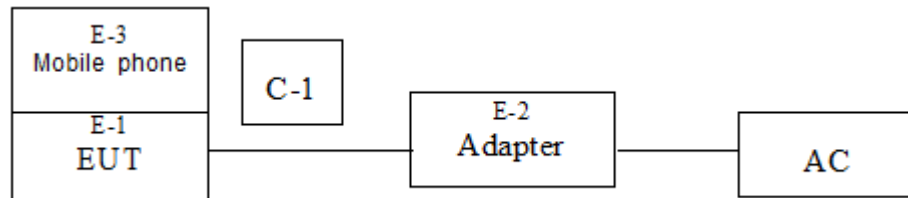

(EUT: **Wireless Charger**)

6.1.2. Anechoic Chamber Test Setup Diagram

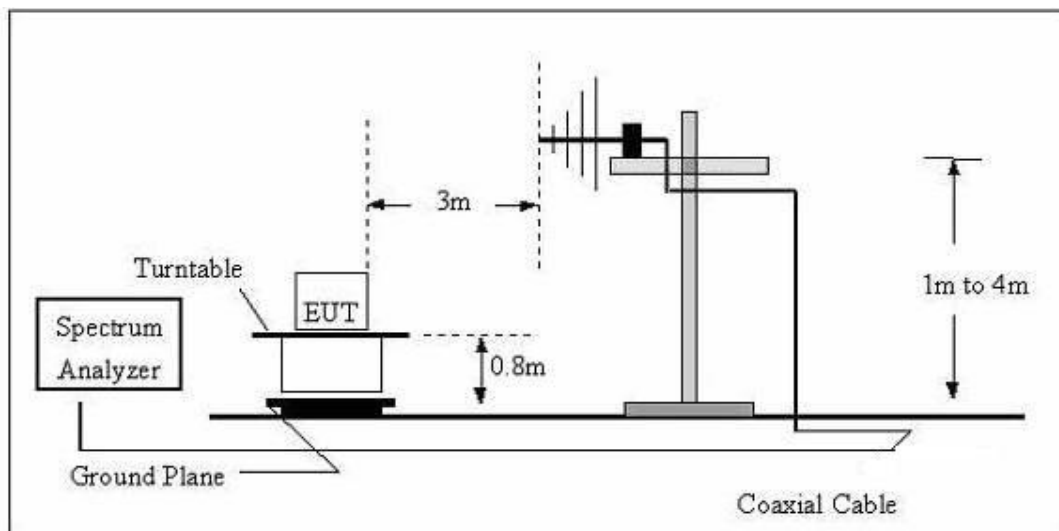

The radiated emission tests were performed in the 3 meters chamber test site, using the setup accordance with the ANSI C63.10-2013. The specification used was the FCC 15.209 and FCC 15.205 limits.

6.2. Test Standard

FCC §15.209; §15.205;

6.3. EMI Test Receiver Setup

The system was investigated from 9kHz to 1GHz.

During the radiated emission test, the EMI test receiver setup was set with the following configurations:



Frequency Range	RBW	Video B/W	Detector
9 kHz – 150 kHz	200 kHz	1 kHz	QP
150 kHz – 30MHz	9kHz	30kHz	QP
30 MHz – 1000 MHz	120 kHz	300 kHz	QP

Note: For the frequency bands 9-90 kHz and 110-490 kHz, the test was based on average detector.

6.4. Test Procedure

The EUT is placed on a turn table which is 0.8 meter above ground. The turn table can rotate 360 degrees to determine the position of the maximum emission level. The EUT is set 3 meters away from the receiving antenna which is mounted on a antenna tower. The antenna can move up and down between 1 to 4 meters to find out the maximum emission level. Broadband antenna (calibrated by dipole antenna) are used as a receiving antenna. Both horizontal and vertical polarization of the antenna are set on measurement.

6.5. Test Result

PASS

Please refer to the following pages.



EUT:	Wireless Charger	Model Name :	CDRZ14
Temperature:	26 °C	Relative Humidity:	54%
Pressure:	1010 hPa	Polarization :	Horizontal
Test Voltage :	DC 5V For Adapter(adapter intpu:AC120V/60Hz)		
Test Mode :	Normal Link		

9kHz-490kHz

Frequency (kHz)	Meter Reading (dBµV)	Factor (dB)	Emission Level (dBµV/m)	Limits (dBµV/m)	Margin (dB)	Detector Type
36.0007	91.81	20.54	112.35	136.48	-24.13	PK
36.0007	80.18	20.54	100.72	116.48	-15.76	AV
162.6105	59.16	21.19	80.35	123.38	-43.03	PK
162.6105	47.24	21.19	68.43	103.38	-34.95	AV
479.6078	48.45	22.47	70.92	113.99	-43.07	PK
479.6078	37.01	22.47	59.48	93.99	-34.51	AV

490kHz-30MHz

Frequency (MHz)	Meter Reading (dBµV)	Factor (dB)	Emission Level (dBµV/m)	Limits (dBµV/m)	Margin (dB)	Detector Type
0.5007	28.17	23.59	51.76	73.61	-21.85	QP
1.8715	18.79	24.93	43.72	69.54	-25.82	QP
7.8035	23.29	25.06	48.35	69.54	-21.19	QP
19.6106	18.28	27.06	45.34	69.54	-24.2	QP
21.6099	12.77	27.15	39.92	69.54	-29.62	QP
27.5968	9.99	27.58	37.57	69.54	-31.97	QP

Note:

Pre-scan in the all of mode, the worst case in of was recorded.

Factor = antenna factor + cable loss – pre-amplifier.

Margin = Emission Level- Limit.



30MHz-1GHz

EUT:	Wireless Charger	Model Name :	CDRZ14
Temperature:	26 °C	Relative Humidity:	54%
Pressure:	1010 hPa	Polarization :	Horizontal
Test Voltage :	DC 9V For Adapter(adapter intpu:AC120V/60Hz)		
Test Mode :	Normal Link		

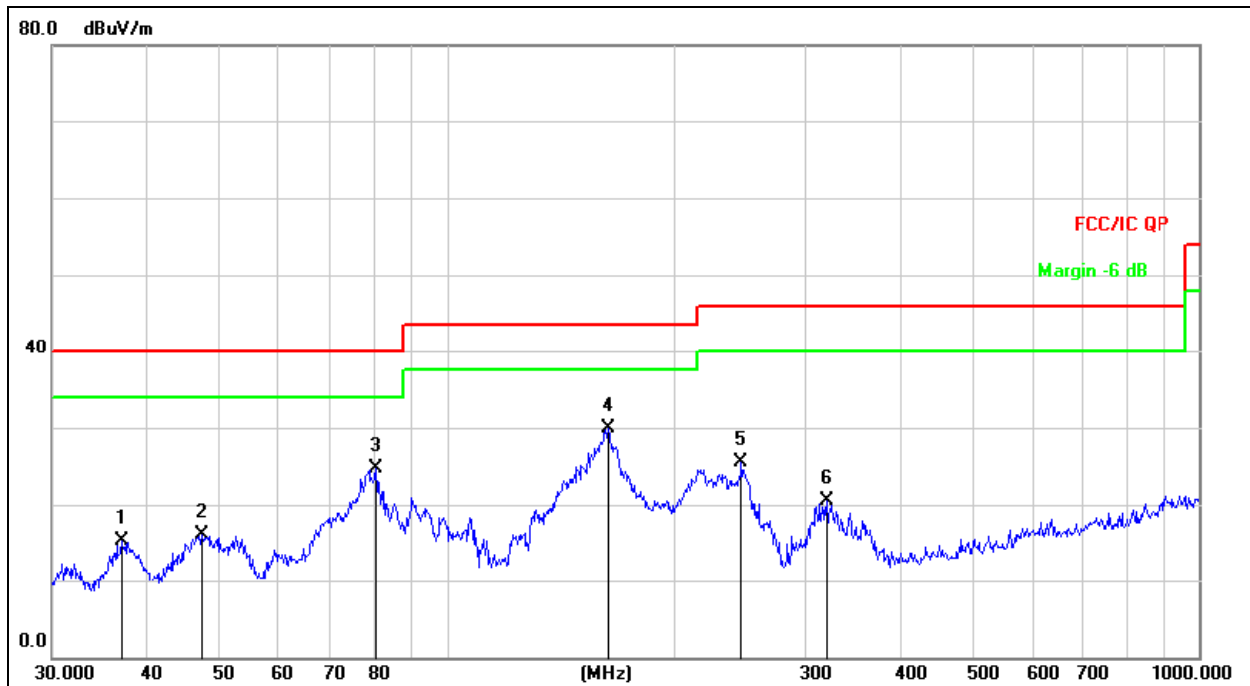

Remark:
Factor = Antenna Factor + Cable Loss – Pre-amplifier.

No.	Mk.	Freq. MHz	Reading Level dBuV	Correct Factor dB	Measure- ment dBuV/m	Limit dB/m	Over dB	Detector
1		37.0248	31.12	-15.78	15.34	40.00	-24.66	QP
2		47.3255	30.09	-13.99	16.10	40.00	-23.90	QP
3		80.6442	44.26	-19.48	24.78	40.00	-15.22	QP
4	*	163.7550	48.86	-18.89	29.97	43.50	-13.53	QP
5		246.8149	40.79	-15.23	25.56	46.00	-20.44	QP
6		319.9370	34.03	-13.62	20.41	46.00	-25.59	QP



EUT:	Wireless Charger	Model Name :	CDRZ14
Temperature:	26 °C	Relative Humidity:	54%
Pressure:	1010 hPa	Polarization :	Vertical
Test Voltage :	DC 5V For Adapter(adapter intpu:AC120V/60Hz)		
Test Mode :	Normal Link		

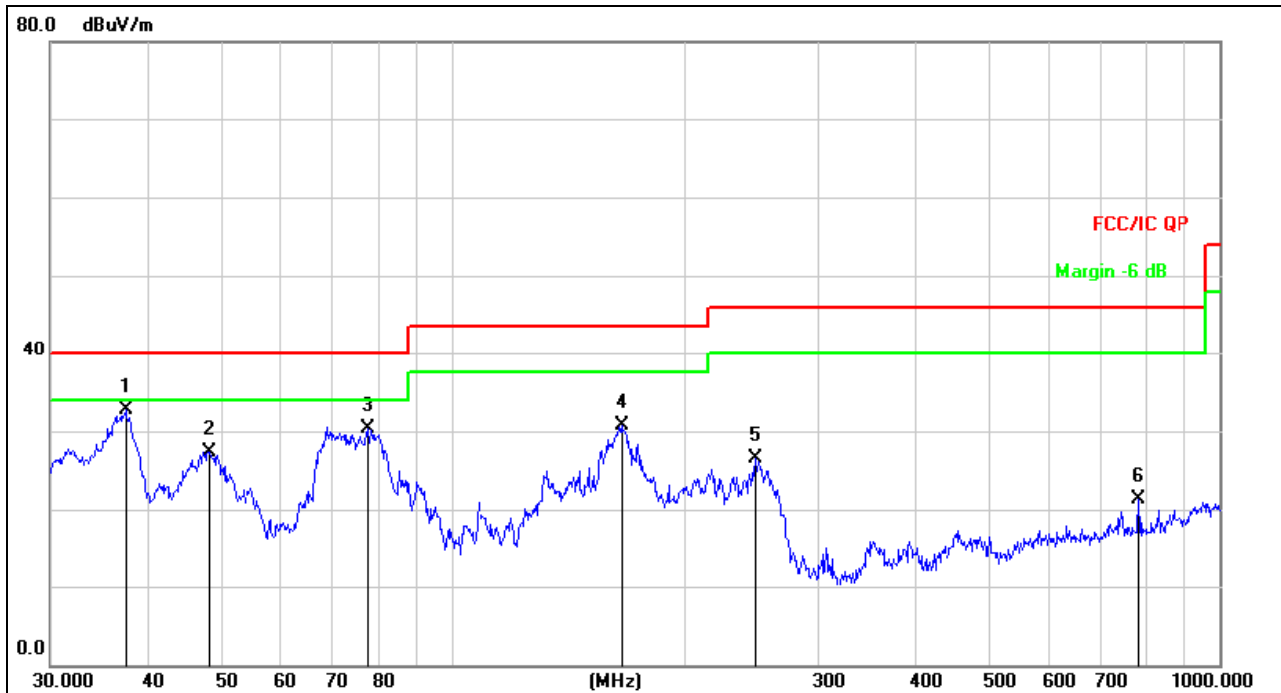

Remark:
Factor = Antenna Factor + Cable Loss – Pre-amplifier.

No.	Mk.	Freq. MHz	Reading Level dBuV	Correct Factor dB	Measure- ment dBuV/m	Limit dB/m	Over dB	Detector
1	*	37.5479	48.25	-15.59	32.66	40.00	-7.34	QP
2		48.1626	41.34	-13.98	27.36	40.00	-12.64	QP
3		77.5928	49.39	-19.14	30.25	40.00	-9.75	QP
4		166.0680	49.43	-18.78	30.65	43.50	-12.85	QP
5		248.5519	41.68	-15.16	26.52	46.00	-19.48	QP
6		782.3453	26.28	-4.92	21.36	46.00	-24.64	QP



EUT:	Wireless Charger	Model Name :	CDRZ14
Temperature:	26 °C	Relative Humidity:	54%
Pressure:	1010 hPa	Polarization :	Horizontal
Test Voltage :	DC 9V For Adapter(adapter intpu:AC120V/60Hz)		
Test Mode :	Normal Link		

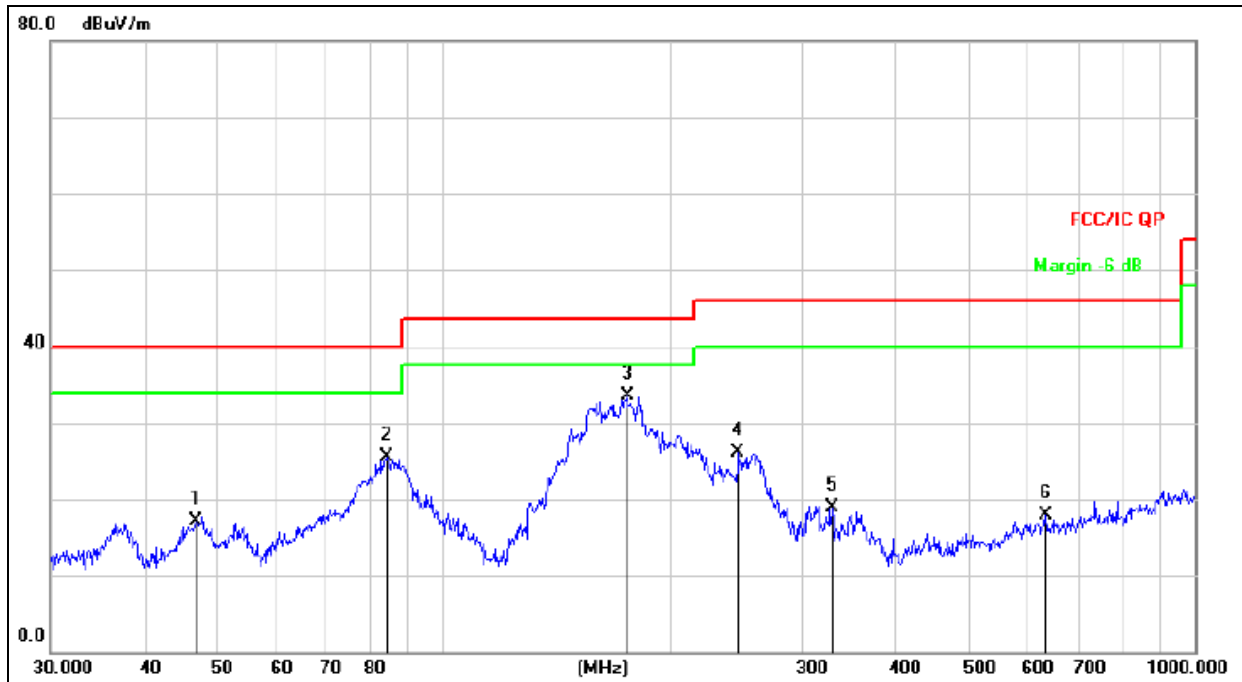

Remark:
Factor = Antenna Factor + Cable Loss – Pre-amplifier.

No.	Mk.	Freq. MHz	Reading Level dBuV	Correct Factor dB	Measure- ment dBuV/m	Limit dB/m	Over dB	Detector
1		46.8303	31.06	-14.00	17.06	40.00	-22.94	QP
2		84.1100	44.15	-18.73	25.42	40.00	-14.58	QP
3	*	175.6516	51.82	-18.30	33.52	43.50	-9.98	QP
4		246.8149	41.36	-15.23	26.13	46.00	-19.87	QP
5		329.0389	32.31	-13.42	18.89	46.00	-27.11	QP
6		633.9072	24.44	-6.52	17.92	46.00	-28.08	QP



EUT:	Wireless Charger	Model Name :	CDRZ14
Temperature:	26 °C	Relative Humidity:	54%
Pressure:	1010 hPa	Polarization :	Vertical
Test Voltage :	DC 9V For Adapter(adapter intpu:AC120V/60Hz)		
Test Mode :	Normal Link		

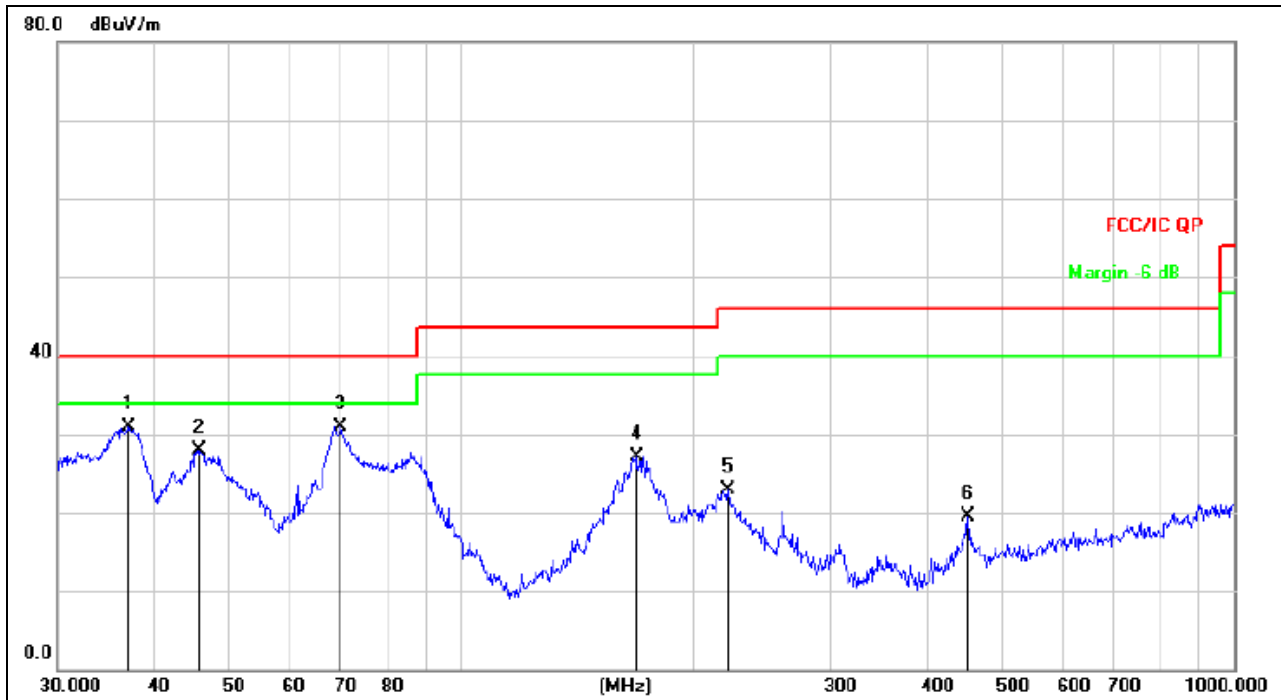

Remark:
Factor = Antenna Factor + Cable Loss – Pre-amplifier.

No.	Mk.	Freq. MHz	Reading Level dBuV	Correct Factor dB	Measure- ment dBuV/m	Limit dB/m	Over dB	Detector
1		37.0248	46.75	-15.78	30.97	40.00	-9.03	QP
2		45.8551	42.00	-14.02	27.98	40.00	-12.02	QP
3	*	69.8450	48.55	-17.56	30.99	40.00	-9.01	QP
4		168.4138	45.72	-18.66	27.06	43.50	-16.44	QP
5		221.3920	38.98	-16.16	22.82	46.00	-23.18	QP
6		452.7196	30.07	-10.59	19.48	46.00	-26.52	QP

7. EUT TEST PHOTOS

Conducted Measurement Photos



Radiated Measurement Photos
9KHz-30MHz

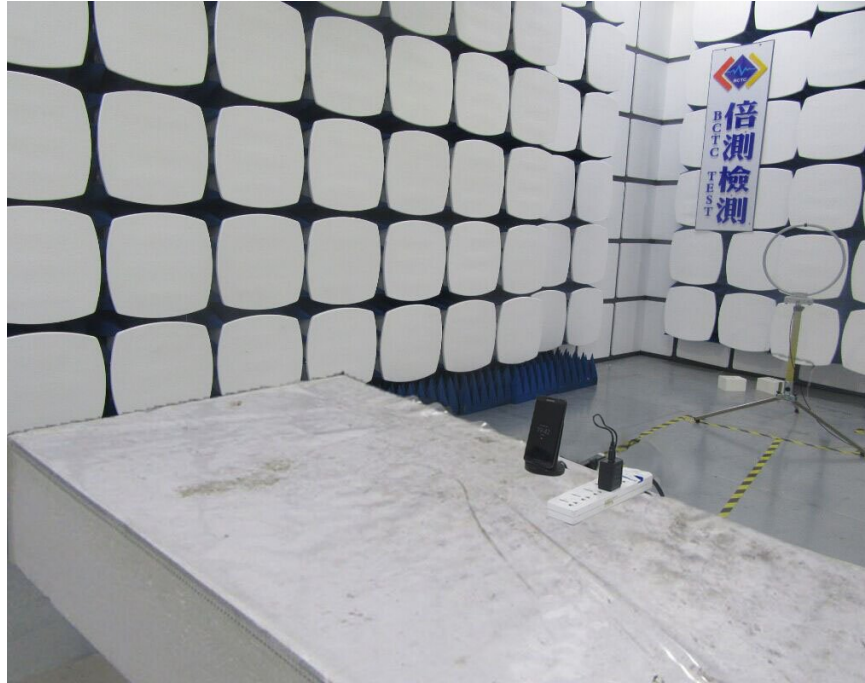

30MHz-1GHz

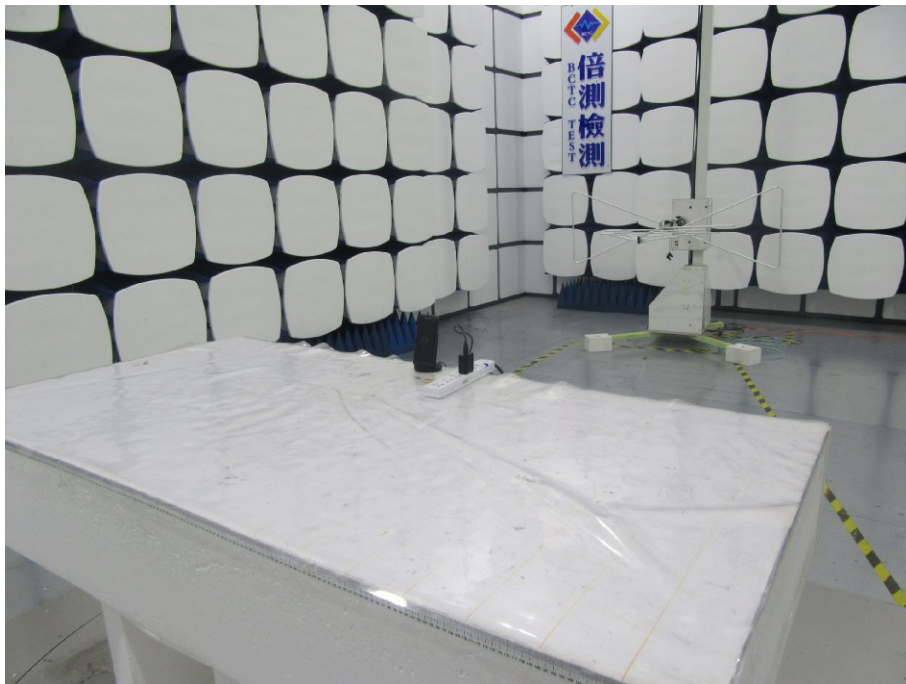

8. EUT PHOTOS



***** END OF REPORT *****