

# TEST REPORT

Report No.: BCTC2010001340-1E

---

Applicant: Shenzhen Mossloo Industrial Co., Ltd

---

Product Name: UV Sanitizer with Wireless Charger

---

Model/Type Ref.: MSL-M6044Q

---

Tested Date: Oct. 26, 2020 to Nov. 03, 2020

---

Issued Date: Nov. 03, 2020

---

**Shenzhen BCTC Testing Co., Ltd.**

# FCC ID: 2AN8F-MSLM6044Q

Product Name: UV Sanitizer with Wireless Charger  
Trademark: N/A  
Model/Type Ref.: MSL-M6044Q  
SNT27  
Prepared For: Shenzhen Mossloo Industrial Co., Ltd  
Address: Road One No.4, Science Industrial Park, Shangxue Village,  
Bantian Street, Longgang District, Shenzhen China  
Manufacturer: Shenzhen Mossloo Industrial Co., Ltd  
Address: Road One No.4, Science Industrial Park, Shangxue Village,  
Bantian Street, Longgang District, Shenzhen China  
Prepared By: Shenzhen BCTC Testing Co., Ltd.  
Address: 1-2F, East of B Building, Pengzhou Industrial, Fuyuan 1st Road,  
Qiaotou Community, Fuyong Street, Bao'an District, Shenzhen,  
China  
Sample Received Date: Oct. 26, 2020  
Sample tested Date: Oct. 26, 2020 to Nov. 03, 2020  
Issue Date: Nov. 03, 2020  
Report No.: BCTC2010001340-1E  
Test Standards: FCC Part15.209  
ANSI C63.10-2013

Tested by:



Eric Yang/Project Handler

Approved by:



*The test report is effective only with both signature and specialized stamp. This result(s) shown in this report refer only to the sample(s) tested. Without written approval of Shenzhen BCTC Testing Co., Ltd, this report can't be reproduced except in full. The tested sample(s) and the sample information are provided by the client.*

**TABLE OF CONTENT**

Test Report Declaration	Page
<b>1. VERSION</b> .....	4
<b>2. TEST SUMMARY</b> .....	5
<b>3. MEASUREMENT UNCERTAINTY</b> .....	6
<b>4. PRODUCT INFORMATION AND TEST SETUP</b> .....	7
4.1 Product Information .....	7
4.2 Test Setup Configuration .....	7
4.3 Support Equipment .....	8
4.5 Test Mode .....	8
<b>5. TEST FACILITY AND TEST INSTRUMENT USED</b> .....	9
5.1 Test Facility .....	9
5.2 Test Instrument Used .....	9
<b>6. CONDUCTED EMISSIONS</b> .....	11
6.1 Block Diagram Of Test Setup .....	11
6.2 Limit .....	11
6.3 Test procedure .....	11
6.4 EUT operating Conditions .....	11
6.5 Test Result .....	12
<b>7. RADIATED EMISSIONS</b> .....	14
7.1 Block Diagram Of Test Setup .....	14
7.2 Limit .....	15
7.3 Test procedure .....	15
7.4 Test Result .....	17
<b>8. EUT PHOTOGRAPHS</b> .....	20
<b>9. EUT TEST SETUP PHOTOGRAPHS</b> .....	21

(Note: N/A means not applicable)

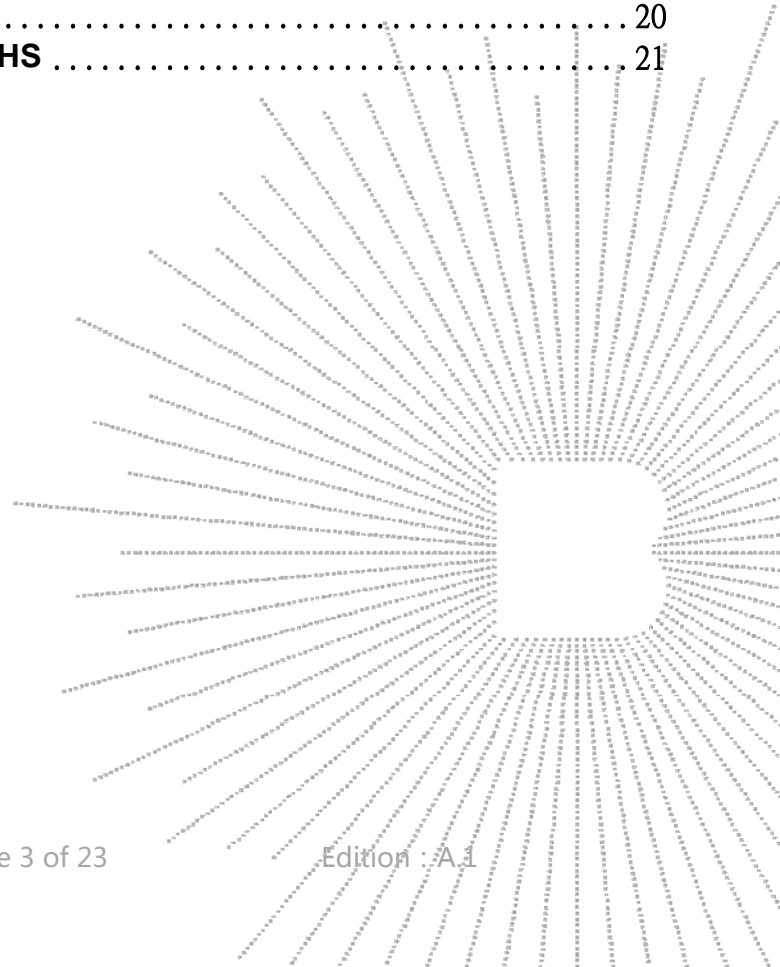

## 1. VERSION

Report No.	Issue Date	Description	Approved
BCTC2010001340-1E	Nov. 03, 2020	Original	Valid

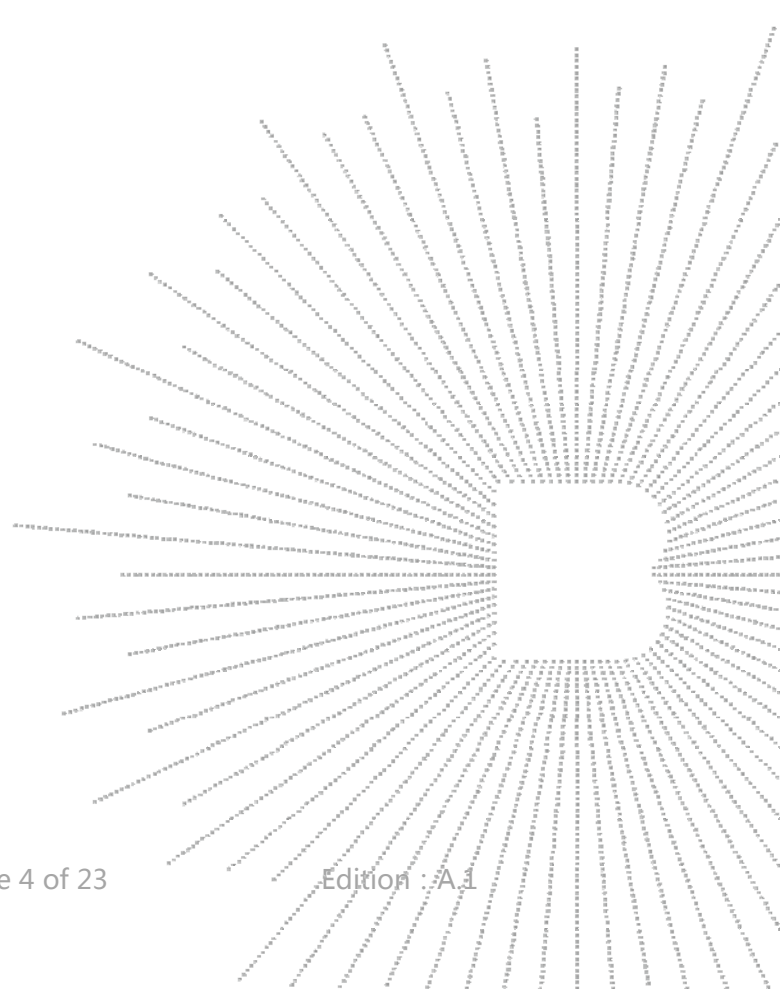

## 2. TEST SUMMARY

The Product has been tested according to the following specifications:

No.	Test Parameter	Clause No	Results
1	Conducted Emission	15.207	PASS
2	Radiated Emission	15.209	PASS
3	Antenna Requirement	15.203	PASS

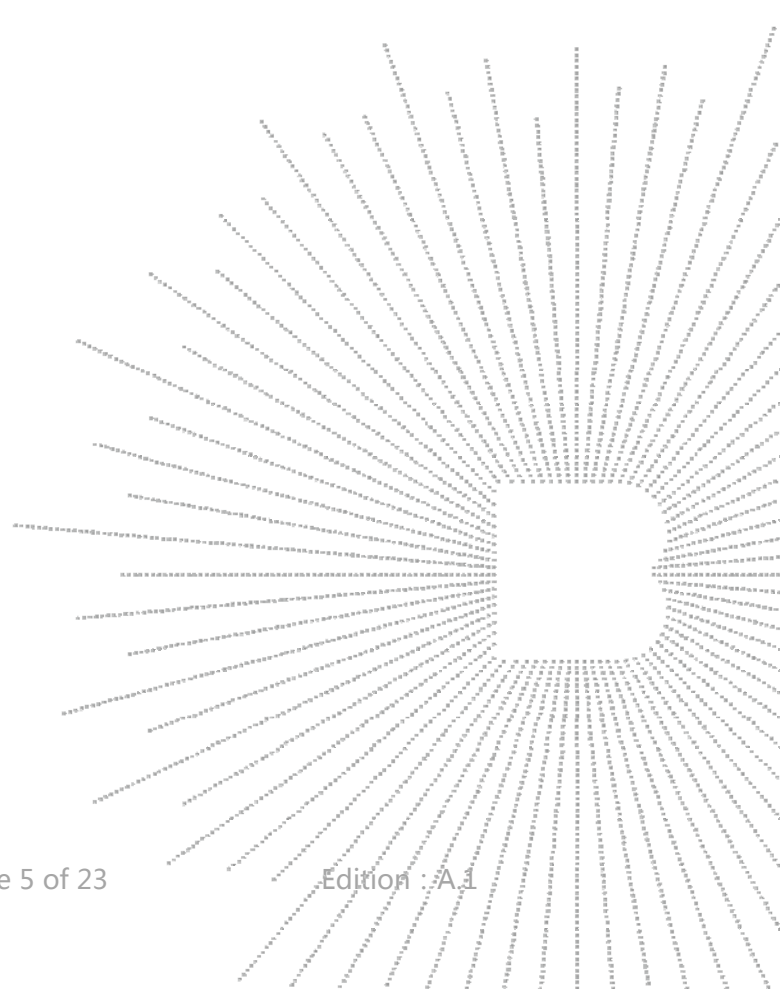

### 3. MEASUREMENT UNCERTAINTY

Where relevant, the following measurement uncertainty levels have been estimated for tests performed on the Product as specified in CISPR 16-4-2. This uncertainty represents an expanded uncertainty expressed at approximately the 95% confidence level using a coverage factor of  $k=2$ .

No.	Item	Uncertainty
1	3m camber Radiated spurious emission(30MHz-1GHz)	U=4.3dB
2	Conducted Emission (150kHz-30MHz)	U=3.2dB
3	humidity uncertainty	U=5.3%
4	Temperature uncertainty	U=0.59°C

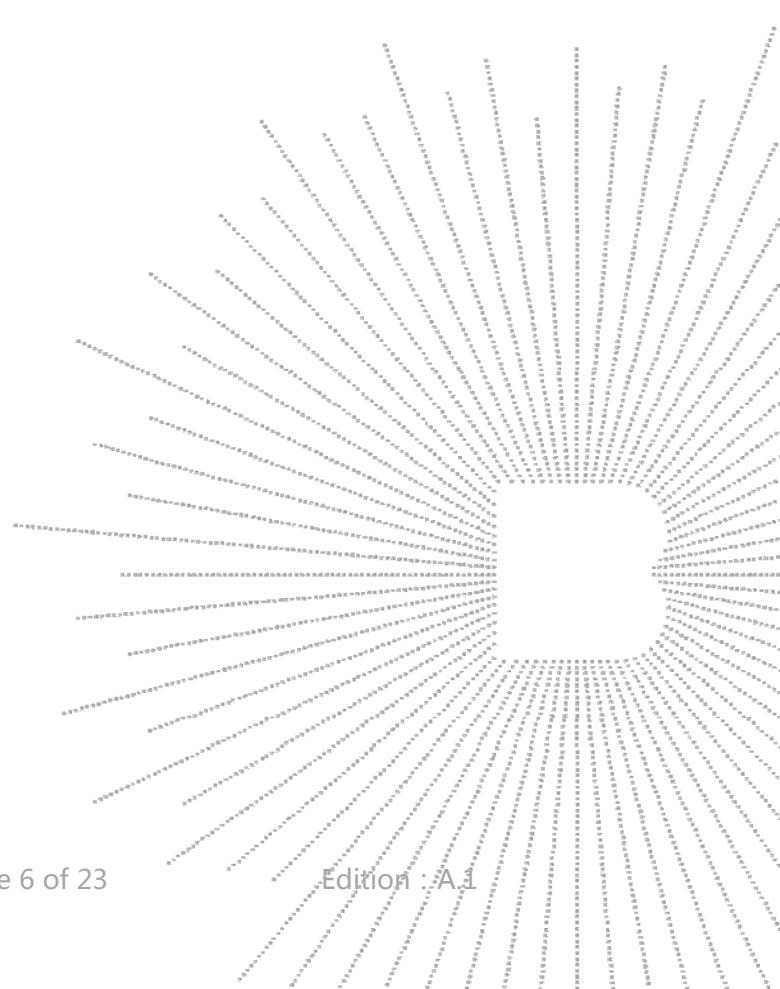

## 4. PRODUCT INFORMATION AND TEST SETUP

### 4.1 Product Information

Model/Type Ref.:	MSL-M6044Q SNT27
Model differences:	All the model are the same circuit and RF module, except model names.
Product Description:	UV Sanitizer with Wireless Charger
Operation Frequency:	112kHz-220kHz
Antenna installation:	Inductive loop coil antenna
Ratings:	DC 5V/2A
Test Model:	MSL-M6044Q

### 4.2 Test Setup Configuration

See test photographs attached in *EUT TEST SETUP PHOTOGRAPHS* for the actual connections between Product and support equipment.

Conducted Emission/Radiated Spurious Emission:

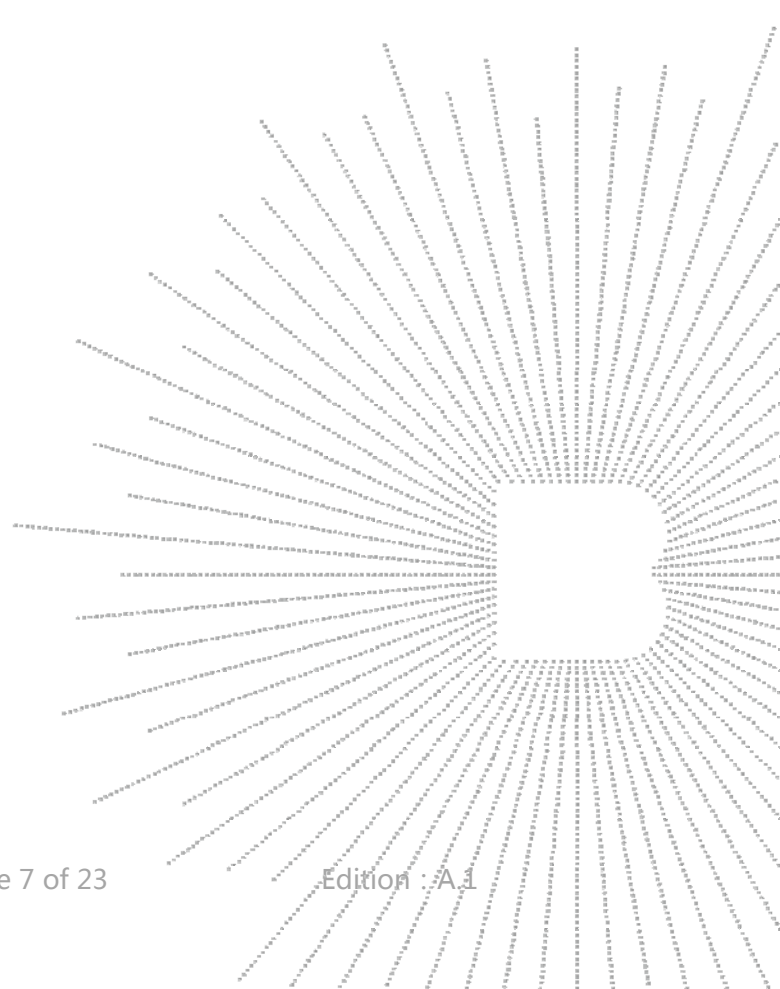
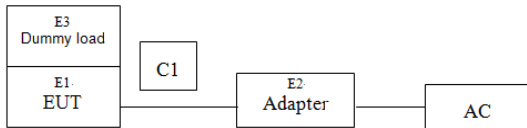

### 4.3 Support Equipment

No.	Device Type	Brand	Model	Series No.	Data Cable	Remark
E-1	UV Sanitizer with Wireless Charger	N/A	MSL-M604 4Q	SNT27	N/A	EUT
E-2	Adapter	N/A	BCTC-002	N/A	Auxiliary	Adapter
E-3	Dummy load	N/A	DL01	N/A	Auxiliary	Dummy load

**Notes:**

1. All the equipment/cables were placed in the worst-case configuration to maximize the emission during the test.
2. Grounding was established in accordance with the manufacturer's requirements and conditions for the intended use.

### 4.5 Test Mode

To investigate the maximum EMI emission characteristics generates from EUT, the test system was pre-scanning tested base on the consideration of following EUT operation mode or test configuration mode which possible have effect on EMI emission level. Each of these EUT operation mode(s) or test configuration mode(s) mentioned above was evaluated respectively.

Test Modes	keeping TX*
------------	-------------

**Note:**

All test mode were tested and passed, only Conducted Emissions, Radiated Emissions shows (\*) is the worst case mode which were recorded in this report.

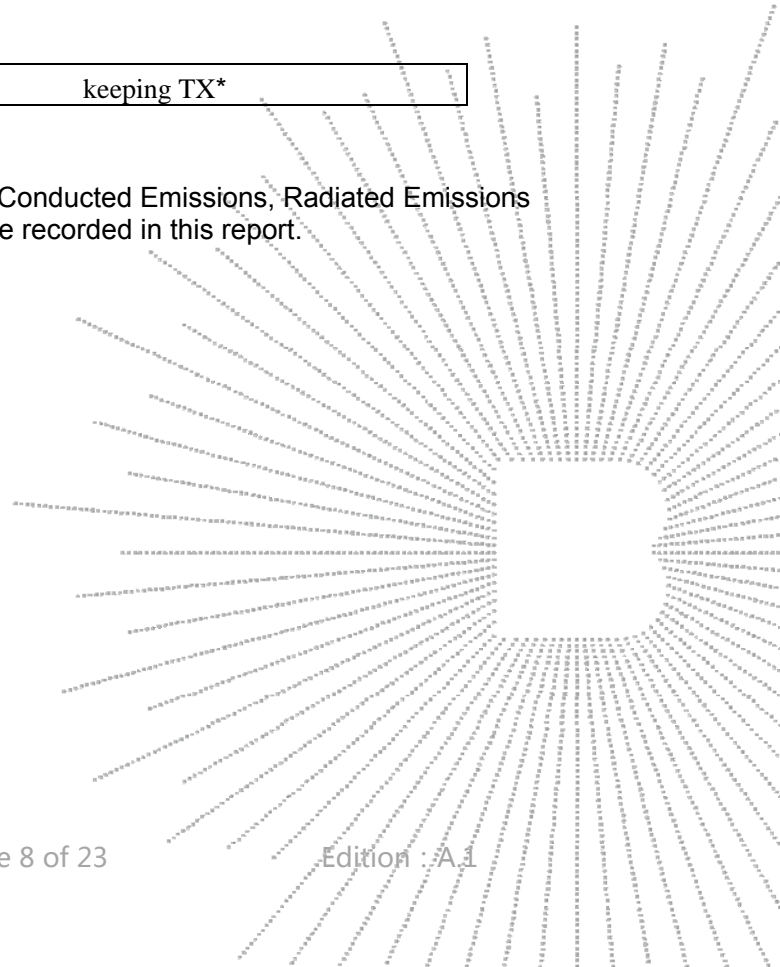



## 5. TEST FACILITY AND TEST INSTRUMENT USED

### 5.1 Test Facility

All measurement facilities used to collect the measurement data are located at Shenzhen BCTC Testing Co., Ltd. Address: 1-2F, East of B Building, Pengzhou Industrial, Fuyuan 1st Road, Qiaotou Community, Fuyong Street, Bao'an District, Shenzhen, China. The site and apparatus are constructed in conformance with the requirements of ANSI C63.4 and CISPR 16-1-1 other equivalent standards.

FCC Test Firm Registration Number: 712850

IC Registered No.: 23583

### 5.2 Test Instrument Used

Conducted emissions Test					
Equipment	Manufacturer	Model#	Serial#	Last Cal.	Next Cal.
Receiver	R&S	ESR3	102075	Jun. 08, 2020	Jun. 07, 2021
LISN	R&S	ENV216	101375	Jun. 04, 2020	Jun. 03, 2021
ISN	HPX	ISN T800	S1509001	Jun. 04, 2020	Jun. 03, 2021
Software	Frad	EZ-EMC	EMC-CON 3A1	\	\

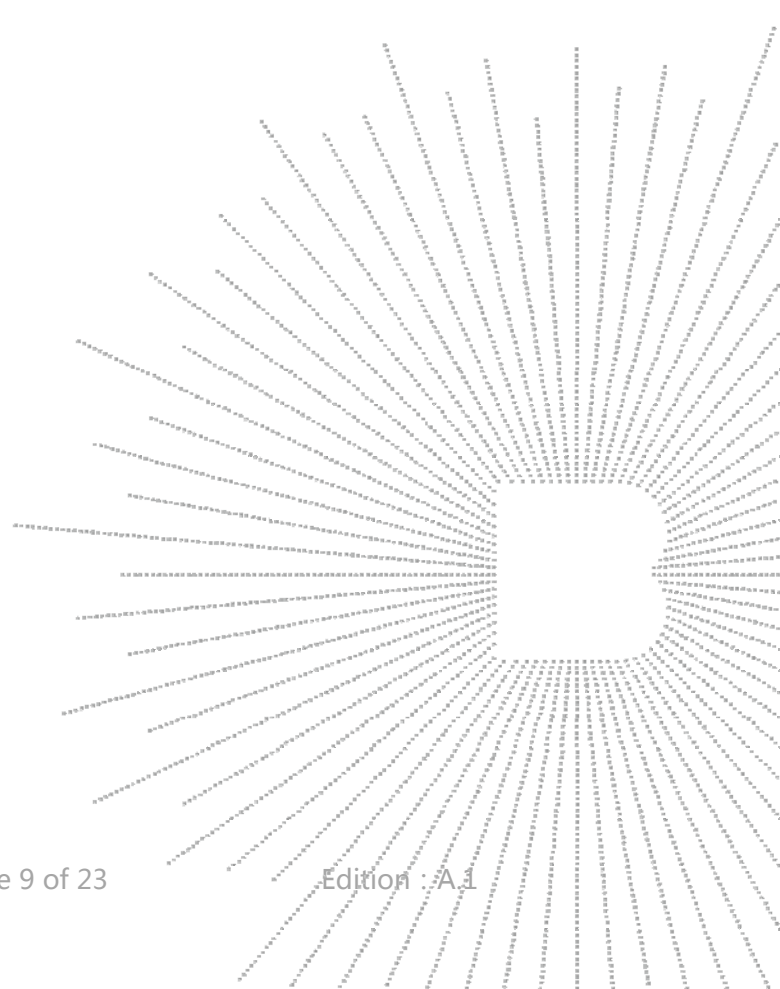

Radiated emissions Test (966 chamber)					
Equipment	Manufacturer	Model#	Serial#	Last Cal.	Next Cal.
966 chamber	ChengYu	966 Room	966	Jun. 06, 2020	Jun. 05, 2023
Receiver	R&S	ESR3	102075	Jun. 08, 2020	Jun. 07, 2021
Receiver	R&S	ESRP	101154	Jun. 08, 2020	Jun. 07, 2021
Amplifier	Schwarzbeck	BBV9718	9718-309	Jun. 04, 2020	Jun. 03, 2021
Amplifier	Schwarzbeck	BBV9744	9744-0037	Jun. 04, 2020	Jun. 03, 2021
TRILOG Broadband Antenna	schwarzbeck	VULB 9163	VULB9163-942	Jun. 08, 2020	Jun. 07, 2021
Horn Antenna	SCHWARZBECK	BBHA9120 D	1201	Jun. 10, 2020	Jun. 09, 2021
Horn Antenna (18GHz-40 GHz)	SCHWARZBECK	BBHA9170	822	Jun. 10, 2020	Jun. 09, 2021
Amplifier (18GHz-40 GHz)	MITEQ	TTA1840-3 5-HG	2034381	Jun. 08, 2020	Jun. 07, 2021
Loop Antenna (9kHz-30MHz)	SCHWARZBECK	FMZB1519 B	014	Jun. 08, 2020	Jun. 07, 2021
RF cables1 (9kHz-30MHz)	Huber+Suhnar	9kHz-30MHz	B1702988-0008	Jun. 08, 2020	Jun. 07, 2021
RF cables2 (30MHz-1GHz)	Huber+Suhnar	30MHz-1GHz	1486150	Jun. 08, 2020	Jun. 07, 2021
RF cables3 (1GHz-40GHz)	Huber+Suhnar	1GHz-40GHz	1607106	Jun. 08, 2020	Jun. 07, 2021
Power Meter	Keysight	E4419B	\	Jun. 08, 2020	Jun. 07, 2021
Power Sensor (AV)	Keysight	E9 300A	\	Jun. 08, 2020	Jun. 07, 2021
Signal Analyzer 20kHz-26.5 GHz	KEYSIGHT	N9020A	MY49100060	Jun. 04, 2020	Jun. 03, 2021
Spectrum Analyzer 9kHz-40GHz	Agilent	FSP40	100363	Jun. 13, 2020	Jun. 12, 2021
Software	Frad	EZ-EMC	FA-03A2 RE	\	\

## 6. CONDUCTED EMISSIONS

### 6.1 Block Diagram Of Test Setup

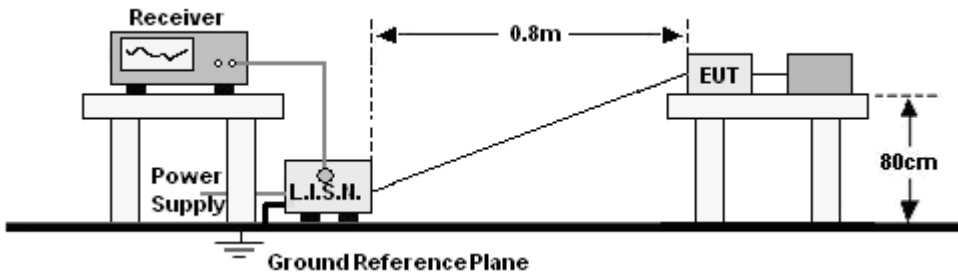

### 6.2 Limit

FREQUENCY (MHz)	Limit (dBuV)	
	Quas-peak	Average
0.15 -0.5	66 - 56 *	56 - 46 *
0.50 -5.0	56.00	46.00
5.0 -30.0	60.00	50.00

Notes:  
 1. \*Decreasing linearly with logarithm of frequency.  
 2. The lower limit shall apply at the transition frequencies.

### 6.3 Test procedure

Receiver Parameters	Setting
Attenuation	10 dB
Start Frequency	0.15 MHz
Stop Frequency	30 MHz
IF Bandwidth	9 kHz

- The Product was placed on a nonconductive table 0.8 m above the horizontal ground reference plane, and 0.4 m from the vertical ground reference plane, and connected to the main through Line Impedance Stability Network (L.I.S.N).
- The RBW of the receiver was set at 9 kHz in 150 kHz ~ 30MHz with Peak and AVG detector in Max Hold mode. Run the receiver's pre-scan to record the maximum disturbance generated from Product in all power lines in the full band.
- For each frequency whose maximum record was higher or close to limit, measure its QP and AVG values and record.

### 6.4 EUT operating Conditions

The EUT was configured for testing in a typical fashion (as a customer would normally use it). The EUT has been programmed to continuously transmit during test. This operating condition was tested and used to collect the included data.

## 6.5 Test Result

Temperature :	26 °C	Relative Humidity :	54%
Pressure :	101kPa	Phase :	L
Test Voltage :	AC 120V/60Hz	Test Mode :	Wireless Charging

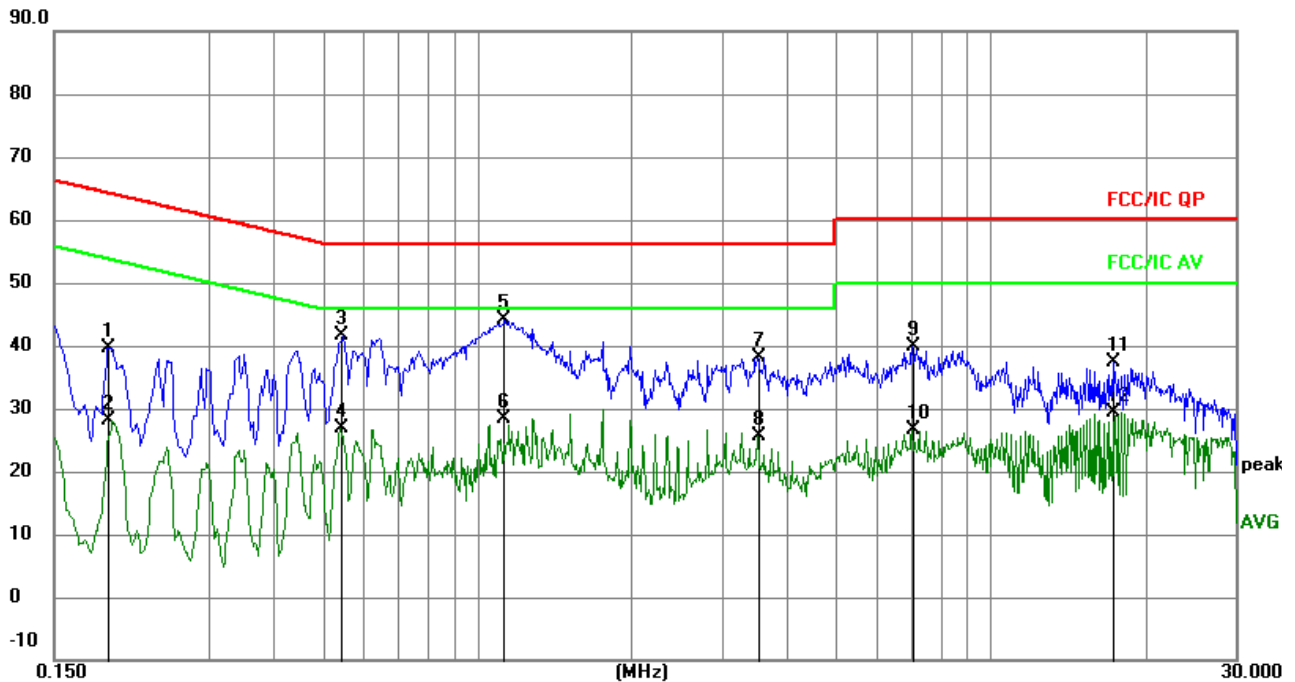

Remark:

1. All readings are Quasi-Peak and Average values.
2. Factor = Insertion Loss + Cable Loss.

No.	Mk.	Freq. MHz	Reading Level	Correct Factor dB	Measure- ment dBuV	Limit dBuV	Over dB	Detector
1		0.1904	30.14	9.47	39.61	64.02	-24.41	QP
2		0.1904	18.67	9.47	28.14	54.02	-25.88	AVG
3		0.5407	31.79	9.76	41.55	56.00	-14.45	QP
4		0.5407	17.15	9.76	26.91	46.00	-19.09	AVG
5	*	1.1292	34.46	9.57	44.03	56.00	-11.97	QP
6		1.1292	18.71	9.57	28.28	46.00	-17.72	AVG
7		3.5092	28.41	9.70	38.11	56.00	-17.89	QP
8		3.5092	15.87	9.70	25.57	46.00	-20.43	AVG
9		7.0249	30.06	9.72	39.78	60.00	-20.22	QP
10		7.0249	16.95	9.72	26.67	50.00	-23.33	AVG
11		17.2908	27.60	9.74	37.34	60.00	-22.66	QP
12		17.2908	19.55	9.74	29.29	50.00	-20.71	AVG

Temperature :	26 °C	Relative Humidity :	54%
Pressure :	101kPa	Phase :	N
Test Voltage :	AC 120V/60Hz	Test Mode :	Wireless Charging

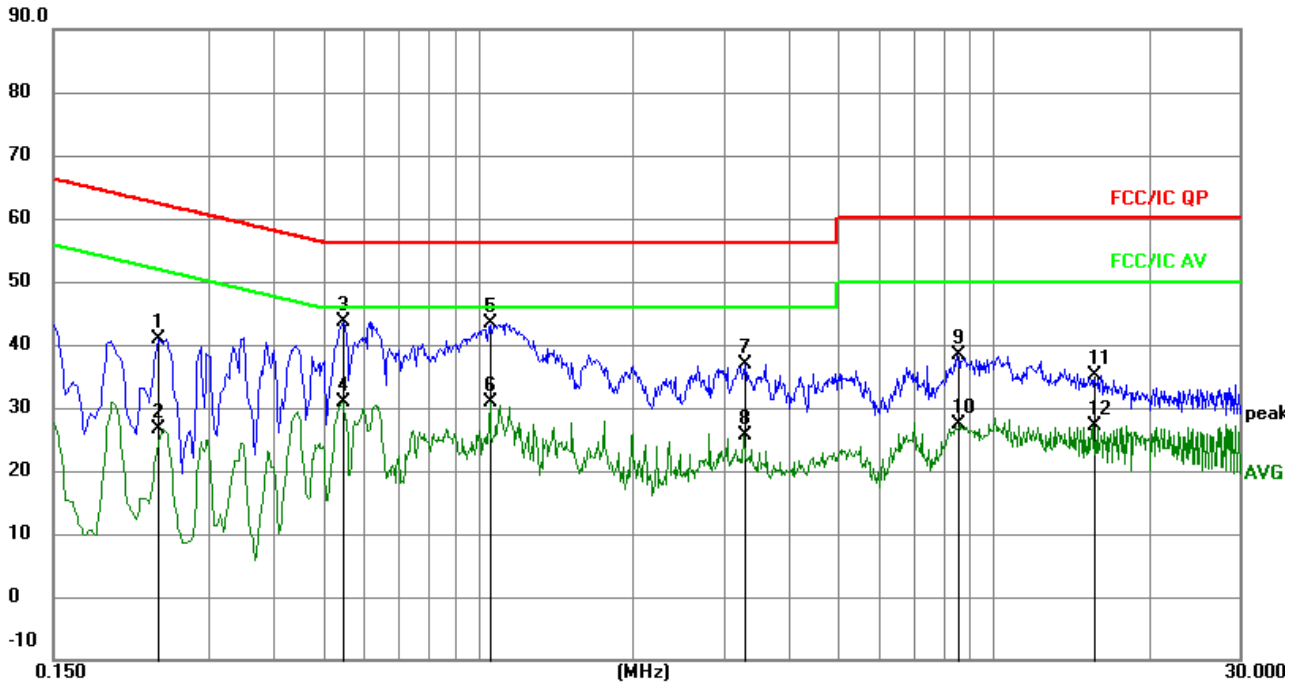
**Remark:**

1. All readings are Quasi-Peak and Average values.
2. Factor = Insertion Loss + Cable Loss.

No.	Mk.	Freq. MHz	Reading Level	Correct Factor dB	Measure- ment dBuV	Limit dBuV	Over dB	Detector
1		0.2400	31.46	9.51	40.97	62.10	-21.13	QP
2		0.2400	17.05	9.51	26.56	52.10	-25.54	AVG
3	*	0.5460	33.80	9.78	43.58	56.00	-12.42	QP
4		0.5460	21.03	9.78	30.81	46.00	-15.19	AVG
5		1.0545	33.81	9.57	43.38	56.00	-12.62	QP
6		1.0545	21.19	9.57	30.76	46.00	-15.24	AVG
7		3.2820	27.19	9.68	36.87	56.00	-19.13	QP
8		3.2820	15.99	9.68	25.67	46.00	-20.33	AVG
9		8.5424	28.76	9.70	38.46	60.00	-21.54	QP
10		8.5424	17.79	9.70	27.49	50.00	-22.51	AVG
11		15.7065	25.34	9.71	35.05	60.00	-24.95	QP
12		15.7065	17.45	9.71	27.16	50.00	-22.84	AVG

## 7. RADIATED EMISSIONS

### 7.1 Block Diagram Of Test Setup

(A) Radiated Emission Test-Up Frequency Below 30MHz

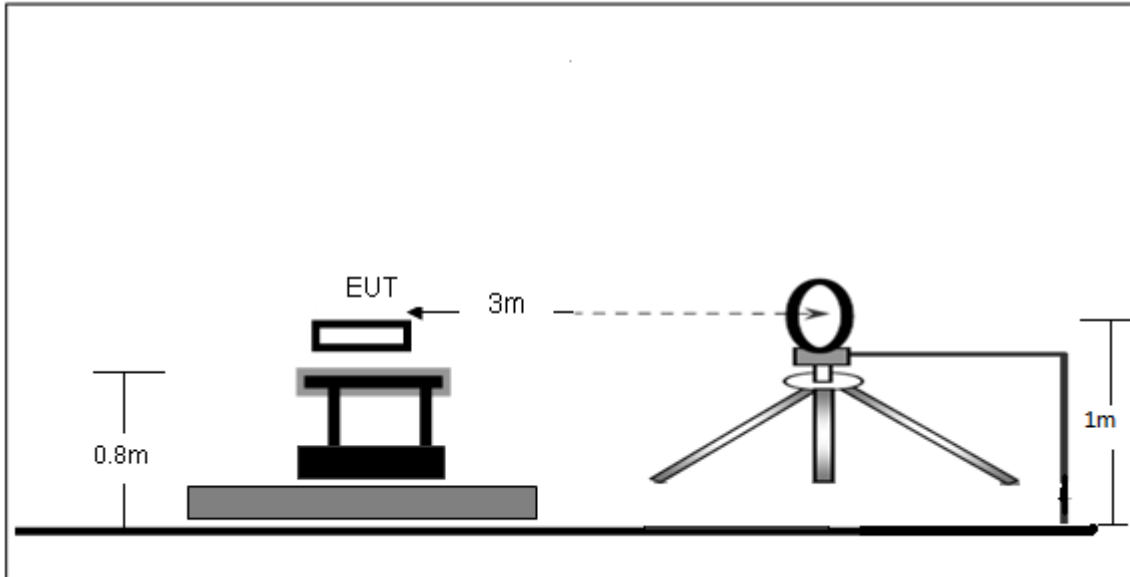

(B) Radiated Emission Test-Up Frequency 30MHz~1GHz

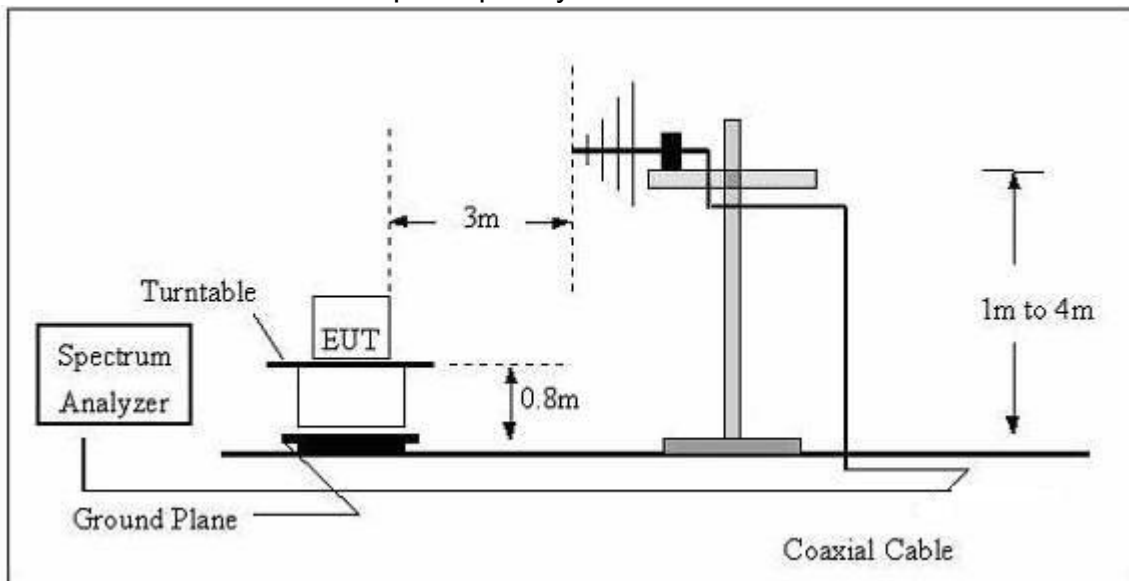

## 7.2 Limit

FCC §15.209; §15.205.

Test Standard	FCC Part15 C Section 15.209 and 15.205				
Test Limit	Frequency (MHz)	Field strength (microvolt/meter)	Limit (dBuV/m)	Remark	Measurement distance (m)
	0.009MHz~0.490MHz	2400/F(kHz)	-	-	300
	0.490MHz~1.705MHz	24000/F(kHz)	-	-	30
	1.705MHz~30MHz	30	-	-	30
	30MHz~88MHz	100	40.0	Quasi-peak	3
	88MHz~216MHz	150	43.5	Quasi-peak	3
	216MHz~960MHz	200	46.0	Quasi-peak	3
	960MHz~1000MHz	500	54.0	Quasi-peak	3
			54.0	Average	3
Above 1000MHz	-	74.0	Peak	3	

## 7.3 Test procedure

Receiver Parameter	Setting
Attenuation	Auto
9kHz~150kHz	RBW 200Hz for QP
150kHz~30MHz	RBW 9kHz for QP
30MHz~1000MHz	RBW 120kHz for QP

Below 1GHz test procedure as below:

- a. The EUT was placed on the top of a rotating table 0.8 meters above the ground at a 3 meter semi-anechoic chamber. The table was rotated 360 degrees to determine the position of the highest radiation.
- b. The EUT was set 3 meters away from the interference-receiving antenna, which was mounted on the top of a variable-height antenna tower.
- c. The antenna height is varied from one meter to four meters above the ground to determine the maximum value of the field strength. Both horizontal and vertical polarizations of the antenna are set to make the measurement.
- d. For each suspected emission, the EUT was arranged to its worst case and then the antenna was tuned to heights from 1 meter to 4 meters (for the test frequency of below 30MHz, the antenna was tuned to heights 1 meter) and the rotatable table was turned from 0 degrees to 360 degrees to find the maximum reading.
- e. The test-receiver system was set to Peak Detect Function and Specified Bandwidth with Maximum Hold Mode.

f. If the emission level of the EUT in peak mode was 10dB lower than the limit specified, then testing could be stopped and the peak values of the EUT would be reported. Otherwise the emissions that did not have 10dB margin would be re-tested one by one using peak, quasi-peak or average method as specified and then reported in a data sheet.

Above 1GHz test procedure as below:

g. Different between above is the test site, change from Semi- Anechoic Chamber to fully Anechoic Chamber and change form table 0.8 metre to 1.5 metre( Above 18GHz the distance is 1 meter and table is 1.5 metre).

h. Test the EUT in the lowest channel ,the middle channel ,the Highest channel.

Note:

Both horizontal and vertical antenna polarities were tested and performed pretest to three orthogonal axis. The worst case emissions were reported.

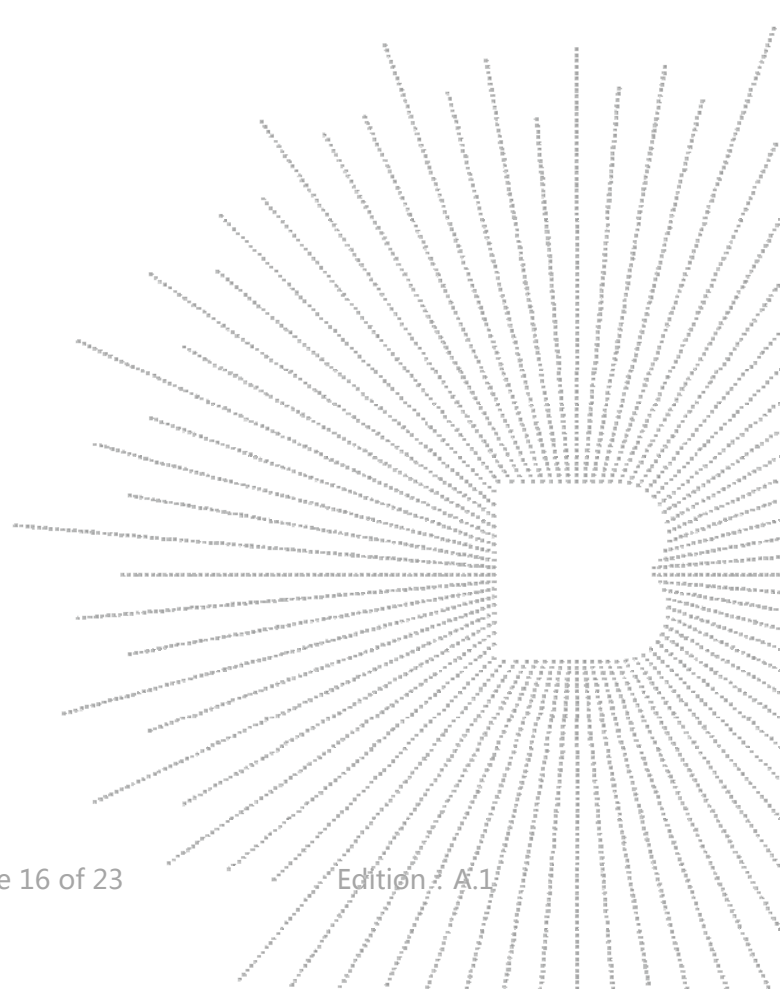



## 7.4 Test Result

9kHz-30MHz

Temperature:	26°C	Relative Humidity:	24%
Pressure:	101 kPa	Test Voltage :	AC 120V/60Hz
Test Mode :	Wireless Charging	Polarization :	--

Frequency (kHz)	Meter Reading (dB $\mu$ V)	Factor (dB)	Emission Level (dB $\mu$ V/m)	Limits (dB $\mu$ V/m)	Margin (dB)	Detector Type
25.6000	44.35	20.15	64.50	139.44	-74.94	PK
25.6000	45.16	20.15	65.31	119.44	-54.13	AV
72.3000	53.35	20.33	73.68	130.42	-56.74	PK
72.3000	46.37	20.33	66.70	110.42	-43.72	AV
139.4000	67.53	20.55	88.08	124.72	-36.64	PK
139.4000	64.31	20.55	84.86	104.72	-19.86	AV
672.5000	36.35	20.64	56.99	71.05	-14.06	QP
955.1000	31.67	21.26	52.93	68.00	-15.07	QP
1268.5200	28.59	22.32	50.91	65.54	-14.63	QP

**Note:**

Pre-scan in the all of mode, the worst case in of was recorded.

Factor = antenna factor + cable loss – pre-amplifier.

Margin = Emission Level- Limit.

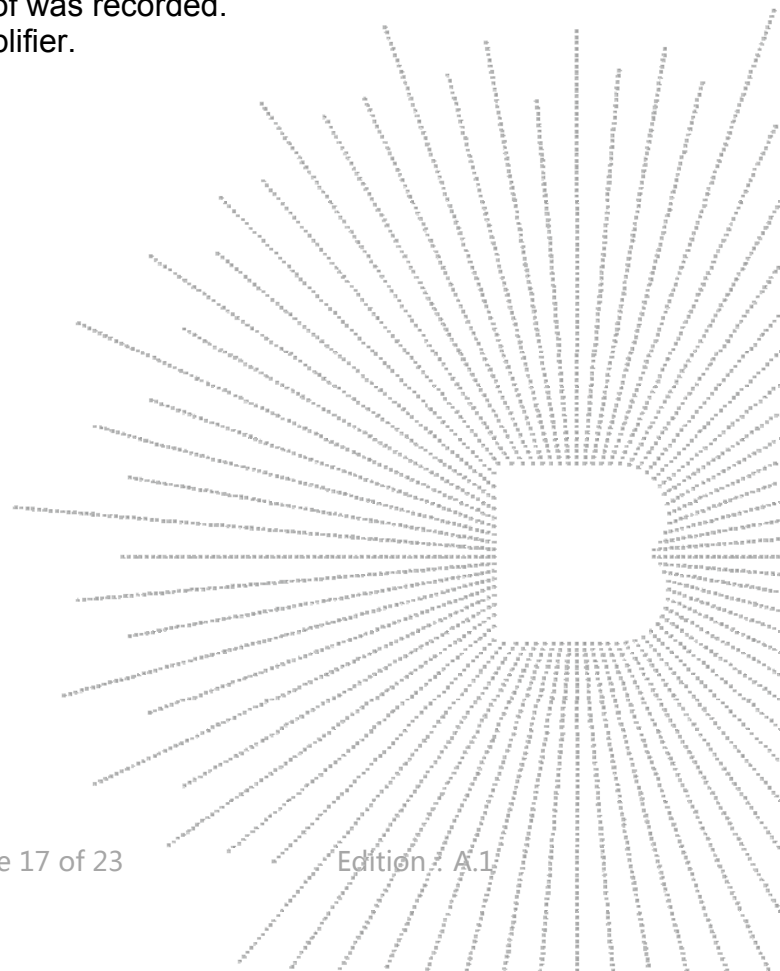

Between 30MHz – 1GHz

Temperature:	26°C	Relative Humidity:	54%
Pressure:	101 kPa	Test Voltage :	AC 120V/60Hz
Test Mode :	Wireless Charging	Polarization :	Horizontal

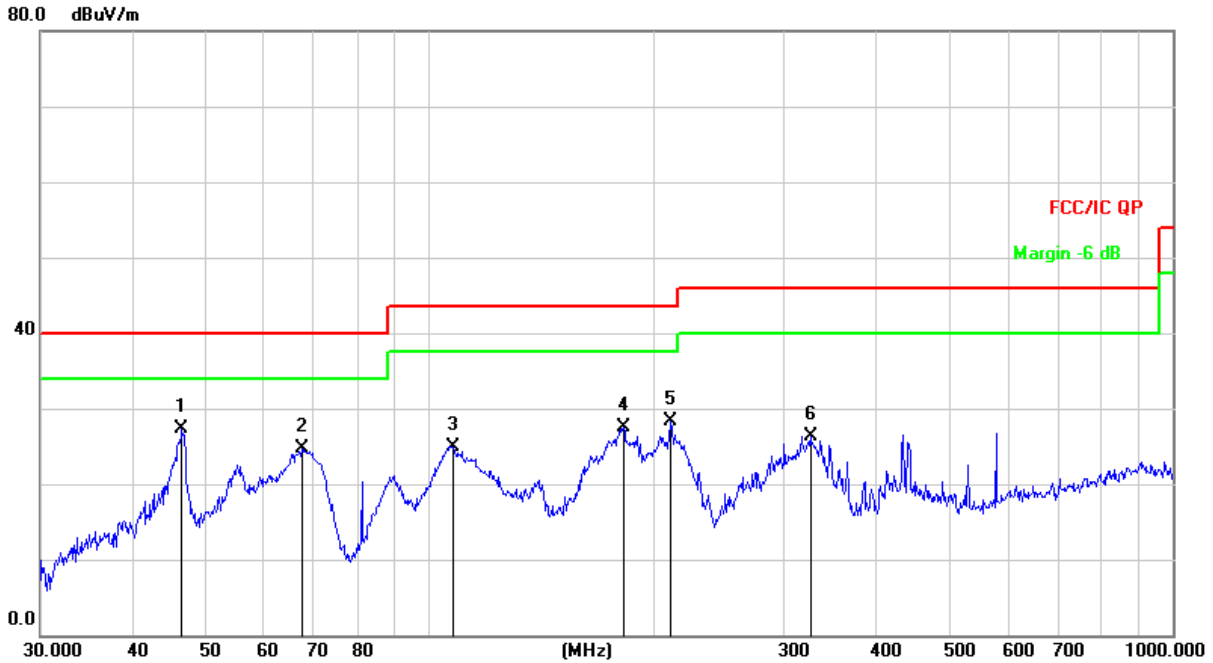

Remark:

Factor = Antenna Factor + Cable Loss – Pre-amplifier.

No.	Mk.	Freq. MHz	Reading Level dBuV	Correct Factor dB	Measure- ment dBuV/m	Limit dB/m	Over dB	Detector
1	*	46.5030	41.61	-14.38	27.23	40.00	-12.77	QP
2		67.4382	41.32	-16.58	24.74	40.00	-15.26	QP
3		107.8877	40.82	-15.98	24.84	43.50	-18.66	QP
4		182.5592	43.96	-16.46	27.50	43.50	-16.00	QP
5		211.5265	43.24	-15.02	28.22	43.50	-15.28	QP
6		325.5958	38.09	-11.72	26.37	46.00	-19.63	QP

Temperature:	26°C	Relative Humidity:	54%
Pressure:	101 kpa	Test Voltage :	AC 120V/60Hz
Test Mode :	Wireless Charging	Polarization :	Vertical

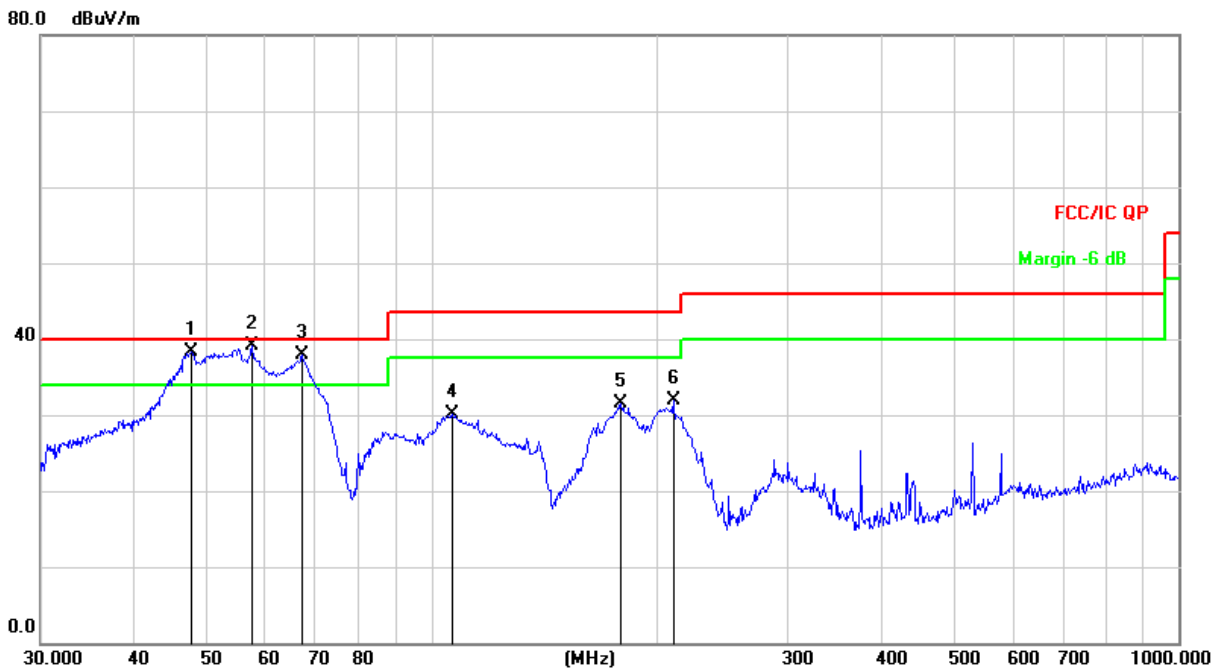

Remark:

Factor = Antenna Factor + Cable Loss – Pre-amplifier.

No.	Mk.	Freq. MHz	Reading Level dBuV	Correct Factor dB	Measure- ment dBuV/m	Limit dB/m	Over dB	Detector
1	!	47.6586	52.54	-14.28	38.26	40.00	-1.74	QP
2	*	57.5939	53.56	-14.52	39.04	40.00	-0.96	QP
3	!	67.2022	54.37	-16.52	37.85	40.00	-2.15	QP
4		106.7587	46.07	-15.91	30.16	43.50	-13.34	QP
5		179.3863	48.10	-16.68	31.42	43.50	-12.08	QP
6		210.7860	46.96	-15.04	31.92	43.50	-11.58	QP

## 8. EUT PHOTOGRAPHS

EUT Photo 1

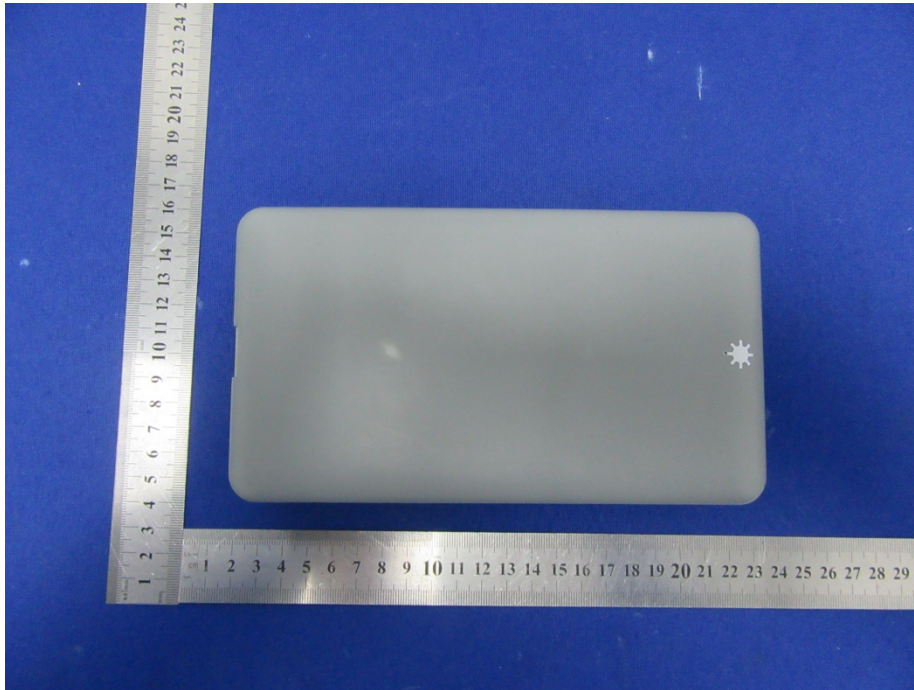

EUT Photo 2

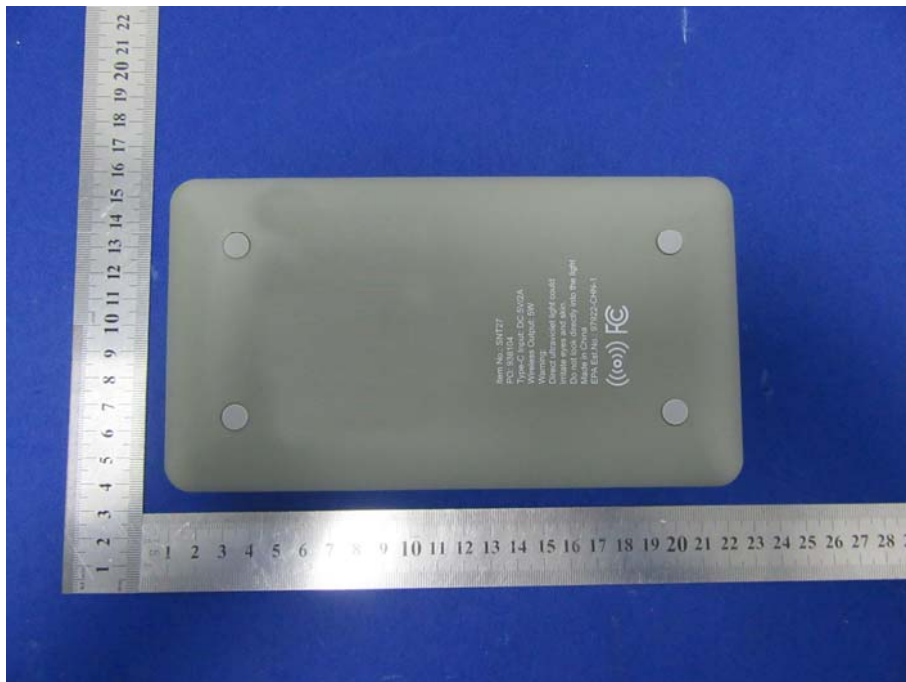

## 9. EUT TEST SETUP PHOTOGRAPHS

### Conducted emissions



Radiated Measurement Photos

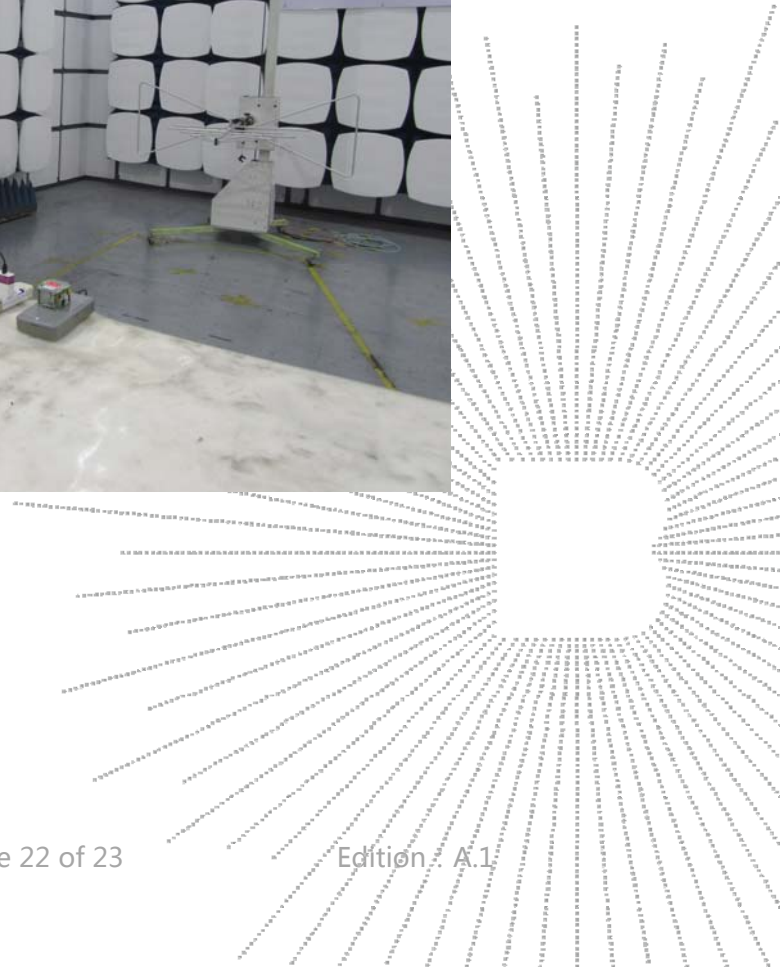
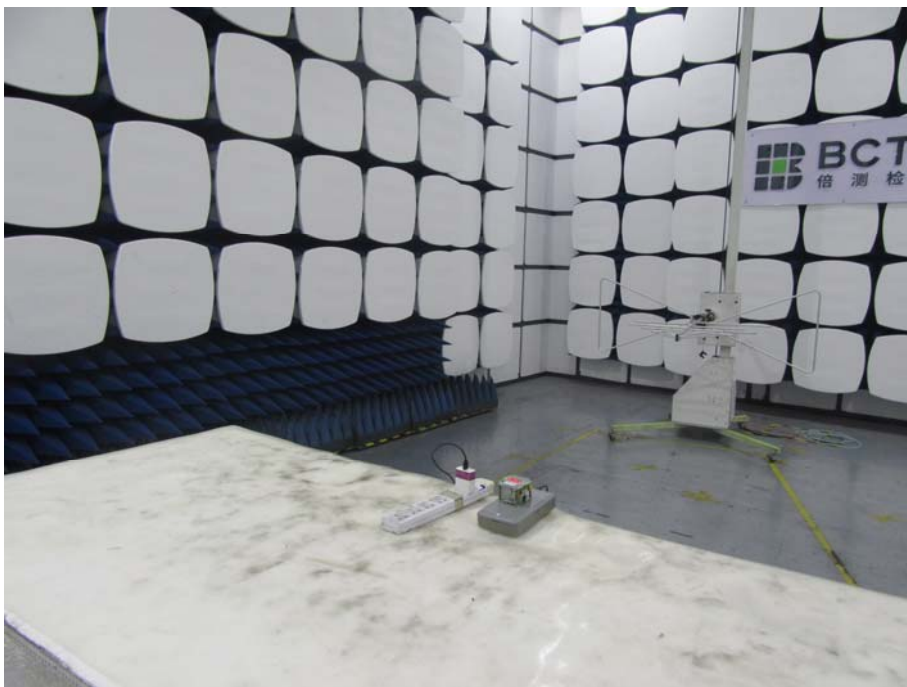
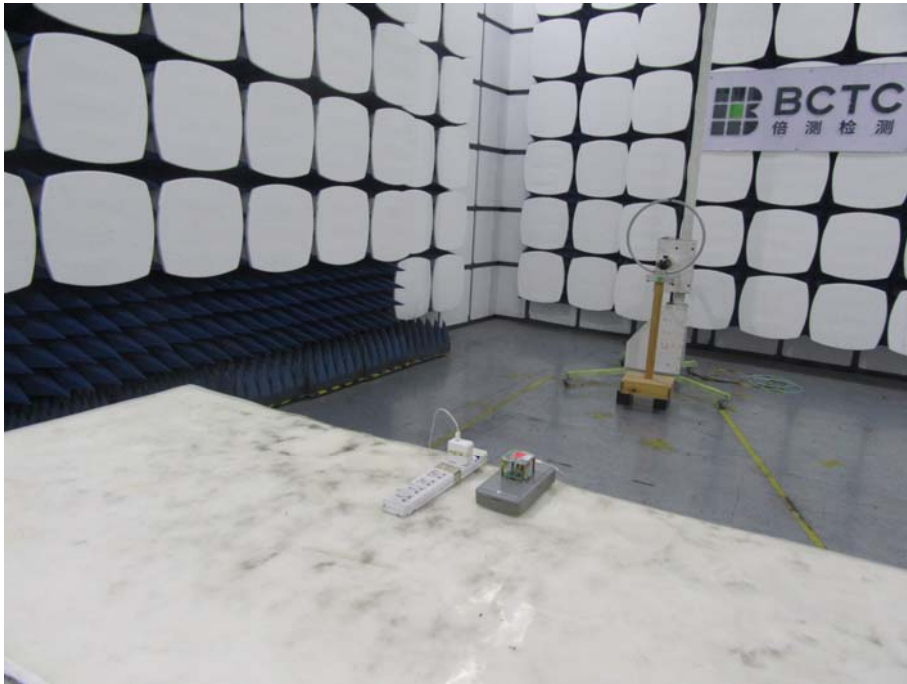

## STATEMENT

- 1.The equipment lists are traceable to the national reference standards.
- 2.The test report can not be partially copied unless prior written approval is issued from our lab.
- 3.The test report is invalid without stamp of laboratory.
- 4.The test report is invalid without signature of person(s) testing and authorizing.
- 5.The test process and test result is only related to the Unit Under Test.
- 6.The quality system of our laboratory is in accordance with ISO/IEC17025.
- 7.If there is any objection to report, the client should inform issuing laboratory within 15 days from the date of receiving test report.

Address:

1-2F, East of B Building, Pengzhou Industrial Park, Fuyuan 1st Road, Qiaotou, Fuyong Street, Bao'an District, Shenzhen, Guangdong, China

TEL : 400-788-9558

P. C.: 518103

FAX : 0755-33229357

Website : <http://www.bctc-lab.com>

E-Mail : [bctc@bctc-lab.com.cn](mailto:bctc@bctc-lab.com.cn)

\*\*\*\*\* END \*\*\*\*\*

