

FCC TEST REPORT

For

Crave LLC

Wireless Charger

Model No.: CRVWC101

Prepared For : Crave LLC

Address : 5570 S Irwin Dr Wasilla, AK 99623 USA

Prepared By : Shenzhen Anbotek Compliance Laboratory Limited

Address : 1/F, Building D, Sogood Science and Technology Park, Sanwei
community, Hangcheng Street, Bao'an District, Shenzhen, Guangdong,
China.518102

Tel: (86) 755-26066365 Fax: (86) 755-26014772

Report Number : SZAWW180125002-01

Date of Test : Jan. 25~31, 2018

Date of Report : Jan. 31, 2018

Contents

1. General Information.....	4
1.1. Client Information.....	4
1.2. Description of Device (EUT).....	4
1.3. Auxiliary Equipment Used During Test.....	4
1.4. Description of Test Modes.....	5
1.5. List of channels.....	5
1.6. Description Of Test Setup.....	6
1.7. Test Equipment List.....	7
1.8. Measurement Uncertainty.....	8
1.9. Description of Test Facility.....	8
2. Summary of Test Results.....	9
3. Conducted Emission Test.....	10
3.1. Test Standard and Limit.....	10
3.2. Test Setup.....	10
3.3. Test Procedure.....	10
3.4. Test Data.....	10
4. Radiation Spurious Emission and Band Edge.....	15
4.1. Test Standard and Limit.....	15
4.2. Test Setup.....	15
4.3. Test Procedure.....	16
4.4. Test Data.....	17
APPENDIX I -- TEST SETUP PHOTOGRAPH.....	21
APPENDIX II -- EXTERNAL PHOTOGRAPH.....	23
APPENDIX III -- INTERNAL PHOTOGRAPH.....	26

TEST REPORT

Applicant : Crave LLC
Manufacturer : Crave HK CO LTD
Product Name : Wireless Charger
Model No. : CRVWC101
Trade Mark : CRAVE
Rating(s) : Input: 5V===2A, 9V===1.8A
Output: 5V===1A, 9V===1.1A

Test Standard(s) : FCC Part15 Subpart C 2017, Paragraph 15.209

Test Method(s) : ANSI C63.10: 2013

The device described above is tested by Shenzhen Anbotek Compliance Laboratory Limited to determine the maximum emission levels emanating from the device and the severe levels of the device can endure and its performance criterion. The measurement results are contained in this test report and Shenzhen Anbotek Compliance Laboratory Limited is assumed full of responsibility for the accuracy and completeness of these measurements. Also, this report shows that the EUT (Equipment Under Test) is technically compliant with the FCC Part 15 Subpart C requirements.

This report applies to above tested sample only and shall not be reproduced in part without written approval of Shenzhen Anbotek Compliance Laboratory Limited.

Date of Test : Jan. 25~31, 2018

Prepared by :



Winkey Wang

(Tested Engineer / Winkey Wang)

Reviewer :

Tangcy. T.

(Project Manager / Tangcy. T)

Approved & Authorized Signer :

Tom Chen

(Manager / Tom Chen)

1. General Information

1.1. Client Information

Applicant	:	Crave LLC
Address	:	5570 S Irwin Dr Wasilla, AK 99623 USA
Manufacturer	:	Crave HK CO LTD
Address	:	1313 Block 2, TongJian Building Shen Nan Zhong Road, Futian, Shenzhen 518031

1.2. Description of Device (EUT)

Product Name	:	Wireless Charger	
Model No.	:	CRVWC101	
Trade Mark	:	CRAVE	
Test Power Supply	:	AC 120V, 60Hz for adapter/AC 240V, 60Hz for adapter	
Product Description	:	Operation Frequency:	110-205KHz
		Number of Channel:	20 Channels
		Modulation Type:	MSK
		Antenna Type:	Loop Antenna
		Antenna Gain(Peak):	0 dBi
Remark: 1) For a more detailed features description, please refer to the manufacturer's specifications or the User's Manual.			

1.3. Auxiliary Equipment Used During Test

Adapter	:	Manufacturer: Samsung M/N: ETA-U90CBC S/N: RT6FB17ZS/B-E Input: AC 100-240V, 50-60Hz, 0.35A Output: DC 5V, 2A
Mobile Phone	:	Manufacturer: SAMSUNG
		M/N: SM-G9550 S/N: R28J636WJ1B CE , FCC, DOC

1.4. Description of Test Modes

To investigate the maximum EMI emission characteristics generated from EUT, the test system was pre-scanning tested based on the consideration of following EUT operation mode or test configuration mode which possibly have effect on EMI emission level. Each of these EUT operation mode(s) or test configuration mode(s) mentioned above was evaluated respectively.

Pretest Mode	Description
Mode 1	CH01
Mode 2	CH10
Mode 3	CH20
Mode 4	Keeping TX+Charging mode

For Conducted Emission	
Final Test Mode	Description
Mode 4	Keeping TX+Charging mode

For Radiated Emission	
Final Test Mode	Description
Mode 1	CH01
Mode 2	CH10
Mode 3	CH20
Mode 4	Keeping TX+Charging mode

1.5. List of channels

Channel	Freq. (MHz)	Channel	Freq. (MHz)	Channel	Freq. (MHz)	Channel	Freq. (MHz)
1	0.110	6	0.135	11	0.160	16	0.185
2	0.115	7	0.140	12	0.165	17	0.190
3	0.120	8	0.145	13	0.170	18	0.195
4	0.125	9	0.150	14	0.175	19	0.200
5	0.130	10	0.155	15	0.180	20	0.205

1.6. Description Of Test Setup

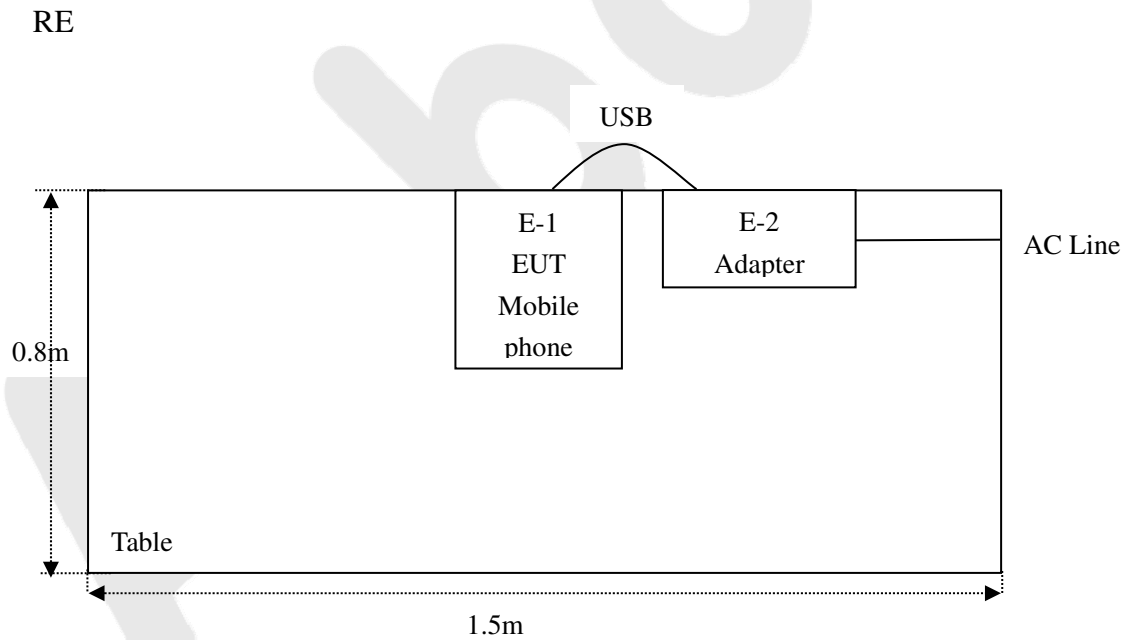
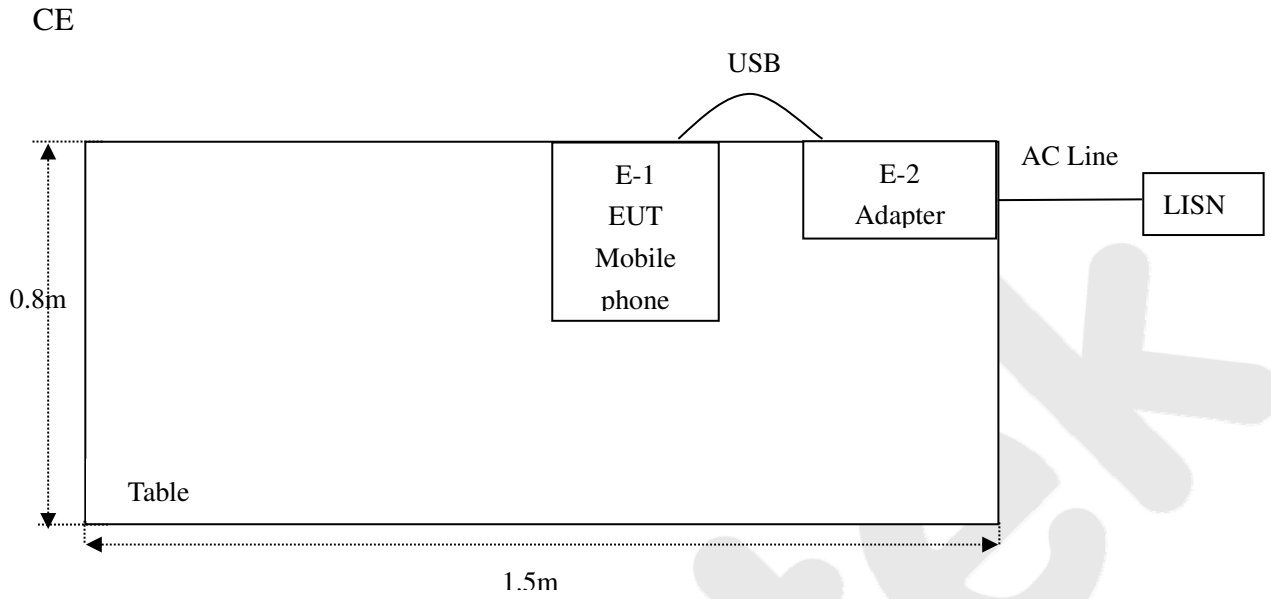

1.7. Test Equipment List

Item	Equipment	Manufacturer	Model No.	Serial No.	Last Cal.	Cal. Interval
1.	L.I.S.N. Artificial Mains Network	Rohde & Schwarz	ENV216	100055	Nov. 17, 2017	1 Year
2.	EMI Test Receiver	Rohde & Schwarz	ESCI	100627	Nov. 17, 2017	1 Year
3.	RF Switching Unit	Compliance Direction	RSU-M2	38303	Nov. 17, 2017	1 Year
4.	Spectrum Analysis	Agilent	E4407B	US39390582	Nov. 17, 2017	1 Year
5.	Spectrum Analysis	Agilent	N9038A	MY53227295	Nov. 17, 2017	1 Year
6.	Preamplifier	SKET Electronic	BK1G18G3 0D	KD17503	Nov. 17, 2017	1 Year
7.	EMI Test Receiver	Rohde & Schwarz	ESPI	101604	Nov. 17, 2017	1 Year
8.	Double Ridged Horn Antenna	Instruments corporation	GTH-0118	351600	Nov. 20, 2017	1 Year
9.	Bilog Broadband Antenna	Schwarzbeck	VULB9163	VULB 9163-289	Nov. 20, 2017	1 Year
10.	Loop Antenna	Schwarzbeck	HFH2-Z2	100047	Nov. 17, 2017	1 Year
11.	Horn Antenna	Schwarzbeck	BBHA9170	9170-375	Nov. 17, 2017	1 Year
12.	Pre-amplifier	SONOMA	310N	186860	Nov. 17, 2017	1 Year
13.	EMI Test Software EZ-EMC	SHURPLE	N/A	N/A	N/A	N/A
14.	RF Test Control System	YIHENG	YH3000	2017430	Nov. 18, 2017	1 Year
15.	Power Sensor	DAER	RPR3006W	15I00041SN045	Nov. 17, 2017	1 Year
16.	Power Sensor	DAER	RPR3006W	15I00041SN046	Nov. 17, 2017	1 Year
17.	MXA Spectrum Analysis	Agilent	N9020A	MY51170037	Nov. 18, 2017	1 Year
18.	MXG RF Vector Signal Generator	Agilent	N5182A	MY48180656	Nov. 18, 2017	1 Year
19.	Signal Generator	Agilent	E4421B	MY41000743	Nov. 18, 2017	1 Year
20.	DC Power Supply	LW	TPR-6410D	349315	Nov. 01, 2017	1 Year
21.	Constant Temperature Humidity Chamber	Sertep	ZJ-HWHS8 0B	ZJ-17042804	Nov. 01, 2017	1 Year

1.8. Measurement Uncertainty

Radiation Uncertainty	:	Ur = 4.1 dB (Horizontal)
		Ur = 4.3 dB (Vertical)
Conduction Uncertainty	:	Uc = 3.4dB

1.9. Description of Test Facility

The test facility is recognized, certified, or accredited by the following organizations:

FCC-Registration No.: 184111

Shenzhen Anbotek Compliance Laboratory Limited, EMC Laboratory has been registered and fully described in a report filed with the (FCC) Federal Communications Commission. The acceptance letter from the FCC is maintained in our files. Registration No. 184111, July 31, 2017.

ISED-Registration No.: 8058A-1

Shenzhen Anbotek Compliance Laboratory Limited, EMC Laboratory has been registered and fully described in a report filed with the (ISED) Innovation, Science and Economic Development Canada. The acceptance letter from the ISED is maintained in our files. Registration 8058A-1, June 13, 2016.

Test Location

All Emissions tests were performed at Shenzhen Anbotek Compliance Laboratory Limited. at 1/F, Building D, Sogood Science and Technology Park, Sanwei community, Hangcheng Street, Bao'an District, Shenzhen, Guangdong, China.518102

2. Summary of Test Results

Standard Section	Test Item	Result
FCC Part 15, Paragraph 15.207	Conducted Emission Test	PASS
FCC Part 15, Paragraph 15.209(a)(f)	Spurious Emission	PASS

Anbotek

3. Conducted Emission Test

3.1. Test Standard and Limit

Test Standard	FCC Part15 Section 15.207		
Test Limit	Frequency	Maximum RF Line Voltage (dBuV)	
		Quasi-peak Level	Average Level
	150kHz~500kHz	66 ~ 56 *	56 ~ 46 *
	500kHz~5MHz	56	46
5MHz~30MHz	60	50	

Remark: (1) *Decreasing linearly with logarithm of the frequency.
(2) The lower limit shall apply at the transition frequency.

3.2. Test Setup

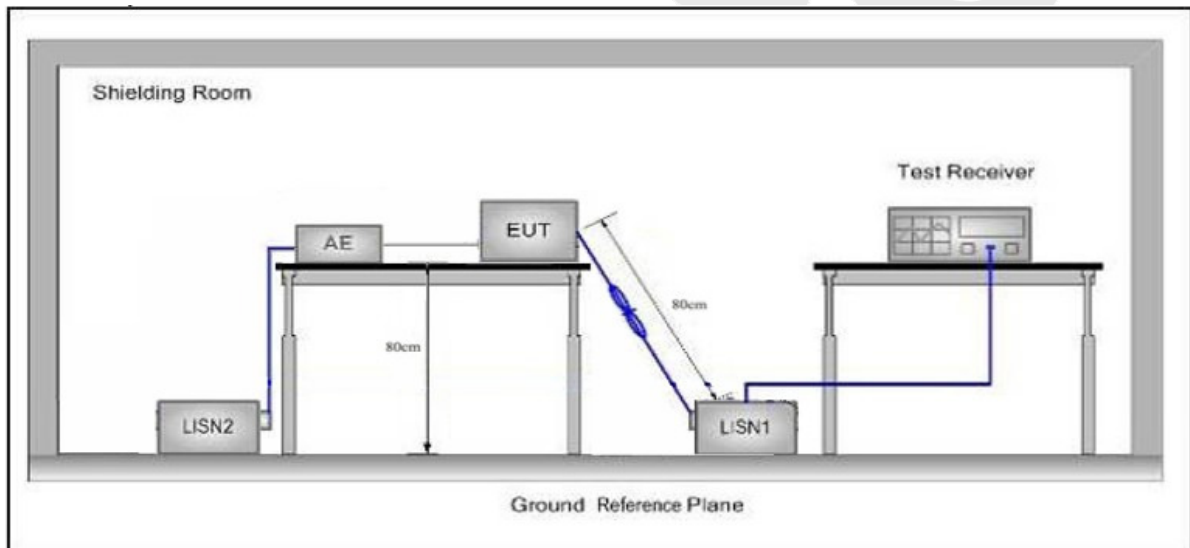

3.3. Test Procedure

The EUT system is connected to the power mains through a line impedance stabilization network (L.I.S.N.). This provides a 50ohm coupling impedance for the EUT system. Please refer the block diagram of the test setup and photographs. Both sides of AC line are checked to find out the maximum conducted emission. In order to find the maximum emission levels, the relative positions of equipment and all of the interface cables shall be changed according to FCC ANSI C63.10-2013 on Conducted Emission Measurement.

The bandwidth of test receiver (ESCI) set at 9kHz.

The frequency range from 150kHz to 30MHz is checked.

3.4. Test Data

Please to see the following pages

Conducted Emission Test Data

Test Site: 1# Shielded Room
 Operating Condition: Keeping TX+Charging mode
 Test Specification: AC 120V, 60Hz for adapter
 Comment: Live Line
 Tem.:25.4°C Hum.:54%

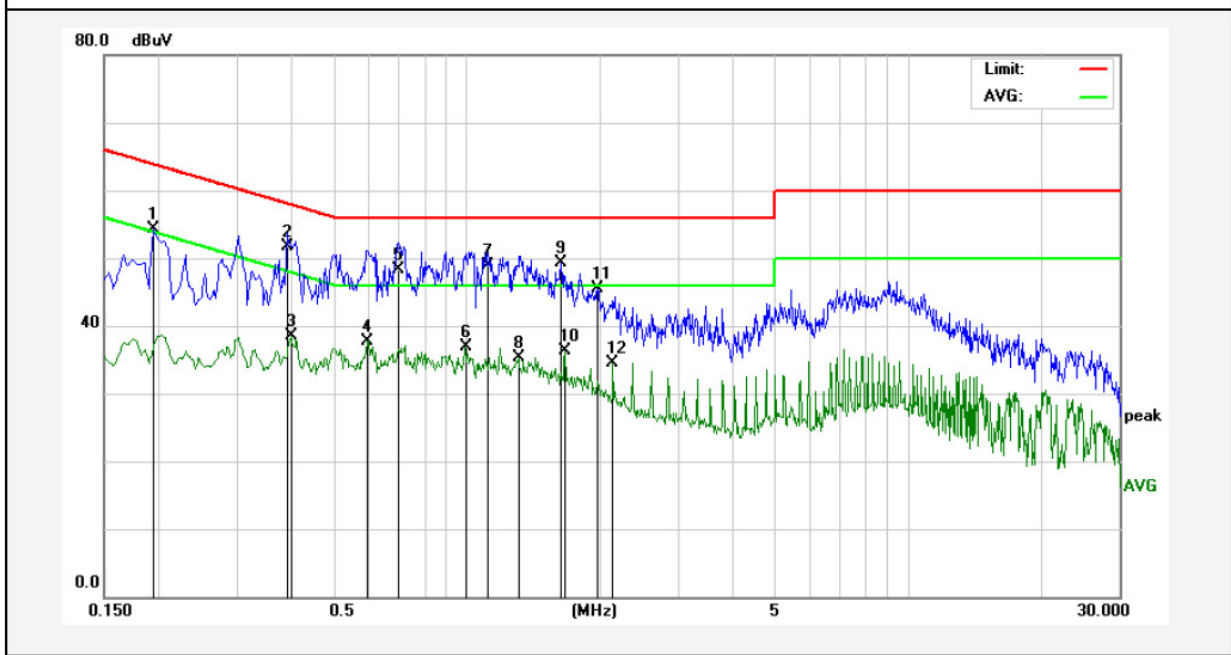

No.	Freq. (MHz)	Reading (dBuV)	Factor (dB)	Result (dBuV)	Limit dBuV	Over Limit (dB)	Detector	Remark
1	0.1940	36.35	17.90	54.25	63.86	-9.61	QP	
2	0.3899	33.77	17.93	51.70	58.06	-6.36	QP	
3	0.3980	20.54	17.93	38.47	47.89	-9.42	AVG	
4	0.5940	19.70	18.01	37.71	46.00	-8.29	AVG	
5	0.6980	30.27	18.04	48.31	56.00	-7.69	QP	
6	0.9860	18.75	18.12	36.87	46.00	-9.13	AVG	
7	1.1140	30.84	18.12	48.96	56.00	-7.04	QP	
8	1.3060	17.14	18.13	35.27	46.00	-10.73	AVG	
9	1.6300	31.23	18.13	49.36	56.00	-6.64	QP	
10	1.6700	18.12	18.13	36.25	46.00	-9.75	AVG	
11	1.9740	27.36	18.14	45.50	56.00	-10.50	QP	
12	2.1340	16.36	18.14	34.50	46.00	-11.50	AVG	

Conducted Emission Test Data

Test Site: 1# Shielded Room
 Operating Condition: Keeping TX+Charging mode
 Test Specification: AC 120V, 60Hz for adapter
 Comment: Neutral Line
 Tem.:25.4°C Hum.:54%

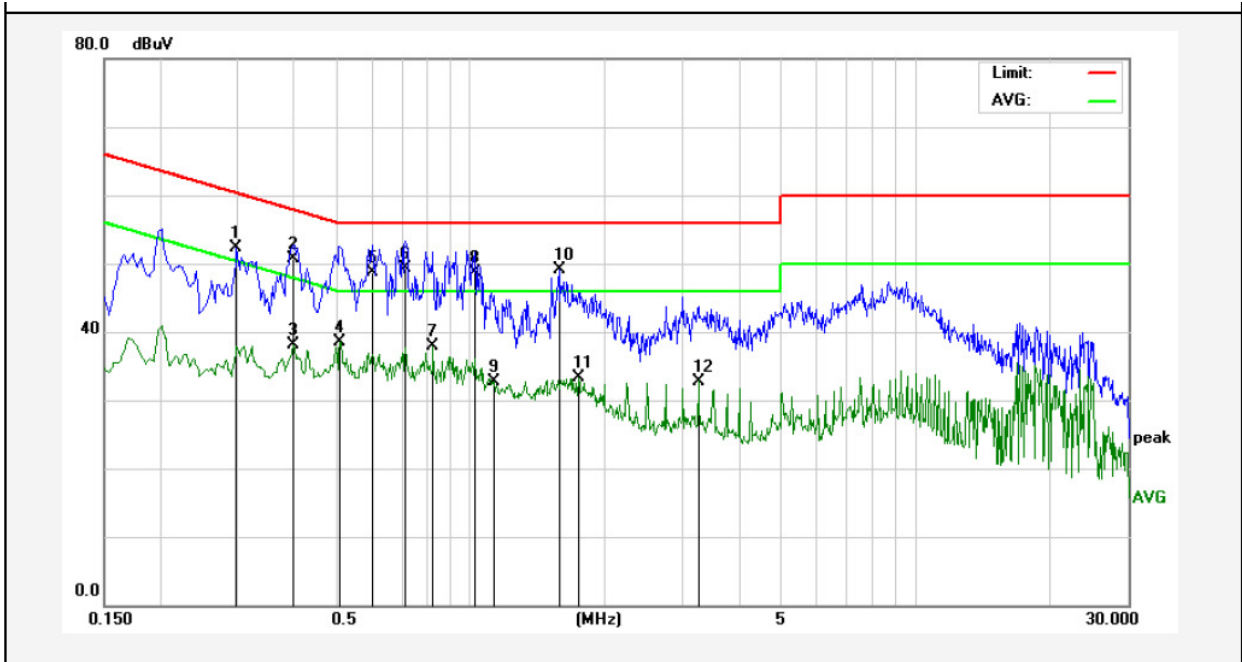

No.	Freq. (MHz)	Reading (dBuV)	Factor (dB)	Result (dBuV)	Limit dBuV	Over Limit (dB)	Detector	Remark
1	0.2980	34.38	17.89	52.27	60.30	-8.03	QP	
2	0.3980	32.83	17.93	50.76	57.89	-7.13	QP	
3	0.3980	20.09	17.93	38.02	47.89	-9.87	AVG	
4	0.5100	20.49	17.98	38.47	46.00	-7.53	AVG	
5	0.6020	30.74	18.01	48.75	56.00	-7.25	QP	
6	0.7140	31.27	18.04	49.31	56.00	-6.69	QP	
7	0.8220	19.89	18.07	37.96	46.00	-8.04	AVG	
8	1.0220	30.53	18.12	48.65	56.00	-7.35	QP	
9	1.1300	14.58	18.12	32.70	46.00	-13.30	AVG	
10	1.5780	31.02	18.13	49.15	56.00	-6.85	QP	
11	1.7500	15.08	18.13	33.21	46.00	-12.79	AVG	
12	3.2580	14.63	18.17	32.80	46.00	-13.20	AVG	

Conducted Emission Test Data

Test Site: 1# Shielded Room
 Operating Condition: Keeping TX+Charging mode
 Test Specification: AC 240V, 60Hz for adapter
 Comment: Live Line
 Tem.:25.4°C Hum.:54%

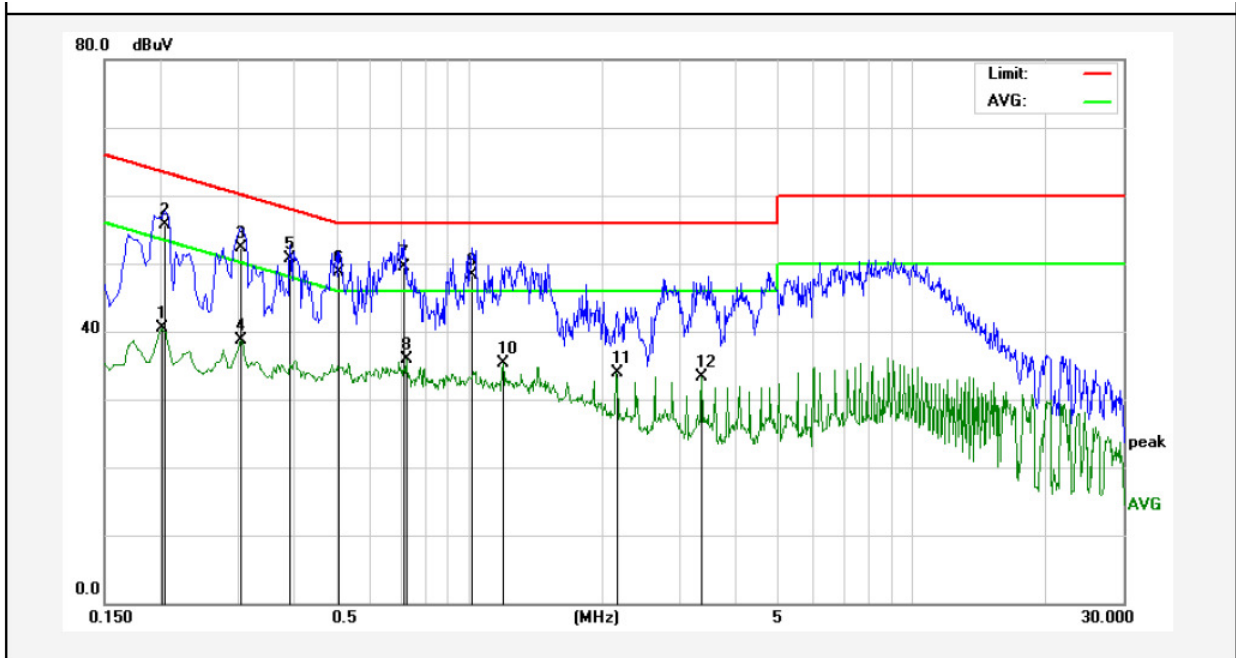

No.	Freq. (MHz)	Reading (dBuV)	Factor (dB)	Result (dBuV)	Limit dBuV	Over Limit (dB)	Detector	Remark
1	0.2020	22.52	17.90	40.42	53.52	-13.10	AVG	
2	0.2060	37.77	17.90	55.67	63.36	-7.69	QP	
3	0.3060	34.36	17.89	52.25	60.08	-7.83	QP	
4	0.3060	20.86	17.89	38.75	50.08	-11.33	AVG	
5	0.3940	32.74	17.93	50.67	57.98	-7.31	QP	
6	0.5100	30.80	17.98	48.78	56.00	-7.22	QP	
7	0.7140	31.42	18.04	49.46	56.00	-6.54	QP	
8	0.7220	17.82	18.05	35.87	46.00	-10.13	AVG	
9	1.0180	30.21	18.12	48.33	56.00	-7.67	QP	
10	1.1940	17.21	18.12	35.33	46.00	-10.67	AVG	
11	2.1460	15.74	18.14	33.88	46.00	-12.12	AVG	
12	3.3540	15.22	18.17	33.39	46.00	-12.61	AVG	

Conducted Emission Test Data

Test Site: 1# Shielded Room
 Operating Condition: Keeping TX+Charging mode
 Test Specification: AC 240V, 60Hz for adapter
 Comment: Neutral Line
 Tem.:25.4°C Hum.:54%

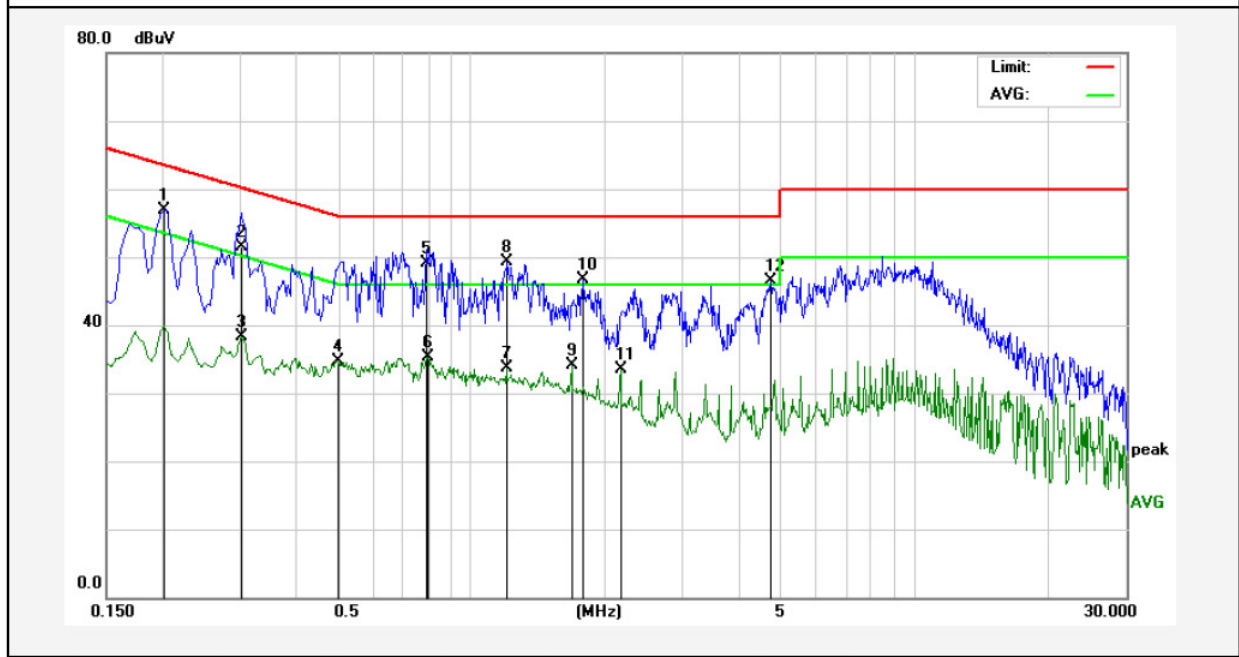

No.	Freq. (MHz)	Reading (dBuV)	Factor (dB)	Result (dBuV)	Limit dBuV	Over Limit (dB)	Detector	Remark
1	0.2020	39.08	17.90	56.98	63.52	-6.54	QP	
2	0.3020	33.58	17.89	51.47	60.19	-8.72	QP	
3	0.3020	20.47	17.89	38.36	50.19	-11.83	AVG	
4	0.4980	16.69	17.98	34.67	46.03	-11.36	AVG	
5	0.7940	31.03	18.06	49.09	56.00	-6.91	QP	
6	0.7980	17.19	18.07	35.26	46.00	-10.74	AVG	
7	1.2020	15.60	18.12	33.72	46.00	-12.28	AVG	
8	1.2059	31.11	18.12	49.23	56.00	-6.77	QP	
9	1.6820	16.05	18.13	34.18	46.00	-11.82	AVG	
10	1.7860	28.48	18.14	46.62	56.00	-9.38	QP	
11	2.1700	15.37	18.14	33.51	46.00	-12.49	AVG	
12	4.7460	28.39	18.20	46.59	56.00	-9.41	QP	

4. Radiation Spurious Emission and Band Edge

4.1. Test Standard and Limit

Test Standard	FCC Part15 C Section 15.209 and 15.205				
Test Limit	Frequency (MHz)	Field strength (microvolt/meter)	Limit (dBuV/m)	Remark	Measurement distance (m)
	0.009MHz~0.490MHz	2400/F(kHz)	-	-	300
	0.490MHz-1.705MHz	24000/F(kHz)	-	-	30
	1.705MHz-30MHz	30	-	-	30
	30MHz~88MHz	100	40.0	Quasi-peak	3
	88MHz~216MHz	150	43.5	Quasi-peak	3
	216MHz~960MHz	200	46.0	Quasi-peak	3
	960MHz~1000MHz	500	54.0	Quasi-peak	3
	Above 1000MHz	500	54.0	Average	3
-		74.0	Peak	3	

Remark:

(1)The lower limit shall apply at the transition frequency.

(2) 15.35(b), Unless otherwise specified, the limit on peak radio frequency emissions is 20dB above the maximum permitted average emission limit applicable to the equipment under test. This peak limit applies to the total peak emission level radiated by the device.

4.2. Test Setup

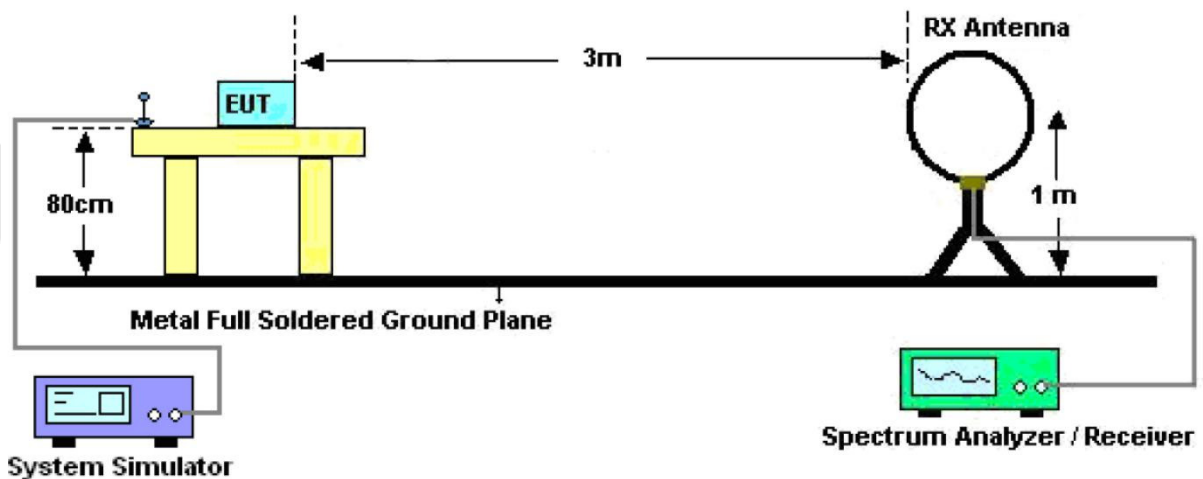

Figure 1. Below 30MHz

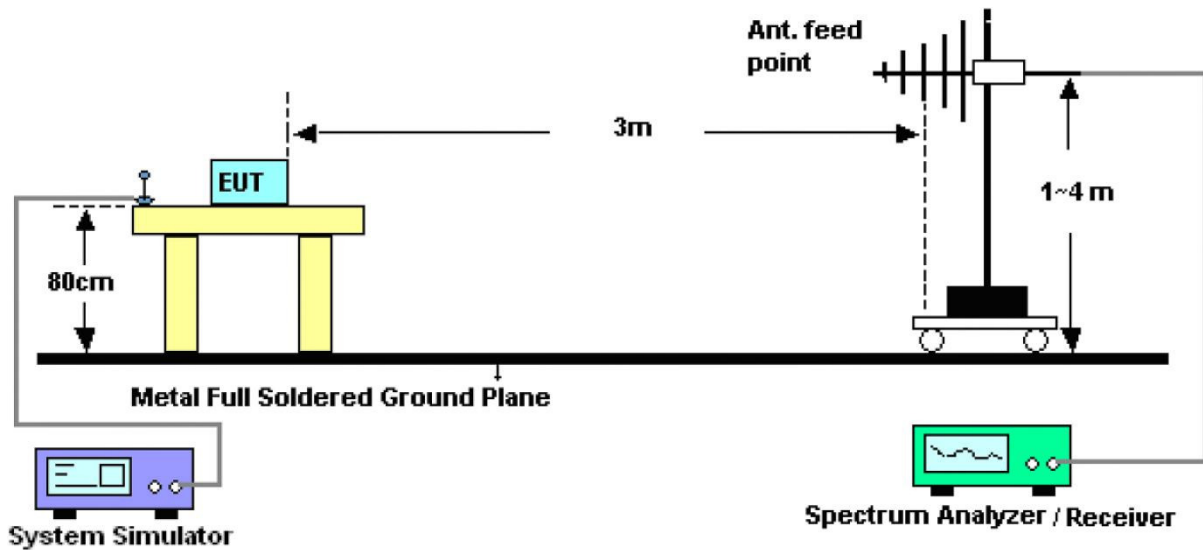

Figure 2. 30MHz to 1GHz

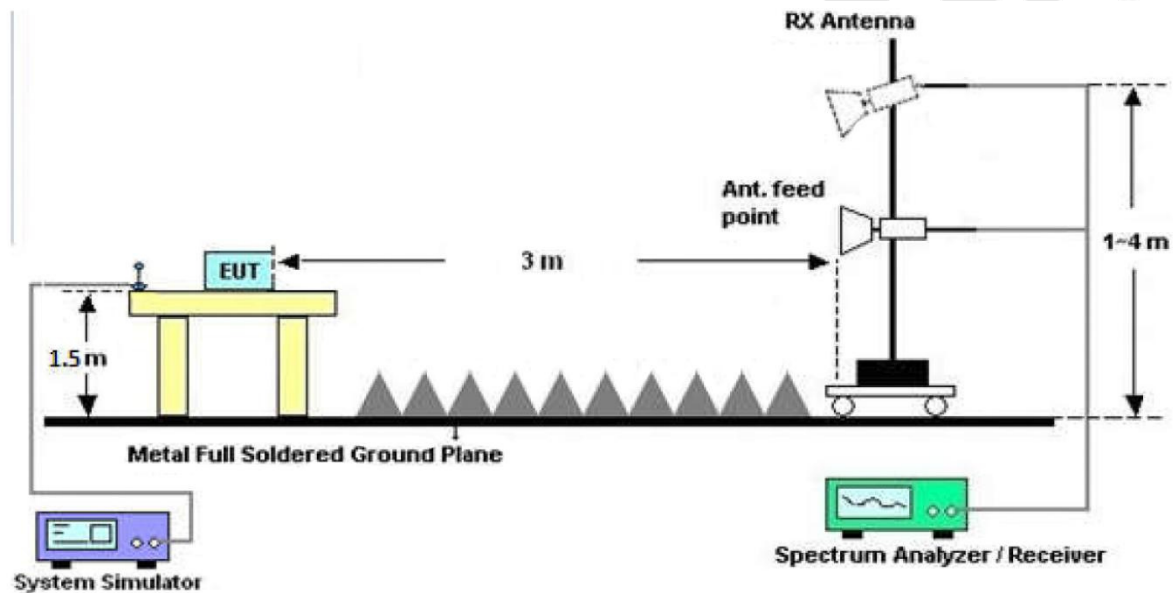

Figure 3. Above 1 GHz

4.3. Test Procedure

For below 1GHz: The EUT is placed on a turntable, which is 0.8m above the ground plane.

For above 1GHz: The EUT is placed on a turntable, which is 1.5m above the ground plane.

The turn table can rotate 360 degrees to determine the position of the maximum emission level. The EUT is set 3 meters away from the receiving antenna which is mounted on a antenna tower. The antenna can be moved up and down from 1 to 4 meters to find out the maximum emission level. Rotated the EUT through three orthogonal axes to determine the maximum emissions, both horizontal and vertical polarization of the antenna are set on test. The EUT is tested in 9*6*6 Chamber. The device is evaluated in xyz orientation.

For 9kHz to 150kHz, Set the spectrum analyzer as:

RBW = 200Hz, VBW = 1kHz, Detector= Quasi-Peak, Trace mode= Max hold, Sweep- auto couple.

For 150kHz to 30MHz, Set the spectrum analyzer as:

RBW = 9KHz, VBW =30kHz, Detector= Quasi-Peak, Trace mode= Max hold, Sweep- auto couple.

For 30MHz to 1000MHz, Set the spectrum analyzer as:

RBW = 100kHz, VBW =300kHz, Detector= Quasi-Peak, Trace mode= Max hold, Sweep- auto couple.

4.4. Test Data

PASS

Anbotek

Test Results

(Between 9KHz – 30MHz)

Job No.:	SZAWW180125002-01		
Standard:	FCC PART15 C _3m	Power Source:	AC 120V, 60Hz for adapter
Test item:	Radiation Test	Temp.(C)/Hum.(%RH):	23.2(C)/53.4% RH
Test Mode:	Keeping TX+Charging mode	Distance:	3m

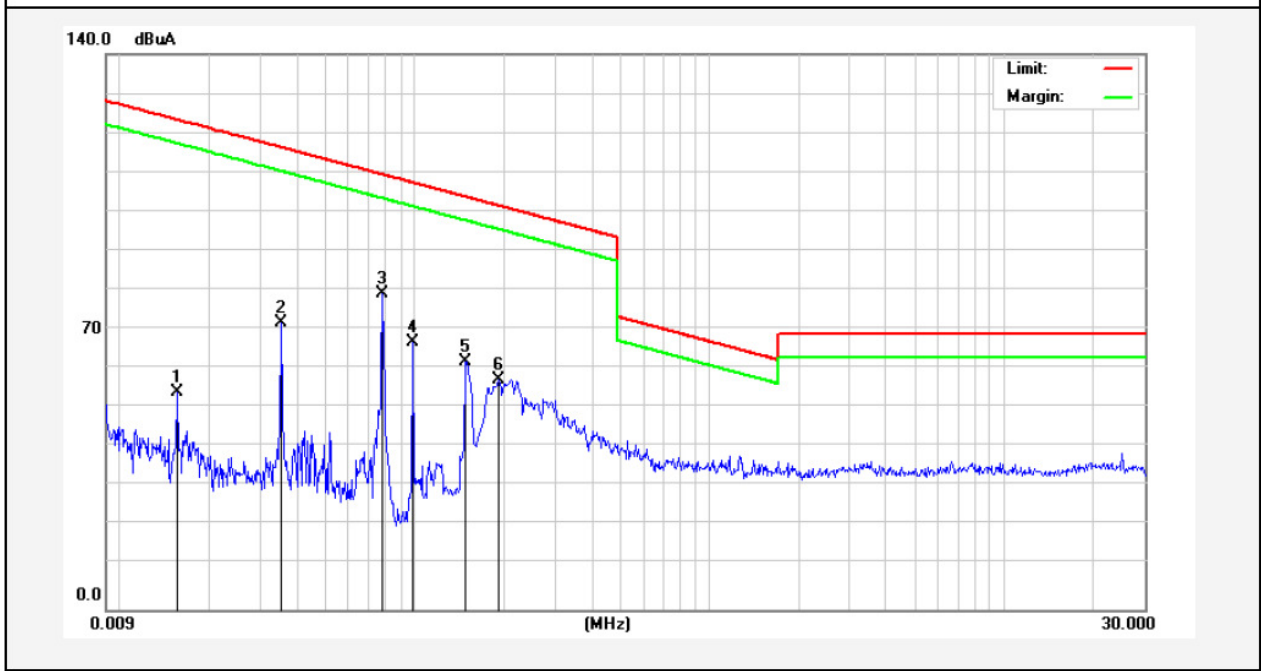

Frequency (MHz)	Read Level (dBuV)	Antenna Factor (dB/m)	Cable Loss (dB)	Preamp Factor (dB)	Level (dBuV/m)	Limit (dBuV/m)	Over Limit (dB)	Detector	degree
									(dgc)
0.0158	48.33	19.26	2.51	0	70.10	143.46	-73.36	Peak	47
0.0158	32.94	19.26	2.51	0	54.71	123.46	-68.75	AV	47
0.0354	52.39	19.30	2.53	0	74.22	136.50	-62.28	Peak	84
0.0354	50.34	19.30	2.53	0	72.17	116.50	-44.33	AV	84
0.0782	58.31	19.29	2.54	0	80.14	129.65	-49.51	Peak	114
0.0782	57.78	19.29	2.54	0	79.61	109.65	-30.04	AV	114
0.0990	45.47	19.32	2.55	0	67.34	107.61	-40.27	QP	96
0.1499	40.62	19.45	2.56	0	62.63	104.03	-41.40	QP	141
0.1940	35.98	19.50	2.53	0	58.01	101.80	-43.79	QP	354

Remark: According to FCC PART 15.209 (d), the emission limits for the frequency bands 9–90 kHz, 110–490 kHz and above 1000 MHz, Radiated emission limits in these three bands are based on measurements employing an average detector.

(Between 30MHz –1000 MHz)

Job No.:	SZAWW180125002-01	Polarization:	Horizontal
Standard:	FCC PART15 C _3m	Power Source:	AC 120V, 60Hz for adapter
Test item:	Radiation Test	Temp.(C)/Hum.(%RH):	23.2(C)/53.4% RH
Test Mode:	Keeping TX+Charging mode	Distance:	3m

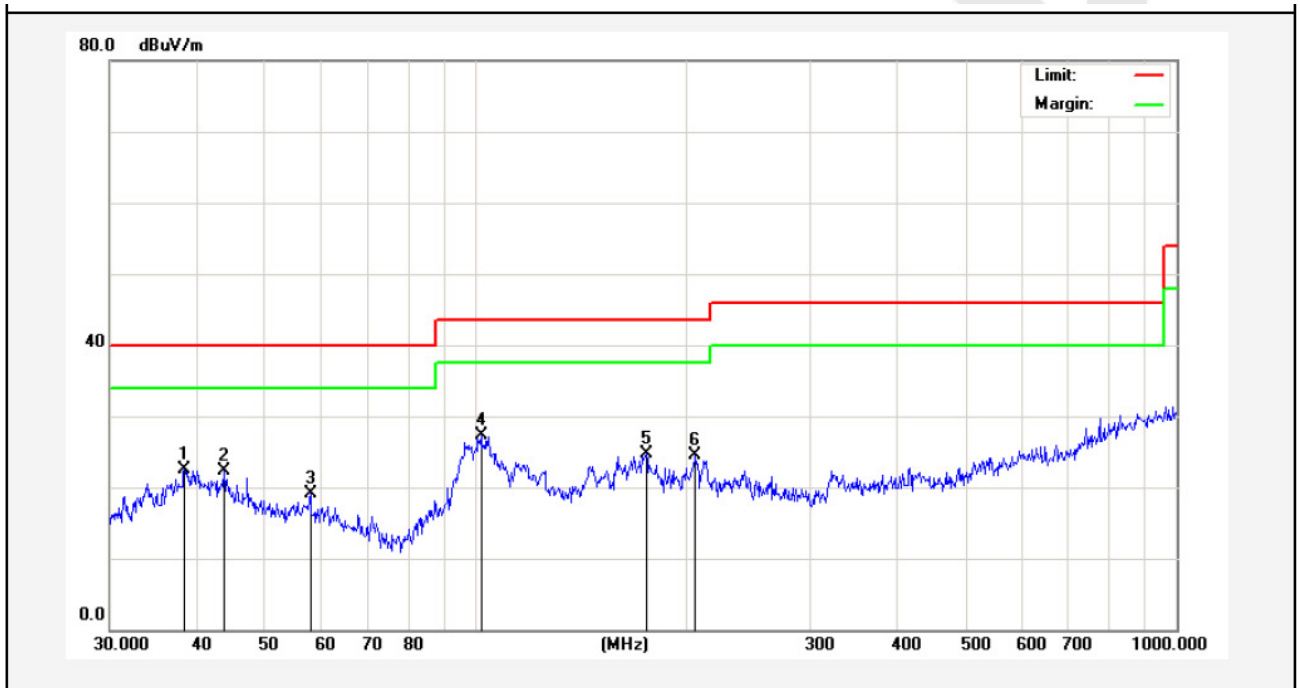

No.	Freq. (MHz)	Reading (dBuV/m)	Factor (dB/m)	Result (dBuV/m)	Limit (dBuV/)	Over Limit (dB)	Detector	Height (cm)	degree (deg)	Remark
1	38.3462	31.70	-9.26	22.44	40.00	-17.56	QP	300	16	
2	43.6584	31.37	-9.07	22.30	40.00	-17.70	QP	300	77	
3	57.9993	29.96	-10.89	19.07	40.00	-20.93	QP	300	154	
4	101.6443	42.04	-14.74	27.30	43.50	-16.20	QP	300	197	
5	175.0368	38.48	-13.71	24.77	43.50	-18.73	QP	300	214	
6	205.6751	37.48	-12.99	24.49	43.50	-19.01	QP	300	257	

Job No.:	SZAWW180125002-01	Polarization:	Vertical
Standard:	FCC PART15 C _3m	Power Source:	AC 120V, 60Hz for adapter
Test item:	Radiation Test	Temp.(C)/Hum.(%RH):	23.2(C)/53.4% RH
Test Mode:	Keeping TX+Charging mode	Distance:	3m

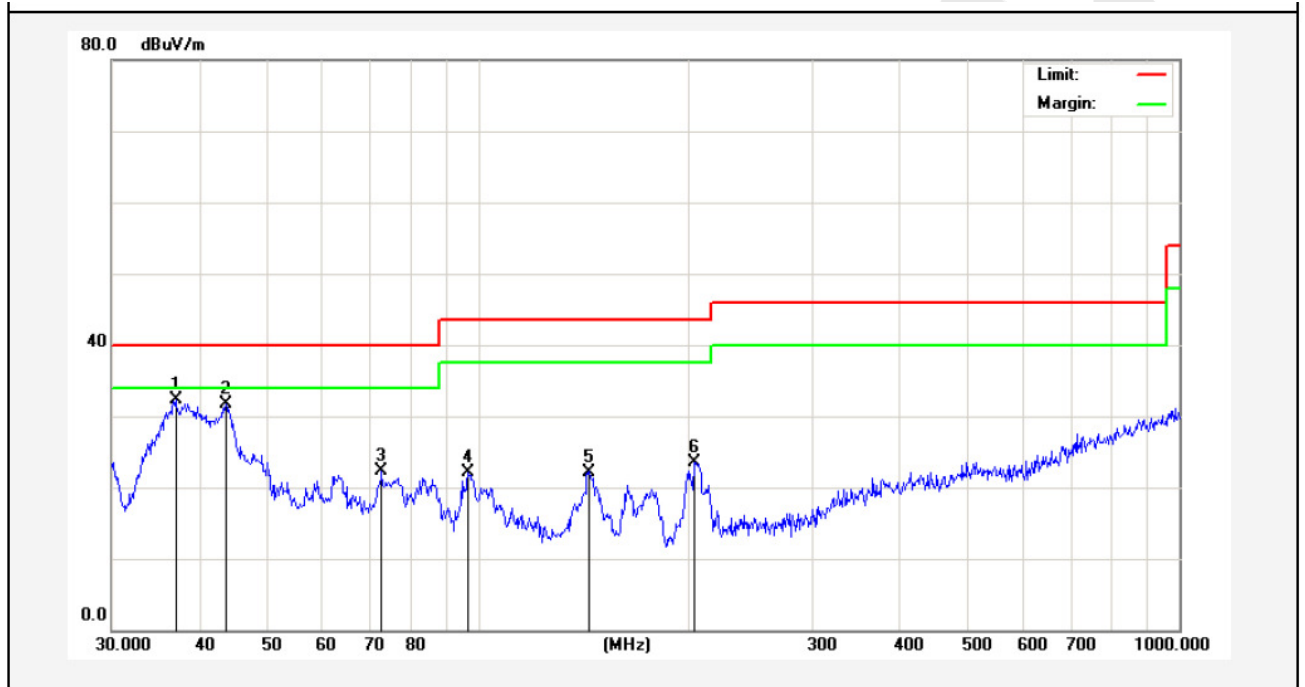

No.	Freq. (MHz)	Reading (dBuV/m)	Factor (dB/m)	Result (dBuV/m)	Limit (dBuV/)	Over Limit (dB)	Detector	Height (cm)	degree (deg)	Remark
1	37.0248	41.30	-8.98	32.32	40.00	-7.68	QP	300	52	
2	43.6584	39.86	-8.07	31.79	40.00	-8.21	QP	300	115	
3	72.8466	36.65	-14.26	22.39	40.00	-17.61	QP	300	215	
4	96.7749	31.11	-9.06	22.05	43.50	-21.45	QP	300	263	
5	143.8295	33.63	-11.43	22.20	43.50	-21.30	QP	300	297	
6	203.5228	32.29	-8.77	23.52	43.50	-19.98	QP	300	320	

APPENDIX I -- TEST SETUP PHOTOGRAPH

Photo of Conducted Emission Measurement

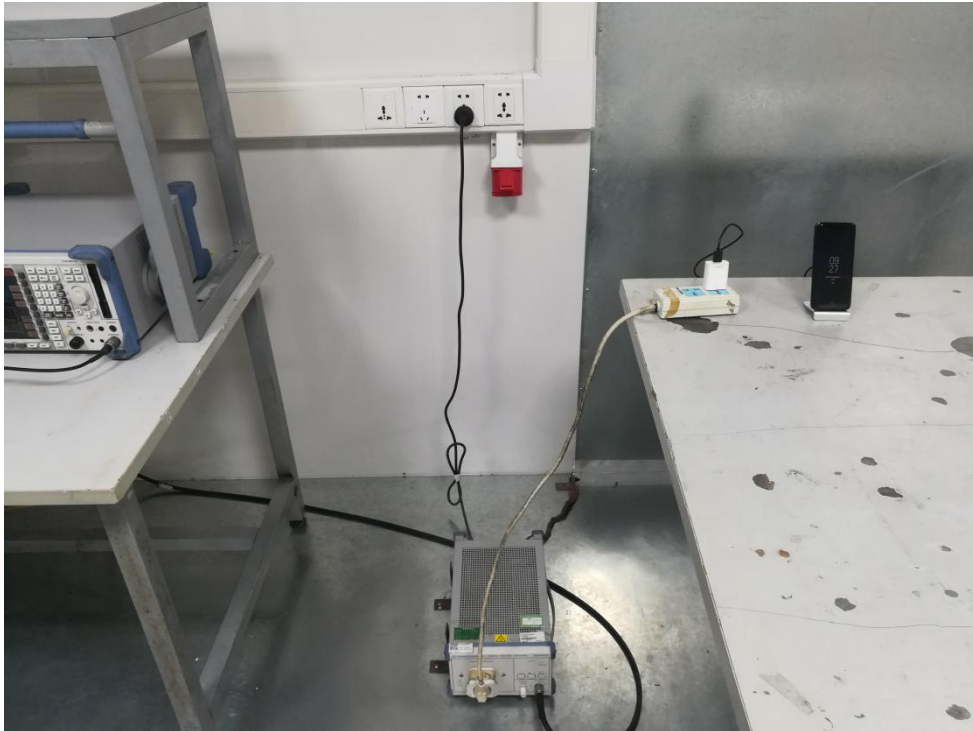
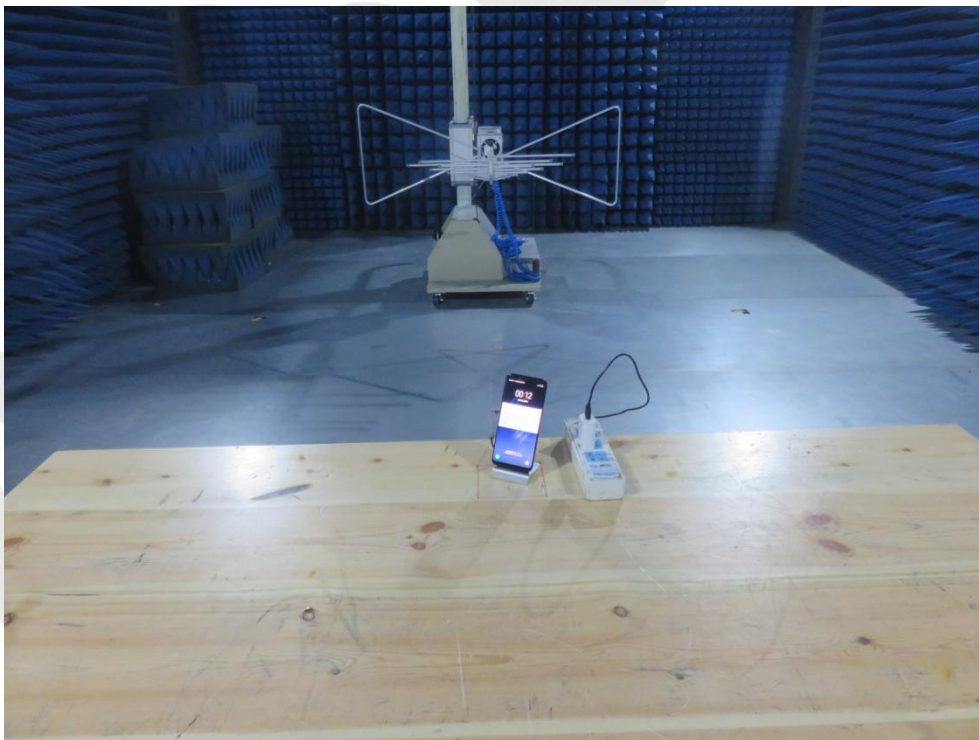

Photo of Radiation Emission Test





Anbotek

APPENDIX II -- EXTERNAL PHOTOGRAPH







APPENDIX III -- INTERNAL PHOTOGRAPH



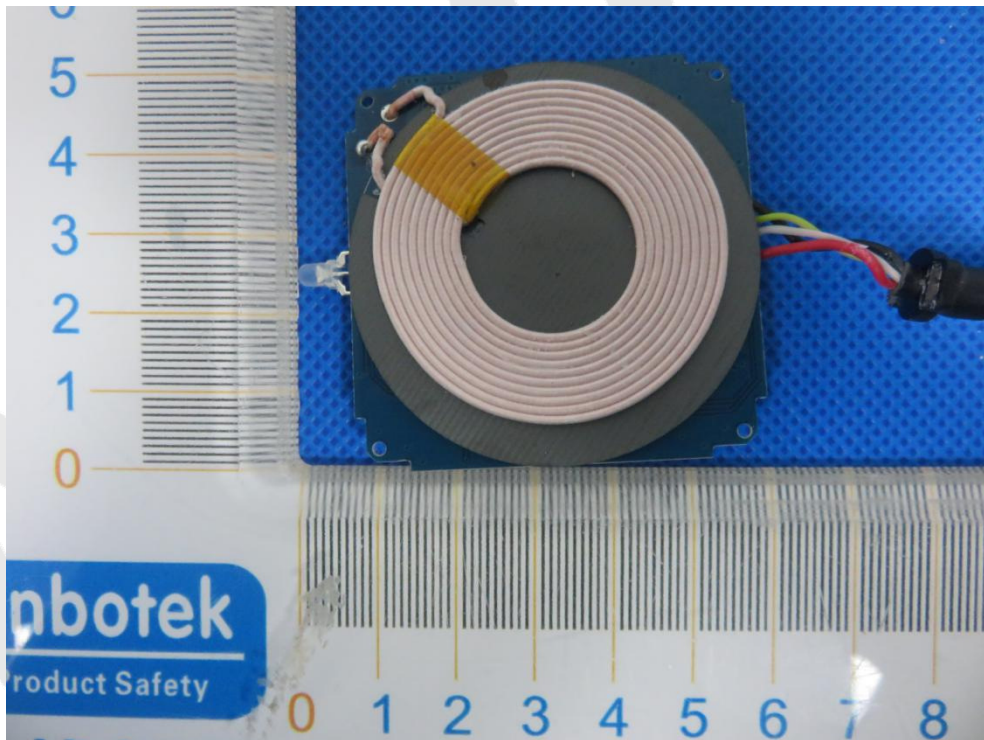
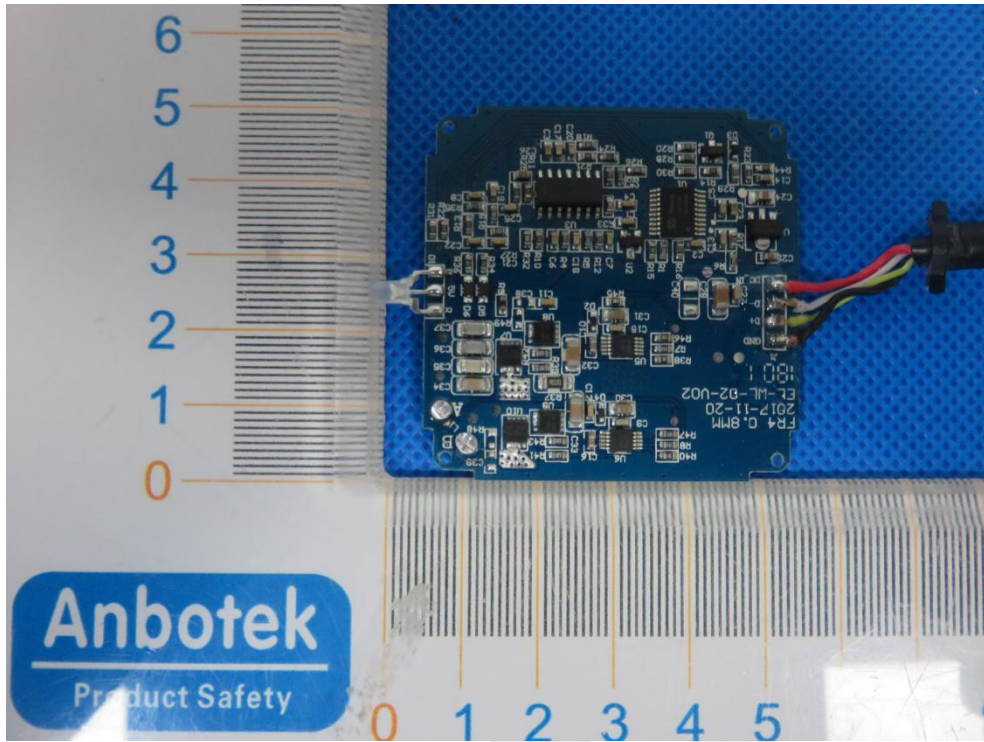

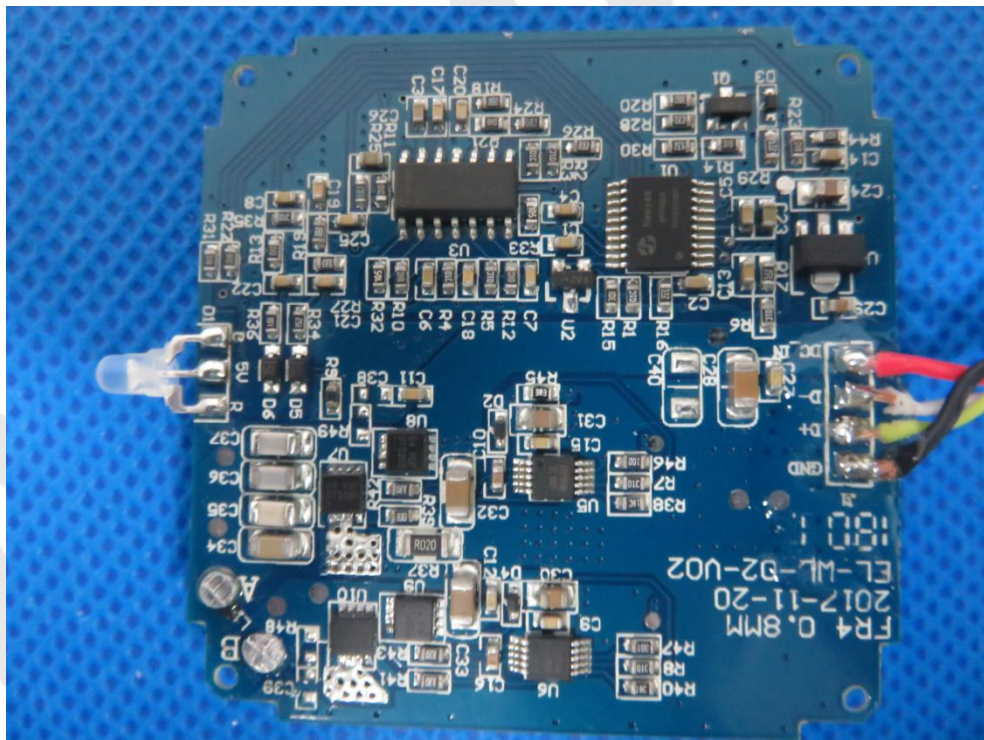
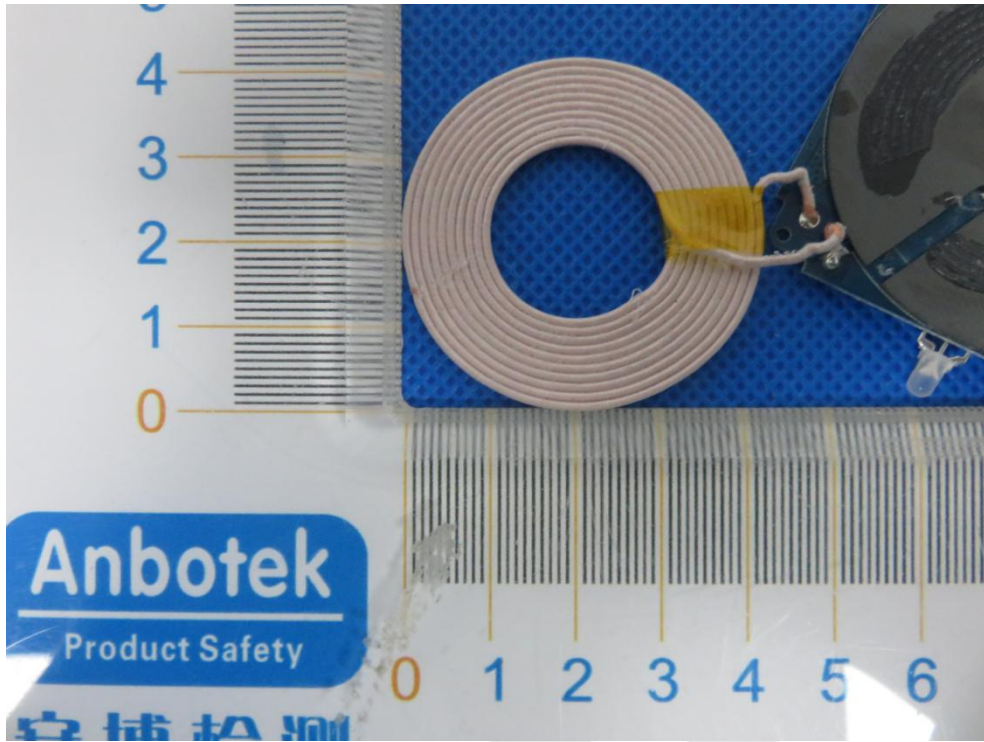



End of Report