



TEST REPORT

FCC ID: 2AN7S-MONSTERBANG

Product: SISTALK Monster Pub Smart Massager

Model No.: Monster Bang Whip Kit

**Additional Model No.: Monster Bang Candle Kit
,Monster Bang Cuffs Kit**

Trade Mark: SISTALK

Report No.: FCC18070063A-BLE

Issued Date: August 29, 2018

Issued for:

**SISTALK Technology (Beijing) Co.,Ltd
#509,A Building,Yuanyangxinganxian,Xiaguangli No.66,Maizidian
Street,Chaoyang District,Beijing,100027**

Issued By:

**World Standardization Certification & Testing Group Co., Ltd.
Building A-B, Baoshi Science & Technology Park, Baoshi Road,
Bao'an District, Shenzhen, Guangdong, China**

TEL: +86-755-26996192

FAX: +86-755-86376605



Note: The results contained in this report pertain only to the tested sample. This report shall not be reproduced, except in full, without written approval of World Standardization Certification & Testing Group Co.,Ltd. This report must not be used by the client to claim product certification, approval, or endorsement by NVLAP, NIST, or any agency of the U.S. Government.





For Question,
Please Contact with WSCT
www.wsct-cert.com

TABLE OF CONTENTS

1. GENERAL INFORMATION	3
2. GENERAL DESCRIPTION OF EUT	4
3. Facilities and Accreditations	5
ACCREDITATIONS	5
TEST DESCRIPTION	6
DESCRIPTION OF SUPPORT UNITS (CONDUCTED MODE)	9
SUMMARY OF TEST RESULTS	10
4. MEASUREMENT INSTRUMENTS	11
5. ANTENNA REQUIREMENT	12
STANDARD APPLICABLE	12
ANTENNA CONNECTOR CONSTRUCTION	12
6. CONDUCTED EMISSIONS	13
7. SPURIOUS EMISSIONS	14
8. -6dB BANDWIDTH TESTING	23
9. MAXIMUM PEAK OUTPUT POWER	26
10. 100 kHz Bandwidth of Frequency Band Edge	29
11. MAXIMUM CONDUCTED POWER SPECTRAL DENSITY	34
12. PHOTOGRAPHS OF THE TEST CONFIGURATION	37
13. PHOTOGRAPHS OF EUT	38





1. GENERAL INFORMATION

Product:	SISTALK Monster Pub Smart Massager
Model No.:	Monster Bang Whip Kit
Additional Model:	Monster Bang Candle Kit, Monster Bang Cuffs Kit
Applicant:	SISTALK Technology (Beijing) Co.,Ltd
Address:	#509,A Building,Yuanyangxinganxian,Xiaguangli No.66,Maizidian Street,Chaoyang District,Beijing,100027
Manufacturer:	SISTALK Technology (Beijing) Co.,Ltd
Address:	#509,A Building,Yuanyangxinganxian,Xiaguangli No.66,Maizidian Street,Chaoyang District,Beijing,100027
Data of receipt:	July 20, 2018
Date of Test:	July 20, 2018 to August 26, 2018
Applicable Standards:	FCC CFR Title 47 Part 15 Subpart C Section 15.247

The above equipment has been tested by World Standardization Certification & Testing Group Co., Ltd. and found compliance with the requirements set forth in the technical standards mentioned above. The results of testing in this report apply only to the product/system, which was tested. Other similar equipment will not necessarily produce the same results due to production tolerance and measurement uncertainties.

Tested By: Pu Shixi
 (Pu Shixi)

Date: August 29, 2018

Check By: Qin Shuiquan
 (Qin Shuiquan)

Date: August 29, 2018

Approved By: Wang Fengbing
 (Wang Fengbing)

Date: August 29, 2018





2. GENERAL DESCRIPTION OF EUT

Equipment Type:	SISTALK Monster Pub Smart Massager
Test Model:	Monster Bang Whip Kit
Additional Model:	Monster Bang Candle Kit,Monster Bang Cuffs Kit
Trade Mark:	SISTALK
Applicant:	SISTALK Technology (Beijing) Co.,Ltd
Address:	#509,A Building,Yuanyangxinganxian,Xiaguangli No.66,Maizidian Street,Chaoyang District,Beijing,100027
Manufacturer:	SISTALK Technology (Beijing) Co.,Ltd
Address:	#509,A Building,Yuanyangxinganxian,Xiaguangli No.66,Maizidian Street,Chaoyang District,Beijing,100027
Hardware version:	MP_MB_C_P1
Software version:	2.1.7
Extreme Temp. Tolerance:	-10°C to +55°C
Power supply:	Li-ion Battery : KT13250 Voltage: 3.7V Capacity: 420mAh
Operating Frequency:	2402-2480MHz
Channels:	40
Channel Spacing:	2MHz
Modulation Type:	GFSK
Antenna Type:	Integral Antenna
Antenna gain:	1.6dBi





3. Facilities and Accreditations

All measurement facilities used to collect the measurement data are located at **Building A-B, Baoshi Science & Technology Park, Baoshi Road, Bao'an District, Shenzhen, Guangdong, China of the World Standardization Certification & Testing Group Co., Ltd**

The sites are constructed in conformance with the requirements of ANSI C63.4 and CISPR Publication 22. All receiving equipment conforms to CISPR Publication 16-1, "Radio Interference Measuring Apparatus and Measurement Methods."

Registration Number: 366353

ACCREDITATIONS

Our laboratories are accredited and approved by the following approval agencies according to ISO/IEC 17025.

- USA** **NVLAP** (The certificate registration number is NVLAP LAB CODE:600142-0)
- Japan** **VCCI** (The certificate registration number is C-4790, R-3684, G-837)
- Canada** **INDUSTRY CANADA**
(The certificated registration number is 7700A-1)
- China** **CNAS** (The certificated registration number is L3732)

Copies of granted accreditation certificates are available for downloading from our web site, <http://www.wsct-cert.com>





For Question,
Please Contact with WSCT
www.wsct-cert.com

TEST DESCRIPTION

MEASUREMENT UNCERTAINTY

The reported uncertainty of measurement $y \pm U$, where expanded uncertainty U is based on a standard uncertainty multiplied by a coverage factor of $k=2$, providing a level of confidence of approximately 95%.

No.	Item	Uncertainty
1	Conducted Emission Test	$\pm 3.2\text{dB}$
2	RF power,conducted	$\pm 0.16\text{dB}$
3	Spurious emissions,conducted	$\pm 0.21\text{dB}$
4	All emissions,radiated(<1G)	$\pm 4.7\text{dB}$
5	All emissions,radiated(>1G)	$\pm 4.7\text{dB}$
6	Temperature	$\pm 0.5^\circ\text{C}$
7	Humidity	$\pm 2\%$





DESCRIPTION OF TEST MODES

To investigate the maximum EMI emission characteristics generates from EUT, the test system was pre-scanning tested base on the consideration of following EUT operation mode or test configuration mode which possible have effect on EMI emission level. Each of these EUT operation mode(s) or test configuration mode(s) mentioned above was evaluated respectively.

Pretest Mode	Description
Mode 1	CH00
Mode 2	CH20
Mode 3	CH39
Mode 4	Normal

For Conducted Emission	
Final Test Mode	Description
Mode 4	Normal

For Radiated Emission	
Final Test Mode	Description
Mode 1	CH00
Mode 2	CH20
Mode 3	CH39

Note:

- (1) The measurements are performed at the highest, middle, lowest available channels.
- (2) Record the worst case of each test item in this report.
- (3) When we test it, the duty cycle $\geq 98\%$





Table of Parameters of Text Software Setting

During testing channel & power controlling software provided by the customer was used to control the operating channel as well as the output power level. The RF output power selection is for the setting of RF output power expected by the customer and is going to be fixed on the firmware of the final end product power parameters.

Test software Version	N/A
-----------------------	-----

Frequency	2402 MHz	2440 MHz	2480 MHz
Parameters(1Mbps)	DEF	DEF	DEF

CONFIGURATION OF SYSTEM UNDER TEST

EUT

(EUT: SISTALK Monster Pub Smart Massager)





DESCRIPTION OF SUPPORT UNITS (CONDUCTED MODE)

The EUT has been tested as an independent unit together with other necessary accessories or support units. The following support units or accessories were used to form a representative test configuration during the tests.

Item	Equipment	Mfr/Brand	Model/Type No.	Series No.	Note
1	Adapter	/	N/A	/	/
2	Earphone	/	N/A	/	/

Note:

- (1) The support equipment was authorized by Declaration of Confirmation.
- (2) For detachable type I/O cable should be specified the length in cm in 『Length』 column.
- (3) “YES” is means “shielded” “with core”, “NO” is means “unshielded” “without core”.





SUMMARY OF TEST RESULTS

Test procedures according to the technical standards:

FCC Part15 (15.247) , Subpart C			
Standard Section	Test Item	Judgment	Remark
15.203	Antenna Requirement	PASS	
15.207	Conducted Emission	PASS	
15.209, 15.205, 15.247(d)	Spurious Emission	PASS	
15.247(a) (2)	6dB Bandwidth Testing	PASS	
15.247(b) (3)	Maximum Peak Output Power	PASS	
15.247(d)	100 KHz Bandwidth of Frequency Band Edge	PASS	
15.247(e)	Maximum Conducted Power Spectral Density	PASS	

NOTE:

(1) "N/A" denotes test is not applicable in this test report.





4. MEASUREMENT INSTRUMENTS

NAME OF EQUIPMENT	MANUFACTURER	MODEL	SERIAL NUMBER	Calibration Date	Calibration Due.
EMI Test Receiver	R&S	ESCI	100005	08/19/2017	08/18/2018
LISN	AFJ	LS16	16010222119	08/19/2017	08/18/2018
LISN(EUT)	Mestec	AN3016	04/10040	08/19/2017	08/18/2018
Universal Radio Communication Tester	R&S	CMU 200	1100.0008.02	08/19/2017	08/18/2018
Coaxial cable	Megalon	LMR400	N/A	08/12/2017	08/11/2018
GPIB cable	Megalon	GPIB	N/A	08/12/2017	08/11/2018
Spectrum Analyzer	R&S	FSU	100114	08/19/2017	08/18/2018
Pre Amplifier	H.P.	HP8447E	2945A02715	10/13/2017	10/12/2018
Pre-Amplifier	CDSI	PAP-1G18-38	--	10/13/2017	10/12/2018
Bi-log Antenna	SUNOL Sciences	JB3	A021907	09/13/2017	09/12/2018
9*6*6 Anechoic	--	--	--	08/21/2017	08/20/2018
Horn Antenna	COMPLIANCE ENGINEERING	CE18000	--	09/13/2017	09/12/2018
Horn Antenna	SCHWARZBECK	BBHA9120D	9120D-631	08/23/2017	08/22/2018
Cable	TIME MICROWAVE	LMR-400	N-TYPE04	04/25/2018	04/24/2019
System-Controller	CCS	N/A	N/A	N.C.R	N.C.R
Turn Table	CCS	N/A	N/A	N.C.R	N.C.R
Antenna Tower	CCS	N/A	N/A	N.C.R	N.C.R
RF cable	Murata	MXHQ87WA3000	-	08/21/2017	08/20/2018
Loop Antenna	EMCO	6502	00042960	08/22/2017	08/21/2018
Horn Antenna	SCHWARZBECK	BBHA 9170	1123	08/19/2017	08/18/2018
Power meter	Anritsu	ML2487A	6K00003613	08/23/2017	08/22/2018
Power sensor	Anritsu	MX248XD	--	08/19/2017	08/18/2018





5. ANTENNA REQUIREMENT

Standard Applicable

According to § 15.203, an intentional radiator shall be designed to ensure that no antenna other than that furnished by the responsible party shall be used with the device. The use of a permanently attached antenna or of an antenna that uses a unique coupling to the intentional radiator shall be considered sufficient to comply with the provisions of this section. The manufacturer may design the unit so that a broken antenna can be replaced by the user, but the user of a standard antenna jack or electrical connector is prohibited. The structure and application of the EUT were analyzed to determine compliance with section §15.203 of the rules. §15.203 state that the subject device must meet the following criteria:

- a. Antenna must be permanently attached to the unit.
- b. Antenna must use a unique type of connector to attach to the EUT.

Unit must be professionally installed, and installer shall be responsible for verifying that the correct antenna is employed with the unit.

And according to FCC 47 CFR section 15.247 (b), if the transmitting antennas of directional gain greater than 6dBi are used, the power shall be reduced by the amount in dB that the directional gain of the antenna exceeds 6 dBi.

Antenna Connector Construction

The EUT's antenna integrated on PCB, The antenna's gain is 1.6dBi and meets the requirement.

BT ANT

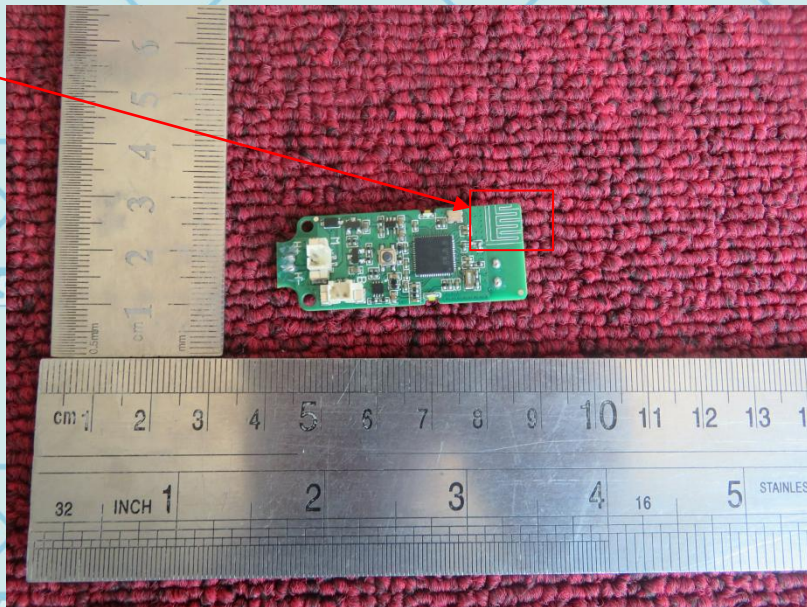



6. CONDUCTED EMISSIONS

1.1.1. Applicable Standard

The specification used was with the FCC Part 15.207 limits.

1.1.2. Test Procedure

During the conducted emission test, the EUT was connected to the outlet of the LISN. Maximizing procedure was performed on the six (6) highest emissions of the EUT. All data was recorded in the Quasi-peak and average detection mode.

1.1.3. Test Conditions

Temperature:	26 °C
Relative Humidity:	60%
ATM Pressure:	100.0kPa
Voltage	120V/60Hz

1.1.4. TEST RESULTS

Not applicable. Due to this product is supplied by battery.





7. SPURIOUS EMISSIONS

1.1.5. Test Equipment

Please refer to section 4 this report.

1.1.6. Test Procedure

The out of band emission tests were performed in the 3-meter chamber test site, using the setup accordance with the ANSI C63.4-2014. The specification used was the FCC Part Subpart C limits.

- a. The measuring distance of at 3 m shall be used for measurements at frequency up to 1GHz. For frequencies above 1GHz, any suitable measuring distance may be used.
- b. The EUT was placed on the top of a rotating table 0.8 meters above the ground at a 3 meter open area test site. The table was rotated 360 degrees to determine the position of the highest radiation.
- c. The height of the equipment or of the substitution antenna shall be 0.8 m; the height of the test antenna shall vary between 1 m to 4 m. Both horizontal and vertical polarizations of the antenna are set to make the measurement.
- d. The initial step in collecting conducted emission data is a spectrum analyzer peak detector mode pre-scanning the measurement frequency range. Significant peaks are then marked and then Quasi Peak detector mode re-measured.
- e. If the Peak Mode measured value compliance with and lower than Quasi Peak Mode Limit, the EUT shall be deemed to meet QP Limits and then no additional QP Mode measurement performed.
- f. For the actual test configuration, please refer to the related Item –EUT Test Photos.

Note:

**Both horizontal and vertical antenna polarities were tested
And performed pretest to three orthogonal axis. The worst case emissions were reported**

1.1.7. Environmental Conditions

Temperature:	26 °C
Relative Humidity:	55%
ATM Pressure:	100.0kPa





1.1.8. Radiated Test Setup

The system was investigated from 9 KHz to 25 GHz. During the radiated emission test, the EMI test receiver & Spectrum Analyzer Setup were set with the following configurations:

Frequency Range	RBW	Video B/W	Detector
9KHz-30MHz	9kHz	30 kHz	QP
30 MHz – 1000 MHz	100 kHz	300 kHz	QP
1000 MHz – 25 GHz	1 MHz	3 MHz	PK
1000 MHz – 25 GHz	1 MHz	10 Hz	Ave

(A) Radiated Emission Test-Up Frequency Below 30MHz

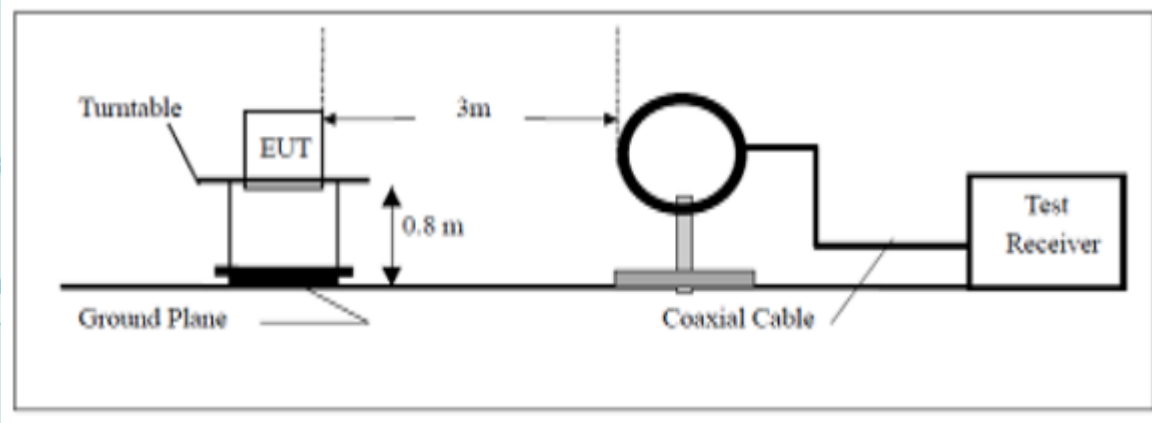

(B) Radiated Emission Test-Up Frequency 30MHz~1GHz

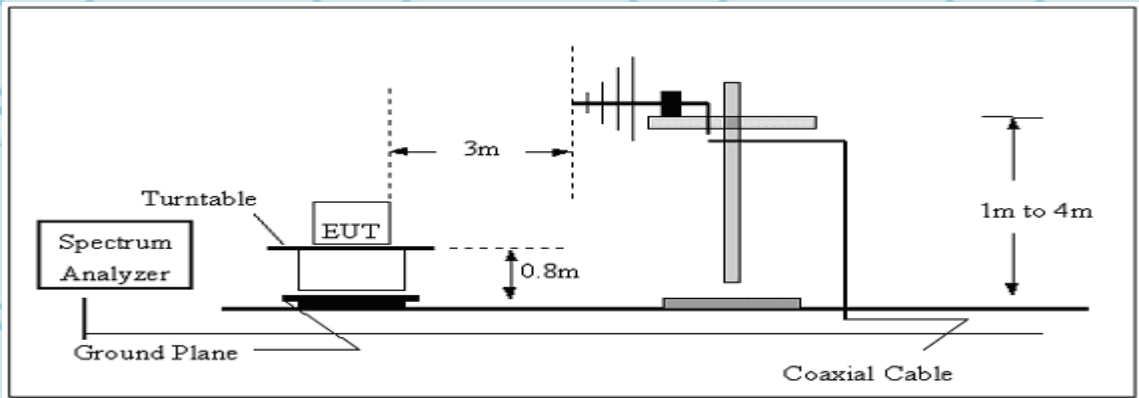



For Question,
Please Contact with WSCT
www.wsct-cert.com

(C) Radiated Emission Test-Up Frequency Above 1GHz

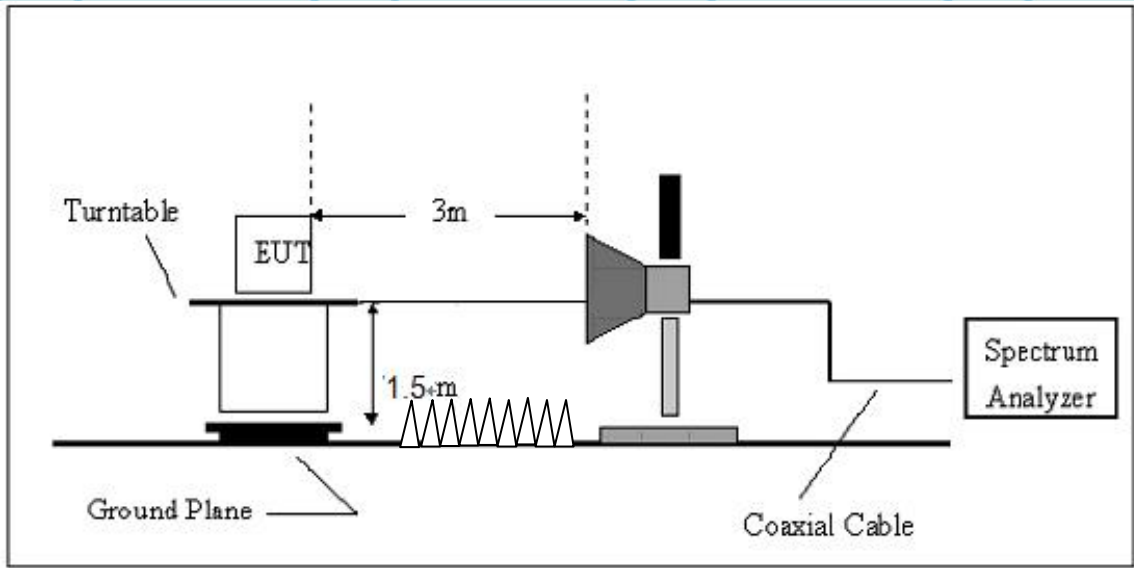

For the accrual test configuration, please refer to the related items-photos of Testing.





For Question,
Please Contact with WSCT
www.wsct-cert.com

1.1.9. Radiated Emission Limit

Applicable Standard
FCC §15.247 (d); §15.209; §15.205;
Radiated Emission Test Result
Test Mode: Transmitting

Note:

Frequency (MHz)	Field strength (microvolts/meter)	Measurement distance (meters)
0.009-0.490	2400/F(kHz)	300
0.490-1.705	24000/F(kHz)	30
1.705-30.0	30	30
30-88	100**	3
88-216	150**	3
216-960	200**	3
Above 960	500	3

Both horizontal and vertical antenna polarities were tested and performed pretest to three orthogonal axis. The worst case emissions were reported

1.1.10. Test result:

From 9KHz to 30MHz

NOTE: 9KHz-30MHz the measurements were greater than 20dB below the limit.





For Question,
Please Contact with WSCT
www.wsct-cert.com

Frequency from 30MHz to 1GHz

Horizontal:

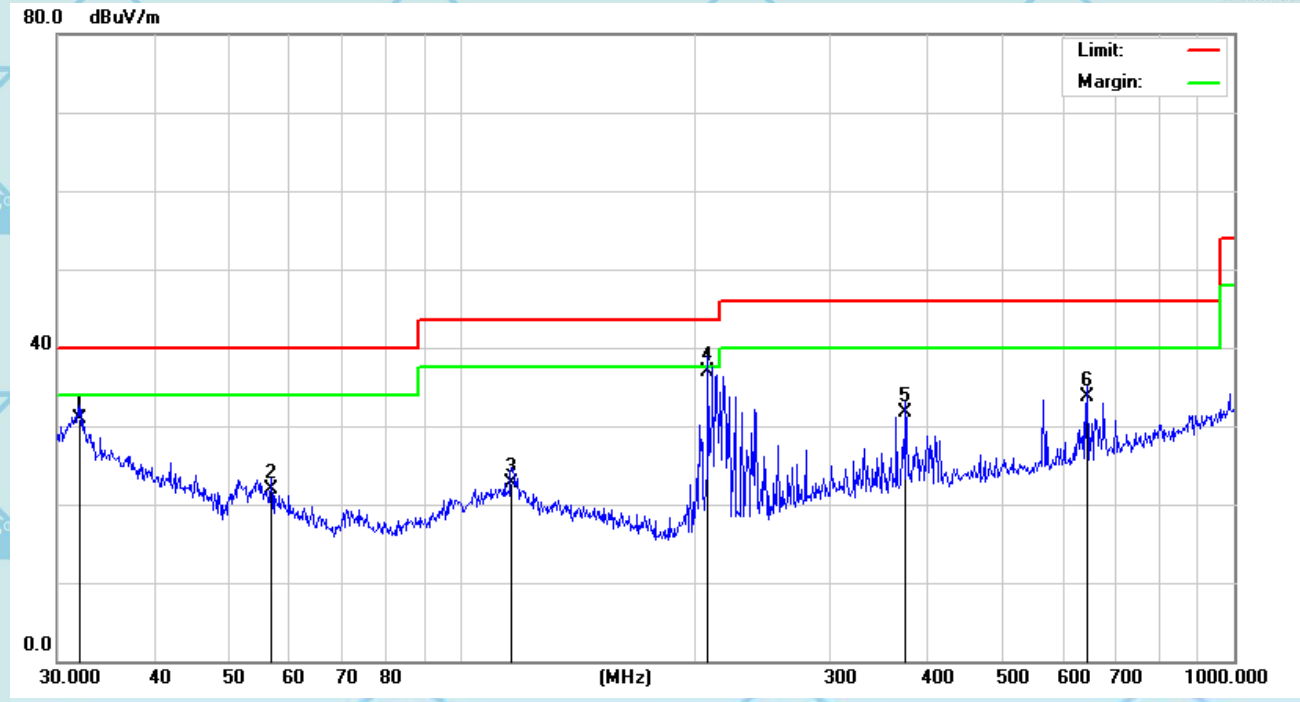

No.	Mk.	Freq. MHz	Reading Level dBuV	Correct Factor dB	Measure- ment dBuV/m	Limit dBuV/m	Over dB	Detector
1		32.0667	26.87	4.00	30.87	40.00	-9.13	QP
2		56.7917	27.69	-5.83	21.86	40.00	-18.14	QP
3		116.1321	25.21	-2.46	22.75	43.50	-20.75	QP
4	*	208.5803	43.56	-6.61	36.95	43.50	-6.55	QP
5		375.9385	33.29	-1.61	31.68	46.00	-14.32	QP
6		645.1195	32.22	1.47	33.69	46.00	-12.31	QP

Remark: All of the TX modes have been investigated, and only worst mode is presented in this report.





For Question, Please Contact with WSCT
-cert.com

Vertical:

80.0 dBuV/m

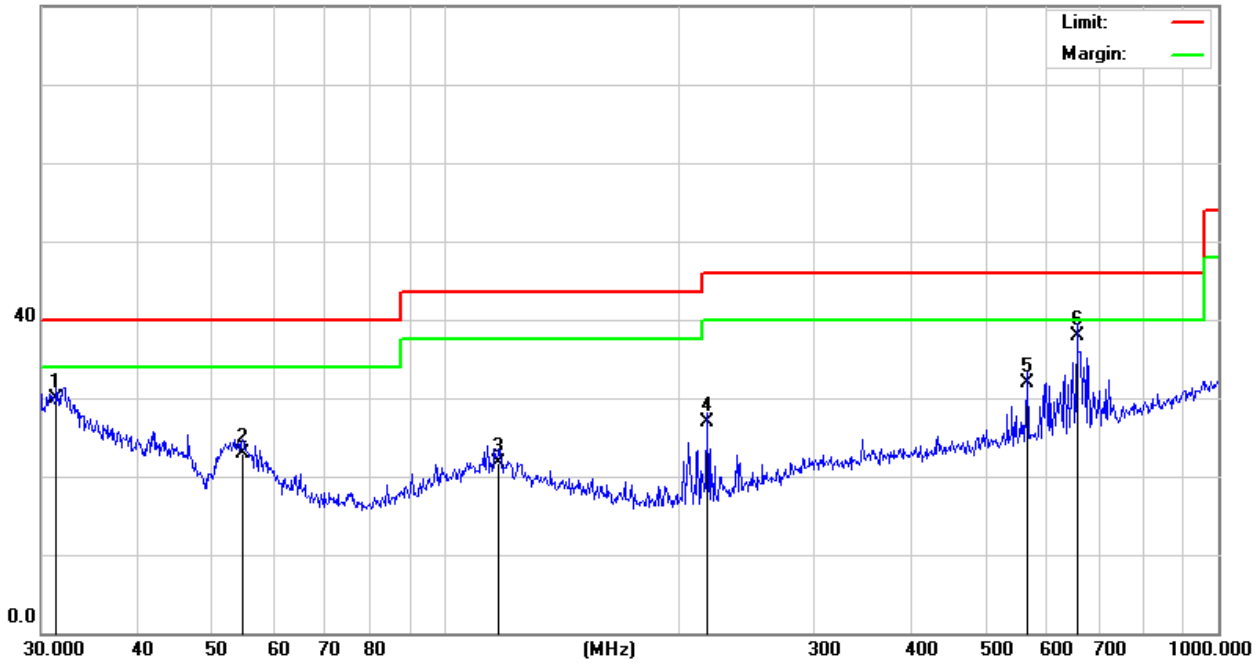

No.	Mk.	Freq. MHz	Reading Level dBuV	Correct Factor dB	Measure- ment dBuV/m	Limit dBuV/m	Over dB	Detector
1		31.3992	25.58	4.26	29.84	40.00	-10.16	QP
2		54.6429	28.51	-5.57	22.94	40.00	-17.06	QP
3		117.3603	24.31	-2.58	21.73	43.50	-21.77	QP
4		218.3085	33.01	-6.16	26.85	46.00	-19.15	QP
5		566.6223	30.71	1.15	31.86	46.00	-14.14	QP
6	*	656.5300	36.12	1.83	37.95	46.00	-8.05	QP

Remark: All of the TX modes have been investigated, and only worst mode is presented in this report.





For Question,
Please Contact with WSCT
www.wsct-cert.com

From 1GHz to 25GHz:

Operation Mode:	Channel 0	Measured Distance:	3m
Frequency Range:	Above 1GHz	Temperature :	28°C
Test Result:	PASS	Humidity :	65 %

Freq. (MHz)	Ant.Pol	Emission Level(dBuV)		Limit 3m(dBuV/m)		Over(dB)	
		PK	AV	PK	AV	PK	AV
4804	V	58.27	39.37	74	54	-15.73	-14.63
7206	V	59.29	40.43	74	54	-14.71	-13.57
4804	H	58.62	40.71	74	54	-15.38	-13.29
7206	H	58.76	39.76	74	54	-15.24	-14.24

All emissions not reported were more than 20dB below the specified limit or in the noise floor.

- Note:**
- (1) All Readings are Peak Value and AV.
 - (2) Emission Level= Reading Level+ Probe Factor +Cable Loss.
 - (3) Data of measurement within this frequency range shown "--" in the table above means the reading of emissions are attenuated more than 20dB below the permissible limits or the field strength is too small to be measured.





For Question, Please Contact with WSCT
www.wsct-cert.com

Operation Mode:	Channel 20	Measured Distance:	3m
Frequency Range:	Above 1GHz	Temperature :	28 °C
Test Result:	PASS	Humidity :	65 %

Freq. (MHz)	Ant.Pol	Emission Level(dBuV)		Limit 3m(dBuV/m)		Over(dB)	
		PK	AV	PK	AV	PK	AV
4880	V	58.38	39.03	74	54	-15.62	-14.97
7320	V	59.32	40.36	74	54	-14.68	-13.64
4880	H	58.05	39.68	74	54	-15.95	-14.32
7320	H	58.05	39.05	74	54	-15.95	-14.95

All emissions not reported were more than 20dB below the specified limit or in the noise floor.

- Note:**
- (1) All Readings are Peak Value and AV.
 - (2) Emission Level= Reading Level+Probe Factor +Cable Loss.
 - (3) Data of measurement within this frequency range shown "--" in the table above means the reading of emissions are attenuated more than 20dB below the permissible limits or the field strength is too small to be measured.





Operation Mode:	Channel 39	Measured Distance:	3m
Frequency Range:	Above 1GHz	Temperature :	28°C
Test Result:	PASS	Humidity :	65 %

For Question,
Please Contact with WSCT
www.wsct-cert.com

Freq. (MHz)	Ant.Pol	Emission Level(dBuV)		Limit 3m(dBuV/m)		Over(dB)	
		PK	AV	PK	AV	PK	AV
4960	V	60.31	39.61	74	54	-13.69	-14.39
7440	V	59.05	39.09	74	54	-14.95	-14.91
4960	H	58.12	40.52	74	54	-15.88	-13.48
7440	H	58.25	39.25	74	54	-15.75	-14.75

All emissions not reported were more than 20dB below the specified limit or in the noise floor.

- Note:**
- (1) All Readings are Peak Value and AV.
 - (2) Emission Level= Reading Level+Probe Factor +Cable Loss.
 - (3) Data of measurement within this frequency range shown “ -- ” in the table above means the reading of emissions are attenuated more than 20dB below the permissible limits or the field strength is too small to be measured.





8. -6dB BANDWIDTH TESTING

Test Equipment

Please refer to Section 4 this report.

Test Procedure

1. Set EUT in the transmitting mode.
2. Remove the antenna from the EUT and then connect a low loss RF cable from the antenna port to the spectrum analyzer.
3. Set the spectrum analyzer as RBW=100KHz,VBW≥RBW, Span=3MHz,Sweep=auto.
4. Mark the peak frequency and -6dB(upper and lower)frequency.
5. Repeat until all the rest channels are investigated.

Note : The EUT was tested according to KDB 558074 for compliance to FCC 47CFR 15.247 requirements.

Environmental Conditions

Temperature:	26 °C
Relative Humidity:	55%
ATM Pressure:	100.0kPa

Applicable Standard

Systems using digital modulation techniques may operate in the 902–928 MHz, 2400–2483.5 MHz, and 5725–5850 MHz bands. The minimum 6 dB bandwidth shall be at least 500 kHz.





For Question,
Please Contact with WSCT
www.wsct-cert.com

Test Result: Pass.

Please refer to the following tables

Channel Frequency (MHz)	Data Rate (Mbps)	6dB Bandwidth (kHz)	Limit (kHz)	Ref. Plot
2402	1	716.35	> 500	PLOT 1
2440	1	740.38	> 500	PLOT 2
2480	1	730.77	> 500	PLOT 3

Low Channel

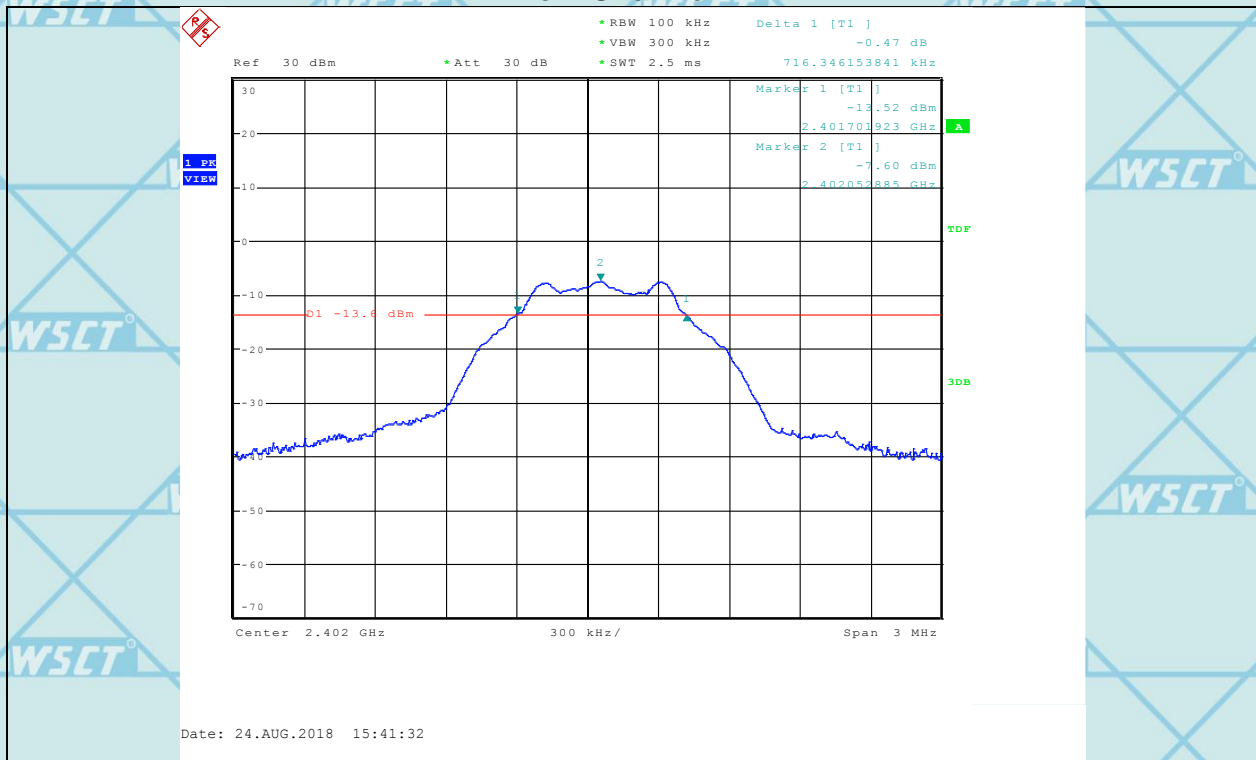



For Question,
Please Contact with WSCT
www.wsct-cert.com

Middle channel

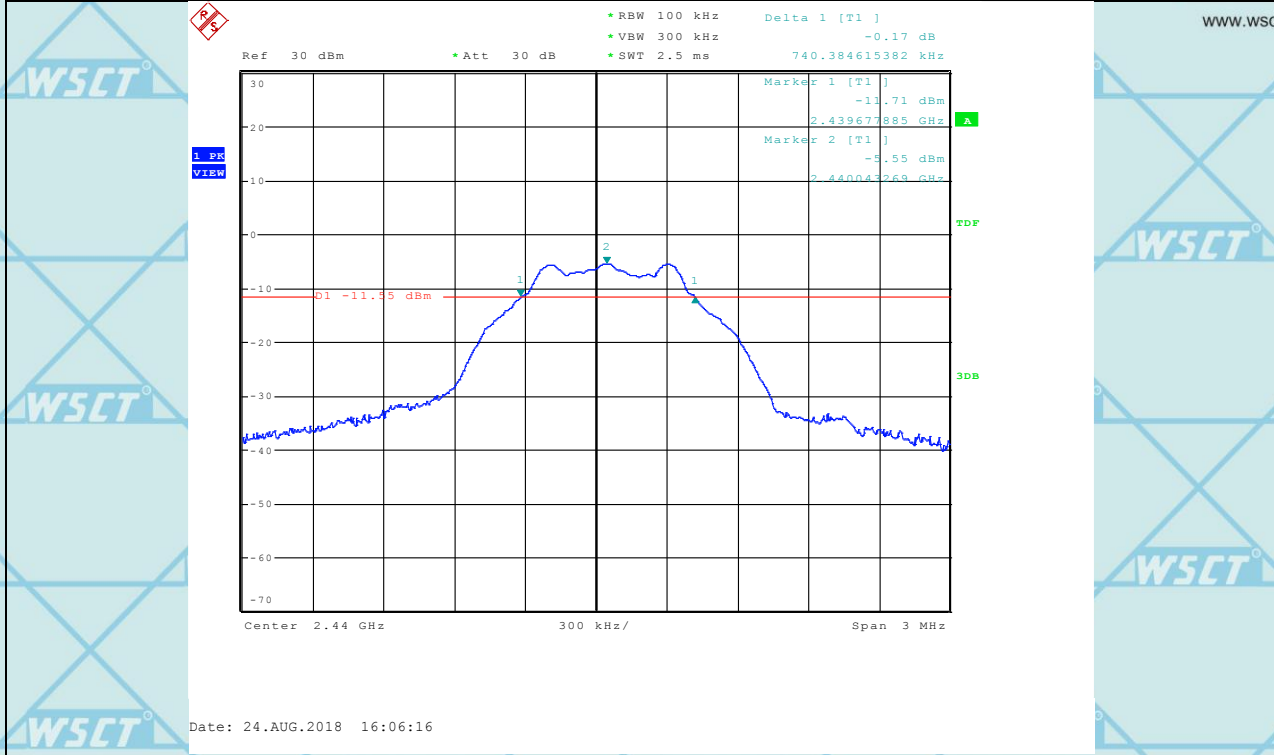

High Channel

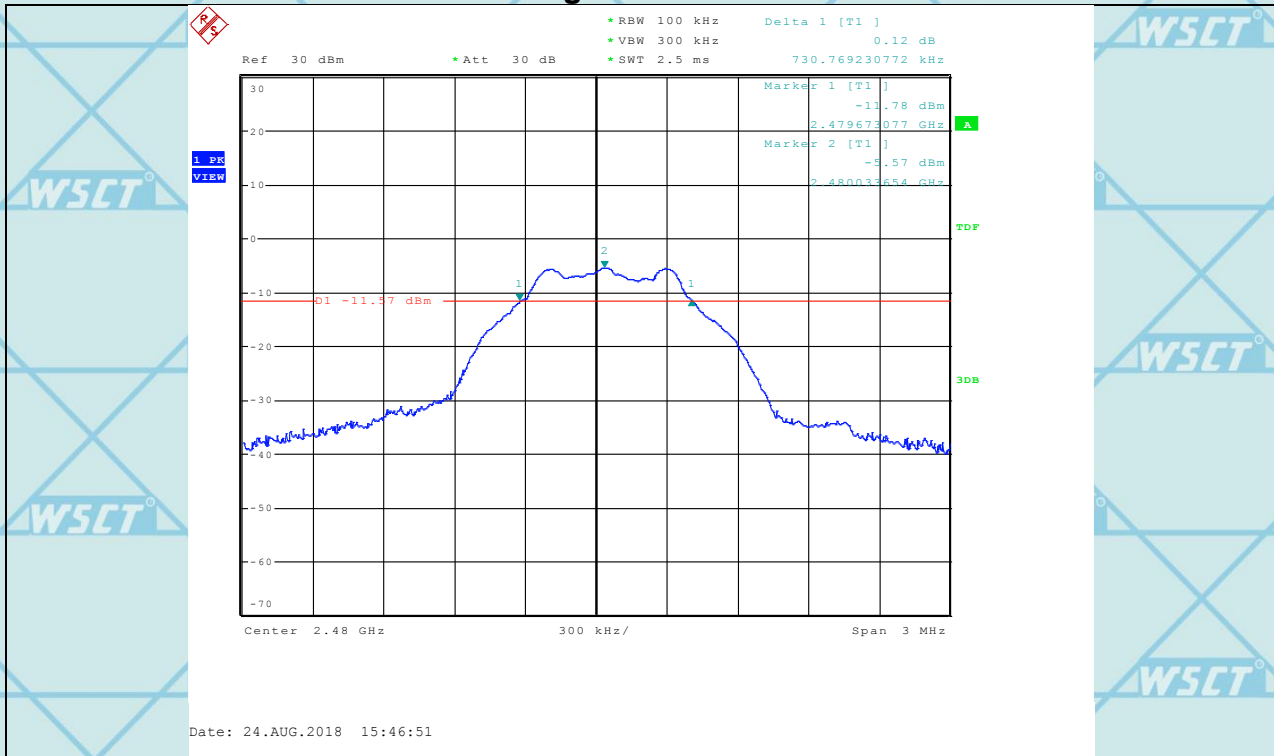



9. MAXIMUM PEAK OUTPUT POWER

Test Equipment

Please refer to Section 4 this report.

Test Procedure

1. The EUT was directly connected to the spectrum analyzer and antenna output port as show in the block diagram below,
2. Set the EUT Work on the top, the middle and the bottom operation frequency individually.
3. Set the RBW =1MHz, VBW \cong 3RBW, span \cong 1.5*6dbbandwith.
Sweep time = auto couple, Detector = peak, Trace mode = max hold.
4. Record the maximum power from the spectrum analyzer.
5. The maximum peak power shall be less 1 Watt (30dBm).

Note : The EUT was tested according to KDB 558074 for compliance to FCC 47CFR 15.247 requirements.

Environmental Conditions

Temperature:	26 °C
Relative Humidity:	55%
ATM Pressure:	100.0kPa

Applicable Standard

According to §15.247(b) (3), for systems using digital modulation in the 902–928 MHz, 2400–2483.5 MHz, and 5725–5850 MHz bands: 1 Watt. As an alternative to a peak power measurement, compliance with the one Watt limit can be based on a measurement of the maximum conducted output power. Maximum Conducted Output Power is defined as the total transmit power delivered to all antennas and antenna elements averaged across all symbols in the signaling alphabet when the transmitter is operating at its maximum power control level. Power must be summed across all antennas and antenna elements. The average must not include any time intervals during which the transmitter is off or is transmitting at a reduced power level. If multiple modes of operation are possible (e.g., alternative modulation methods), the maximum conducted output power is the highest total transmit power occurring in any mode.





For Question,
Please Contact with WSCT
www.wsct-cert.com

Test Result

Channel	Frequency (MHz)	Data Rate (Mbps)	Conducted Power (dBm)	Limit (dBm)
Low	2402	1	-5.62	30
Middle	2440	1	-4.39	30
High	2480	1	-3.67	30

Low channel

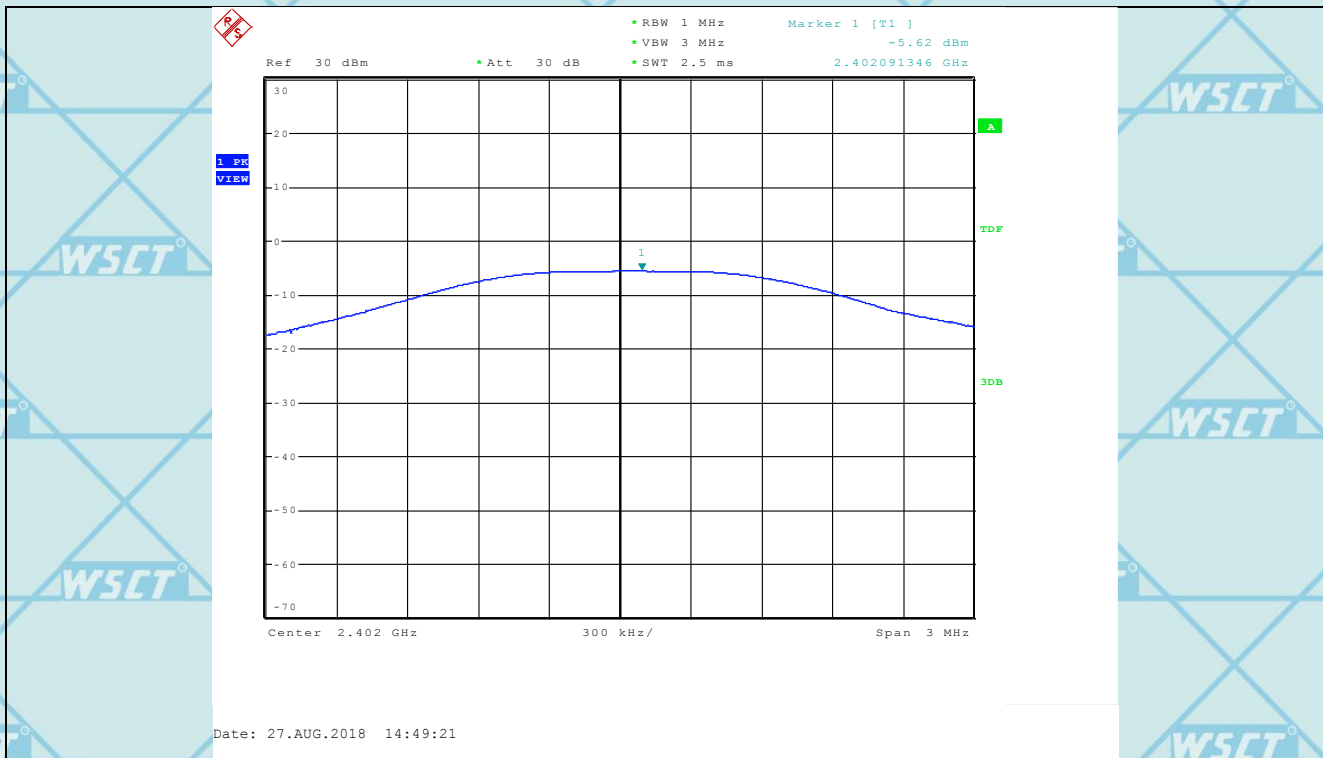



For Question, Please Contact with WSCT www.wsct-cert.com

Middle channel

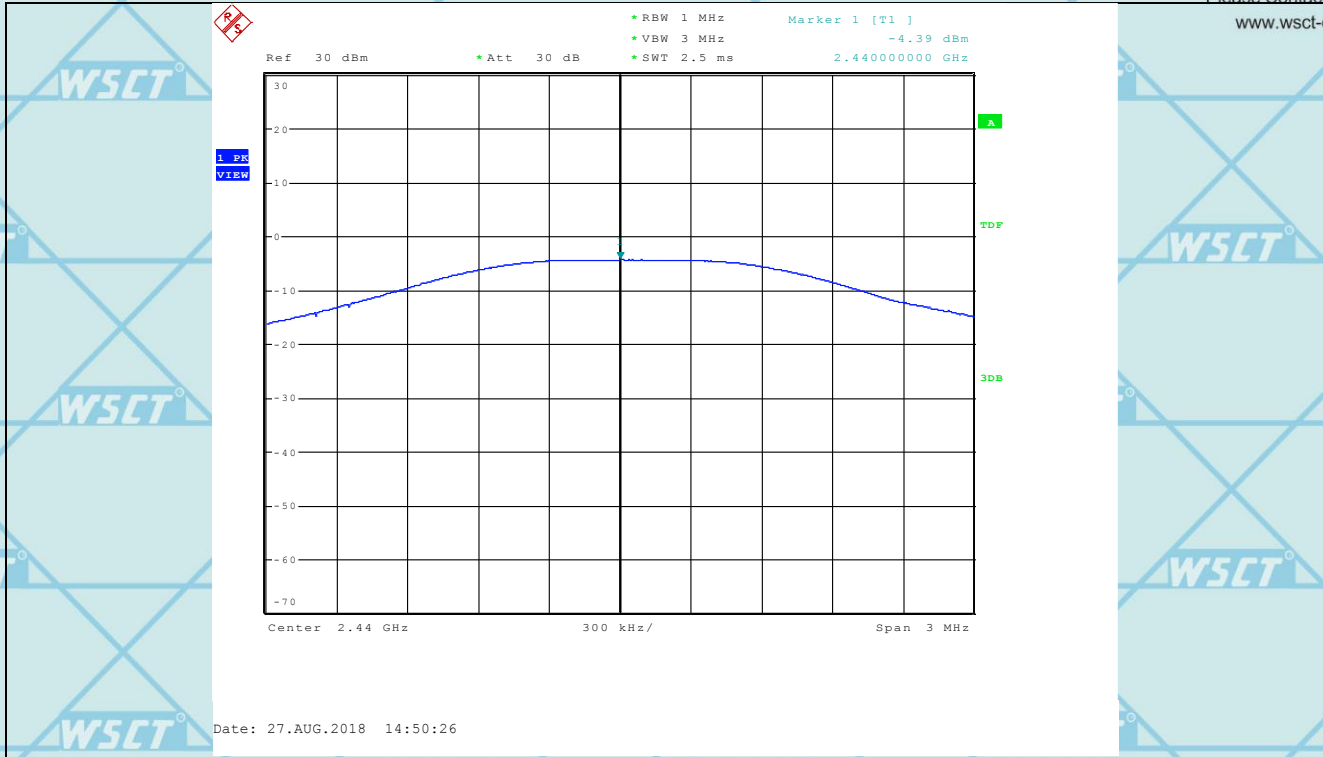

High channel

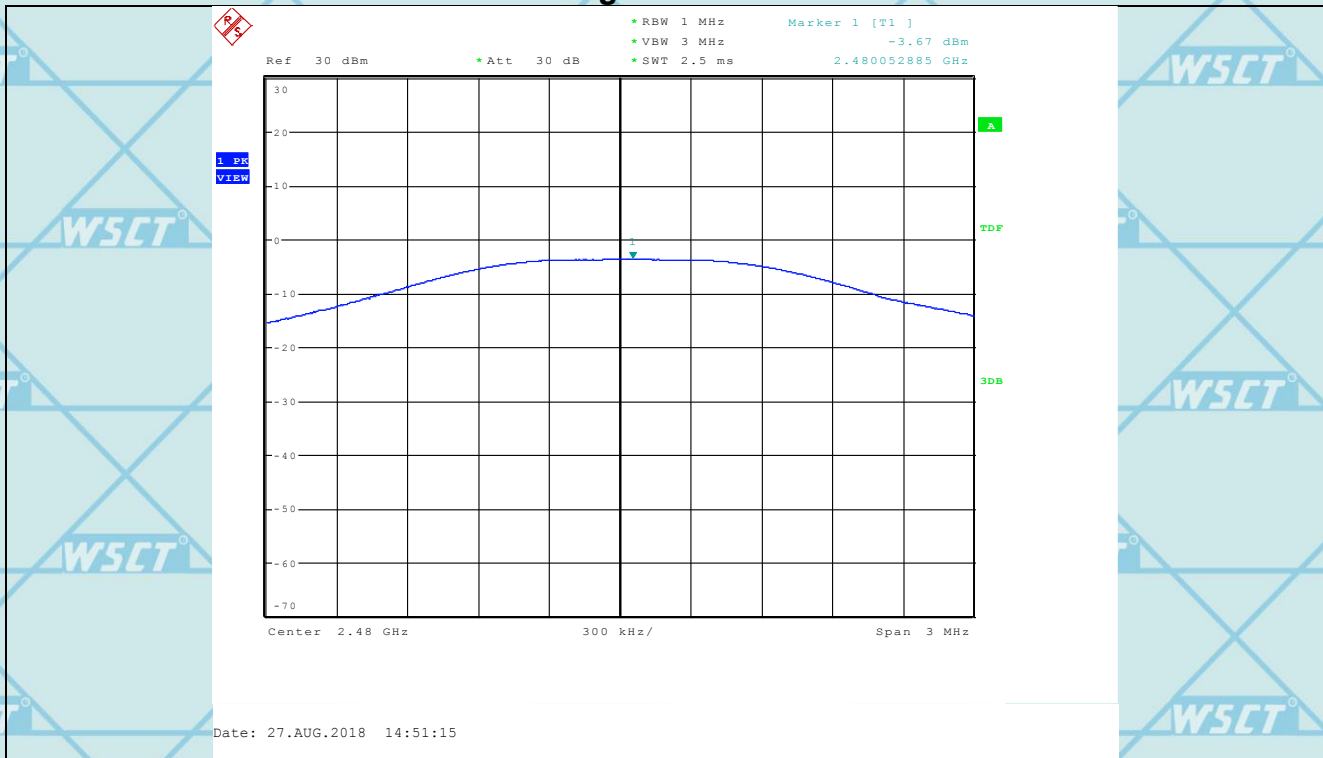



10. 100 kHz Bandwidth of Frequency Band Edge

Test Equipment

Please refer to Section 4 this report.

Test Procedure

The out of band emission tests were performed in the 3-meter chamber test site, using the setup accordance with the ANSI C63.4-2014. The specification used was the FCC Part Subpart C limits.

Environmental Conditions

Temperature:	26 °C
Relative Humidity:	55%
ATM Pressure:	100.0kPa

Applicable Standard

In any 100 kHz bandwidth outside the frequency band in which the spread spectrum or digitally modulated intentional radiator is operating, the radio frequency power that is produced by the intentional radiator shall be at least 20 dB below that in the 100 kHz bandwidth within the band that contains the highest level of the desired power, based on either an RF conducted or a radiated measurement, provided the transmitter demonstrates compliance with the peak conducted power limits. If the transmitter complies with the conducted power limits based on the use of RMS averaging over a time interval, as permitted under paragraph (b)(3) of this section, the attenuation required under this paragraph shall be 30 dB instead of 20 dB. Attenuation below the general limits specified in §15.209(a) is not required. In addition, radiated emissions which fall in the restricted bands, as defined in §15.205(a), must also comply with the radiated emission limits specified in §15.209(a) (see §15.205(c)).





For Question,
Please Contact with WSCT
www.wsct-cert.com

Test Result: PASS

Radiated measurement:

Indicated		result (PK/AV)	Table Angle degree	Antenna		Correction Factor			FCC Part 15.247		
Frequency (MHz)	Receiver Reading (dBμV/m)			Height (m)	Polar (H/V)	Ant. Factor (dB/m)	Cable Loss (dB)	Pre-Amp. Gain (dB)	Cord. Amp. (dBμV/m)	Limit (dBμV/m)	Margin (dB)
Low Channel (2402MHz)											
2390	40.12	AV	225	1.5	V	30.3	4.1	33.1	41.42	54	12.58
2390	41.84	AV	90	2	H	30.3	4.1	33.1	43.14	54	10.86
2390	61.17	PK	180	1.5	V	30.3	4.1	33.1	41.42	74	11.53
2390	61.87	PK	270	2	H	30.3	4.1	33.1	63.17	74	10.83
High Channel (2480MHz)											
2483.5	41.03	AV	360	1	V	31	4.4	32.7	43.73	54	10.27
2483.5	41.23	AV	90	2	H	31	4.4	32.7	43.93	54	10.07
2483.5	60.47	PK	180	1	V	31	4.4	32.7	63.17	74	10.83
2483.5	60.73	PK	225	2	H	31	4.4	32.7	63.43	74	10.57





For Question,
Please Contact with WSCT
www.wsct-cert.com

Conducted Emission Measurement:

Low channel

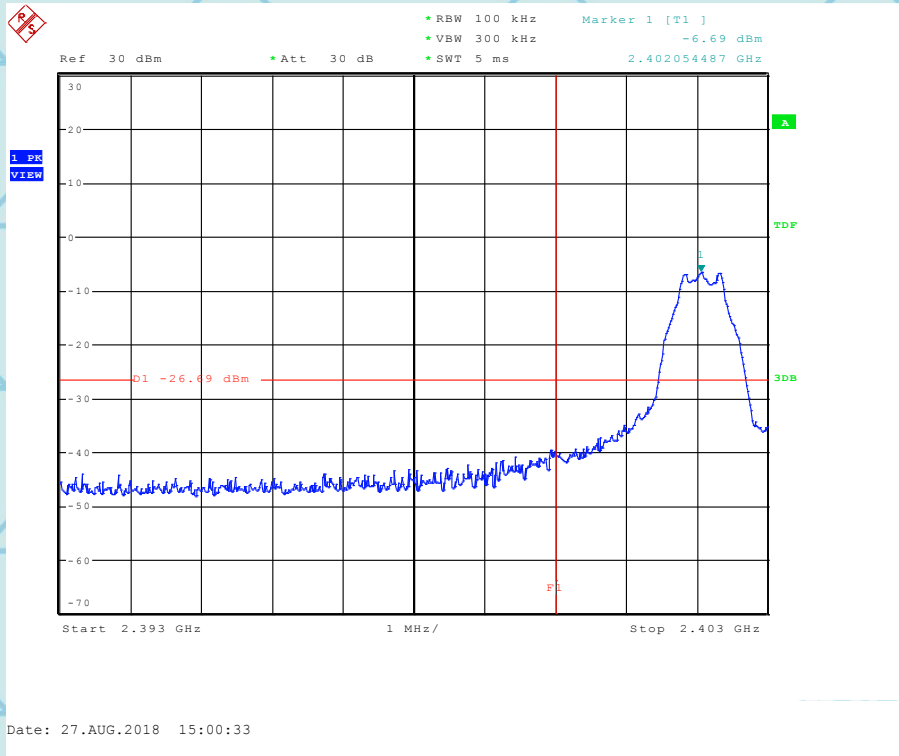

High channel

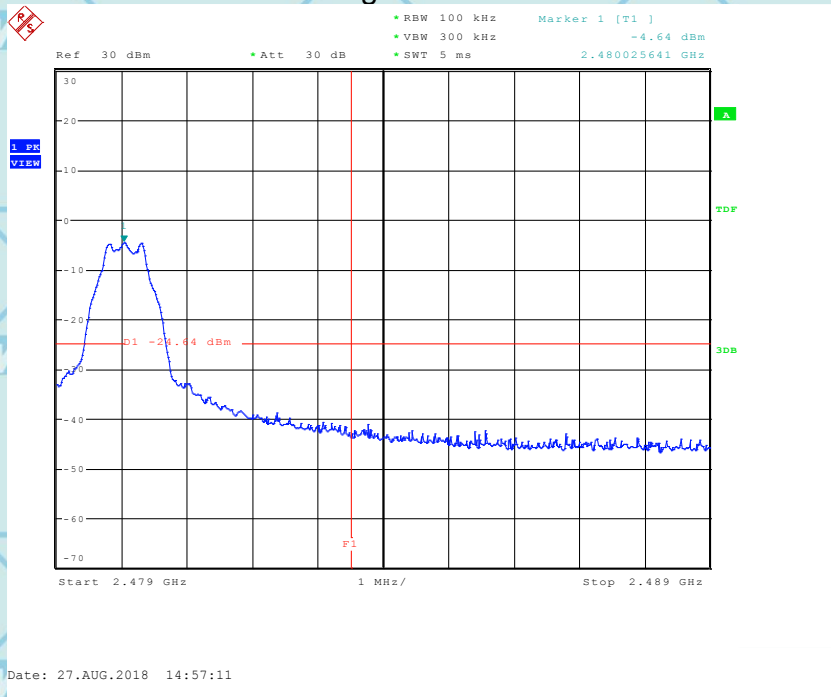



For Question,
Please Contact with WSCT
www.wsct-cert.com

Conducted spurious emissions

Channel Low

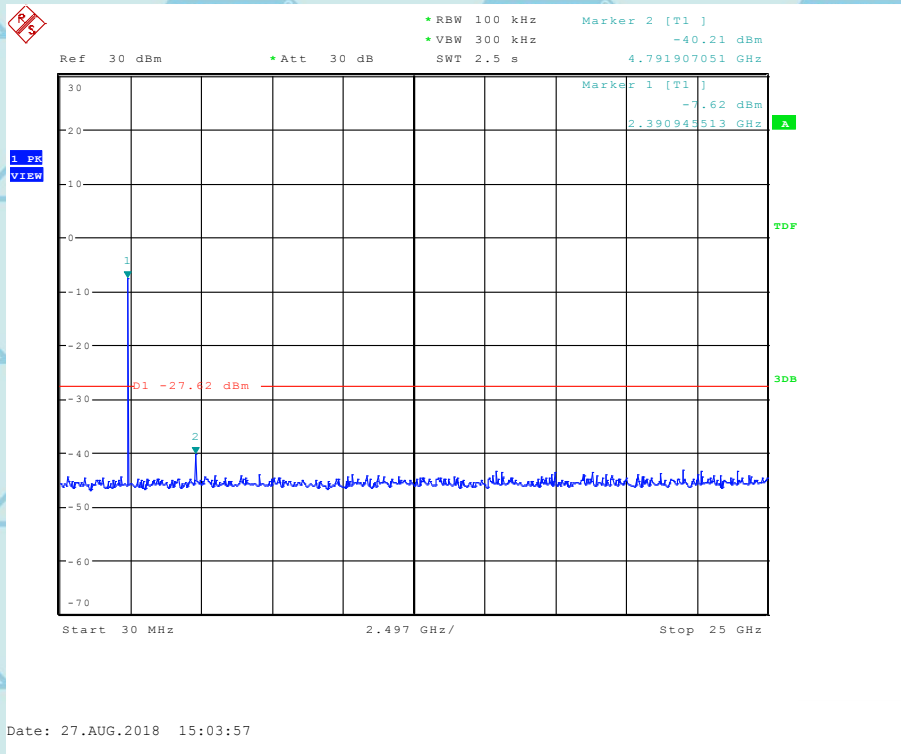

Channel Mid

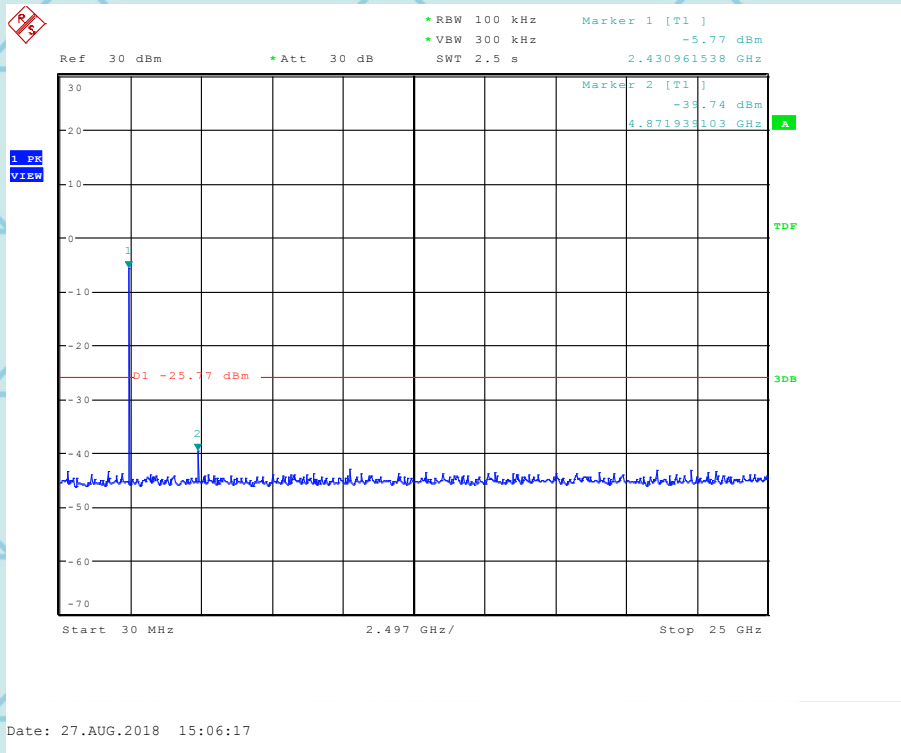



For Question,
Please Contact with WSCT
www.wsct-cert.com

Channel High

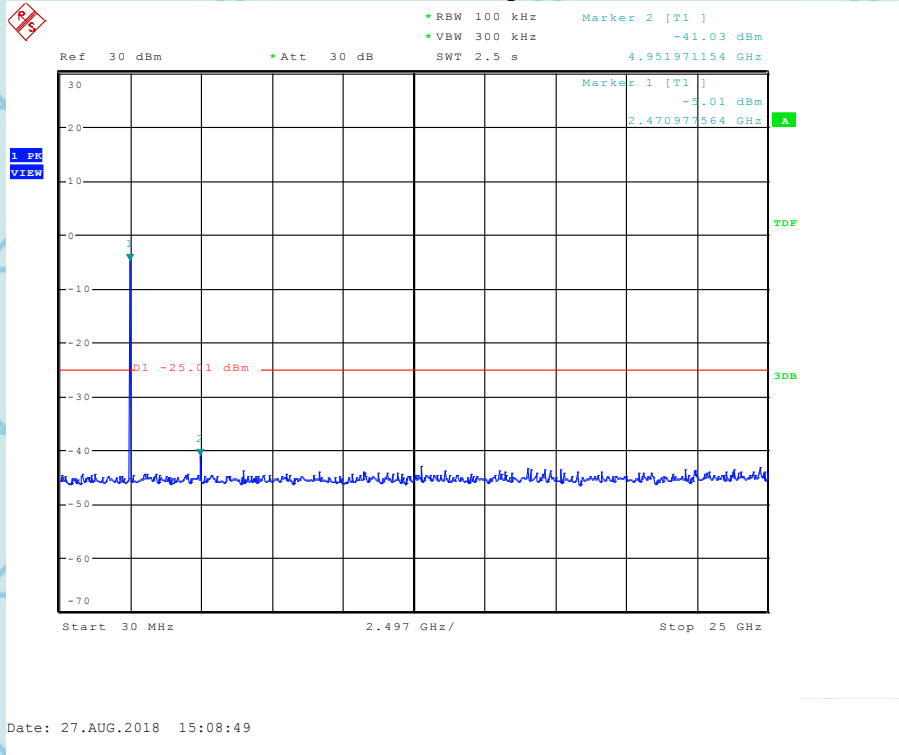



11. MAXIMUM CONDUCTED POWER SPECTRAL DENSITY

1.1.11. Test Equipment

Please refer to Section 4 this report.

1.1.12. Test Procedure

- 1, This procedure shall be used if maximum peak conducted output power was used to demonstrate compliance, and is optional if the maximum conducted (average) output power was used to demonstrate compliance.
- 2, Set analyzer center frequency to DTS channel center frequency.
- 3, Set the RBW to: $3 \text{ kHz} \leq \text{RBW} \leq 100 \text{ kHz}$, Set the VBW $\geq 3 \text{ RBW}$, Detector = peak.
Sweep time = auto couple
- 4, Trace mode = max hold, Allow trace to fully stabilize.

Note : The EUT was tested according to KDB 558074 for compliance to FCC 47CFR 15.247 requirements.

1.1.13. Environmental Conditions

Temperature:	25 °C
Relative Humidity:	55%
ATM Pressure:	100.0kPa

1.1.14. Applicable Standard

For digitally modulated systems, the power spectral density conducted from the intentional radiator to the antenna shall not be greater than 8 dBm in any 3 kHz band during any time interval of continuous transmission. This power spectral density shall be determined in accordance with the provisions of paragraph (b) of this section. The same method of determining the conducted output power shall be used to determine the power spectral density.





For Question,
Please Contact with WSCT
www.wsct-cert.com

Test Result

PASS

Channel Frequency (MHz)	Data Rate (Mbps)	PSD (dBm/3kHz)	Limit (dBm/3kHz)	RESULT
2402	1	-15.80	8	Compliant
2440	1	-15.05	8	Compliant
2480	1	-16.98	8	Compliant

Low Channel

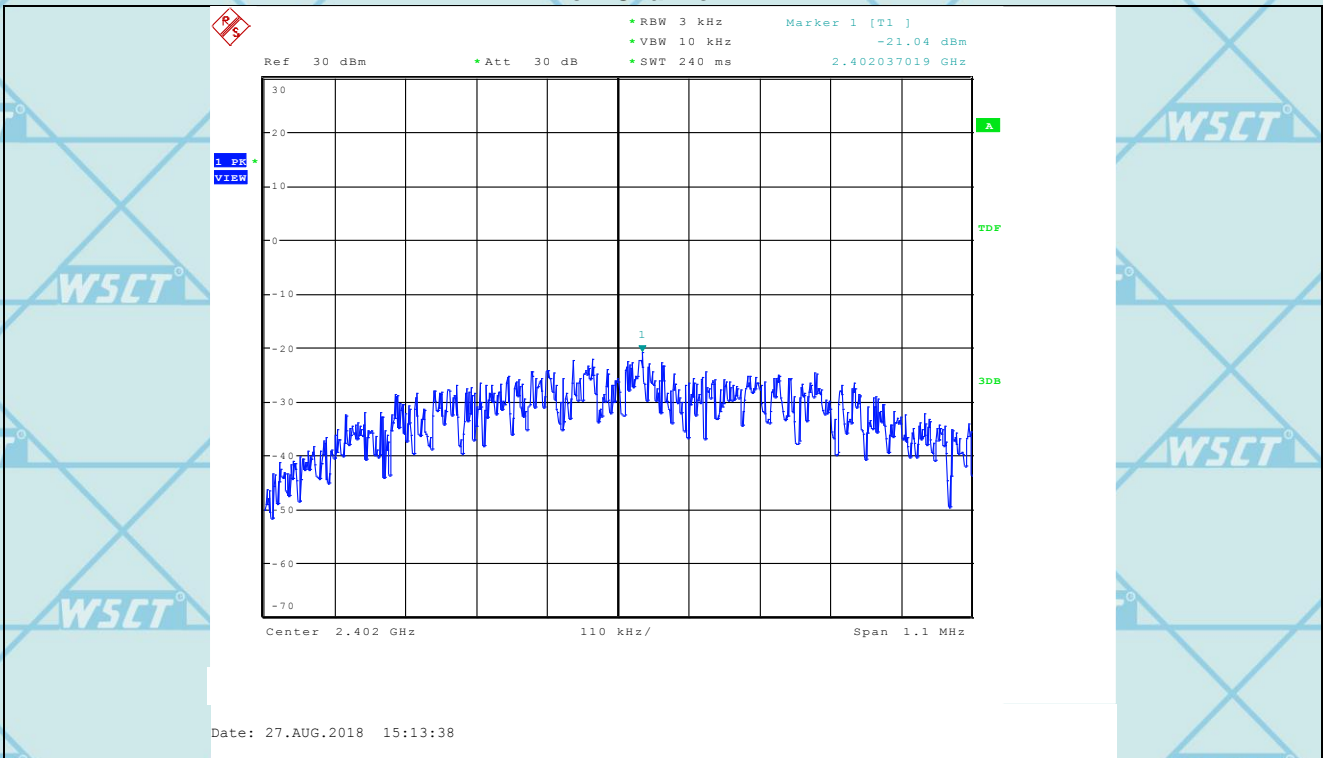



For Question,
Please Contact with WSCT
www.wsct-cert.com

Middle Channel

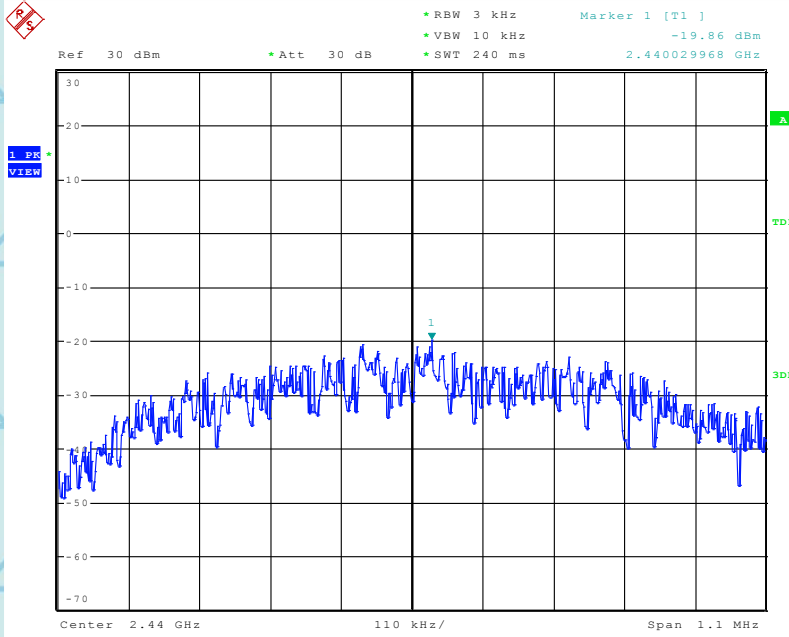

Date: 27.AUG.2018 15:12:26

High Channel

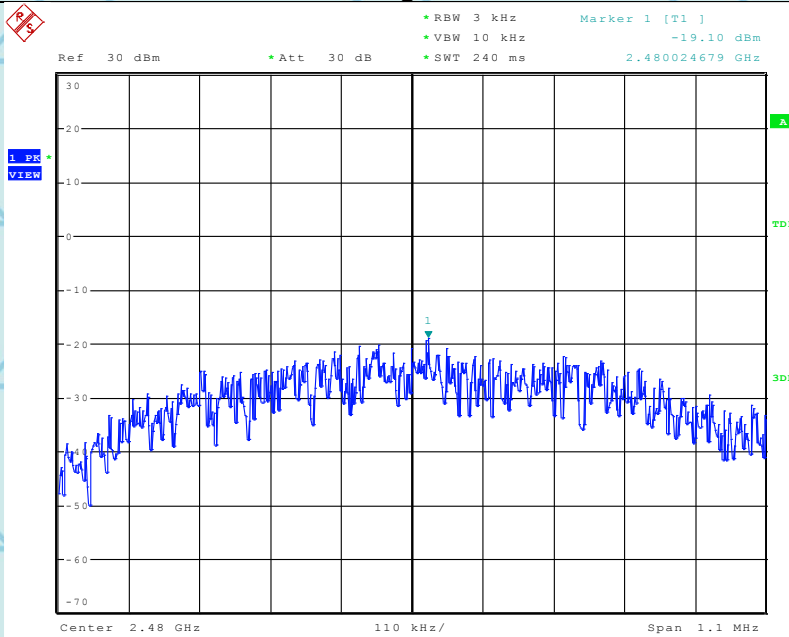

Date: 27.AUG.2018 15:10:48





For Question,
Please Contact with WSCT
www.wsct-cert.com

12. PHOTOGRAPHS OF THE TEST CONFIGURATION

RADIATED EMISSION TEST
(Frequency from 30MHz to 1GHz)

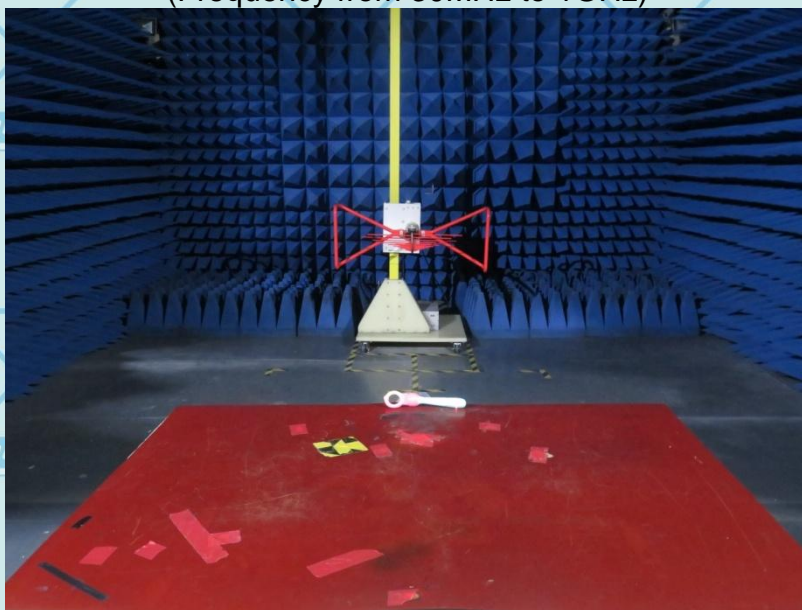

RADIATED EMISSION TEST
(Frequency above 1GHz)

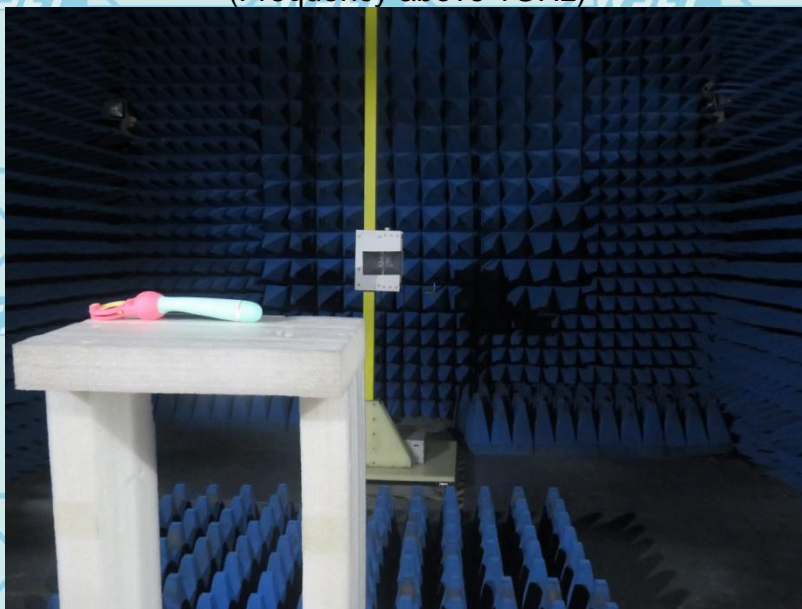



For Question,
Please Contact with WSCT
www.wsct-cert.com

13. PHOTOGRAPHS OF EUT

Appearance photograph of EUT



Appearance photograph of EUT





For Question,
Please Contact with WSCT
www.wsct-cert.com

Appearance photograph of EUT



Appearance photograph of EUT





For Question,
Please Contact with WSCT
www.wsct-cert.com

Appearance photograph of EUT



Appearance photograph of EUT





For Question,
Please Contact with WSCT
www.wsct-cert.com

Appearance photograph of EUT



Internal photograph of EUT





For Question,
Please Contact with WSCT
www.wsct-cert.com

Internal photograph of EUT

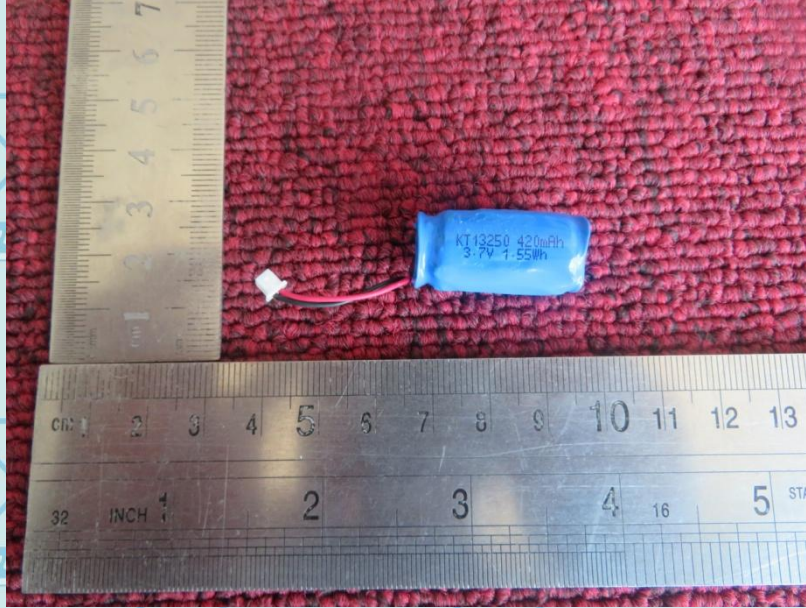

Internal photograph of EUT

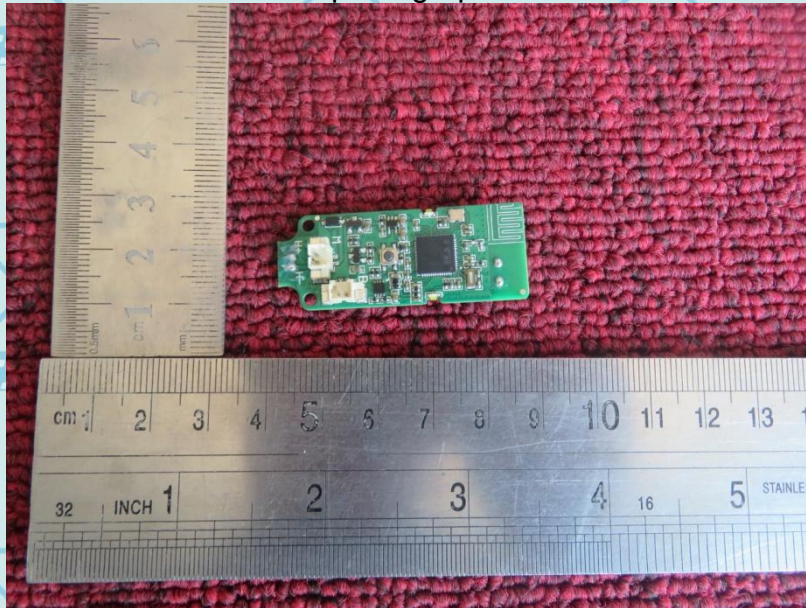



For Question,
Please Contact with WSCT
www.wsct-cert.com

Internal photograph of EUT

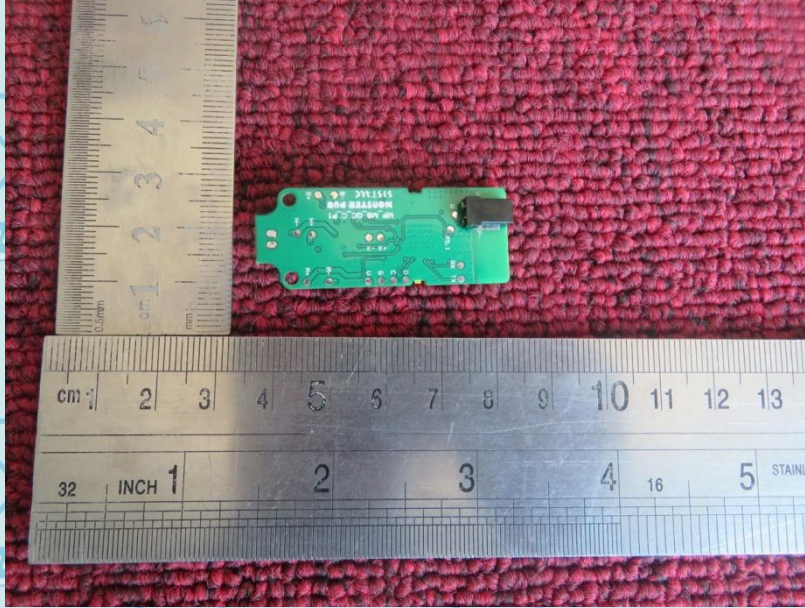

Internal photograph of EUT

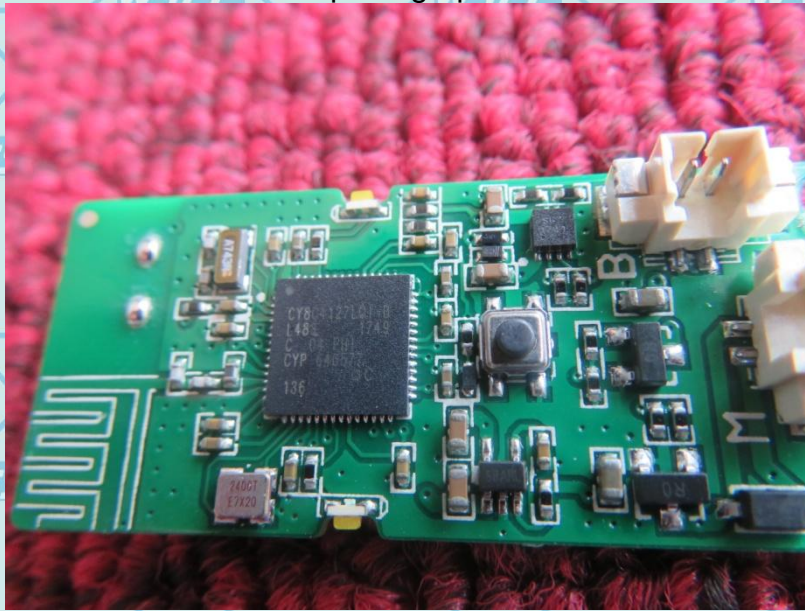

---END OF REPORT---

