

# Zino 2

《User Manual》

V2.0



## DISCLAIMER & WARNING

All users must read product operating instructions as well as this liability disclaimer before using any Hubsan product. By using a Hubsan product(s), users are accepting the terms and conditions of Hubsan liability and operational guidelines. This product is not suitable for minors under 14 years of age. While operating a Hubsan product (s), users also accept all liability and responsibility for their own behavior, actions as well as any consequences resulting thereof while using a Hubsan product(s). These products may only be used for purposes that are proper and in accordance with local regulations, terms and any applicable policies / guidelines Hubsan may make available. Users agree to comply with these terms and conditions, along with any and all relevant policies / guidelines set forth by Hubsan.

## INSTRUCTIONS

Some product flight functions are restricted in certain areas. Once you use this product, you are deemed to have read carefully the relevant ICAO regulations, local airspace control provisions and the regulations governing UAVs. You assume all liability for any non-compliance with the foregoing, are responsible for the consequences for your actions as well as any indirect and / or direct liability that arises as a result of these limitations.

## FLIGHT ENVIRONMENT REQUIREMENTS

- (1) Select an open environment devoid of high rise buildings and tall obstructions (such as trees and poles). Near buildings and obstacles, flight control signals and GPS signals can be severely weakened; GPS functions such as GPS mode and Return to Home may not function properly.
- (2) Do not fly in bad weather conditions (such as in wind, rain or fog).
- (3) Fly the aircraft in ambient temperatures of 0-40 °C.
- (4) When flying, please stay away from obstructions, crowds, high voltage lines, trees, water, etc.
- (5) To avoid remote control signal interference, do not fly in complex electromagnetic environments (such as venues with radio stations, power plants and towers).
- (6) The aircraft cannot be used in or near the Arctic circle or Antarctica.
- (7) Do not fly in no-fly zones.
- (8) Do not operate the aircraft near high pressure lines, airports or areas with severe magnetic interference.

## IMPORTANT SAFETY INFORMATION

### OPERATION

Be extremely careful and responsible when using the aircraft. Small electronic components can be damaged due to crashes or exposure to moisture / liquid. To avoid any injuries, do not use the aircraft with broken or damaged components.

### MAINTENANCE

Do not try to open or repair the units by yourself. Please contact Hubsan or Hubsan authorized dealers for service. For more information, please visit the official website at [www.hubsan.com](http://www.hubsan.com).

### BATTERY

Do not disassemble, squeeze, impact, burn, drop or trample the battery. Do not short-circuit or put the battery terminal in contact with metal. Do not expose the battery to temperatures above 60 ° C. Charge the aircraft battery prior to flight. Use a Hubsan dedicated charger for charging. Keep the battery out of the reach of children and away from any kind of moisture.

### FLIGHT

Please be mindful of personal safety and the safety of others while flying.

- Do not fly in bad weather conditions.
- Do not attempt to catch the aircraft while it is in flight.
- This product is intended for experienced pilots over the age of 14.
- After every flight, completely disarm the aircraft motors and disconnect the aircraft from power. Then, you may power off the remote control.

### READ THE DISCLAIMER AND SAFETY GUIDELINES FIRST BEFORE USE.

#### Symbol Explanation:

 Prohibited Operation

 Instruction

 Important Notice

 Explanation / Reference

## HUBSAN AIRCRAFT USES SMART BATTERY

- If you do not plan to fly the aircraft for a long time, store the battery ~50% charged to maintain battery performance and life.
- Please use Hubsan chargers for battery charging.
- Discharge the battery at 5C current or below. To avoid discharge related battery damage, do not prolong the discharge time.
- Do not charge on carpet to avoid fire.
- Batteries need to be recharged if unused for over 3 months.

- ⊙ 1. Do not disassemble or reassemble the battery.
2. Do not short-circuit the battery.
3. Do not use or charge near sources of heat.
4. Do not put the battery in contact with water or any kind of liquid.
5. Do not charge batteries under sunlight or near fire.
6. Do not puncture or subject the battery to force of any kind.
7. Do not throw or manhandle the battery.
8. Never charge a battery that has been damaged, become deformed or swelled.
9. Do not solder on or near the battery.
10. Do not reverse charge or over discharge the battery.
11. Do not reverse charge or reverse the battery polarities.
12. Do not connect the battery to a car charger / cigarette lighter or any kind of unconventional power source.
13. This battery is prohibited for non-designated devices.
14. Do not mix other types of batteries with lithium batteries.
15. Do not exceed the specified charging time.
16. Do not place the battery in a microwave or in areas of high pressure.
17. Do not expose the battery to the sun.
18. Do not use in environments with high static electricity (64V and above).
19. Do not use or charge in temperatures below 0 °C and above 45 °C.
20. If a newly purchased battery is used, leaking, possesses a bad smell or other abnormalities, return immediately to the vendor.
21. Keep away from the reach of children.
22. Use a dedicated battery charger and follow all charging requirements.
23. Minors who use the battery and its dedicated unit must be supervised by an adult at all times.

# Contents

Disclaimer		3.5 Staring/stopping The Motors	15
Important safety information		4 Flight Controller	16
Battery use precautions		4.1 Flight Control Mode	16
1 Aircraft	1	4.2 Flight Orientation Indicator (Single-color Lamp)	16
1.1 Aircraft Spare Part	1	4.3 Eturn-to-home(Rth)	17
1.2 Aircraft Battery	3	4.4 Search The Drone Apron	18
1.2.1 Aircraft Battery Charging	3	4.5 Flight Mode	18
1.2.2 Aircraft Battery Installation	3	4.5.1 Headless Mode	18
1.2.3 Intelligent Flight Battery Function	4	4.5.2 Creative Video	19
1.2.4 Precautions For Low Temperature	5	4.5.3 Follow Mode	19
1.2.5 Precautions For Battery	5	4.5.4 Orbiting	20
1.3 Propellers	6	4.5.5 Waypoint	20
2 Remote Controller ( America Mode 2 )	6	4.5.6 Line Fly Mode	21
2.1 Names Of Remote Controller Components	6	4.5.7 Time-lapse Photography	22
2.2 Remote Controller Features	7	4.5.8 Panorama Mode	23
2.3 Charging The Transmitter Battery	8	4.6 Gimbal Camera	24
2.4 Remote Control Diagram	9	4.6.1 Camera Settings	24
2.5 Remote Control Antenna Angle	10	4.6.2 Gimbal Pitch Axis Adjustment	24
3 Flight	10	4.6.3 Tf Card	25
3.1 Download The X-hubsan 2.0 App	10	5 Faq	25
3.2 Main Interface Guide	11	Zino 2 Parts & Accessories	27
3.3 Pairing The Aircraft	11	Limitation Of Liability	32
3.4 Aircraft Calibration	13	Fcc Information	33
3.4.1 Horizontal Calibration	13		
3.4.2 Compass Calibration	13		
3.4.3 Gps Accuracy Test	14		

# 1.Aircraft

## 1.1 Aircraft Spare Part

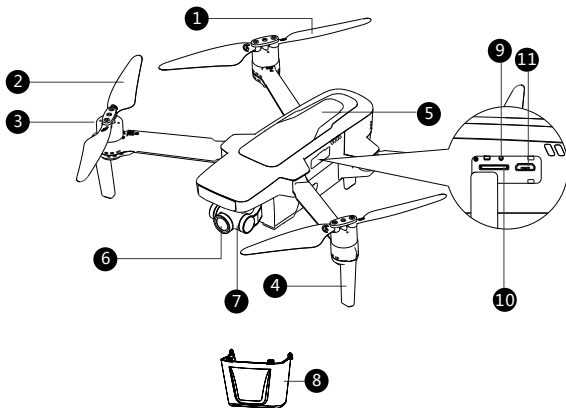

- |                           |                         |                |
|---------------------------|-------------------------|----------------|
| 1 Propeller A             | 3 Motor                 | 5 Body shell   |
| 2 Propeller B             | 4 Tripod (With Antenna) | 6 4K HD Camera |
| 7 3-axis gimbal           | 9 Bind key              | 11 USB Slot    |
| 8 Gimbal Protection Guard | 10 TF Slot              |                |

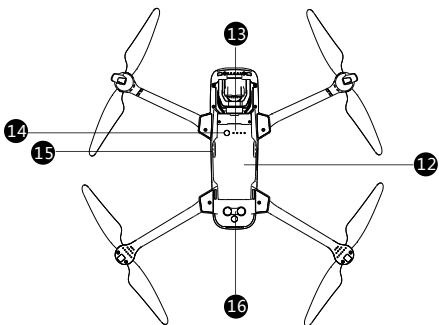

**12** Intelligent Battery

**13** Battery level indicator

**14** Battery power switch

**15** Battery buckle

**16** Auxiliary altitude  
hold system

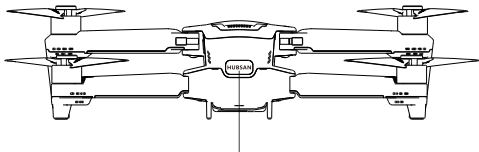

Rear LOGO



## 1.2 Aircraft Battery

### 1.2.1 Aircraft Battery Charging

Aircraft Lithium Battery Capacity: 3800mAh, 15.2V lithium battery equipped with a standard charger, charging time is about 110 minutes.

- ① Connect the power adapter to AC power (100V-240V, 50-60Hz).
- ② Connect the Intelligent Flight Battery and the power adapter with Intelligent Flight Battery turned off
- ③ Intelligent Flight Battery Level indicator will flash and indicate current battery level under charging
- ④ Intelligent Flight Battery is fully charged when power indicator lights are all off. Please remove the Intelligent Flight Battery and power adapter to complete charging.

Note: After using the battery, please re-charge it in time (at least 50%) to avoid long-term storage of the battery and affecting battery life.

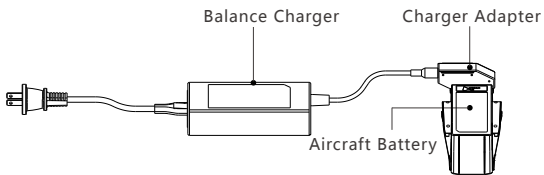

### 1.2.2 Aircraft Battery Installation

- ① Prepare the aircraft battery
- ② Put the battery in the battery compartment
- ③ Check if the battery is fastened

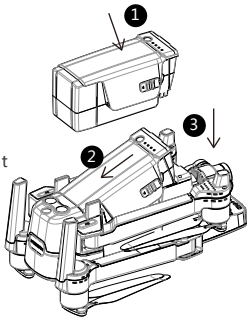

### 1.2.3 Intelligent Flight Battery Function

(1) Power display: The battery has a power indicator, which can display the current battery power.

(2) Battery storage self-discharge protection: After the battery is fully charged and stored for 10 days without any operation, the battery will automatically turn on the self-discharge mode to protect the battery (there may be slight heating during discharge).

(3) Balance protection: automatically balance the battery cell voltage to protect the battery.

(4) Charging temperature protection: When the battery temperature is below 5 °C or above 40 °C, battery will be damaged. So battery will not start charging at this temperature,

(5) Charging over-current protection: High-current charging will seriously damage battery. When charging current is too large, the battery will stop charging.

(6) Overcharge protection: Overcharging will seriously damage the battery. When the battery is fully charged, it will automatically stop charging.

(7) Over-discharge protection: Excessive discharge will seriously damage the battery. When the battery is not in use. Battery will cut off the output when it is discharged to a certain voltage. While over-discharge protection won't start during the flight.

(8) Short circuit protection: When the battery detects a short circuit, it will cut off the output to protect the battery.

(9) Cell damage detection: When the battery detects that the battery is damaged or the battery is seriously unbalanced, it will indicate that the battery is damaged.

(10) Hibernation protection: When the battery is on, the battery will turn off the output after 20 minutes and will enter into no-working state to maintain the power if no electrical equipment is connected. When the battery power is less than 5%, if the machine is locked but not turned off, it will automatically shut down. If the machine is turned off, the battery will automatically enter the sleep state to prevent over-discharge. At this time, short press the battery switch, the power indicator will not light up, the battery can be waken up by charging again.

(11) Communication: The aircraft can obtain battery information in real time through the communication interface on the battery such as voltage and power.

Battery switch	Short press to check the battery level, it will turn off after 3 seconds
	Short press first and then long press to turn on / off, the indicator light turns on / off

### **1.2.4 Precautions for Low Temperature**

- (1) If the battery is used in a low temperature environment ( $-10^{\circ}\text{C}$  to  $5^{\circ}\text{C}$ ), please fully charge and keep the battery warm before use.
- (2) The battery cannot be used in an environment below  $-10^{\circ}\text{C}$ .
- (3) In a low temperature environment, it is recommended to stop the flight immediately when the APP prompts "Low Battery Alarm" .
- (4) In a low temperature environment, it is recommended that the battery be preheated to  $5^{\circ}\text{C}$  or higher before flight.
- (5) In low temperature environments, the aircraft's wind resistance will be reduced due to the battery output power limitation. Please operate with caution.
- (6) Before flying in a low temperature environment, you can insert the battery into the aircraft to warm up for 1 to 2 minutes, and take off after the battery is fully warmed up.

### **1.2.5 Precautions For Battery**

Be sure to fully charge each time before using the Intelligent Flight Battery. The Intelligent Flight Battery must be use a Hubsan dedicated power adapter for charging.

- (1) The temperature of the Intelligent Flight Battery is high after the flight is over. The Intelligent Flight Battery must be cooled to room temperature before charging the battery.
- (2) The charging temperature range of the intelligent flight battery is  $5^{\circ}\text{C}$  to  $40^{\circ}\text{C}$ . If the temperature of the battery cell is not in this range, the battery management system will prohibit charging. The optimal charging temperature range is  $25 \pm 3^{\circ}\text{C}$ . Charging in this temperature range can extend the battery life.

## 1.3 Propellers

Before installing the propeller, please carefully check the letters beside the aircraft motor and the letters on the propeller. The two letters must be the same when installing; When the blade is damaged or needs to be replaced, remove the screw counterclockwise to remove the propeller.

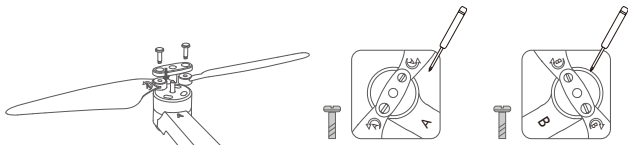

## 2. Remote Controller ( America Mode 2 )

### 2.1 Names Of Remote Controller Components

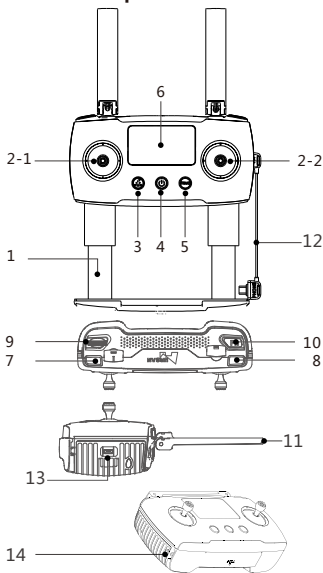

- 1) Mobile Device holder
- 2-1) Throttle / Rudder Stick
- 2-2) Forward / backward / left / right flight control levers
- 3) Return to Home
- 4) Power
- 5) F / N / S mode:  
Movie mode / normal mode / sport mode
- 6) Display
- 7) Photo
- 8) Video
- 9) Gimbal Adjustment Wheel
- 10) Custom keys
- 11) Antenna
- 12) Remote control extension cable
- 13) Charging / Adapter Port
- 14) Lanyard hole
- 15) Rocker storage
- 16) Cable storage

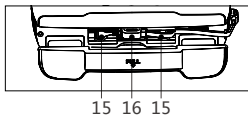

## 2.2 Remote Controller Features

S/N	Key / Switch	Function
(1)	Throttle / Rudder Stick	Push the stick forward or backward and the quadcopter will ascend or descend (respectively). Push the stick left or right and the quadcopter will fly left or right (respectively).
(2)	Elevator / Aileron Stick	Push the stick forward or backward and the quadcopter will fly forwards or backwards (respectively). Push the stick left or right and the quadcopter will rotate counterclockwise or clockwise (respectively).
1	Throttle / Aileron Stick	Push the stick forward or backward and the quadcopter will ascend or descend (respectively). Push the stick left or right and the quadcopter will rotate counterclockwise or clockwise (respectively).
2	Elevator / Rudder Stick	Push the stick forward or backward and the quadcopter will fly forwards or backwards (respectively). Push the stick left or right and the quadcopter will fly left or right (respectively).
3	Return to Home	Long press to enter home mode, short press to exit and return to home; During the flight, the remote control "Beep... Beep..." prompt (once every three seconds)
4	Power Switch	Long press to power on or off.
5	F / N / S mode (Movie / Normal / Sport mode)	Movie mode: Flying speed of the aircraft 1m / s Normal mode: the aircraft flies at the maximum speed set by the APP, 12m / s Sport mode: the maximum flying speed of the aircraft is 20m / s
6	Display	Display flight parameters
7	Photo	Short press to take photos.
8	Video	Long press to start recording, short press to end recording
9	Gimbal Adjustment Wheel	Controls the angle of the gimbal.

S/N	Key / Switch	Function
10	Custom keys	<p>Press and hold the Fn button, turn the gimbal adjustment Wheel to adjust tthe brightness of the remote control display at the same time.</p> <p>The remote control buzzer beeps when a low battery is triggered or RTH Press the Fn button for 1.5 seconds, and the beep will stop. Long press the Fn button again 1.5 seconds to restore the beep.</p> <p>Custom keys,set the function on the APP and save it in when the APP is not connected, [short press] Fn doesn't work.</p> <p>Function one: Exit the current flight mode. APP is performing various functions.</p> <p>In the mode, short press Fn to exit the current mode and the aircraft hover.</p> <p>Function two: short press Fn to execute gimbal return.</p> <p>Function three: no function Settings)</p>
11	Charging / Adapter Port	Charge the remote control or connect with a mobile device
12	Low Battery Warning	Low battery warning for the aircraft or remote control: Remote control "Beep...Beep..." prompt (one time per second)
13	Standby Protection	<p>The remote control has no operation for 10 minutes after stand-by, the remote control "Beep...Beep..." Tips (once every three seconds)</p> <p>After 3 minutes of prompting the sound, the remote control will automatically shut down, and there will be operation within 3 minutes, and the prompt tone will stop</p>

### 2.3 Charging The Transmitter Battery

The remote is charged using the Micro USB cable as shown:

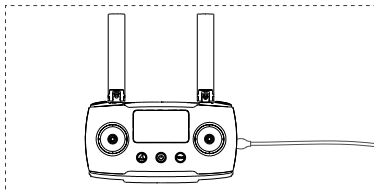

The remote control charging time is about 2.5 hours.The remote control battery indicator light flashes during charging.When charging is complete, the LEDs will be solid.

## 2.4 Remote Control Diagram

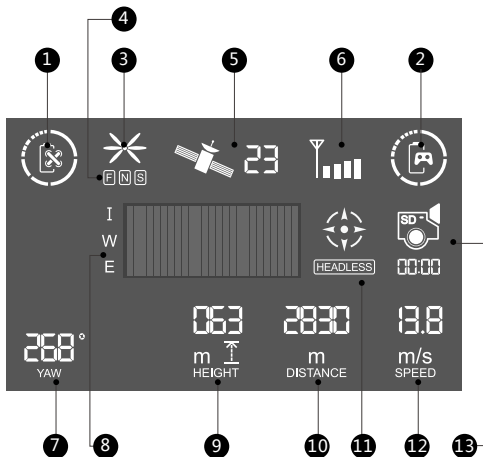

1 Aircraft Battery

2 Remote Controller Battery

5 Aircraft GPS Satellite

6 Aircraft Signals

9 Photo / Video

10 Flight Distance

12 Aircraft speed

3 Propellers Status

4 Aircraft Mode

7 Heading Angle

8 Character Area

11 Compass Calibration /  
Headless Mode

13 Photo / Video

## 2.5 Remote Control Antenna Angle

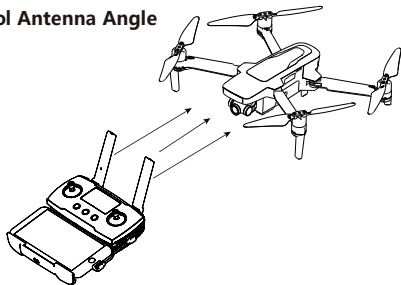

- (1) Adjust the angle of the remote control antenna and try to face the flight direction of the aircraft as much as possible;
- (2) Long-distance state, the distance between the two antennas is properly tightened to maintain the antenna directivity;
- (3) Closer State, the two antennas are properly separated to maintain a wide receiving range;
- (4) Do Not Form an occlusion or cross between the antennas.

## 3 Flight

### 3.1 Download The X-hubsan 2.0 App

Before flying, users must download the X-Hubsan 2.0 APP.

Download the APP for free by scanning the code as shown or by download it via APP Store (IOS) Or Goggle Play.



X-Hubsan 2.0



## 3.2 Main Interface Guide

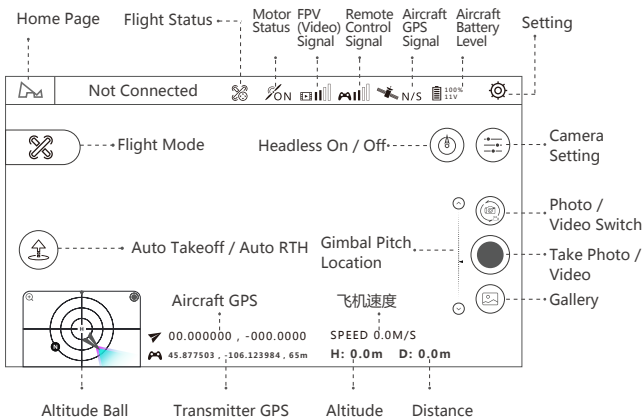

Note: This is the interface in Map mode

## 3.3 Pairing The Aircraft

- (1) Run X-Hubsan 2.0 APP, choose the aircraft model.
- (2) Short press the aircraft power button and then long press for a few seconds to turn it on.
- (3) Short press the transmitter power button and then long press for a few seconds to turn it on, connect the transmitter to your mobile device with the RC cable.



(4) Start binding (This step is only required when first binding or replace the transmitter, do it manually.)

1. Go to APP - Setting - Controller, transmitter connection method: Leas

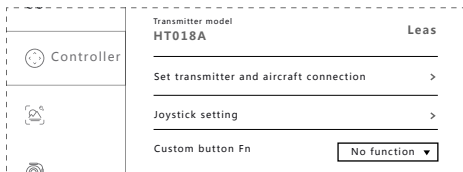

2. Using a pin to long press the aircraft bind button to enter binding mode.

3. Select "Set transmitter and aircraft connection" and scan aircraft.

4. Select the aircraft and connect.

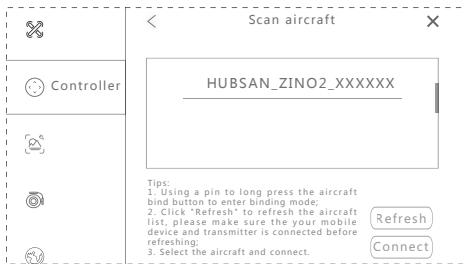

You have to complete the binding process on APP when first use or replace the transmitter, and then you can fly the aircraft with the transmitter directly without connecting to the APP.

Tips:

-The binding process has been completed in the factory. Generally, user only need to do the first 3 steps.

-After entering binding mode, all 4 LEDs flash rapidly and become solid after binding successfully.

-Please keep the distance between the aircraft and transmitter within 1 meter when binding.

## 3.4 Aircraft Calibration

### 3.4.1 Horizontal Calibration

During the flight, when the aircraft has a significant horizontal deviation, please land the drone, lock the motor, and place it on the horizontal ground. Then enter the APP setting interface, select horizontal calibration, the aircraft will automatically perform the calibration, the four heading lights will flash, and it will stay on after the calibration is completed. Do not move the aircraft during calibration.

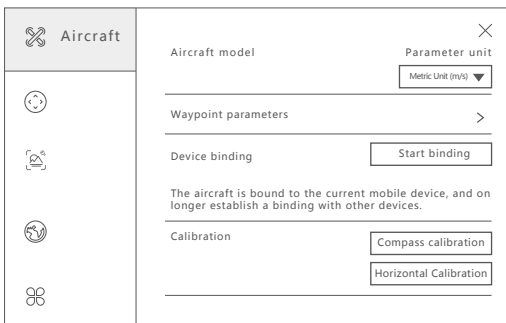

### 3.4.2 Compass Calibration

When using for the first time, the compass calibration will pop out before takeoff. Follow the instructions on your screen, rotate the aircraft horizontally the n point the aircraft nose down and rotate it c lockwise. The compass calibration message will disappear once it is complet ed. You must complete the compass calibration before flying the aircraft for the first time.

The compass is susceptible to interference by electronic equipments,magnetic interference and metals and interference could lead to erratic behavior and loss of control. Regular calibration helps to keep the compass and its readings accurate. In the "Settings", select "Compass Calibration" under "Calibration".

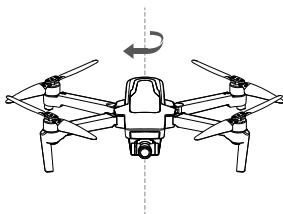

Compass 1

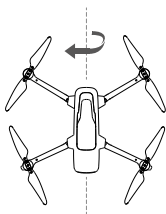

Compass 2

### 3.4.3 GPS Accuracy Test

After entering the APP interface, tap on "Aircraft", select "GPS Accuracy Test" then tap on "En able / Restart GPS Accuracy Test". The aircraft will automatically proceed to test.

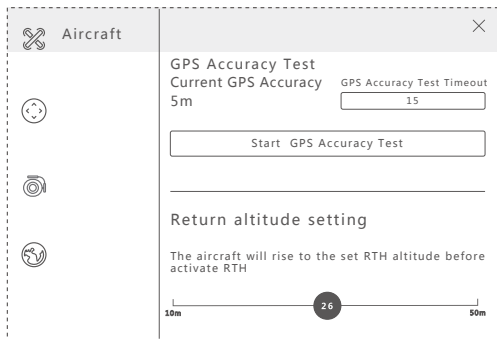

### 3.5 Staring/Stopping the Motors

Motor starting condition

- (1) The aircraft, remote control and mobile phone have been connected;
- (2) The aircraft has been calibrated by the compass (four Orientation lights are always on);

(3) The aircraft must be placed horizontally

(4) It is not recommended to take off forcefully when the GPS satellite signal is not reached.

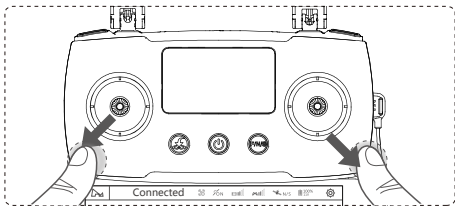

### Starting the Motors

Push both stick to the bottom outer corners to start the motors. Once the motors have started spinning, Release both sticks simultaneously.

### Stopping the Motors

When the motor is running, Push both stick to the bot tom outer corners to stop the motors. Release both sticks once motors stop.

### Forced to Stop

When flying in the air, the motor c an be forced to stop in 2 seconds with outer eight bar. Use this function with caution, as it can cause the aircraft to fall and may endanger personal safety.

## 4 Flight Controller

### 4.1 Flight Control Mode

Flight Speed	
Movie Mode	Maximum speed 1m/s
Regular Mode	Maximum speed is 12m / s, which can be adjusted in the APP settings by 10% -100%
Sport Mode	The maximum speed is 20m / s, the sport mode is only available in the GPS mode.

<b>Flight Control Mode</b> (The flight controller judges the GPS signal and switches the corresponding mode)	
<b>GPS Mode</b>	With good GPS conditions, using GPS fixed point and optical flow assist.
<b>Optical flow mode</b>	When the aircraft is hovering, and the GPS quantity is insufficient, using the optical flow fixed-point mode. The effectively fixed height of optical flow mode is 5 meters and greater than 5 meters for attitude mode. In this mode, the maximum speed of the aircraft is 3m / s. The intelligent mode is not available. Please fly with caution.
<b>Attitude mode</b>	When GPS and optical flow effects are weak, the only manual flight is available, and intelligent mode is prohibited. In attitude mode, the aircraft's fixed point is abnormal. Please land as soon as possible.

## 4.2 Flight Orientation Indicator ( Single-Color Lamp)

Calibration	
Power On And Start Up	All 4 LEDs flash slowly
Compass Calibration	Calibrate Compass 1:All 4 LEDs flash in cycle Calibrate Compass 2:All 4 LEDs flash in vertical pairs alternately
Horizontal Calibration	All 4 LEDs flash slowly
Flight Mode	
Regular Mode	All 4 LEDs are solidly lit
Low Power Indicator	Fore / frontal blue LEDs stay solidly lit and the rear red LEDs flash rapidly
Loss Of Flight Control Indicator	The front Orientation light flashes slowly in blue, and the rear Orientation light is steady red. (When there is a conflict with low battery, priority is displayed.)
Headless Mode	Fore/front blue LEDS flash in vertical pairs alternately and rear red LEDs stay solidly
RTH	Fore / frontal blue LEDs stay solidly lit and the rear red LEDs flash slowly
Photo	Rear red LEDs flash once
Video	Rear red LEDs flash alternately
Light-Off	Long press the camera button.

### 4.3 Return-to-home(Rth)

There are three types of RTH: One-key RTH, Low Battery RTH, and Failsafe RTH. When taking off, GPS  $\geq$  6 stars, the aircraft successfully recorded to the return point. If there is no GPS signal forced take-off, the position with the latest GPS  $\geq$  6 stars is recorded as the return point.

RTH-Process
<ol style="list-style-type: none"><li>Record "Home Point"</li><li>Trigger return conditions</li><li>Adjust the direction of the head</li><li>Return to the return altitude set by APP<ol style="list-style-type: none"><li>Regardless of the current height of the aircraft, if the aircraft is within 5 meters of the horizontal distance, land directly;</li><li>If the horizontal distance is 5 meters away and within 20 meters, return at the current altitude;</li><li>In 20 meters away, if the altitude of aircraft is more height than the return altitude, it will return directly; If no, it will rise to up to the return altitude, and then RTH;</li></ol></li><li>Search for the drone apron during the landing process (Make sure this function is on).</li></ol>
One-key RTH
APP one-Key RTH / remote control one-Key RTH
Low Battery RTH
<p>The flight controller will display a notice when a low battery warning is triggered. The aircraft will automatically return to the Home Point if the current power is enough, otherwise it will land directly. when without GPS signal or signal is not strong that will land directly.</p> <p>Performance requirements:</p> <ol style="list-style-type: none"><li>The appropriate low-voltage protection voltage is automatically calculated according to the altitude and distance of the flight;</li><li>After the low power forced landing or crash, if the power is lower than 10%, enter the protection mode: turn off the picture transmission, but save normal data communication.</li></ol>
Failsafe RTH
<p>When the aircraft loses connection with the remote control for more than 5 seconds, the aircraft automatically returns or land directly. Performance requirements:</p> <ol style="list-style-type: none"><li>After the aircraft loses control for 5 seconds, it triggers automatic return;</li><li>If the connection is restored during the return flight, the return flight can be canceled;</li><li>Landing directly when there is no GPS signal or the signal is not strong.</li><li>After the aircraft re-establishes the connection, the priority control signal establishes a connection. The connection is not established until 10 seconds after the signal is transmitted, and the image connection can also be forced by the shortcut button.</li></ol>

## 4.4 Search The Drone Apron

When the aircraft landed or returned to a height of about 10 meters from the ground, it will automatically enter the search for the drone apron function.

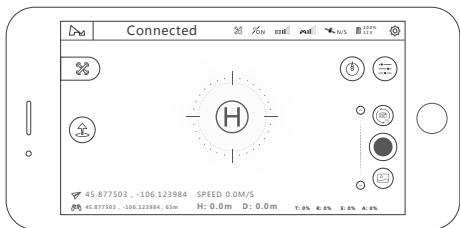

(1) The gimbal overlooks the search for the drone apron [H], Apron requirements: 1 Sharp contrast, 2 white "H" lettering, 3 Apron without obstruction.

(2) The aircraft will first pan to the top of the apron and locks the apron, then descend smoothly after successful recognition. When landing to a height of less than 3 meters, the aircraft pan/tilt will resume normal view and no longer adjust the position of the aircraft and land directly. If an error is identified or other unexpected circumstances occur, press the stop button to exit the function.

(3) If the aircraft has not been found to the apron or critical low battery when it has landed 5 meters, the aircraft will land directly.

(4) The search for the drone apron function cannot be performed in video mode.

(5) If needn't, please turn it off in the settings.

## 4.5 Flight Mode

### 4.5.1 Headless Mode

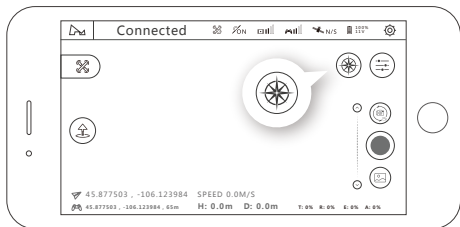

Record a flight path, the direction of the nose is the direction of advance, the heading and forward direction of the aircraft are independent of the direction of the nose during flight.



## 4.5.2 Creative Video

Panorama Photography:

- (1) Select the direction of rotation (clockwise / counterclockwise);
- (2) Set the rotation angle, the range of rotation angle ( $90^{\circ}$  -  $360^{\circ}$ , accuracy  $1^{\circ}$ );
- (3) Set the speed ( $2-30^{\circ}$  / sec, accuracy 1);
- (4) Click GO, the aircraft rotates in place in the hover position, shooting during the rotation + storage Video recording;
- (5) During the execution, you can click the exit button to exit the mode and save the video.

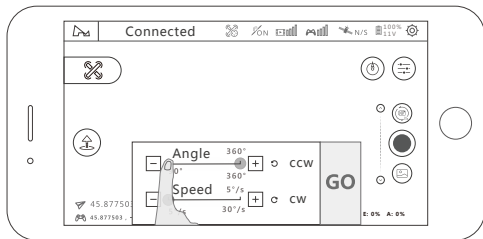

## 4.5.3 Follow Mode

Enter into follow mode to choose the Image tracking and GPS follow.

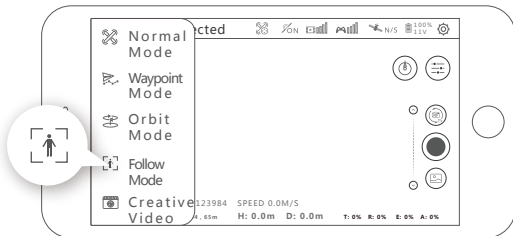
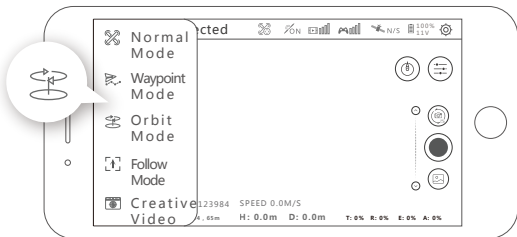

**Image Tracking:** Select the target on the APP. After the selecting successfully, tap on "Go" and the aircraft will follow the movements of the target. The range of tracking altitude and distance is 5-15 meters. This function cannot be turned on within 5 meters of the distance between the person and the aircraft.

**GPS Follow:** the aircraft will follow the control device to fly when turning on the GPS follow.

#### 4.5.4 Orbiting

Tap on "Mode Selection" then "Orbit Mode" to set the current location or the position of the mobile device as the center. During Orbit mode, you can adjust the speed and direction by moving the control stick left and right and adjust the orbit radius by moving the control stick forward and backward.



#### 4.5.5 Waypoint

The aircraft will fly along the flight path drawn on-screen or saved ,you can adjust the speed of the aircraft during flight .

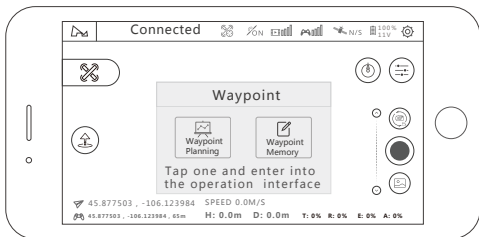

**Waypoint Planning:** You can preset the waypoint parameters such as the number of waypoints, the altitude of each waypoints and other parameters. The aircraft will follow the preset parameters after you activate waypoint mode. You can control the flying speed during flight or you can pause or resume the Waypoint mode.

**Waypoint Memory:** After entering the mode, fly the aircraft and tap on "Memorize Waypoints" on the APP and the aircraft will mark the location. After memorizing all the waypoints, upload and execute, then the aircraft will fly according to the memory.

If the aircraft is not in the starting position, the aircraft will fly to the starting position before starting this function.

#### 4.5.6 Line Fly Mode

Tap on "Mode Selection" then "Line Fly Mode". Set the angle, distance and speed of the aircraft.

Performance requirements:

1. Set the angle (0 ~ 360 °, accuracy 1 °);

Set the distance (10-100 meters, accuracy 1 meter); set the speed (1-8 m / s, accuracy 0.1);

2. Once setup is complete, the aircraft will execute Line Fly mode.

During the flight, pilots can take photos or videos manually, or pause / resume / stop the flight at any time.

During the flight, the throttle stick is controllable and the other directions are uncontrollable;

3. You can pause/resume/stop the flight at any time.

4. When the aircraft is low on battery or lost connection, the aircraft will always set Return to Home as the priority mission.

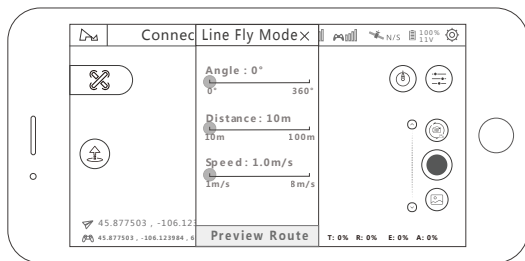

## 4.5.7 Time-lapse Photography

When you choose time compressor mode, you can choose free time-lapse and surround time-lapse.

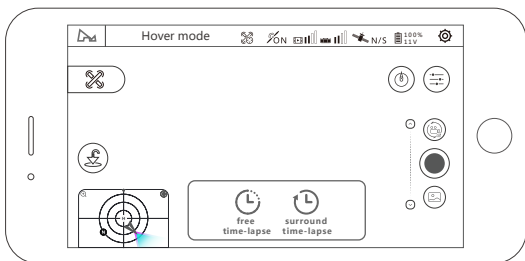

### Free Time-lapse

The aircraft will take a certain number of photos and compose time-lapse videos automatically according to the parameters which you set. During the process of shooting, the user can control the flight of the aircraft freely.

- (1) choose free time-lapse;
- (2) set the shutter interval taken by the aircraft, the time of video generated and the maximum flight speed;
- (3) after done, please click 'GO' and start shooting.

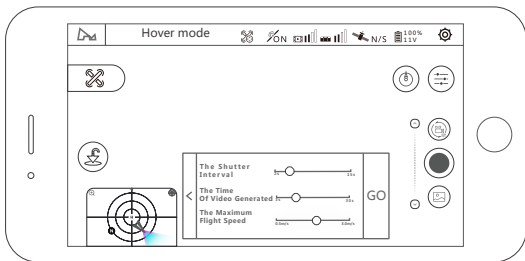

## Surround Time-lapse

The aircraft will take a certain number of photos and compose time-lapse video automatically according to the circle point of interest and the parameters which you set. During shooting, operating lever will automatically quit the task.

(1) select surround time-lapse

(2) set the shutter interval taken by the aircraft, the time of video generated and the maximum flight speed

(3) set the circle direction, and position the circle center by adjusting the circle radius and the direction of the aircraft nose

(4) after done, please click 'GO' and start shooting.

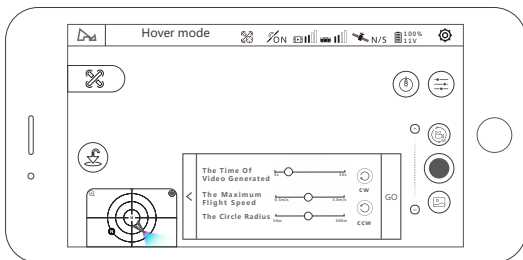

## 4.5.8 Panorama mode

In the panoramic mode, you can choose spherical, 180°, vertical shooting and wide angle shooting. In this mode, the aircraft will perform the shooting task automatically. After the shooting done, you can view photos and videos from the TF card, also export photos and videos and composite it. During shooting, the user will quit the task automatically.

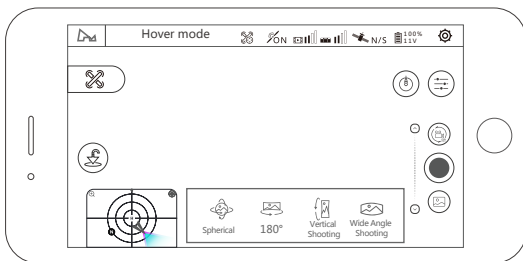

## 4.6 Gimbal Camera

### 4.6.1 Camera Settings

Click the setting icon for camera on the main interface of the APP and you can set the resolution, white balance, color and other parameters as follows:

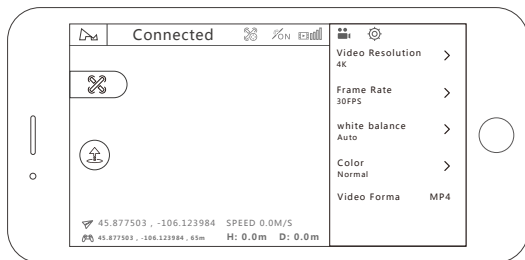

### 4.6.2 Gimbal Pitch Axis Adjustment

#### APP Ddjustment

Method 1: long press the blank of the video preview interface and the mobile device will vibrate once. When the icon appears at the position which you press, you can adjust gimbal pitch axis by sweeping your finger up and down the screen.

Method 2: you can fine tune the angle of gimbal pitch by clicking up-down button on the slider of gimbal pitch axis.

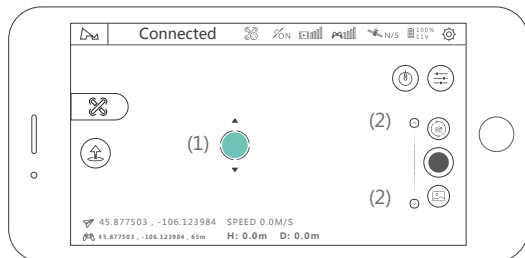

#### Transmitter Adjustment

You can adjust the angle of gimbal pitch by fiddling with the control thumb-wheel of gimbal pitch.

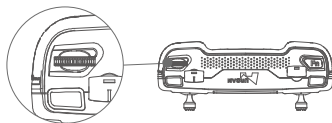

### 4.6.3 Tf Card

- (1) support TF card, U3 above 16G/32G/64G/128G;
- (2) hot plug is supported. It is recommended to plug in the TF card after switch off the power.

## 5 FAQ

1.The mobile device and remote control cannot be connected

- (1) Check whether the status of the APP control signal icon has changed
- (2) For USB Settings on android phones, check out "Android phone connection tutorial"

2. Aircraft cannot be searched

- (1) Restart the plane, remote control and x-hubsan 2.0 APP
- (2) Update the aircraft firmware
- (3) Check whether the TF card slot of the drone is keeps on red light, if it flashing, means the aircraft is abnormal

3. Picture transmission stuck or easy to lose control and disconnected

- (1) Adjust the antenna Angle to the aircraft, without the block between them
- (2) Change the flight site, please do not fly in tall buildings, or near signal tower
- (3) Update the latest firmware

4.The aircraft is hovering unsteadily

- (1) Change the flight site, please do not fly near tall buildings and signal towers
- (2) Do the compass calibration and horizontal calibration of the aircraft
- (3) Judge whether the wind is too strong to affect the flight

5. Aircraft GPS accuracy is not precise or cannot pass the GPS accuracy test

- (1) in the open area of the outdoor with GPS over 6 satellite
- (2) Walk around near the aircraft
- (3) Replace the mobile device

6.The battery cannot charge

Replug the charger and battery

7. with short flight time

Battery overcharge or high temperature environment can easily lead to reduction of battery life, it is recommended to keep the remaining 50% or so, full charge again before use

8. The tilt Angle of the gimbal is too large or the gimbal show abnormal

- (1) Restart the aircraft to recalibrate the gimbal
- (2) Check on the APP to see whether the gimbal status is normal

9. Gimbal initialize failed

Before starting the aircraft, take off the protective cover of the gimbal

10.The picture is not clear

- (1) Check whether the lens protective film is peeled off
- (2) Fly in a well-lit environment
- (3) Shooting parameters setting in camera Settings of APP
- (4) Video source files are saved in TF card files with suffix AA

11. Lens fogging

- (1) humid climate causes lens foggy, change aircraft storage location

Place some desiccant in the protective cover of the gimbal when storage

12. Picture or video is lost

- (1) Perform completing recording operation after recording video, otherwise it may lead to video damage or loss
- (2) Check whether the TF card is broken

13. constant-height flight by flow cannot be used

- (1) The current environment light is weak, please fly on outdoor with sufficient light
- (2) detect whether the optical flow lens at the bottom of the aircraft is worn or covered by foreign matter



## ZINO 2 Parts & Accessories



ZINO200-01



ZINO200-02



ZINO200-03



ZINO200-04



ZINO200-05



ZINO200-06



ZINO200-07



ZINO200-08



ZINO200-09



ZINO200-10



ZINO200-11



ZINO200-12



ZINO200-13



ZINO200-14

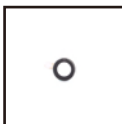

ZINO200-15

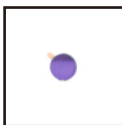

ZINO200-16



ZINO200-17



ZINO200-18



ZINO200-19



ZINO200-20



ZINO200-21



ZINO200-22



ZINO200-23



ZINO200-24



ZINO200-25

## ZINO 2 Parts & Accessories



ZINO200-26

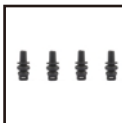

ZINO200-27



ZINO200-28



ZINO200-29



ZINO200-30



ZINO200-31



ZINO200-32



ZINO200-33



ZINO200-34



ZINO200-35



ZINO200-36



ZINO200-37



ZINO200-38



ZINO200-40



ZINO200-46



ZINO000-10



ZINO000-11



ZINO000-12



ZINO000-29

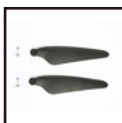

ZINO000-30



ZINO000-37



ZINO000-42



ZINO000-48



ZINO000-54



ZINO000-55

## ZINO 2 Parts & Accessories



ZINO200-47



ZINO200-48



ZINO200-49



ZINO200-50

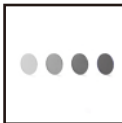

ZINO200-51

## ZINO 2 Parts & Accessories

ITEM NUMBER	NAME OF SPARE PARTS	ITEM NUMBER	NAME OF SPARE PARTS
ZINO200-01	Gyroscope Cover	ZINO200-18	Cooling bracket
ZINO200-02	Upper Body Shell	ZINO200-19	gimbal steel plate (with screw)
ZINO200-03	lower body shell, Arm wear gasket	ZINO200-20	Gyroscope upper shell, gyroscope lower shell
ZINO200-04	Back shell	ZINO200-21	gimbal supporter
ZINO200-05	Front lens base and lower lens base	ZINO200-22	Cooling air guide cover
ZINO200-06	gimbal anti-separation, Left front arm cover, Right front arm cover, left rear arm cover Right rear arm cover, arm wire cover, Side key	ZINO200-23	TF card outside lid
		ZINO200-24	gimbal protection cover
		ZINO200-25	rubber feet
ZINO200-07	Left front rubber feet , right front rubber feet	ZINO200-26	Damping ring
ZINO200-08	Left front lamp cover, right front lamp cover, Left rear rubber feet , right rear rubber feet	ZINO200-27	gimbal dampeners
		ZINO000-29	propeller A (with screw)
ZINO200-09	Left antenna bracket, right antenna bracket, Socket pressure piece, power board pressure block, Battery anti loose pressing block, battery anti loose top block, Optical flow bracket, battery ejection spring	ZINO000-30	propeller B (with screw )
		ZINO000-48	propellers A+B (with screw)
		ZINO200-28	motor (with screws)
		ZINO200-29	ESC (blue lighth module)
ZINO200-10	Left front white arm 1 (inc.ESC )	ZINO200-30	ESC (red light module)
ZINO200-11	Right front white arm 2	ZINO200-31	Aircraft antenna
ZINO200-12	Left rear white arm 3 (inc.ESC )	ZINO200-32	main board
ZINO200-13	Rear right white arm 4	ZINO200-33	Power adapter board
ZINO200-14	Hardware shaft	ZINO200-34	power adapter plate FPC
ZINO200-15	Optical flow lens	ZINO200-35	gyroscope FPC
ZINO200-16	TOF lenses	ZINO200-36	GPS
ZINO200-17	Fan		

## ZINO 2 Parts & Accessories

ITEM NUMBER	NAME OF SPARE PARTS
ZINO200-37	Screw
ZINO000-37	screwdriver
ZINO200-38	Battery
ZINO200-40	adapter (Europe)
ZINO200-46	remote HT018A
ZINO000-10	Micro USB cable
ZINO000-11	Type C cable
ZINO000-12	iphone cable
ZINO000-42	Micro USB cable
ZINO000-54	TF card 32G
ZINO000-55	Card reader
ZINO200-47	carry bag
ZINO200-48	gimbal
ZINO200-49	gimbal coaxial line
ZINO200-50	Antenna of remote
ZINO200-51	filter

## Limitation of Liability

Hubsan accepts no liability for damages, injuries or any legal responsibilities incurred directly or indirectly from the use of Hubsan products under the following conditions:

1. Damages, injuries or any legal responsibilities incurred when users are drunk, under the influence of drugs or anesthesia, dizzy, fatigued, nauseous and / or affected by other conditions both physical and mental that could impair sound judgment and / or personal ability.
2. Subjective misjudgment and / or intentional mis-operation of products.
3. Any and all mental damage, trauma, impairment, illness, compensation caused / solicited by accidents involving Hubsan products.
4. Product operation in no-fly zones (i.e. natural reserves).
5. Malfunctions or problems caused by modification, refit, replacement or use with non-Hubsan accessories / parts, failure to follow the guidance of the manual in assembly or operation.
6. Damages, injuries or any legal responsibilities caused by mechanical failures due to natural wear and tear (aircraft flight time clocking in 100 hours or above), corrosion, aging hardware, etc.
7. Continued flight after low voltage protection alarms are triggered.
8. Knowingly flying aircraft under abnormal conditions (such as when water, oil, soil, sand or other unknown material are inside the X4, the aircraft and / or transmitter are incompletely assembled, the main components have obvious faults, obvious defect or missing accessories, etc).
9. Flying in the following situations and / or environments: areas with magnetic interference (such as high voltage lines, power stations, broadcasting towers and mobile base stations), radio interference, government regulated no-fly zones, if the pilot loses sight of the X4, suffers from poor eyesight or is otherwise unsuited for operating Hubsan products.
10. Aircraft use in or exposure to bad weather, such as a rain, wind, snow, hail, lightning, tornadoes and hurricanes.
11. Products are involved in / exposed to collisions, fire, explosions, floods, tsunamis, manmade and / or natural structure collapses, ice, avalanches, debris, landslides, earthquakes, etc.

12. The acquisition, through use of Hubsan products (specifically but not limited to aircraft), of any data, audio, video that results in infringement of law and / or rights.
13. Misuse and / or alteration of batteries, product / aircraft circuits, hardware protections (including protection circuits), RC model and battery chargers.
14. Any malfunction of equipment or accessory, including memory cards, that results in the failure of an image or video to be recorded or not be recorded in a way that is machine readable.
15. Users who engage in reckless, unsafe flying (with or without sufficient training).
16. Non compliance with pre cautions, instructions, information and operation guidelines / methods given through official Hubsan website announcements, product quick start guides, user manuals, etc.
17. Other losses, damages, or injuries that are not within the boundaries of Hubsan responsibility.

RISK OF EXPLOSION IF BATTERY IS REPLACED BY AN INCORRECT TYPE.

DISPOSE OF USED BATTERIES ACCORDING TO THE LOCAL REGULATIONS.

HAZARDOUS MOVING PARTS KEEP FINGERS AND OTHER BODY PARTS AWAY.

Declaration of Conformity

Hereby, SHENZHEN HUBSAN TECHNOLOGY CO., LTD.,

declares this product is in compliance with the essential requirements and other relevant

provisions of Directive 2014 / 53 / EU. A copy of the original Declaration of Conformity can be obtained at the following address: 13th Floor, Bldg 1C, SHENZHEN NANSHAN SOFTWARE INDUSTRY BASE, Xuefu Road, Nanshan District, Shenzhen, China

This product bears the selective sorting symbol for waste electrical and electronic equipment (WEEE). This means that this product must be handled pursuant to European Directive 2012 / 19 / EU in order to be recycled or dismantled to minimize its impact on the environment.

For further information, please contact your local or regional authorities. Electronic products not included in the selective sorting process are potentially dangerous for the environment and human health due to the presence of hazardous substances.

## FCC INFORMATION

This equipment has been tested and found to comply with the limits for a Class B digital device, pursuant to Part 15 of the FCC Rules. These limits are designed to provide reasonable protection against harmful interference in a residential installation. This equipment generates, uses, and can radiate radio frequency energy and, if not installed and used in accordance with the instructions, may cause harmful interference to radio communications. However, there is no guarantee that interference will not occur in a particular installation. If this equipment does cause harmful interference to radio or television reception, which can be determined by turning the equipment off and on, the user is encouraged to try to correct the interference by one or more of the following measures:

- Reorient or relocate the receiving antenna.
- Increase the separation between the equipment and receiver.
- Connect the equipment into an outlet on a circuit different from that to which the receiver is connected.
- Consult the local dealer or an experienced radio / TV technician for help.

Changes or modifications not expressly approved by the party responsible for compliance could void the user's authority to operate the equipment.

This device complies with Part 15 of the FCC Rules. Operation is subject to the following two conditions: (1) this device may not cause harmful interference, and (2) this device must accept any interference received, including interference that may cause undesired operation.

This equipment complies with FCC radiation exposure limits set forth for an uncontrolled environment. This equipment should be installed and operated with a minimum distance of 20cm between the radiator & your body. This transmitter must not be co-located or operating in conjunction with any other antenna or transmitter.

### **Electrical and electronic equipment that are supplied with batteries (including internal batteries)**

#### **WEEE Directive & Product Disposal**

At the end of its serviceable life, this product should not be treated as household or general waste. It should be handed over to the applicable collection point for the recycling of electrical and electronic equipment, or returned to the supplier for disposal. Internal / Supplied Batteries.

This symbol on the battery indicates that the battery is to be collected separately. This battery is designed for separate collection at an appropriate collection point.











Please read the operating instructions carefully before use!

- Never leave units unattended when charging
- Unplug the charging cable immediately after charging
- Propellers may cause injury
- This product is not a toy
- Not suitable for children under 14 years of age



Flight Academy

Product name: ZINO 2

Product Standard Number: Q / HBS 001-2017

Vendor: Shenzhen Hubsan Technology Co., Ltd

Address: 13th Floor, Block C, Shenzhen Software Industrial Base,  
Xuefu Road, Nanshan District, Shenzhen, Guangdong Province, China

Email: [service@hubsan.com](mailto:service@hubsan.com)

[WWW.HUBSAN.COM](http://WWW.HUBSAN.COM)