



## Shenzhen Huaxia Testing Technology Co., Ltd

1F., Block A of Tongsheng Technology Building, Huahui Road, Dalang Street, Longhua District, Shenzhen, China

Telephone: +86-755-26648640  
Fax: +86-755-26648637  
Website: [www.cqa-cert.com](http://www.cqa-cert.com)

Report Template Version: V03  
Report Template Revision Date: Mar.1st, 2017

# FCC Test Report

**Report No. :** CQASZ171101574EW-01

**Applicant:** SHENZHEN HUBSAN TECHNOLOGY CO., LTD.

**Address of Applicant:** 13th Floor, Bldg 1C, Shenzhen Software Industry Base, Xuefu Road, Nanshan District, Shenzhen, China. 518054

**Manufacturer:** SHENZHEN HUBSAN TECHNOLOGY CO., LTD.

**Address of Manufacturer:** 13th Floor, Bldg 1C, Shenzhen Software Industry Base, Xuefu Road, Nanshan District, Shenzhen, China. 518054

**Factory:** Dongguan Tengsheng Industrial Co., Ltd.

**Address of Factory:** A22# Luyi Street, Tianxin Village, Tangxia Town, Dongguan, China.

**Equipment Under Test (EUT):**

**Product:** HT015 Transmitter

**Model No.:** HT015

**Brand Name:** HUBSAN

**FCC ID:** 2AN75-T015TX

**Standards:** 47 CFR Part 15, Subpart C

**Date of Test:** 2018-01-08 to 2018-01-10

**Date of Issue:** 2018-01-10

**Test Result :** **PASS\***

**Tested By:**

(Aaron Ma)

**Reviewed By:**

(Owen Zhou)

**Approved By:**

(Jack Ai)



\* In the configuration tested, the EUT complied with the standards specified above.

The test report is effective only with both signature and specialized stamp, The result(s) shown in this report refer only to the sample(s) tested. Without written approval of CQA, this report can't be reproduced except in full.

## 2 Version

### Revision History Of Report

Report No.	Version	Description	Issue Date
CQASZ171101574EW-01	Rev.01	Initial report	2018-01-10

### 3 Test Summary

Test Item	Test Requirement	Test method	Result
Antenna Requirement	47 CFR Part 15, Subpart C Section 15.203	ANSI C63.10 (2013)	PASS
AC Power Line Conducted Emission	47 CFR Part 15, Subpart C Section 15.207	ANSI C63.10 (2013)	N/A
Field Strength of the Fundamental Signal	47 CFR Part 15, Subpart C Section 15.249 (a)	ANSI C63.10 (2013)	PASS
Spurious Emissions	47 CFR Part 15, Subpart C Section 15.249 (a)/15.209	ANSI C63.10 (2013)	PASS
Restricted bands around fundamental frequency (Radiated Emission)	47 CFR Part 15, Subpart C Section 15.249(a)/15.205	ANSI C63.10 (2013)	PASS
20dB Occupied Bandwidth	47 CFR Part 15, Subpart C Section 15.215 (c)	ANSI C63.10 (2013)	PASS

N/A: Not applicable, This EUT is battery power

## 4 Contents

	Page
<b>1 COVER PAGE.....</b>	<b>1</b>
<b>2 VERSION .....</b>	<b>2</b>
<b>3 TEST SUMMARY .....</b>	<b>3</b>
<b>4 CONTENTS.....</b>	<b>4</b>
<b>5 GENERAL INFORMATION.....</b>	<b>5</b>
5.1 CLIENT INFORMATION.....	5
5.2 GENERAL DESCRIPTION OF EUT .....	5
5.3 TEST ENVIRONMENT AND MODE .....	7
5.4 DESCRIPTION OF SUPPORT UNITS.....	7
5.5 STATEMENT OF THE MEASUREMENT UNCERTAINTY .....	7
5.6 TEST LOCATION .....	8
5.7 TEST FACILITY.....	8
5.8 DEVIATION FROM STANDARDS.....	8
5.9 ABNORMALITIES FROM STANDARD CONDITIONS .....	8
5.10 OTHER INFORMATION REQUESTED BY THE CUSTOMER.....	8
5.11 EQUIPMENT LIST .....	9
<b>6 TEST RESULTS AND MEASUREMENT DATA.....</b>	<b>10</b>
6.1 ANTENNA REQUIREMENT .....	10
6.2 RADIATED EMISSION.....	11
6.3 20DB BANDWIDTH.....	19
<b>7 PHOTOGRAPHS.....</b>	<b>22</b>
7.1 RADIATED EMISSION TEST SETUP.....	22
7.2 EUT CONSTRUCTIONAL DETAILS .....	24
<b>END OF THE REPORT .....</b>	<b>29</b>

## 5 General Information

### 5.1 Client Information

Applicant:	SHENZHEN HUBSAN TECHNOLOGY CO., LTD.
Address of Applicant:	13th Floor, Bldg 1C, Shenzhen Software Industry Base, Xuefu Road, Nanshan District, Shenzhen, China. 518054
Manufacturer:	SHENZHEN HUBSAN TECHNOLOGY CO., LTD.
Address of Manufacturer:	13th Floor, Bldg 1C, Shenzhen Software Industry Base, Xuefu Road, Nanshan District, Shenzhen, China. 518054
Factory:	Dongguan Tengsheng Industrial Co., Ltd.
Address of Factory:	A22# Luyi Street, Tianxin Village, Tangxia Town, Dongguan, China.

### 5.2 General Description of EUT

Name:	HT015 Transmitter
Model No.:	HT015
Trade Mark :	HUBSAN
Hardware Version:	EA4000151-01
Software Version:	HT015-TX-V1.1.9
Frequency Range:	2410 MHz ~ 2465MHz
Modulation Type:	GFSK
Number of Channels:	12 (declared by the client)
Sample Type:	Portable production
Test Software of EUT:	RF test (manufacturer declare )
Antenna Type:	Integral antenna
Antenna Gain:	1.0dBi
Power Supply:	4 x AAA battery, DC6V

Operation Frequency each of channel							
Channel	Frequency	Channel	Frequency	Channel	Frequency	Channel	Frequency
/	/	4	2425MHz	8	2445MHz	12	2465MHz
1	2410MHz	5	2430MHz	9	2450MHz	/	/
2	2415MHz	6	2435MHz	10	2455MHz	/	/
3	2420MHz	7	2440MHz	11	2460MHz	/	/

Note:

In section 15.31(m), regards to the operating frequency range over 10 MHz, the Lowest frequency, the middle frequency, and the highest frequency of channel were selected to perform the test, and the selected channel see below:

Channel	Frequency
The Lowest channel(CH1)	2410MHz
The Middle channel(CH6)	2435MHz
The Highest channel(CH12)	2465MHz

### 5.3 Test Environment and Mode

Operating Environment:	
Temperature:	24.0 °C
Humidity:	52 % RH
Atmospheric Pressure:	1008 mbar
Test Mode:	Use test software (RF test) to set the lowest frequency, the middle frequency and the highest frequency keep transmitting of the EUT.

### 5.4 Description of Support Units

The EUT has been tested with associated equipment below.

Description	Manufacturer	Model No.	Remark	FCC certification
/	/	/	/	/

### 5.5 Statement of the measurement uncertainty

The data and results referenced in this document are true and accurate.

The reader is cautioned that there may be errors within the calibration limits of the equipment and facilities.

The measurement uncertainty was calculated for all measurements listed in this test report acc. to CISPR 16 - 4 „Specification for radio disturbance and immunity measuring apparatus and methods – Part 4: Uncertainty in EMC Measurements“ and is documented in the **Shenzhen Huaxia Testing Technology Co., Ltd** quality system acc. to DIN EN ISO/IEC 17025.

Furthermore, component and process variability of devices similar to that tested may result in additional deviation. The manufacturer has the sole responsibility of continued compliance of the device.

Hereafter the best measurement capability for **CQA** laboratory is reported:

Test	Range	Uncertainty	Notes
Radiated Emission	Below 1GHz	±5.12dB	(1)
Radiated Emission	Above 1GHz	±4.60dB	(1)
Conducted Disturbance	0.15~30MHz	±3.34dB	(1)

(1) This uncertainty represents an expanded uncertainty expressed at approximately the 95% confidence level using a coverage factor of k=2.

## 5.6 Test Location

All tests were performed at:

Shenzhen Huaxia Testing Technology Co., Ltd.,

1F., Block A of Tongsheng Technology Building, Huahui Road, Dalang Street, Longhua District, Shenzhen, China

## 5.7 Test Facility

The test facility is recognized, certified, or accredited by the following organizations:

- **CNAS (No. CNAS L5785)**

CNAS has accredited Shenzhen Huaxia Testing Technology Co., Ltd. Shenzhen Branch EMC Lab to ISO/IEC 17025:2005 General Requirements for the Competence of Testing and Calibration Laboratories (CNAS-CL01 Accreditation Criteria for the Competence of Testing and Calibration Laboratories) for the competence in the field of testing.

- **ISED Registration No.: 22984-1**

The 3m Semi-anechoic chamber of Shenzhen Huaxia Testing Technology Co., Ltd. has been registered by Certification and Engineering Bureau of Industry Canada for radio equipment testing

- **A2LA (Certificate No. 4742.01)**

Shenzhen Huaxia Testing Technology Co., Ltd., Shenzhen EMC Laboratory is accredited by the American Association for Laboratory Accreditation(A2LA). Certificate No. 4742.01.

- **FCC Registration No.: 522263**

Shenzhen Huaxia Testing Technology Co., Ltd., Shenzhen EMC Laboratory has been registered and fully described in a report filed with the (FCC) Federal Communications Commission. The acceptance letter from the FCC is maintained in our files. Registration No.:522263

## 5.8 Deviation from Standards

None.

## 5.9 Abnormalities from Standard Conditions

None.

## 5.10 Other Information Requested by the Customer

None.



## 5.11 Equipment List

Item	Test Equipment	Manufacturer	Model No.	Instrument No.	Calibration Due Date
1	EMI Test Receiver	R&S	ESR7	CQA-005	2018/9/24
2	Spectrum analyzer	R&S	FSU26	CQA-038	2018/9/24
3	Preamplifier	MITEQ	AFS4-00010300-18-10P-4	CQA-035	2018/9/24
4	Preamplifier	MITEQ	AMF-6D-02001800-29-20P	CQA-036	2018/9/24
5	Loop antenna	Schwarzbeck	FMZB1516	CQA-087	2018/3/21
6	Bilog Antenna	R&S	HL562	CQA-011	2018/9/24
7	Horn Antenna	R&S	HF906	CQA-012	2018/9/24
8	Horn Antenna	R&S	BBHA 9170	CQA-088	2018/9/24
9	Coax cable (9KHz~40GHz)	CQA	RE-low-01	CQA-077	2018/9/24
10	Coax cable (9KHz~40GHz)	CQA	RE-high-02	CQA-078	2018/9/24
11	Antenna Connector	CQA	RFC-01	CQA-080	2018/9/24
12	RF cable(9KHz~40GHz)	CQA	RF-01	CQA-079	2018/9/24

Note:

The temporary antenna connector is soldered on the PCB board in order to perform conducted tests and this temporary antenna connector is listed in the equipment list.

## 6 Test results and Measurement Data

### 6.1 Antenna Requirement

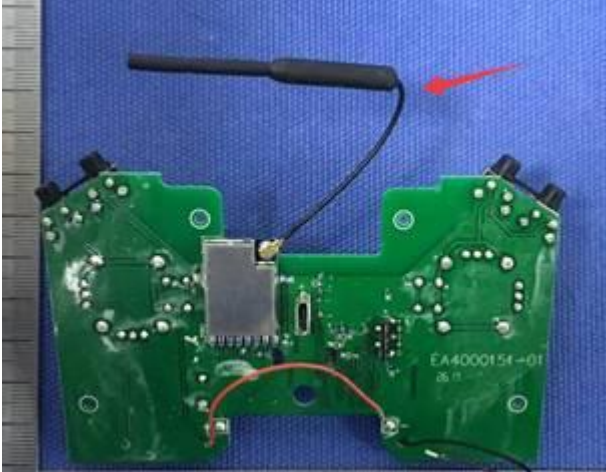
<b>Standard requirement:</b>	47 CFR Part 15C Section 15.203
<p>15.203 requirement:          An intentional radiator shall be designed to ensure that no antenna other than that furnished by the responsible party shall be used with the device. The use of a permanently attached antenna or of an antenna that uses a unique coupling to the intentional radiator, the manufacturer may design the unit so that a broken antenna can be replaced by the user, but the use of a standard antenna jack or electrical connector is prohibited.</p>	
<b>EUT Antenna:</b>	
<p>The antenna is integrated on the main PCB and no consideration of replacement. The best case gain of the antenna is 1.0dBi.</p>	

## 6.2 Radiated Emission

Test Requirement:	47 CFR Part 15C Section 15.249 and 15.209 and 15.205				
Test Method:	ANSI C63.10: 2013				
Test Site:	Measurement Distance: 3m (Semi-Anechoic Chamber)				
Receiver Setup:	Frequency	Detector	RBW	VBW	Remark
	0.009MHz-0.090MHz	Peak	10kHz	30KHz	Peak
	0.009MHz-0.090MHz	Average	10kHz	30KHz	Average
	0.090MHz-0.110MHz	Quasi-peak	10kHz	30KHz	Quasi-peak
	0.110MHz-0.490MHz	Peak	10kHz	30KHz	Peak
	0.110MHz-0.490MHz	Average	10kHz	30KHz	Average
	0.490MHz -30MHz	Quasi-peak	10kHz	30kHz	Quasi-peak
	30MHz-1GHz	Quasi-peak	100 kHz	300KHz	Quasi-peak
	Above 1GHz	Peak	1MHz	3MHz	Peak
		Peak	1MHz	10Hz	Average
Note: For fundamental frequency, RBW=5MHz, VBW=5MHz, Peak detector is for PK value, RMS detector is for Average value.					
Limit: (Spurious Emissions and band edge)	Frequency	Field strength (microvolt/meter )	Limit (dBuV/m )	Remark	Measurement distance (m)
	0.009MHz-0.490MHz	2400/F(kHz)	-	-	300
	0.490MHz-1.705MHz	24000/F(kHz)	-	-	30
	1.705MHz-30MHz	30	-	-	30
	30MHz-88MHz	100	40.0	Quasi-peak	3
	88MHz-216MHz	150	43.5	Quasi-peak	3
	216MHz-960MHz	200	46.0	Quasi-peak	3
	960MHz-1GHz	500	54.0	Quasi-peak	3
	Above 1GHz	500	54.0	Average	3
	Note: 1) 15.35(b), Unless otherwise specified, the limit on peak radio frequency emissions is 20dB above the maximum permitted average emission limit applicable to the equipment under test. This peak limit applies to the total peak emission level radiated by the device. 2) Emissions radiated outside of the specified frequency bands, except for harmonics, shall be attenuated by at least 50 dB below the level of the fundamental or to the general radiated emission limits in Section 15.209, whichever is the lesser attenuation.				
Limit: (Field strength of the fundamental signal)	Frequency	Limit (dBuV/m @3m)		Remark	
	2400MHz-2483.5MHz	94.0		Average Value	
		114.0		Peak Value	

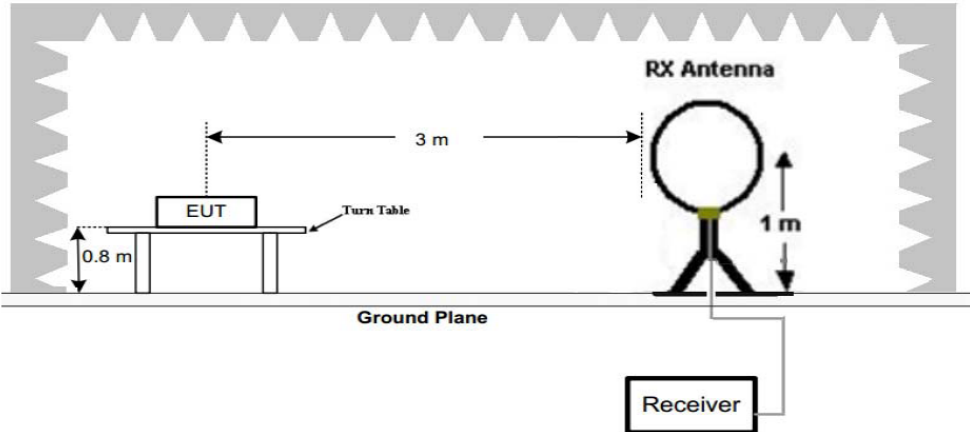
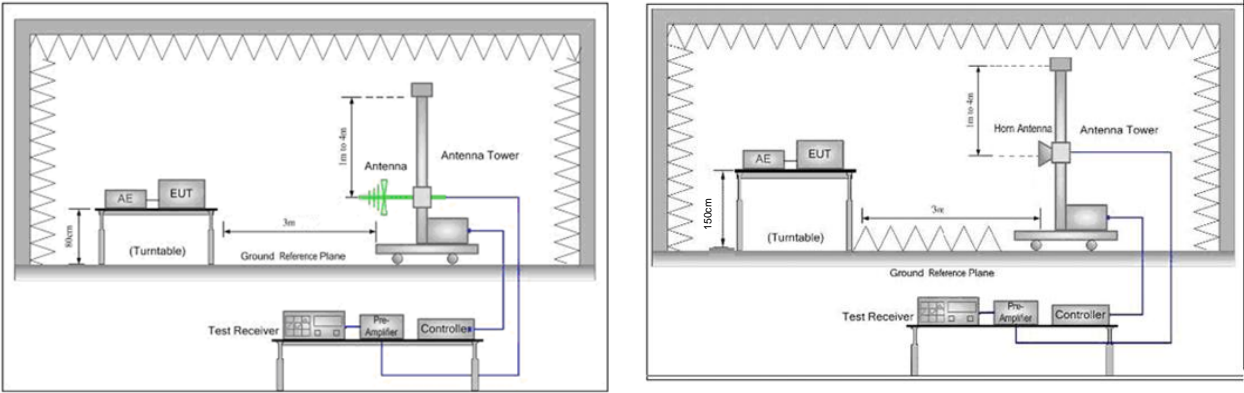
<p>Test Setup:</p>		
		
<p>Figure 1. Below 30MHz</p>		
		
<p>Figure 2. 30MHz to 1GHz</p>		<p>Figure 3. Above 1 GHz</p>
<p>Test Procedure:</p>	<ol style="list-style-type: none"> <li>a. 1) Below 1G: The EUT was placed on the top of a rotating table 0.8 meters above the ground at a 3 meter semi-anechoic chamber. The table was rotated 360 degrees to determine the position of the highest radiation.</li> <li>2) Above 1G: The EUT was placed on the top of a rotating table 1.5 meters above the ground at a 3 meter semi-anechoic chamber. The table was rotated 360 degrees to determine the position of the highest radiation.</li> </ol> <p>Note: For the radiated emission test above 1GHz:  Place the measurement antenna away from each area of the EUT determined to be a source of emissions at the specified measurement distance, while keeping the measurement antenna aimed at the source of emissions at each frequency of significant emissions, with polarization oriented for maximum response. The measurement antenna may have to be higher or lower than the EUT, depending on the radiation pattern of the emission and staying aimed at the emission source for receiving the maximum signal. The final measurement antenna elevation shall be that which maximizes the emissions. The measurement antenna elevation for maximum emissions shall be restricted to a range of heights of from 1 m to 4 m above the ground or reference ground plane.</p> <ol style="list-style-type: none"> <li>b. The EUT was set 3 meters away from the interference-receiving antenna, which was mounted on the top of a variable-height antenna tower.</li> <li>c. The antenna height is varied from one meter to four meters above the ground to determine the maximum value of the field strength. Both horizontal and vertical polarizations of the antenna are set to make the measurement.</li> <li>d. For each suspected emission, the EUT was arranged to its worst case and then the antenna was tuned to heights from 1 meter to 4 meters (for the test frequency of below 30MHz, the antenna was tuned to heights 1 meter) and the rotatable table</li> </ol>	

	<p>was turned from 0 degrees to 360 degrees to find the maximum reading.</p> <p>e. The test-receiver system was set to Peak Detect Function and Specified Bandwidth with Maximum Hold Mode.</p> <p>f. If the emission level of the EUT in peak mode was 10dB lower than the limit specified, then testing could be stopped and the peak values of the EUT would be reported. Otherwise the emissions that did not have 10dB margin would be re-tested one by one using peak, quasi-peak or average method as specified and then reported in a data sheet.</p> <p>g. Test the EUT in the lowest channel,the middle channel,the Highest channel</p> <p>h. The radiation measurements are performed in X, Y, Z axis positioning for Transmitting mode,And found the X axis positioning which it is worse case.</p> <p>i. Repeat above procedures until all frequencies measured was complete.</p>
Instruments Used:	Refer to section 5.11 for details
Exploratory Test Mode:	Transmitting mode
Final Test Mode:	<p>Pretest the EUT at Transmitting mode, For below 1GHz part, through pre-scan, the worst case is the lowest channel.</p> <p>Only the worst case is recorded in the report.</p>
Test Voltage:	DC6V
Test Results:	Pass

Measurement Data

30MHz~1GHz		
Test mode:	Transmitting (lowest channel)	Vertical

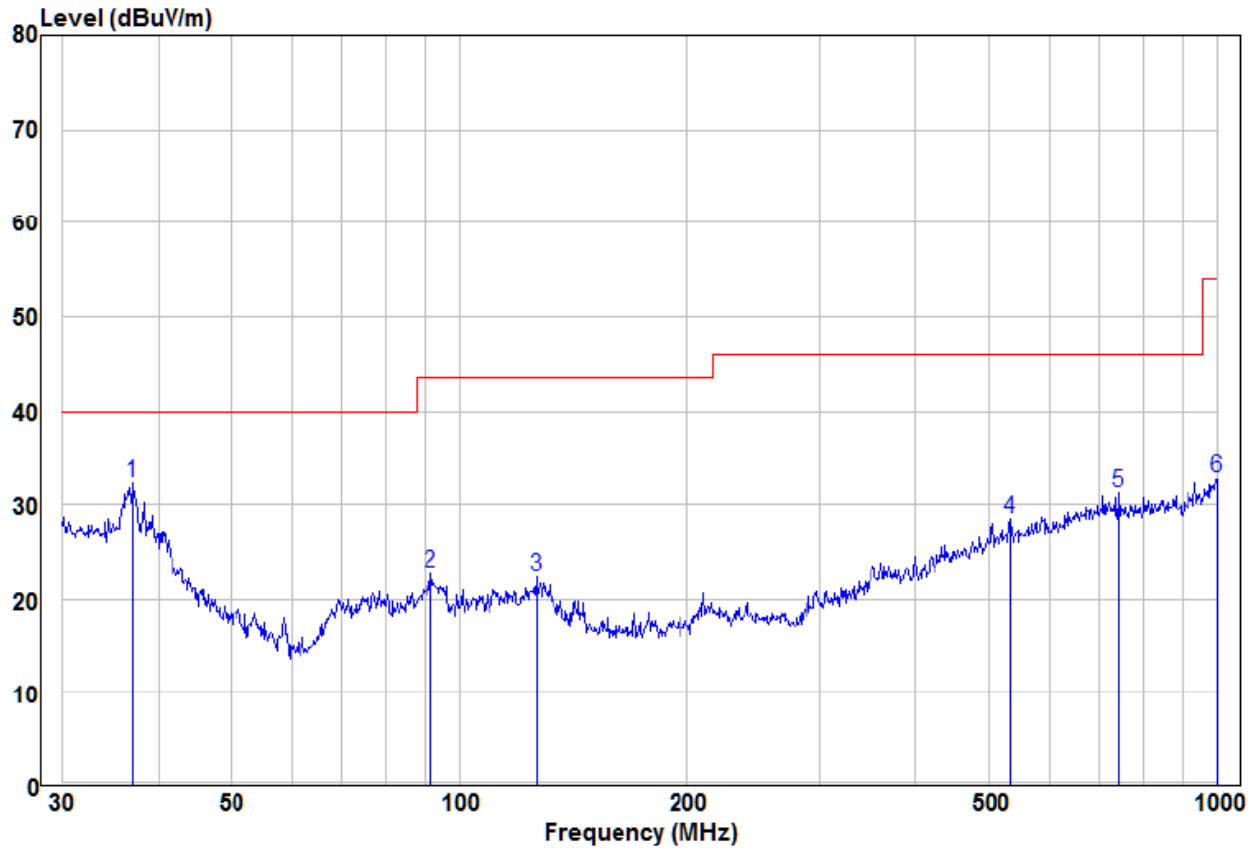

	Read		Limit	Over					
	Freq	Level	Factor	Level	Line	Limit	Remark	Pol/Phase	
	MHz	dBuV	dB/m	dBuV/m	dBuV/m	dB			
1	pp	37.15	15.25	16.99	32.24	40.00	-7.76	Peak	VERTICAL
2		91.82	12.49	10.19	22.68	43.50	-20.82	Peak	VERTICAL
3		126.33	11.97	10.33	22.30	43.50	-21.20	Peak	VERTICAL
4		535.71	11.11	17.37	28.48	46.00	-17.52	Peak	VERTICAL
5		742.26	11.14	20.14	31.28	46.00	-14.72	Peak	VERTICAL
6		1000.00	9.79	22.94	32.73	54.00	-21.27	Peak	VERTICAL

Test mode:	Transmitting (lowest channel)	Horizontal
------------	-------------------------------	------------

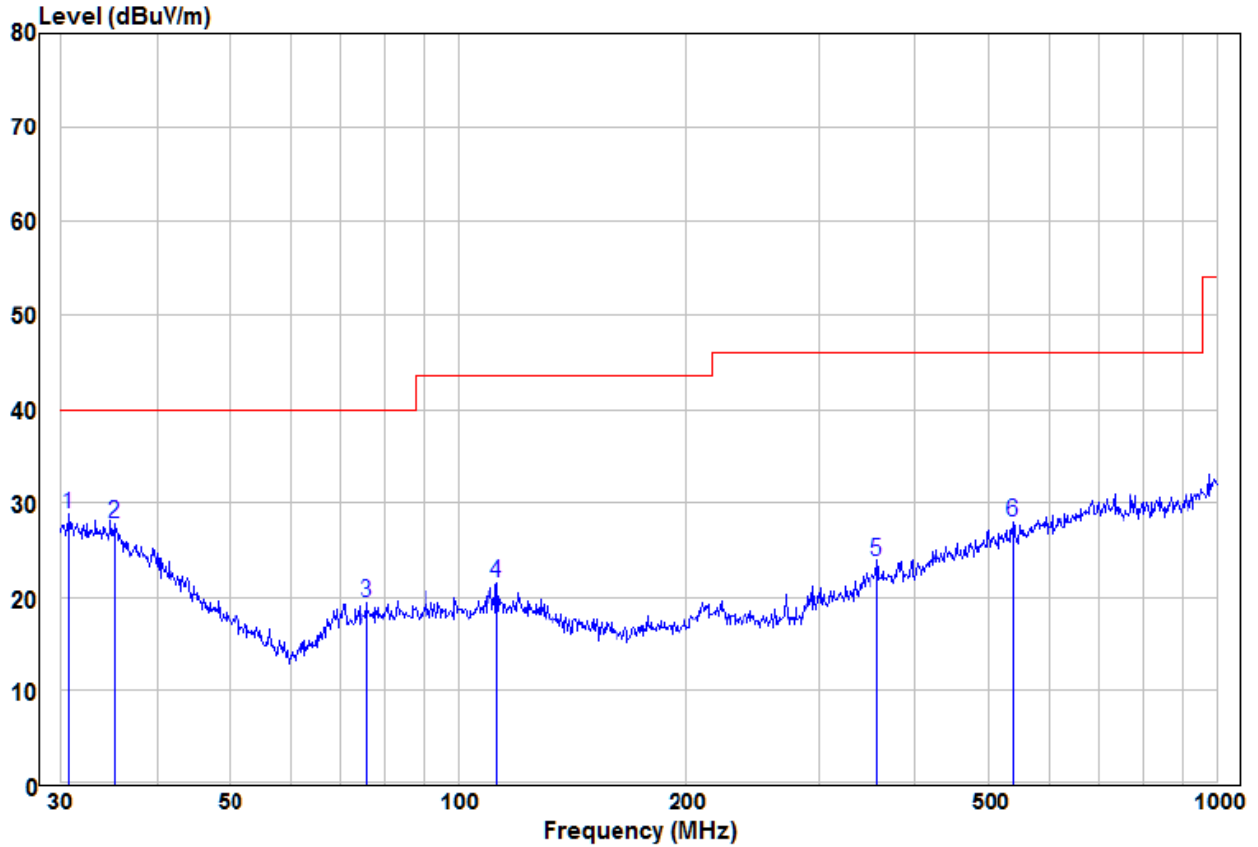

	Read	Limit	Over						
	Freq	Level	Factor	Level	Line	Limit	Remark	Pol/Phase	
	MHz	dBuV	dB/m	dBuV/m	dBuV/m	dB			
1	pp	30.75	9.96	18.85	28.81	40.00	-11.19	Peak	HORIZONTAL
2		35.25	9.46	18.32	27.78	40.00	-12.22	Peak	HORIZONTAL
3		75.71	10.38	9.10	19.48	40.00	-20.52	Peak	HORIZONTAL
4		112.52	11.08	10.38	21.46	43.50	-22.04	Peak	HORIZONTAL
5		356.68	10.26	13.66	23.92	46.00	-22.08	Peak	HORIZONTAL
6		539.48	10.62	17.40	28.02	46.00	-17.98	Peak	HORIZONTAL

Above 1GHz							
Test mode:		Transmitting		Test channel:		Lowest	
Frequency	Meter Reading	Factor	Emission Level	Limits	Over	Detector Type	Ant. Pol.
(MHz)	(dB $\mu$ V)	(dB)	(dB $\mu$ V/m)	(dB $\mu$ V/m)	(dB)		H/V
2390	66.66	-9.2	57.46	74	-16.54	Peak	H
2390	38.84	-9.2	29.64	54	-24.36	AVG	H
2400	68.51	-9.39	59.12	74	-14.88	Peak	H
2400	48.83	-9.39	39.44	54	-14.56	AVG	H
2410	105.46	-9.33	96.13	114	-17.87	peak	H
2410	98.79	-9.33	89.46	94	-4.54	AVG	H
4820	53.54	-4.28	49.26	74	-24.74	peak	H
4820	42.57	-4.28	38.29	54	-15.71	AVG	H
7230	50.13	1.13	51.26	74	-22.74	peak	H
7230	36.78	1.13	37.91	54	-16.09	AVG	H
2390	61.46	-9.2	52.26	74	-21.74	peak	V
2390	38.97	-9.2	29.77	54	-24.23	AVG	V
2400	61.4	-9.39	52.01	74	-21.99	peak	V
2400	38.6	-9.39	29.21	54	-24.79	AVG	V
<b>2410</b>	<b>107.83</b>	<b>-9.33</b>	<b>98.5</b>	<b>114</b>	<b>-15.5</b>	<b>peak</b>	<b>V</b>
2410	99.16	-9.34	89.82	94	-4.18	AVG	V
4820	53.49	-4.28	49.21	74	-24.79	peak	V
4820	41.89	-4.28	37.61	54	-16.39	AVG	V
7230	49.97	1.13	51.1	74	-22.9	peak	V
7230	37.69	1.13	38.82	54	-15.18	AVG	V



Test mode:		Transmitting		Test channel:		Middle	
Frequency	Meter Reading	Factor	Emission Level	Limits	Over	Detector Type	Ant. Pol.
(MHz)	(dB $\mu$ V)	(dB)	(dB $\mu$ V/m)	(dB $\mu$ V/m)	(dB)		H/V
2435	103.48	-9.37	94.11	114	-19.89	peak	H
2435	96.41	-9.37	87.04	94	-6.96	AVG	H
4870	55.78	-4.14	51.64	74	-22.36	peak	H
4870	38.49	-4.14	34.35	54	-19.65	AVG	H
7305	51.09	0.56	51.65	74	-22.35	peak	H
7305	37.67	0.56	38.23	54	-15.77	AVG	H
2435	105.64	-9.36	96.28	114	-17.72	peak	V
2435	97.15	-9.36	87.79	94	-6.21	AVG	V
4870	55.42	-4.14	51.28	74	-22.72	peak	V
4870	39.16	-4.14	35.02	54	-18.98	AVG	V
7305	50.94	0.56	51.5	74	-22.5	peak	V
7305	38.43	0.56	38.99	54	-15.01	AVG	V

Test mode:		Transmitting		Test channel:		Highest	
Frequency	Meter Reading	Factor	Emission Level	Limits	Over	Detector Type	Ant. Pol.
(MHz)	(dB $\mu$ V)	(dB)	(dB $\mu$ V/m)	(dB $\mu$ V/m)	(dB)		H/V
2465	104.16	-9.23	94.93	114	-19.07	peak	H
2465	96.78	-9.23	87.55	94	-6.45	AVG	H
2483.5	59.87	-9.29	50.58	74	-23.42	Peak	H
2483.5	40.4	-9.29	31.11	54	-22.89	AVG	H
4930	54.18	-4.03	50.15	74	-23.85	peak	H
4930	39.45	-4.03	35.42	54	-18.58	AVG	H
7395	50.49	1.68	52.17	74	-21.83	peak	H
7395	37.9	1.68	39.58	54	-14.42	AVG	H
2465	105.99	-9.23	96.76	114	-17.24	peak	V
2465	97.94	-9.23	88.71	94	-5.29	AVG	V
2483.5	55.64	-9.29	46.35	74	-27.65	peak	V
2483.5	39.49	-9.29	30.2	54	-23.8	AVG	V
4930	53.79	-4.03	49.76	74	-24.24	peak	V
4930	40.58	-4.03	36.55	54	-17.45	AVG	V
7395	51.26	1.68	52.94	74	-21.06	peak	V
7395	37.55	1.68	39.23	54	-14.77	AVG	V

Remark:

- 1) The field strength is calculated by adding the Antenna Factor, Cable Factor & Preamplifier. The basic equation with a sample calculation is as follows:  
Final Test Level = Receiver Reading + Antenna Factor + Cable Factor – Preamplifier Factor
- 2) Scan from 9kHz to 25GHz, The disturbance above 10GHz and below 30MHz was very low, and the above harmonics were the highest point could be found when testing, so only the above harmonics had been displayed. The amplitude of spurious emissions from the radiator which are attenuated more than 20dB below the limit need not be reported .

### 6.3 20dB Bandwidth

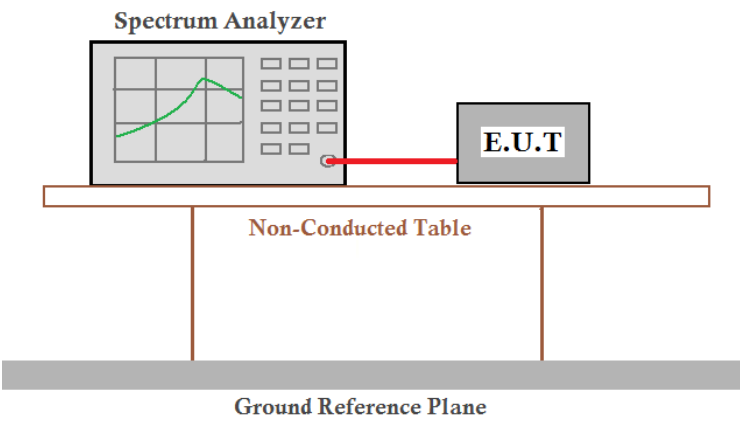
Test Requirement:	47 CFR Part 15C Section 15.215
Test Method:	ANSI C63.10:2013
Test Setup:	 <p>The diagram illustrates the test setup. A Spectrum Analyzer is connected to an E.U.T. (Equipment Under Test) via a red cable. Both are placed on a Non-Conducted Table, which is supported by two vertical legs. Below the table is a Ground Reference Plane.</p>
Instruments Used:	Refer to section 5.11 for details
Test Mode:	Transmitting with GFSK modulation.
Limit:	N/A
Test Results:	Pass

#### Measurement Data

Test channel	20dB bandwidth (MHz)	Results
Lowest	0.921	Pass
Middle	0.913	Pass
Highest	0.913	Pass

Test plot as follows:

Test channel: **Lowest**

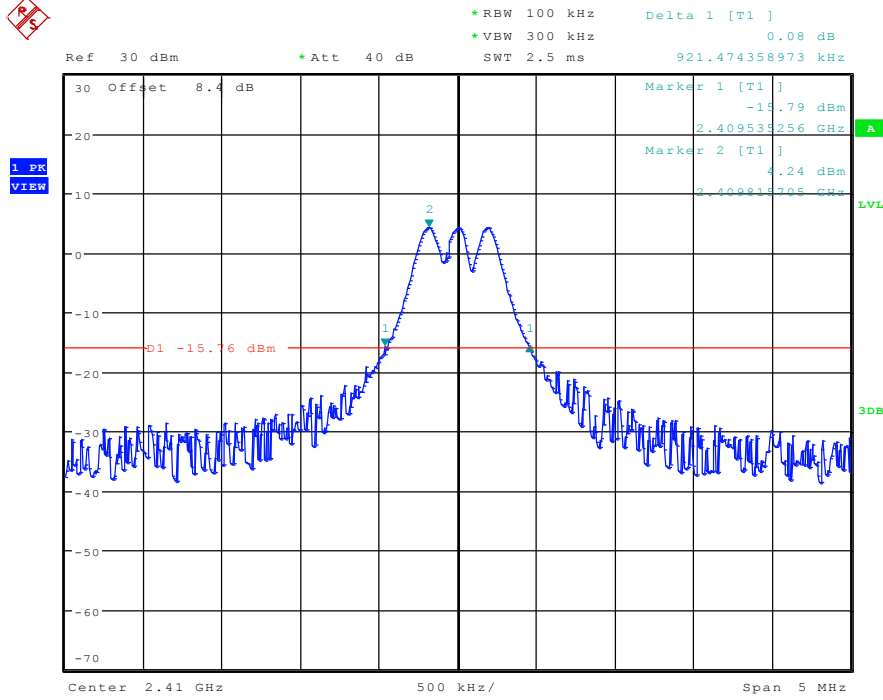

Test channel: **Middle**

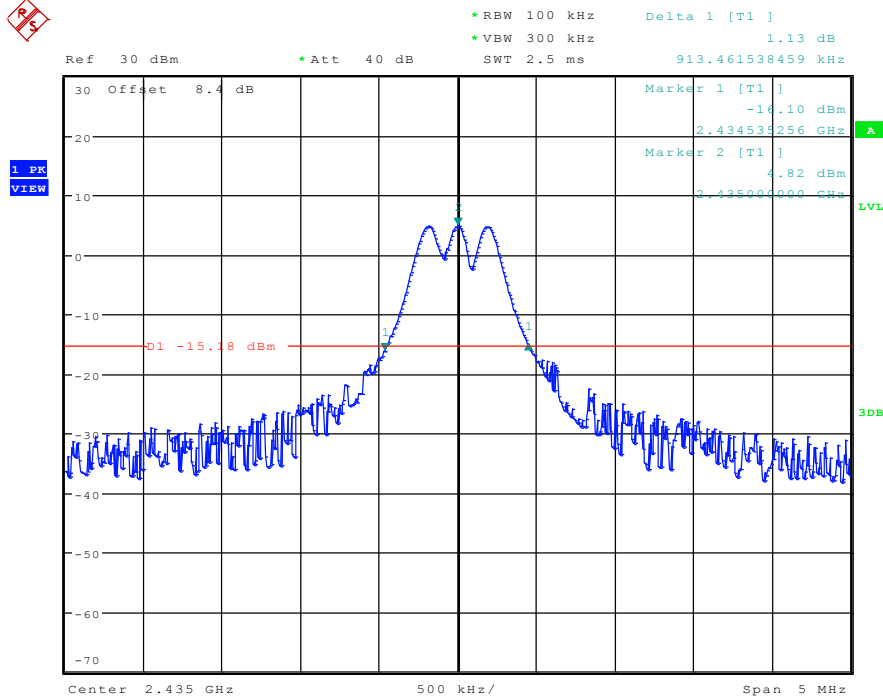

Test channel: Highest

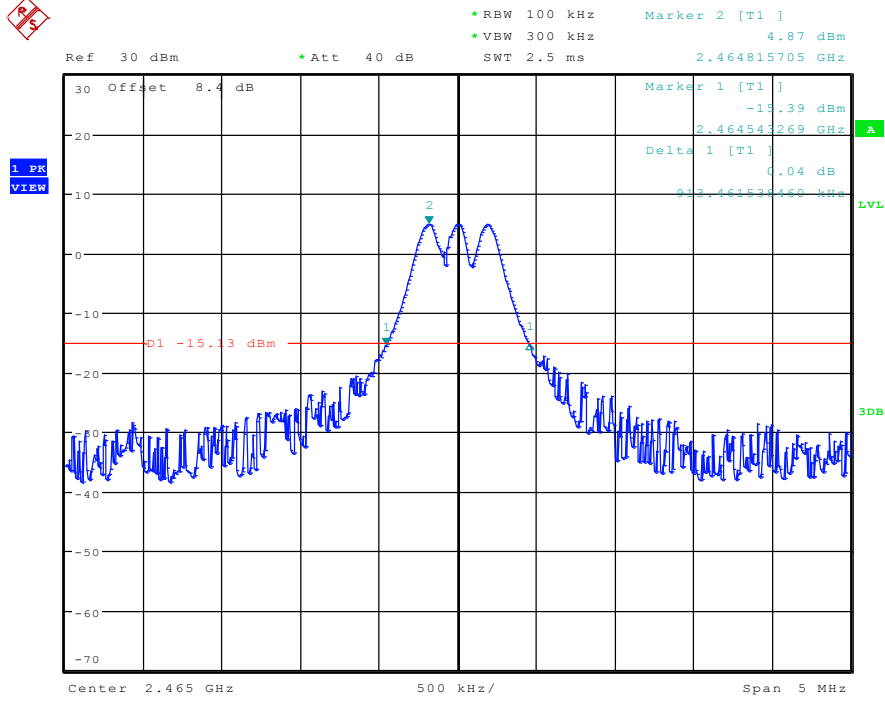

## 7 Photographs

### 7.1 Radiated Emission Test Setup

9KHz~30MHz

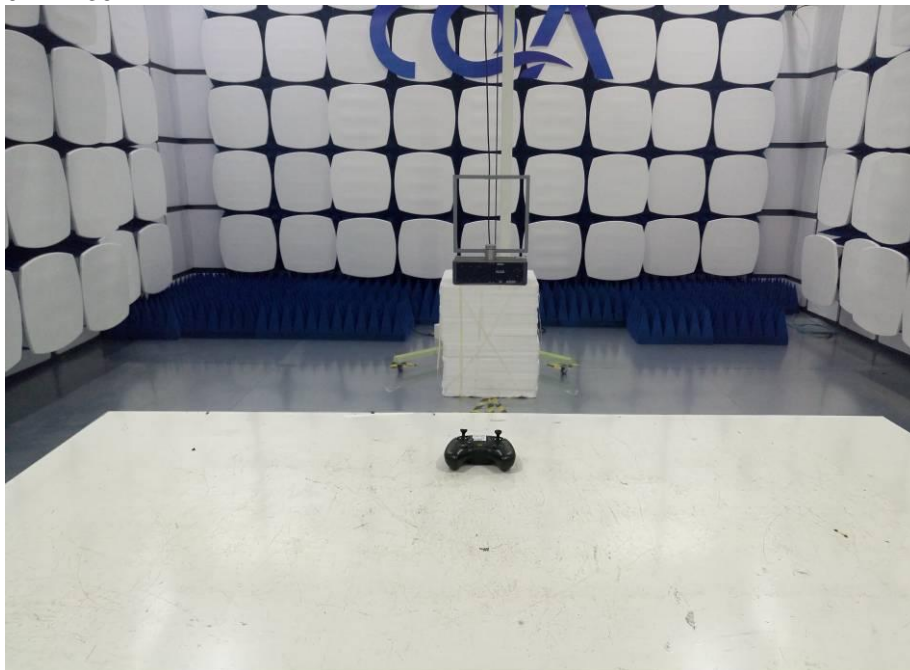

30MHz~1GHz:

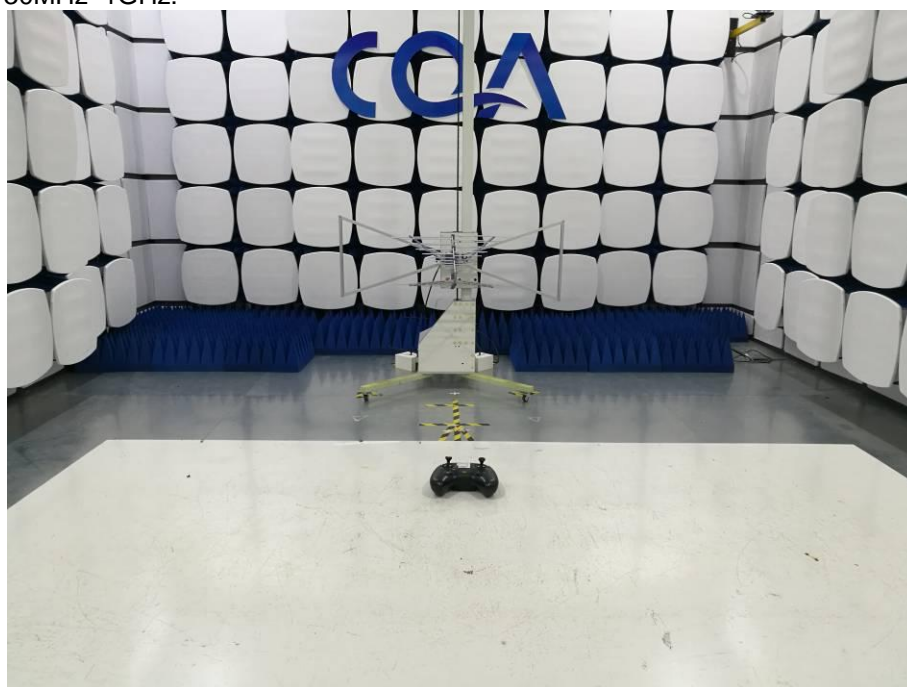

Above 1GHz:

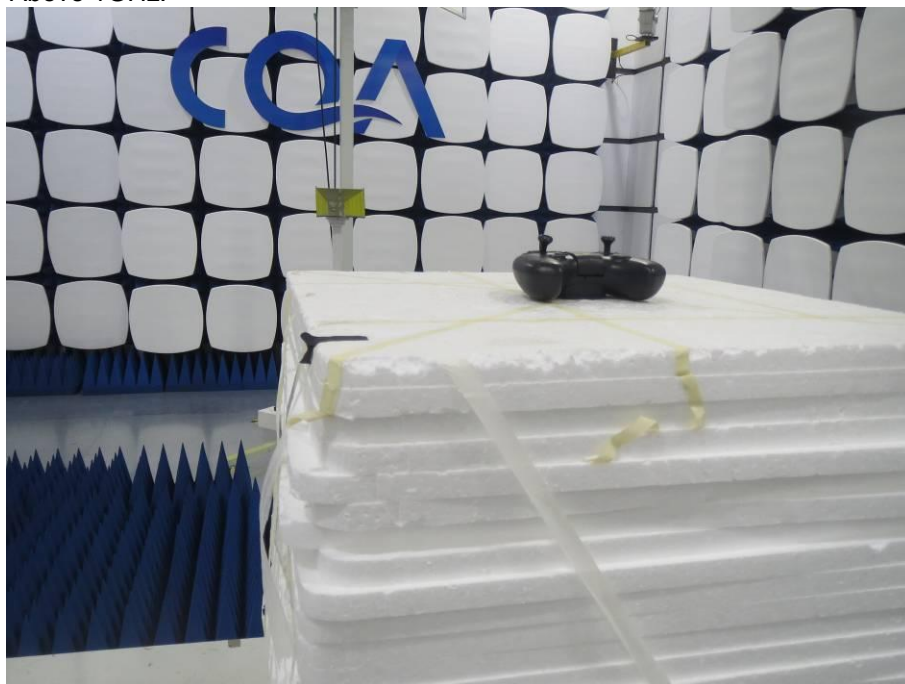

## 7.2 EUT Constructional Details











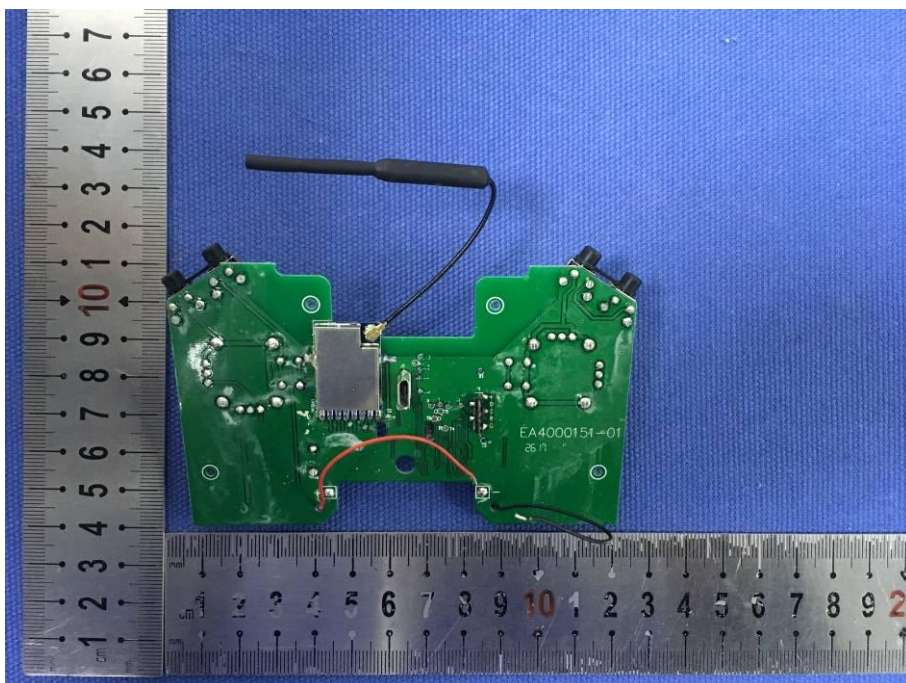

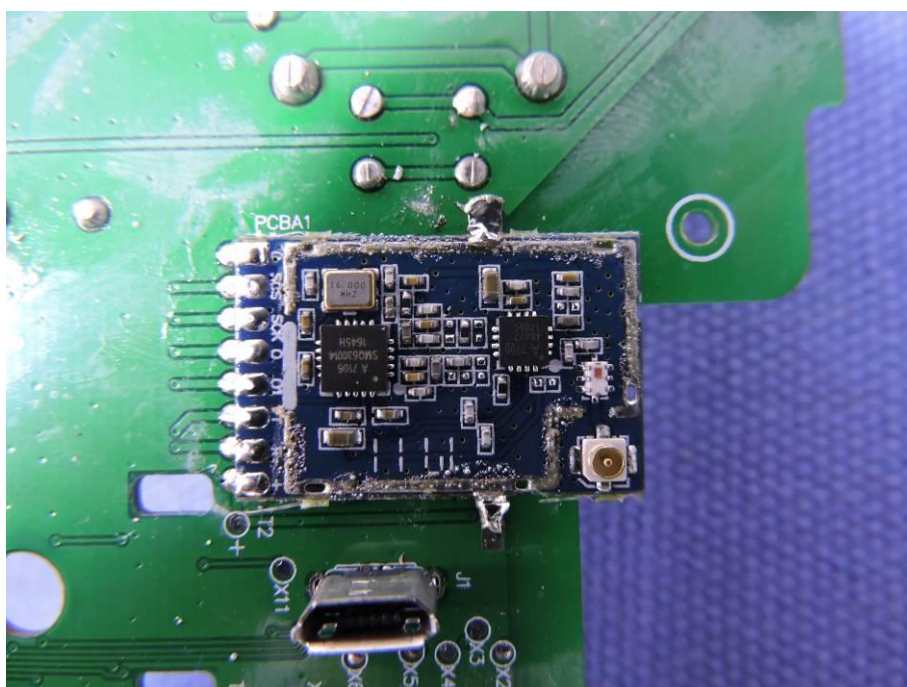
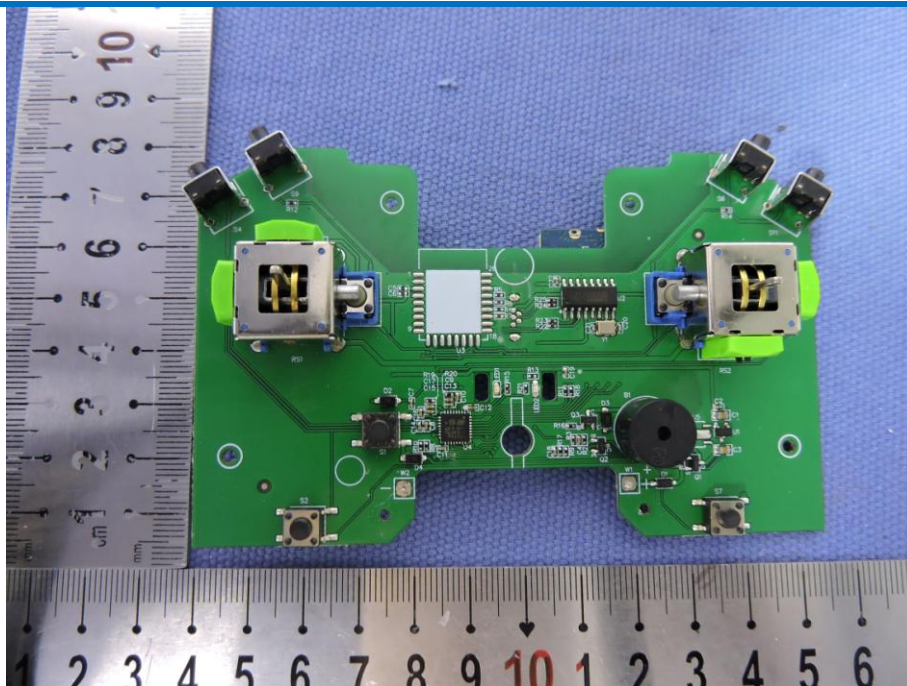

**END OF THE REPORT**