

H501A X4 AIR PRO

《 H501A Quick Start Guide 》

Version 2.3

Disclaimer & Warning

All users must read product operating instructions as well as this liability disclaimer before using any Hubsan product. By using a Hubsan product(s), users are accepting the terms and conditions of Hubsan liability and operational guidelines. This product is not suitable for minors under 14 years of age. While operating a Hubsan product(s), users also accept all liability and responsibility for their own behavior, actions as well as any consequences resulting thereof while using a Hubsan product(s). These products may only be used for purposes that are proper and in accordance with local regulations, terms and any applicable policies/guidelines Hubsan may make available. Users agree to comply with these terms and conditions, along with any and all relevant policies/guidelines set forth by Hubsan.

Instructions

Some product flight functions are restricted in certain areas. Once you use this product, you are deemed to have read carefully the relevant ICAO regulations, local airspace control provisions and the regulations governing UAVs. You assume all liability for any non-compliance with the foregoing, are responsible for the consequences for your actions as well as any indirect and/or direct liability that arises as a result of these limitations.

Flight environment requirements

- (1) Select an open environment devoid of high rise buildings and tall obstructions (such as trees and poles). Near buildings and obstacles, flight control signals and GPS signals can be severely weakened; GPS functions such as GPS mode and Return to Home may not function properly.
- (2) Do not fly in bad weather conditions (such as in wind, rain or fog).
- (3) Fly the drone in ambient temperatures of 0-40 °C.
- (4) When flying, please stay away from obstructions, crowds, high voltage lines, trees, water, etc.
- (5) To avoid remote control signal interference, do not fly in complex electromagnetic environments (such as venues with radio stations, power plants and towers).
- (6) The aircraft cannot be used in or near the Arctic circle or Antarctica.
- (7) Do not fly in no-fly zones.
- (8) Do not operate the aircraft near high pressure lines, airports or areas with severe magnetic interference.

Downloading the APP

Before flying with the H501A, users must download the X-Hubsan APP.

Download the APP for free by scanning the below code or by downloading it via the App Store (iOS) and Google Play (Android).



Scan and download

There are two most commonly used joystick modes: Mode 1 (Japanese hand) and Mode 2 (American hand). This manual will introduce flight operations in Mode 2.

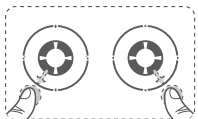

Arming/disarming motors

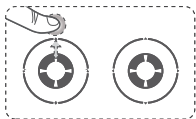

Taking off
(Mode 2, American hand)

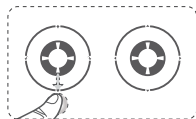

Landing
(Mode 2, American hand)

The first flight configuration: Aircraft+mobile device

Step 1

Connect the aircraft to its battery and power it on. Go to your mobile device's WIFI settings and select the aircraft's WIFI signal. (HUBSAN_H501A_XXXXXX)

Password: 12345678

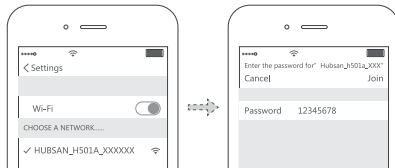

Step 2

Compass calibration: Please follow the app's prompting to calibrate.

Step 3

Takeoff: (two options)

- 1) Manual takeoff (with the virtual joysticks): To start/arm the motors, please be sure that the joystick setting is activated. Simultaneously pull both joysticks diagonally down-out as shown in the figures below. Slowly push the throttle stick up; the aircraft will ascend and takeoff.
- 2) Automatic takeoff: Tap the Auto Takeoff key. The aircraft will take off and hover at a height of around 2 meters. Note that the Auto Takeoff key will turn into an Auto Land key after the aircraft begins to fly.



Step 4

Landing: (four options)

- 1) Slowly push down the throttle stick until the copter has completed its descent to the ground. Hold the throttle in its lowest position downwards for 5 seconds to fully disarm the motors.
- 2) Slowly push down the throttle stick until the copter has completed its descent to the ground. Disarm the motors by simultaneously pulling both sticks diagonally down-out. When the motors have completely stopped, release the joysticks.
- 3) Select the Auto Land option on the screen and the aircraft will slowly descend in place to land.
- 4) Select the Automatic return option on the screen and the aircraft will return either to its takeoff point or to the mobile device.



The second flight configuration: Aircraft + mobile device + HT005 Relay

Step 1



Power on the HT005. Enter your mobile device's WIFI settings and connect to the HT005's WIFI signal (Hubsan_HT005_XXXXXX).

Step 2



After successfully pairing the HT005, run X-Hubsan APP. Enter the "Setting" interface and tap the "Relay" tab. Select "WIFI" on the "Transmitter connection" tab.

Step 3

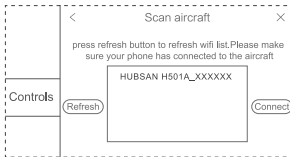

Refresh the WIFI list and select the WIFI signal of the aircraft you are using (i.e. HUBSAN-H501A-XXXX). Tap the WIFI signal in question and allow the relay and aircraft to connect.

To minimize the chances of losing control, go to the Settings menu (select the cog icon on the upper right hand corner). Then, select "Other" and "Bind aircraft to current device" to make sure all devices are properly bound/paired.

The third flight configuration: Aircraft + H906A Transmitter

Step 1

Binding the transmitter and aircraft

- 1) Hold the "Enter" key and power on the transmitter until "System Initialize" appears on the LCD screen.
- 2) Release the Enter key when the screen changes to display "Bind to Plane".
- 3) Power on the quad and place it very close to the transmitter. After a few seconds, the transmitter should then beep, indicating that binding has been successful.
- 4) If this does not happen and the aircraft's LEDs begin to rotate clockwise, the binding is unsuccessful. Please power off the quad and repeat the above steps.

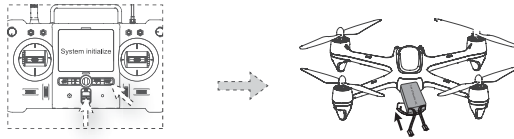

Once the aircraft and transmitter are bound, there will be no need to do so for subsequent flights. Another binding is necessary only should you decide to pair the aircraft with other devices.

Step 2

Compass calibration

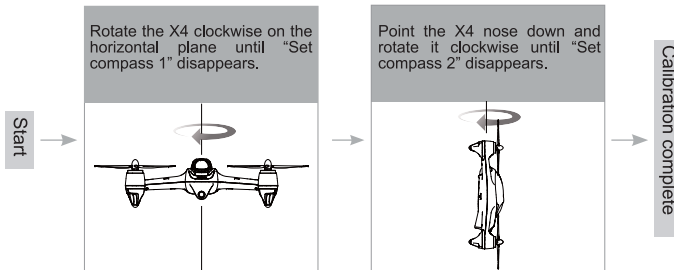

Step 3

Takeoff

Simultaneously pull the transmitter joysticks diagonally down-out to arm the motors. Smoothly and slowly pull the left joystick (throttle) upwards to take off.

Landing

Slowly and gently pull the throttle joystick down until the copter has completed its descent on the ground. Simultaneously pull the transmitter joysticks diagonally down-out to disarm the motors. After all motors have come to a complete stop, release the joysticks.



- High speed propellers are very dangerous. Please keep the aircraft away from people, animate and inanimate objects.
- Keep the aircraft under control at all times while the motors are still running.
- Do not disarm during flight. The motors will stop in midair, causing the aircraft to fall and other such hazards. Only disarm during flight in the case of emergencies.

The fourth flight configuration: Aircraft + H901A Transmitter

Step 1

Binding procedure:

1) Hold the Photo key and power on the transmitter until "System Initialize" appears on the LCD screen.

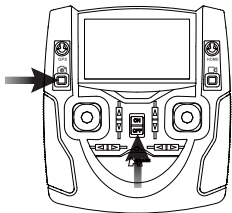

2) Release the Photo key when the screen changes to display "Bind to Plane". Power on the quad and place it very close to the transmitter. After a few seconds, the transmitter should then beep, indicating that binding has been successful.

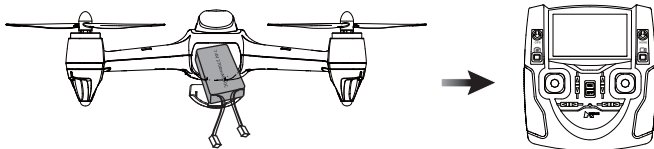

3) If this does not happen and the aircraft's LEDs begin to rotate clockwise, the binding is unsuccessful. Please power off the quad and repeat the above steps.

Step 2

Compass Calibration

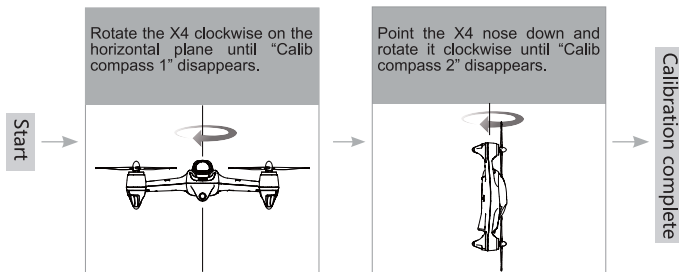

- Do not calibrate the compass in areas with strong magnetic interference.

Step 3

Takeoff

Simultaneously pull the transmitter joysticks diagonally down-out to arm the motors . Smoothly and slowly pull the left joystick (throttle) upwards to take off.

Landing

Slowly and gently pull the throttle joystick down until the copter has completed its descent on the ground. Simultaneously pull the transmitter joysticks diagonally down-out to disarm the motors. After all motors have come to a complete stop, release the joysticks.

The fifth flight configuration: Aircraft + HT011A Transmitter + mobile device

Step 1

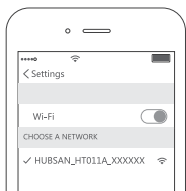

Power on the HT011A. Go to your mobile device's WIFI settings and select the HT011A's WIFI signal (Hubsan_HT011A_XXXXXX).

Step 2

Run X-Hubsan APP. Enter the "Setting" interface and tap the "Relay" tab. Select "Setup the relay connection to aircraft" to enter the connection setting page.

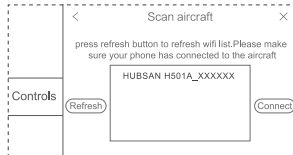

Step 3

Compass calibration

Please follow the app's prompting to calibrate.

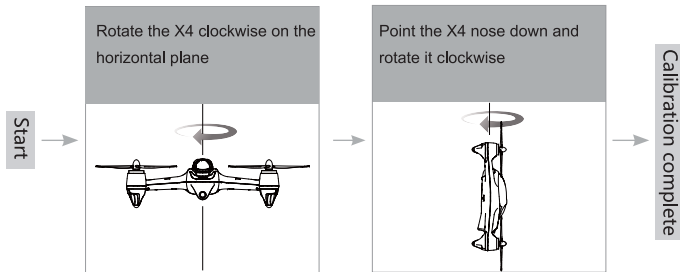

Step 4

Takeoff

Simultaneously pull the transmitter joysticks diagonally down-out to arm the motors (as shown in the left figure). Smoothly and slowly pull the left joystick (throttle) upwards to take off.

Landing

- 1) Slowly push down the throttle stick until the copter has completed its descent to the ground. Disarm the motors by simultaneously pulling both sticks diagonally down-out. When the motors have completely stopped, release the joysticks.
- 2) Slowly push down the throttle stick until the copter has completed its descent to the ground. Hold the throttle in its lowest position downwards for 5 seconds to fully disarm the motors.
- 3) Long press the Return to Home key and the aircraft will return either to its takeoff point or to the mobile device.

One may directly use the HT011A to fly the aircraft:

Step 1

(1) Hold the transmitter's binding button and simultaneously power the transmitter on. The HT011A's 2.4G status LED will flash.

(2) Power on the aircraft. Put both transmitter and aircraft very close to each other. The transmitter should beep once to indicate a successful binding. Its 2.4G status LED will turn solid.

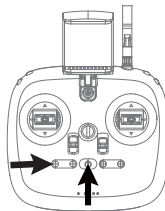

Step 2

After a successful binding, the aircraft will enter compass calibration mode:

- (1) When the LEDs are flashing clockwise, slowly rotate the aircraft on the horizontal plane.
- (2) When the LEDs are flashing in vertical pairs, alternately, point the head of the aircraft downwards and rotate the aircraft in place (it should be vertical, pointing perpendicular to the ground) until the LEDs turn solid.
- (3) Calibration is complete when the LEDs are solid.

Step 3

See instructions for takeoff and landing, the fifth flight configuration.

Charging and installing the aircraft battery

To charge the battery, connect the battery to the balance charger and connect the charger to the AC adapter (if necessary, please use a power conversion adapter). The balance charger LEDs are solid red while charging and turn solid green when the battery is fully charged. Please disconnect the battery from the charger immediately afterwards. Full charging time is around 180 minutes.

Installing the battery: Push the battery into its compartment with its lines facing away from the unit. Connect the blue adapters, noting the positive and negative polarities. Coil the power line into the compartment and then shut the battery hatch.

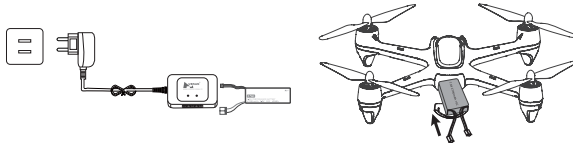

- Make sure the battery is fully charged before each flight.
- Please do not leave unattended while charging.

Installation and removal of propellers

The X4 aircraft uses 7.3-inch propellers. Each is marked with either an A or a B. Please replace damaged propellers.

Before installing the propellers for the first time, please check whether the propeller and motor arm read "A" or "B". The two letters should match.



- The propellers are self-tightening units. Please do not use other screws or screw glue to attach them to the motor shafts.
- Make sure that the propellers are installed in the correct positions, otherwise the aircraft will not be able to fly normally.
- Since the propeller blades are thin and somewhat sharp, it is recommended that users wear gloves during installation to prevent accidental scratches.

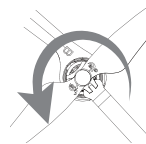
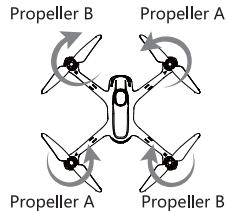

Getting to know your H906A

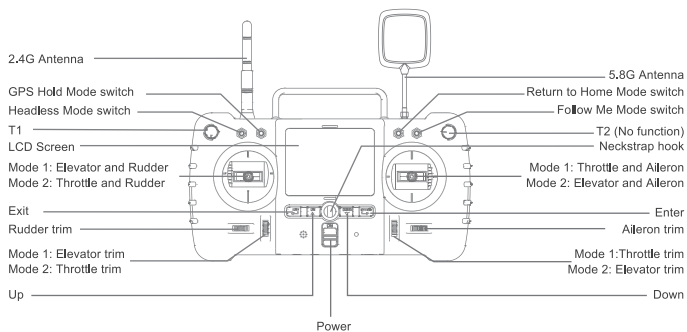
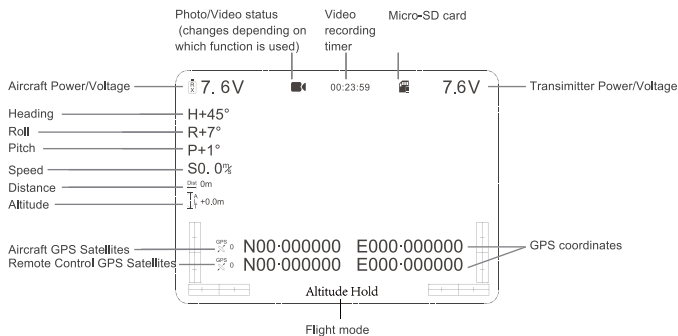

Getting to know your HT005 (Relay)

Product Description

The HUBSAN HT005 relay is a wireless signal amplifier. When used to amplify the aircraft WiFi and X-Hubsan APP connection, users can experience increased flight range. This device is suitable for any HUBSAN WiFi compatible aircraft.

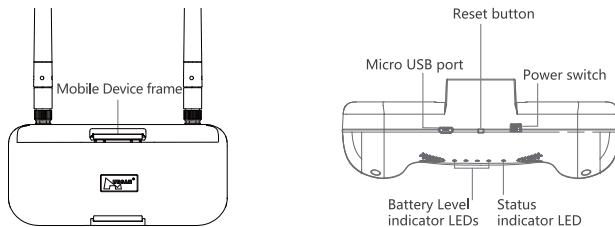

Getting to know your H901A

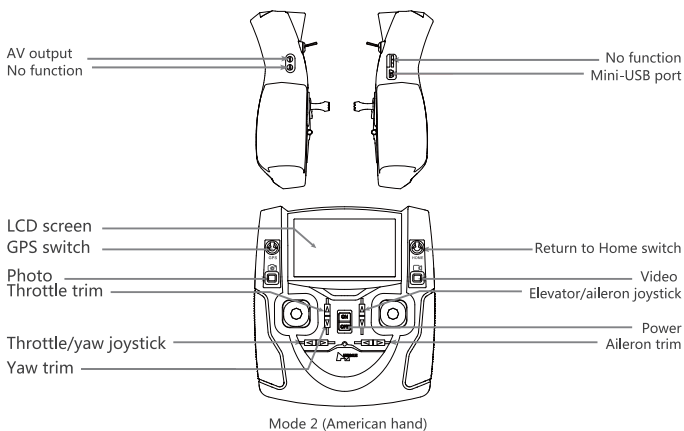

Getting to know your HT011A

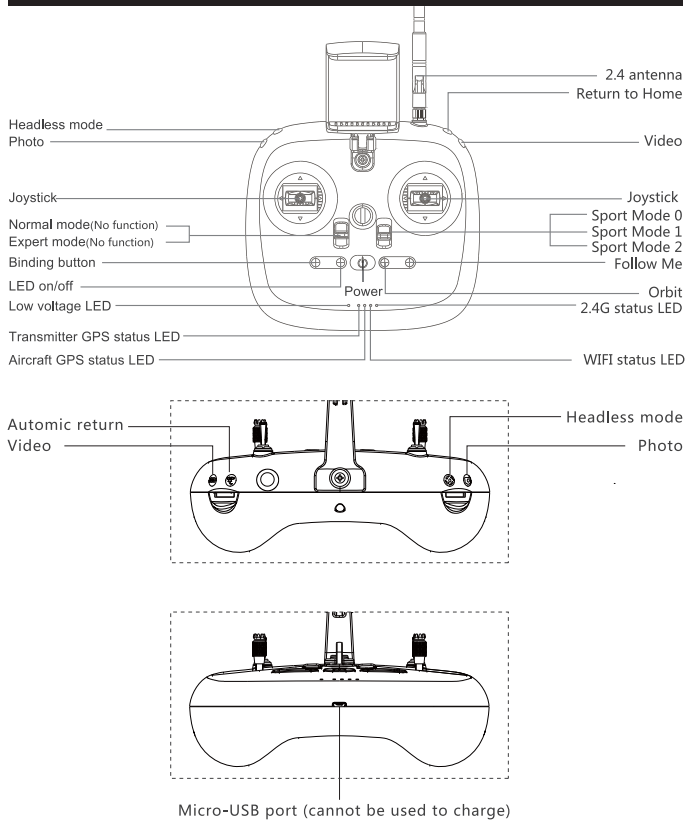

Note: When HT011A control is paired with the H501A aircraft, the gimbal adjustment wheels and flight mode switch have no functions or use.

Getting to know your H501A aircraft

Thank you for purchasing a HUBSAN product. The H501A can perform a variety of GPS flight functions, shoot 1080P HD video and take 2MP photos.

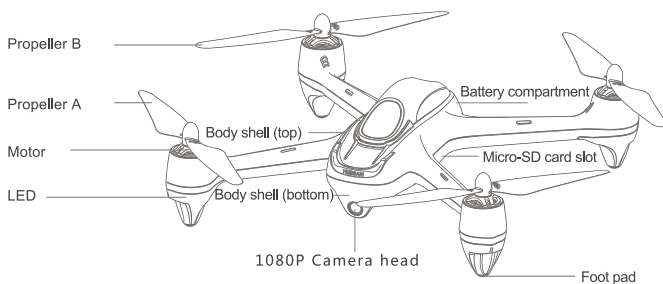

Getting to know the X-Hubsan APP

X-Hubsan is a flight control APP designed for HUBSAN WIFI compatible aircraft. Users can control flight, camera, video and flight parameters with the APP.

It is recommended to use a large screened smartphones or tablets for the optimal visual experience.

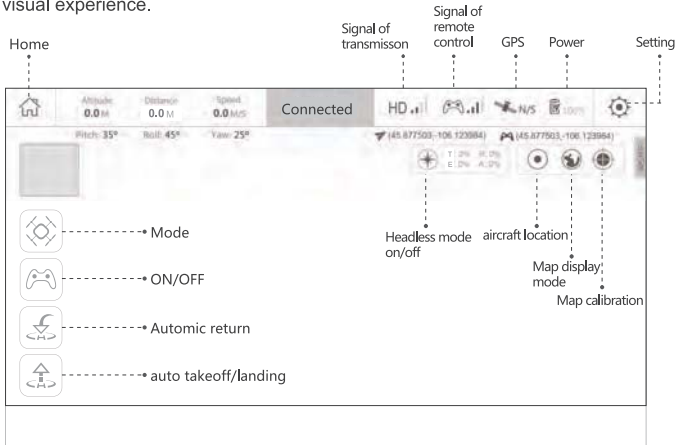

Appendix: LED Status Indicators

H501A has 4 LEDs; the fore/frontal LEDs are blue and the rear LEDs are red.

The LED status indications are defined as follows:

Function	LED status indication
Power on and start up	All 4 LEDs flash simultaneously
Compass calibration	Calib. Compass 1, all 4 LEDs flash clockwise; Calib. Compass 2 LEDs should be flashing in vertical pairs, alternately
Horizontal calibration	All 4 LEDs flash simultaneously
Rotational calibration	All 4 LEDs flash clockwise
Flight mode	All 4 LEDs are solidly lit
Low Power	Fore/frontal blue LEDs stay solidly lit and the rear red LEDs flash rapidly
How to turn off the LEDs	When recording and/or taking pictures, the throttle's vertical trim button serves as an on/off toggle for the LEDs
Flight control signal loss warning	When the flight control signal is lost, the rear red LEDs will stay solid while the fore blue LEDs will slowly flash
Headless mode	Fore LEDs slowly flash blue and rear LEDs are solid red.



- Before flying, carefully read the "Disclaimer and Safety Guidelines". Also watch the operational tutorial video on the official Hubsan website (www.hubsan.com).
- To learn more and for more detailed instructions, please download and read the "H501A User Manual" on the official Hubsan website.

WWW.HUBSAN.COM

Content is subject to change without notice.

Frequently Asked Questions

1. Aircraft and remote control are not pairing

- ① Check that the aircraft and remote control are both powered on.
- ② Rebind the aircraft and its chosen device(s).

2. Cannot arm motors

- ① Make sure that you have completed compass calibration
- ② Check that the Return to Home switch is pointing down/off
- ③ Check that the joystick channels on the LCD screen are properly centered (if they are not, please use the transmitter's trim buttons to adjust)
- ④ If you are flying indoors, please set the "Fly With No GPS" option on the Main Menu from the default "No" to "Yes".

3. Weak or nonexistent GPS signal/few or no GPS satellites

Make sure that the aircraft is not indoors or between buildings. Please take the aircraft outdoors to receive GPS satellites/signal.

4. No video on the screen or user is experiencing strong video feed interference

- ① Check whether there are strong sources of wireless interference (i.e. WIFI, electricity, radio tower frequencies, etc). If there are any, please change your flight location.
- ② Rebind the copter to the transmitter, as the 5.8 and 2.4 frequencies might be interfering with each other.

5. The aircraft flies erratically in Altitude Hold mode

- ① Check to see if the air pressure sensor reading (Altitude telemetry value) is abnormal when the aircraft is motionless on flat ground. It should read 0 and fluctuate very little.
- ② Check to see if the throttle joystick channel is moving appropriately and properly centered. If not, please calibrate the transmitter sticks and adjust the channel with the corresponding trim button (located on the transmitter).

6. Waypoint Mode does not work

- ① Check that the aircraft has 6 or more satellites
- ② Check that the GPS switch is pointing upwards (on) and the Return to Home switch is pointing down (off).
- ③ Check that all joystick channels onscreen are properly centered.

7. Follow Me mode does not work

Check that the aircraft is in GPS Hold mode (Follow Me will not work without it)

Check that the aircraft has 6 or more satellites (Follow Me will not work otherwise)

Make sure that the all joystick channels are properly centered and that the joysticks are not moved while Follow Me mode is engaged or being engaged. (the aircraft will automatically exit Follow Me mode if a non-throttle joystick is moved or not centered)

8. The aircraft does not return to the home point

When the aircraft takes off, be sure that the aircraft has received 6 or more satellites.

9. The aircraft keeps on losing GPS satellites or GPS satellites drop to 0 erratically

Check to see whether there are sources of high-frequency signal interference around the aircraft (such as high-voltage lines, signal transmission towers, etc).

10. Aircraft/video feed is shaking/shaky

- ① Check if the aircraft propellers are deformed or broken. Please replace them.
- ② Check that all aircraft body screws are firmly in place.
- ③ Check whether any motor shafts are broken. Motors must be replaced if the shafts are broken.

Limitation of Liability

Hubsan accepts no liability for damages, injuries or any legal responsibilities incurred directly or indirectly from the use of Hubsan products under the following conditions:

1. Damages, injuries or any legal responsibilities incurred when users are drunk, under the influence of drugs or anesthesia, dizzy, fatigued, nauseous and/or affected by other conditions both physical and mental that could impair sound judgment and/or personal ability.
2. Subjective misjudgment and/or intentional mis-operation of products.
3. Any and all mental damage, trauma, impairment, illness, compensation caused/solicited by accidents involving Hubsan products.
4. Product operation in no-fly zones (i.e. natural reserves).
5. Malfunctions or problems caused by modification, refit, replacement or use with non-Hubsan accessories/parts, failure to follow the guidance of the manual in assembly or operation.
6. Damages, injuries or any legal responsibilities caused by mechanical failures due to natural wear and tear (aircraft flight time clocking in 100 hours or above), corrosion, aging hardware, etc.
7. Continued flight after low voltage protection alarms are triggered.
8. Knowingly flying aircraft under abnormal conditions (such as when water, oil, soil, sand or other unknown material are inside the X4, the aircraft and/or transmitter are incompletely assembled, the main components have obvious faults, obvious defect or missing accessories, etc).
9. Flying in the following situations and/or environments: areas with magnetic interference (such as high voltage lines, power stations, broadcasting towers and mobile base stations), radio interference, government regulated no-fly zones, if the pilot loses sight of the X4, suffers from poor eyesight or is otherwise unsuited for operating Hubsan products.
10. Aircraft use in or exposure to bad weather, such as a rain, wind, snow, hail, lighting, tornadoes and hurricanes.
11. Products are involved in/exposed to collisions, fire, explosions, floods, tsunamis, manmade and/or natural structure collapses, ice, avalanches, debris, landslides, earthquakes, etc.
12. The acquisition, through use of Hubsan products (specifically but not limited to aircraft), of any data, audio, video that results in infringement of law and/or rights.
13. Misuse and/or alteration of batteries, product/aircraft circuits, hardware protections (including protection circuits), RC model and battery chargers.
14. Any malfunction of equipment or accessory, including memory cards, that results in the failure of an image or video to be recorded or to be recorded in a way that is machine readable.
15. Users who engage in reckless, unsafe flying (with or without sufficient training).
16. Noncompliance with precautions, instructions, information and operation guidelines/methods given through official Hubsan website announcements, product quick start guides, user manuals, etc.

17. Other losses, damages, or injuries that are not within the boundaries of Hubsan responsibility.

RISK OF EXPLOSION IF BATTERY IS REPLACED BY AN INCORRECT TYPE.

DISPOSE OF USED BATTERIES ACCORDING TO THE LOCAL REGULATIONS.

HAZARDOUS MOVING PARTS KEEP FINGERS AND OTHER BODY PARTS AWAY.

Declaration of Conformity

Hereby, SHENZHEN HUBSAN TECHNOLOGY CO., LTD.,

declares this product is in compliance with the essential requirements and other relevant provisions of Directive 2014/53/EU. A copy of the original Declaration of Conformity can be obtained at the following address: 13th Floor, Bldg 1C, SHENZHEN NANSHAN SOFTWARE INDUSTRY BASE, Xuefu Road, Nanshan District, Shenzhen, China

This product bears the selective sorting symbol for waste electrical and electronic equipment (WEEE). This means that this product must be handled pursuant to European Directive 2012/19/EU in order to be recycled or dismantled to minimize its impact on the environment.

For further information, please contact your local or regional authorities. Electronic products not included in the selective sorting process are potentially dangerous for the environment and human health due to the presence of hazardous substances.

FCC INFORMATION

This equipment has been tested and found to comply with the limits for a Class B digital device, pursuant to Part 15 of the FCC Rules. These limits are designed to provide reasonable protection against harmful interference in a residential installation. This equipment generates, uses, and can radiate radio frequency energy and, if not installed and used in accordance with the instructions, may cause harmful interference to radio communications. However, there is no guarantee that interference will not occur in a particular installation. If this equipment does cause harmful interference to radio or television reception, which can be determined by turning the equipment off and on, the user is encouraged to try to correct the interference by one or more of the following measures:

- Reorient or relocate the receiving antenna.
- Increase the separation between the equipment and receiver.

- Connect the equipment into an outlet on a circuit different from that to which the receiver is connected.
- Consult the local dealer or an experienced radio/TV technician for help.

Changes or modifications not expressly approved by the party responsible for compliance could void the user's authority to operate the equipment.

This device complies with Part 15 of the FCC Rules. Operation is subject to the following two conditions: (1) this device may not cause harmful interference, and (2) this device must accept any interference received, including interference that may cause undesired operation.

This device complies with FCC RF radiation exposure limits set forth for an uncontrolled environment. This transmitter must not be co-located or operating in conjunction with any other antenna or transmitter.

Changes or modifications not expressly approved by the party responsible for compliance could void the user's authority to operate the equipment.

Electrical and electronic equipment that are supplied with batteries (including internal batteries)

WEEE Directive & Product Disposal

At the end of its serviceable life, this product should not be treated as household or general waste. It should be handed over to the applicable collection point for the recycling of electrical and electronic equipment, or returned to the supplier for disposal.

Internal / Supplied Batteries.

This symbol on the battery indicates that the battery is to be collected separately.

This battery is designed for separate collection at an appropriate collection point.



Please read the operating instructions carefully before use!



- Never leave units unattended when charging
- Unplug the charging cable immediately after charging
- Propellers may cause injury
- This product is not a toy
- Not suitable for children under 14 years of age

WWW.HUBSAN.COM

SHENZHEN HUBSAN TECHNOLOGY CO., LTD.
13th Floor, Bldg 1C, Shenzhen Software Industry Base,
Xuefu Road, Nanshan District, Shenzhen, China. 518054



Telephone: 0769-82776166 (China)

Download the user manual