

# H501M X4 AIR BASIC EDITION

《H501M User Manual》

Version 1.0

## 2 Different Ways to Fly, 2 Configurations

1. Aircraft + HT009 Transmitter + mobile device (phone/tablet)

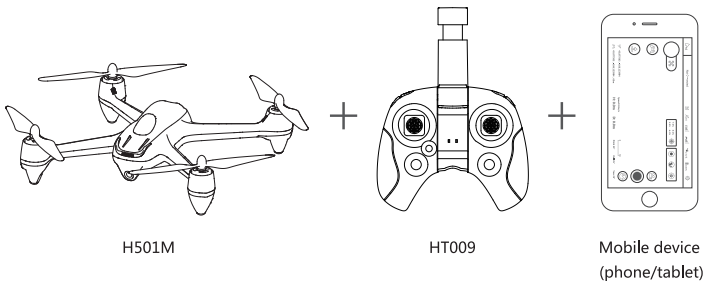

2. Aircraft + HT005 Relay + mobile device (phone/tablet)

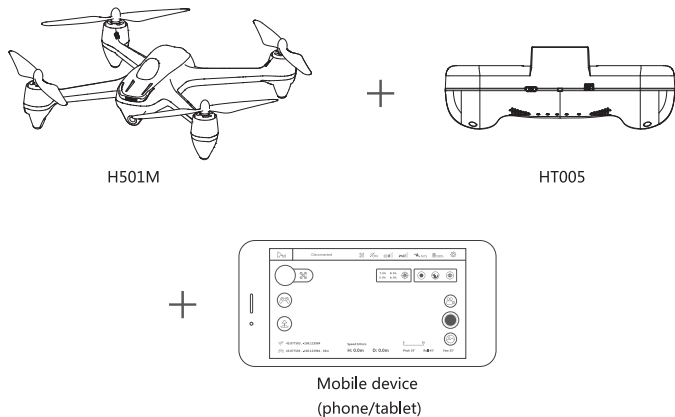

## Important safety information

**Operation:** Be extremely careful and responsible when using the quad. Small electronic components can be damaged due to crashes or exposure to moisture/liquid. To avoid any injuries, do not use the quad with broken or damaged components.

**Maintenance:** Do not try to open or repair the units by yourself. Please contact Hubsan or Hubsan authorized dealers for service. For more information, please visit the official website at [www.hubsan.com](http://www.hubsan.com).

**Battery:** Do not disassemble, squeeze, impact, burn, drop or trample the battery. Do not short-circuit or put the battery terminal in contact with metal. Do not expose the battery to temperatures above 60 ° C. Charge the aircraft battery prior to flight. Use a Hubsan dedicated charger for charging. Keep the battery out of the reach of children and away from any kind of moisture.

**Flight:** Please be mindful of personal safety and the safety of others while flying.

- Do not fly in bad weather conditions.
- Do not attempt to catch the aircraft while it is in flight.
- This product is intended for experienced pilots over the age of 14.
- After every flight, completely disarm the aircraft motors and disconnect the aircraft from power. Then, you may power off the remote control.

Read the Disclaimer and Safety Guidelines first before use.

### Symbol explanation:

 Prohibited operation

 Important Notice

 Instruction

 Explanation/reference

### USAGE ADVICE

(Hubsan has created the following operational and safety materials):

 《Quick Start Guide》

## Hubsan Safety Advisory Notice for Lithium-Polymer (LIPO) Batteries

LiPo batteries are different from conventional batteries in that their chemical contents are encased in a relatively lightweight foil packaging. This has the advantage of significantly reducing their weight but it does make them more susceptible to damage if roughly or inappropriately handled. As with all batteries, there is a risk of fire or explosion if safety practices are ignored:

- If you do not plan to fly the quad for a long time, store the battery ~50% charged to maintain battery performance and life.
  - Please use Hubsan chargers for battery charging.
  - Discharge the battery at 5C current or below. To avoid discharge related battery damage, do not prolong the discharge time.
  - Do not charge on carpet to avoid fire.
  - Batteries need to be recharged if unused for over 3 months.
- ① 1. Do not disassemble or reassemble the battery.
  2. Do not short-circuit the battery.
  3. Do not use or charge near sources of heat.
  4. Do not put the battery in contact with water or any kind of liquid.
  5. Do not charge batteries under sunlight or near fire.
  6. Do not puncture or subject the battery to force of any kind.
  7. Do not throw or manhandle the battery.
  8. Never charge a battery that has been damaged, become deformed or swelled.
  9. Do not solder on or near the battery.
  10. Do not overcharge or over discharge the battery.
  11. Do not reverse charge or reverse the battery polarities.
  12. Do not connect the battery to a car charger/cigarette lighter or any kind of unconventional power source.
  13. This battery is prohibited for non-designated devices.
  14. Do not touch any kind of liquid waste or byproduct from batteries. If skin or clothes come in contact with these substances, please flush with water!
  15. Do not mix other types of batteries with lithium batteries.
  16. Do not exceed the specified charging time.
  17. Do not place the battery in a microwave or in areas of high pressure.
  18. Do not expose the battery to the sun.
  19. Do not use in environments with high static electricity (64V and above).
  20. Do not use or charge in temperatures below 0 °C and above 45 °C.
  21. If a newly purchased battery is used, leaking, possesses a bad smell or other abnormalities, return immediately to the vendor.
  22. Keep away from the reach of children.
  23. Use a dedicated battery charger and follow all charging requirements.
  24. Minors who use the battery and its dedicated unit must be supervised by an adult at all times.

# Table of Contents

Important safety information -----	2	5.2 Pre-Flight Checklist -----	13
Symbol Explanation -----	2	5.3 Three ways to pair and fly-----	14
Usage Advice -----	2	5.3.1 Pairing the aircraft+mobile device-----	14
H501M Profile -----	5	5.3.2 Pairing the aircraft+mobile device+HT009 Transmitter -----	14
<b>1. The H501M Aircraft</b> -----	<b>5</b>	5.3.3 Pairing the aircraft+mobile device+HT005 Relay-----	15
1.1 Aircraft component breakdown	5	5.4 Calibrations -----	16
1.2 The aircraft battery-----	6	5.4.1 Horizontal calibration -----	16
1.3 Installing and Removing the propellers -----	7	5.4.2 Compass calibration-----	17
1.4 Aircraft LED indications-----	8	5.4.3 GPS Accuracy test -----	17
<b>2. X-Hubsan APP</b> -----	<b>8</b>	5.5 Flying with the APP-----	18
2.1 APP Overview -----	8	5.5.1 Arming/Disarming motors ..	18
2.2 Downloading the APP -----	8	5.5.2 Auto Takeoff/Land -----	18
2.3 APP Interface Guide -----	9	5.5.3 Advanced functions -----	19
<b>3. The HT009 Remote</b>		5.6 Flying with the HT009 Transmitter	10
<b>Control/Transmitter</b> -----	<b>9</b>	<b>6. Failsafe modes</b> -----	<b>23</b>
3.1 HT009 overview -----	9	6.1 Low power failsafe -----	24
3.2 Remote control components and functions -----	10	6.2 Loss of flight control connection failsafe -----	24
3.3 Battery installation-----	11	<b>Frequently Asked Questions</b> -----	<b>25</b>
<b>4. The HT005 Relay</b> -----	<b>11</b>	<b>H501M Accessories</b> -----	<b>26</b>
4.1 HT005 overview-----	11		
4.2 Battery -----	12		
<b>5. Flight</b> -----	<b>13</b>		
5.1 Flight environment requirements	13		

## H501M Accessories

Thank you for purchasing a HUBSAN product. The H501M is an easy to fly aircraft, capable of a variety of flight functions.

Please read and follow the manual carefully for proper operation and use.

 **FPV:** Also known as First Person View, or the first person perspective. With FPV, users can intuitively fly the aircraft and enjoy an immersive flight experience.

## 1 The H501M aircraft

### 1.1 Aircraft component breakdown

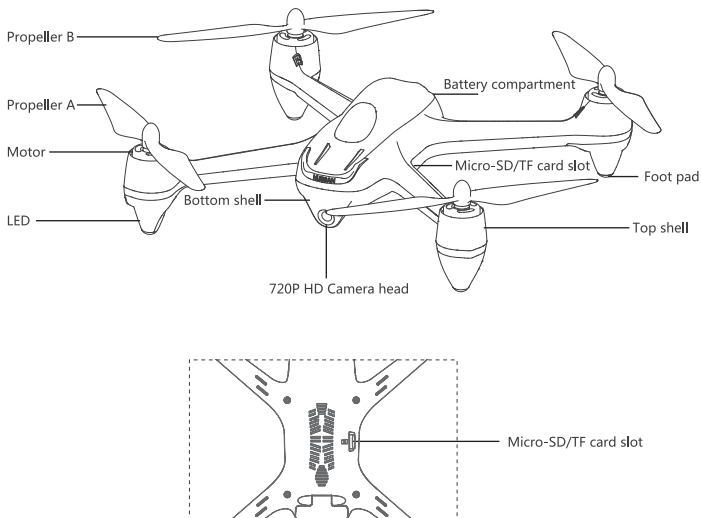

## 1.2 The aircraft battery

To charge the battery, connect the battery to the balance charger and connect the charger to the AC adapter (if necessary, please use a power conversion adapter). The balance charger LEDs are solid red while charging and turn solid green when the battery is fully charged.

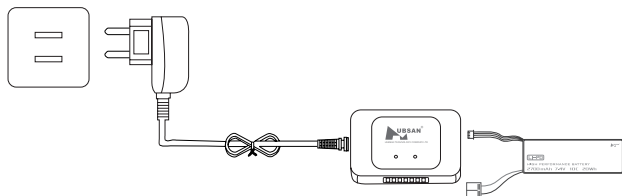

Installing the battery: Push the battery into its compartment with its lines facing away from the unit (below figure). Connect the blue adapters, noting the positive and negative polarities.

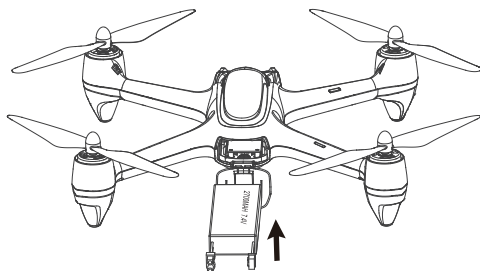

- Make sure the battery is fully charged before each flight.
- Please do not leave unattended while charging.

### 1.3 Installing and Removing the propellers

The X4 aircraft uses 7.3-inch propellers. Each is marked with either an A or a B. Please replace damaged propellers.

Before installing the propellers for the first time, please check whether the propeller and motor arm read "A" or "B". The two letters should match.

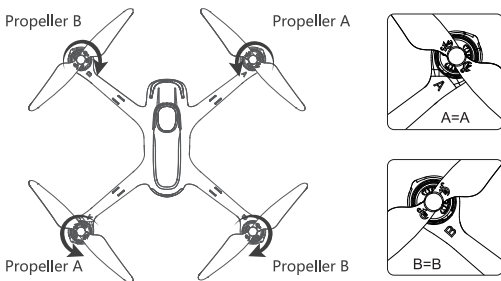

Removal: When the blade is damaged or needs to be replaced, hold the propeller with a hand or the provided auxiliary wrench, and remove by turning it in the indicated "unlock" direction.

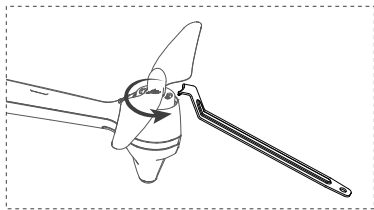

- The propellers are self tightening units. Please do not use other screws or screw glue to attach them to the motor shafts.
- Make sure that the propellers are installed in the correct positions, otherwise the aircraft will not be able to fly normally.
- Since the propeller blades are thin and somewhat sharp, it is recommended that users wear gloves during installation to prevent accidental scratches.



## 1.4 Aircraft LED indications

H501M has 4 LEDs; the fore/frontal LEDs are blue and the rear LEDs are red. The LED status indications are defined as follows:

Function	LED Status Indication
Power on and start up	All 4 LEDs flash simultaneously
Compass Calibration	Calib. Compass 1, all 4 LEDs flash clockwise; Calib. Compass 2, LEDs should be flashing in vertical pairs, alternately
Horizontal Calibration	All 4 LEDs flash simultaneously
Inertial Sensor Calibration	All 4 LEDs flash simultaneously
Flight Mode	All 4 LEDs are solidly lit
Low Power	Fore/frontal blue LEDs stay solidly lit and the rear red LEDs flash rapidly
Flight control lost	When the flight control signal is lost, the rear LEDs will stay solid while the fore LEDs will slowly flash
Headless mode	Fore LEDs slowly flash blue and rear LEDs are solid red.
How to shut off LEDs	Long press the camera button

## 2 X-Hubsan APP

### 2.1 APP overview

X-Hubsan is a flight control APP designed for HUBSAN WIFI-enabled aircraft. Users can control flight, camera, video and flight parameters with the APP. It is recommended to use a large screened smartphones or tablets for the optimal visual experience.

### 2.2 Downloading the APP

Before flying, users must download the X-Hubsan APP.

Download the APP for free by scanning the code on the right or by downloading it via the App Store (iOS) and Google Play (Android).



## 2.3 APP Interface Guide

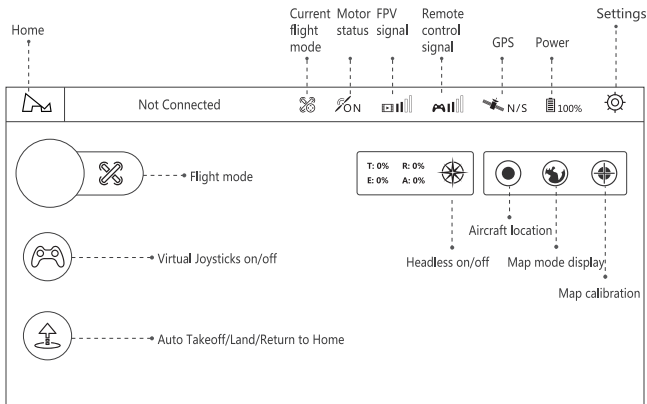

## 3 The HT009 Remote Control/Transmitter

The HT009 is a Bluetooth transmitter fully outfitted for use with the H501M aircraft and its various functions. Experience real-time video transmission through the X-Hubsan app on a mobile device equipped with a high definition screen.

### 3.1 HT009 overview

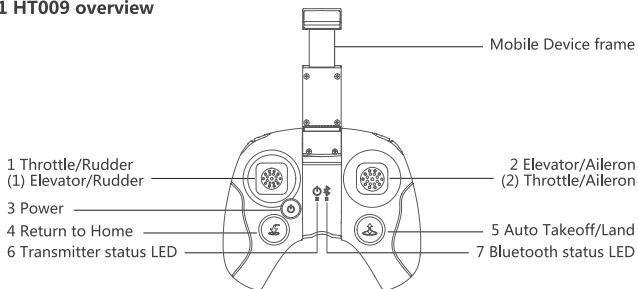

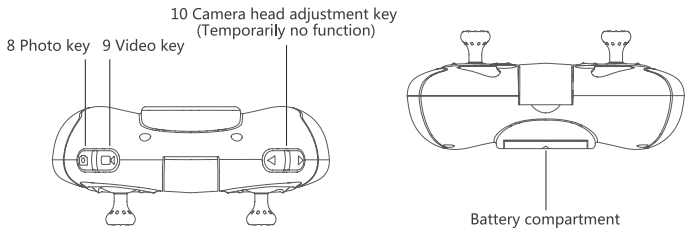

### 3.2 HT009 key functions

No.	Key/Button/Switch	Function
1	Throttle/Rudder stick	Push the stick forward or backward and the quadcopter will ascend or descend (respectively). Push the stick left or right and the quadcopter will rotate counterclockwise or clockwise (respectively).
2	Elevator/Aileron stick	Push the stick forward or backward and the quadcopter will fly forwards or backwards (respectively). Push the stick left or right and the quadcopter will fly left or right (respectively).
(1)	Throttle/Aileron stick	Push the stick forward or backward and the quadcopter will ascend or descend (respectively). Push the stick left or right and the quadcopter will fly left or right (respectively).
(2)	Elevator/Rudder stick	Push the stick forward or backward and the quadcopter will fly forwards or backwards (respectively). Push the stick left or right and the quadcopter will rotate counterclockwise or clockwise (respectively).
3	Power	Long press for 1.5 seconds and the transmitter will power on. To power off, long press for 1.5 seconds while the transmitter is on.
4	Return to Home	Long press for 1.5 seconds and the quadcopter will perform a Return to Home. To terminate Return to Home, short press for 0.5 seconds.
5	Auto Takeoff/Auto Land	Long press for 1.5 seconds and the quadcopter will perform an Auto Takeoff or Auto Land (if the unit is airborne).
6	Transmitter status LED	When the transmitter is powered on, the LED should be solidly lit. If the transmitter is low on power, the LED will flash rapidly.
7	Bluetooth status LED	When the transmitter is powered on, the LED should be solidly lit. If the transmitter is low on power, the LED will flash rapidly.
8	Photo	Short press the key to take a photo.
9	Video	Short press once to start the recording; short press again during the recording to stop the recording.
10	Camera head adjustment key	Temporarily no function.

### 3.3 Battery installation

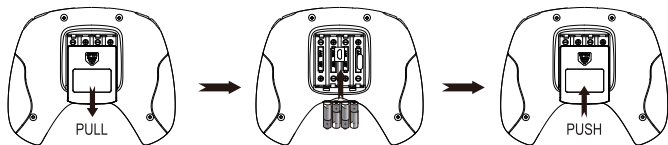

Remove the compartment screw.  
Slide open the compartment hatch.

Insert 4 AAA batteries into the  
battery compartment. Take note to  
make sure you have correctly  
matched the polarities.

Slide the compartment hatch to  
close it; screw it shut.



- Do not mix new and old batteries
- Do not cross-use different types of batteries at the same time
- There are two ports located in the battery compartment, used for upgrades. Please **DO NOT** use or connect these ports to any kind of device whatsoever!

## 4 The HT005 relay

### 4.1 HT005 overview

The HUBSAN HT005 relay is a wireless signal amplifier. When used to amplify the aircraft WiFi and X-Hubsan APP connection, users can experience increased flight range. This device is suitable for any HUBSAN WiFi-enabled aircraft.

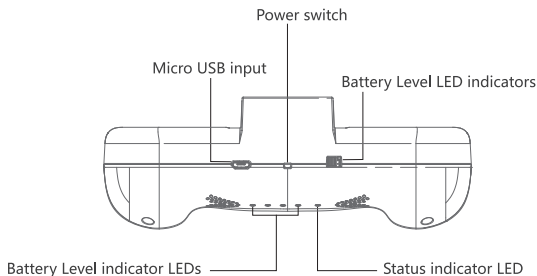

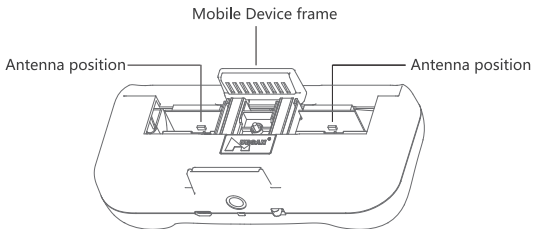

## LED Indicators

Status indicator: red upon start up, green when start up is complete.

Power indicator: When charging, all 4 LEDs will flash blue. They will stay solidly lit when the battery is fully charged. Each LED represents 25% of the battery's maximum charge.

## 4.2 Battery

HUBSAN has designed a 2600mAh battery for the HT005 relay. The unit is equipped with overcharge, over discharge and low voltage protections.

### Specifications

Type	LiPo	Capacity	2600mAh
Voltage	3.7V	Consumption	9.62Wh
Ambient temperature for charging		0°C~+35°C	
Ambient temperature for use		-20°C~+60°C	



Make sure the battery is fully charged before use.

### Charging the battery

Connect the relay with the provided Micro USB charging cable to a 5V adapter or a PC terminal to charge. When charging, all 4 LEDs will flash blue. They will stay solidly lit when the battery is fully charged. If the charge current is 1A, it takes 3 hours to fully charge. In general, approximate charging time is 180 minutes.

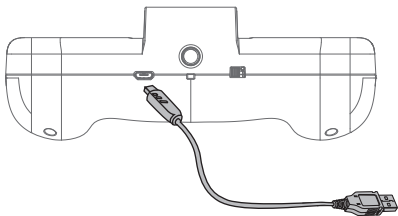

When needed, adapters must be supplied by the user; maximum charge current is 2.6A.

## 5 Flight

It is recommended that users implement some kind of flight training (i.e using a simulator for flight practice, seeking professional guidance, etc.) before flying. Please select an appropriate flight environment for flight.

### 5.1 Flight environment requirements

- (1) Select an open environment devoid of high rise buildings and tall obstructions (such as trees and poles). Near buildings and obstacles, flight control signals and GPS signals can be severely weakened; GPS functions such as GPS mode and Return to Home may not function properly.
- (2) Do not fly in bad weather conditions (such as in wind, rain or fog).
- (3) Fly the drone in ambient temperatures of 0-40 °C.
- (4) When flying, please stay away from obstructions, crowds, high voltage lines, trees, water, etc.
- (5) To avoid remote control signals interference, do not fly in complex electromagnetic environments (such as venues with radio stations, power plants and towers).
- (6) The aircraft cannot be used in/near the Arctic circle or Antarctica.
- (7) Do not fly in no-fly zones.
- (8) Do not operate the aircraft near high pressure lines, airports or areas with severe magnetic interference.

## 5.2 Pre-Flight checklist

- (1) Make sure the aircraft battery and mobile device are charged and have adequate power.
- (2) Confirm that propellers are properly installed.
- (3) If you are taking pictures, insert the Micro-SD card required for taking pictures and videos (recommended Class 10, 16GB, 32GB max).
- (4) Verify that the motors arm and spin smoothly.
- (5) Ensure the camera lens is clean.

## 5.3 Three ways to pair and fly

### 5.3.1 Pairing the aircraft+mobile device

Connect the aircraft to its battery. Go to your mobile device's WIFI settings and select the H501M's WIFI signal (Hubsan\_H501M\_XXXXXX).

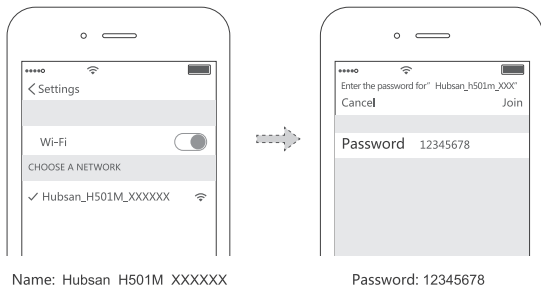
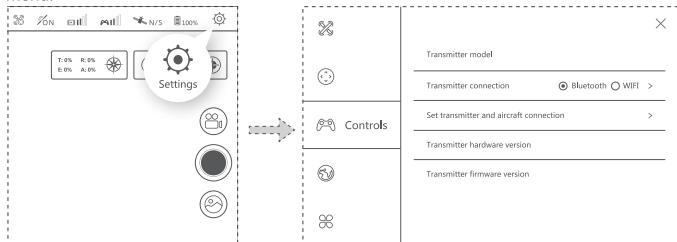

Figure 1

### 5.3.2 Pairing the aircraft+mobile device+HT009 Transmitter

Connect the aircraft to its battery. Go to your mobile device's WIFI settings and select the H501M's WIFI signal (Hubsan\_H501M\_XXXXXX, Figure 1).

2) Power the transmitter on; pair the mobile device and transmitter on the Bluetooth menu.



1. Enter the main app interface and tap the Settings cog on the upper right-hand corner.

2. Tap "Controller" and then "Using remote control" .

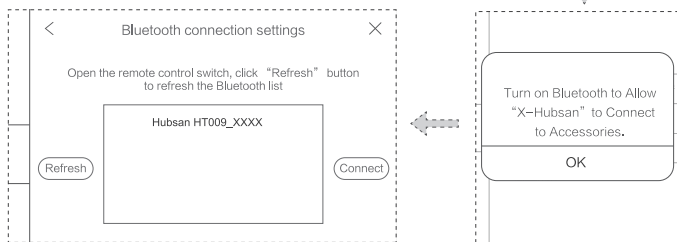

4. The interface will then show the "Bluetooth connection settings" menu. Select the HUBSAN HT009\_XXXXXX and confirm to connect.

3. The device will request permission to use Bluetooth. Tap "Allow" to continue.

### 5.3.3 Pairing the aircraft+mobile device+HT005 relay

1) Power on the HT005. Enter your mobile device' s WIFI settings and select the HT005 WIFI signal (Hubsan\_HT005\_XXXXXX, right hand figure).

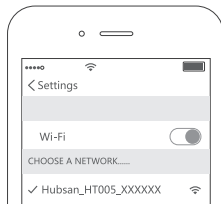



2) Run X-Hubsan APP and select the appropriate aircraft. Enter the "Settings" interface and tap the "Controls" tab. Make sure "Transmitter connection" is set to "Bluetooth" (NOT WIFI). Then, select "Set relay to connection with the aircraft" to enter the connection settings page (below figure).

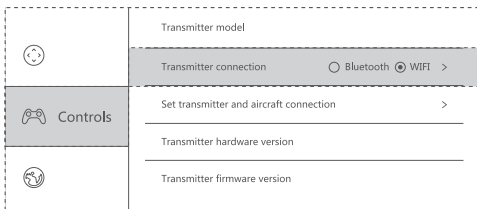

3) Refresh the WIFI list and select the WIFI signal of the aircraft you are using (Hubsan-H501M-XXXXXX). Tap the WIFI signal in question and allow the relay and aircraft to connect (below figure).

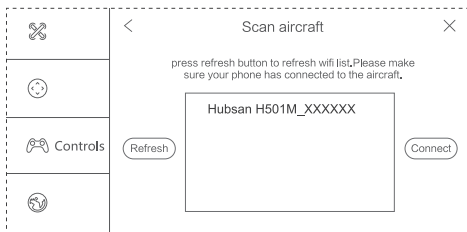

## 5.4 Calibrations

### 5.4.1 Horizontal calibration

If during takeoff or flight the aircraft drifts, lifts off unevenly, perform a horizontal calibration. First, land the aircraft if it is flying and make sure all motors come to a complete stop. The aircraft must also be on a completely flat and horizontal surface for the calibration to work properly. Tap the Settings cog, followed by "Other". Select "Horizontal Calibration" and allow the aircraft to calibrate itself. Calibration is complete when all 4 LED indicators stop flashing. It is recommended that users wait for 15-20 seconds after the calibration is completed before flying again.

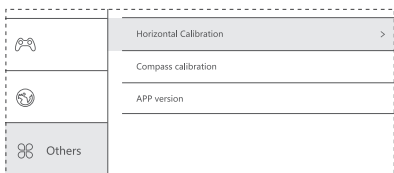

### 5.4.2 Compass calibration

The compass must be calibrated every time the aircraft is powered on. The compass is susceptible to interference by other electronic equipment, magnetic interference and metal, which can lead to erratic behavior and loss of control. Regular calibration helps keep the compass and its readings accurate. To manually calibrate the compass, tap the "Settings" cog on the upper right hand corner of the main interface. Then select "Other" followed by "Compass calibration".

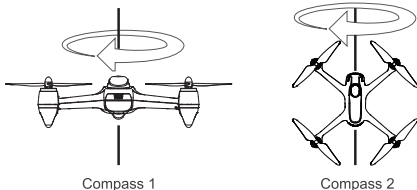

### 5.4.3 GPS accuracy test

To perform a GPS accuracy test, tap the "Settings" cog, followed by the "Aircraft" tab. Select "Start/restart GPS accuracy test" and the aircraft will conduct the GPS accuracy test automatically. Make sure the mobile device is very close to the aircraft. Move the device around the aircraft for more accuracy.

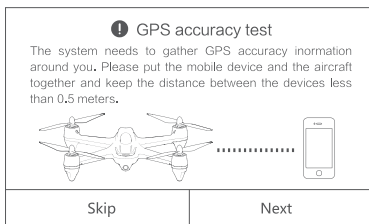

## 5.5 Flying with the APP

### 5.5.1 Arming/Disarming

How to arm (start) motors:

Simultaneously pull the virtual joysticks diagonally down-out to arm the motors (as shown in the below figure).

How to disarm (stop) motors:

Disarm the motors by simultaneously pulling both sticks diagonally down-out. When the motors have completely stopped, release the joysticks.

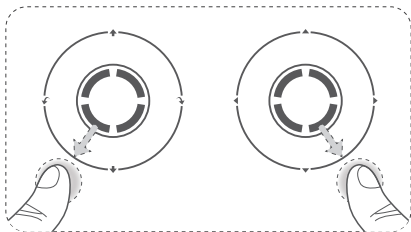

⊘ While flying, please make sure you do not disarm while in midair. The aircraft motors will stop, causing the aircraft to crash.

💡 Be sure to operate the virtual joysticks slowly and firmly. When disarming, wait until the motors come to a complete stop before releasing the joysticks.

### 5.5.2 Auto Takeoff/Land

When the aircraft's LEDs are solid and the aircraft is ready for flight, pilots may use the Auto Takeoff/Auto Land features. Please follow the below steps:

**Auto Takeoff:** First, confirm that take-off conditions are safe and clear. Tap the Auto Takeoff icon; the aircraft will automatically takeoff and hover at a height of ~2 meters from the ground. Note that the Auto Takeoff icon will turn into an Auto Land icon after the aircraft begins to fly.

**Auto Land:** First, confirm that landing conditions are safe and clear. Be sure to choose a flat, open area for the landing. Tap the Auto Land icon; the aircraft will slowly descend to the ground and disarm its motors.



## 5.5.3 Advanced functions

### 1) Headless mode

Tap the compass icon to activate Headless mode. The aircraft will set the direction its head is pointing at the time of activation as the default "forward" direction in Headless mode.

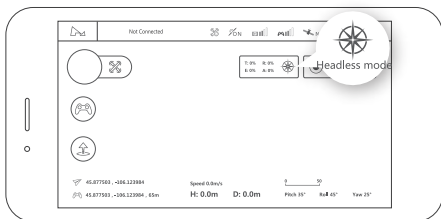

### 2) Waypoint mode

While motors are completely disarmed, tap the Flight mode icon and select the Waypoint mode icon. You can custom set each Waypoint altitude, travel speed and other parameters before uploading your Waypoint mission. After takeoff, the aircraft will fly its specified route.

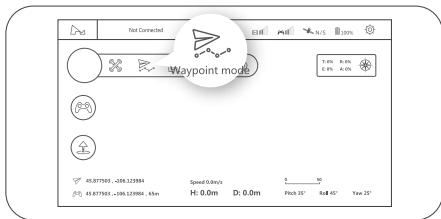

Point of interest (POI): While flying with waypoints, pilots may set a POI. The aircraft will turn to face the POI for the entire duration of the mission. Point of interest (POI): While flying with waypoints, pilots may set a POI. The aircraft will turn to face the POI for the entire duration of the mission.

### 3) Follow Me

Tap Flight mode icon and select Follow Me. The aircraft will now follow the mobile device. Pilots may adjust the following distance with the elevator stick (back and forth only) while the aircraft is in Follow Me mode.

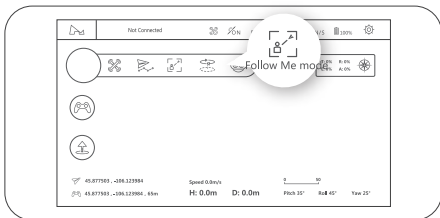

### 4) Circle fly/Orbit mode

Tap the Flight mode icon and select Orbit/Circle fly. The aircraft will fly in a circle around the mobile device. Orbit is only usable when the aircraft is at least 3 meters away from the mobile device. While in Orbit, pilots may use the aileron (left and right only) to adjust the Orbit radius.

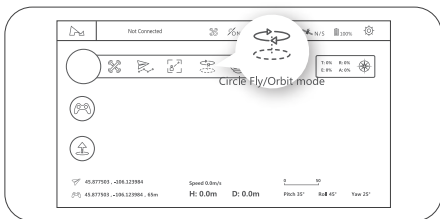

Please begin flight only when you have 6 or more GPS satellites. Waypoint/Return to Home/Orbiting/Follow Me modes are then accessible. Note: GPS cannot be accessed indoors.

## 5.6 Flying with the HT009 Transmitter

When the HT009 is successfully paired with a mobile device and the aircraft, pilots may use it to control the H501M.

### How to arm (start) motors:

Simultaneously pull both joysticks diagonally down-out as shown in the right hand figure.

### How to disarm (stop) motors:

Make sure the aircraft has completed its descent to the ground. Simultaneously pull both joysticks diagonally down-out as shown in the right hand figure.

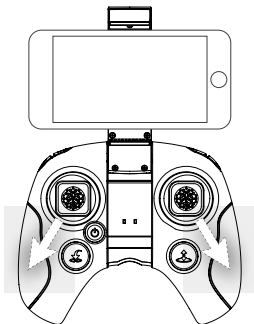

- ⊘ While flying, please make sure you do not disarm while in midair. The aircraft motors will stop, causing the aircraft to crash.
- 💡 Be sure to operate the virtual joysticks slowly and firmly. When disarming, wait until the motors come to a complete stop before releasing the joysticks.

## Auto Takeoff/Land

When the aircraft's LEDs are solid and the aircraft is ready for flight, pilots may use the Auto Takeoff/Auto Land features. Please follow the below steps:

**Auto Takeoff:** First, confirm that take-off conditions are safe and clear. Tap the Auto Takeoff key; the aircraft will automatically takeoff and hover at a height of ~2 meters from the ground. Note that the Auto Takeoff key will turn into an Auto Land key after the aircraft begins to fly.

**Auto Land:** First, confirm that landing conditions are safe and clear. Be sure to choose a flat, open area for the landing. Tap the Auto Land icon; the aircraft will slowly descend to the ground and disarm its motors.

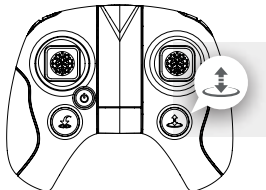

## Return to Home

Return to Home mode will only work when the aircraft has 6 or more satellites. Otherwise, the unit will not be able to return and will malfunction.

### Entering Return to Home mode

Long press the Return to Home button for 1.5 seconds and the quadcopter will perform a Return to Home. The flight control system will command the aircraft to return to its designated "home" point. Users can either allow the flight system to land the aircraft automatically, or exit Return to Home and land the aircraft manually.

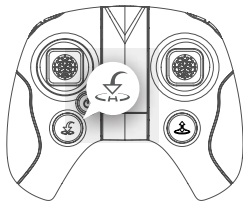

### Exiting Return to Home

To terminate Return to Home, short press for 0.5 seconds. Users may then continue to fly or land the aircraft manually.







1. Use this function only if the aircraft has 6 or more GPS satellites.
2. While in RTH, pilots may also use the non-throttle stick to navigate the aircraft and avoid obstacles.

The remote control is by default set to Mode 2 in factory; this manual will introduce flight operations in Mode 2.

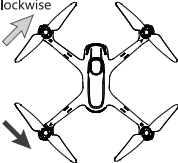
- Transmitter joysticks are self-centering and spring loaded: the joysticks will automatically center themselves.
- Joystick sensitivity: dependent how much and how forcefully each joystick is pulled or pushed away from center point.

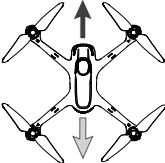
Remote Control (Mode 2)	Aircraft	Transmitter controls
		<p>The throttle is used to control the ascent and descent of the aircraft. Push the throttle up and the aircraft ascends. Pull the throttle back and the aircraft descends. When the joystick is centered (unmoving), the aircraft will hold its altitude in the air. The throttle must be pushed upwards beyond center point for the aircraft to completely takeoff from the ground. The harder the throttle is pushed, the faster the aircraft will ascend. Please push the throttle slowly for a gradual lift and to prevent the aircraft from ascending erratically.</p>

Remote Control (Mode 2)	Aircraft	Transmitter controls
	<p data-bbox="314 155 394 173">Clockwise</p>  <p data-bbox="314 365 456 383">Counterclockwise</p>	<p data-bbox="584 145 952 372">The rudder is used to control the aircraft's rotations. Push the joystick to the left and the aircraft rotates counterclockwise. Push the joystick to the right and the aircraft rotates clockwise. When the joystick is centered (unmoving), the angular velocity of the aircraft is "0" and the aircraft will not turn. How hard the rudder is pushed will determine the angular velocity of the aircraft's rotation. The harder the rudder is pushed, the faster the aircraft rotates.</p>
	<p data-bbox="408 428 474 446">Forward</p>  <p data-bbox="408 666 480 684">Backward</p>	<p data-bbox="584 414 952 680">The elevator controls the aircraft's forward and backward movement. Push the joystick forward and the aircraft will tilt and fly forward. Pull the joystick back and the aircraft will tilt and fly backwards. When the joystick is centered (unmoving), the aircraft will hold its altitude in the air. How hard the elevator is pushed will determine the degree of the aircraft's tilt and therefore the velocity of its forward and backward movement. The harder the elevator is pushed, the greater the aircraft's tilt angle and flight speed either forwards or backwards.</p>
	 <p data-bbox="325 904 360 922">Left</p> <p data-bbox="505 904 553 922">Right</p>	<p data-bbox="584 715 952 960">The aileron controls the aircraft's left and right movement. Push the joystick to the left and the aircraft will tilt and fly leftwards. Pull the joystick to the right and the aircraft will tilt and fly rightwards. When the joystick is centered (unmoving), the aircraft will hold its altitude in the air. How hard the aileron is pushed will determine the degree of the aircraft's tilt and therefore the velocity of its left and right movement. The harder the aileron is pushed, the greater the aircraft's tilt angle and flight speed either leftwards or rightwards.</p>



## 6 Failsafe modes

### 6.1 Low power failsafe

When the aircraft battery is low, there is likely insufficient power to support the return of the aircraft. Please land the aircraft immediately, otherwise the aircraft will fall and cause damage to the aircraft and surrounding objects. To prevent this, the aircraft flight control will use flight information to determine whether to perform a Return to Home or to land immediately.

### 6.2 Loss of flight control connection

When the flight control connection between the aircraft and transmitter is lost, the aircraft will automatically land or return to where the remote control/transmitter was last located and land there. This can drastically reduce the possibility of the aircraft crashing or being lost.

Conditions that may trigger a failsafe

- 1) Transmitter is powered off/loses power.
- 2) The flight distance exceeds the remote control's signal transmission range.
- 3) There is an obstacle between the remote control and aircraft.
- 4) The flight control or transmitter signal is interrupted by strong external electronic interference.



To ensure the successful return of the aircraft if it loses flight control connection, users must confirm that the aircraft has enough GPS satellites to fly safely in GPS mode. Users must also be certain that the flight environment is clear enough for an emergency return and landing. If the aircraft's GPS satellites drop below 6 for more than 20 seconds while the X4 is returning to Home Point, the aircraft will automatically descend.

## Frequently Asked Questions

### **1. Aircraft and remote control are not pairing**

- ① Check that the mobile device WIFI utility is active.
- ② Restart the aircraft.

### **2. Weak or nonexistent GPS signal/few or no GPS satellites**

Make sure that the aircraft is not indoors or between buildings. Please take the aircraft outdoors to receive GPS satellites/signal.

### **3. Follow Me mode does not work**

- ① Check that the aircraft is in GPS mode (Follow me will not work without it ).
- ② Check that the aircraft has passed the GPS accuracy test (Follow Me will not work if you skip or fail this step ).
- ③ See if the aircraft power is dipping below 25% (Follow Me will not function if so).

### **4. The aircraft does not return to the home point**

When the aircraft takes off, be sure that the aircraft has received 6 or more satellites.

### **5. The aircraft keeps on losing GPS satellites or GPS satellites drop to 0 erratically**

Check to see whether there are sources of high-frequency signal interference around the aircraft (such as high-voltage lines, signal transmission towers, etc).

### **6. Aircraft/video feed is shaking/shaky**

- ① Check if the aircraft propellers are deformed or broken. Please replace them.
- ② Check that all aircraft body screws are firmly in place.
- ③ Check whether any motor shafts are broken. Motors must be replaced if the shafts are broken.

### **7. Aircraft refuses to pass the GPS accuracy test (even after a long wait)**

- ① Restart the test from the Settings interface ("Other") and move the mobile device around the drone (you must be within 1-3 feet of the aircraft for this to work).
- ② Rebind/re-pair the mobile device and aircraft.

## H501M Accessories

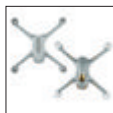

H501M-07  
H501M Body shell  
(Galaxy Grey)



H501M-03  
Battery cover



H501S-17  
Lampshade

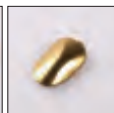

H501S-03  
Canopy



H501S-18  
Motor LED  
Lampshade A/B

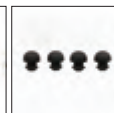

H109-04  
Rubber feet



H501S-04  
Screw set



H501M-04  
Propeller A (Black)



H501M-05  
Propeller B (Black)



H501S-05  
Propeller A (Gold)

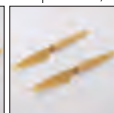

H501S-06  
Propeller A (Gold)

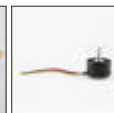

H501M-09  
Brushless  
motor A (Black)

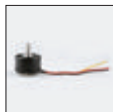

H501M-10  
Brushless  
motor B (Black)

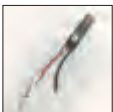

H501S-19  
ESC



H501C-10  
LED PCBA  
(Blue/Red)

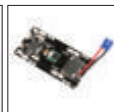

H501M-11  
PCB motherboard

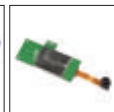

H501M-08  
Video module  
(FPV transmission)



H501S-12  
GPS module



H501M-02  
Compass



H501S-14  
Li-Po Battery



H301S-11  
Charging adapter



H301S-12  
Balance charger



H501M-06  
Propeller wrench



H501S-26  
USB cable



H501A-04  
HT005 relay



H216A-05  
HT009 transmitter



H501M-01  
HT011A-B  
transmitter (Black)

Please read the operating instructions carefully before use!



- Never leave units unattended when charging
- Unplug the charging cable immediately after charging
- Propellers may cause injury
- This product is not a toy
- Not suitable for children under 14 years of age

[WWW.HUBSAN.COM](http://WWW.HUBSAN.COM)

Product Name: X4 Air Basic Edition

Product Standard Number: Q/HBS 001-2017

Vendor: Shenzhen Hubsan Technology Co., Ltd

Address: 13th Floor, Block C, Shenzhen Software Industrial Base,  
Xuefu Road, Nanshan District, Shenzhen, Guangdong Province, China

Manufacturer: Dongguan Teng Sheng Industrial Co., Ltd.

Address: Dongguan City, Guangdong Province, Tangxia Tianke Branch City Road, A22

Telephone: 0769-82776166 (China)

### **Federal Communication Commission (FCC) Radiation Exposure Statement**

The device has been evaluated to meet general RF exposure requirement, The device can be used in portable exposure condition without restriction Federal Communication Commission (FCC) Radiation Exposure Statement Power is so low that no RF exposure calculation is needed.

This device complies with part 15 of the FCC rules. Operation is subject to the following two conditions: (1) this device may not cause harmful interference, and (2) this device must accept any interference received, including interference that may cause undesired operation.

NOTE: The manufacturer is not responsible for any radio or TV interference caused by unauthorized modifications or changes to this equipment. Such modifications or changes could void the user's authority to operate the equipment.

NOTE: This equipment has been tested and found to comply with the limits for a Class B digital device, pursuant to part 15 of the FCC Rules. These limits are designed to provide reasonable protection against harmful interference in a residential installation. This equipment generates uses and can radiate radio frequency energy and, if not installed and used in accordance with the instructions, may cause harmful interference to radio communications. However, there is no guarantee that interference will not occur in a particular installation. If this equipment does cause harmful interference to radio or television reception, which can be determined by turning the equipment off and on, the user is encouraged to try to correct the interference by one or more of the following measures:

- Reorient or relocate the receiving antenna.
- Increase the separation between the equipment and receiver.
- Connect the equipment into an outlet on a circuit different from that to which the receiver is connected.
- Consult the dealer or an experienced radio/TV technician for help.

### 15.21

FCC Caution: Any changes or modifications not expressly approved by the party responsible for compliance could void the user's authority to operate this equipment.