

RADIO TEST REPORT

FCC ID: 2AN6U-YTK-318

Product: wireless speaker
Trade Mark: N/A
Model No.: YTK-318
Serial Model: YTK-XXXX (XXXX mean 0001-9999)
Report No.: SER180129011001E
Issue Date: 23 Feb. 2018

Prepared for

Shenzhen HeYouTai Technology Co.,LTD.
No 6, Second Lane, Longhua 5th Industrial Zone, Shangtang
Industrial West Road, Longhua New District, Shenzhen, China

Prepared by

Shenzhen NTEK Testing Technology Co., Ltd.
1/F, Building E, Fenda Science Park, Sanwei Community,
Xixiang Street Bao'an District, Shenzhen 518126 P.R. China
Tel.: +86-755-6115 6588
Fax.: +86-755-6115 6599
Website:<http://www.ntek.org.cn>

TABLE OF CONTENTS

| | | |
|----------|---|-----------|
| 1 | TEST RESULT CERTIFICATION | 3 |
| 2 | SUMMARY OF TEST RESULTS..... | 4 |
| 3 | FACILITIES AND ACCREDITATIONS | 5 |
| 3.1 | FACILITIES..... | 5 |
| 3.2 | LABORATORY ACCREDITATIONS AND LISTINGS | 5 |
| 3.3 | MEASUREMENT UNCERTAINTY | 5 |
| 4 | GENERAL DESCRIPTION OF EUT | 6 |
| 5 | DESCRIPTION OF TEST MODES | 8 |
| 6 | SETUP OF EQUIPMENT UNDER TEST | 9 |
| 6.1 | BLOCK DIAGRAM CONFIGURATION OF TEST SYSTEM..... | 9 |
| 6.2 | SUPPORT EQUIPMENT..... | 10 |
| 6.3 | EQUIPMENTS LIST FOR ALL TEST ITEMS..... | 11 |
| 7 | TEST REQUIREMENTS..... | 13 |
| 7.1 | CONDUCTED EMISSIONS TEST | 13 |
| 7.2 | RADIATED SPURIOUS EMISSION | 18 |
| 7.3 | NUMBER OF HOPPING CHANNEL..... | 27 |
| 7.4 | HOPPING CHANNEL SEPARATION MEASUREMENT | 29 |
| 7.5 | AVERAGE TIME OF OCCUPANCY (DWELL TIME) | 33 |
| 7.6 | 20DB BANDWIDTH TEST | 37 |
| 7.7 | PEAK OUTPUT POWER | 41 |
| 7.8 | CONDUCTED BAND EDGE MEASUREMENT..... | 45 |
| 7.9 | SPURIOUS RF CONDUCTED EMISSION..... | 49 |
| 7.10 | ANTENNA APPLICATION | 53 |



1 TEST RESULT CERTIFICATION

| | |
|-----------------------------------|---|
| Applicant's name | Shenzhen HeYouTai Technology Co.,LTD. |
| Address | No 6, Second Lane, Longhua 5th Industrial Zone, Shangtang Industrial West Road, Longhua New District, Shenzhen, China |
| Manufacturer's Name | Shenzhen HeYouTai Technology Co.,LTD. |
| Address | No 6, Second Lane, Longhua 5th Industrial Zone, Shangtang Industrial West Road, Longhua New District, Shenzhen, China |
| Product description | |
| Product name | wireless speaker |
| Model and/or type reference | YTK-318 |
| Serial Model | YTK-XXXX (XXXX mean 0001-9999) |

Measurement Procedure Used:

| APPLICABLE STANDARDS | |
|---|-------------|
| STANDARD/ TEST PROCEDURE | TEST RESULT |
| FCC 47 CFR Part 2, Subpart J FCC 47 CFR Part 15, Subpart C KDB 174176 D01 Line Conducted FAQ v01r01 ANSI C63.10-2013 | Complied |

This device described above has been tested by Shenzhen NTEK Testing Technology Co., Ltd., and the test results show that the equipment under test (EUT) is in compliance with the FCC requirements. And it is applicable only to the tested sample identified in the report.

This report shall not be reproduced except in full, without the written approval of Shenzhen NTEK Testing Technology Co., Ltd., this document may be altered or revised by Shenzhen NTEK Testing Technology Co., Ltd., personnel only, and shall be noted in the revision of the document.

The test results of this report relate only to the tested sample identified in this report.

Date of Test : 29 Jan. 2018 ~ 23 Feb. 2018

Testing Engineer : *Allen Liu*
(Allen Liu)

Technical Manager : *Jason Chen*
(Jason Chen)

Authorized Signatory : *Sam Chen*
(Sam Chen)

2 SUMMARY OF TEST RESULTS

| FCC Part15 (15.247), Subpart C | | | |
|--------------------------------|-----------------------------|---------|--------|
| Standard Section | Test Item | Verdict | Remark |
| 15.207 | Conducted Emission | PASS | |
| 15.247(c) | Radiated Spurious Emission | PASS | |
| 15.247(a)(1) | Hopping Channel Separation | PASS | |
| 15.247(b)(1) | Peak Output Power | PASS | |
| 15.247(a)(iii) | Number of Hopping Frequency | PASS | |
| 15.247(a)(iii) | Dwell Time | PASS | |
| 15.247(a)(1) | Bandwidth | PASS | |
| 15.205 | Band Edge Emission | PASS | |
| 15.203 | Antenna Requirement | PASS | |

Remark:

1. "N/A" denotes test is not applicable in this Test Report.
2. All test items were verified and recorded according to the standards and without any deviation during the test.

3 FACILITIES AND ACCREDITATIONS

3.1 FACILITIES

All measurement facilities used to collect the measurement data are located at 1/F, Building E, Fenda Science Park, Sanwei Community, Xixiang Street, Bao'an District, Shenzhen 518126 P.R. China.

The sites are constructed in conformance with the requirements of ANSI C63.7, ANSI C63.10 and CISPR Publication 22.

3.2 LABORATORY ACCREDITATIONS AND LISTINGS

Site Description

CNAS-Lab. : The Laboratory has been assessed and proved to be in compliance with CNAS-CL01:2006 (identical to ISO/IEC 17025:2005)
The Certificate Registration Number is L5516.

IC-Registration

The Certificate Registration Number is 9270A-1.

FCC- Accredited

Test Firm Registration Number: 463705.

Designation Number: CN1184

A2LA-Lab.

The Certificate Registration Number is 4298.01

This laboratory is accredited in accordance with the recognized International Standard ISO/IEC 17025:2005 General requirements for the competence of testing and calibration laboratories.

This accreditation demonstrates technical competence for a defined scope and the operation of a laboratory quality management system (refer to joint ISO-ILAC-IAF Communiqué dated 8 January 2009).

Name of Firm

: Shenzhen NTEK Testing Technology Co., Ltd.

Site Location

: 1/F, Building E, Fenda Science Park, Sanwei Community, Xixiang Street, Bao'an District, Shenzhen 518126 P.R. China.

3.3 MEASUREMENT UNCERTAINTY

The reported uncertainty of measurement $y \pm U$, where expanded uncertainty U is based on a standard uncertainty multiplied by a coverage factor of $k=2$, providing a level of confidence of approximately 95 %.

| No. | Item | Uncertainty |
|-----|-------------------------------------|-------------------------|
| 1 | Conducted Emission Test | $\pm 2.80\text{dB}$ |
| 2 | RF power, conducted | $\pm 0.16\text{dB}$ |
| 3 | Spurious emissions, conducted | $\pm 0.21\text{dB}$ |
| 4 | All emissions, radiated(30MHz~1GHz) | $\pm 2.64\text{dB}$ |
| 5 | All emissions, radiated(1GHz~6GHz) | $\pm 2.40\text{dB}$ |
| 6 | All emissions, radiated(>6GHz) | $\pm 2.52\text{dB}$ |
| 7 | Temperature | $\pm 0.5^\circ\text{C}$ |
| 8 | Humidity | $\pm 2\%$ |

4 GENERAL DESCRIPTION OF EUT

| Product Feature and Specification | |
|-----------------------------------|---|
| Equipment | wireless speaker |
| Trade Mark | N/A |
| FCC ID | 2AN6U-YTK-318 |
| Model No. | YTK-318 |
| Serial Model | YTK-XXXX (XXXX mean 0001-9999) |
| Model Difference | All models are the same circuit and RF module, except the appearance. |
| Operating Frequency | 2402MHz~2480MHz |
| Modulation | GFSK, $\pi/4$ -DQPSK, 8-DPSK |
| Bluetooth Version | 4.2+EDR |
| Number of Channels | 79 Channels |
| Antenna Type | PCB Antenna |
| Antenna Gain | 1 dBi |
| Power supply | <input checked="" type="checkbox"/> DC supply: DC 3.7V/300mAh from Battery or DC 5V from USB Port. |
| | <input type="checkbox"/> Adapter supply: |
| HW Version | HSC-S08U-S-V2.01 |
| SW Version | s08u_en_lxw_d220170216_01_release |

Note: Based on the application, features, or specification exhibited in User's Manual, the EUT is considered as an ITE/Computing Device. More details of EUT technical specification, please refer to the User's Manual.



Revision History

| Report No. | Version | Description | Issued Date |
|------------------|---------|-------------------------|--------------|
| SER180129011001E | Rev.01 | Initial issue of report | Feb 23, 2018 |
| | | | |
| | | | |
| | | | |
| | | | |
| | | | |
| | | | |
| | | | |
| | | | |
| | | | |
| | | | |
| | | | |
| | | | |
| | | | |
| | | | |
| | | | |
| | | | |
| | | | |
| | | | |
| | | | |
| | | | |
| | | | |

5 DESCRIPTION OF TEST MODES

To investigate the maximum EMI emission characteristics generates from EUT, the test system was pre-scanning tested base on the consideration of following EUT operation mode or test configuration mode which possible have effect on EMI emission level. Each of these EUT operation mode(s) or test configuration mode(s) mentioned above was evaluated respectively.

The Transmitter was operated in the normal operating mode. The TX frequency was fixed which was for the purpose of the measurements.

Test of channel included the lowest and middle and highest frequency to perform the test, then record on this report.

Those data rates (1Mbps for GFSK modulation; 2Mbps for $\pi/4$ -DQPSK modulation; 3Mbps for 8-DPSK modulation) were used for all test.

The EUT was pretested with 3 orientations placed on the table for the radiated emission measurement –X, Y, and Z-plane. The X-plane results were found as the worst case and were shown in this report.

Carrier Frequency and Channel list:

| Channel | Frequency(MHz) |
|---------|----------------|
| 0 | 2402 |
| 1 | 2403 |
| ... | ... |
| 39 | 2441 |
| 40 | 2442 |
| ... | ... |
| 77 | 2479 |
| 78 | 2480 |

Note: $f_c=2402\text{MHz}+k \times 1\text{MHz}$ $k=0$ to 78

The following summary table is showing all test modes to demonstrate in compliance with the standard.

| For AC Conducted Emission | |
|---------------------------|------------------|
| Final Test Mode | Description |
| Mode 1 | normal link mode |

Note: AC power line Conducted Emission was tested under maximum output power.

| For Radiated Test Cases | |
|-------------------------|------------------|
| Final Test Mode | Description |
| Mode 1 | normal link mode |
| Mode 2 | CH00(2402MHz) |
| Mode 3 | CH39(2441MHz) |
| Mode 4 | CH78(2480MHz) |

Note: For radiated test cases, the worst mode data rate 3Mbps was reported only, because this data rate has the highest RF output power at preliminary tests, and no other significantly frequencies found in conducted spurious emission.

| For Conducted Test Cases | |
|--------------------------|---------------|
| Final Test Mode | Description |
| Mode 2 | CH00(2402MHz) |
| Mode 3 | CH39(2441MHz) |
| Mode 4 | CH78(2480MHz) |
| Mode 5 | Hopping mode |

Note: The engineering test program was provided and the EUT was programmed to be in continuously transmitting mode.

1. AC power line Conducted Emission was tested under maximum output power.

6 SETUP OF EQUIPMENT UNDER TEST

6.1 BLOCK DIAGRAM CONFIGURATION OF TEST SYSTEM

For AC Conducted Emission Mode

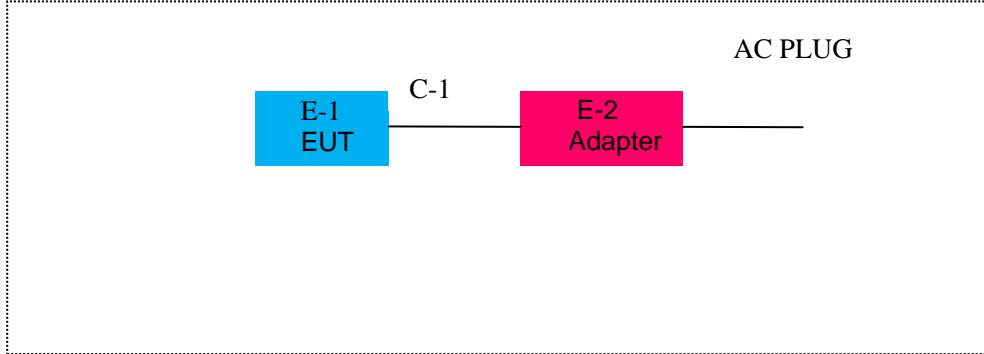

For Radiated Test Cases

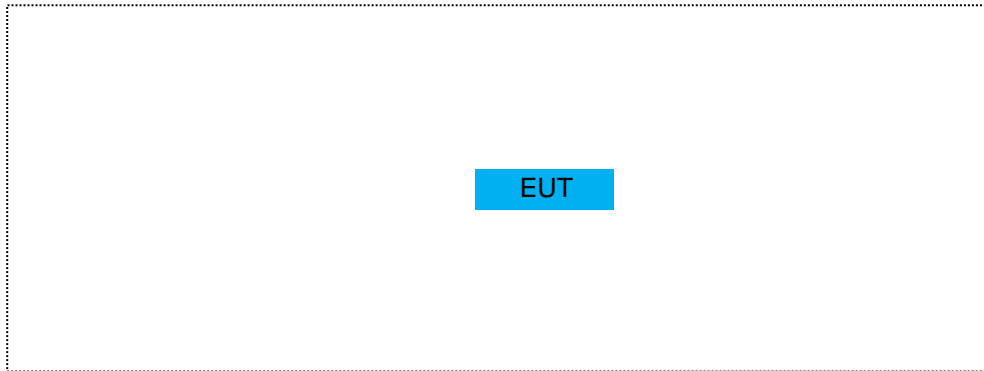

For Conducted Test Cases

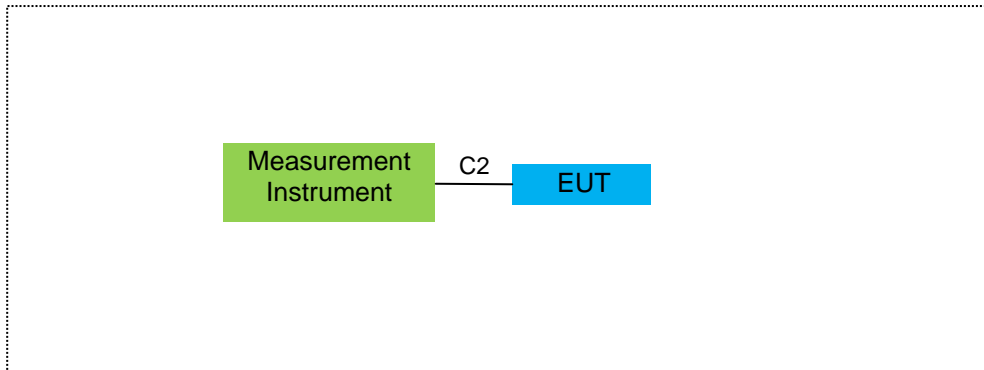

Note: The temporary antenna connector is soldered on the PCB board in order to perform conducted tests and this temporary antenna connector is listed in the equipment list.

6.2 SUPPORT EQUIPMENT

The EUT has been tested as an independent unit together with other necessary accessories or support units. The following support units or accessories were used to form a representative test configuration during the tests.

| Item | Equipment | Mfr/Brand | Model/Type No. | FCC ID | Note |
|------|------------------|-----------|----------------|---------------|-------------|
| E-1 | wireless speaker | N/A | YTK-318 | 2AN6U-YTK-318 | EUT |
| E-2 | Adapter | N/A | Polaroid | N/A | Peripherals |
| | | | | | |
| | | | | | |

| Item | Cable Type | Shielded Type | Ferrite Core | Length |
|------|------------|---------------|--------------|--------|
| C-1 | USB Cable | NO | NO | 1.2m |
| C-2 | RF Cable | NO | NO | 0.5m |
| | | | | |
| | | | | |
| | | | | |

Notes:

- (1) The support equipment was authorized by Declaration of Confirmation.
- (2) For detachable type I/O cable should be specified the length in cm in 『Length』 column.
- (3) “YES” is means “shielded” “with core”; “NO” is means “unshielded” “without core”.

6.3 EQUIPMENTS LIST FOR ALL TEST ITEMS

Radiation Test equipment

| Item | Kind of Equipment | Manufacturer | Type No. | Serial No. | Last calibration | Calibrated until | Calibration period |
|------|------------------------------------|--------------|---------------|---------------|------------------|------------------|--------------------|
| 1 | Spectrum Analyzer | Agilent | E4407B | MY45108040 | 2017.06.06 | 2018.06.05 | 1 year |
| 2 | Spectrum Analyzer | Agilent | N9020A | MY49100060 | 2017.11.10 | 2018.11.09 | 1 year |
| 3 | EMI Test Receiver | Agilent | N9038A | MY53227146 | 2017.06.06 | 2018.06.05 | 1 year |
| 4 | Test Receiver | R&S | ESPI | 101318 | 2017.06.06 | 2018.06.05 | 1 year |
| 5 | Bilog Antenna | TESEQ | CBL6111D | 31216 | 2017.04.09 | 2018.04.08 | 1 year |
| 6 | 50Ω Coaxial Switch | Anritsu | MP59B | 6200983705 | 2017.06.06 | 2018.06.05 | 1 year |
| 7 | Horn Antenna | EM | EM-AH-10180 | 2011071402 | 2017.04.09 | 2018.04.08 | 1 year |
| 8 | Horn Ant | Schwarzbeck | BBHA 9170 | 9170-181 | 2017.07.06 | 2018.07.05 | 1 year |
| 9 | Amplifier | EMC | EMC051835SE | 980246 | 2017.08.09 | 2018.08.08 | 1 year |
| 10 | Amplifier | MITEQ | TTA1840-35-HG | 177156 | 2017.06.06 | 2018.06.05 | 1 year |
| 11 | Loop Antenna | ARA | PLA-1030/B | 1029 | 2017.06.06 | 2018.06.05 | 1 year |
| 12 | Power Meter | DARE | RPR3006W | 15I00041SN084 | 2017.08.07 | 2018.08.06 | 1 year |
| 13 | Test Cable (9KHz-30MHz) | N/A | R-01 | N/A | 2017.04.21 | 2020.04.20 | 3 year |
| 14 | Test Cable (30MHz-1GHz) | N/A | R-02 | N/A | 2017.04.21 | 2020.04.20 | 3 year |
| 15 | High Test Cable(1G-40G Hz) | N/A | R-03 | N/A | 2017.04.21 | 2020.04.20 | 3 year |
| 16 | High Test Cable(1G-40G Hz) | N/A | R-04 | N/A | 2017.04.21 | 2020.04.20 | 3 year |
| 17 | temporary antenna connector (Note) | NTS | R001 | N/A | N/A | N/A | N/A |

Note:

We will use the temporary antenna connector (soldered on the PCB board) When conducted test And this temporary antenna connector is listed within the instrument list

Conduction Test equipment

| Item | Kind of Equipment | Manufacturer | Type No. | Serial No. | Last calibration | Calibrated until | Calibration period |
|------|-------------------------|--------------|-----------|------------|------------------|------------------|--------------------|
| 1 | Test Receiver | R&S | ESCI | 101160 | 2017.06.06 | 2018.06.05 | 1 year |
| 2 | LISN | R&S | ENV216 | 101313 | 2017.04.19 | 2018.04.18 | 1 year |
| 3 | LISN | SCHWARZBECK | NNLK 8129 | 8129245 | 2017.06.06 | 2018.06.05 | 1 year |
| 4 | 50Ω Coaxial Switch | ANRITSU CORP | MP59B | 6200983704 | 2017.06.06 | 2018.06.05 | 1 year |
| 5 | Test Cable (9KHz-30MHz) | N/A | C01 | N/A | 2017.04.21 | 2020.04.20 | 3 year |
| 6 | Test Cable (9KHz-30MHz) | N/A | C02 | N/A | 2017.04.21 | 2020.04.20 | 3 year |
| 7 | Test Cable (9KHz-30MHz) | N/A | C03 | N/A | 2017.04.21 | 2020.04.20 | 3 year |

| | | | | | | | |
|---|--------|----------|---------|----|------------|------------|--------|
| 1 | Filter | TRILTHIC | 2400MHz | 29 | 2017.04.19 | 2018.04.18 | 1 year |
|---|--------|----------|---------|----|------------|------------|--------|

Note: Each piece of equipment is scheduled for calibration once a year except the Test Cable which is scheduled for calibration every 3 years.

7 TEST REQUIREMENTS

7.1 CONDUCTED EMISSIONS TEST

7.1.1 Applicable Standard

According to FCC Part 15.207(a) and KDB 174176 D01 Line Conducted FAQ v01r01

7.1.2 Conformance Limit

| Frequency(MHz) | Conducted Emission Limit | |
|----------------|--------------------------|---------|
| | Quasi-peak | Average |
| 0.15-0.5 | 66-56* | 56-46* |
| 0.5-5.0 | 56 | 46 |
| 5.0-30.0 | 60 | 50 |

Note: 1. *Decreases with the logarithm of the frequency
 2. The lower limit shall apply at the transition frequencies
 3. The limit decreases in line with the logarithm of the frequency in the range of 0.15 to 0.50MHz.

7.1.3 Test Configuration

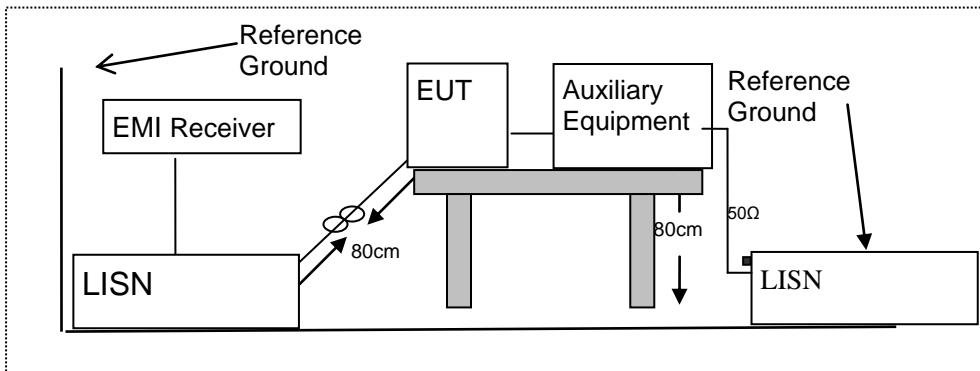

7.1.4 Test Procedure

According to the requirements in Section 13.1.4.1 of ANSI C63.10-2013 Conducted emissions the EUT measured in the frequency range between 0.15 MHz and 30 MHz using CISPR Quasi-Peak and average detector mode.

1. The EUT was placed 0.4 meter from the conducting wall of the shielding room.
2. The EUT was placed on a table which is 0.8m above ground plane.
3. Connect EUT to the power mains through a line impedance stabilization network (LISN). All other support equipments powered from additional LISN(s). The LISN provide 50 Ohm/ 50uH of coupling impedance for the measuring instrument.
4. Interconnecting cables that hang closer than 40 cm to the ground plane shall be folded back and forth in the center forming a bundle 30 to 40cm long.
5. I/O cables that are not connected to a peripheral shall be bundled in the center. The end of the cable may be terminated, if required, using the correct terminating impedance. The overall length shall not exceed 1 m.
6. LISN at least 80 cm from nearest part of EUT chassis.
7. The frequency range from 150KHz to 30MHz was searched.
8. Set the test-receiver system to Peak Detect Function and specified bandwidth(IF bandwidth=9KHz) with Maximum Hold Mode
9. For the actual test configuration, please refer to the related Item –EUT Test Photos.

7.1.5 Test Results

Pass

7.1.6 Test Results

| | | | |
|----------------|---------------------------------|--------------------|---------|
| EUT: | wireless speaker | Model Name : | YTK-318 |
| Temperature: | 18 °C | Relative Humidity: | 38% |
| Pressure: | 1010hPa | Phase : | L |
| Test Voltage : | DC 5V from Adapter AC 120V/60Hz | Test Mode: | Mode 1 |

| Frequency | Reading Level | Correct Factor | Measure-ment | Limits | Margin | Remark |
|-----------|---------------|----------------|--------------|--------------|--------|--------|
| (MHz) | (dB μ V) | (dB) | (dB μ V) | (dB μ V) | (dB) | |
| 0.158 | 33.48 | 9.82 | 43.30 | 65.56 | -22.26 | QP |
| 0.158 | 20.63 | 9.82 | 30.45 | 55.56 | -25.11 | AVG |
| 0.290 | 22.39 | 9.82 | 32.21 | 60.52 | -28.31 | QP |
| 0.290 | 12.43 | 9.82 | 22.25 | 50.52 | -28.27 | AVG |
| 0.550 | 21.88 | 9.83 | 31.71 | 56.00 | -24.29 | QP |
| 0.550 | 11.82 | 9.83 | 21.65 | 46.00 | -24.35 | AVG |
| 0.958 | 16.19 | 9.92 | 26.11 | 56.00 | -29.89 | QP |
| 0.958 | 8.49 | 9.92 | 18.41 | 46.00 | -27.59 | AVG |
| 5.486 | 12.71 | 10.04 | 22.75 | 60.00 | -37.25 | QP |
| 5.486 | 3.50 | 10.04 | 13.54 | 50.00 | -36.46 | AVG |
| 16.014 | 10.41 | 10.22 | 20.63 | 60.00 | -39.37 | QP |
| 16.014 | 2.32 | 10.22 | 12.54 | 50.00 | -37.46 | AVG |

Remark:

1. All readings are Quasi-Peak and Average values.
2. Factor = Insertion Loss + Cable Loss.

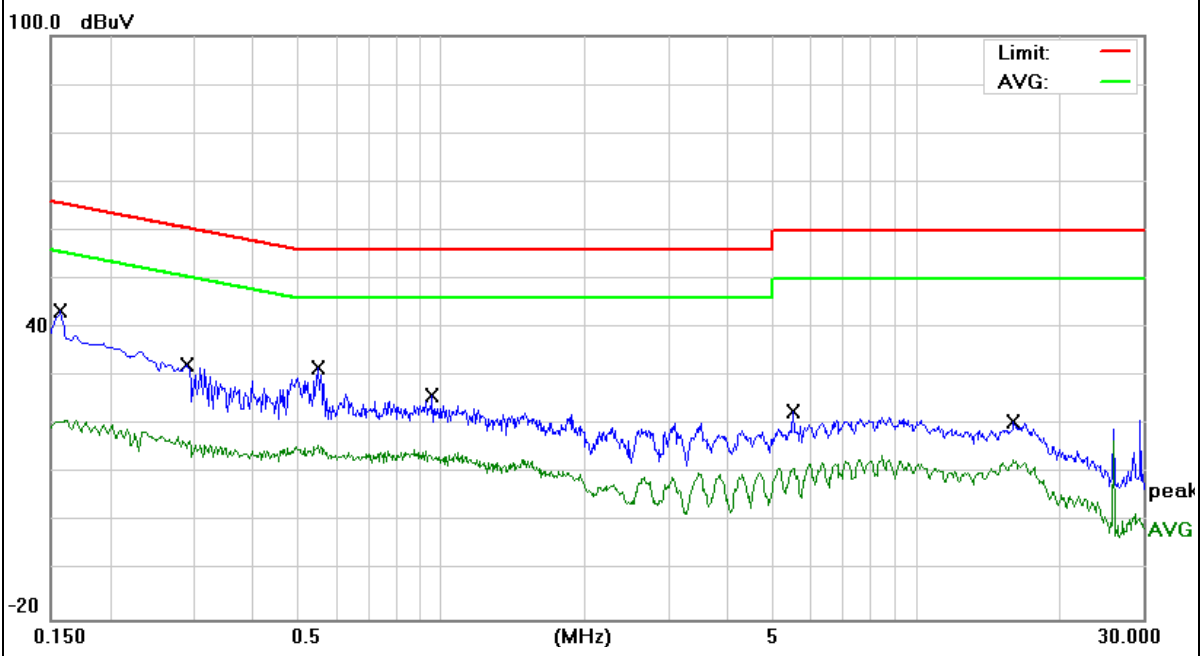

| | | | |
|----------------|---------------------------------|--------------------|---------|
| EUT: | wireless speaker | Model Name : | YTK-318 |
| Temperature: | 18 °C | Relative Humidity: | 38% |
| Pressure: | 1010hPa | Phase : | N |
| Test Voltage : | DC 5V from Adapter AC 120V/60Hz | Test Mode: | Mode 1 |

| Frequency (MHz) | Reading Level (dBμV) | Correct Factor (dB) | Measurement (dBμV) | Limits (dBμV) | Margin (dB) | Remark |
|-----------------|----------------------|---------------------|--------------------|---------------|-------------|--------|
| 0.1819 | 33.89 | 9.92 | 43.81 | 64.39 | -20.58 | QP |
| 0.1819 | 20.10 | 9.92 | 30.02 | 54.39 | -24.37 | AVG |
| 0.2540 | 27.00 | 9.92 | 36.92 | 61.62 | -24.70 | QP |
| 0.2540 | 18.19 | 9.92 | 28.11 | 51.62 | -23.51 | AVG |
| 0.5540 | 27.43 | 9.93 | 37.36 | 56.00 | -18.64 | QP |
| 0.5540 | 15.43 | 9.93 | 25.36 | 46.00 | -20.64 | AVG |
| 0.9619 | 20.09 | 9.93 | 30.02 | 56.00 | -25.98 | QP |
| 0.9619 | 14.09 | 9.93 | 24.02 | 46.00 | -21.98 | AVG |
| 1.8819 | 16.72 | 9.94 | 26.66 | 56.00 | -29.34 | QP |
| 1.8819 | 5.27 | 9.94 | 15.21 | 46.00 | -30.79 | AVG |
| 3.1139 | 14.50 | 9.95 | 24.45 | 56.00 | -31.55 | QP |
| 3.1139 | 3.37 | 9.95 | 13.32 | 46.00 | -32.68 | AVG |

Remark:

- All readings are Quasi-Peak and Average values.
- Factor = Insertion Loss + Cable Loss.

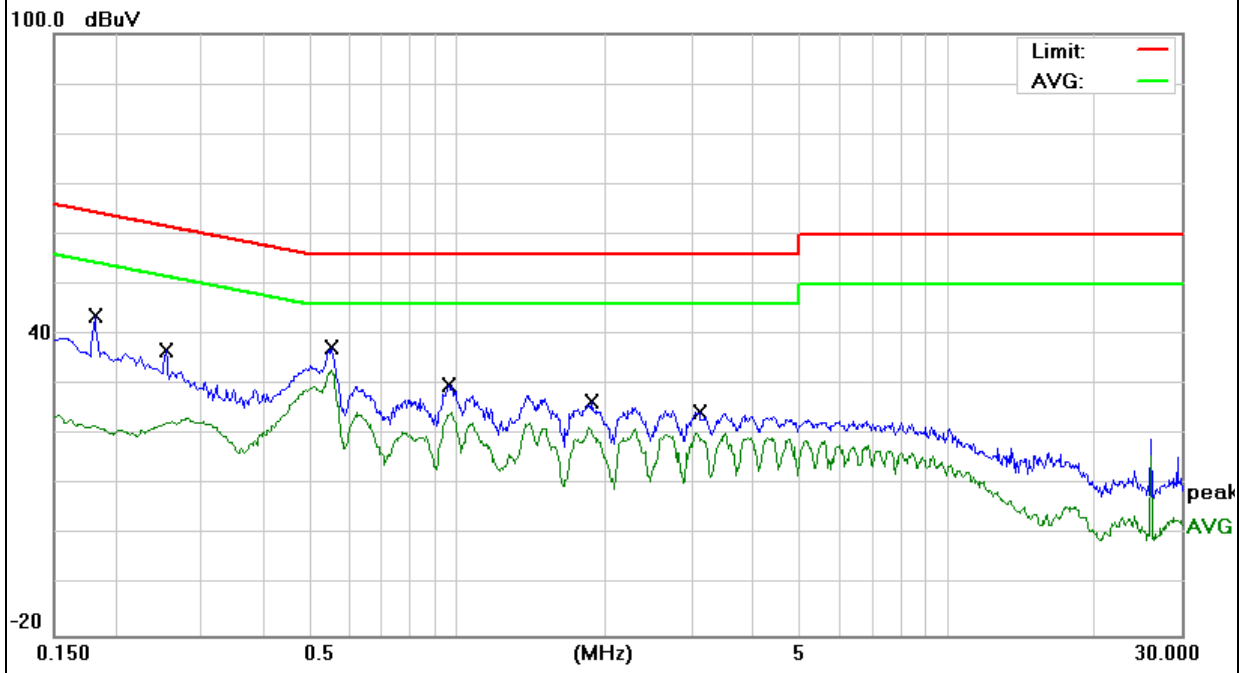

| | | | |
|----------------|---------------------------------|--------------------|---------|
| EUT: | wireless speaker | Model Name : | YTK-318 |
| Temperature: | 18 °C | Relative Humidity: | 38% |
| Pressure: | 1010hPa | Phase : | L |
| Test Voltage : | DC 5V from Adapter AC 240V/60Hz | Test Mode: | Mode 1 |

| Frequency (MHz) | Reading Level (dBμV) | Correct Factor (dB) | Measure-ment (dBμV) | Limits (dBμV) | Margin (dB) | Remark |
|-----------------|----------------------|---------------------|---------------------|---------------|-------------|--------|
| 0.2744 | 20.93 | 9.82 | 30.75 | 60.98 | -30.23 | QP |
| 0.2744 | 10.43 | 9.82 | 20.25 | 50.98 | -30.73 | AVG |
| 0.5540 | 20.28 | 9.83 | 30.11 | 56.00 | -25.89 | QP |
| 0.5540 | 9.52 | 9.83 | 19.35 | 46.00 | -26.65 | AVG |
| 1.9300 | 13.92 | 9.85 | 23.77 | 56.00 | -32.23 | QP |
| 1.9300 | 5.17 | 9.85 | 15.02 | 46.00 | -30.98 | AVG |
| 2.7500 | 13.09 | 10.00 | 23.09 | 56.00 | -32.91 | QP |
| 2.7500 | 2.35 | 10.00 | 12.35 | 46.00 | -33.65 | AVG |
| 3.6220 | 12.34 | 10.05 | 22.39 | 56.00 | -33.61 | QP |
| 3.6220 | 3.31 | 10.05 | 13.36 | 46.00 | -32.64 | AVG |
| 5.2499 | 12.86 | 10.05 | 22.91 | 60.00 | -37.09 | QP |
| 5.2499 | 2.40 | 10.05 | 12.45 | 50.00 | -37.55 | AVG |

Remark:

1. All readings are Quasi-Peak and Average values.
2. Factor = Insertion Loss + Cable Loss.

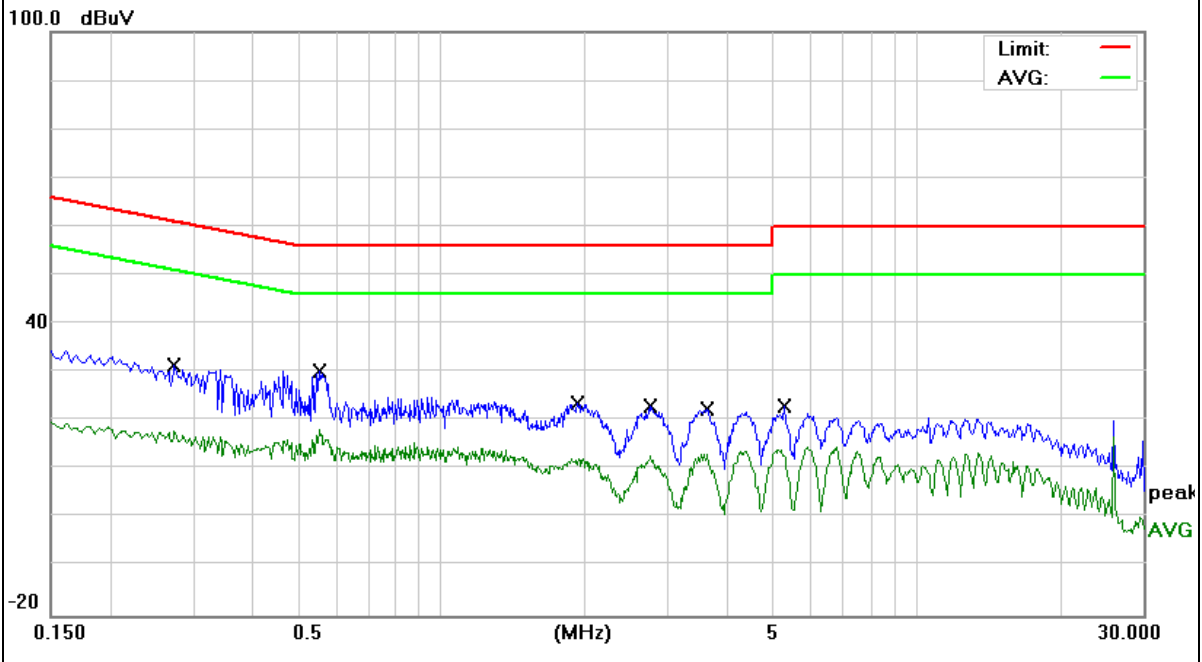

| | | | |
|----------------|---------------------------------|--------------------|---------|
| EUT: | wireless speaker | Model Name : | YTK-318 |
| Temperature: | 18°C | Relative Humidity: | 38% |
| Pressure: | 1010hPa | Phase : | N |
| Test Voltage : | DC 5V from Adapter AC 240V/60Hz | Test Mode: | Mode 1 |

| Frequency (MHz) | Reading Level (dBμV) | Correct Factor (dB) | Measure-ment (dBμV) | Limits (dBμV) | Margin (dB) | Remark |
|-----------------|----------------------|---------------------|---------------------|---------------|-------------|--------|
| 0.470 | 24.40 | 9.93 | 34.33 | 56.51 | -22.18 | QP |
| 0.470 | 11.09 | 9.93 | 21.02 | 46.51 | -25.49 | AVG |
| 0.570 | 28.10 | 9.93 | 38.03 | 56.00 | -17.97 | QP |
| 0.570 | 13.43 | 9.93 | 23.36 | 46.00 | -22.64 | AVG |
| 0.970 | 22.00 | 9.93 | 31.93 | 56.00 | -24.07 | QP |
| 0.970 | 13.38 | 9.93 | 23.31 | 46.00 | -22.69 | AVG |
| 1.870 | 19.01 | 9.94 | 28.95 | 56.00 | -27.05 | QP |
| 1.870 | 10.18 | 9.94 | 20.12 | 46.00 | -25.88 | AVG |
| 2.782 | 17.72 | 9.95 | 27.67 | 56.00 | -28.33 | QP |
| 2.782 | 9.40 | 9.95 | 19.35 | 46.00 | -26.65 | AVG |
| 3.618 | 17.46 | 9.95 | 27.41 | 56.00 | -28.59 | QP |
| 3.618 | 8.50 | 9.95 | 18.45 | 46.00 | -27.55 | AVG |

Remark:

1. All readings are Quasi-Peak and Average values.
2. Factor = Insertion Loss + Cable Loss.

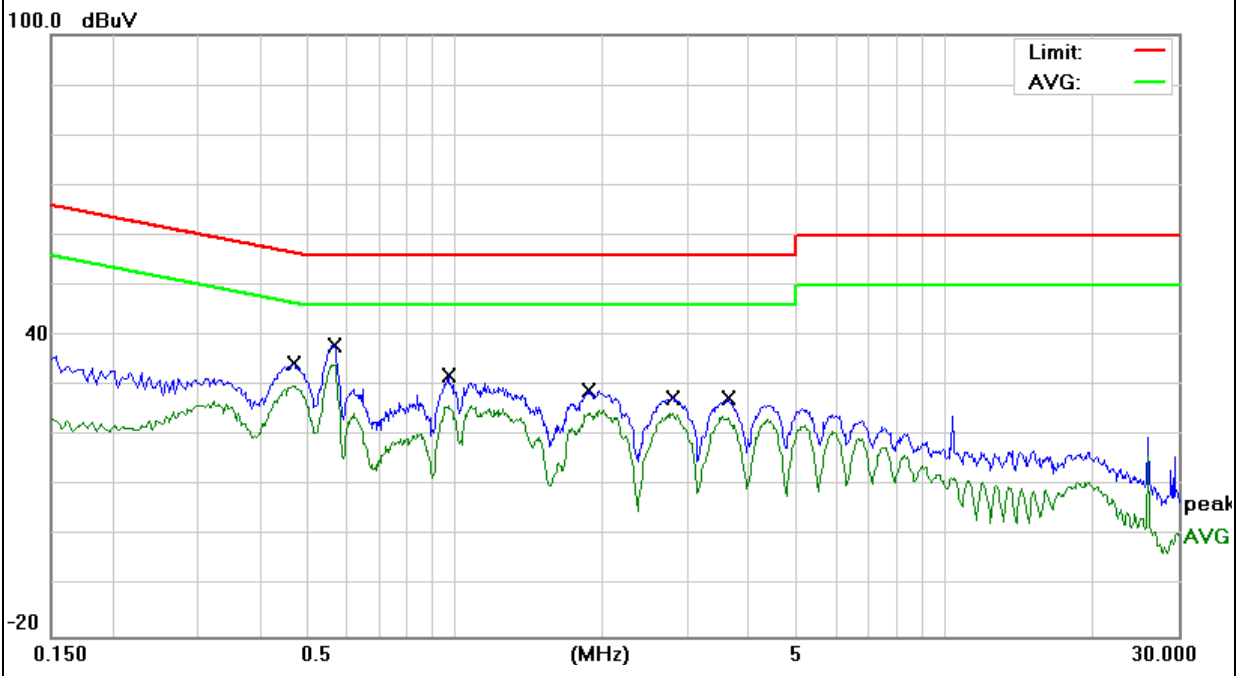

7.2 RADIATED SPURIOUS EMISSION

7.2.1 Applicable Standard

According to FCC Part 15.247(d) and 15.209 and ANSI C63.10-2013

7.2.2 Conformance Limit

According to FCC Part 15.247(d): radiated emissions which fall in the restricted bands, as defined in §15.205(a), must also comply with the radiated emission limits specified in §15.209(a) (see §15.205(c)). According to FCC Part 15.205, Restricted bands

| MHz | MHz | MHz | GHz |
|-------------------|---------------------|---------------|-------------|
| 0.090-0.110 | 16.42-16.423 | 399.9-410 | 4.5-5.15 |
| 10.495-0.505 | 16.69475-16.69525 | 608-614 | 5.35-5.46 |
| 2.1735-2.1905 | 16.80425-16.80475 | 960-1240 | 7.25-7.75 |
| 4.125-4.128 | 25.5-25.67 | 1300-1427 | 8.025-8.5 |
| 4.17725-4.17775 | 37.5-38.25 | 1435-1626.5 | 9.0-9.2 |
| 4.20725-4.20775 | 73-74.6 | 1645.5-1646.5 | 9.3-9.5 |
| 6.215-6.218 | 74.8-75.2 | 1660-1710 | 10.6-12.7 |
| 6.26775-6.26825 | 123-138 | 2200-2300 | 14.47-14.5 |
| 8.291-8.294 | 149.9-150.05 | 2310-2390 | 15.35-16.2 |
| 8.362-8.366 | 156.52475-156.52525 | 2483.5-2500 | 17.7-21.4 |
| 8.37625-8.38675 | 156.7-156.9 | 2690-2900 | 22.01-23.12 |
| 8.41425-8.41475 | 162.0125-167.17 | 3260-3267 | 23.6-24.0 |
| 12.29-12.293 | 167.72-173.2 | 3332-3339 | 31.2-31.8 |
| 12.51975-12.52025 | 240-285 | 3345.8-3358 | 36.43-36.5 |
| 12.57675-12.57725 | 322-335.4 | 3600-4400 | (2) |
| 13.36-13.41 | | | |

20dBc in any 100 kHz bandwidth outside the operating frequency band. In case the emission fall within the restricted band specified on 15.205(a), then the 15.209(a) limit in the table below has to be followed.

| Restricted Frequency(MHz) | Field Strength (µV/m) | Field Strength (dBµV/m) | Measurement Distance |
|---------------------------|-----------------------|-------------------------|----------------------|
| 0.009~0.490 | 2400/F(KHz) | 20 log (uV/m) | 300 |
| 0.490~1.705 | 2400/F(KHz) | 20 log (uV/m) | 30 |
| 1.705~30.0 | 30 | 29.5 | 30 |
| 30-88 | 100 | 40 | 3 |
| 88-216 | 150 | 43.5 | 3 |
| 216-960 | 200 | 46 | 3 |
| Above 960 | 500 | 54 | 3 |

Limits of Radiated Emission Measurement(Above 1000MHz)

| Frequency(MHz) | Class B (dBuV/m) (at 3M) | |
|----------------|--------------------------|---------|
| | PEAK | AVERAGE |
| Above 1000 | 74 | 54 |

- Remark :
1. Emission level in dBuV/m=20 log (uV/m)
 2. Measurement was performed at an antenna to the closed point of EUT distance of meters.
 3. Distance extrapolation factor =40log(Specific distance/ test distance)(dB);
Limit line=Specific limits(dBuV) + distance extrapolation factor.

7.2.3 Measuring Instruments

The Measuring equipment is listed in the section 6.3 of this test report.

7.2.4 Test Configuration

(a) For radiated emissions below 30MHz

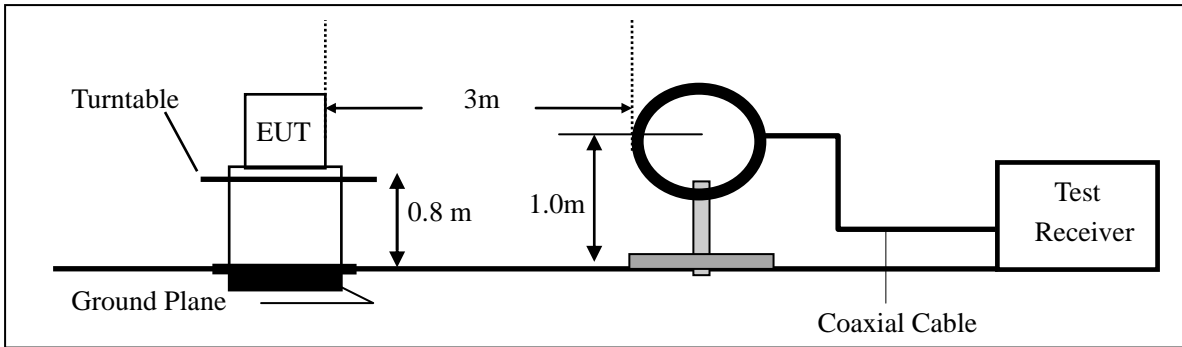

(b) For radiated emissions from 30MHz to 1000MHz

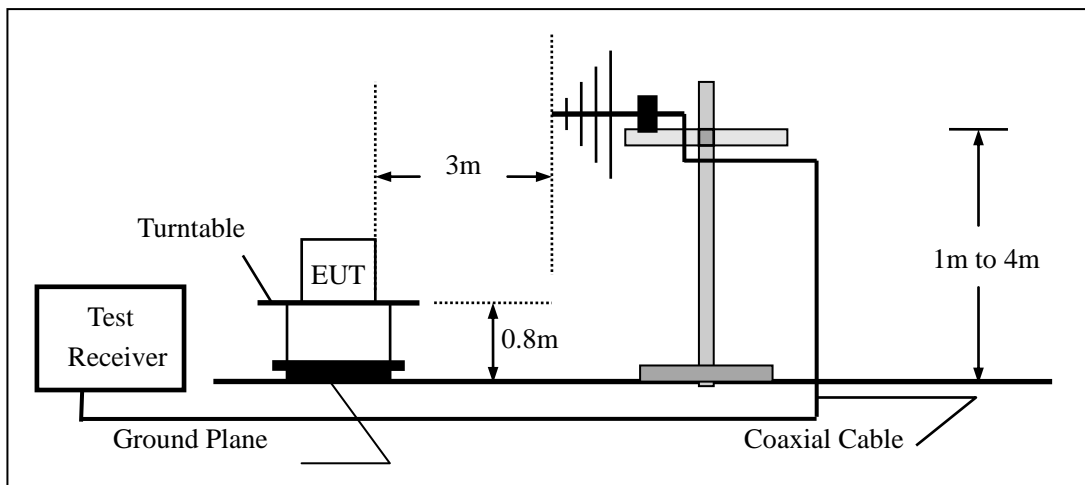

(c) For radiated emissions above 1000MHz

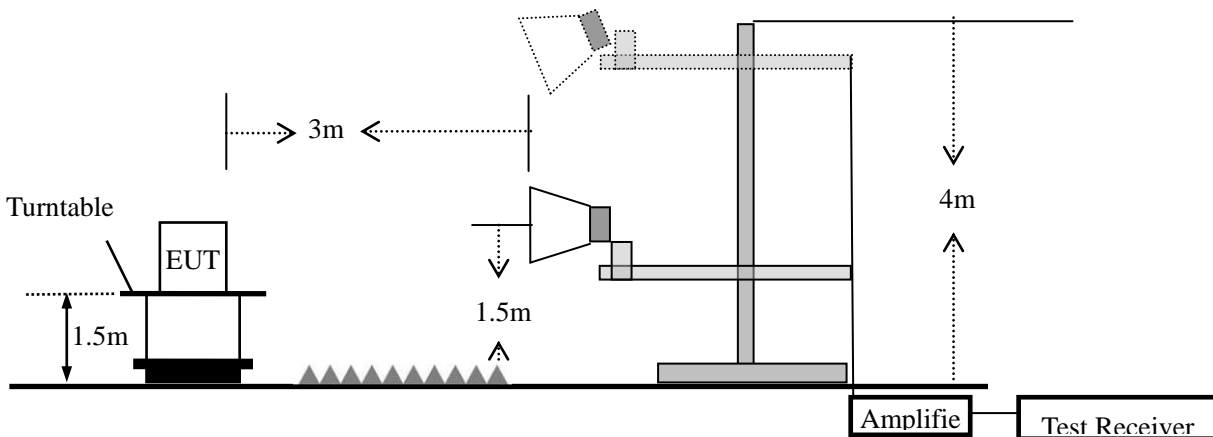

7.2.5 Test Procedure

The test site semi-anechoic chamber has met the requirement of NSA tolerance 4 dB according to the standards: ANSI C63.10-2013. The test distance is 3m. The setup is according to the requirements in Section 13.1.4.1 of ANSI C63.10-2013 and CAN/CSA-CEI/IEC CISPR 22.

This test is required for any spurious emission that falls in a Restricted Band, as defined in Section 15.205. It must be performed with the highest gain of each type of antenna proposed for use with the EUT.

Use the following spectrum analyzer settings:

| Spectrum Parameter | Setting |
|---------------------------------------|--|
| Attenuation | Auto |
| Start Frequency | 1000 MHz |
| Stop Frequency | 10th carrier harmonic |
| RB / VB (emission in restricted band) | 1 MHz / 1 MHz for Peak, 1 MHz / 10Hz for Average |

| Receiver Parameter | Setting |
|------------------------|----------------------------------|
| Attenuation | Auto |
| Start ~ Stop Frequency | 9kHz~150kHz / RB 200Hz for QP |
| Start ~ Stop Frequency | 150kHz~30MHz / RB 9kHz for QP |
| Start ~ Stop Frequency | 30MHz~1000MHz / RB 120kHz for QP |

- a. The measuring distance of at 3 m shall be used for measurements at frequency up to 1GHz. For frequencies above 1GHz, any suitable measuring distance may be used.
- b. The EUT was placed on the top of a rotating table 0.8 m for below 1GHz and 1.5m for above 1GHz the ground at a 3 meter. The table was rotated 360 degrees to determine the position of the highest radiation.
- c. The height of the equipment or of the substitution antenna shall be 0.8 m for below 1GHz and 1.5m for above 1GHz; the height of the test antenna shall vary between 1 m to 4 m. Both horizontal and vertical polarizations of the antenna are set to make the measurement.
- d. For the radiated emission test above 1GHz:
Place the measurement antenna away from each area of the EUT determined to be a source of emissions at the specified measurement distance, while keeping the measurement antenna aimed at the source of emissions at each frequency of significant emissions, with polarization oriented for maximum response. The measurement antenna may have to be higher or lower than the EUT, depending on the radiation pattern of the emission and staying aimed at the emission source for receiving the maximum signal. The final measurement antenna elevation shall be that which maximizes the emissions. The measurement antenna elevation for maximum emissions shall be restricted to a range of heights of from 1 m to 4 m above the ground or reference ground plane.
- e. The initial step in collecting conducted emission data is a spectrum analyzer peak detector mode pre-scanning the measurement frequency range. Significant peaks are then marked and then Quasi Peak detector mode re-measured.
- f. If the Peak Mode measured value compliance with and lower than Quasi Peak Mode Limit, the EUT shall be deemed to meet QP Limits and then no additional QP Mode measurement performed.
- g. For the actual test configuration, please refer to the related Item –EUT Test Photos.

Note:

Both horizontal and vertical antenna polarities were tested and performed pretest to three orthogonal axis. The worst case emissions were reported

During the radiated emission test, the Spectrum Analyzer was set with the following configurations:

| Frequency Band (MHz) | Function | Resolution bandwidth | Video Bandwidth |
|----------------------|----------|----------------------|-----------------|
| 30 to 1000 | QP | 120 kHz | 300 kHz |
| Above 1000 | Peak | 1 MHz | 1 MHz |
| | Average | 1 MHz | 10 Hz |

Note: for the frequency ranges below 30 MHz, a narrower RBW is used for these ranges but the measured value should add a RBW correction factor (RBWCF) where $RBWCF [dB] = 10 * \lg(100 [kHz] / \text{narrower RBW [kHz]})$. , the narrower RBW is 1 kHz and RBWCF is 20 dB for the frequency 9 kHz to 150 kHz, and the narrower RBW is 10 kHz and RBWCF is 10 dB for the frequency 150 kHz to 30 MHz.

7.2.6 Test Results

■ Spurious Emission below 30MHz (9KHz to 30MHz)

| | | | |
|--------------|-------------------|--------------------|-----------|
| EUT: | wireless speaker | Model No.: | YTK-318 |
| Temperature: | 20 °C | Relative Humidity: | 48% |
| Test Mode: | Mode2/Mode3/Mode4 | Test By: | Allen Liu |

| Freq. (MHz) | Ant.Pol. H/V | Emission Level(dBuV/m) | | Limit 3m(dBuV/m) | | Over(dB) | |
|-------------|--------------|------------------------|----|------------------|----|----------|----|
| | | PK | AV | PK | AV | PK | AV |
| -- | -- | -- | -- | -- | -- | -- | -- |

Note: the amplitude of spurious emission that is attenuated by more than 20dB below the permissible limit has no need to be reported.

Distance extrapolation factor = $20 \log(\text{Specific distance} / \text{test distance})$ (dB);

Limit line = Specific limits(dBuV) + distance extrapolation factor

■ Spurious Emission below 1GHz (30MHz to 1GHz)

All the modulation modes have been tested, and the worst result was report as below:

| | | | |
|----------------|------------------|--------------------|---------|
| EUT: | wireless speaker | Model Name : | YTK-318 |
| Temperature: | 23°C | Relative Humidity: | 36% |
| Pressure: | 1010hPa | Test Mode: | Mode 1 |
| Test Voltage : | DC 3.7V | | |

| Polar (H/V) | Frequency | Meter Reading | Factor | Emission Level | Limits | Margin | Remark |
|-------------|-----------|---------------|--------|----------------|----------|--------|--------|
| | (MHz) | (dBuV) | (dB) | (dBuV/m) | (dBuV/m) | (dB) | |
| V | 49.3594 | 13.28 | 13.35 | 26.63 | 40.00 | -13.37 | QP |
| V | 77.8654 | 14.51 | 11.54 | 26.05 | 40.00 | -13.95 | QP |
| V | 118.6014 | 16.32 | 10.46 | 26.78 | 43.50 | -16.72 | QP |
| V | 197.8928 | 20.40 | 13.75 | 34.15 | 43.50 | -9.35 | QP |
| V | 394.8545 | 25.24 | 15.09 | 40.33 | 46.00 | -5.67 | QP |
| V | 533.8321 | 19.25 | 17.95 | 37.20 | 46.00 | -8.80 | QP |

Remark:

Absolute Level= ReadingLevel+ Factor, Margin= Absolute Level - Limit

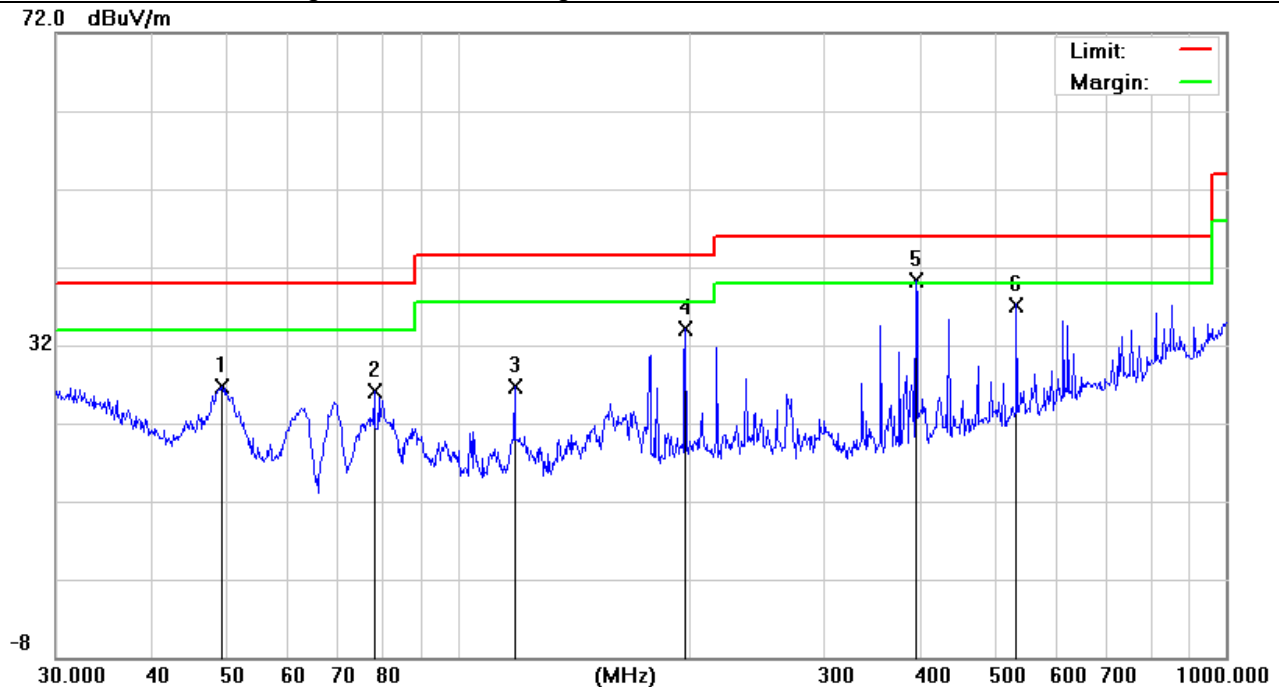

| Polar (H/V) | Frequency | Meter Reading | Factor | Emission Level | Limits | Margin | Remark |
|-------------|-----------|---------------|--------|----------------|----------|--------|--------|
| | (MHz) | (dBuV) | (dB) | (dBuV/m) | (dBuV/m) | (dB) | |
| H | 158.1123 | 23.47 | 11.84 | 35.31 | 43.50 | -8.19 | QP |
| H | 197.8928 | 24.62 | 13.75 | 38.37 | 43.50 | -5.13 | QP |
| H | 217.5442 | 23.66 | 12.74 | 36.40 | 46.00 | -9.60 | QP |
| H | 256.5211 | 28.34 | 12.65 | 40.99 | 46.00 | -5.01 | QP |
| H | 394.8545 | 27.40 | 15.09 | 42.49 | 46.00 | -3.51 | QP |
| H | 872.1832 | 12.06 | 25.93 | 37.99 | 46.00 | -8.01 | QP |

Remark:

Absolute Level= ReadingLevel+ Factor, Margin= Absolute Level - Limit

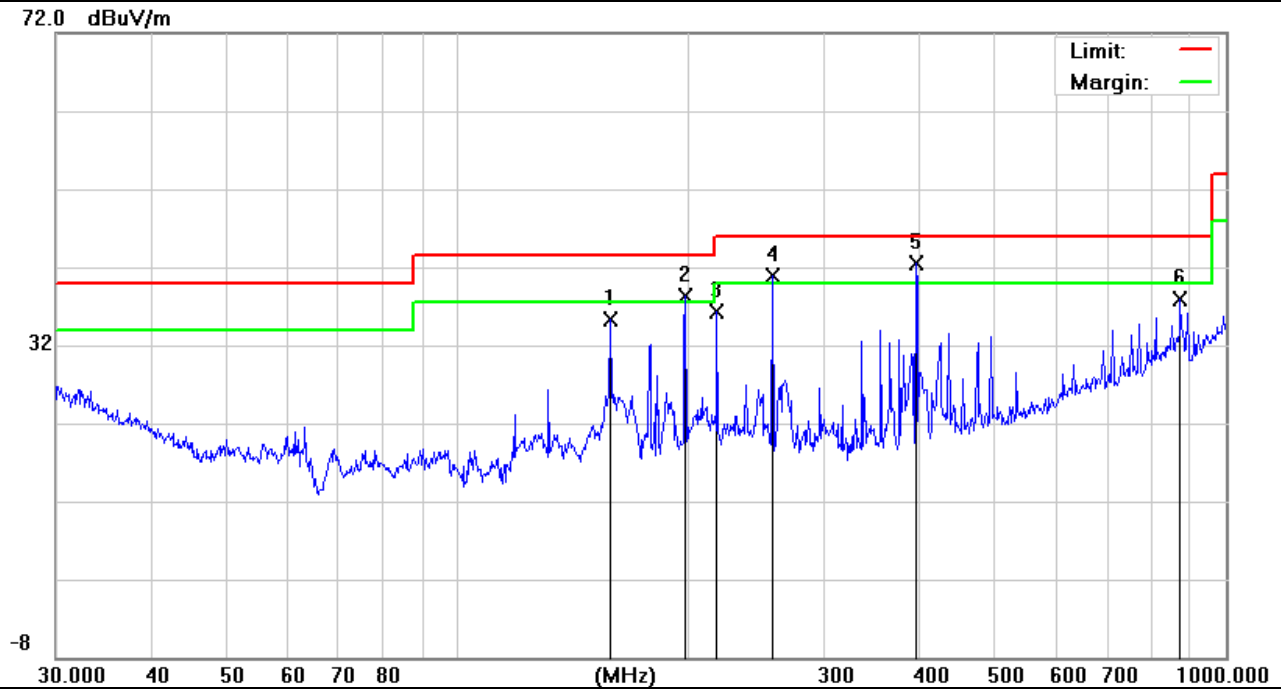

■ Spurious Emission Above 1GHz (1GHz to 25GHz)

| | | | |
|--------------|-------------------|--------------------|-----------|
| EUT: | wireless speaker | Model No.: | YTK-318 |
| Temperature: | 23°C | Relative Humidity: | 36% |
| Test Mode: | Mode2/Mode3/Mode4 | Test By: | Allen Liu |

All the modulation modes have been tested, and the worst result was report as below:

| Frequency | Read Level | Cable loss | Antenna Factor | Preamp Factor | Emission Level | Limits | Margin | Remark | Comment |
|--|------------|------------|----------------|---------------|----------------|----------|--------|--------|------------|
| (MHz) | (dBμV) | (dB) | dB/m | (dB) | (dBμV/m) | (dBμV/m) | (dB) | | |
| Low Channel (2402 MHz)(8-DPSK)--Above 1G | | | | | | | | | |
| 4804.23 | 62.14 | 5.21 | 35.59 | 44.30 | 58.64 | 74.00 | -15.36 | Pk | Vertical |
| 4804.23 | 42.37 | 5.21 | 35.59 | 44.30 | 38.87 | 54.00 | -15.13 | AV | Vertical |
| 7206.17 | 59.76 | 6.48 | 36.27 | 44.60 | 57.91 | 74.00 | -16.09 | Pk | Vertical |
| 7206.17 | 40.95 | 6.48 | 36.27 | 44.60 | 39.10 | 54.00 | -14.9 | AV | Vertical |
| 4804 | 60.07 | 5.21 | 35.55 | 44.30 | 56.53 | 74.00 | -17.47 | Pk | Horizontal |
| 4804 | 42.38 | 5.21 | 35.55 | 44.30 | 38.84 | 54.00 | -15.16 | AV | Horizontal |
| 7206.02 | 59.46 | 6.48 | 36.27 | 44.52 | 57.69 | 74.00 | -16.31 | Pk | Horizontal |
| 7206.02 | 48.33 | 6.48 | 36.27 | 44.52 | 46.56 | 54.00 | -7.44 | AV | Horizontal |
| Mid Channel (2441 MHz)(8-DPSK)--Above 1G | | | | | | | | | |
| 4881.34 | 61.11 | 5.21 | 35.66 | 44.20 | 57.78 | 74.00 | -16.22 | Pk | Vertical |
| 4881.34 | 41.02 | 5.21 | 35.66 | 44.20 | 37.69 | 54.00 | -16.31 | AV | Vertical |
| 7321.94 | 58.45 | 7.10 | 36.50 | 44.43 | 57.62 | 74.00 | -16.38 | Pk | Vertical |
| 7321.94 | 49.44 | 7.10 | 36.50 | 44.43 | 48.61 | 54.00 | -5.39 | AV | Vertical |
| 4881.09 | 58.38 | 5.21 | 35.66 | 44.20 | 55.05 | 74.00 | -18.95 | Pk | Horizontal |
| 4881.09 | 46.54 | 5.21 | 35.66 | 44.20 | 43.21 | 54.00 | -10.79 | AV | Horizontal |
| 7322 | 57.31 | 7.10 | 36.50 | 44.43 | 56.48 | 74.00 | -17.52 | Pk | Horizontal |
| 7322 | 43.22 | 7.10 | 36.50 | 44.43 | 42.39 | 54.00 | -11.61 | AV | Horizontal |
| High Channel (2480 MHz)(8-DPSK)-- Above 1G | | | | | | | | | |
| 4959.02 | 60.04 | 5.21 | 35.52 | 44.21 | 56.56 | 74.00 | -17.44 | Pk | Vertical |
| 4959.02 | 39.99 | 5.21 | 35.52 | 44.21 | 36.51 | 54.00 | -17.49 | AV | Vertical |
| 7439 | 61.13 | 7.10 | 36.53 | 44.60 | 60.16 | 74.00 | -13.84 | Pk | Vertical |
| 7439 | 45.37 | 7.10 | 36.53 | 44.60 | 44.40 | 54.00 | -9.60 | AV | Vertical |
| 4958.97 | 61.05 | 5.21 | 35.52 | 44.21 | 57.57 | 74.00 | -16.43 | Pk | Horizontal |
| 4958.97 | 47.54 | 5.21 | 35.52 | 44.21 | 44.06 | 54.00 | -9.94 | AV | Horizontal |
| 7439.06 | 58.92 | 7.10 | 36.53 | 44.60 | 57.95 | 74.00 | -16.05 | Pk | Horizontal |
| 7439.06 | 42.06 | 7.10 | 36.53 | 44.60 | 41.09 | 54.00 | -12.91 | AV | Horizontal |

- Note: (1) All Readings are Peak Value (VBW=3MHz) and AV Value (VBW=10Hz).
 (2) Emission Level= Antenna Factor + Cable Loss + Read Level - Preamp Factor
 (3)All other emissions more than 20dB below the limit.

■ Spurious Emission in Band edge

| | | | |
|--------------|------------------|--------------------|-----------|
| EUT: | wireless speaker | Model No.: | YTK-318 |
| Temperature: | 20 °C | Relative Humidity: | 48% |
| Test Mode: | Mode2/ Mode4 | Test By: | Allen Liu |

All the modulation modes have been tested, and the worst result was report as below:

| Frequency (MHz) | Meter Reading (dBμV) | Cable Loss (dB) | Antenna Factor (dB/m) | Preamp Factor (dB) | Emission Level (dBμV/m) | Limits (dBμV/m) | Margin (dB) | Detector Type | Comment |
|-----------------------------------|----------------------------|-----------------------|-----------------------------|--------------------------|-------------------------------|--------------------|----------------|------------------|------------|
| 3Mbps (8-DPSK)-hopping | | | | | | | | | |
| 2310.00 | 60.24 | 2.97 | 27.80 | 43.80 | 47.21 | 74 | -26.79 | Pk | Horizontal |
| 2310.00 | 42.10 | 2.97 | 27.80 | 43.80 | 29.07 | 54 | -24.93 | AV | Horizontal |
| 2310.00 | 63.20 | 2.97 | 27.80 | 43.80 | 50.17 | 74 | -23.83 | Pk | Vertical |
| 2310.00 | 42.07 | 2.97 | 27.80 | 43.80 | 29.04 | 54 | -24.96 | AV | Vertical |
| 2390.00 | 59.41 | 3.14 | 27.21 | 43.80 | 45.96 | 74 | -28.04 | Pk | Vertical |
| 2390.00 | 40.95 | 3.14 | 27.21 | 43.80 | 27.50 | 54 | -26.5 | AV | Vertical |
| 2390.00 | 59.51 | 3.14 | 27.21 | 43.80 | 46.06 | 74 | -27.94 | Pk | Horizontal |
| 2390.00 | 42.10 | 3.14 | 27.21 | 43.80 | 28.65 | 54 | -25.35 | AV | Horizontal |
| 2483.50 | 61.45 | 3.58 | 27.70 | 44.00 | 48.73 | 74 | -25.27 | Pk | Vertical |
| 2483.50 | 40.05 | 3.58 | 27.70 | 44.00 | 27.33 | 54 | -26.67 | AV | Vertical |
| 2483.50 | 60.36 | 3.58 | 27.70 | 44.00 | 47.64 | 74 | -26.36 | Pk | Horizontal |
| 2483.50 | 42.11 | 3.58 | 27.70 | 44.00 | 29.39 | 54 | -24.61 | AV | Horizontal |
| 3Mbps(8-DPSK)- Non-hopping | | | | | | | | | |
| 2310.00 | 60.36 | 2.97 | 27.80 | 43.80 | 47.33 | 74 | -26.67 | Pk | Horizontal |
| 2310.00 | 42.12 | 2.97 | 27.80 | 43.80 | 29.09 | 54 | -24.91 | AV | Horizontal |
| 2310.00 | 62.10 | 2.97 | 27.80 | 43.80 | 49.07 | 74 | -24.93 | Pk | Vertical |
| 2310.00 | 41.05 | 2.97 | 27.80 | 43.80 | 28.02 | 54 | -25.98 | AV | Vertical |
| 2390.00 | 59.41 | 3.14 | 27.21 | 43.80 | 45.96 | 74 | -28.04 | Pk | Vertical |
| 2390.00 | 42.48 | 3.14 | 27.21 | 43.80 | 29.03 | 54 | -24.97 | AV | Vertical |
| 2390.00 | 59.80 | 3.14 | 27.21 | 43.80 | 46.35 | 74 | -27.65 | Pk | Horizontal |
| 2390.00 | 43.19 | 3.14 | 27.21 | 43.80 | 29.74 | 54 | -24.26 | AV | Horizontal |
| 2483.50 | 62.16 | 3.58 | 27.70 | 44.00 | 49.44 | 74 | -24.56 | Pk | Vertical |
| 2483.50 | 42.81 | 3.58 | 27.70 | 44.00 | 30.09 | 54 | -23.91 | AV | Vertical |
| 2483.50 | 59.40 | 3.58 | 27.70 | 44.00 | 46.68 | 74 | -27.32 | Pk | Horizontal |
| 2483.50 | 41.96 | 3.58 | 27.70 | 44.00 | 29.24 | 54 | -24.76 | AV | Horizontal |

Note: (1) All other emissions more than 20dB below the limit.

■ Spurious Emission in Restricted Band 3260MMHz-18000MHz

| | | | |
|--------------|------------------|--------------------|-----------|
| EUT: | wireless speaker | Model No.: | YTK-318 |
| Temperature: | 20 °C | Relative Humidity: | 48% |
| Test Mode: | Mode2/ Mode4 | Test By: | Allen Liu |

All the modulation modes have been tested, and the worst result was report as below:

| Frequency (MHz) | Reading Level (dB μ V) | Cable Loss (dB) | Antenna (dB/m) | Preamp Factor (dB) | Emission Level (dB μ V/m) | Limits (dB μ V/m) | Margin (dB) | Detector Type | Comment |
|--------------------|-------------------------------|--------------------|-------------------|-----------------------|----------------------------------|--------------------------|----------------|------------------|------------|
| 3260 | 60.64 | 4.04 | 29.57 | 44.70 | 49.55 | 74 | -24.45 | Pk | Vertical |
| 3260 | 49.27 | 4.04 | 29.57 | 44.70 | 38.18 | 54 | -15.82 | AV | Vertical |
| 3260 | 61.73 | 4.04 | 29.57 | 44.70 | 50.64 | 74 | -23.36 | Pk | Horizontal |
| 3260 | 52.69 | 4.04 | 29.57 | 44.70 | 41.60 | 54 | -12.40 | AV | Horizontal |
| 3332 | 61.58 | 4.26 | 29.87 | 44.40 | 51.31 | 74 | -22.69 | Pk | Vertical |
| 3332 | 51.22 | 4.26 | 29.87 | 44.40 | 40.95 | 54 | -13.05 | AV | Vertical |
| 3332 | 61.73 | 4.26 | 29.87 | 44.40 | 51.46 | 74 | -22.54 | Pk | Horizontal |
| 3332 | 49.36 | 4.26 | 29.87 | 44.40 | 39.09 | 54 | -14.91 | AV | Horizontal |
| 17797 | 42.64 | 10.99 | 43.95 | 43.50 | 54.08 | 74 | -19.92 | Pk | Vertical |
| 17797 | 30.33 | 10.99 | 43.95 | 43.50 | 41.77 | 54 | -12.23 | AV | Vertical |
| 17788 | 42.51 | 11.81 | 43.69 | 44.60 | 53.41 | 74 | -20.59 | Pk | Horizontal |
| 17788 | 28.96 | 11.81 | 43.69 | 44.60 | 39.86 | 54 | -14.14 | AV | Horizontal |

Note: (1) All other emissions more than 20dB below the limit.

7.3 NUMBER OF HOPPING CHANNEL

7.3.1 Applicable Standard

According to FCC Part 15.247(a)(1) (iii) and ANSI C63.10-2013

7.3.2 Conformance Limit

Frequency hopping systems in the 2400-2483.5MHz band shall use at least 15 channels.

7.3.3 Measuring Instruments

The Measuring equipment is listed in the section 6.3 of this test report.

7.3.4 Test Setup

Please refer to Section 6.1 of this test report.

7.3.5 Test Procedure

The testing follows ANSI C63.10-2013 clause 7.8.3

The RF output of EUT was connected to the spectrum analyzer by RF cable and attenuator.

The path loss was compensated to the results for each measurement.

Set to the maximum power setting and enable the EUT transmit continuously.

The EUT must have its hopping function enabled.

Use the following spectrum analyzer settings:

Span = the frequency band of operation

RBW : To identify clearly the individual channels, set the RBW to less than 30% of the channel spacing or the 20 dB bandwidth, whichever is smaller.

VBW \geq RBW

Sweep = auto

Detector function = peak

Trace = max hold

7.3.6 Test Results

| | | | |
|--------------|------------------|--------------------|-----------|
| EUT: | wireless speaker | Model No.: | YTK-318 |
| Temperature: | 20 °C | Relative Humidity: | 48% |
| Test Mode: | Mode 5(1Mbps) | Test By: | Allen Liu |

| Number of Hopping (Channel) | Adaptive Frequency hopping (Channel) | limit | Verdict |
|-----------------------------|--------------------------------------|-----------|---------|
| 79 | 20 | ≥ 15 | Pass |

Number of Hopping Channel Plot

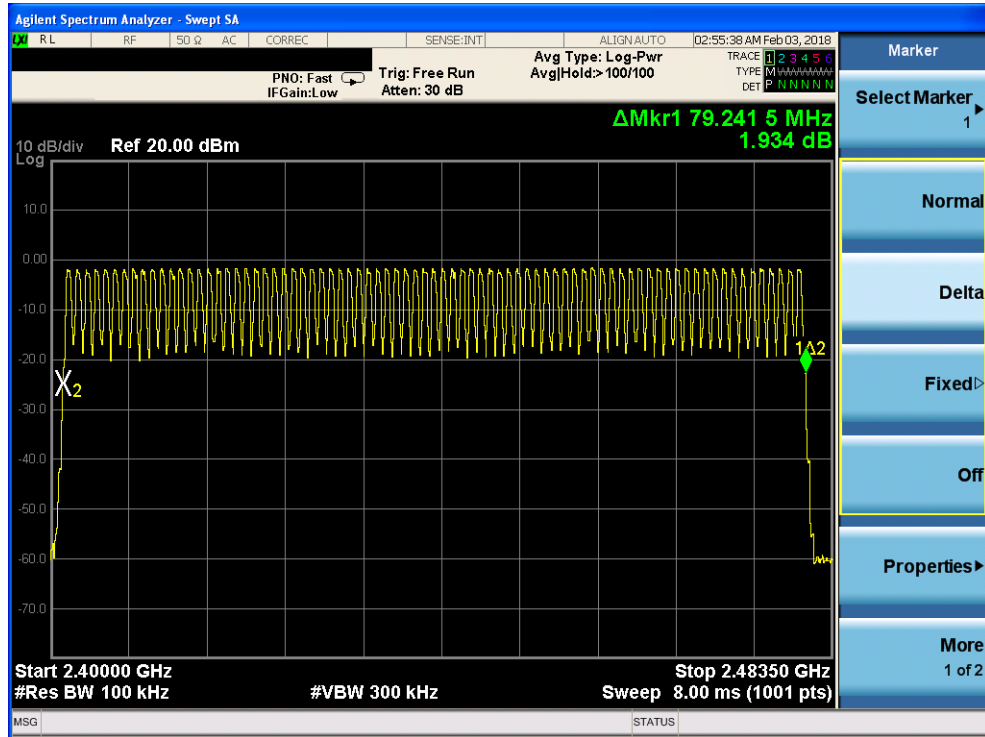

7.4 HOPPING CHANNEL SEPARATION MEASUREMENT

7.4.1 Applicable Standard

According to FCC Part 15.247(a)(1) and ANSI C63.10-2013

7.4.2 Conformance Limit

Frequency hopping systems operating in the 2400-2483.5MHz band shall have hopping channel carrier frequencies that are separated by 25kHz or two-thirds of the 20dB bandwidth of the hopping channel, whichever is greater.

7.4.3 Measuring Instruments

The Measuring equipment is listed in the section 6.3 of this test report.

7.4.4 Test Setup

Please refer to Section 6.1 of this test report.

7.4.5 Test Procedure

The testing follows ANSI C63.10-2013 clause 7.8.2

The RF output of EUT was connected to the spectrum analyzer by RF cable and attenuator.

The path loss was compensated to the results for each measurement.

Set to the maximum power setting and enable the EUT transmit continuously.

The EUT was operating in controlled its channel.

Use the following spectrum analyzer settings:

Span = Measurement Bandwidth or Channel Separation

RBW: Start with the RBW set to approximately 30% of the channel spacing; adjust as necessary to best identify the center of each individual channel.

VBW \geq RBW

Sweep = auto

Detector function = peak

Trace = max hold

7.4.6 Test Results

| | | | |
|--------------|-------------------|--------------------|-----------|
| EUT: | wireless speaker | Model No.: | YTK-318 |
| Temperature: | 20 °C | Relative Humidity: | 48% |
| Test Mode: | Mode2/Mode3/Mode4 | Test By: | Allen Liu |

| Modulation Mode | Channel Number | Channel Frequency (MHz) | Measured Channel Separation (kHz) | Limit (kHz) | | Verdict |
|-----------------|----------------|-------------------------|-----------------------------------|-------------|----------------|---------|
| | | | | | | |
| GFSK | 0 | 2402 | 1000 | >831.7 | 20dB BW | PASS |
| | 39 | 2441 | 997.5 | >831.4 | 20dB BW | PASS |
| | 78 | 2480 | 1000 | >838.1 | 20dB BW | PASS |
| $\pi/4$ -DQPSK | 0 | 2402 | 1000 | >768.667 | 2/3 of 20dB BW | PASS |
| | 39 | 2441 | 1000 | >771.333 | 2/3 of 20dB BW | PASS |
| | 78 | 2480 | 997.5 | >770.667 | 2/3 of 20dB BW | PASS |
| 8-DPSK | 0 | 2402 | 997.5 | >792.000 | 2/3 of 20dB BW | PASS |
| | 39 | 2441 | 997.5 | >793.333 | 2/3 of 20dB BW | PASS |
| | 78 | 2480 | 997.5 | >794.000 | 2/3 of 20dB BW | PASS |

Test Plot

(1Mbps) Channel Separation plot on channel 00-01

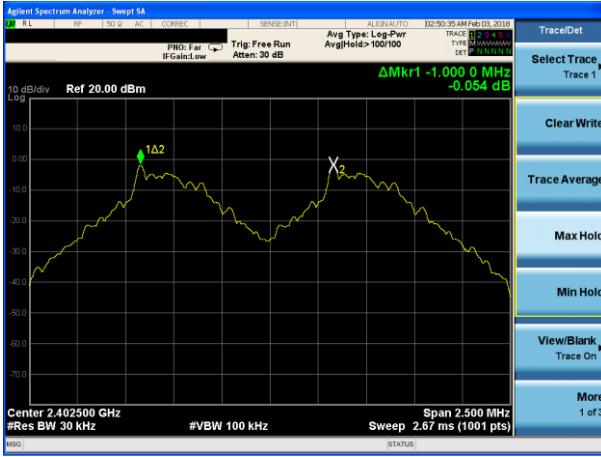

(2Mbps) Channel Separation plot on channel 00-01



(1Mbps) Channel Separation plot on channel 39-40

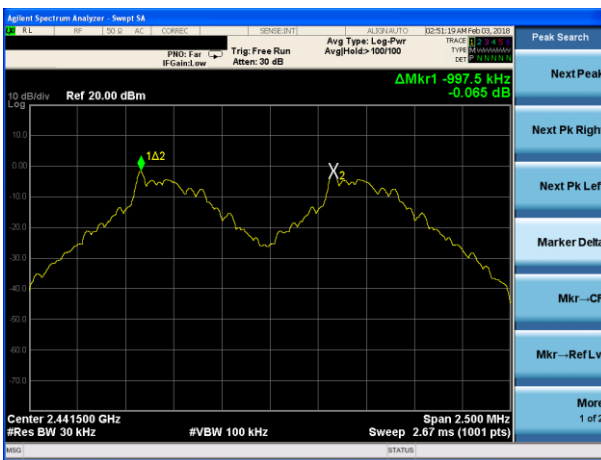

(2Mbps) Channel Separation plot on channel 39-40



(1Mbps) Channel Separation plot on channel 77-78

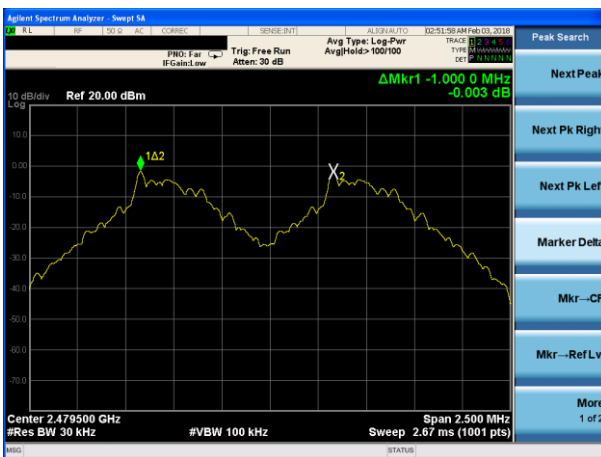

(2Mbps) Channel Separation plot on channel 77-78

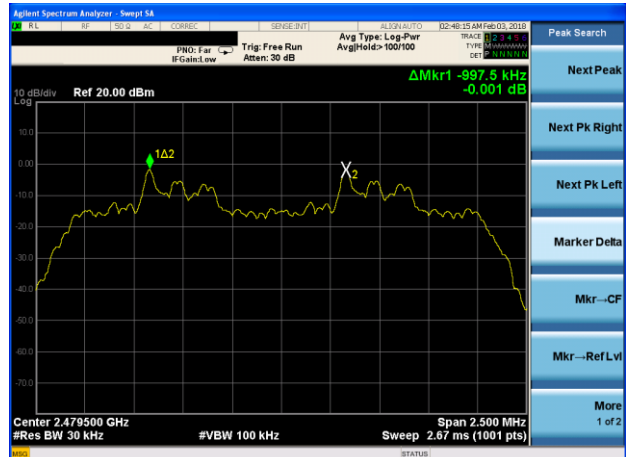

Test Plot

(3Mbps) Channel Separation plot on channel 00-01



(3Mbps) Channel Separation plot on channel 39-40

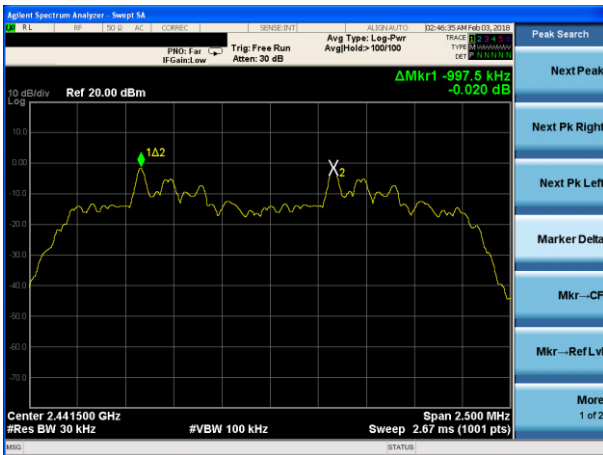

(3Mbps) Channel Separation plot on channel 77-78

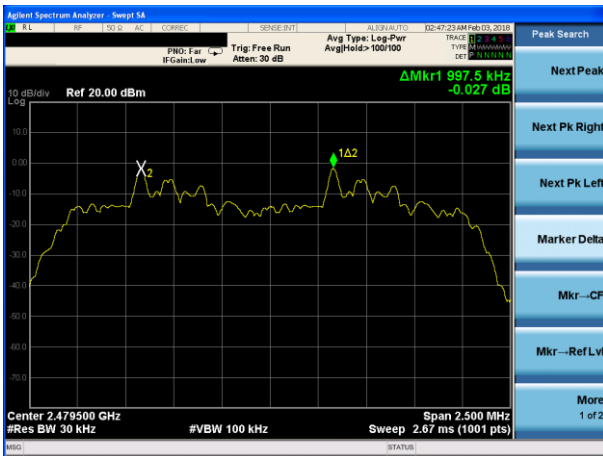

7.5 AVERAGE TIME OF OCCUPANCY (DWELL TIME)

7.5.1 Applicable Standard

According to FCC Part 15.247(a)(1)(iii) and ANSI C63.10-2013

7.5.2 Conformance Limit

The average time of occupancy on any channel shall not be greater than 0.4s within a period of 0.4s multiplied by the number of hopping channels employed.

7.5.3 Measuring Instruments

The Measuring equipment is listed in the section 6.3 of this test report.

7.5.4 Test Setup

Please refer to Section 6.1 of this test report.

7.5.5 Test Procedure

The testing follows ANSI C63.10-2013 clause 7.8.4

The RF output of EUT was connected to the spectrum analyzer by RF cable and attenuator.

The path loss was compensated to the results for each measurement.

Set to the maximum power setting and enable the EUT transmit continuously.

The EUT must have its hopping function enabled.

Use the following spectrum analyzer settings:

Span = zero span, centered on a hopping channel

RBW \geq 1MHz

VBW \geq RBW

Sweep = as necessary to capture the entire dwell time per hopping channel

Detector function = peak

Trace = max hold

Measure the maximum time duration of one single pulse.

Set the EUT for DH5, DH3 and DH1 packet transmitting.

Measure the maximum time duration of one single pulse.

7.5.6 Test Results

| | | | |
|--------------|-------------------|--------------------|-----------|
| EUT: | wireless speaker | Model No.: | YTK-318 |
| Temperature: | 20 °C | Relative Humidity: | 48% |
| Test Mode: | Mode2/Mode3/Mode4 | Test By: | Allen Liu |

| Modulation Mode | Channel Number | Packet type | Mode | Hops Over Occupancy | Pulse width | dwell time (ms) | Limit | Verdict |
|-----------------|----------------|-------------|--------|---------------------|-------------|-----------------|-------|---------|
| | | | | (ms) | (ms) | | (ms) | |
| GFSK | 39 | DH1 | Normal | 320 | 0.456 | 145.920 | <400 | PASS |
| | 39 | | AFH | 160 | 0.456 | 72.960 | <400 | PASS |
| | 39 | DH3 | Normal | 160 | 1.728 | 276.480 | <400 | PASS |
| | 39 | | AFH | 80 | 1.728 | 138.240 | <400 | PASS |
| | 39 | DH5 | Normal | 106.67 | 2.976 | 317.450 | <400 | PASS |
| | 39 | | AFH | 53.33 | 2.976 | 158.710 | <400 | PASS |
| π/4-DQPSK | 39 | 2DH1 | Normal | 320 | 0.472 | 151.040 | <400 | PASS |
| | 39 | | AFH | 160 | 0.472 | 75.520 | <400 | PASS |
| | 39 | 2DH3 | Normal | 160 | 1.752 | 280.320 | <400 | PASS |
| | 39 | | AFH | 80 | 1.752 | 140.160 | <400 | PASS |
| | 39 | 2DH5 | Normal | 106.67 | 2.976 | 317.450 | <400 | PASS |
| | 39 | | AFH | 53.33 | 2.976 | 158.710 | <400 | PASS |
| 8DPSK | 39 | 3DH1 | Normal | 320 | 0.488 | 156.160 | <400 | PASS |
| | 39 | | AFH | 160 | 0.488 | 78.080 | <400 | PASS |
| | 39 | 3DH3 | Normal | 160 | 1.744 | 279.040 | <400 | PASS |
| | 39 | | AFH | 80 | 1.744 | 139.520 | <400 | PASS |
| | 39 | 3DH5 | Normal | 106.67 | 2.984 | 318.303 | <400 | PASS |
| | 39 | | AFH | 53.33 | 2.984 | 159.137 | <400 | PASS |

Note:

A Period Time = (channel number)*0.4

DH1 Time Slot: Reading * (1600/2)*31.6/(channel number)

DH3 Time Slot: Reading * (1600/4)*31.6/(channel number)

DH5 Time Slot: Reading * (1600/6)*31.6/(channel number)

For Example:

- In normal mode, hopping rate is 1600 hops/s with 6 slots in 79 hopping channels. With channel hopping rate (1600 / 6 / 79) in Occupancy Time Limit (0.4 x 79) (s), Hops Over Occupancy Time comes to (1600 / 6 / 79) x (0.4 x 79) = 106.67 hops.
- In AFH mode, hopping rate is 800 hops/s with 6 slots in 20 hopping channels. With channel hopping rate (800 / 6 / 20) in Occupancy Time Limit (0.4 x 20) (s), Hops Over Occupancy Time comes to (800 / 6 / 20) x (0.4 x 20) = 53.33 hops.
- Dwell Time(s) = Hops Over Occupancy Time (hops) x Package Transfer Time

Test Plot

Package Transfer Time Plot CH39-DH1

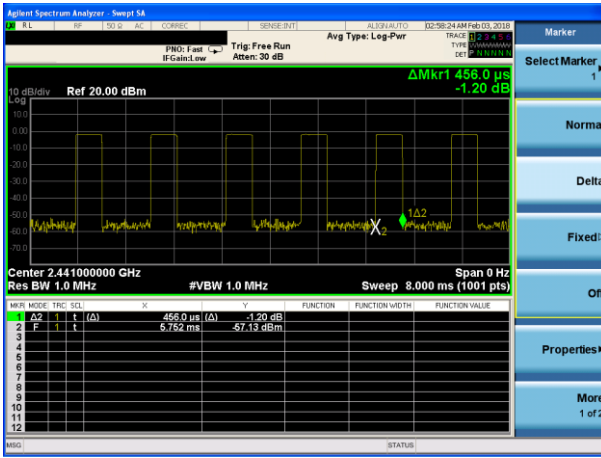

Package Transfer Time Plot CH39-2DH1

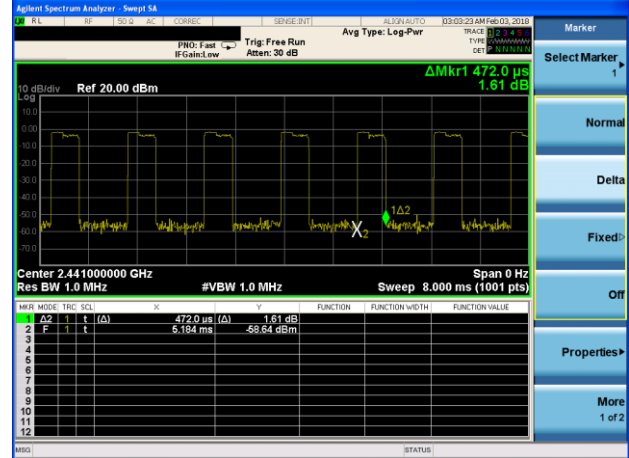

Package Transfer Time Plot CH39-DH3

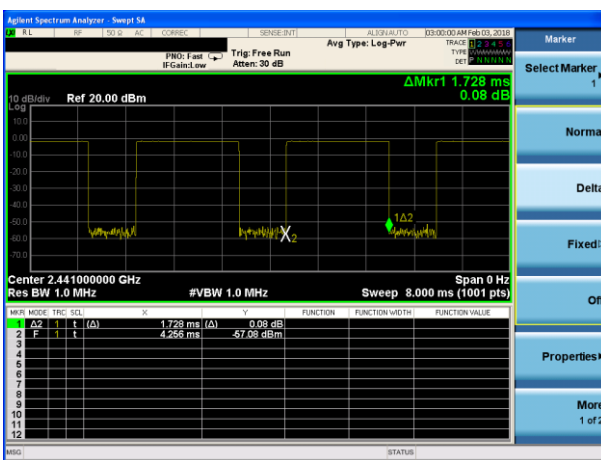

Package Transfer Time Plot CH39-2DH3



Package Transfer Time Plot CH39-DH5

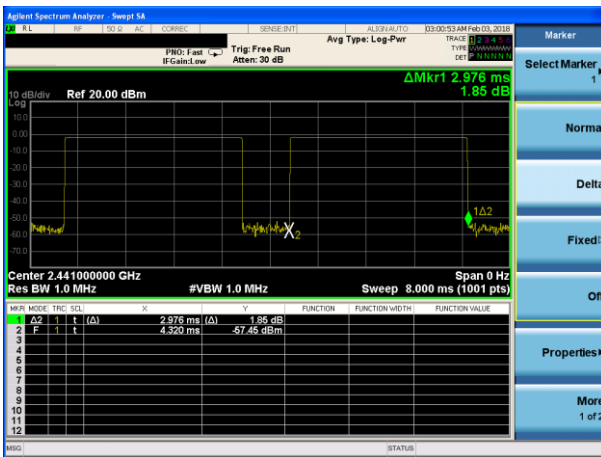

Package Transfer Time Plot CH39-2DH5

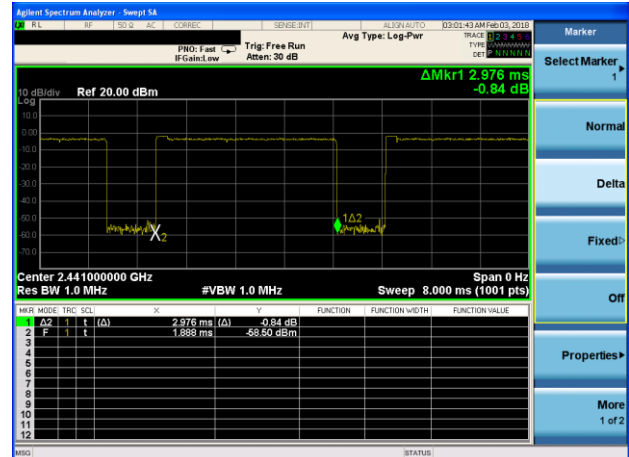

Test Plot

Package Transfer Time Plot CH39-3DH1

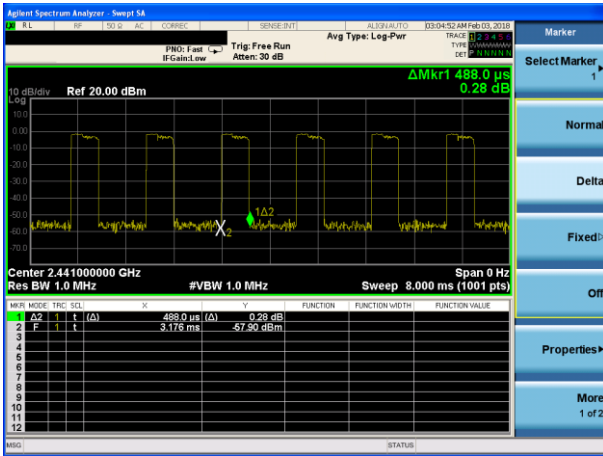

Package Transfer Time Plot CH39-3DH3

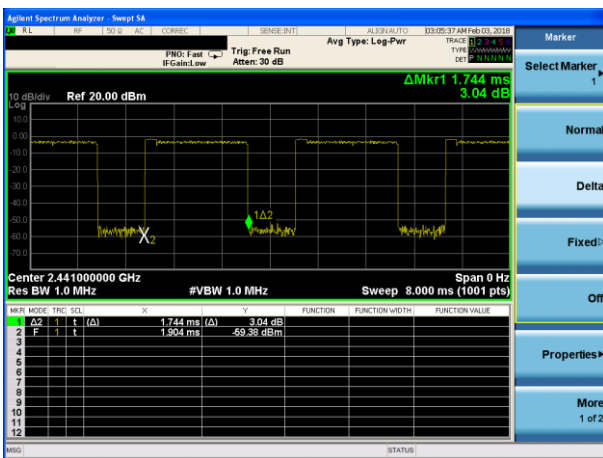

Package Transfer Time Plot CH39-3DH5

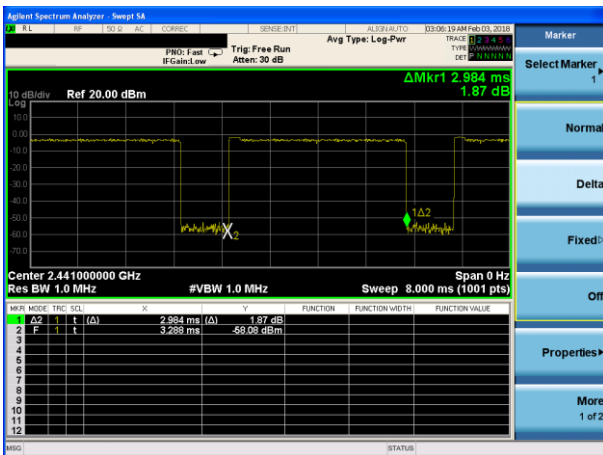

7.6 20DB BANDWIDTH TEST

7.6.1 Applicable Standard

According to FCC Part 15.247(a)(1) and ANSI C63.10-2013

7.6.2 Conformance Limit

No limit requirement.

7.6.3 Measuring Instruments

The Measuring equipment is listed in the section 6.3 of this test report.

7.6.4 Test Setup

Please refer to Section 6.1 of this test report.

7.6.5 Test Procedure

The testing follows ANSI C63.10-2013 clause 6.9.2

The RF output of EUT was connected to the spectrum analyzer by RF cable and attenuator.

The path loss was compensated to the results for each measurement.

Set to the maximum power setting and enable the EUT transmit continuously.

The EUT was operating in controlled its channel.

Use the following spectrum analyzer settings:

Span = approximately 2 to 3 times the 20 dB bandwidth, centered on a hopping channel

RBW \geq 1% of the 20 dB bandwidth

VBW \geq RBW

Sweep = auto

Detector function = peak

Trace = max hold

7.6.6 Test Results

| | | | |
|--------------|-------------------|--------------------|-----------|
| EUT: | wireless speaker | Model No.: | YTK-318 |
| Temperature: | 20 °C | Relative Humidity: | 48% |
| Test Mode: | Mode2/Mode3/Mode4 | Test By: | Allen Liu |

| Test Channel | Frequency | Measured Bandwidth (KHz) | Limit | Verdict |
|--------------|-----------|--------------------------|-------|---------|
| | (MHz) | | (kHz) | |
| 1Mbps | | | | |
| 0 | 2402 | 831.700 | N/A | PASS |
| 39 | 2441 | 831.400 | N/A | PASS |
| 78 | 2480 | 838.100 | N/A | PASS |
| 2Mbps | | | | |
| 0 | 2402 | 1153 | N/A | PASS |
| 39 | 2441 | 1157 | N/A | PASS |
| 78 | 2480 | 1156 | N/A | PASS |
| 3Mbps | | | | |
| 0 | 2402 | 1188 | N/A | PASS |
| 39 | 2441 | 1190 | N/A | PASS |
| 78 | 2480 | 1191 | N/A | PASS |

Note: N/A (Not Applicable)

Test Plot

20dB Bandwidth plot on channel 00 (1Mbps)

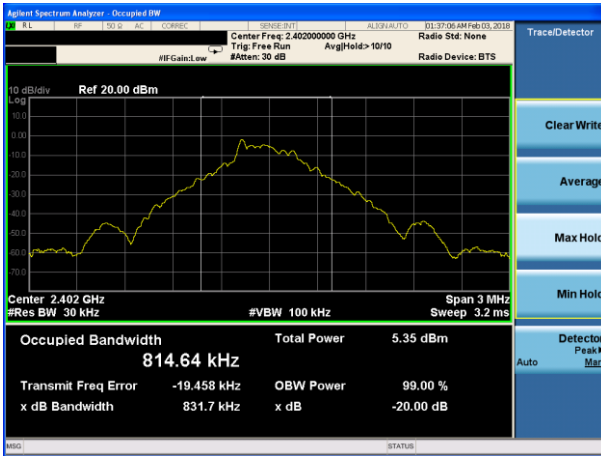

20dB Bandwidth plot on channel 00 (2Mbps)

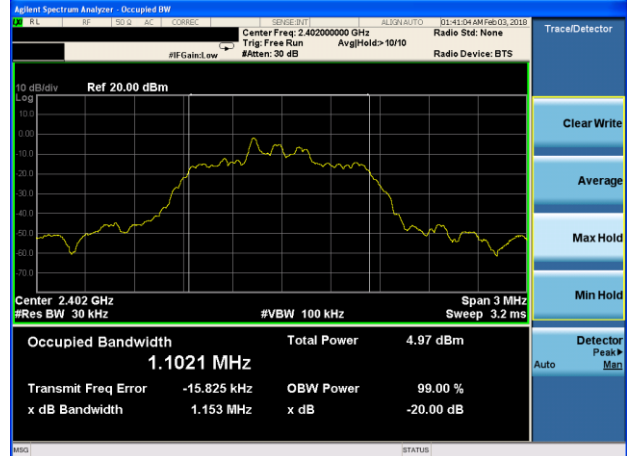

20dB Bandwidth plot on channel 39 (1Mbps)

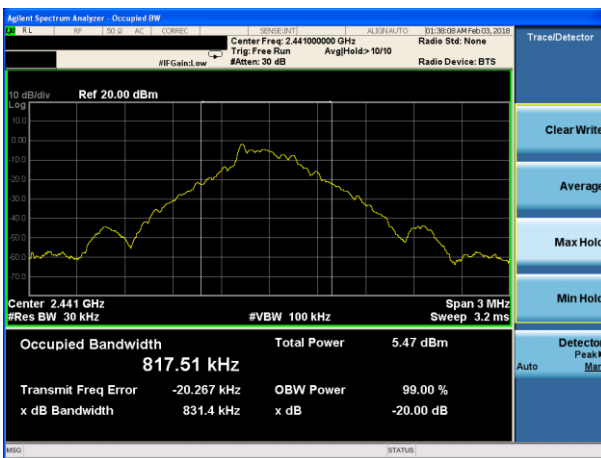

20dB Bandwidth plot on channel 39 (2Mbps)

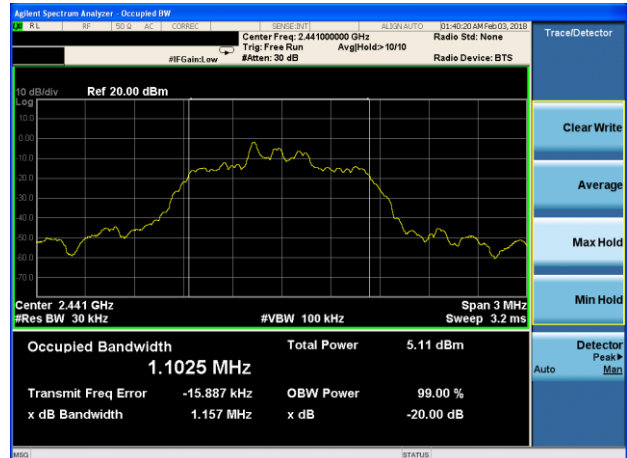

20dB Bandwidth plot on channel 78 (1Mbps)

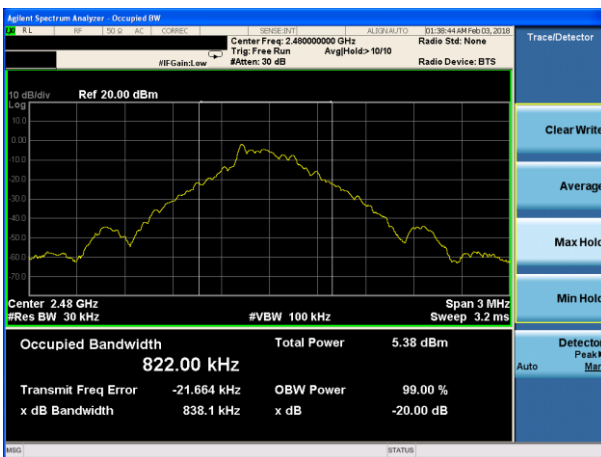

20dB Bandwidth plot on channel 78 (2Mbps)

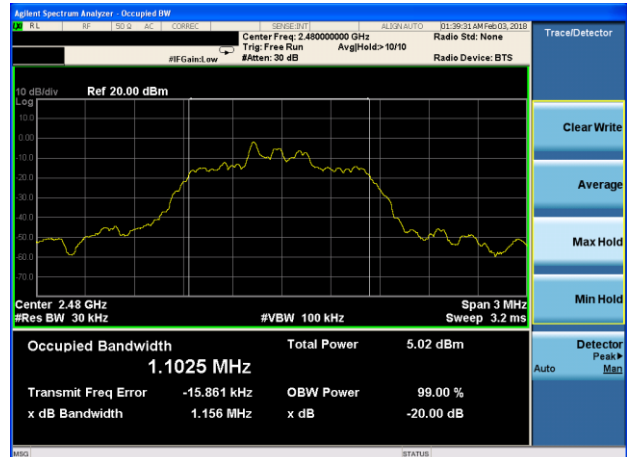

Test Plot

20dB Bandwidth plot on channel 00 (3Mbps)

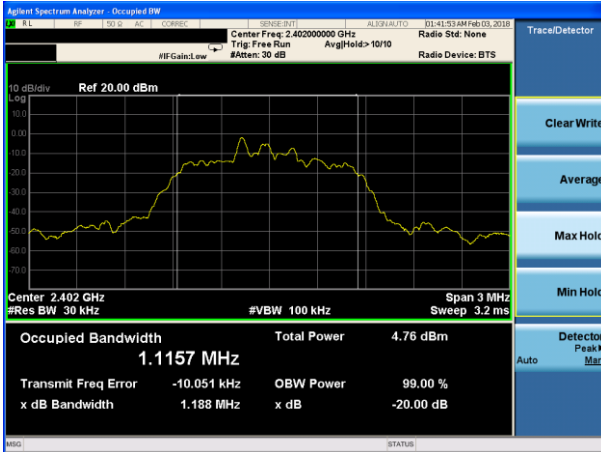

20dB Bandwidth plot on channel 39 (3Mbps)

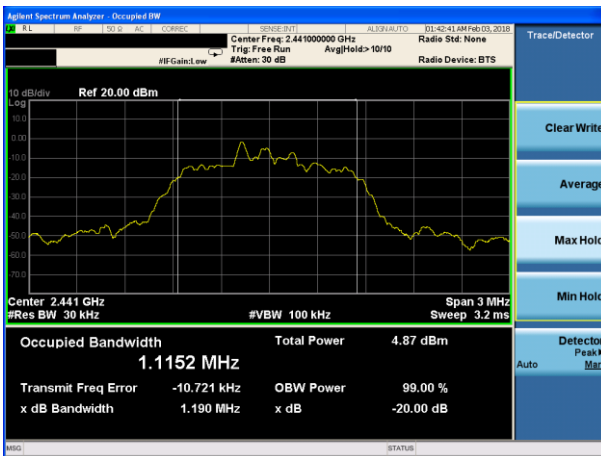

20dB Bandwidth plot on channel 78 (3Mbps)

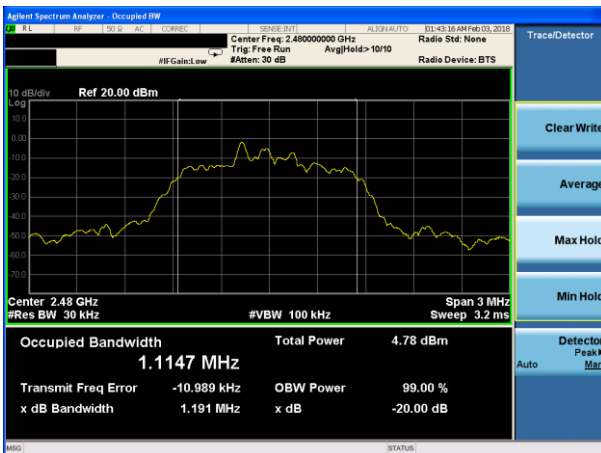

7.7 PEAK OUTPUT POWER

7.7.1 Applicable Standard

According to FCC Part 15.247(b)(1) and ANSI C63.10-2013

7.7.2 Conformance Limit

The maximum peak conducted output power of the intentional radiator shall not exceed the following: (1) For frequency hopping systems operating in the 2400-2483.5 MHz band employing at least 75 non-overlapping hopping channels, and all frequency hopping systems in the 5725-5850 MHz band: 1 watt. For all other frequency hopping systems in the 2400-2483.5 MHz band 0.125 watts.

7.7.3 Measuring Instruments

The Measuring equipment is listed in the section 6.3 of this test report.

7.7.4 Test Setup

Please refer to Section 6.1 of this test report.

7.7.5 Test Procedure

The testing follows ANSI C63.10-2013 clause 7.8.5.

The RF output of EUT was connected to the spectrum analyzer by RF cable and attenuator.

The path loss was compensated to the results for each measurement.

Set to the maximum power setting and enable the EUT transmit continuously.

The EUT was operating in controlled its channel.

Use the following spectrum analyzer settings:

Span = approximately 5 times the 20 dB bandwidth, centered on a hopping channel

RBW \geq the 20 dB bandwidth of the emission being measured

VBW \geq RBW

Sweep = auto

Detector function = peak

Trace = max hold

7.7.6 Test Results

| | | | |
|--------------|-------------------|--------------------|-----------|
| EUT: | wireless speaker | Model No.: | YTK-318 |
| Temperature: | 20 °C | Relative Humidity: | 48% |
| Test Mode: | Mode2/Mode3/Mode4 | Test By: | Allen Liu |

| Test Channel | Frequency | Power Setting | Peak Output Power | LIMIT | Verdict |
|--------------|-----------|---------------|-------------------|-------|---------|
| | (MHz) | | (dBm) | (dBm) | |
| 1Mbps | | | | | |
| 0 | 2402 | Default | -1.833 | 30 | PASS |
| 39 | 2441 | Default | -1.721 | 30 | PASS |
| 78 | 2480 | Default | -1.822 | 30 | PASS |
| 2Mbps | | | | | |
| 0 | 2402 | Default | -1.832 | 20.97 | PASS |
| 39 | 2441 | Default | -1.707 | 20.97 | PASS |
| 78 | 2480 | Default | -1.824 | 20.97 | PASS |
| 3Mbps | | | | | |
| 0 | 2402 | Default | -1.825 | 20.97 | PASS |
| 39 | 2441 | Default | -1.705 | 20.97 | PASS |
| 78 | 2480 | Default | -1.82 | 20.97 | PASS |

Test Plot

Peak output Power plot on channel 00 (1Mbps)

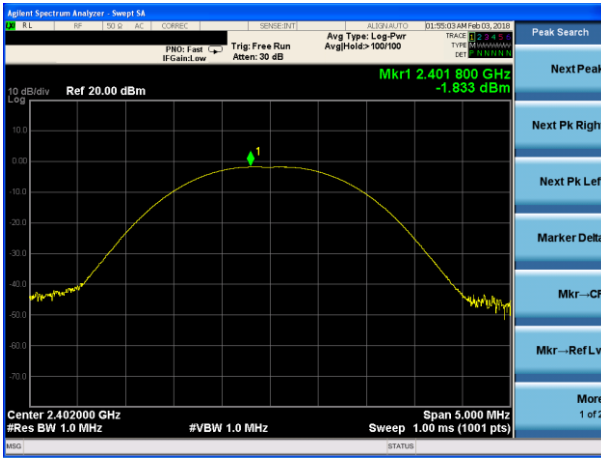

Peak output Power plot on channel 00 (2Mbps)

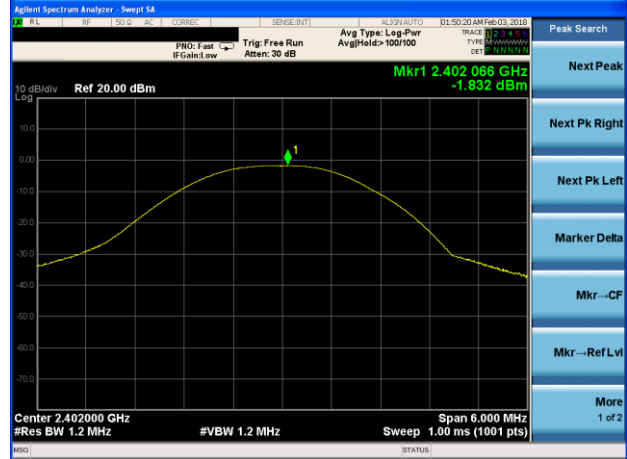

Peak output Power plot on channel 39 (1Mbps)

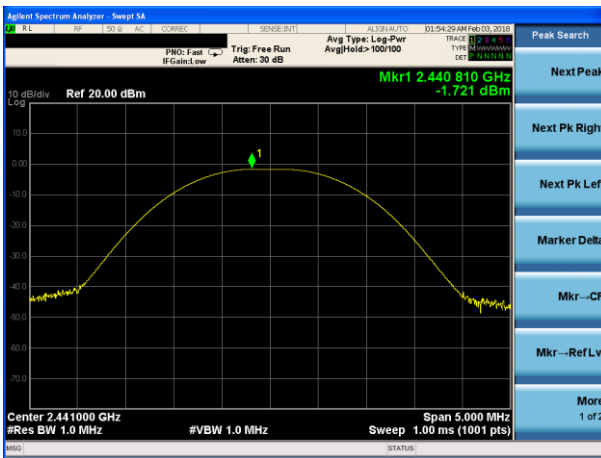

Peak output Power plot on channel 39 (2Mbps)

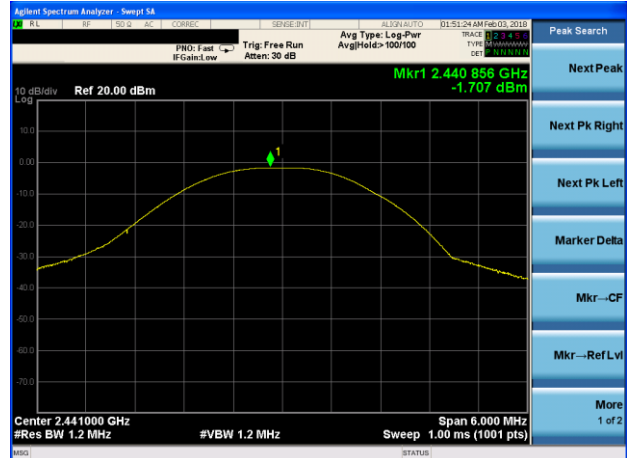

Peak output Power plot on channel 78 (1Mbps)

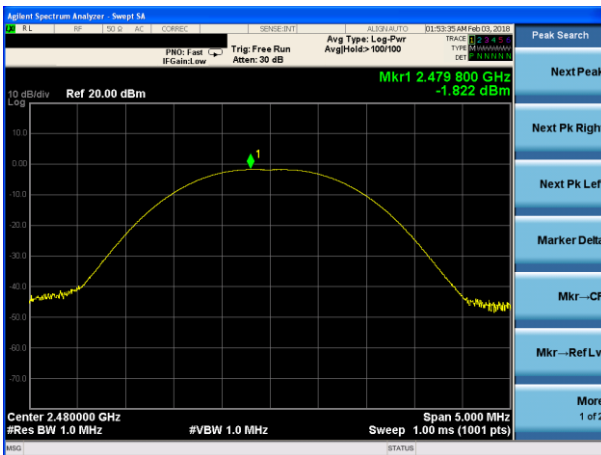

Peak output Power plot on channel 78 (2Mbps)

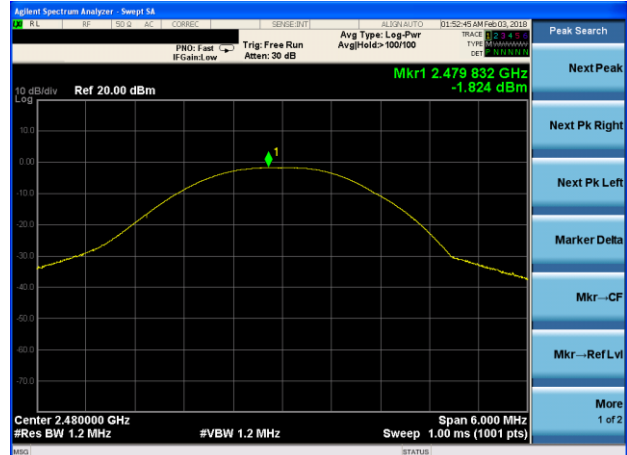

Test Plot

Peak output Power plot on channel 00 (3Mbps)

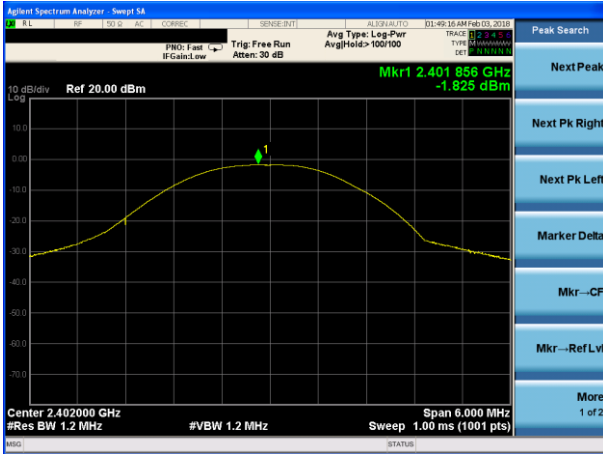

Peak output Power plot on channel 39 (3Mbps)

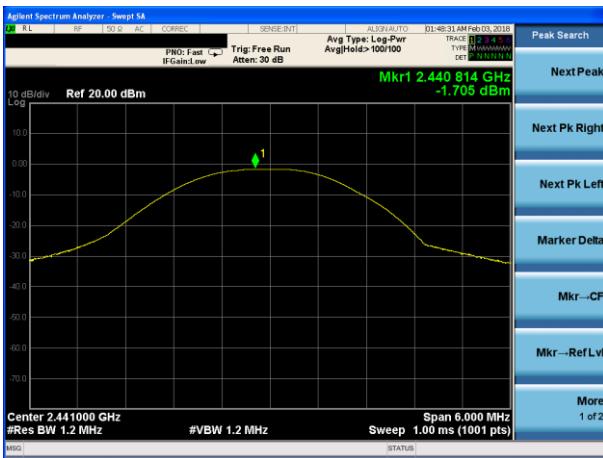

Peak output Power plot on channel 78 (3Mbps)

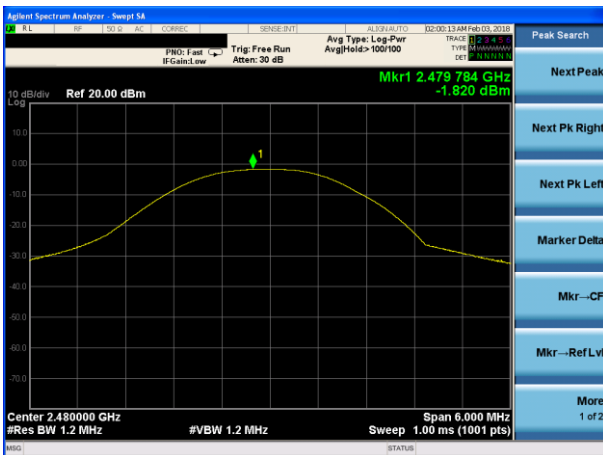

7.8 CONDUCTED BAND EDGE MEASUREMENT

7.8.1 Applicable Standard

According to FCC Part 15.247(d) and ANSI C63.10-2013

7.8.2 Conformance Limit

In any 100 kHz bandwidth outside the frequency band in which the spread spectrum or digitally modulated intentional radiator is operating, the radio frequency power that is produced by the intentional radiator shall be at least 20 dB below that in the 100 kHz bandwidth within the band that contains the highest level of the desired power, based on either an RF conducted or a radiated measurement, provided the transmitter demonstrates compliance with the peak conducted power limits. If the transmitter complies with the conducted power limits based on the use of RMS averaging over a time interval, as permitted under paragraph (b)(3) of this section, the attenuation required under this paragraph shall be 30 dB instead of 20 dB. Attenuation below the general limits specified in §15.209(a) is not required. In addition, radiated emissions which fall in the restricted bands, as defined in §15.205(a), must also comply with the radiated emission limits specified in §15.209(a) (see §15.205(c)).

7.8.3 Measuring Instruments

The Measuring equipment is listed in the section 6.3 of this test report.

7.8.4 Test Setup

Please refer to Section 6.1 of this test report.

7.8.5 Test Procedure

The testing follows ANSI C63.10-2013 clause 7.8.6.

The RF output of EUT was connected to the spectrum analyzer by RF cable and attenuator.

The path loss was compensated to the results for each measurement.

Set to the maximum power setting and enable the EUT transmit continuously.

The EUT must have its hopping function enabled.

Use the following spectrum analyzer settings:

Span = approximately 5 times the 20 dB bandwidth, centered on a hopping channel

RBW = 100KHz

VBW = 300KHz

Band edge emissions must be at least 20 dB down from the highest emission level within the authorized band as measured with a 100kHz RBW. The attenuation shall be 30 dB instead of 20 dB when RMS conducted output power procedure is used.

Measure the highest amplitude appearing on spectral display and set it as a reference level. Plot the graph with marking the highest point and edge frequency.

Repeat above procedures until all measured frequencies were complete.

7.8.6 Test Results

| | | | |
|--------------|----------------------|--------------------|-----------|
| EUT: | wireless speaker | Model No.: | YTK-318 |
| Temperature: | 20 °C | Relative Humidity: | 48% |
| Test Mode: | Mode2 /Mode4/ Mode 5 | Test By: | Allen Liu |

Test Plot

GFSK: Band Edge-Low Channel

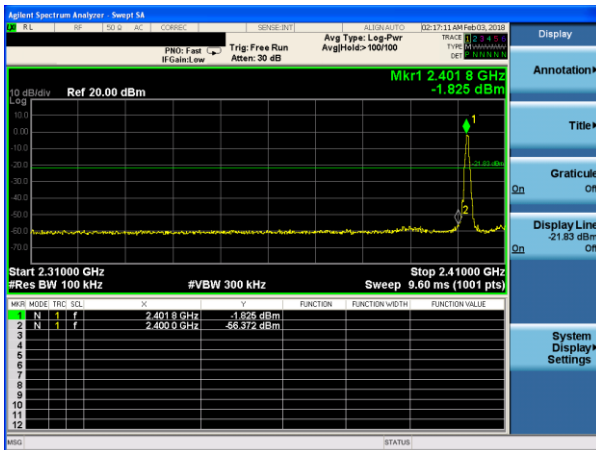

GFSK: Band Edge-High Channel

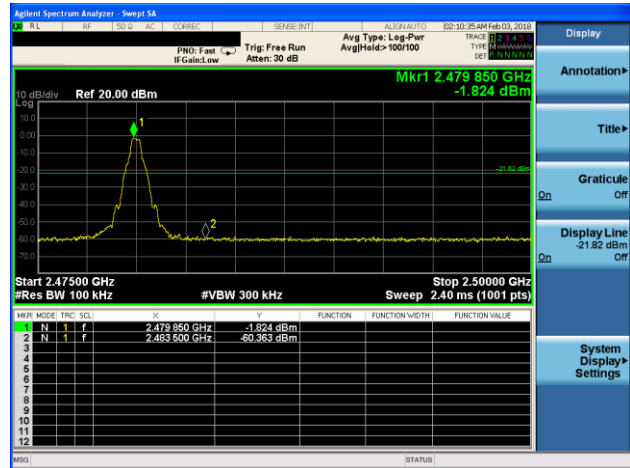

GFSK: Band Edge-Low Channel (Hopping Mode)

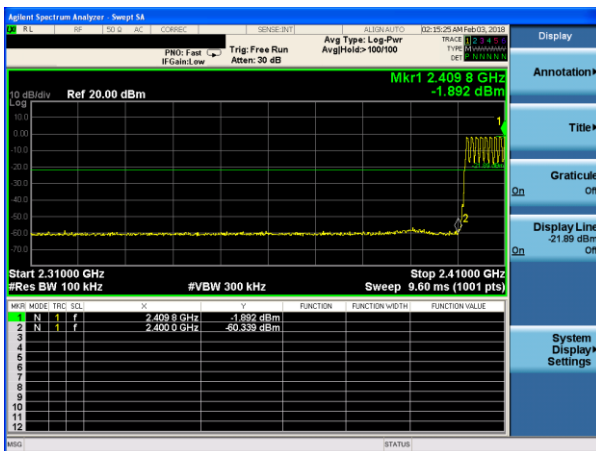

GFSK: Band Edge-High Channel (Hopping Mode)

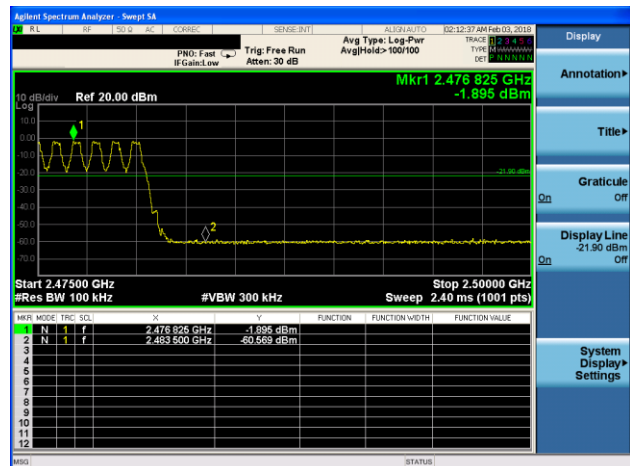

Test Plot

π /4-DQPSK: Band Edge-Low Channel

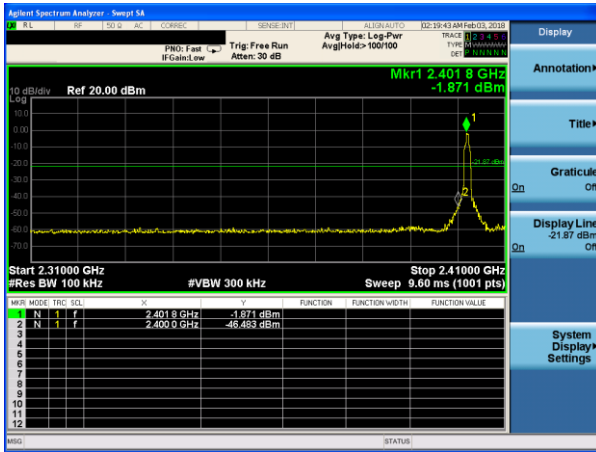

π /4-DQPSK: Band Edge-High Channel

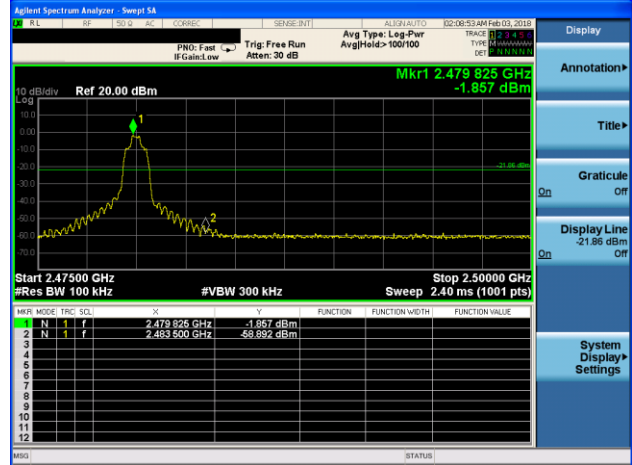

π /4-DQPSK: Band Edge-Low Channel
(Hopping Mode)

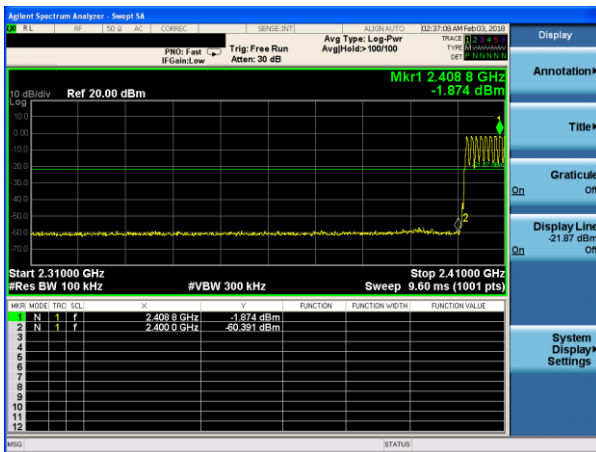

π /4-DQPSK: Band Edge-High Channel
(Hopping Mode)

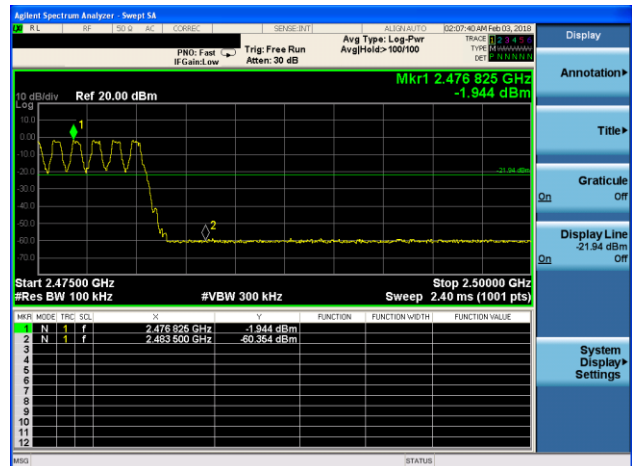

Test Plot

8-DPSK: Band Edge-Low Channel

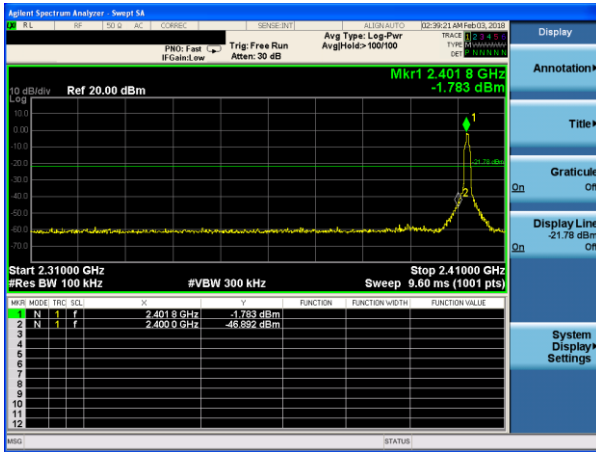

8-DPSK: Band Edge-High Channel

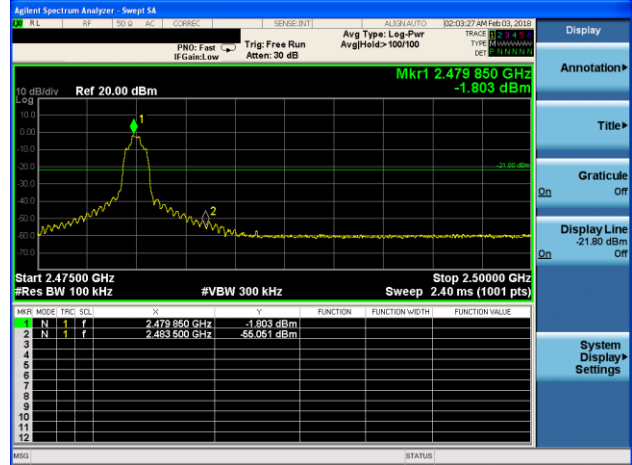

8-DPSK: Band Edge-Low Channel
(Hopping Mode)

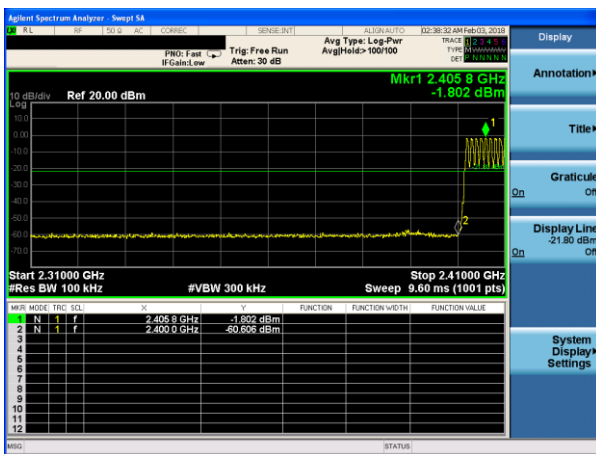

8-DPSK: Band Edge-High Channel (Hopping Mode)

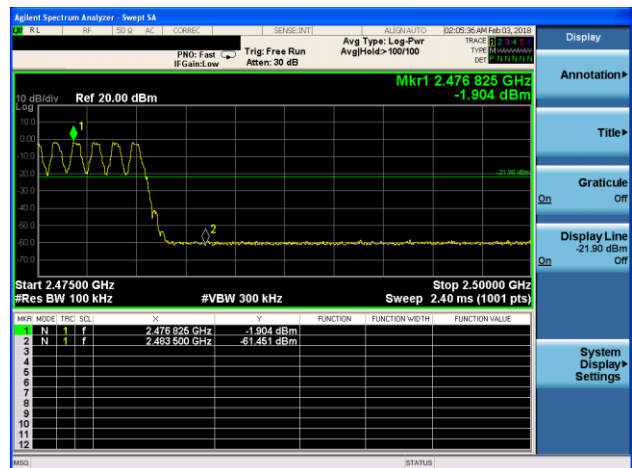

7.9 SPURIOUS RF CONDUCTED EMISSION

7.9.1 Applicable Standard

According to FCC Part 15.247(d) and ANSI C63.10-2013.

7.9.2 Conformance Limit

In any 100 kHz bandwidth outside the frequency band in which the spread spectrum or digitally modulated intentional radiator is operating, the radio frequency power that is produced by the intentional radiator shall be at least 20 dB below that in the 100 kHz bandwidth within the band that contains the highest level of the desired power, based on either an RF conducted or a radiated measurement, provided the transmitter demonstrates compliance with the peak conducted power limits. If the transmitter complies with the conducted power limits based on the use of RMS averaging over a time interval, as permitted under paragraph (b)(3) of this section, the attenuation required under this paragraph shall be 30 dB instead of 20 dB. Attenuation below the general limits specified in §15.209(a) is not required. In addition, radiated emissions which fall in the restricted bands, as defined in §15.205(a), must also comply with the radiated emission limits specified in §15.209(a) (see §15.205(c)).

7.9.3 Measuring Instruments

The Measuring equipment is listed in the section 6.3 of this test report.

7.9.4 Test Setup

Please refer to Section 6.1 of this test report.

7.9.5 Test Procedure

Establish an emission level by using the following procedure:

- a) Set the center frequency and span to encompass frequency range to be measured.
- b) Set the RBW = 100 kHz.
- c) Set the VBW $\geq [3 \times \text{RBW}]$.
- d) Detector = peak.
- e) Sweep time = auto couple.
- f) Trace mode = max hold.
- g) Allow trace to fully stabilize.
- h) Use the peak marker function to determine the maximum amplitude level.

Then the limit shall be attenuated by at least 20 dB relative to the maximum amplitude level in 100 kHz.

7.9.6 Test Results

Remark: The measurement frequency range is from 9KHz to the 10th harmonic of the fundamental frequency. The lowest, middle and highest channels are tested to verify the spurious emissions and bandedge measurement data.

The worst mode is 8-DPSK mode, and the report only show the worst mode data.

Test Plot(8-DPSK)

8-DPSK on channel 00



8-DPSK on channel 00

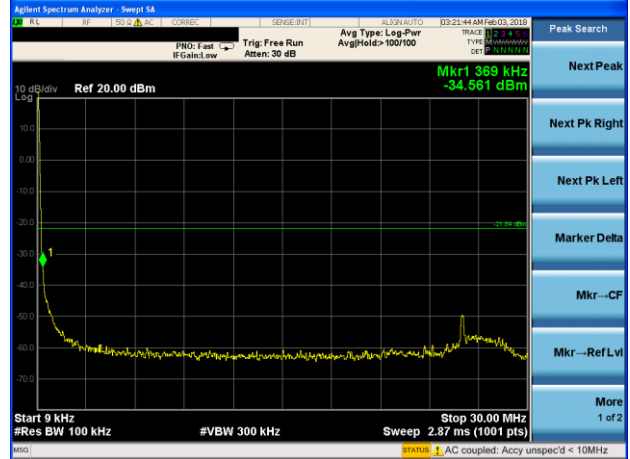

8-DPSK on channel 00

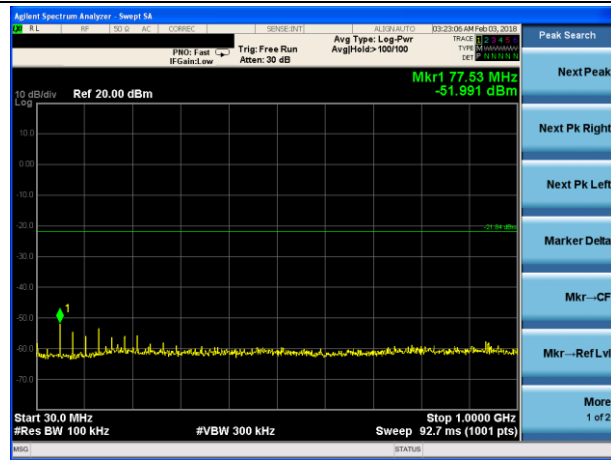

8-DPSK on channel 00



Test Plot

8-DPSK on channel 39



8-DPSK on channel 39

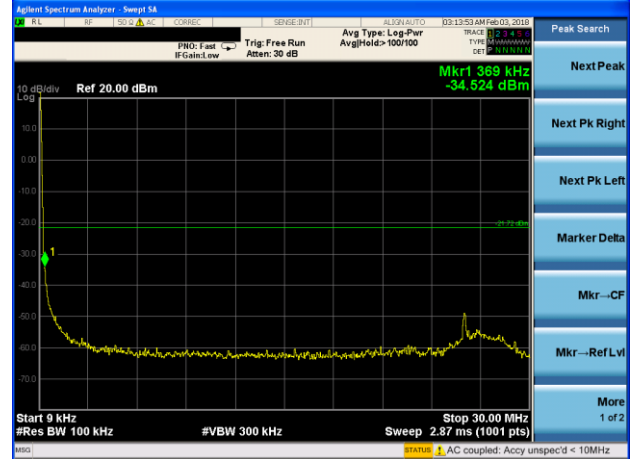

8-DPSK on channel 39

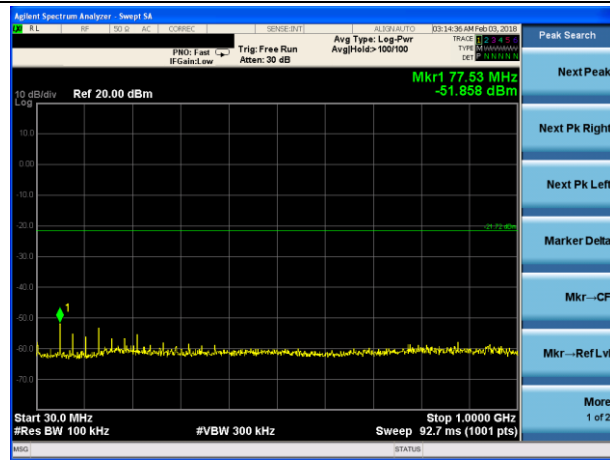

8-DPSK on channel 39



Test Plot

8-DPSK on channel 78



8-DPSK on channel 78

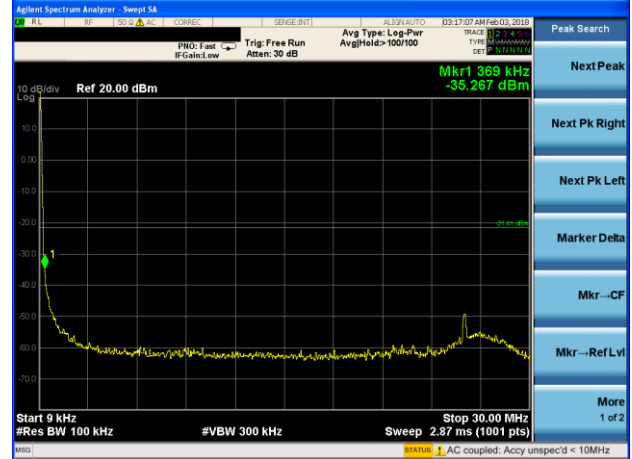

8-DPSK on channel 78

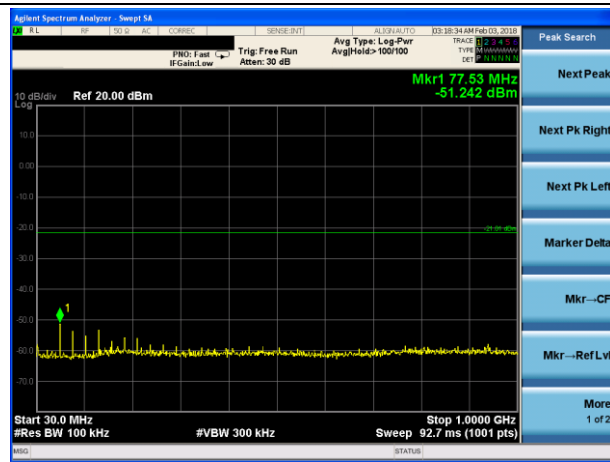

8-DPSK on channel 78

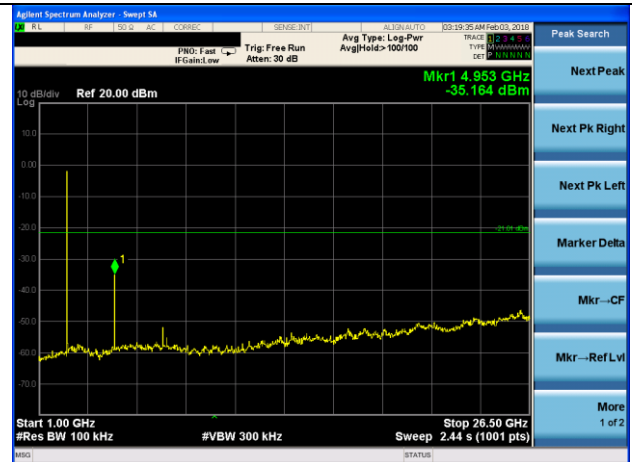

7.10 ANTENNA APPLICATION

7.10.1 Antenna Requirement

15.203 requirement: For intentional device, according to 15.203: an intentional radiator shall be designed to ensure that no antenna other than that furnished by the responsible party shall be used with the device.

7.10.2 Result

The EUT antenna is permanent attached PCB antenna(Gain:1dBi). It comply with the standard requirement.

END OF REPORT