



# FCC TEST REPORT

**Test report  
On Behalf of  
Wicked Technology Corporation  
For  
Two way radio  
Model No.: 953-01011-001**

**FCC ID: 2AN6PALPHA1**

**Prepared for :** Wicked Technology Corporation  
7785 E Redfield Rd, Suite 212, Scottsdale, Arizona, United States 85260

**Prepared By :** Shenzhen HUAKE Testing Technology Co., Ltd.  
1F, B2 Building, Junfeng Zhongcheng Zhizao Innovation Park, Fuhai Street, Bao'an District, Shenzhen City, China

**Date of Test:** Dec. 28, 2018~Mar. 07, 2019

**Date of Report:** Mar. 07, 2019

**Report Number:** HK1903070397E





Revision	Issue Date	Revisions	Revised By
V1.0	Mar. 07, 2019	Initial Issue	Jason Zhou



**TABLE OF CONTENTS**

**1. VERIFICATION OF COMPLIANCE ..... 5**

**2. PRODUCT INFORMATION ..... 6**

**3. IDENTIFICATION OF THE RESPONSIBLE TESTING LOCATION ..... 7**

**4. SUPPORT EQUIPMENT LIST ..... 8**

**5. SYSTEM DESCRIPTION ..... 8**

**6. SUMMARY OF TEST RESULTS ..... 9**

**7. FCC RADIATED EMISSION TEST ..... 10**

    7.1. TEST EQUIPMENT OF RADIATED EMISSION ..... 10

    7.2. LIMITS OF RADIATED EMISSION TEST ..... 10

    7.3 BLOCK DIAGRAM OF RADIATED EMISSION TEST ..... 10

    7.4 PROCEDURE OF RADIATED EMISSION TEST ..... 12

    7.5 TEST RESULT OF RADIATED EMISSION TEST ..... 13

**8. CONDUCTED EMISSION TEST ..... 15**

    8.1 PROVISIONS APPLICABLE ..... 15

    8.2 MEASUREMENT PROCEDURE ..... 15

    8.3 TEST SETUP BLOCK DIAGRAM ..... 16

    8.4 TEST RESULT ..... 17

**9. ANTENNA CONDUCTED POWER FOR RECEIVERS ..... 19**

**10. SCANNING RECEIVERS AND FREQUENCY CONVERTERS USED WITH SCANNING RECEIVERS... 22**

**APPENDIX 1 PHOTOGRAPHS OF TEST SETUP ..... 23**

**APPENDIX 2 PHOTOGRAPHS OF EUT ..... 25**



## 1. VERIFICATION OF COMPLIANCE

<b>Hardware Version</b>	2015 REV:3.11
<b>Software Version</b>	VER01.00
<b>Measurement Procedure</b>	ANSI C63.4: 2014
<b>Deviation:</b>	None
<b>Condition of Test Sample</b>	Normal

The test results of this report relate only to the tested sample identified in this report.



## 2. PRODUCT INFORMATION

The EUT is a Two way radio designed for voice communication. It is designed by way of utilizing the F3E modulation achieves the system operating.

A major technical description of EUT is described as following:

<b>Communication Type</b>	Voice / Tone only
<b>Modulation</b>	FM
<b>RX Frequency Range</b>	Rx: 450MHz-470MHz
<b>Emission Type</b>	F3E
<b>Antenna Designation</b>	Detachable
<b>Antenna Gain</b>	2.15dBi
<b>Power Supply</b>	DC 7.4V 1500mAh, charging with DC 8.4V.
<b>Charger Parameter</b>	INPUT:DC 12V 0.5A OUTPUT:DC 8.4V 0.5A
<b>Adapter Parameter</b>	AC:100-240V 50/60Hz 0.3A Output: 12V 0.5A

### I/O Port Information (Applicable Not Applicable)

I/O Port of EUT			
I/O Port Type	Q'TY	Cable	Tested with
DC Input Port	1	0	1
Antenna Connect Port	1	0	1

**3. IDENTIFICATION OF THE RESPONSIBLE TESTING LOCATION**

<b>Site</b>	Shenzhen HUAKE Testing Technology Co., Ltd.
<b>Location</b>	1F, B2 Building, Junfeng Zhongcheng Zhizao Innovation Park, Fuhai Street, Bao'an District, Shenzhen City, China
<b>Designation Number</b>	CN1229
Test Firm Registration Number : 616276	

**List Of Test Equipment:**

<b>Conducted Emission Shielding Room Test Site (744)</b>					
<b>Equipment</b>	<b>Manufacturer</b>	<b>Model</b>	<b>Serial Number</b>	<b>Cal. Date</b>	<b>Cal. Due</b>
Receiver	R&S	ESCI 7	HKE-010	Dec. 29, 2017	Dec. 28, 2018
Receiver	R&S	ESCI 7	HKE-010	Dec. 27, 2018	Dec. 26, 2019
LISN	R&S	ENV216	HKE-002	Dec. 29, 2017	Dec. 28, 2018
LISN	R&S	ENV216	HKE-002	Dec. 27, 2018	Dec. 26, 2019
Conducted test software	Tonscend	TS+ Rev 2.5.0.0	HKE-081	N/A	N/A

**TEST EQUIPMENT OF RADIATED EMISSION TEST**

<b>Equipment</b>	<b>Manufacturer</b>	<b>Model</b>	<b>S/N</b>	<b>Cal. Date</b>	<b>Cal. Due</b>
Broadband antenna	Schwarzbeck	VULB 9163	HKE-012	Dec. 29, 2017	Dec. 28, 2019
Receiver	R&S	ESCI 7	HKE-010	Dec. 29, 2017	Dec. 28, 2018
Receiver	R&S	ESCI 7	HKE-010	Dec. 27, 2018	Dec. 26, 2019
Preamplifier	Schwarzbeck	BBV 9743	HKE-006	Dec. 29, 2017	Dec. 28, 2018
Preamplifier	Schwarzbeck	BBV 9743	HKE-006	Dec. 27, 2018	Dec. 26, 2019
Position controller	Taiwan MF	MF7802	HKE-011	Dec. 29, 2017	Dec. 28, 2018
Position controller	Taiwan MF	MF7802	HKE-011	Dec. 27, 2018	Dec. 26, 2019
Horn antenna	Schwarzbeck	9120D	HKE-013	Dec. 29, 2017	Dec. 28, 2019
Vector Analyzer	Agilent	E4440A	S/N MY44303916	Mar.01,2018	Feb.28,2019
RF Communication Test Set	HP	HP8920B	HKE-089	June 12, 2018	June 11, 2019



#### 4. SUPPORT EQUIPMENT LIST

Device Type	Manufacturer	Model Name	Serial No.	Data Cable	Power Cable
--	--	--	--	--	--

#### 5. SYSTEM DESCRIPTION

**EUT test procedure:**

1. Connect EUT and peripheral devices.
2. Power on the EUT, the EUT begins to work.
3. Make sure the EUT normal working.

**EMC TEST MODES**

No.	TEST MODES
1	Scanning mode
2	Scanning stopped/Receiving at low channel of 450 MHz -470 MHz
3	Scanning stopped/Receiving at middle channel of 450 MHz -470 MHz
4	Scanning stopped/Receiving at high channel of 450 MHz -470 MHz

**Note:** Only the result of the worst case was recorded in the report.



**6. SUMMARY OF TEST RESULTS**

FCC Rules	Description Of Test	Result
§15.107	Conduction Emission	Compliant
§15.109	Radiated Emission	Compliant
§15.111	Antenna Conducted Power for receivers	Compliant
§15.121(b)	Scanning receivers and frequency converters used with scanning receivers	Compliant



## 7. FCC RADIATED EMISSION TEST

### 7.1. TEST EQUIPMENT OF RADIATED EMISSION

### 7.2. LIMITS OF RADIATED EMISSION TEST

Frequency (MHz)	Distance (m)	Maximum Field Strength Limit (dBuV/m/ Q.P.)
30~88	3	41.0
88~216	3	45.0
216~960	3	48.0
960~2000	3	53.5

\*\*Note: The lower limit shall apply at the transition frequency. Because the EUT RX frequency range up to 480 MHz, so the upper the frequency range up to 2 GHz.

### 7.3 BLOCK DIAGRAM OF RADIATED EMISSION TEST

RADIATED EMISSION TEST SETUP 30MHz-1000MHz

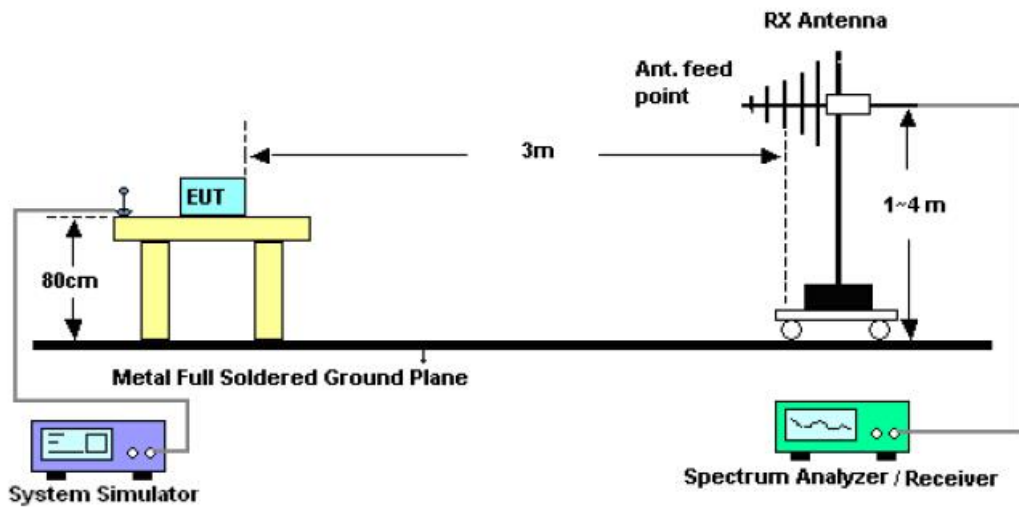



### RADIATED EMISSION TEST SETUP ABOVE 1000MHz

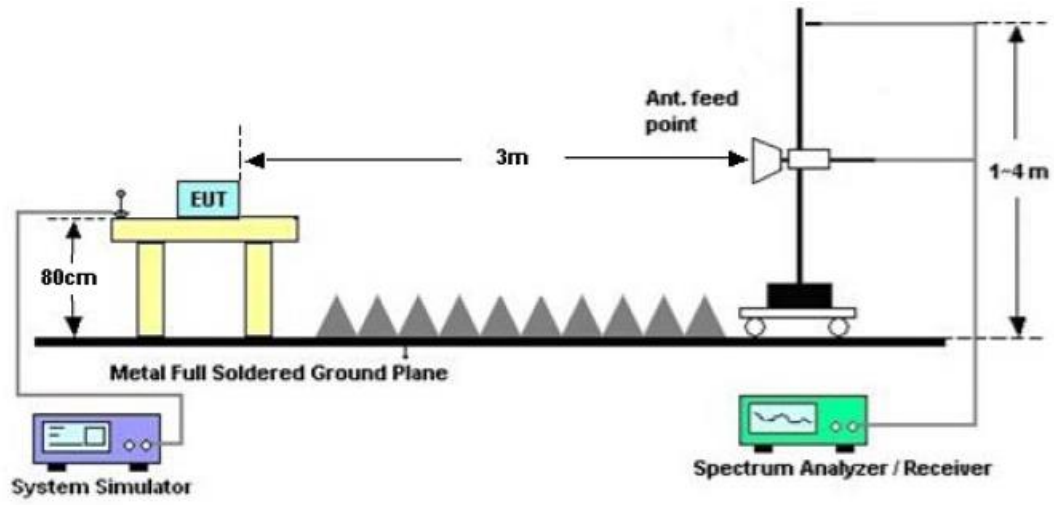



#### 7.4 PROCEDURE OF RADIATED EMISSION TEST

- 1) The equipment was set up as per the test configuration to simulate typical actual usage per the user's manual. When the EUT is a tabletop system, a wooden turntable with a height of 0.8 meters is used which is placed on the ground plane as per ANSI C63.4 (see Test Facility for the dimensions of the ground plane used). When the EUT is floor-standing equipment, it is placed on the ground plane which has a 3-12 mm non-conductive covering to insulate the EUT from the ground plane.
- 2) Support equipment, if needed, was placed as per ANSI C63.4.
- 3) All I/O cables were positioned to simulate typical actual usage as per ANSI C63.4.
- 4) The EUT received power by AC 120V/60Hz.
- 5) The antenna was placed at 3 meter away from the EUT as stated in FCC Part 15. The antenna connected to the Analyzer via a cable and at times a pre-amplifier would be used.
- 6) The Analyzer / Receiver quickly scanned from 30MHz to 1000MHz. The EUT test program was started. Emissions were scanned and measured rotating the EUT to 360 degrees and positioning the antenna 1 to 4 meters above the ground plane, in both the vertical and the horizontal polarization, to maximize the emission reading level.
- 7) The test mode(s) were scanned during the test:
- 8) Recorded at least the six highest emissions. Emission frequency, amplitude, antenna position, polarization and turntable position were recorded into a computer in which correction factors were used to calculate the emission level and compare reading to the applicable limit and Q.P./Peak reading is presented. For emissions below 1GHz, use 120KHz RBW and  $VBW \geq 3RBW$  for QP reading.
- 9) For emissions above 1GHz, use 1MHz RBW and 3MHz VBW for peak reading. Then 1MHz RBW and 10Hz VBW for average reading in spectrum analyzer.
- 10) When the radiated emissions limits are expressed in terms of the average value of the emissions, and pulsed operation is employed, the measurement field strength shall be determined by averaging over one complete pulse train, including blanking intervals, as long as the pulse train does not exceed 0.1 seconds. As an alternative (provided the transmitter operates for longer than 0.1 seconds) or in cases where the pulse train exceeds 0.1 seconds, the measured field strength shall be determined from the average absolute voltage during a 0.1 second interval during which the field strength is at its maximum values.
- 11) If the emissions level of the EUT in peak mode was 3 dB lower than the average limit specified, then testing will be stopped and peak values of EUT will be reported, otherwise, the emissions which do not have 3 dB margin will be repeated one by one using the quasi-peak method for below 1GHz.
- 12) For testing above 1GHz, the emissions level of the EUT in peak mode was lower than average limit (that means the emissions level in peak mode also complies with the limit in average mode), then testing will be stopped and peak values of EUT will be reported, otherwise, the emissions will be measured in average mode again and reported.
- 13) In case the emission is lower than 30MHz, loop antenna has to be used for measurement and the recorded data should be QP measured by receiver. High - Low scan is not required in this case.
- 14) The test data of the worst case condition (mode 1) was reported on the following Data page



### 7.5 TEST RESULT OF RADIATED EMISSION TEST

#### Radiated Emission Test –Horizontal -3m Below 1G

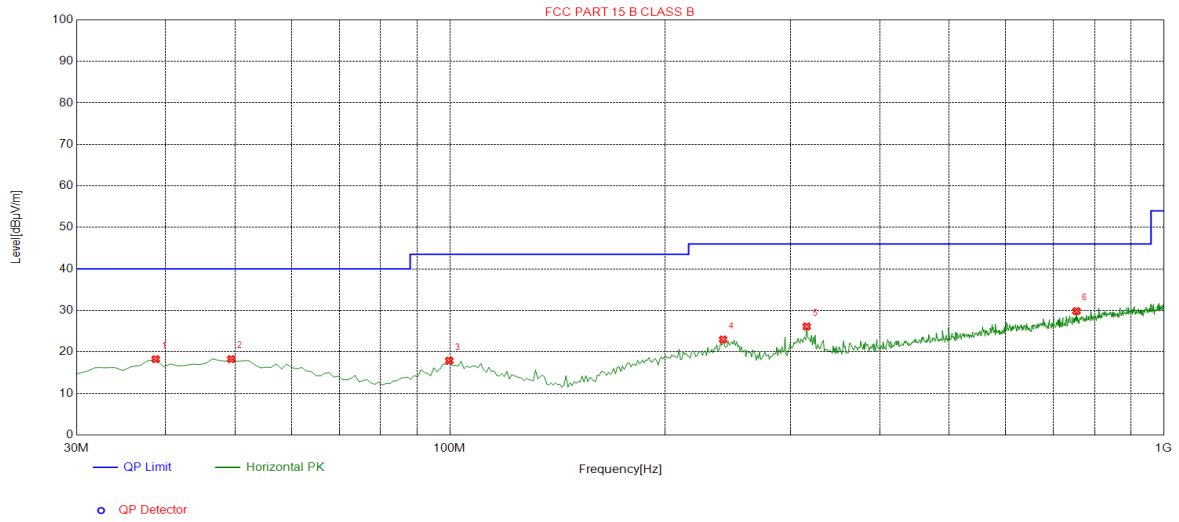

Suspected List								
NO.	Freq. [MHz]	Level [dBµV/m]	Factor [dB]	Limit [dBµV/m]	Margin [dB]	Height [cm]	Angle [°]	Polarity
1	38.7300	18.25	-14.95	40.00	21.75	100	153	Horizontal
2	49.4000	18.26	-13.65	40.00	21.74	100	134	Horizontal
3	99.8400	17.89	-15.43	43.50	25.61	100	317	Horizontal
4	241.460	22.99	-13.79	46.00	23.01	100	326	Horizontal
5	316.150	26.14	-12.30	46.00	19.86	100	260	Horizontal
6	754.590	29.83	-3.61	46.00	16.17	100	343	Horizontal

**RESULT: PASS**



Radiated Emission Test –Vertical -3m Below 1G

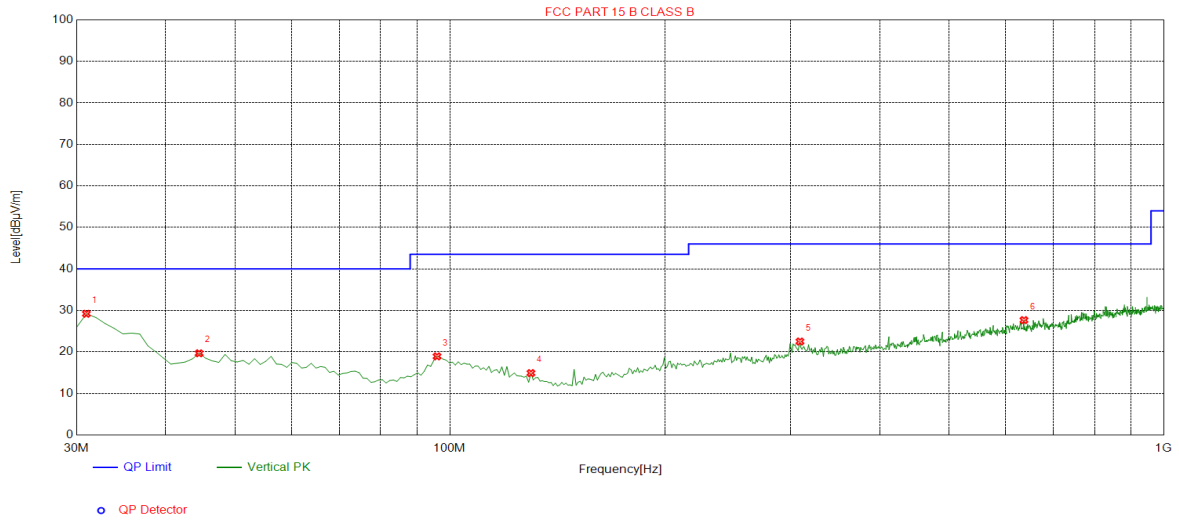

Suspected List								
NO.	Freq. [MHz]	Level [dBµV/m]	Factor [dB]	Limit [dBµV/m]	Margin [dB]	Height [cm]	Angle [°]	Polarity
1	30.9700	29.19	-16.30	40.00	10.81	100	343	Vertical
2	44.5500	19.67	-13.73	40.00	20.33	100	350	Vertical
3	95.9600	18.92	-16.07	43.50	24.58	100	293	Vertical
4	129.910	14.90	-18.56	43.50	28.60	100	103	Vertical
5	309.360	22.50	-12.62	46.00	23.50	100	15	Vertical
6	637.220	27.66	-5.60	46.00	18.34	100	24	Vertical

**RESULT: PASS**

- Note:**
1. Factor=Antenna Factor + Cable loss - Amplifier gain, Margin=Measurement-Limit.
  2. The "Factor" value can be calculated automatically by software of measurement system.
  3. Emissions range from 1GHz to 2GHz have 20dB margin. No recording in the test report.
  4. Only the data of the worst case would be record in this test report.



## 8. CONDUCTED EMISSION TEST

### 8.1 PROVISIONS APPLICABLE

For an intentional radiator that is designed to be connected to the public utility (AC) power line, the radio frequency voltage that is conducted back onto the AC power line on any frequencies within the band 150 KHz to 30 MHz shall not exceed the limits in the following table, as measured using a 50uH/50 ohms line impedance stabilization network (LISN). Compliance with the provisions of this paragraph shall be based on the measurement of the radio frequency voltage between each power line and ground at the power terminal. The lower limit applies at the boundary between the frequencies ranges.

Frequency of Emission (MHz)	Conducted Limit(dBuV)	
	Quasi-Peak	Average
0.15 – 0.5	66 to 56 *	56 to 46 *
0.5 – 5	56	46
5 – 30	60	50

\* Decreases with the logarithm of the frequency.

### 8.2 MEASUREMENT PROCEDURE

- (1) The equipment was set up as per the test configuration to simulate typical actual usage per the user's manual. When the EUT is a tabletop system, a wooden table with a height of 0.8 meters is used and is placed on the ground plane as per ANSI C63.4 (see Test Facility for the dimensions of the ground plane used). When the EUT is a floor-standing equipment, it is placed on the ground plane which has a 3-12 mm non-conductive covering to insulate the EUT from the ground plane.
- (2) Support equipment, if needed, was placed as per ANSI C63.4.
- (3) All I/O cables were positioned to simulate typical actual usage as per ANSI C63.4.
- (4) The EUT received AC 120V/60Hz power through a Line Impedance Stabilization Network (LISN) which supplied power source and was grounded to the ground plane.
- (5) All support equipments received AC power from a second LISN, if any.
- (6) The EUT test program was started. Emissions were measured on each current carrying line of the EUT using a spectrum Analyzer / Receiver connected to the LISN powering the EUT. The LISN has two monitoring points: Line 1 (Hot Side) and Line 2 (Neutral Side). Two scans were taken: one with Line 1 connected to Analyzer / Receiver and Line 2 connected to a 50 ohm load; the second scan had Line 1 connected to a 50 ohm load and Line 2 connected to the Analyzer / Receiver.
- (7) Analyzer / Receiver scanned from 150 KHz to 30MHz for emissions in each of the test modes.

During the above scans, the emissions were maximized by cable manipulation.



### 8.3 TEST SETUP BLOCK DIAGRAM

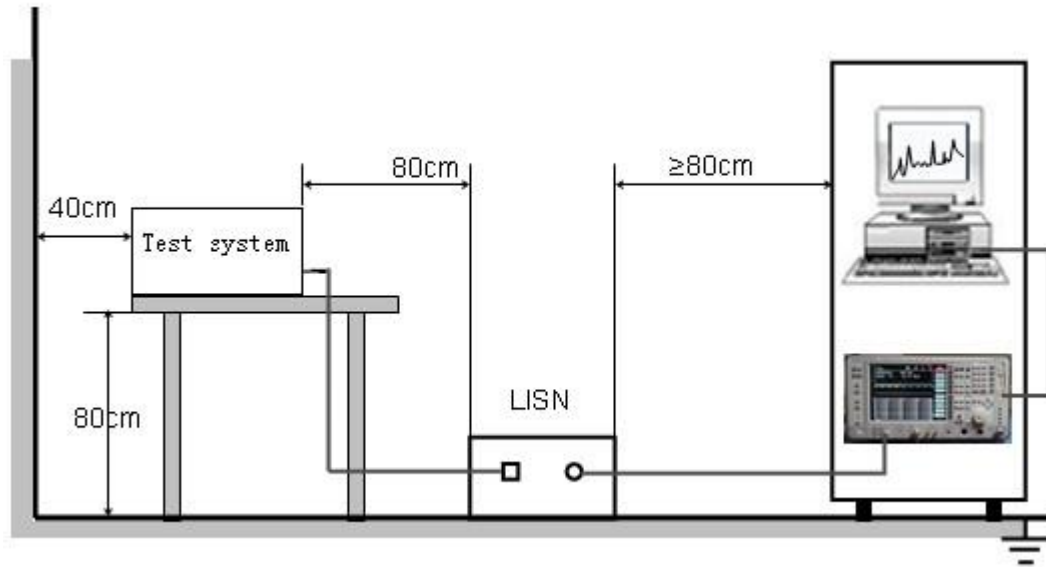





8.4 TEST RESULT

CONDUCTED EMISSION TEST – LINE L

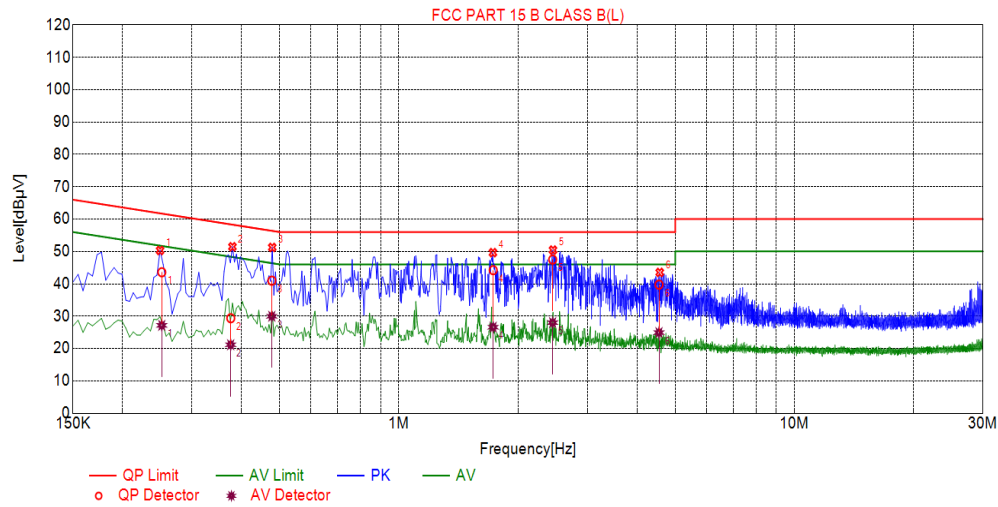

Suspected List						
NO.	Freq. [MHz]	Level [dBµV]	Factor [dB]	Limit [dBµV]	Margin [dB]	Detector
1	0.2490	50.30	10.04	61.79	11.49	PK
2	0.3795	51.46	10.05	58.29	6.83	PK
3	0.4785	51.25	10.04	56.37	5.12	PK
4	1.7295	49.64	10.13	56.00	6.36	PK
5	2.4540	50.44	10.19	56.00	5.56	PK
6	4.5690	43.52	10.25	56.00	12.48	PK

Final Data List								
NO.	Freq. [MHz]	Factor [dB]	QP Value [dBµV]	QP Limit [dBµV]	QP Margin [dB]	AV Value [dBµV]	AV Limit [dBµV]	AV Margin [dB]
1	0.2515	10.04	43.59	61.71	18.12	27.17	51.71	24.54
2	0.3757	10.05	29.37	58.37	29.00	21.17	48.37	27.20
3	0.4773	10.04	40.98	56.39	15.41	29.98	46.39	16.41
4	1.7317	10.13	44.24	56.00	11.76	26.60	46.00	19.40
5	2.4488	10.19	47.51	56.00	8.49	28.01	46.00	17.99
6	4.5488	10.25	39.77	56.00	16.23	24.93	46.00	21.07

RESULT: PASS



CONDUCTED EMISSION TEST – LINE N

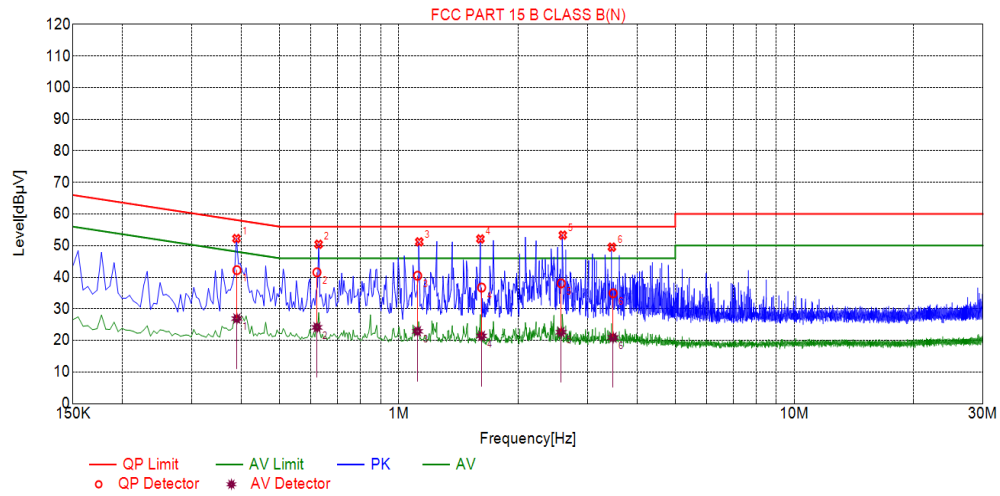

Suspected List						
NO.	Freq. [MHz]	Level [dBµV]	Factor [dB]	Limit [dBµV]	Margin [dB]	Detector
1	0.3885	52.24	10.04	58.10	5.86	PK
2	0.6270	50.43	10.05	56.00	5.57	PK
3	1.1265	51.19	10.08	56.00	4.81	PK
4	1.6080	52.12	10.11	56.00	3.88	PK
5	2.5980	53.33	10.21	56.00	2.67	PK
6	3.4575	49.51	10.25	56.00	6.49	PK

Final Data List								
NO.	Freq. [MHz]	Factor [dB]	QP Value [dBµV]	QP Limit [dBµV]	QP Margin [dB]	AV Value [dBµV]	AV Limit [dBµV]	AV Margin [dB]
1	0.3894	10.04	42.25	58.08	15.83	26.92	48.08	21.16
2	0.6207	10.05	41.56	56.00	14.44	24.13	46.00	21.87
3	1.1153	10.08	40.48	56.00	15.52	22.89	46.00	23.11
4	1.6188	10.11	36.74	56.00	19.26	21.43	46.00	24.57
5	2.5736	10.20	38.06	56.00	17.94	22.61	46.00	23.39
6	3.4817	10.25	34.94	56.00	21.06	20.95	46.00	25.05

**RESULT: PASS**



## 9. ANTENNA CONDUCTED POWER FOR RECEIVERS

### LIMIT

The antenna conducted power of the receiver as defined in §15.111 shall not exceed the values given in the following tables

Frequency Range	9 KHz to 2GHz
Limit	2.0 nW (-57 dBm )

### TEST CONFIGURATION

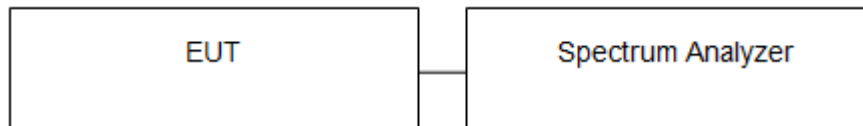

### TEST PROCEDURE

1. The receiver antenna terminal connected to a spectrum analyzer.
2. The test data of the worst case condition (mode 1) was reported on the following Data page.



**TEST RESULTS**

**Conducted Measurement (9 KHz to 150 KHz)**

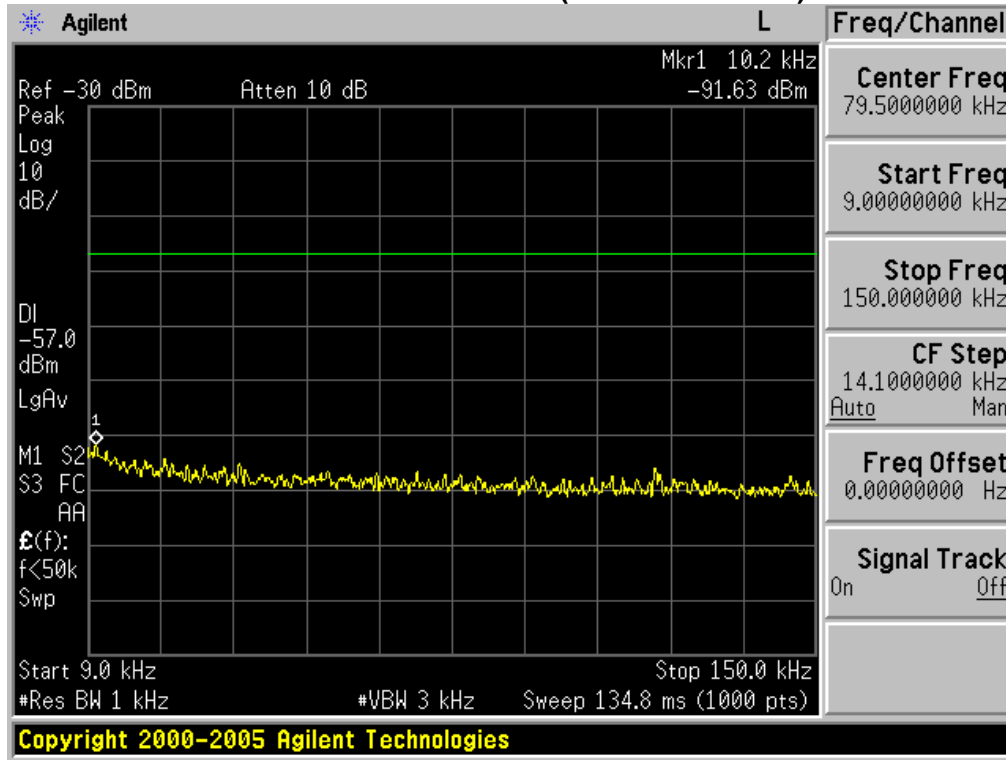

**Conducted Measurement (150 KHz to 30MHz)**

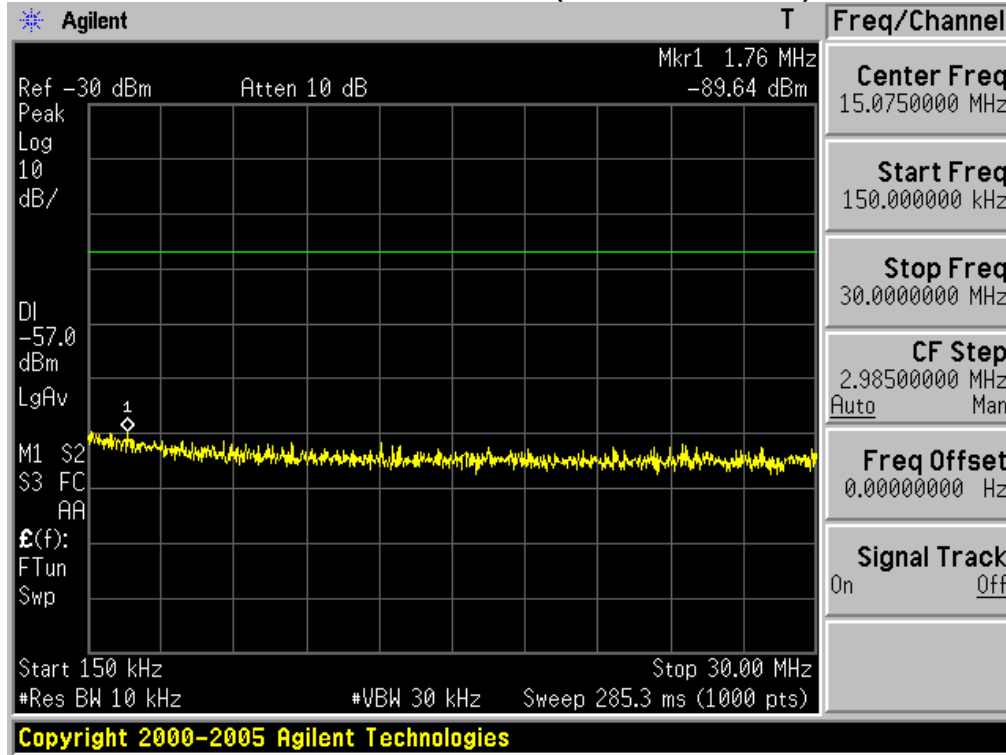



### Conducted Measurement (30MHz to 1GHz)

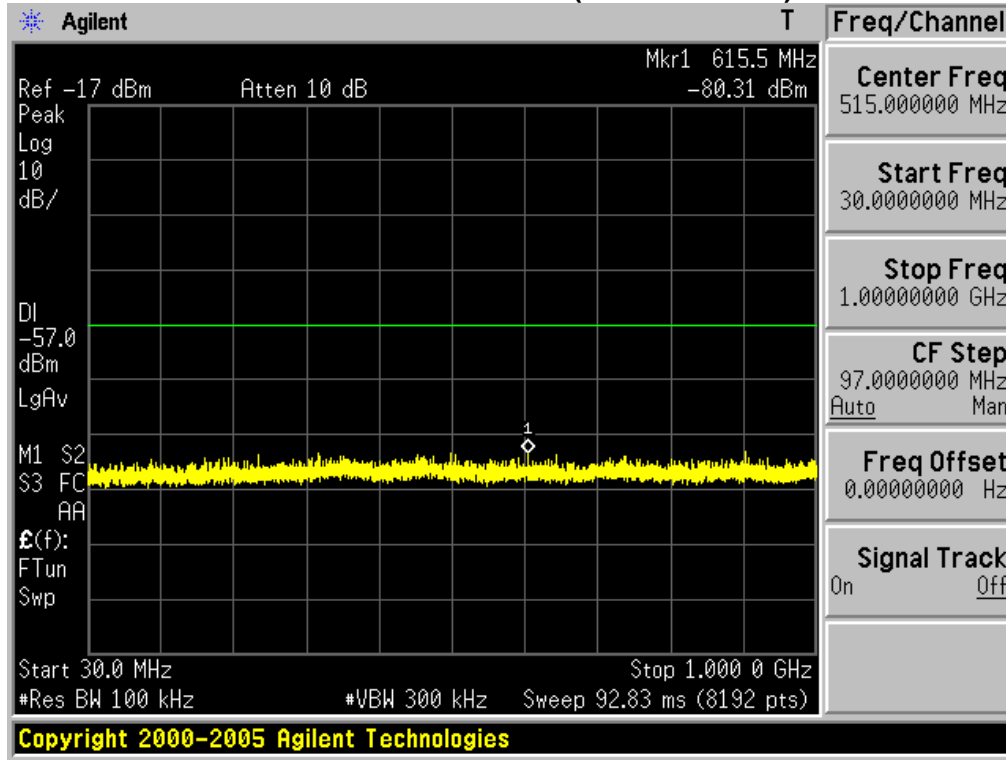

### Conducted Measurement (1GHz to 2GHz)

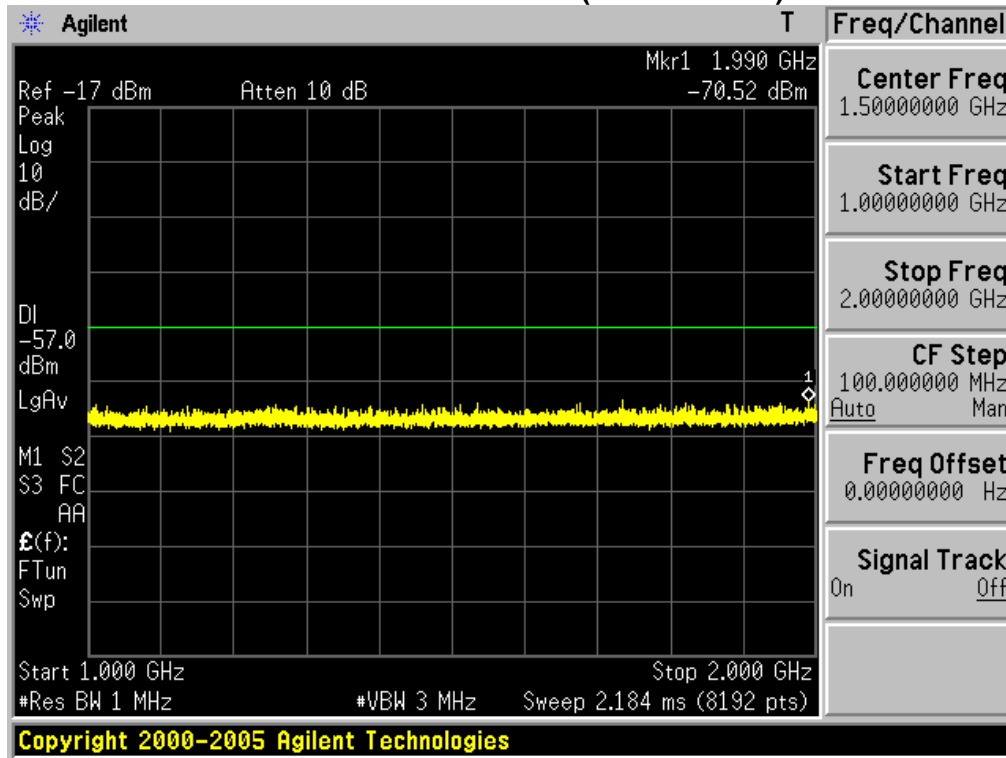

PASS



### 10. SCANNING RECEIVERS AND FREQUENCY CONVERTERS USED WITH SCANNING RECEIVERS.

#### LIMIT

Except as provided in paragraph (c) of this section, scanning receivers shall reject any signals from the Cellular Radiotelephone Service frequency bands that are 38 dB or lower based upon a 12 dB SINAD measurement, which is considered the threshold where a signal can be clearly discerned from any interference that may be present.

#### TEST CONFIGURATION

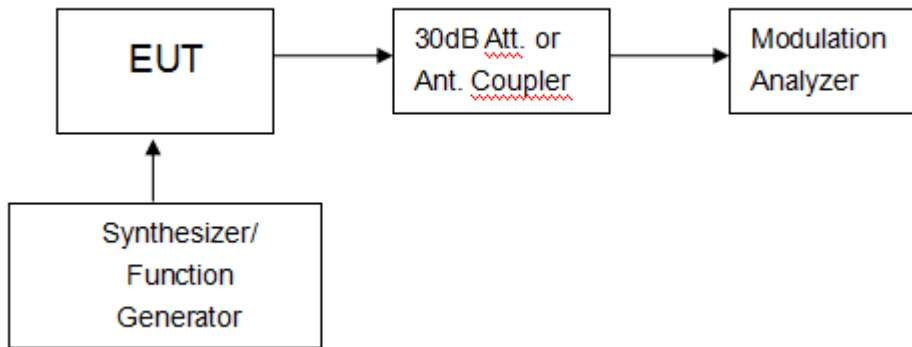

#### TEST PROCEDURE

Please review the FCC Part 15.121 b section requirements to meet the testing process

#### TEST RESULTS

UHF:

Frequency Range(MHz)	Channel	Measurement Result (dB)	Limit(dB)	Result
450-470	Bottom	42	> 38	Pass
450-470	Middle	41	> 38	Pass
450-470	Top	44	> 38	Pass

Note:1.This device meets the requirements of FCC PART 15.121.b

2.The test report only shows the worst test results



### APPENDIX 1 PHOTOGRAPHS OF TEST SETUP CONDUCTED EMISSION TEST SETUP



RADIATED EMISSION TEST SETUP

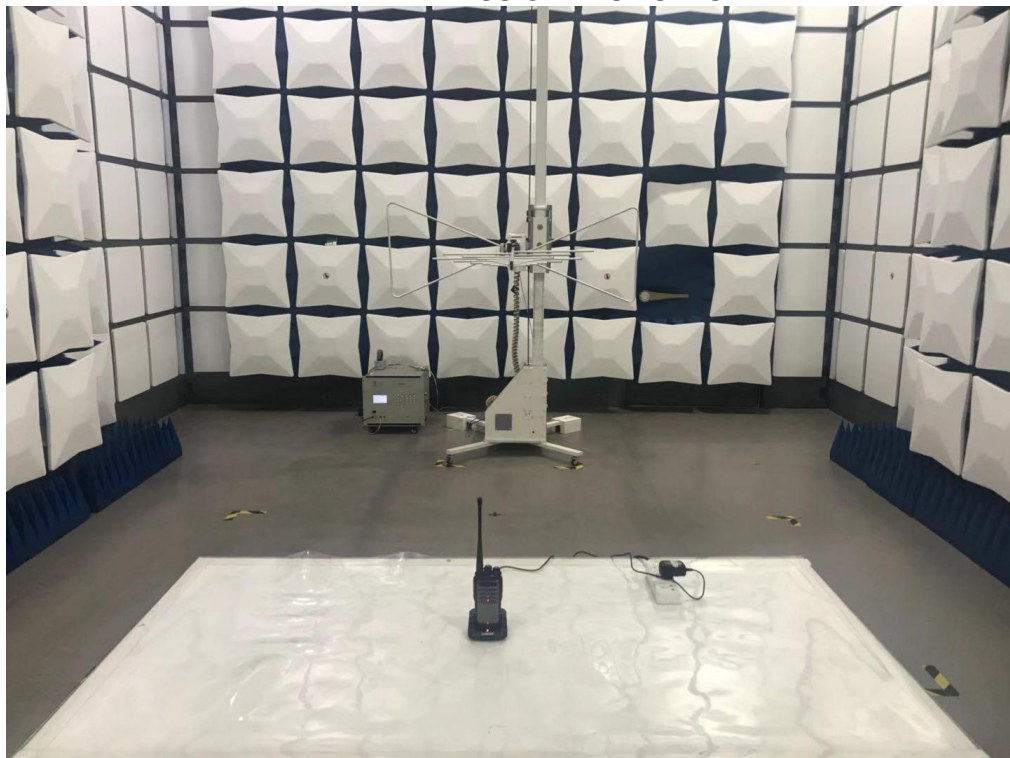



RADIATED EMISSION ABOVE 1G TEST SETUP

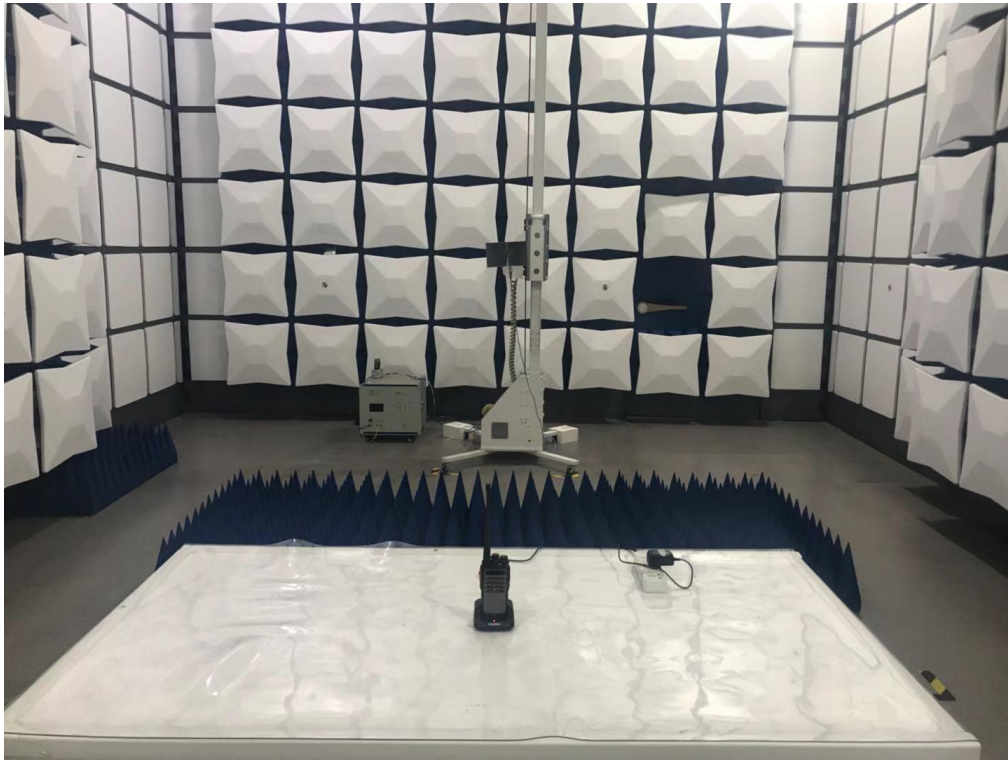





## APPENDIX 2 PHOTOGRAPHS OF EUT

TOTAL VIEW OF EUT



TOP VIEW OF EUT





BOTTOM VIEW OF EUT



FRONT VIEW OF EUT







BACK VIEW OF EUT



LEFT VIEW OF EUT





RIGHT VIEW OF EUT



OPEN VIEW-1 OF EUT







OPEN VIEW-2 OF EUT

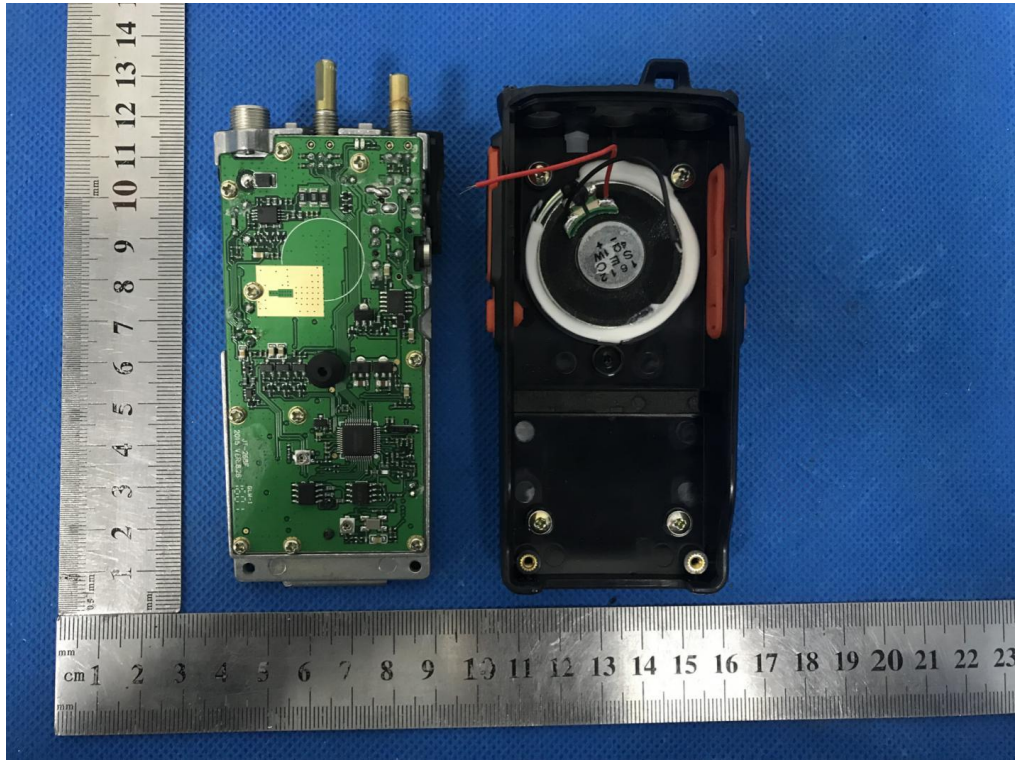

OPEN VIEW-3 OF EUT

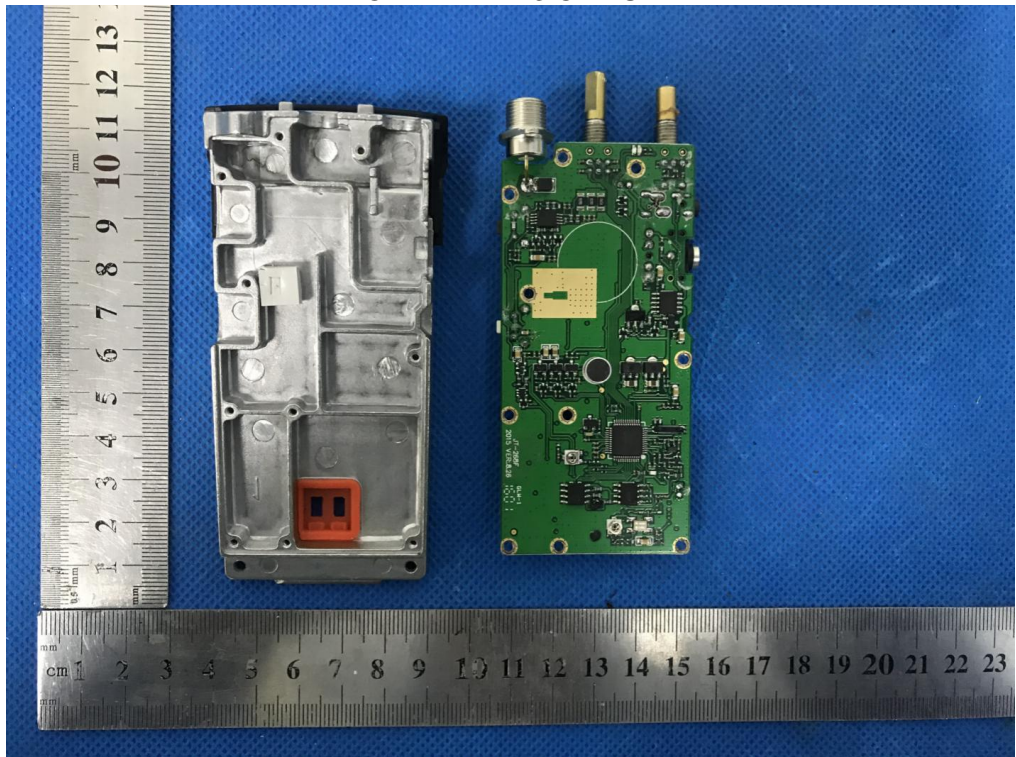





INTERNAL VIEW-1 OF EUT

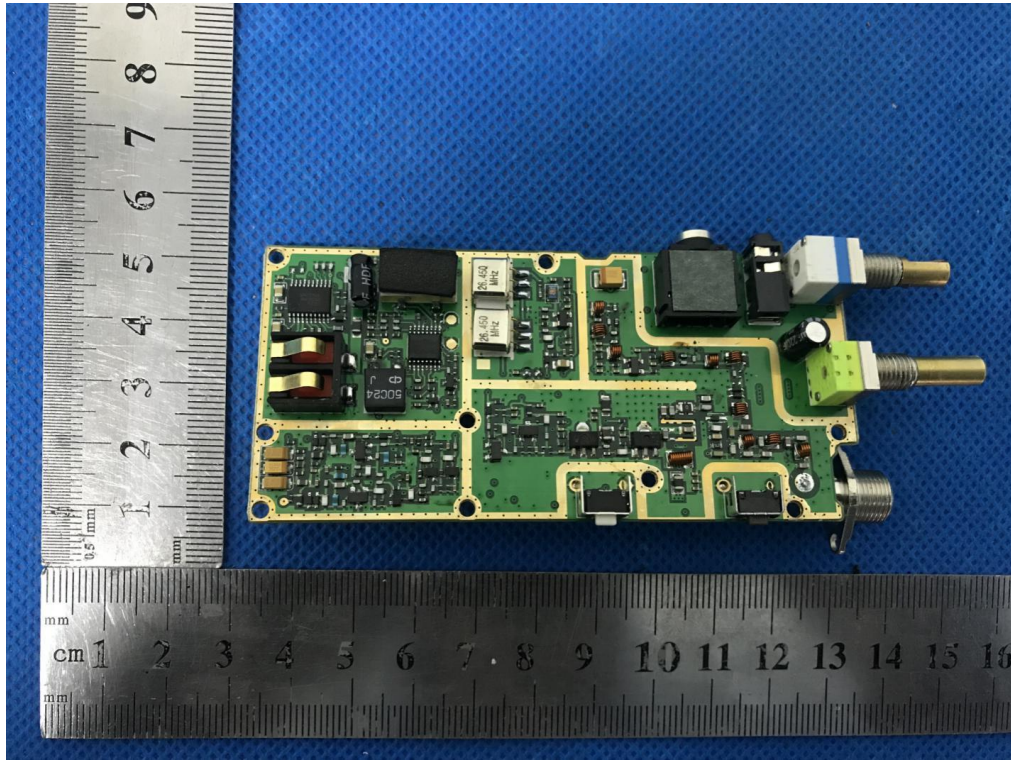

INTERNAL VIEW-2 OF EUT

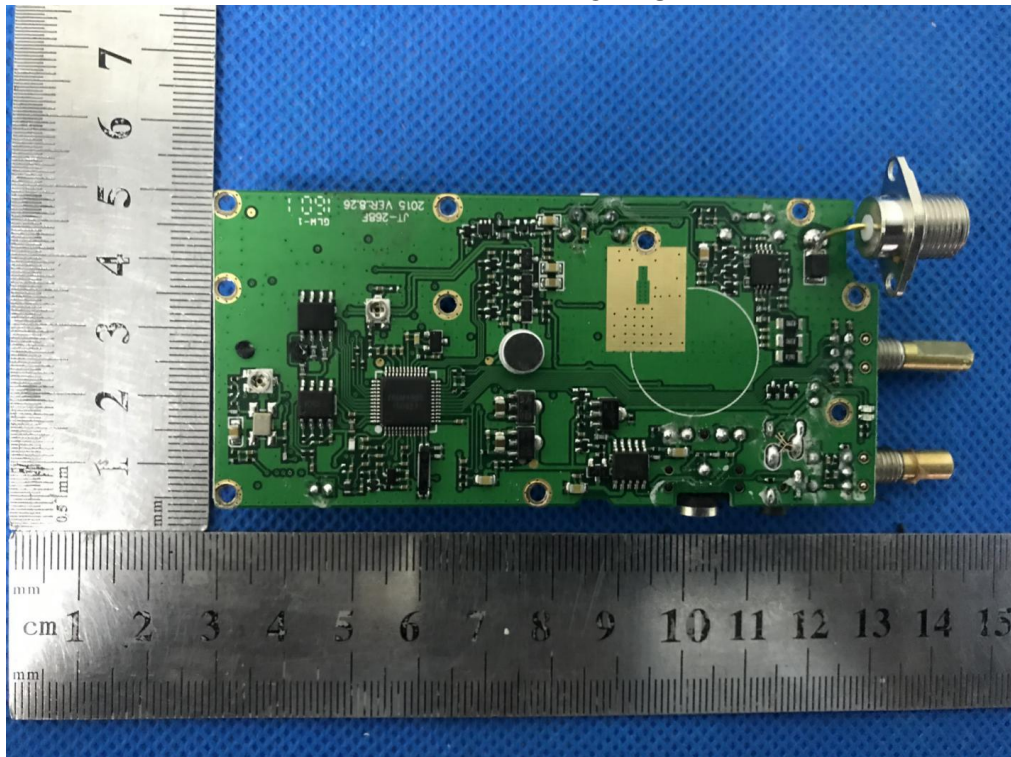



INTERNAL VIEW-3 OF EUT

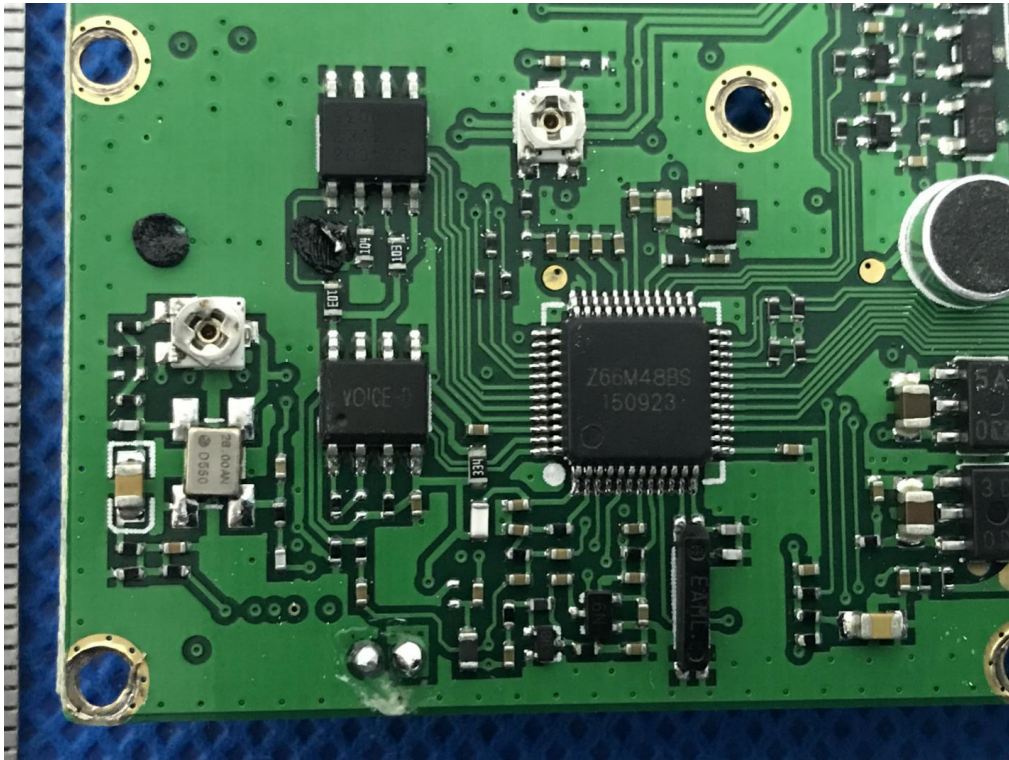

----END OF REPORT----