

APPLICATION CERTIFICATION FCC Part 15C  
On Behalf of

PURE TOY LIMITED

Video Camera Drone With LED Lights  
Model No.: 205981-01

FCC ID: 2AN6G-S13

Prepared for : PURE TOY LIMITED  
Address : Chenghua Toys Industrial Zone, Chenghai, Shantou,  
Guangdong, 515800, China

Prepared by : Shenzhen Accurate Technology Co., Ltd.  
Address : 1/F., Building A, Changyuan New Material Port, Science  
& Industry Park, Nanshan District, Shenzhen, Guangdong,  
P.R. China.

Tel: (0755) 26503290  
Fax: (0755) 26503396

Report Number : ATE20171776  
Date of Test : Sep. 15, 2017  
Date of Report : Sep. 27, 2017

## TABLE OF CONTENTS

Description	Page
Test Report Certification	
<b>1. GENERAL INFORMATION .....</b>	<b>4</b>
1.1. Description of Device (EUT).....	4
1.2. Frequency list.....	4
1.3. Special Accessory and Auxiliary Equipment .....	4
1.4. Description of Test Facility .....	5
1.5. Measurement Uncertainty.....	5
<b>2. MEASURING DEVICE AND TEST EQUIPMENT .....</b>	<b>6</b>
<b>3. OPERATION OF EUT DURING TESTING .....</b>	<b>7</b>
3.1. Operating Mode.....	7
3.2. Configuration and peripherals .....	7
<b>4. TEST PROCEDURES AND RESULTS .....</b>	<b>8</b>
<b>5. 20DB BANDWIDTH MEASUREMENT.....</b>	<b>9</b>
5.1. Block Diagram of Test Setup.....	9
5.2. The Requirement For Section 15.215(c).....	9
5.3. Operating Condition of EUT .....	9
5.4. Test Procedure .....	9
5.5. Test Result .....	10
<b>6. BAND EDGE COMPLIANCE TEST .....</b>	<b>12</b>
6.1. Block Diagram of Test Setup.....	12
6.2. The Requirement For Section 15.249.....	12
6.3. EUT Configuration on Measurement .....	12
6.4. Operating Condition of EUT .....	13
6.5. Test Procedure .....	13
6.6. Test Result .....	13
<b>7. RADIATED SPURIOUS EMISSION TEST .....</b>	<b>18</b>
7.1. Block Diagram of Test Setup.....	18
7.2. The Limit For Section 15.249.....	19
7.3. Restricted bands of operation .....	20
7.4. Configuration of EUT on Measurement .....	20
7.5. Operating Condition of EUT .....	21
7.6. Test Procedure .....	21
7.7. Data Sample.....	22
7.8. The Field Strength of Radiation Emission Measurement Results .....	22
<b>8. ANTENNA REQUIREMENT.....</b>	<b>35</b>
8.1. The Requirement .....	35
8.2. Antenna Construction .....	35
<b>9. PHOTO OF EUT.....</b>	<b>36</b>

## Test Report Certification

Applicant : PURE TOY LIMITED  
Address : Chenghua Toys Industrial Zone, Chenghai, Shantou, Guangdong, 515800, China  
Manufacturer : PURE TOY LIMITED  
Address : Chenghua Toys Industrial Zone, Chenghai, Shantou, Guangdong, 515800, China  
Product : Video Camera Drone With LED Lights  
Model No. : 205981-01  
(Please refer to the detailed description about coverage models on page 4)  
Trade name : N/A

Measurement Procedure Used:

**FCC Rules and Regulations Part 15 Subpart C Section 15.249**  
**ANSI C63.10: 2013**

The EUT was tested according to FCC 47CFR 15.249 for compliance to FCC 47CFR 15.249 requirements

The device described above is tested by Shenzhen Accurate Technology Co., Ltd. to determine the maximum emission levels emanating from the device. The maximum emission levels are compared to the FCC Part 15 Subpart C Section 15.249 limits. The measurement results are contained in this test report and Shenzhen Accurate Technology Co., Ltd. is assumed full responsibility for the accuracy and completeness of these measurements. Also, this report shows that the Equipment Under Test (EUT) is to be technically compliant with the FCC requirements.

This report applies to above tested sample only. This report shall not be reproduced in part without written approval of Shenzhen Accurate Technology Co., Ltd.

Date of Test : Sep. 15, 2017  
Date of Report : Sep. 27, 2017

Prepared by : \_\_\_\_\_  
(Star Yang, Engineer)

Approved & Authorized Signer : \_\_\_\_\_  
(Sean Liu, Manager)



# 1. GENERAL INFORMATION

## 1.1. Description of Device (EUT)

Product	:	Video Camera Drone With LED Lights
Main test model Number	:	205981-01,
List model Number	:	S13, S31, S32, S33, S34, S35, S36, S37, S38, S39, S40, S41, S42, S43, S45, S46, S47, S48, S49, S50
Frequency Range	:	2420-2460MHz
Number of Channels	:	41
Modulation Type	:	GFSK
Type of Antenna	:	Integral Antenna
Max antenna gain	:	1dBi
Power Supply	:	DC 4.5V (Powered by battery)

## 1.2. Frequency list

serial	channel	serial	channel	serial	channel	serial	channel
1	2420	13	2432	25	2444	37	2456
2	2421	14	2433	26	2445	38	2457
3	2422	15	2434	27	2446	39	2458
4	2423	16	2435	28	2447	40	2459
5	2424	17	2436	29	2448	41	2460
6	2425	18	2437	30	2449	42	
7	2426	19	2438	31	2450	43	
8	2427	20	2439	32	2451	44	
9	2428	21	2440	33	2452	45	
10	2429	22	2441	34	2453	46	
11	2430	23	2442	35	2454	47	
12	2431	24	2443	36	2455	48	

## 1.3. Special Accessory and Auxiliary Equipment

N/A

## 1.4. Description of Test Facility

EMC Lab	: Recognition of accreditation by Federal Communications Commission (FCC) The Designation Number is CN1189 The Registration Number is 708358
	Listed by Innovation, Science and Economic Development Canada (ISED) The Registration Number is 5077A-2
	Accredited by China National Accreditation Service for Conformity Assessment (CNAS) The Registration Number is CNAS L3193
	Accredited by American Association for Laboratory Accreditation (A2LA) The Certificate Number is 4297.01
Name of Firm	: Shenzhen Accurate Technology Co., Ltd.
Site Location	: 1/F., Building A, Changyuan New Material Port, Science & Industry Park, Nanshan District, Shenzhen, Guangdong, P.R. China

## 1.5. Measurement Uncertainty

Conducted Emission Expanded Uncertainty	=	2.23dB, k=2
Radiated emission expanded uncertainty (9kHz-30MHz)	=	3.08dB, k=2
Radiated emission expanded uncertainty (30MHz-1000MHz)	=	4.42dB, k=2
Radiated emission expanded uncertainty (Above 1GHz)	=	4.06dB, k=2

## 2. MEASURING DEVICE AND TEST EQUIPMENT

**Table 1: List of Test and Measurement Equipment**

Kind of equipment	Manufacturer	Type	S/N	Calibrated dates	Cal. Interval
EMI Test Receiver	Rohde&Schwarz	ESCS30	100307	Jan. 07, 2017	One Year
EMI Test Receiver	Rohde&Schwarz	ESPI3	101526/003	Jan. 07, 2017	One Year
Spectrum Analyzer	Agilent	E7405A	MY45115511	Jan. 07, 2017	One Year
Pre-Amplifier	Rohde&Schwarz	CBLU118354 0-01	3791	Jan. 07, 2017	One Year
Loop Antenna	Schwarzbeck	FMZB1516	1516131	Jan. 13, 2017	One Year
Bilog Antenna	Schwarzbeck	VULB9163	9163-323	Jan. 13, 2017	One Year
Horn Antenna	Schwarzbeck	BBHA9120D	9120D-655	Jan. 13, 2017	One Year
Horn Antenna	Schwarzbeck	BBHA9120D	9120D-1067	Jan. 13, 2017	One Year
LISN	Rohde&Schwarz	ESH3-Z5	100305	Jan. 07, 2017	One Year
LISN	Schwarzbeck	NSLK8126	8126431	Jan. 07, 2017	One Year
Highpass Filter	Wainwright Instruments	WHKX3.6/18 G-10SS	N/A	Jan. 07, 2017	One Year
Band Reject Filter	Wainwright Instruments	WRCG2400/2 485-2375/2510 -60/11SS	N/A	Jan. 07, 2017	One Year

### 3. OPERATION OF EUT DURING TESTING

#### 3.1. Operating Mode

The mode is used: **Transmitting mode**

Low Channel: 2420MHz

Middle Channel: 2440MHz

High Channel: 2460MHz

#### 3.2. Configuration and peripherals

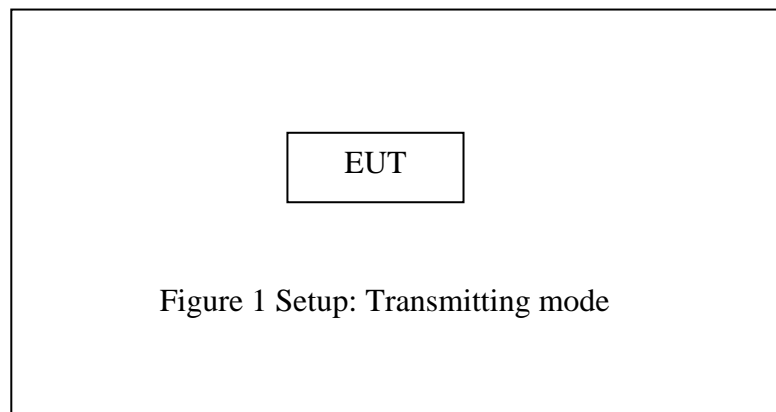

#### 4. TEST PROCEDURES AND RESULTS

<b>FCC Rules</b>	<b>Description of Test</b>	<b>Result</b>
Section 15.215(c)	20dB Bandwidth	Compliant
Section 15.249(d)	Band Edge Compliance Test	Compliant
Section 15.205(a), Section 15.209(a), Section 15.249, Section 15.35	Radiated Spurious Emission Test	Compliant
Section 15.207	AC Power Line Conducted Emission Test	N/A
Section 15.203	Antenna Requirement	Compliant

Note: The power supply mode of the EUT is DC 4.5V, According to the FCC standard requirements, conducted emission is not applicable.



## 5. 20DB BANDWIDTH MEASUREMENT

### 5.1. Block Diagram of Test Setup

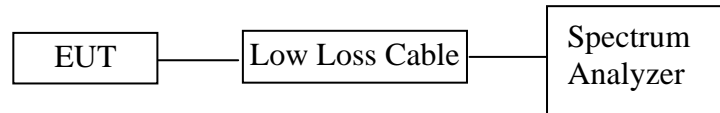

### 5.2. The Requirement For Section 15.215(c)

The bandwidth of a frequency hopping channel is the 20 dB emission bandwidth, measured with the hopping stopped. The system RF bandwidth is equal to the channel bandwidth multiplied by the number of channels in the hopset. The hopset shall be such that the near-term distribution of frequencies appears random, with sequential hops randomly distributed in both direction and magnitude of change in the hopset while the long-term distribution appears evenly distributed.

### 5.3. Operating Condition of EUT

5.3.1. Setup the EUT and simulator as shown as Section 5.1.

5.3.2. Turn on the power of all equipment.

5.3.3. Let the EUT work in TX modes measure it. The transmit frequency are 2420-2460 MHz. We select 2420MHz, 2440MHz, 2460MHz TX frequency to transmit.

### 5.4. Test Procedure

5.4.1. Place the EUT on the table and set it in transmitting mode.

5.4.2. Remove the antenna from the EUT and then connect a low loss RF cable from the antenna port to the spectrum analyzer.

5.4.3. Set RBW of spectrum analyzer to 100 kHz and VBW to 300 kHz, Detector function=peak, Trace=max hold, Sweep=auto.

5.4.4. Set the measured low, middle and high frequency and test 20dB bandwidth with spectrum analyzer.

### 5.5. Test Result

Channel	Frequency (MHz)	20 dB Bandwidth (MHz)
Low	2420	1.792
Middle	2440	1.456
High	2460	1.256

The spectrum analyzer plots are attached as below.

#### Low channel



Date: 15.SEP.2017 16:02:34

## Middle channel

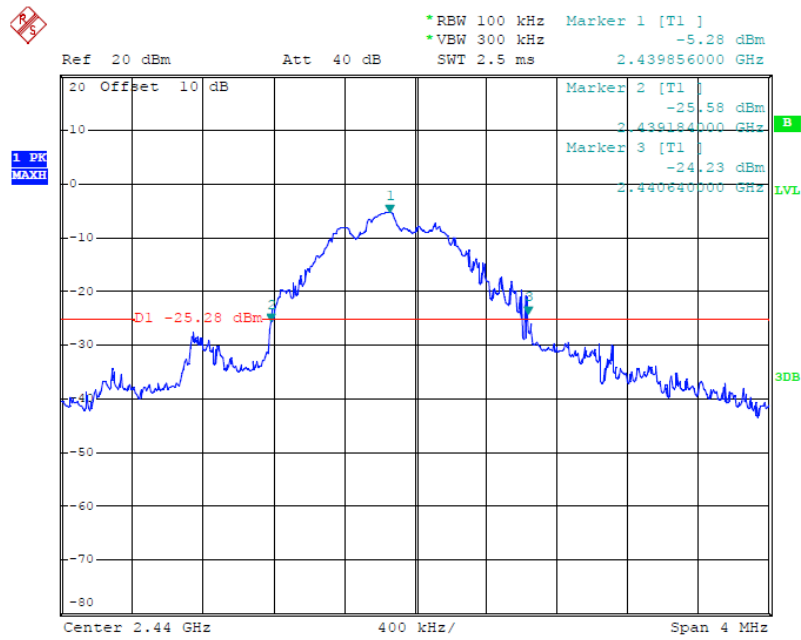

Date: 15.SEP.2017 16:07:02

## High channel

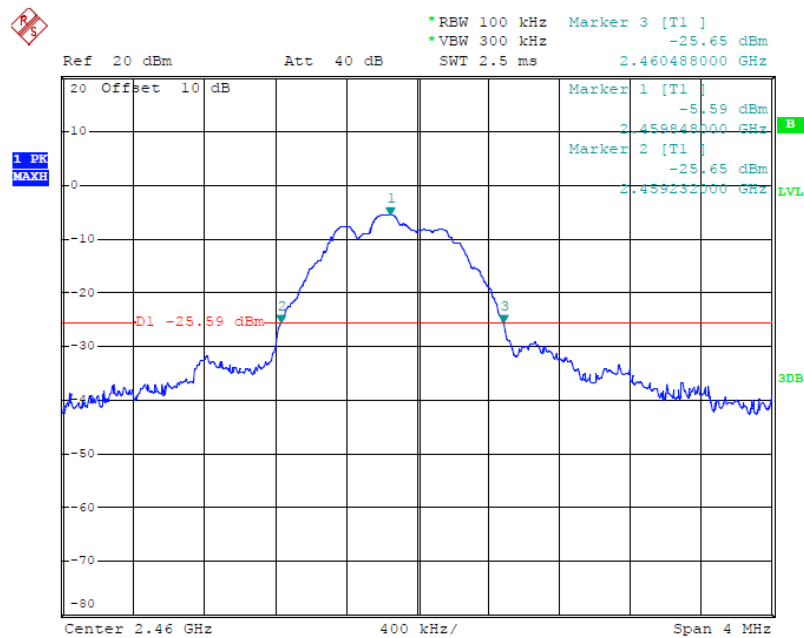

Date: 15.SEP.2017 16:08:27

## 6. BAND EDGE COMPLIANCE TEST

### 6.1. Block Diagram of Test Setup

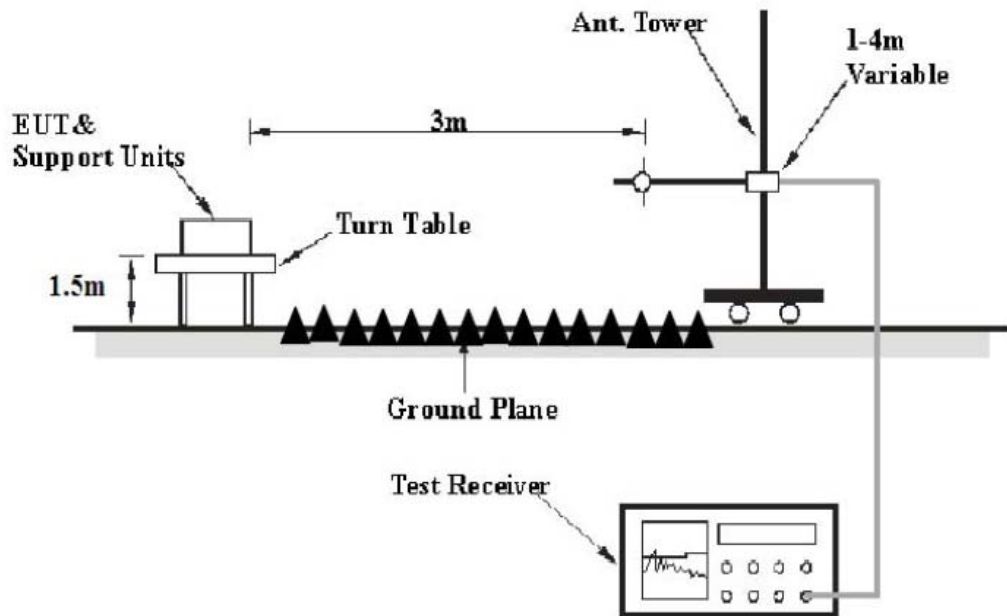

### 6.2. The Requirement For Section 15.249

In any 100 kHz bandwidth outside the frequency band in which the spread spectrum or digitally modulated intentional radiator is operating, the radio frequency power that is produced by the intentional radiator shall be at least 20 dB below that in the 100 kHz bandwidth within the band that contains the highest level of the desired power, based on either an RF conducted or a radiated measurement, provided the transmitter demonstrates compliance with the peak conducted power limits. If the transmitter complies with the conducted power limits based on the use of RMS averaging over a time interval, as permitted under paragraph A8.4(4), the attenuation required shall be 30 dB instead of 20 dB. Attenuation below the general limits specified in Section 15.209(a) is not required. In addition, radiated emissions which fall in the restricted bands, as defined in Section 15.205(a), must also comply with the radiated emission limits specified in Section 15.209(a).

### 6.3. EUT Configuration on Measurement

The equipment are installed on the emission Measurement to meet the commission requirements and operating regulations in a manner which tends to maximize its emission characteristics in normal application.

## 6.4. Operating Condition of EUT

6.4.1. Setup the EUT and simulator as shown as Section 6.1.

6.4.2. Turn on the power of all equipment.

6.4.3. Let the EUT work in TX modes measure it. The transmit frequency are 2420-2460 MHz. We select 2420MHz, 2460MHz TX frequency to transmit.

## 6.5. Test Procedure

Radiate Band Edge:

6.5.1. The EUT is placed on a turntable, which is 1.5m above the ground plane and worked at highest radiated power.

6.5.2. The turntable was rotated for 360 degrees to determine the position of maximum emission level.

6.5.3. EUT is set 3m away from the receiving antenna, which is varied from 1m to 4m to find out the highest emission.

6.5.4. Set the spectrum analyzer in the following setting in order to capture the lower and upper band-edges of the emission:

RBW=1MHz, VBW=1MHz

6.5.5. The band edges was measured and recorded.

## 6.6. Test Result

### **PASS**

Note: 1. Emissions attenuated more than 20 dB below the permissible value are not reported.

2. The field strength is calculated by adding the antenna factor, high pass filter loss(if used) and cable loss, and subtracting the amplifier gain(if any)from the measured reading. The basic equation calculation is as follows:

Result = Reading + Corrected Factor

3. Display the measurement of peak values.

4. The average measurement was not performed when peak measured data under the limit of average detection.

The spectral diagrams are attached as below.



**ACCURATE TECHNOLOGY CO., LTD.**

 F1,Bldg,A,Changyuan New Material Port Keyuan Rd,  
 Science & Industry Park,Nanshan Shenzhen,P.R.China

 Site: 1# Chamber  
 Tel:+86-0755-26503290  
 Fax:+86-0755-26503396

Job No.: frank2017 #807 Standard: FCC PK Test item: Radiation Test Temp.( C)/Hum.(%) 25 C / 55 % EUT: Video Camera Drone With LED Lights Mode: TX 2420MHz Model: 205981-01 Manufacturer: PURE TOY LIMITED	Polarization: Horizontal Power Source: DC 4.5V Date: 17/09/15/ Time: 9/09/17 Engineer Signature: Frank Distance: 3m
--	--

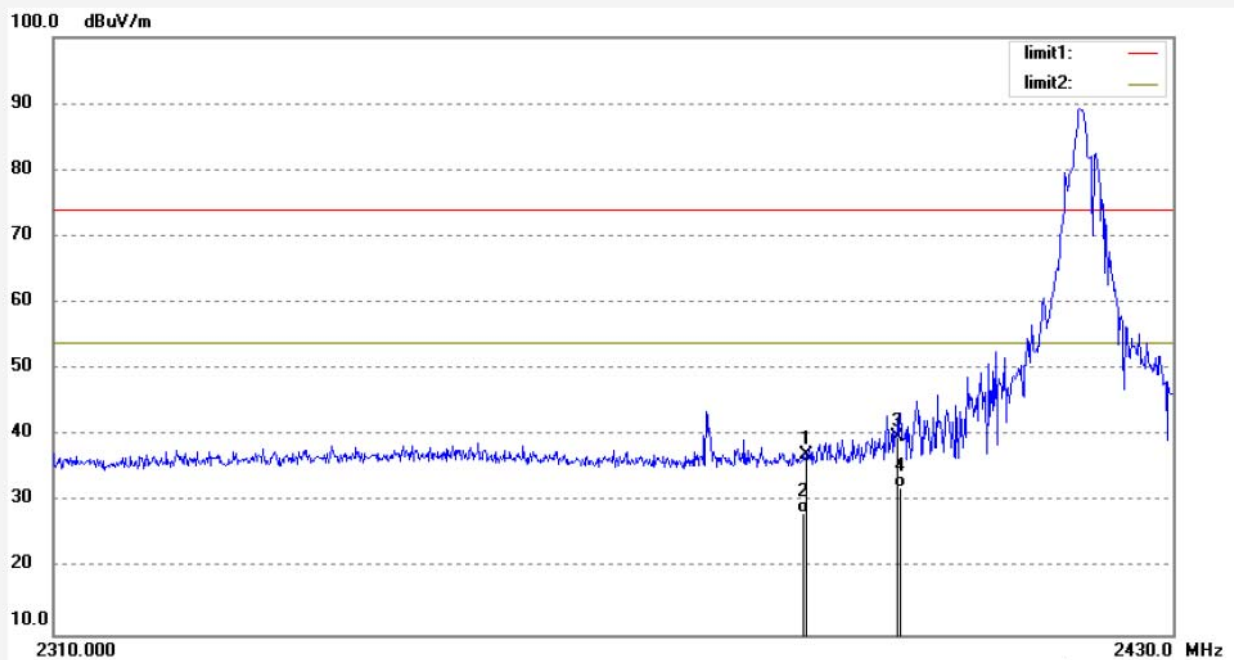
Note: Report NO.:ATE20171776



No.	Freq. (MHz)	Reading (dBuV/m)	Factor (dB)	Result (dBuV/m)	Limit (dBuV/m)	Margin (dB)	Detector	Height (cm)	Degree (deg.)	Remark
1	2390.000	41.05	-3.96	37.09	74.00	-36.91	peak	300	159	
2	2390.000	32.21	-3.96	28.25	54.00	-25.75	AVG	300	163	
3	2400.000	43.76	-3.91	39.85	74.00	-34.15	peak	250	190	
4	2400.000	36.14	-3.91	32.23	54.00	-21.77	AVG	250	176	



**ACCURATE TECHNOLOGY CO., LTD.**

F1,Bldg,A,Changyuan New Material Port Keyuan Rd,  
Science & Industry Park,Nanshan Shenzhen,P.R.China

Site: 1# Chamber  
Tel:+86-0755-26503290  
Fax:+86-0755-26503396

Job No.: frank2017 #806	Polarization: Vertical
Standard: FCC PK	Power Source: DC 4.5V
Test item: Radiation Test	Date: 17/09/15/
Temp.( C)/Hum.(%) 25 C / 55 %	Time: 9/04/00
EUT: Video Camera Drone With LED Lights	Engineer Signature: Frank
Mode: TX 2420MHz	Distance: 3m
Model: 205981-01	
Manufacturer: PURE TOY LIMITED	

Note: Report NO.:ATE20171776

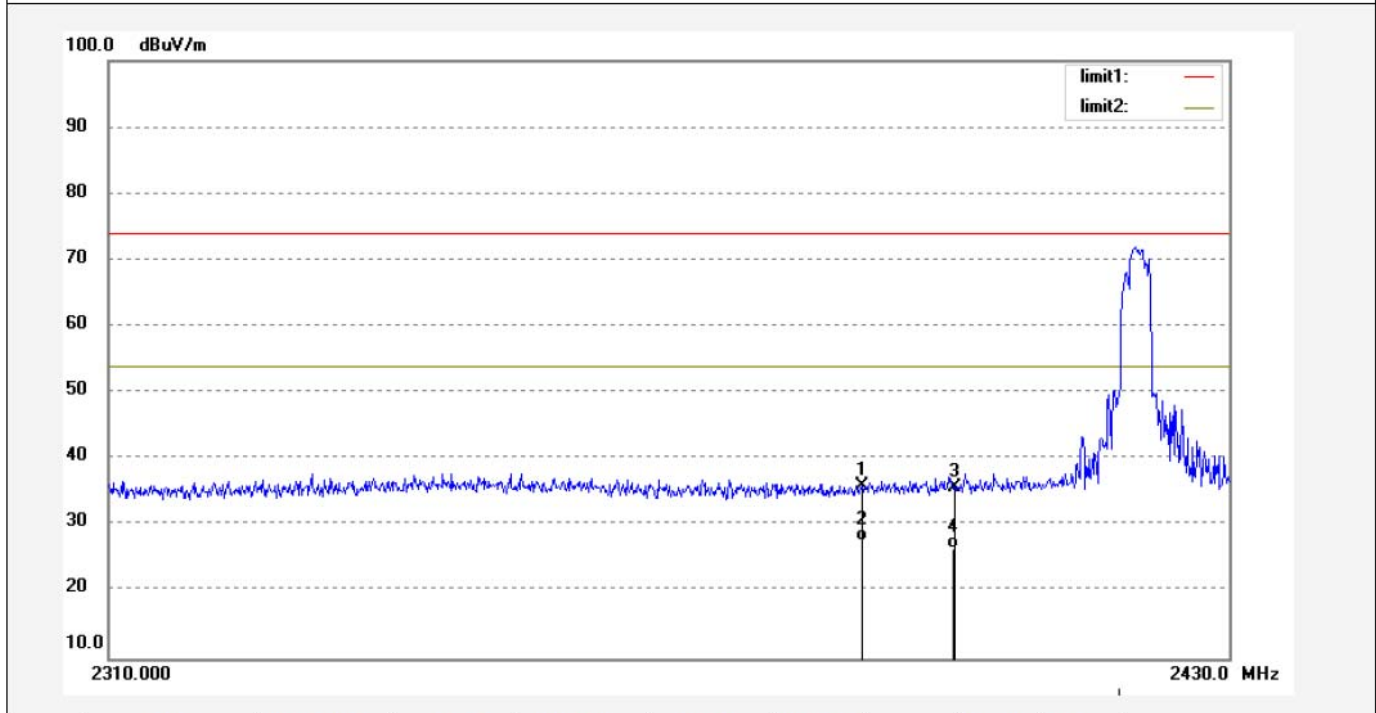

No.	Freq. (MHz)	Reading (dBuV/m)	Factor (dB)	Result (dBuV/m)	Limit (dBuV/m)	Margin (dB)	Detector	Height (cm)	Degree (deg.)	Remark
1	2390.000	40.03	-3.96	36.07	74.00	-37.93	peak	250	200	
2	2390.000	31.56	-3.96	27.60	54.00	-26.40	AVG	250	182	
3	2400.000	39.61	-3.91	35.70	74.00	-38.30	peak	200	112	
4	2400.000	30.54	-3.91	26.63	54.00	-27.37	AVG	200	90	



**ACCURATE TECHNOLOGY CO., LTD.**

 F1,Bldg,A,Changyuan New Material Port Keyuan Rd,  
 Science & Industry Park,Nanshan Shenzhen,P.R.China

Site: 1# Chamber

Tel:+86-0755-26503290

Fax:+86-0755-26503396

Job No.: frank2017 #809	Polarization: Horizontal
Standard: FCC PK	Power Source: DC 4.5V
Test item: Radiation Test	Date: 17/09/15/
Temp.( C)/Hum.(%) 25 C / 55 %	Time: 9/23/15
EUT: Video Camera Drone With LED Lights	Engineer Signature: Frank
Mode: TX 2460MHz	Distance: 3m
Model: 205981-01	
Manufacturer: PURE TOY LIMITED	

Note: Report NO.:ATE20171776

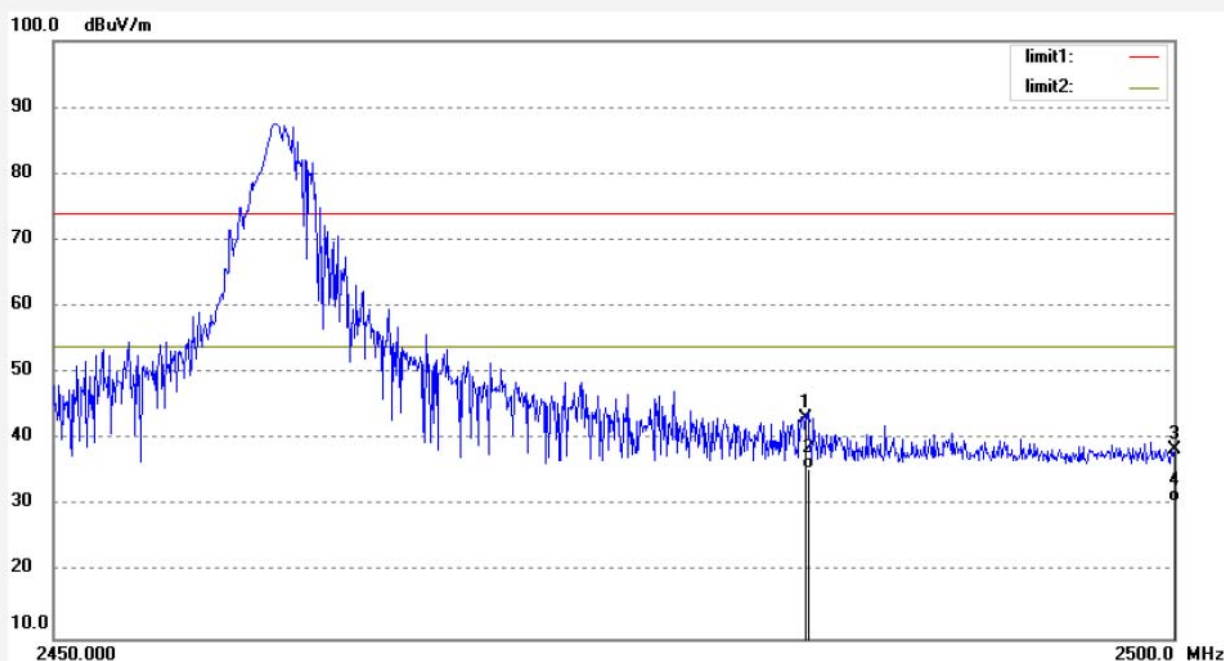

No.	Freq. (MHz)	Reading (dBuV/m)	Factor (dB)	Result (dBuV/m)	Limit (dBuV/m)	Margin (dB)	Detector	Height (cm)	Degree (deg.)	Remark
1	2483.500	46.64	-3.50	43.14	74.00	-30.86	peak	250	144	
2	2483.500	39.12	-3.50	35.62	54.00	-18.38	AVG	250	169	
3	2500.000	41.78	-3.42	38.36	74.00	-35.64	peak	300	307	
4	2500.000	34.12	-3.42	30.70	54.00	-23.30	AVG	300	358	



**ACCURATE TECHNOLOGY CO., LTD.**

 F1,Bldg,A,Changyuan New Material Port Keyuan Rd,  
 Science & Industry Park,Nanshan Shenzhen,P.R.China

Site: 1# Chamber

Tel:+86-0755-26503290

Fax:+86-0755-26503396

Job No.: frank2017 #810

Standard: FCC PK

Test item: Radiation Test

Temp.( C)/Hum.(%) 25 C / 55 %

EUT: Video Camera Drone With LED Lights

Mode: TX 2460MHz

Model: 205981-01

Manufacturer: PURE TOY LIMITED

Polarization: Vertical

Power Source: DC 4.5V

Date: 17/09/15/

Time: 9/26/26

Engineer Signature: Frank

Distance: 3m

Note: Report NO.:ATE20171776

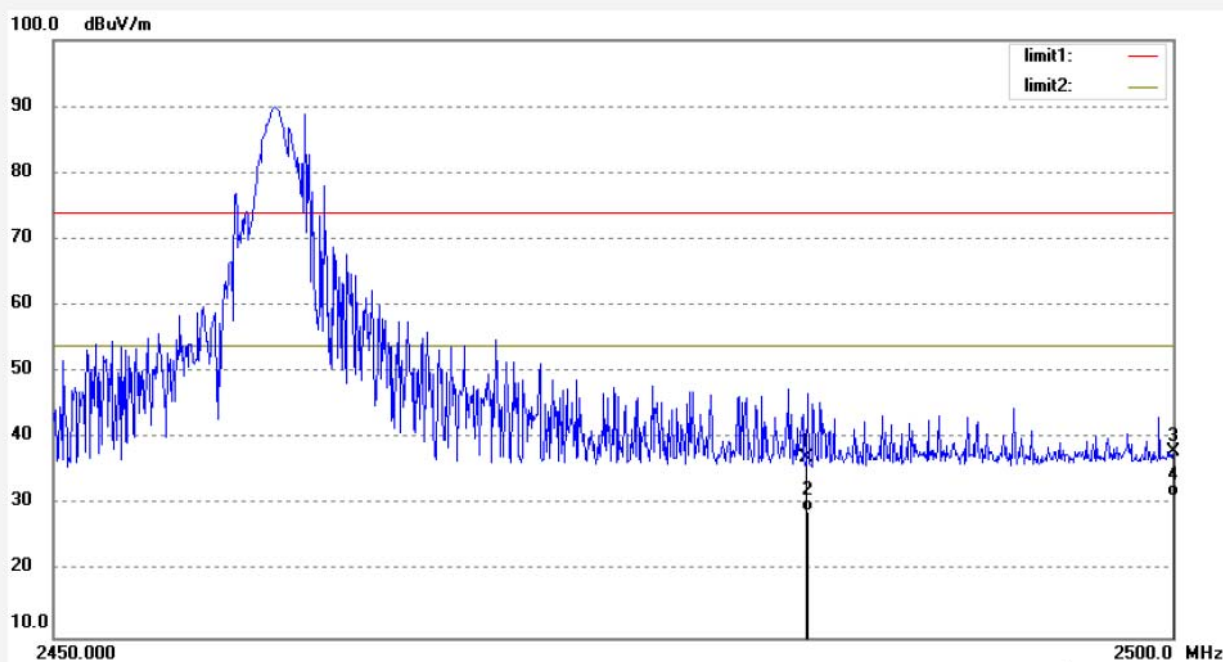

No.	Freq. (MHz)	Reading (dBuV/m)	Factor (dB)	Result (dBuV/m)	Limit (dBuV/m)	Margin (dB)	Detector	Height (cm)	Degree (deg.)	Remark
1	2483.500	40.53	-3.50	37.03	74.00	-36.97	peak	250	335	
2	2483.500	32.45	-3.50	28.95	54.00	-25.05	AVG	250	352	
3	2500.000	41.38	-3.42	37.96	74.00	-36.04	peak	300	301	
4	2500.000	34.67	-3.42	31.25	54.00	-22.75	AVG	300	360	

## 7. RADIATED SPURIOUS EMISSION TEST

### 7.1. Block Diagram of Test Setup

#### 7.1.1. Block diagram of connection between the EUT and peripherals

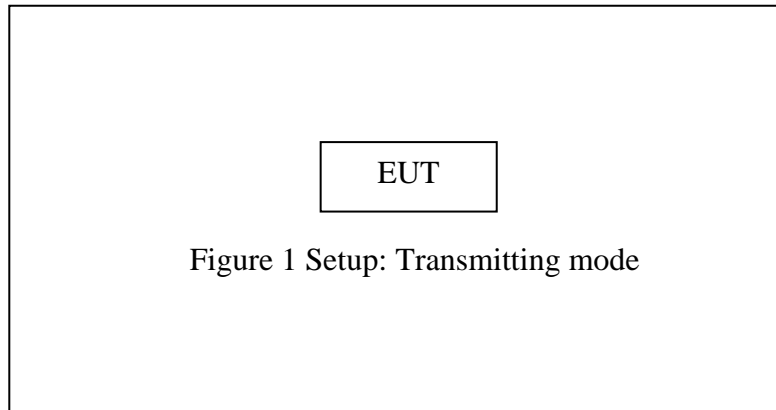

#### 7.1.2. Semi-Anechoic Chamber Test Setup Diagram

(A) Radiated Emission Test Set-Up, Frequency below 30MHz

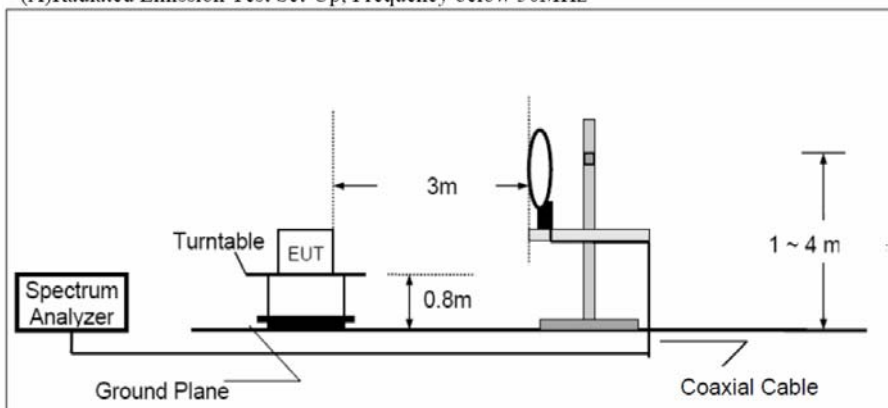

(B) Radiated Emission Test Set-Up, Frequency 30-1000MHz

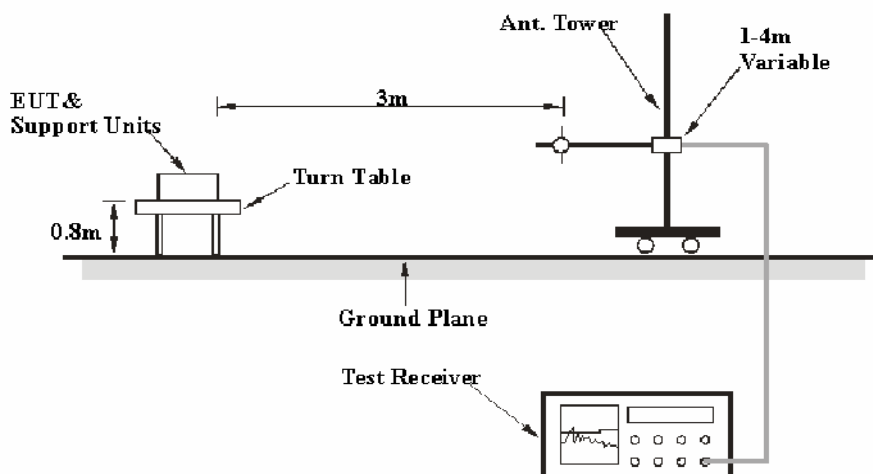

(C) Radiated Emission Test Set-Up, Frequency above 1GHz

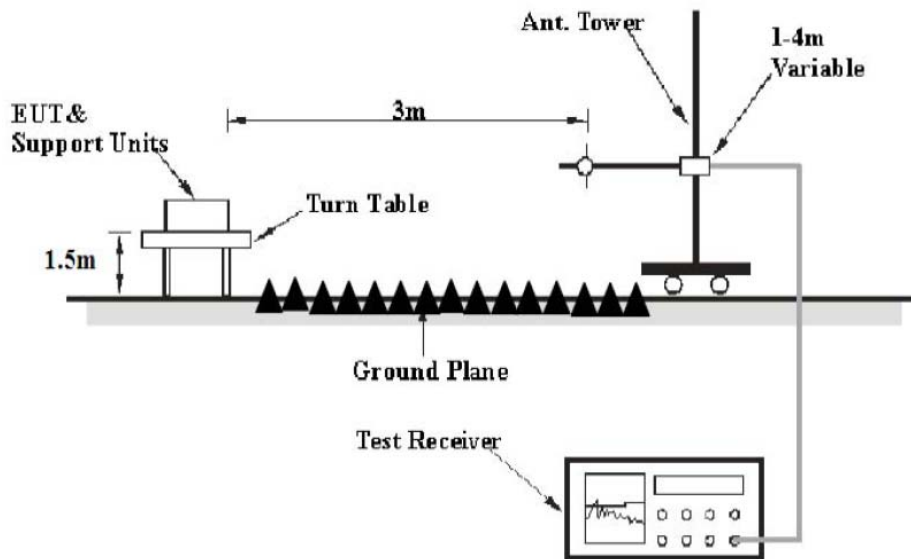

## 7.2. The Limit For Section 15.249

In any 100 kHz bandwidth outside the frequency band in which the spread spectrum or digitally modulated intentional radiator is operating, the radio frequency power that is produced by the intentional radiator shall be at least 20 dB below that in the 100 kHz bandwidth within the band that contains the highest level of the desired power, based on either an RF conducted or a radiated measurement, provided the transmitter demonstrates compliance with the peak conducted power limits. If the transmitter complies with the conducted power limits based on the use of RMS averaging over a time interval, as permitted under paragraph A8.4(4), the attenuation required under this paragraph shall be 30 dB instead of 20 dB. Attenuation below the general limits specified in Section 15.209(a) is not required. In addition, radiated emissions which fall in the restricted bands, as defined in Section 15.205(a), must also comply with the radiated emission limits specified in Section 15.209(a).

### 7.3. Restricted bands of operation

#### 7.3.1. FCC Part 15.205 Restricted bands of operation

(a) Except as shown in paragraph (d) of this section, Only spurious emissions are permitted in any of the frequency bands listed below:

MHz	MHz	MHz	GHz
0.090-0.110	16.42-16.423	399.9-410	4.5-5.15
<sup>1</sup> 0.495-0.505	16.69475-16.69525	608-614	5.35-5.46
2.1735-2.1905	16.80425-16.80475	960-1240	7.25-7.75
4.125-4.128	25.5-25.67	1300-1427	8.025-8.5
4.17725-4.17775	37.5-38.25	1435-1626.5	9.0-9.2
4.20725-4.20775	73-74.6	1645.5-1646.5	9.3-9.5
6.215-6.218	74.8-75.2	1660-1710	10.6-12.7
6.26775-6.26825	108-121.94	1718.8-1722.2	13.25-13.4
6.31175-6.31225	123-138	2200-2300	14.47-14.5
8.291-8.294	149.9-150.05	2310-2390	15.35-16.2
8.362-8.366	156.52475-156.52525	2483.5-2500	17.7-21.4
8.37625-8.38675	156.7-156.9	2690-2900	22.01-23.12
8.41425-8.41475	162.0125-167.17	3260-3267	23.6-24.0
12.29-12.293	167.72-173.2	3332-3339	31.2-31.8
12.51975-12.52025	240-285	3345.8-3358	36.43-36.5
12.57675-12.57725	322-335.4	3600-4400	( <sup>2</sup> )
13.36-13.41			

<sup>1</sup>Until February 1, 1999, this restricted band shall be 0.490-0.510

<sup>2</sup>Above 38.6

(b) Except as provided in paragraphs (d) and (e), the field strength of emission appearing within these frequency bands shall not exceed the limits shown in Section 15.209. At frequencies equal to or less than 1000MHz, Compliance with the limits in Section 15.209 shall be demonstrated using measurement instrumentation employing a CISPR quasi-peak detector. Above 1000MHz, compliance with the emission limits in Section 15.209 shall be demonstrated based on the average value of the measured emissions. The provisions in Section 15.35 apply to these measurements.

### 7.4. Configuration of EUT on Measurement

The equipment are installed on Radiated Emission Measurement to meet the commission requirements and operating regulations in a manner which tends to maximize its emission characteristics in normal application.

## 7.5. Operating Condition of EUT

7.5.1. Setup the EUT and simulator as shown as Section 7.1.

7.5.2. Turn on the power of all equipment.

7.5.3. Let the EUT work in TX modes measure it. The transmit frequency are 2420-2460 MHz. We select 2420MHz, 2460MHz TX frequency to transmit.

## 7.6. Test Procedure

The EUT and its simulators are placed on a turntable, which is 0.8 meter (Below 1GHz) and 1.5m (above 1GHz) high above ground. The turntable can rotate 360 degrees to determine the position of the maximum emission level. EUT is set 3.0 meters away from the receiving antenna, which is mounted on an antenna tower. The antenna can be moved up and down between 1.0 meter and 4 meters to find out the maximum emission level. Broadband antenna (calibrated bilog antenna) is used as receiving antenna. Both horizontal and vertical polarizations of the antenna are set on measurement. In order to find the maximum emission levels, all of the interface cables must be manipulated according to ANSI C63.10: 2013 on radiated emission measurement. The EUT was tested in 3 orthogonal planes.

The bandwidth of test receiver is set at 9 kHz in below 30MHz. and set at 120 kHz in 30-1000MHz, and 1MHz in above 1000MHz.

The final measurement in band 9-90 kHz, 110-490 kHz and above 1000MHz is performed with Average detector. Except those frequency bands mention above, the final measurement for frequencies below 1000MHz is performed with Quasi Peak detector.

RBW (120 kHz), VBW (300 kHz) for QP detector below 1GHz

Peak detector above 1GHz

RBW (1 MHz), VBW (3MHz) for Peak measurement

RBW (1 MHz), VBW (10Hz) for AV measurement

### 7.7.Data Sample

Frequency(MHz)	Reading (dB $\mu$ v)	Factor (dB/m)	Result (dB $\mu$ v/m)	Limit (dB $\mu$ v/m)	Margin (dB)	Remark
X.XX	31.47	-15.16	16.31	40.00	-23.69	QP

Frequency(MHz) = Emission frequency in MHz

Reading(dB $\mu$ v) = Uncorrected Analyzer/Receiver reading

Factor (dB/m) = Antenna factor + Cable Loss – Amplifier gain

Result(dB $\mu$ v/m) = Reading(dB $\mu$ v) + Factor(dB/m)

Limit (dB $\mu$ v/m) = Limit stated in standard

Margin (dB) = Result(dB $\mu$ v/m) - Limit (dB $\mu$ v/m)

QP = Quasi-peak Reading

Calculation Formula:

Margin(dB) = Result (dB $\mu$ V/m)–Limit(dB $\mu$ V/m)

Result(dB $\mu$ V/m)= Reading(dB $\mu$ V)+ Factor(dB/m)

The “Margin” column of the following data tables indicates the degree of compliance with the applicable limit. For example, a margin of -7dB means the emission is 7dB below the limit.

### 7.8.The Field Strength of Radiation Emission Measurement Results

**PASS.**

**Note: 1. Emissions attenuated more than 20 dB below the permissible value are not reported.**

**2. \*: Denotes restricted band of operation.**

**3. The EUT is tested radiation emission at Low, Middle, High channel in three axes. The worst emissions are reported in all channels.**

**4. The test frequency is from 30MHz to 25GHz, The 18-25GHz emissions are not reported, because the levels are too low against the limit.**





**ACCURATE TECHNOLOGY CO., LTD.**

 F1,Bldg,A,Changyuan New Material Port Keyuan Rd,  
 Science & Industry Park,Nanshan Shenzhen,P.R.China

 Site: 1# Chamber  
 Tel:+86-0755-26503290  
 Fax:+86-0755-26503396

Job No.: frank2017 #812 Standard: FCC Class B 3M Radiated Test item: Radiation Test Temp.( C)/Hum.(%) 25 C / 55 % EUT: Video Camera Drone With LED Lights Mode: TX 2420MHz Model: 205981-01 Manufacturer: PURE TOY LIMITED	Polarization: Horizontal Power Source: DC 4.5V Date: 2017/09/15 Time: 19:31:47 Engineer Signature: Frank Distance: 3m
---	--

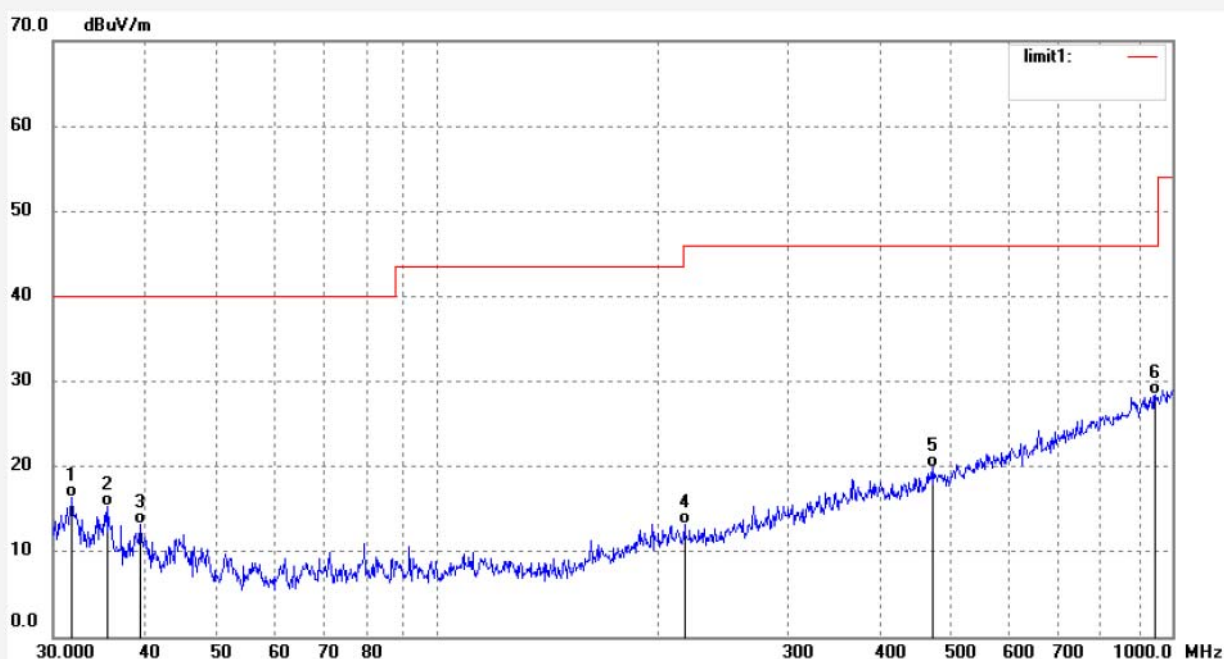
Note: Report NO.:ATE20171776



No.	Freq. (MHz)	Reading (dBuV/m)	Factor (dB)	Result (dBuV/m)	Limit (dBuV/m)	Margin (dB)	Detector	Height (cm)	Degree (deg.)	Remark
1	31.8463	31.47	-15.16	16.31	40.00	-23.69	QP	100	246	
2	35.6362	31.60	-16.22	15.38	40.00	-24.62	QP	100	108	
3	39.4587	31.15	-17.87	13.28	40.00	-26.72	QP	100	70	
4	216.8803	31.69	-18.41	13.28	46.00	-32.72	QP	100	38	
5	473.1259	31.19	-11.32	19.87	46.00	-26.13	QP	100	120	
6	948.6608	29.92	-1.50	28.42	46.00	-17.58	QP	100	329	

Job No.: frank2017 #811

Standard: FCC Class B 3M Radiated

Test item: Radiation Test

Temp.( C)/Hum.(%) 25 C / 55 %

EUT: Video Camera Drone With LED Lights

Mode: TX 2420MHz

Model: 205981-01

Manufacturer: PURE TOY LIMITED

Polarization: Vertical

Power Source: DC 4.5V

Date: 2017/09/15

Time: 19:30:43

Engineer Signature: Frank

Distance: 3m

Note: Report NO.:ATE20171776

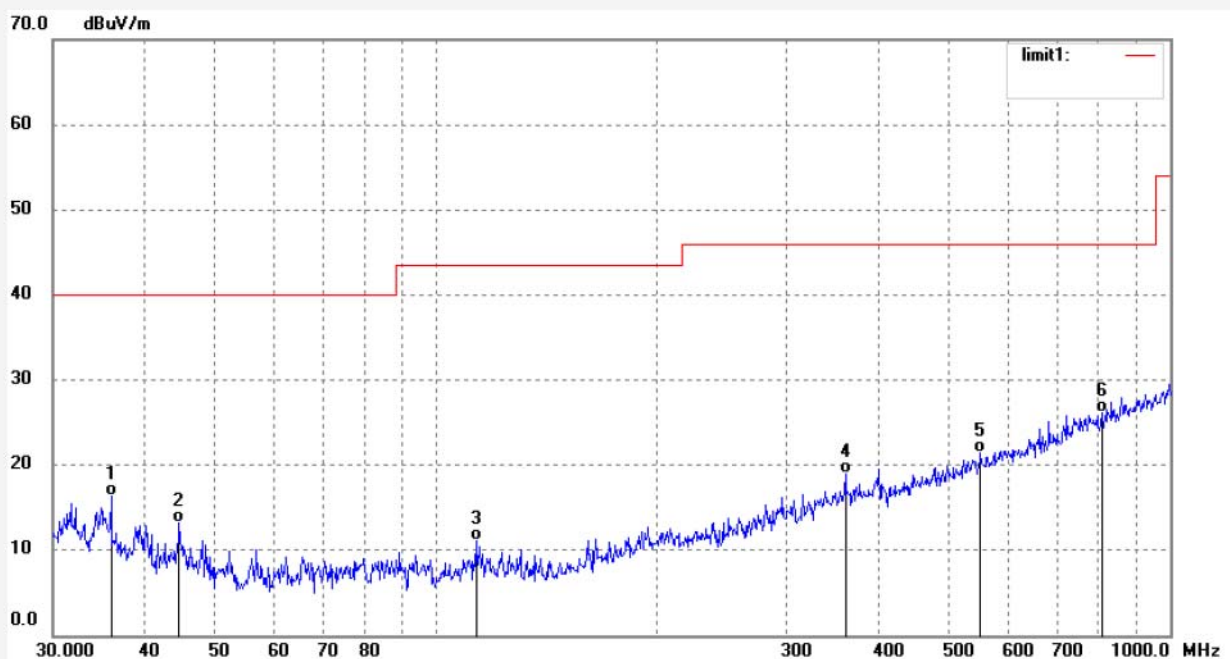

No.	Freq. (MHz)	Reading (dBuV/m)	Factor (dB)	Result (dBuV/m)	Limit (dBuV/m)	Margin (dB)	Detector	Height (cm)	Degree (deg.)	Remark
1	36.0138	32.67	-16.38	16.29	40.00	-23.71	QP	100	28	
2	44.6221	32.09	-18.85	13.24	40.00	-26.76	QP	100	96	
3	113.2198	32.97	-21.84	11.13	43.50	-32.37	QP	100	10	
4	360.9775	32.37	-13.44	18.93	46.00	-27.07	QP	100	275	
5	552.2269	31.01	-9.65	21.36	46.00	-24.64	QP	100	180	
6	809.9238	30.19	-3.97	26.22	46.00	-19.78	QP	100	251	



**ACCURATE TECHNOLOGY CO., LTD.**

 F1,Bldg,A,Changyuan New Material Port Keyuan Rd,  
 Science & Industry Park,Nanshan Shenzhen,P.R.China

Site: 1# Chamber

Tel:+86-0755-26503290

Fax:+86-0755-26503396

 Job No.: frank2017 #813  
 Standard: FCC Class B 3M Radiated  
 Test item: Radiation Test  
 Temp.( C)/Hum.(%) 25 C / 55 %  
 EUT: Video Camera Drone With LED Lights  
 Mode: TX 2440MHz  
 Model: 205981-01  
 Manufacturer: PURE TOY LIMITED

 Polarization: Horizontal  
 Power Source: DC 4.5V  
 Date: 2017/09/15  
 Time: 19:31:47  
 Engineer Signature: Frank  
 Distance: 3m

Note: Report NO.:ATE20171776

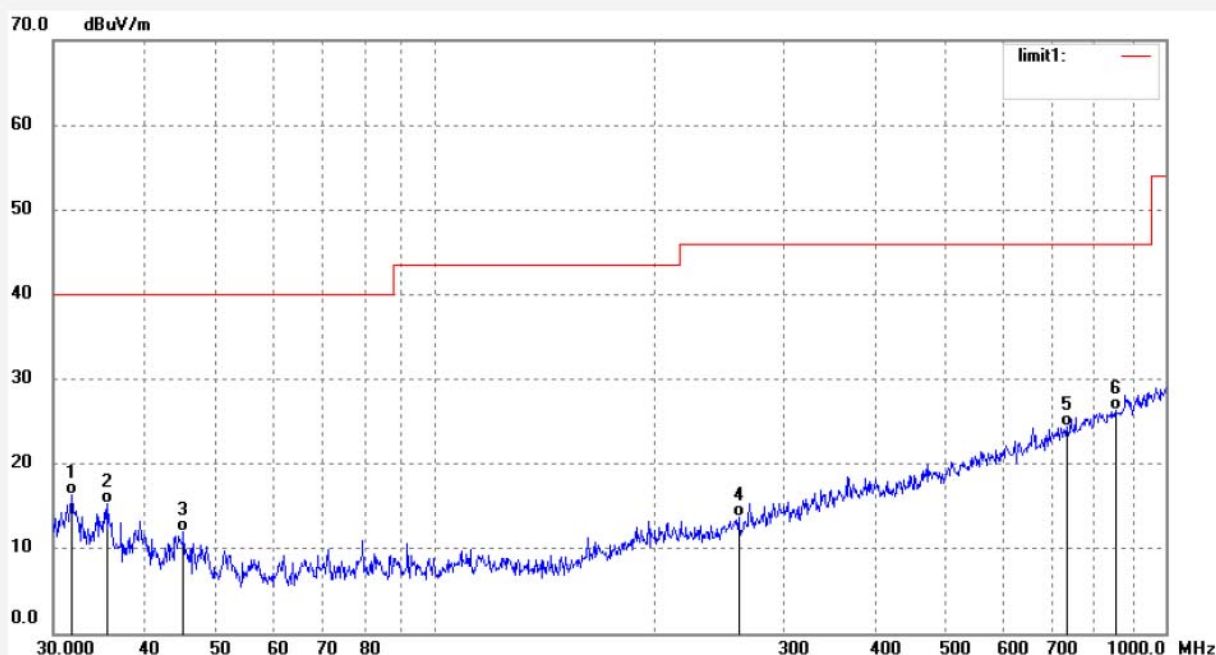

No.	Freq. (MHz)	Reading (dBuV/m)	Factor (dB)	Result (dBuV/m)	Limit (dBuV/m)	Margin (dB)	Detector	Height (cm)	Degree (deg.)	Remark
1	31.8462	31.47	-15.16	16.31	40.00	-23.69	QP	100	79	
2	35.6362	31.60	-16.22	15.38	40.00	-24.62	QP	100	251	
3	45.2536	31.02	-19.01	12.01	40.00	-27.99	QP	100	277	
4	260.3566	31.19	-17.52	13.67	46.00	-32.33	QP	100	301	
5	731.4627	30.00	-5.58	24.42	46.00	-21.58	QP	100	278	
6	853.7545	29.47	-3.18	26.29	46.00	-19.71	QP	100	28	

**ACCURATE TECHNOLOGY CO., LTD.**

 F1,Bldg,A,Changyuan New Material Port Keyuan Rd,  
 Science & Industry Park,Nanshan Shenzhen,P.R.China

Site: 1# Chamber

Tel:+86-0755-26503290

Fax:+86-0755-26503396

Job No.: frank2017 #814 Standard: FCC Class B 3M Radiated Test item: Radiation Test Temp.( C)/Hum.(%) 25 C / 55 % EUT: Video Camera Drone With LED Lights Mode: TX 2440MHz Model: 205981-01 Manufacturer: PURE TOY LIMITED	Polarization: Vertical Power Source: DC 4.5V Date: 2017/09/15 Time: 19:32:22 Engineer Signature: Frank Distance: 3m
---	--

Note: Report NO.:ATE20171776

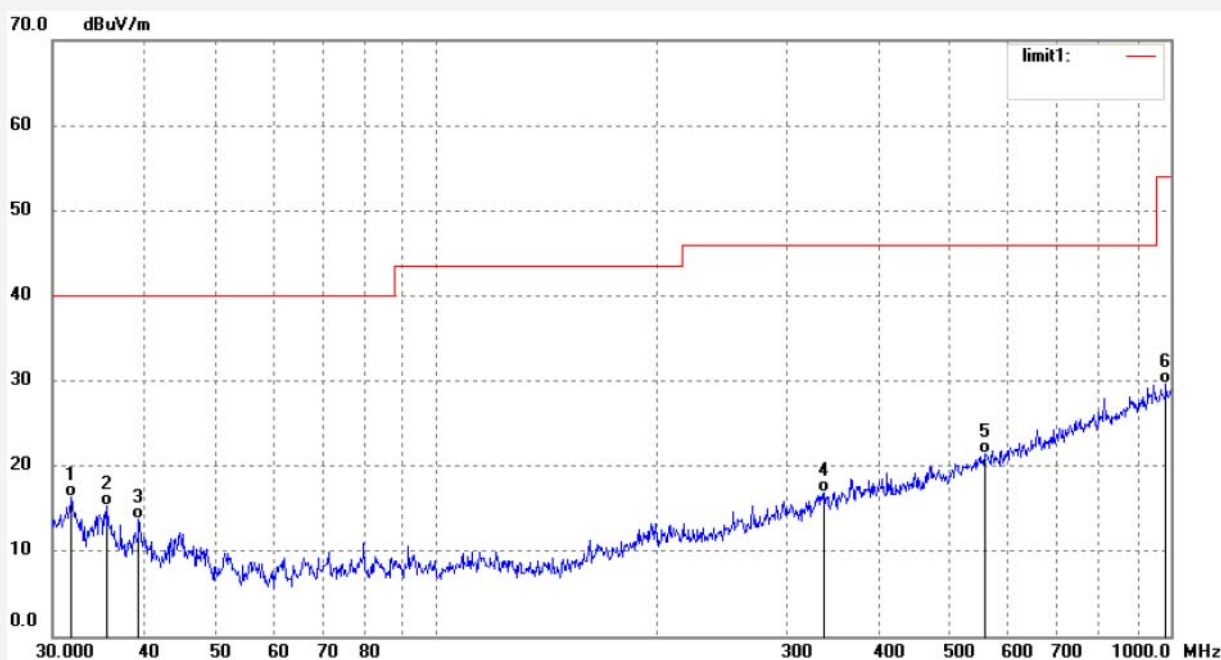

No.	Freq. (MHz)	Reading (dBuV/m)	Factor (dB)	Result (dBuV/m)	Limit (dBuV/m)	Margin (dB)	Detector	Height (cm)	Degree (deg.)	Remark
1	31.8463	31.47	-15.16	16.31	40.00	-23.69	QP	100	298	
2	35.6362	31.60	-16.22	15.38	40.00	-24.62	QP	100	301	
3	39.3203	31.52	-17.80	13.72	40.00	-26.28	QP	100	189	
4	337.6659	31.19	-14.31	16.88	46.00	-29.12	QP	100	287	
5	558.0788	30.91	-9.48	21.43	46.00	-24.57	QP	100	27	
6	986.0439	30.27	-0.54	29.73	54.00	-24.27	QP	100	39	

Job No.: frank2017 #816	Polarization: Horizontal
Standard: FCC Class B 3M Radiated	Power Source: DC 4.5V
Test item: Radiation Test	Date: 2017/09/15
Temp.( C)/Hum.(%) 25 C / 55 %	Time: 19:32:57
EUT: Video Camera Drone With LED Lights	Engineer Signature: Frank
Mode: TX 2460MHz	Distance: 3m
Model: 205981-01	
Manufacturer: PURE TOY LIMITED	

Note: Report NO.:ATE20171776

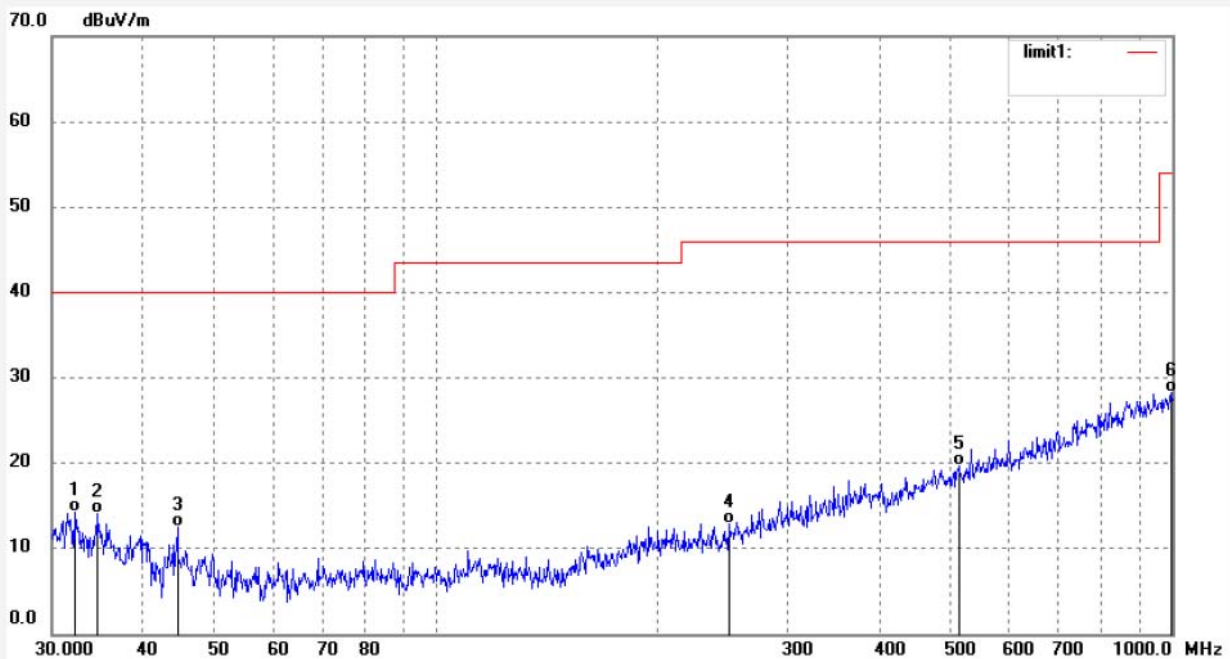

No.	Freq. (MHz)	Reading (dBuV/m)	Factor (dB)	Result (dBuV/m)	Limit (dBuV/m)	Margin (dB)	Detector	Height (cm)	Degree (deg.)	Remark
1	32.1839	29.52	-15.24	14.28	40.00	-25.72	QP	100	76	
2	34.6484	30.01	-15.86	14.15	40.00	-25.85	QP	100	102	
3	44.4656	31.28	-18.84	12.44	40.00	-27.56	QP	100	267	
4	250.4858	30.99	-18.10	12.89	46.00	-33.11	QP	100	20	
5	512.9477	30.33	-10.59	19.74	46.00	-26.26	QP	100	198	
6	996.4926	28.59	-0.29	28.30	54.00	-25.70	QP	100	28	



Job No.: frank2017 #815	Polarization: Vertical
Standard: FCC Class B 3M Radiated	Power Source: DC 4.5V
Test item: Radiation Test	Date: 2017/09/15
Temp.( C)/Hum.(%) 25 C / 55 %	Time: 19:32:39
EUT: Video Camera Drone With LED Lights	Engineer Signature: Frank
Mode: TX 2460MHz	Distance: 3m
Model: 205981-01	
Manufacturer: PURE TOY LIMITED	

Note: Report NO.:ATE20171776

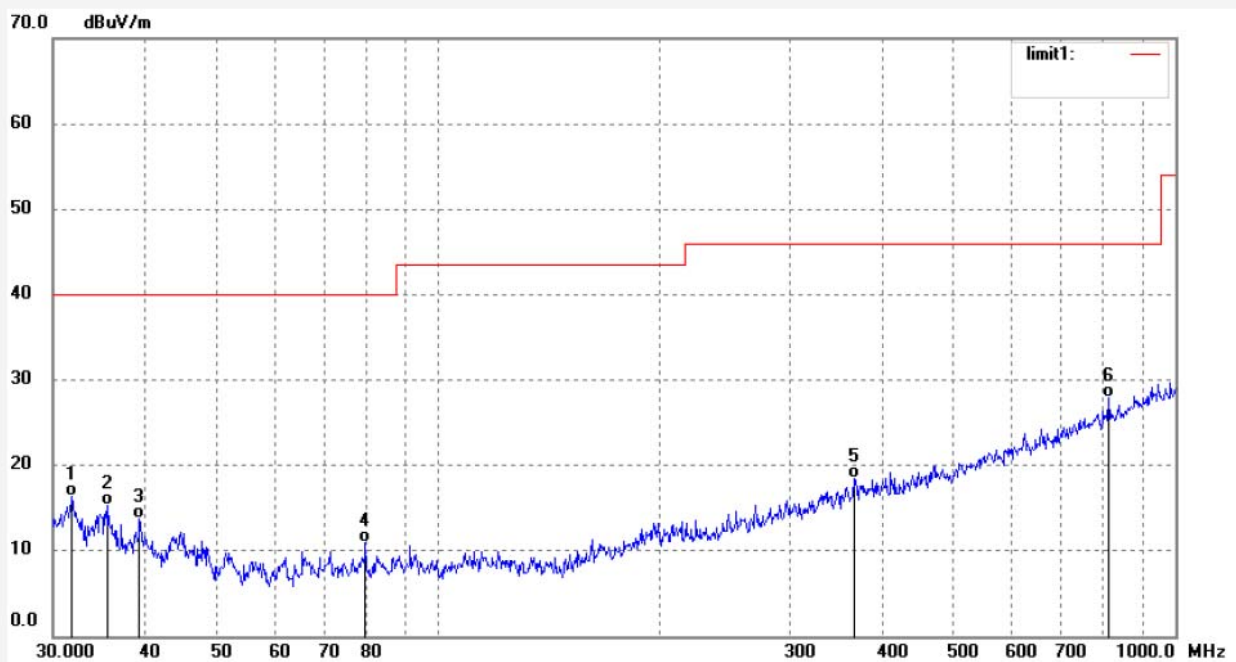

No.	Freq. (MHz)	Reading (dBuV/m)	Factor (dB)	Result (dBuV/m)	Limit (dBuV/m)	Margin (dB)	Detector	Height (cm)	Degree (deg.)	Remark
1	31.8464	31.47	-15.16	16.31	40.00	-23.69	QP	100	88	
2	35.6362	31.60	-16.22	15.38	40.00	-24.62	QP	100	109	
3	39.3203	31.52	-17.80	13.72	40.00	-26.28	QP	100	198	
4	79.6764	32.95	-22.02	10.93	40.00	-29.07	QP	100	182	
5	366.0865	31.78	-13.39	18.39	46.00	-27.61	QP	100	91	
6	812.7744	31.91	-3.91	28.00	46.00	-18.00	QP	100	126	

Job No.: frank2017 #818

Standard: FCC PK

Test item: Radiation Test

Temp.( C)/Hum.(%) 25 C / 55 %

EUT: Video Camera Drone With LED Lights

Mode: TX 2420MHz

Model: 205981-01

Manufacturer: PURE TOY LIMITED

Polarization: Horizontal

Power Source: DC 4.5V

Date: 2017/09/15

Time: 19:36:44

Engineer Signature: Frank

Distance: 3m

Note: Report NO.:ATE20171776

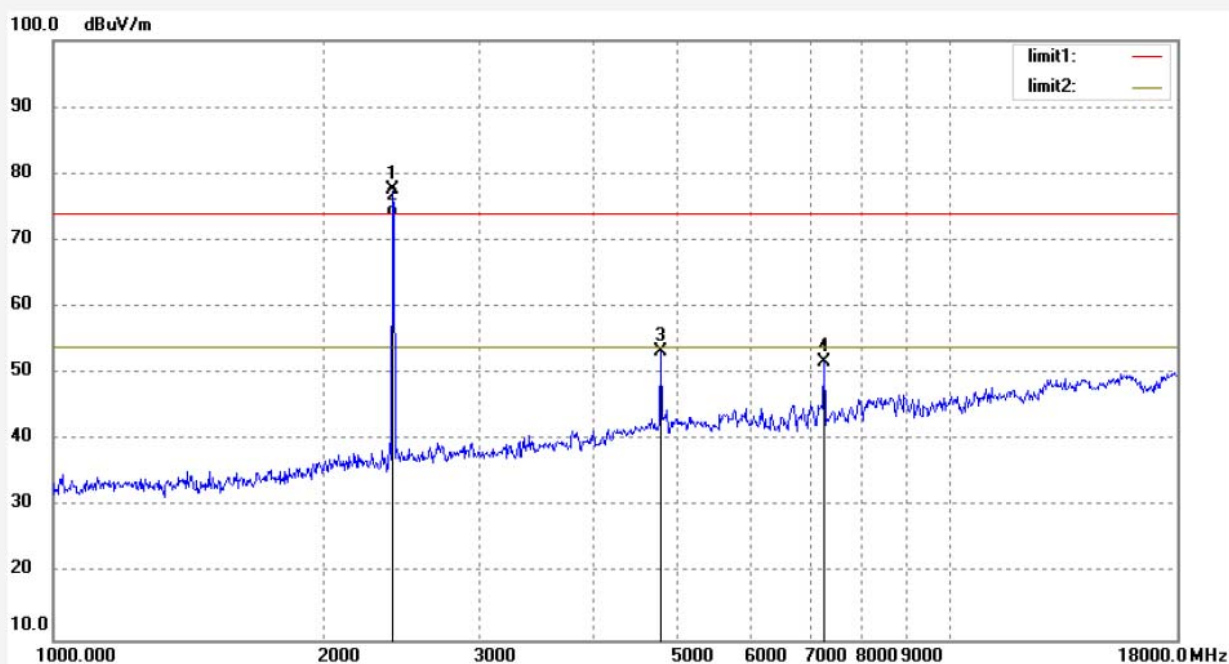

No.	Freq. (MHz)	Reading (dBuV/m)	Factor (dB)	Result (dBuV/m)	Limit (dBuV/m)	Margin (dB)	Detector	Height (cm)	Degree (deg.)	Remark
1	2420.100	81.50	-3.93	77.57	114.00	-36.43	peak	151	29	
2	2420.100	77.45	-3.93	73.52	94.00	-20.48	AVG	151	30	
3	4840.200	49.65	3.63	53.28	74.00	-20.72	peak	152	96	
4	7260.300	42.52	9.11	51.63	74.00	-22.37	peak	150	262	

**ACCURATE TECHNOLOGY CO., LTD.**

 F1,Bldg,A,Changyuan New Material Port Keyuan Rd,  
 Science & Industry Park,Nanshan Shenzhen,P.R.China

Site: 1# Chamber

Tel:+86-0755-26503290

Fax:+86-0755-26503396

Job No.: frank2017 #819

Standard: FCC PK

Test item: Radiation Test

Temp.( C)/Hum.(%) 25 C / 55 %

EUT: Video Camera Drone With LED Lights

Mode: TX 2420MHz

Model: 205981-01

Manufacturer: PURE TOY LIMITED

Polarization: Vertical

Power Source: DC 4.5V

Date: 2017/09/15

Time: 19:38:01

Engineer Signature: Frank

Distance: 3m

Note: Report NO.:ATE20171776

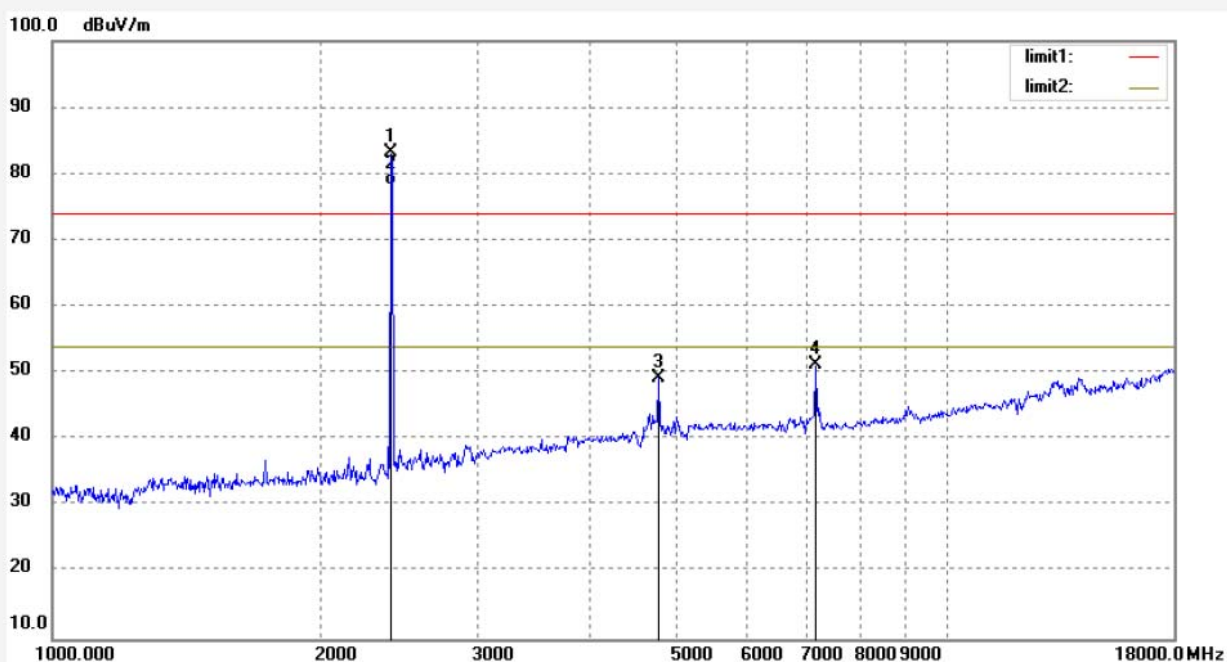

No.	Freq. (MHz)	Reading (dBuV/m)	Factor (dB)	Result (dBuV/m)	Limit (dBuV/m)	Margin (dB)	Detector	Height (cm)	Degree (deg.)	Remark
1	2420.100	87.26	-3.93	83.33	114.00	-30.67	peak	151	178	
2	2420.100	82.15	-3.93	78.22	94.00	-15.78	AVG	151	179	
3	4840.200	45.54	3.63	49.17	74.00	-24.83	peak	151	181	
4	7260.300	42.45	8.92	51.37	74.00	-22.63	peak	152	65	





**ACCURATE TECHNOLOGY CO., LTD.**

F1,Bldg,A,Changyuan New Material Port Keyuan Rd,  
Science & Industry Park,Nanshan Shenzhen,P.R.China

Site: 1# Chamber

Tel:+86-0755-26503290

Fax:+86-0755-26503396

Job No.: frank2017 #821

Standard: FCC PK

Test item: Radiation Test

Temp.( C)/Hum.(%) 25 C / 55 %

EUT: Video Camera Drone With LED Lights

Mode: TX 2440MHz

Model: 205981-01

Manufacturer: PURE TOY LIMITED

Polarization: Horizontal

Power Source: DC 4.5V

Date: 2017/09/15

Time: 19:41:13

Engineer Signature: Frank

Distance: 3m

Note: Report NO.:ATE20171776

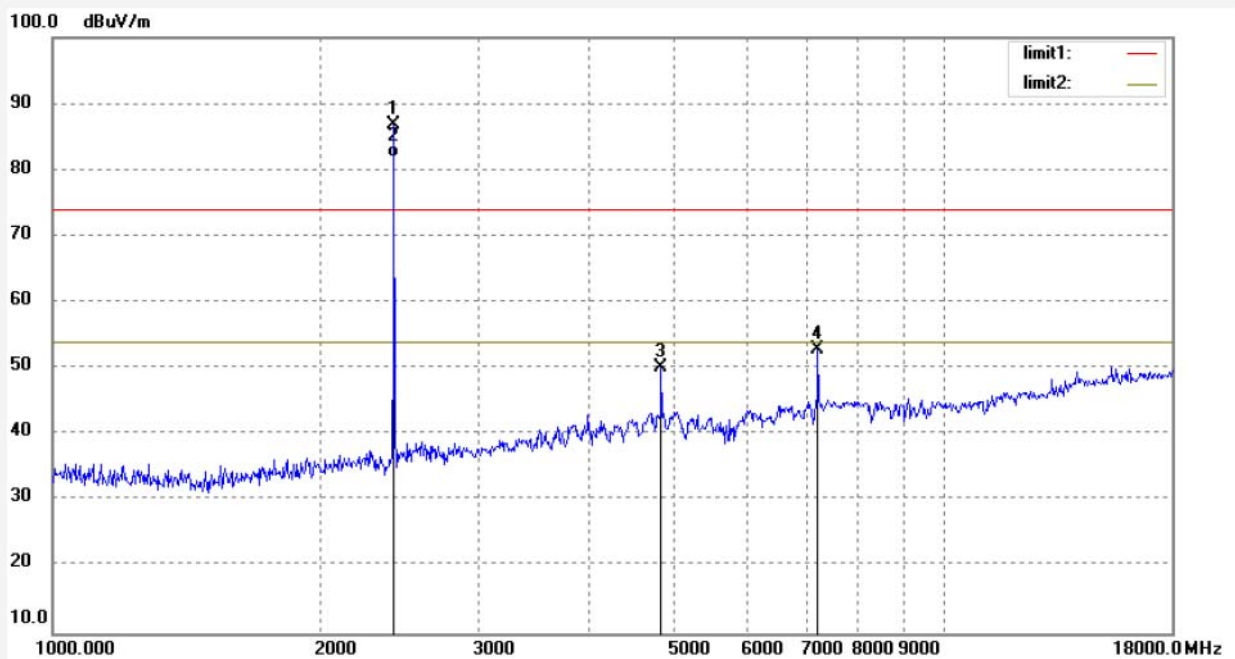

No.	Freq. (MHz)	Reading (dBuV/m)	Factor (dB)	Result (dBuV/m)	Limit (dBuV/m)	Margin (dB)	Detector	Height (cm)	Degree (deg.)	Remark
1	2440.121	90.62	-3.83	86.79	114.00	-27.21	peak	151	22	
2	2440.121	85.65	-3.83	81.82	94.00	-12.18	AVG	151	21	
3	4880.242	46.27	3.82	50.09	74.00	-23.91	peak	152	38	
4	7320.366	43.92	9.03	52.95	74.00	-21.05	peak	152	89	

Job No.: frank2017 #820

Standard: FCC PK

Test item: Radiation Test

Temp.( C)/Hum.(%) 25 C / 55 %

EUT: Video Camera Drone With LED Lights

Mode: TX 2440MHz

Model: 205981-01

Manufacturer: PURE TOY LIMITED

Polarization: Vertical

Power Source: DC 4.5V

Date: 2017/09/15

Time: 19:39:51

Engineer Signature: Frank

Distance: 3m

Note: Report NO.:ATE20171776

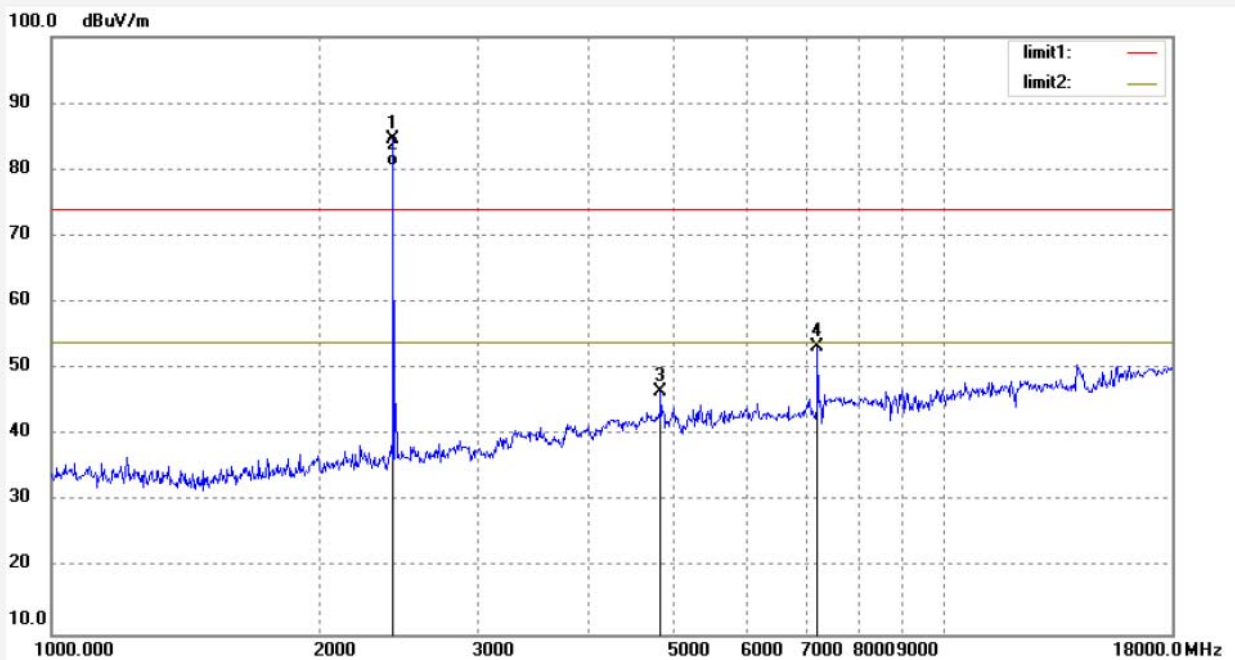

No.	Freq. (MHz)	Reading (dBuV/m)	Factor (dB)	Result (dBuV/m)	Limit (dBuV/m)	Margin (dB)	Detector	Height (cm)	Degree (deg.)	Remark
1	2440.121	88.37	-3.83	84.54	114.00	-29.46	peak	151	75	
2	2440.121	84.35	-3.83	80.52	94.00	-13.48	AVG	151	76	
3	4880.242	42.77	3.82	46.59	74.00	-27.41	peak	152	267	
4	7320.366	44.22	9.03	53.25	74.00	-20.75	peak	152	80	



**ACCURATE TECHNOLOGY CO., LTD.**

 F1,Bldg,A,Changyuan New Material Port Keyuan Rd,  
 Science & Industry Park,Nanshan Shenzhen,P.R.China

Site: 1# Chamber

Tel:+86-0755-26503290

Fax:+86-0755-26503396

Job No.: frank2017 #822

Standard: FCC PK

Test item: Radiation Test

Temp.( C)/Hum.(%) 25 C / 55 %

EUT: Video Camera Drone With LED Lights

Mode: TX 2460MHz

Model: 205981-01

Manufacturer: PURE TOY LIMITED

Polarization: Horizontal

Power Source: DC 4.5V

Date: 2017/09/15

Time: 19:42:44

Engineer Signature: Frank

Distance: 3m

Note: Report NO.:ATE20171776

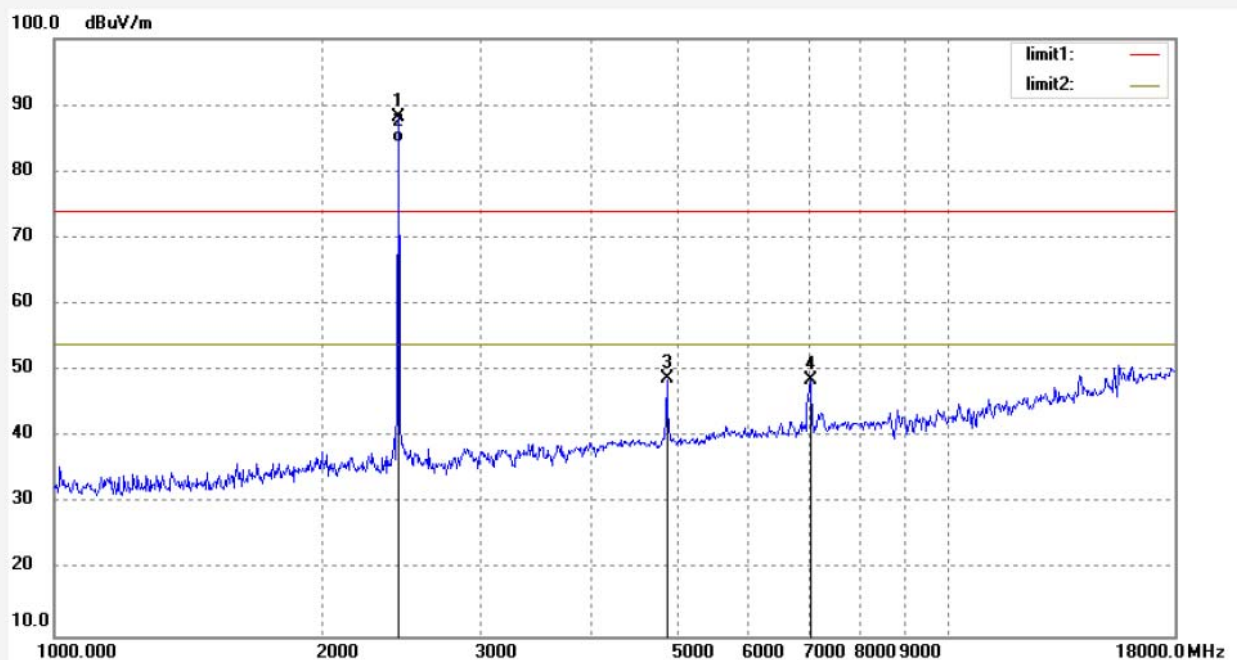

No.	Freq. (MHz)	Reading (dBuV/m)	Factor (dB)	Result (dBuV/m)	Limit (dBuV/m)	Margin (dB)	Detector	Height (cm)	Degree (deg.)	Remark
1	2460.124	92.02	-3.77	88.25	114.00	-25.75	peak	151	92	
2	2460.124	88.15	-3.77	84.38	94.00	-9.62	AVG	151	93	
3	4920.557	44.70	4.00	48.70	74.00	-25.30	peak	153	81	
4	7380.360	39.83	8.71	48.54	74.00	-25.46	peak	152	182	



**ACCURATE TECHNOLOGY CO., LTD.**

F1,Bldg,A,Changyuan New Material Port Keyuan Rd,  
Science & Industry Park,Nanshan Shenzhen,P.R.China

Site: 1# Chamber

Tel:+86-0755-26503290

Fax:+86-0755-26503396

Job No.: frank2017 #823

Standard: FCC PK

Test item: Radiation Test

Temp.( C)/Hum.(%) 25 C / 55 %

EUT: Video Camera Drone With LED Lights

Mode: TX 2460MHz

Model: 205981-01

Manufacturer: PURE TOY LIMITED

Polarization: Vertical

Power Source: DC 4.5V

Date: 2017/09/15

Time: 19:44:07

Engineer Signature: Frank

Distance: 3m

Note: Report NO.:ATE20171776

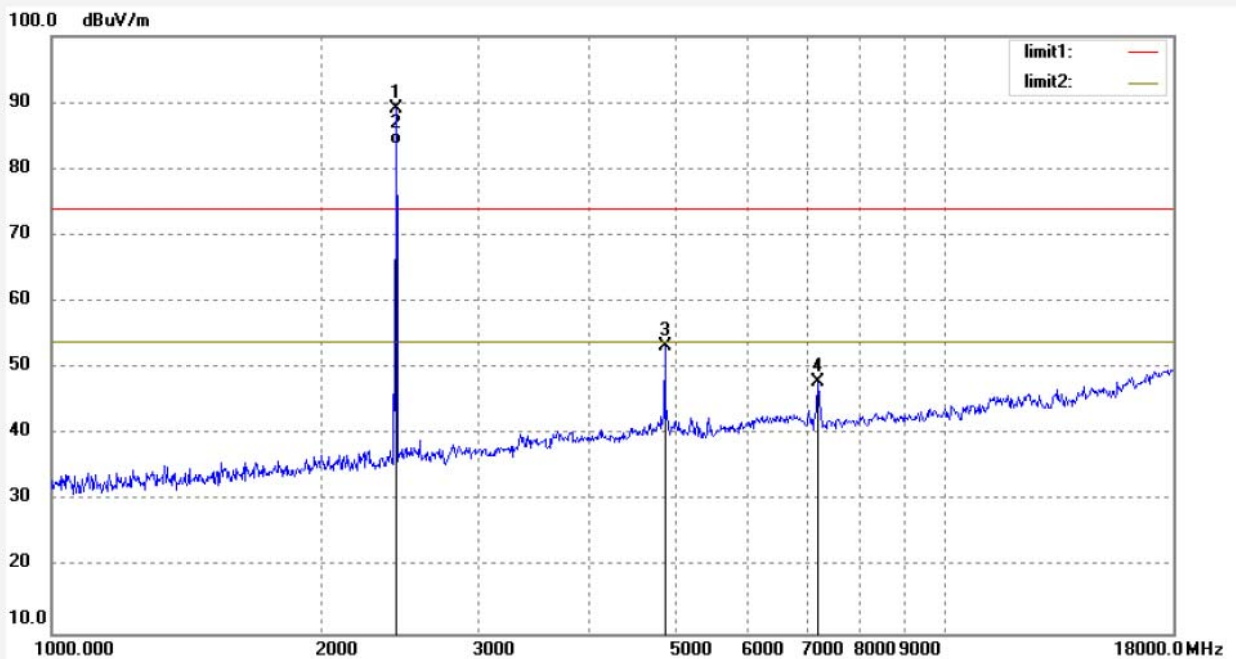

No.	Freq. (MHz)	Reading (dBuV/m)	Factor (dB)	Result (dBuV/m)	Limit (dBuV/m)	Margin (dB)	Detector	Height (cm)	Degree (deg.)	Remark
1	2460.124	92.89	-3.77	89.12	114.00	-24.88	peak	152	92	
2	2460.124	87.45	-3.77	83.68	94.00	-10.32	AVG	152	92	
3	4920.257	49.36	4.00	53.36	74.00	-20.64	peak	151	219	
4	7380.360	38.85	9.00	47.85	74.00	-26.15	peak	151	206	

## 8. ANTENNA REQUIREMENT

### 8.1.The Requirement

According to Section 15.203, an intentional radiator shall be designed to ensure that no antenna other than that furnished by the responsible party shall be used with the device.

### 8.2.Antenna Construction

Device is equipped with permanent attached antenna, which isn't displaced by other antenna. The Antenna gain of EUT is 1dBi. Therefore, the equipment complies with the antenna requirement of Section 15.203.

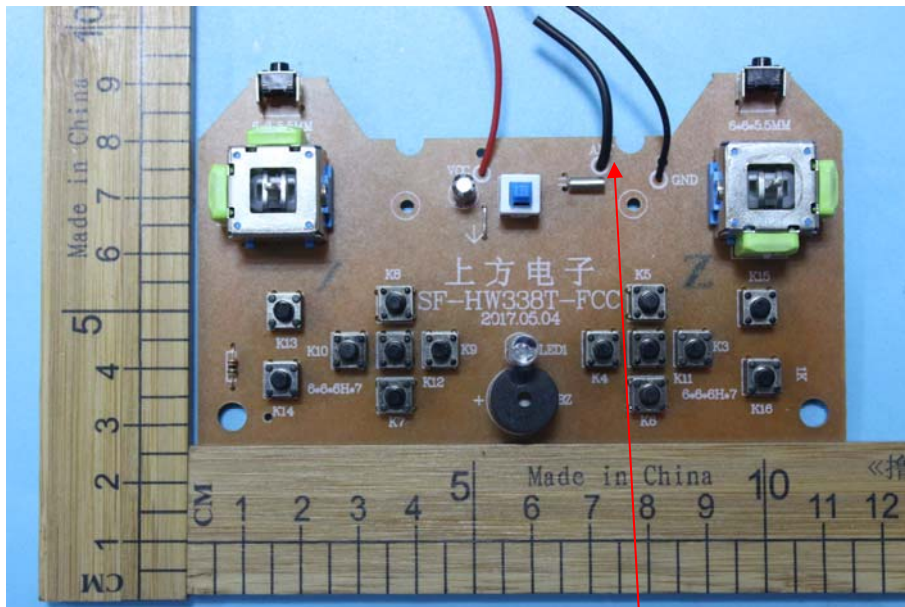

Antenna

### 9. PHOTO OF EUT











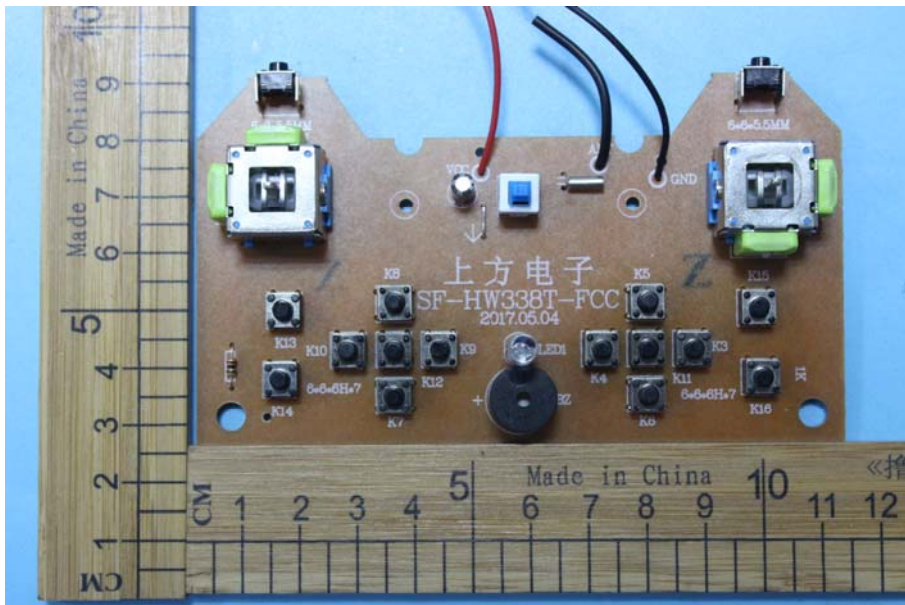
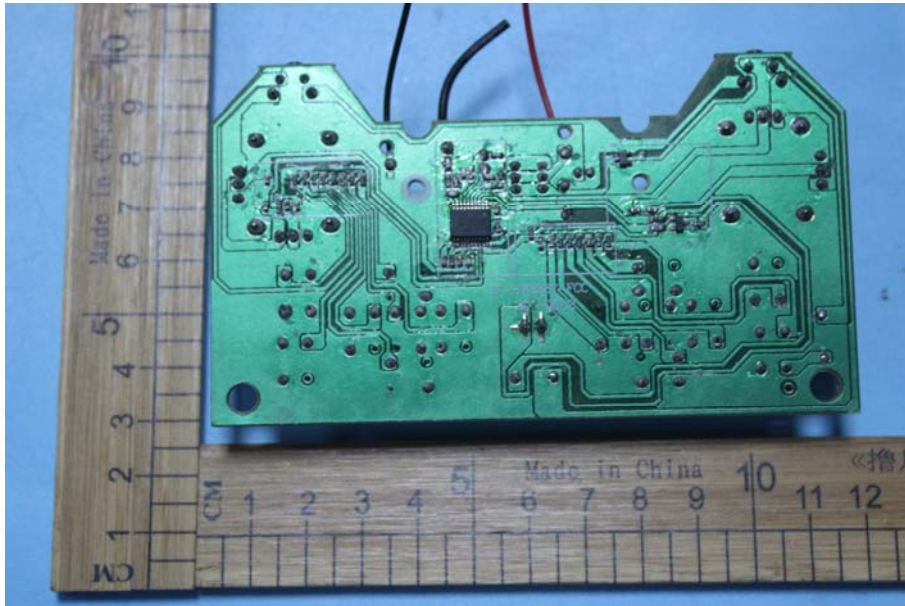

----- THE END OF TEST REPORT -----