



**CFR 47 FCC PART 15 SUBPART C  
ISED RSS-247 ISSUE 2**

**CERTIFICATION TEST REPORT**

*For*

**Robotic Vacuum Cleaner**

**MODEL NUMBER: S270RR**

**FCC ID: 2AN2O-S270RR02**

**IC: 23317-S270RR02**

**HVIN: S270RR-FNH1**

**REPORT NUMBER: 4790240136-2**

**ISSUE DATE: April 01, 2022**

*Prepared for*

**Beijing Roborock Technology Co., Ltd.  
Floor 6, Suite 6016, 6017, 6018, Building C, Kangjian Baosheng Plaza, No.8  
Heiquan Road, Haidian District, Beijing, P.R. China**

*Prepared by*

**UL Verification Services (Guangzhou) Co., Ltd, Song Shan Lake Branch  
Building 10, Innovation Technology Park, No. 1, Li Bin Road, Song Shan Lake Hi-  
Tech Development Zone Dongguan, 523808, People's Republic of China**

**Tel: +86 769 22038881**

**Fax: +86 769 33244054**

**Website: [www.ul.com](http://www.ul.com)**



Revision History

<u>Rev.</u>	<u>Issue Date</u>	<u>Revisions</u>	<u>Revised By</u>
V0	4/1/2022	Initial Issue	



Summary of Test Results			
Clause	Test Items	FCC/ISED Rules	Test Results
1	6dB Bandwidth and 99% Occupied Bandwidth	FCC Part 15.247 (a) (2) RSS-247 Clause 5.2 (a) ISED RSS-Gen Clause 6.7	Pass
2	Conducted Output Power	FCC Part 15.247 (b) (3) RSS-247 Clause 5.4 (d)	Pass
3	Power Spectral Density	FCC Part 15.247 (e) RSS-247 Clause 5.2 (b)	Pass
4	Conducted Bandedge and Spurious Emission	FCC Part 15.247 (d) RSS-247 Clause 5.5	Pass
5	Radiated Bandedge and Spurious Emission	FCC Part 15.247 (d) FCC Part 15.209 FCC Part 15.205 RSS-247 Clause 5.5 RSS-GEN Clause 8.9	Pass
6	Conducted Emission Test for AC Power Port	FCC Part 15.207 RSS-GEN Clause 8.8	Pass
7	Antenna Requirement	FCC Part 15.203 RSS-GEN Clause 6.8	Pass
<b>Note:</b> 1. This test report is only published to and used by the applicant, and it is not for evidence purpose in China. 2. The measurement result for the sample received is <Pass> according to < CFR 47 FCC PART 15 SUBPART C >< ISED RSS-247 > when <Accuracy Method> decision rule is applied.			



## TABLE OF CONTENTS

<b>1. ATTESTATION OF TEST RESULTS .....</b>	<b>6</b>
<b>2. TEST METHODOLOGY .....</b>	<b>7</b>
<b>3. FACILITIES AND ACCREDITATION .....</b>	<b>7</b>
<b>4. CALIBRATION AND UNCERTAINTY .....</b>	<b>8</b>
4.1. <i>MEASURING INSTRUMENT CALIBRATION .....</i>	<i>8</i>
4.2. <i>MEASUREMENT UNCERTAINTY.....</i>	<i>8</i>
<b>5. EQUIPMENT UNDER TEST .....</b>	<b>9</b>
5.1. <i>DESCRIPTION OF EUT .....</i>	<i>9</i>
5.2. <i>CHANNEL LIST.....</i>	<i>9</i>
5.3. <i>MAXIMUM OUTPUT POWER.....</i>	<i>10</i>
5.4. <i>TEST CHANNEL CONFIGURATION.....</i>	<i>10</i>
5.5. <i>THE WORSE CASE POWER SETTING PARAMETER.....</i>	<i>10</i>
5.6. <i>THE WORSE CASE CONFIGURATIONS .....</i>	<i>11</i>
5.7. <i>DESCRIPTION OF AVAILABLE ANTENNAS .....</i>	<i>12</i>
5.8. <i>DESCRIPTION OF TEST SETUP.....</i>	<i>13</i>
<b>6. MEASURING INSTRUMENT AND SOFTWARE USED .....</b>	<b>14</b>
<b>7. ANTENNA PORT TEST RESULTS .....</b>	<b>16</b>
7.1. <i>ON TIME AND DUTY CYCLE.....</i>	<i>16</i>
7.2. <i>6 dB DTS BANDWIDTH AND 99 % OCCUPIED BANDWIDTH .....</i>	<i>17</i>
7.3. <i>CONDUCTED OUTPUT POWER.....</i>	<i>19</i>
7.4. <i>POWER SPECTRAL DENSITY .....</i>	<i>20</i>
7.5. <i>CONDUCTED BANDEDGE AND SPURIOUS EMISSIONS.....</i>	<i>22</i>
<b>8. RADIATED TEST RESULTS.....</b>	<b>24</b>
8.1. <i>RESTRICTED BANDEDGE.....</i>	<i>30</i>
8.1.1. <i>802.11b MODE .....</i>	<i>30</i>
8.1.2. <i>802.11g MODE .....</i>	<i>34</i>
8.1.3. <i>802.11n HT20 MODE .....</i>	<i>38</i>
8.1.4. <i>802.11n HT40 MODE .....</i>	<i>42</i>
8.2. <i>SPURIOUS EMISSIONS (1 GHz ~ 3 GHz).....</i>	<i>46</i>
8.2.1. <i>802.11 b MODE .....</i>	<i>46</i>
8.3. <i>SPURIOUS EMISSIONS (3 GHz ~ 18 GHz).....</i>	<i>52</i>
8.3.1. <i>802.11b MODE .....</i>	<i>52</i>
8.3.2. <i>802.11g MODE .....</i>	<i>58</i>
8.3.3. <i>802.11n HT20 MODE .....</i>	<i>64</i>
8.3.4. <i>802.11n HT40 MODE .....</i>	<i>70</i>



8.4.	SPURIOUS EMISSIONS (18 GHz ~ 26 GHz)	76
8.4.1.	802.11b MODE	76
8.5.	SPURIOUS EMISSIONS (30 MHz ~ 1 GHz)	78
8.5.1.	802.11b MODE	78
8.6.	SPURIOUS EMISSIONS BELOW 30 MHz	80
8.6.1.	802.11b MODE	80
<b>9.</b>	<b>AC POWER LINE CONDUCTED EMISSIONS</b>	<b>83</b>
9.1.1.	802.11b MODE	84
<b>10.</b>	<b>ANTENNA REQUIREMENTS</b>	<b>87</b>
<b>11.</b>	<b>Appendix</b>	<b>88</b>
11.1.	Appendix A: DTS Bandwidth	88
11.1.1.	Test Result	88
11.1.2.	Test Graphs	89
11.2.	Appendix B: Occupied Channel Bandwidth	93
11.2.1.	Test Result	93
11.2.2.	Test Graphs	94
11.3.	Appendix C: Maximum conducted output power	98
11.3.1.	Test Result	98
11.4.	Appendix D: Maximum power spectral density	99
11.4.1.	Test Result	99
11.4.2.	Test Graphs	100
11.5.	Appendix E: Band edge measurements	104
11.5.1.	Test Result	104
11.5.2.	Test Graphs	105
11.6.	Appendix F: Conducted Spurious Emission	108
11.6.1.	Test Result	108
11.6.2.	Test Graphs	109
11.7.	Appendix G: Duty Cycle	121
11.7.1.	Test Result	121
11.7.2.	Test Graphs	122



# 1. ATTESTATION OF TEST RESULTS

## Applicant Information

Company Name: Beijing Roborock Technology Co., Ltd.  
Address: Floor 6, Suite 6016, 6017, 6018, Building C, Kangjian Baosheng Plaza, No.8 Heiquan Road, Haidian District, Beijing, P.R. China

## Manufacturer Information

Company Name: Beijing Roborock Technology Co., Ltd.  
Address: Floor 6, Suite 6016, 6017, 6018, Building C, Kangjian Baosheng Plaza, No.8 Heiquan Road, Haidian District, Beijing, P.R. China

## EUT Information

EUT Name: Robotic Vacuum Cleaner  
Model: S270RR  
Brand: /  
Sample Received Date: February 24, 2022  
Sample Status: Normal  
Sample ID: 4701840  
Date of Tested: February 24, 2022~ March 28, 2022

APPLICABLE STANDARDS	
STANDARD	TEST RESULTS
CFR 47 FCC PART 15 SUBPART C	PASS
ISED RSS-247 Issue 2	PASS
ISED RSS-GEN Issue 5	PASS

Prepared By:

*Dean Hua*

Dean Hua  
Project Engineer

Checked By:

*Shawn Wen*

Shawn Wen  
Laboratory Leader

Approved By:

*Stephen Guo*

Stephen Guo  
Laboratory Manager



## 2. TEST METHODOLOGY

The tests documented in this report were performed in accordance with KDB 558074 D01 15.247 Meas Guidance v05r02, KDB 414788 D01 Radiated Test Site v01r01, CFR 47 FCC Part 2, CFR 47 FCC Part 15, ANSI C63.10-2013, ISED RSS-247 Issue 2 and ISED RSS-GEN Issue 5.

## 3. FACILITIES AND ACCREDITATION

Accreditation Certificate	<p><b>A2LA (Certificate No.: 4102.01)</b> UL Verification Services (Guangzhou) Co., Ltd. Song Shan Lake Branch. has been assessed and proved to be in compliance with A2LA.</p> <p><b>FCC (FCC Designation No.: CN1187)</b> UL Verification Services (Guangzhou) Co., Ltd. Song Shan Lake Branch. Has been recognized to perform compliance testing on equipment subject to the Commission's Declaration of Conformity (DoC) and Certification rules</p> <p><b>ISED (Company No.: 21320)</b> UL Verification Services (Guangzhou) Co., Ltd. Song Shan Lake Branch. has been registered and fully described in a report filed with ISED. The Company Number is 21320 and the test lab Conformity Assessment Body Identifier (CABID) is CN0046.</p> <p><b>VCCI (Registration No.: G-20019, R-20004, C-20012 and T-20011)</b> UL Verification Services (Guangzhou) Co., Ltd. Song Shan Lake Branch. has been assessed and proved to be in compliance with VCCI, the Membership No. is 3793. Facility Name: Chamber D, the VCCI registration No. is G-20019 and R-20004 Shielding Room B , the VCCI registration No. is C-20012 and T-20011</p>
---------------------------	---

Note 1: All tests measurement facilities use to collect the measurement data are located at Building 10, Innovation Technology Park, Song Shan Lake Hi tech Development Zone, Dongguan, 523808, China

Note 2: The test anechoic chamber in UL Verification Services (Guangzhou) Co., Ltd. Song Shan Lake Branch had been calibrated and compared to the open field sites and the test anechoic chamber is shown to be equivalent to or worst case from the open field site.

Note 3: For below 30 MHz, lab had performed measurements at test anechoic chamber and comparing to measurements obtained on an open field site. And these measurements below 30 MHz had been correlated to measurements performed on an OFS.



## 4. CALIBRATION AND UNCERTAINTY

### 4.1. MEASURING INSTRUMENT CALIBRATION

The measuring equipment utilized to perform the tests documented in this report has been calibrated in accordance with the manufacturer's recommendations and is traceable to recognize national standards.

### 4.2. MEASUREMENT UNCERTAINTY

Where relevant, the following measurement uncertainty levels have been estimated for tests performed on the apparatus:

Test Item	Uncertainty
Conduction emission	3.62 dB
Radiated Emission (Included Fundamental Emission) (9 kHz ~ 30 MHz)	2.2 dB
Radiated Emission (Included Fundamental Emission) (30 MHz ~ 1 GHz)	4.00 dB
Radiated Emission (Included Fundamental Emission) (1 GHz to 26 GHz)	5.78 dB (1 GHz ~ 18 GHz)
	5.23 dB (18 GHz ~ 26 GHz)
Duty Cycle	±0.028%
DTS and 99% Occupied Bandwidth	±0.0196%
Maximum Conducted Output Power	±0.686 dB
Maximum Power Spectral Density Level	±0.743 dB
Conducted Band-edge Compliance	±1.328 dB
Conducted Unwanted Emissions In Non-restricted Frequency Bands	±0.746 dB (9 kHz ~ 1 GHz)
	±1.328dB (1 GHz ~ 26 GHz)
Note: This uncertainty represents an expanded uncertainty expressed at approximately the 95% confidence level using a coverage factor of k=2.	





## 5. EQUIPMENT UNDER TEST

### 5.1. DESCRIPTION OF EUT

EUT Name:	Robotic Vacuum Cleaner
Model Name:	S270RR
Radio Technology	IEEE802.11b/g/n HT20/n HT40
Operation frequency	IEEE 802.11b: 2412MHz—2462MHz IEEE 802.11g: 2412MHz—2462MHz IEEE 802.11n HT20: 2412MHz—2462MHz IEEE 802.11n HT40: 2422MHz—2452MHz
Modulation	IEEE 802.11b: DSSS(CCK) IEEE 802.11g: OFDM(64QAM, 16QAM, QPSK, BPSK) IEEE 802.11n HT20: OFDM (64QAM, 16QAM, QPSK,BPSK) IEEE 802.11n HT40: OFDM (64QAM, 16QAM, QPSK,BPSK)
Power Supply	DC14.4V from battery; DC 20V from dock charger

### 5.2. CHANNEL LIST

Channel List for 802.11b/g/n (20 MHz)							
Channel	Frequency (MHz)	Channel	Frequency (MHz)	Channel	Frequency (MHz)	Channel	Frequency (MHz)
1	2412	4	2427	7	2442	10	2457
2	2417	5	2432	8	2447	11	2462
3	2422	6	2437	9	2452	/	/

Channel List for 802.11n (40 MHz)							
Channel	Frequency (MHz)	Channel	Frequency (MHz)	Channel	Frequency (MHz)	Channel	Frequency (MHz)
3	2422	5	2432	7	2442	9	2452
4	2427	6	2437	8	2447	/	/

### 5.3. MAXIMUM OUTPUT POWER

IEEE Std. 802.11	Frequency (MHz)	Channel Number	Maximum Conducted AVG Output Power (dBm)
b	2412 ~ 2462	1-11[1]	17.12
g	2412 ~ 2462	1-11[1]	13.82
n HT20	2412 ~ 2462	1-11[6]	13.71
n HT40	2422 ~ 2452	3-9[9]	9.65

### 5.4. TEST CHANNEL CONFIGURATION

IEEE Std. 802.11	Test Channel	Frequency
b	CH 1, CH 6, CH 11/ Low, Middle, High	2412MHz, 2437MHz, 2462MHz
g	CH 1, CH 6, CH 11/ Low, Middle, High	2412MHz, 2437MHz, 2462MHz
n HT20	CH 1, CH 6, CH 11/ Low, Middle, High	2412MHz, 2437MHz, 2462MHz
n HT40	CH 3, CH 6, CH 9/ Low, Middle, High	2422MHz, 2437MHz, 2452MHz

### 5.5. THE WORSE CASE POWER SETTING PARAMETER

The Worst Case Power Setting Parameter under 2400 ~ 2483.5MHz Band							
Test Software		CMD					
Modulation Mode	Transmit Antenna Number	Test Channel					
		NCB: 20MHz			NCB: 40MHz		
		CH 1	CH 6	CH 11	CH 3	CH 6	CH 9
802.11b	1	Default	Default	Default	/		
802.11g	1	56	56	60			
802.11n HT20	1	56	60	60			
802.11n HT40	1	/			38	38	38



## 5.6. THE WORSE CASE CONFIGURATIONS

The EUT was tested in the following configuration(s):

Controlled in test mode using a software application on the EUT supplied by customer. The application was used to enable a continuous transmission and to select the mode, test channels, bandwidth, data rates as required.

Test channels referring to section 5.4.

Maximum power setting referring to section 5.5.

Worst-case data rates as provided by the client were:

802.11b mode: 1 Mbps

802.11g mode: 6 Mbps

802.11n HT20 mode: MCS0

802.11n HT40 mode: MCS0

The measured additional path loss was included in any path loss calculations for all RF cable used during tested.



## 5.7. DESCRIPTION OF AVAILABLE ANTENNAS

Antenna	Frequency (MHz)	Antenna Type	MAX Antenna Gain (dBi)
1	2412-2462	PCB	2.82

Test Mode	Transmit and Receive Mode	Description
IEEE 802.11b	<input checked="" type="checkbox"/> 1TX, 1RX	ANT 1 can be used as transmitting/receiving antenna.
IEEE 802.11g	<input checked="" type="checkbox"/> 1TX, 1RX	ANT 1 can be used as transmitting/receiving antenna.
IEEE 802.11n HT20	<input checked="" type="checkbox"/> 1TX, 1RX	ANT 1 can be used as transmitting/receiving antenna.
IEEE 802.11n HT40	<input checked="" type="checkbox"/> 1TX, 1RX	ANT 1 can be used as transmitting/receiving antenna.

Note: The value of the antenna gain was declared by customer.

## 5.8. DESCRIPTION OF TEST SETUP

### SUPPORT EQUIPMENT

Item	Equipment	Brand Name	Model Name	Remarks
1	Laptop	Lenovo	XIAOXIN 5000	/
2	UART	/	/	/

### I/O CABLES

Cable No	Port	Connector Type	Cable Type	Cable Length(m)	Remarks
1	USB	N/A	Micro USB	1	N/A

### ACCESSORIES

Item	Accessory	Brand Name	Model Name	Description
1	Dock Charger	Roborck	CDZ11RR	Input: 100~240VAC 50-60Hz Output: 20VDC 1.2A

### TEST SETUP

The EUT can work in engineering mode with a software through a Laptop.

### SETUP DIAGRAM FOR TESTS

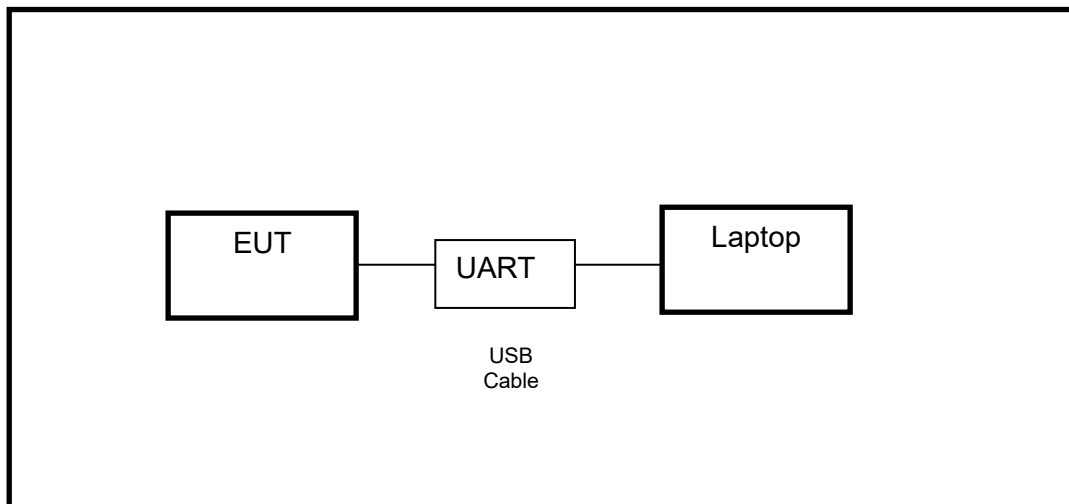

**6. MEASURING INSTRUMENT AND SOFTWARE USED**

Conducted Emissions					
Equipment	Manufacturer	Model No.	Serial No.	Last Cal.	Due Date
EMI Test Receiver	R&S	ESR3	101961	Oct.30, 2021	Oct.29, 2022
Artificial Mains Networks	Schwarzbeck	NSLK 8126	8126465	Oct.30, 2021	Oct.29, 2022
Software					
Description			Manufacturer	Name	Version
Test Software for Conducted Emissions			Farad	EZ-EMC	Ver. UL-3A1

Radiated Emissions					
Equipment	Manufacturer	Model No.	Serial No.	Last Cal.	Due Date
MXE EMI Receiver	KESIGHT	N9038A	MY56400036	Oct.30, 2021	Oct.29, 2022
Hybrid Log Periodic Antenna	TDK	HLP-3003C	130959	Aug.02, 2021	Aug.01, 2024
Preamplifier	HP	8447D	2944A09099	Oct.30, 2021	Oct.29, 2022
EMI Measurement Receiver	R&S	ESR26	101377	Oct.30, 2021	Oct.29, 2022
Horn Antenna	TDK	HRN-0118	130940	July 20, 2021	July 19, 2024
Preamplifier	TDK	PA-02-0118	TRS-305-00067	Oct.30, 2021	Oct.29, 2022
Horn Antenna	Schwarzbeck	BBHA9170	697	July 20, 2021	July 19, 2024
Preamplifier	TDK	PA-02-2	TRS-307-00003	Oct.31, 2021	Oct.30, 2022
Preamplifier	TDK	PA-02-3	TRS-308-00002	Oct.31, 2021	Oct.30, 2022
Loop antenna	Schwarzbeck	1519B	00008	Dec.14, 2021	Dec.13, 2024
Preamplifier	TDK	PA-02-001-3000	TRS-302-00050	Oct.31, 2021	Oct.30, 2022
Preamplifier	Mini-Circuits	ZX60-83LN-S+	SUP01201941	Oct.31, 2021	Oct.30, 2022
High Pass Filter	Wi	WHKX10-2700-3000-18000-40SS	23	Oct.31, 2021	Oct.30, 2022
Highpass Filter	Wainwright	WHKX10-5850-6500-1800-40SS	4	Oct.31, 2021	Oct.30, 2022
Band Reject Filter	Wainwright	WRCJV8-2350-2400-2483.5-2533.5-40SS	4	Oct.31, 2021	Oct.30, 2022



Software			
Description	Manufacturer	Name	Version
Test Software for Radiated Emissions	Farad	EZ-EMC	Ver. UL-3A1

Other instruments					
Equipment	Manufacturer	Model No.	Serial No.	Last Cal.	Next Cal.
Spectrum Analyzer	R&S	FSV40	101117	Oct.31, 2021	Oct.30, 2022
Dual Channel Power Meter	Keysight	N1912A	MY55416024	Oct.30, 2021	Oct.29, 2022
Power Sensor	Keysight	USB Wideband Power Sensor	MY5100022	Oct.30, 2021	Oct.29, 2022

## 7. ANTENNA PORT TEST RESULTS

### 7.1. ON TIME AND DUTY CYCLE

#### LIMITS

None; for reporting purposes only

#### PROCEDURE

Refer to ANSI C63.10-2013 clause 11.6 Zero – Span Spectrum Analyzer method.

#### TEST SETUP

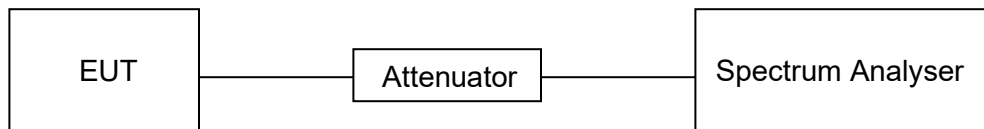

#### TEST ENVIRONMENT

Temperature	22.6 °C	Relative Humidity	48 %
Atmosphere Pressure	101 kPa	Test Voltage	DC 14.4V

#### RESULTS

Please refer to appendix G.



## 7.2. 6 dB DTS BANDWIDTH AND 99 % OCCUPIED BANDWIDTH

### LIMITS

CFR 47 FCC Part15 (15.247) Subpart C ISED RSS-247 ISSUE 2			
Section	Test Item	Limit	Frequency Range (MHz)
CFR 47 FCC 15.247(a)(2) ISED RSS-247 5.2 (a)	6 dB Bandwidth	≥ 500 kHz	2400-2483.5
ISED RSS-Gen Clause 6.7	99 % Occupied Bandwidth	For reporting purposes only.	2400-2483.5

### TEST PROCEDURE

Connect the EUT to the spectrum analyser and use the following settings:

Center Frequency	The center frequency of the channel under test
Frequency Span	Between 1.5 times and 5.0 times the OBW
Detector	Peak
RBW	For 6 dB Bandwidth: 100 kHz For 99 % Occupied Bandwidth: 1 % to 5 % of the occupied bandwidth
VBW	For 6 dB Bandwidth: ≥3 × RBW For 99 % Occupied Bandwidth: ≥3 × RBW
Trace	Max hold
Sweep	Auto couple

a) Use the 99 % power bandwidth function of the instrument, allow the trace to stabilize and report the measured bandwidth.

b) Allow the trace to stabilize and measure the maximum width of the emission that is constrained by the frequencies associated with the two outermost amplitude points (upper and lower frequencies) that are attenuated by 6 dB relative to the maximum level measured in the fundamental emission.

### TEST SETUP

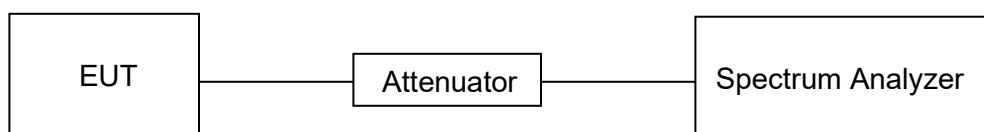



**TEST ENVIRONMENT**

Temperature	22.6 °C	Relative Humidity	48 %
Atmosphere Pressure	101 kPa	Test Voltage	DC 14.4V

**RESULTS**

Please refer to appendix A & B.

### 7.3. CONDUCTED OUTPUT POWER

#### LIMITS

CFR 47 FCC Part15 (15.247) Subpart C ISED RSS-247 ISSUE 2			
Section	Test Item	Limit	Frequency Range (MHz)
CFR 47 FCC 15.247(b)(3) ISED RSS-247 5.4 (d)	AVG Output Power	1 watt or 30 dBm	2400-2483.5

#### TEST PROCEDURE

Refer to ANSI C63.10-2013 clause 11.9.2.3.1 Method AVGPM

Connect the EUT to a low loss RF cable from the antenna port to the power sensor (video bandwidth is greater than the occupied bandwidth).

Measure the average power of the transmitter, the indicated level is the average output power, after any corrections for external attenuators and cables.

#### TEST SETUP

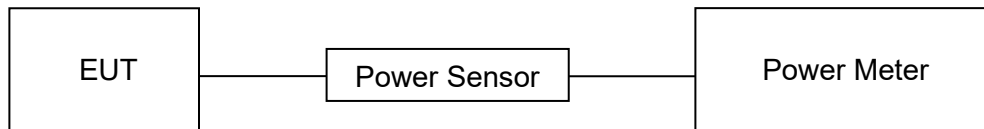

#### TEST ENVIRONMENT

Temperature	22.6 °C	Relative Humidity	48 %
Atmosphere Pressure	101 kPa	Test Voltage	DC 14.4V

#### RESULTS

Please refer to appendix C.

## 7.4. POWER SPECTRAL DENSITY

### LIMITS

CFR 47 FCC Part15 (15.247) Subpart C ISED RSS-247 ISSUE 2			
Section	Test Item	Limit	Frequency Range (MHz)
CFR 47 FCC §15.247 (e) ISED RSS-247 5.2 (b)	Power Spectral Density	8 dBm/3 kHz	2400-2483.5

### TEST PROCEDURE

Connect the EUT to the spectrum analyser and use the following settings:

Center Frequency	The center frequency of the channel under test
Detector	RMS
RBW	$3 \text{ kHz} \leq \text{RBW} \leq 100 \text{ kHz}$
VBW	$\geq 3 \times \text{RBW}$
Span	1.5 x DTS bandwidth
Trace	Trace average at least 100 traces
Sweep time	Auto couple

Refer to ANSI C63.10-2013 clause 11.10.3 Method AVGPSD-1

Allow trace to fully stabilize and use the peak marker function to determine the maximum amplitude level within the RBW.

If measured value exceeds limit, reduce RBW (no less than 3 kHz) and repeat.

### TEST SETUP

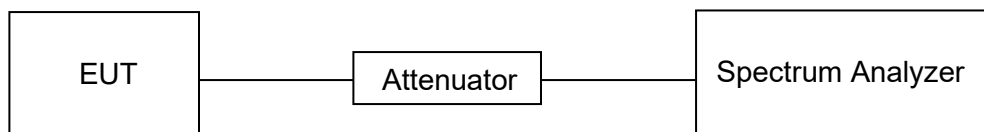

### TEST ENVIRONMENT

Temperature	22.6 °C	Relative Humidity	48 %
Atmosphere Pressure	101 kPa	Test Voltage	DC 14.4V



**RESULTS**

Please refer to appendix D.



## 7.5. CONDUCTED BANDEGE AND SPURIOUS EMISSIONS

### LIMITS

CFR 47 FCC Part15 (15.247) Subpart C ISED RSS-247 ISSUE 2		
Section	Test Item	Limit
CFR 47 FCC §15.247 (d) ISED RSS-247 5.5	Conducted Bandedge and Spurious Emissions	at least 30 dB below that in the 100 kHz bandwidth within the band that contains the highest level of the desired power

### TEST PROCEDURE

Refer to ANSI C63.10-2013 clause 11.11 and 11.13.

Connect the EUT to the spectrum analyser and use the following settings for reference level measurement:

Center Frequency	The center frequency of the channel under test
Detector	Peak
RBW	100 kHz
VBW	$\geq 3 \times \text{RBW}$
Span	1.5 x DTS bandwidth
Trace	Max hold
Sweep time	Auto couple.

Allow trace to fully stabilize and use the peak marker function to determine the maximum PSD level.

Change the settings for emission level measurement:

Span	Set the center frequency and span to encompass frequency range to be measured
Detector	Peak
RBW	100 kHz
VBW	$\geq 3 \times \text{RBW}$
measurement points	$\geq \text{span}/\text{RBW}$
Trace	Max hold
Sweep time	Auto couple.

Allow trace to fully stabilize and use the peak marker function to determine the maximum PSD level. Ensure that the amplitude of all unwanted emissions outside of the authorized frequency band (excluding restricted frequency bands) is attenuated by at least the minimum requirements specified in 11.11.



**TEST SETUP**

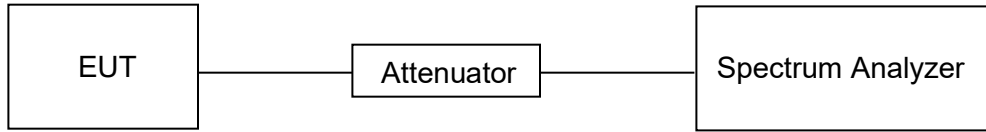

**TEST ENVIRONMENT**

Temperature	22.6 °C	Relative Humidity	48 %
Atmosphere Pressure	101 kPa	Test Voltage	DC 14.4V

**RESULTS**

Please refer to appendix E & F.



## 8. RADIATED TEST RESULTS

### LIMITS

Please refer to CFR 47 FCC §15.205 and §15.209.

Please refer to ISED RSS-GEN Clause 8.9 and Clause 8.10.

Radiation Disturbance Test Limit for FCC (Class B) (9 kHz ~ 1 GHz)

Emissions radiated outside of the specified frequency bands above 30 MHz			
Frequency Range (MHz)	Field Strength Limit (uV/m) at 3 m	Field Strength Limit (dBuV/m) at 3 m	
		Quasi-Peak	
30 - 88	100	40	
88 - 216	150	43.5	
216 - 960	200	46	
Above 960	500	54	
Above 1000	500	Peak	Average
		74	54

FCC Emissions radiated outside of the specified frequency bands below 30 MHz		
Frequency (MHz)	Field strength (microvolts/meter)	Measurement distance (meters)
0.009-0.490	2400/F(kHz)	300
0.490-1.705	24000/F(kHz)	30
1.705-30.0	30	30

ISED General field strength limits at frequencies below 30 MHz

Table 6 – General field strength limits at frequencies below 30 MHz		
Frequency	Magnetic field strength (H-Field) (µA/m)	Measurement distance (m)
9 - 490 kHz <sup>Note 1</sup>	6.37/F (F in kHz)	300
490 - 1705 kHz	63.7/F (F in kHz)	30
1.705 - 30 MHz	0.08	30

**Note 1:** The emission limits for the ranges 9-90 kHz and 110-490 kHz are based on measurements employing a linear average detector.





ISED Restricted bands please refer to ISED RSS-GEN Clause 8.10

**Table 7 – Restricted frequency bands<sup>Note 1</sup>**

MHz	MHz	GHz
0.090 - 0.110	149.9 - 150.05	9.0 - 9.2
0.495 - 0.505	166.52475 - 166.52525	9.3 - 9.5
2.1735 - 2.1905	166.7 - 166.9	10.6 - 12.7
3.020 - 3.028	162.0125 - 167.17	13.25 - 13.4
4.125 - 4.128	167.72 - 173.2	14.47 - 14.5
4.17725 - 4.17775	240 - 285	15.35 - 16.2
4.20725 - 4.20775	322 - 335.4	17.7 - 21.4
5.677 - 5.683	399.9 - 410	22.01 - 23.12
6.215 - 6.218	608 - 614	23.6 - 24.0
6.26775 - 6.26825	960 - 1427	31.2 - 31.8
6.31175 - 6.31225	1435 - 1626.5	36.43 - 36.5
8.291 - 8.294	1045.5 - 1646.5	Above 38.6
8.362 - 8.366	1660 - 1710	
8.37625 - 8.38675	1718.8 - 1722.2	
8.41425 - 8.41475	2200 - 2300	
12.29 - 12.293	2310 - 2390	
12.51975 - 12.52025	2483.5 - 2500	
12.57675 - 12.57725	2655 - 2900	
13.36 - 13.41	3260 - 3267	
16.42 - 16.423	3332 - 3339	
16.69475 - 16.69525	3345.8 - 3358	
16.80425 - 16.80475	3500 - 4400	
25.5 - 25.67	4500 - 5150	
37.5 - 38.25	5350 - 5460	
73 - 74.6	7250 - 7750	
74.8 - 75.2	8025 - 8500	
108 - 138		

**Note 1:** Certain frequency bands listed in table 7 and in bands above 38.6 GHz are designated for licence-exempt applications. These frequency bands and the requirements that apply to related devices are set out in the 200 and 300 series of RSSs.

FCC Restricted bands of operation refer to FCC §15.205 (a):

MHz	MHz	MHz	GHz
0.090-0.110	16.42-16.423	399.9-410	4.5-5.15
<sup>1</sup> 0.495-0.505	16.69475-16.69525	608-614	5.35-5.46
2.1735-2.1905	16.80425-16.80475	960-1240	7.25-7.75
4.125-4.128	25.5-25.67	1300-1427	8.025-8.5
4.17725-4.17775	37.5-38.25	1435-1626.5	9.0-9.2
4.20725-4.20775	73-74.6	1645.5-1646.5	9.3-9.5
6.215-6.218	74.8-75.2	1660-1710	10.6-12.7
6.26775-6.26825	108-121.94	1718.8-1722.2	13.25-13.4
6.31175-6.31225	123-138	2200-2300	14.47-14.5
8.291-8.294	149.9-150.05	2310-2390	15.35-16.2
8.362-8.366	156.52475-156.52525	2483.5-2500	17.7-21.4
8.37625-8.38675	156.7-156.9	2690-2900	22.01-23.12
8.41425-8.41475	162.0125-167.17	3260-3267	23.6-24.0
12.29-12.293	167.72-173.2	3332-3339	31.2-31.8
12.51975-12.52025	240-285	3345.8-3358	36.43-36.5
12.57675-12.57725	322-335.4	3600-4400	( <sup>2</sup> )
13.36-13.41			

Note: <sup>1</sup>Until February 1, 1999, this restricted band shall be 0.490-0.510 MHz.

<sup>2</sup>Above 38.6c

**TEST SETUP AND PROCEDURE**

Below 30 MHz

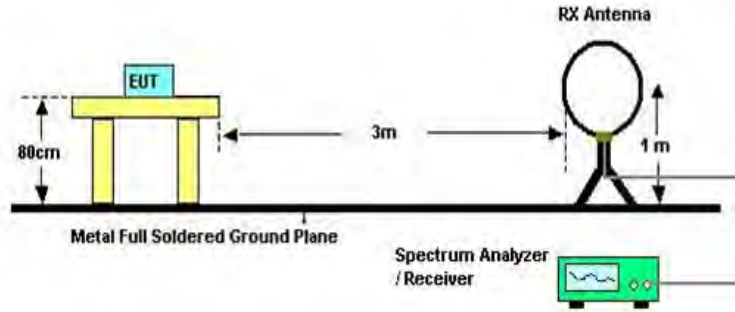

The setting of the spectrum analyser

RBW	200 Hz (From 9 kHz to 0.15 MHz)/ 9 kHz (From 0.15 MHz to 30 MHz)
VBW	200 Hz (From 9 kHz to 0.15 MHz)/ 9 kHz (From 0.15 MHz to 30 MHz)
Sweep	Auto
Trace	Max hold

1. The testing follows the guidelines in ANSI C63.10-2013 clause 6.4.
2. The EUT was arranged to its worst case and then turntable (from 0 degree to 360 degrees) to find the maximum reading. A pre-amp and a high pass filter are used for the test in order to get better signal level. Both Horizontal, Face-on and Face-off polarizations of the antenna are set to make the measurement.
3. The EUT was placed on a turntable with 80 cm above ground.
4. The EUT was set 3 meters from the interference receiving antenna, which was mounted on the top of a 1 m height antenna tower.
5. The radiated emission limits are based on measurements employing a CISPR quasi-peak detector except for the frequency bands 9-90 kHz, 110-490 kHz and above 1000 MHz. Radiated emission limits in these three bands are based on measurements employing an average detector.
6. For measurement below 1 GHz, the initial step in collecting conducted emission data is a spectrum analyzer peak detector mode pre-scanning the measurement frequency range. Significant peaks are then marked and then Quasi Peak and average detector mode re-measured. If the emission level of the EUT measured by the peak detector is 3 dB lower than the applicable limit, the peak emission level will be reported. Otherwise, the emission measurement will be repeated using the quasi-peak and average detector and reported.
7. Although these tests were performed other than open field site, adequate comparison measurements were confirmed against 30m open field site. Therefore sufficient tests were made to demonstrate that the alternative site produces results that correlate with the ones of tests made in an open field site based on KDB 414788.
8. The limits in CFR 47, Part 15, Subpart C, paragraph 15.209 (a), are identical to those in RSS-GEN Section 8.9, Table 6, since the measurements are performed in terms of magnetic field strength and converted to electric field strength levels (as reported in the table) using the free space impedance of 377 Ω; For example, the measurement frequency X kHz resulted in a level of Y dBuV/m, which is equivalent to  $Y-51.5 = Z$  dBuA/m, which has the same margin, W dB, to the corresponding RSS-GEN Table 6 limit as it has to be 15.209(a) limit.

Below 1 GHz and above 30 MHz

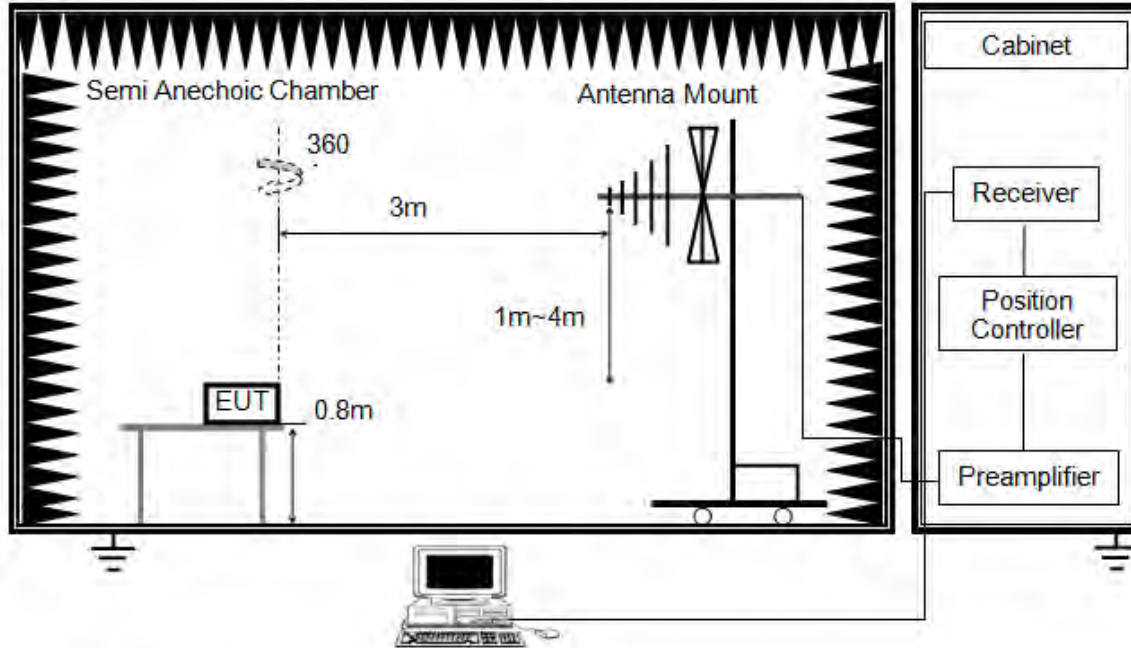

The setting of the spectrum analyzer

RBW	120 kHz
VBW	300 kHz
Sweep	Auto
Detector	Peak/QP
Trace	Max hold

1. The testing follows the guidelines in ANSI C63.10-2013 clause 6.5.
2. The EUT was arranged to its worst case and then tune the antenna tower (from 1 m to 4 m) and turntable (from 0 degree to 360 degrees) to find the maximum reading. A pre-amp and a high pass filter are used for the test in order to get better signal level. Both horizontal and vertical polarizations of the antenna are set to make the measurement.
3. The EUT was placed on a turntable with 80 cm above ground.
4. The EUT was set 3 meters from the interference receiving antenna, which was mounted on the top of a variable height antenna tower.
5. For measurement below 1 GHz, the initial step in collecting conducted emission data is a spectrum analyzer peak detector mode pre-scanning the measurement frequency range. Significant peaks are then marked and then Quasi Peak detector mode re-measured. If the emission level of the EUT measured by the peak detector is 3 dB lower than the applicable limit, the peak emission level will be reported. Otherwise, the emission measurement will be repeated using the quasi-peak detector and reported.

Above 1 GHz

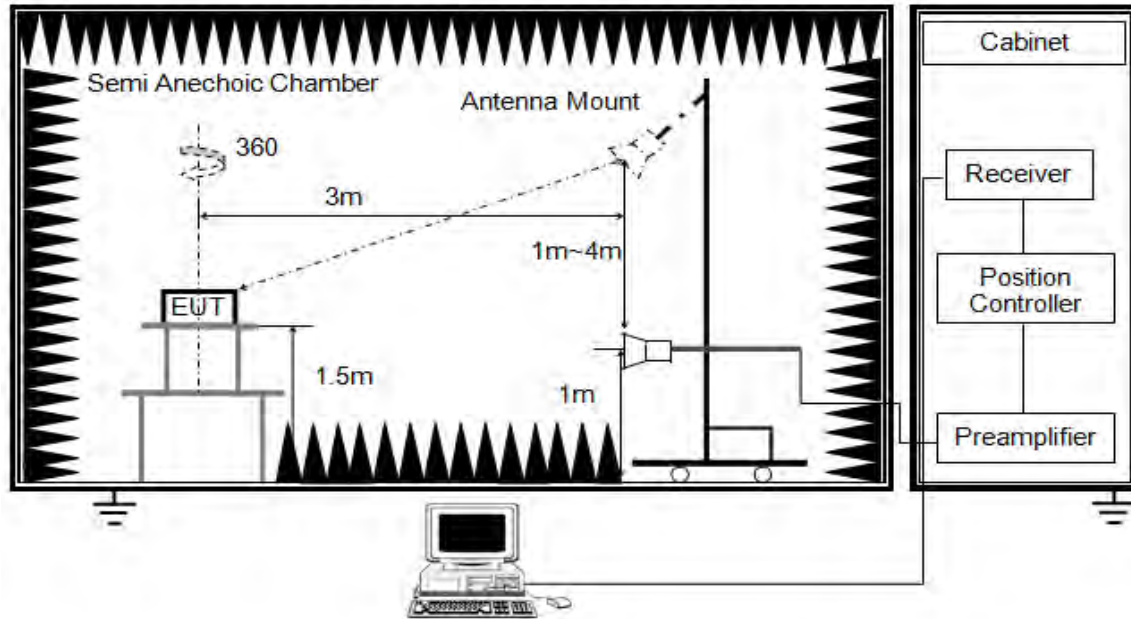

The setting of the spectrum analyser

RBW	1 MHz
VBW	PEAK: 3 MHz AVG: see note 6
Sweep	Auto
Detector	Peak
Trace	Max hold

1. The testing follows the guidelines in ANSI C63.10-2013 clause 6.6.
2. The EUT was arranged to its worst case and then tune the antenna tower (from 1 m to 4 m) and turntable (from 0 degree to 360 degrees) to find the maximum reading. A pre-amp and a high pass filter are used for the test in order to get better signal level. Both horizontal and vertical polarizations of the antenna are set to make the measurement.
3. The EUT was placed on a turntable with 1.5 m above ground.
4. The EUT was set 3 meters from the interference receiving antenna, which was mounted on the top of a variable height antenna tower.
5. For measurement above 1 GHz, the emission measurement will be measured by the peak detector. This peak level, once corrected, must comply with the limit specified in Section 15.209.
6. For measurements above 1 GHz the resolution bandwidth is set to 1 MHz, then the video bandwidth is set to 3 MHz for peak measurements and 1 MHz resolution bandwidth with 1/T video bandwidth with peak detector for average measurements. For the Duty Cycle please refer to clause 7.1.ON TIME AND DUTY CYCLE.

X axis, Y axis, Z axis positions:

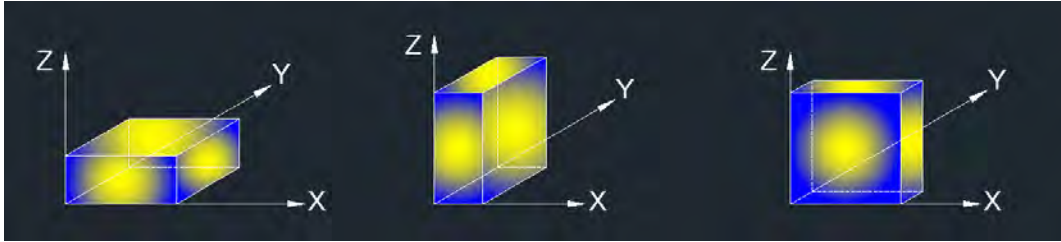

Note 1: For all radiated test, EUT in each of three orthogonal axis emissions had been tested, but only the worst case (X axis) data recorded in the report.

### TEST ENVIRONMENT

Temperature	22 °C	Relative Humidity	60 %
Atmosphere Pressure	101 kPa	Test Voltage	DC 14.4 V

### RESULTS

## 8.1. RESTRICTED BANDEDGE

### 8.1.1. 802.11b MODE

#### ANTENNA 1 TEST RESULTS (WORST CASE)

#### RESTRICTED BANDEDGE (LOW CHANNEL, VERTICAL)

#### PEAK

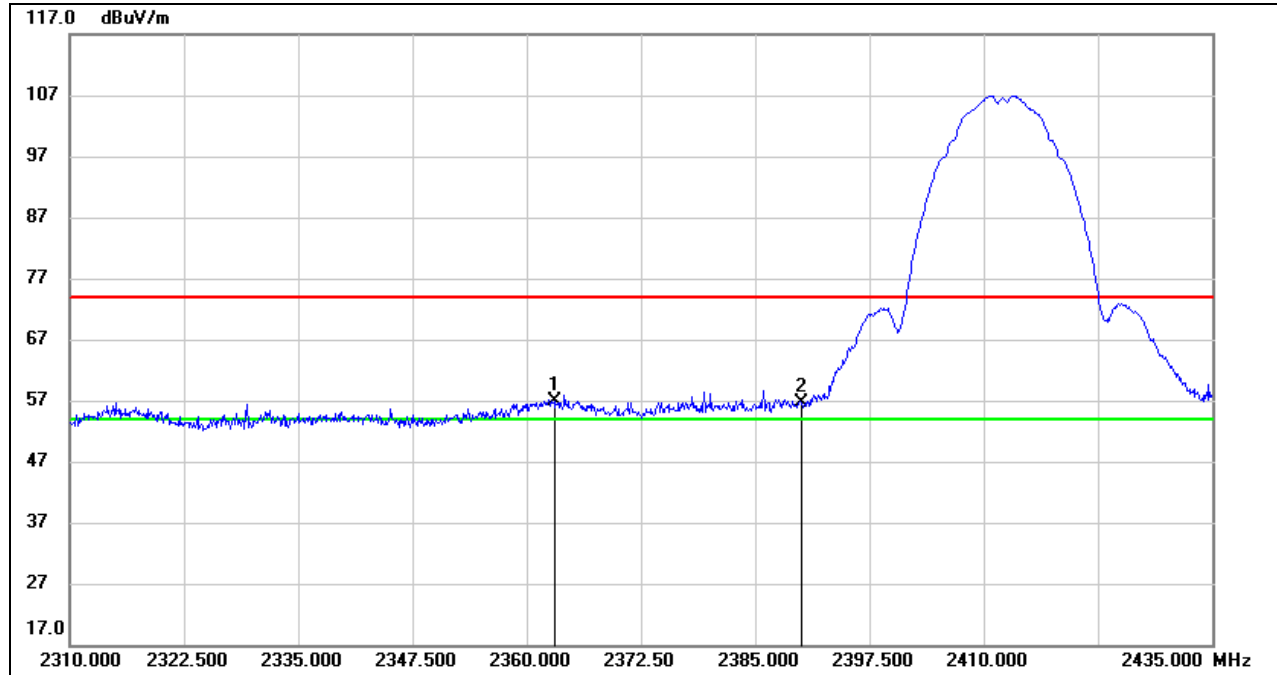

No.	Frequency (MHz)	Reading (dBuV)	Correct (dB/m)	Result (dBuV/m)	Limit (dBuV/m)	Margin (dB)	Remark
1	2363.000	24.48	32.43	56.91	74.00	-17.09	peak
2	2390.000	24.07	32.66	56.73	74.00	-17.27	peak

Note: 1. Measurement = Reading Level + Correct Factor.

2. Peak: Peak detector.

3. Only the worst data was recorded, if it complies with the limit, the other emissions deemed to comply with the limit.

**AVG**

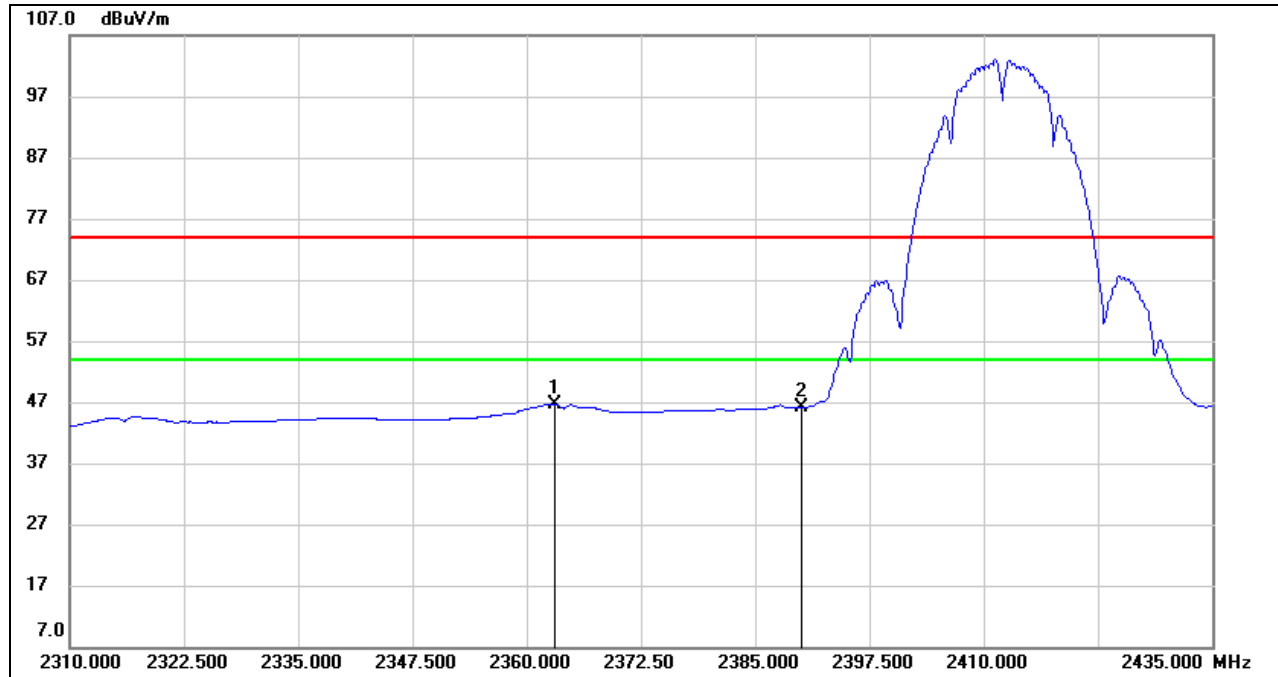

No.	Frequency (MHz)	Reading (dBuV)	Correct (dB/m)	Result (dBuV/m)	Limit (dBuV/m)	Margin (dB)	Remark
1	2363.000	14.31	32.43	46.74	54.00	-7.26	AVG
2	2390.000	13.48	32.66	46.14	54.00	-7.86	AVG

- Note:
1. Measurement = Reading Level + Correct Factor.
  2. AVG:  $VBW=1/Ton$ , where: Ton is the transmitting duration.
  3. For the transmitting duration, please refer to clause 7.1.
  4. Only the worst data was recorded, if it complies with the limit, the other emissions deemed to comply with the limit.

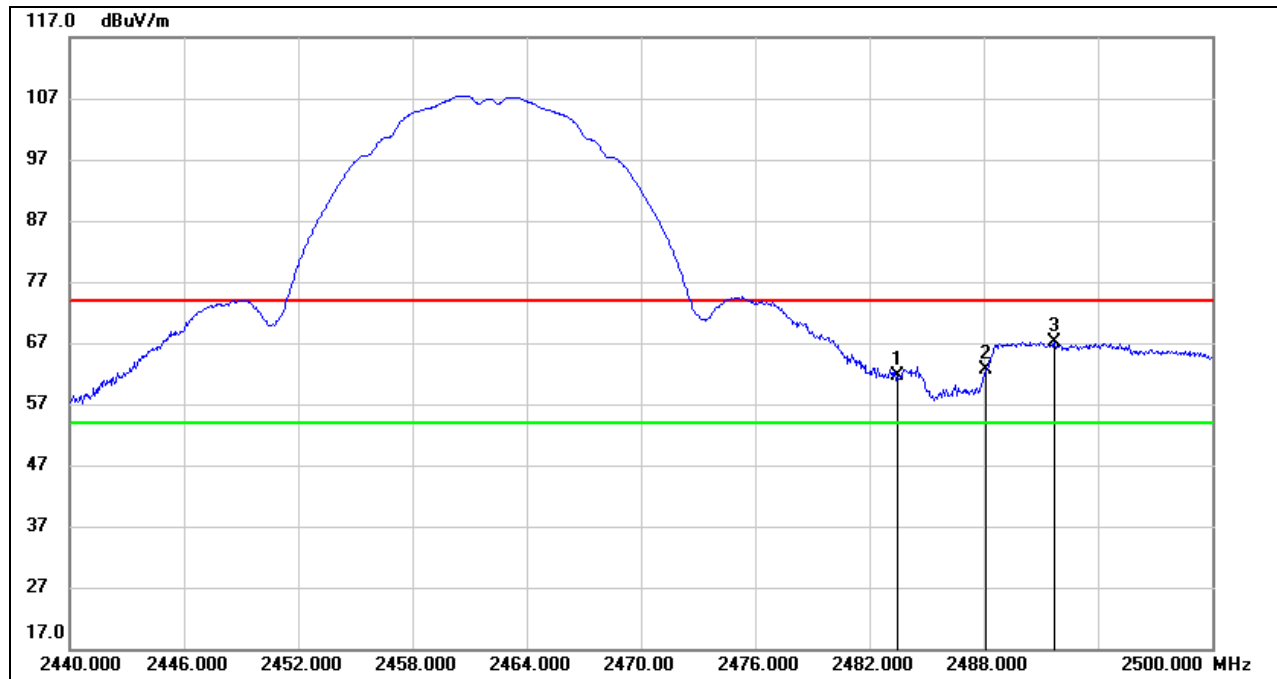
**RESTRICTED BANDEDGE (HIGH CHANNEL, VERTICAL)****PEAK**

No.	Frequency (MHz)	Reading (dBuV)	Correct (dB/m)	Result (dBuV/m)	Limit (dBuV/m)	Margin (dB)	Remark
1	2483.500	28.59	33.10	61.69	74.00	-12.31	peak
2	2488.120	29.48	33.11	62.59	74.00	-11.41	peak
3	2491.720	33.94	33.13	67.07	74.00	-6.93	peak

Note: 1. Measurement = Reading Level + Correct Factor.

2. Peak: Peak detector.

3. Only the worst data was recorded, if it complies with the limit, the other emissions deemed to comply with the limit.

Note: All the polarities (Vertical & Horizontal) and antennas had been tested, only the worst data was recorded in the report.

Note: Both antennas have been tested, only the worst data was recorded in the report.



**AVG**

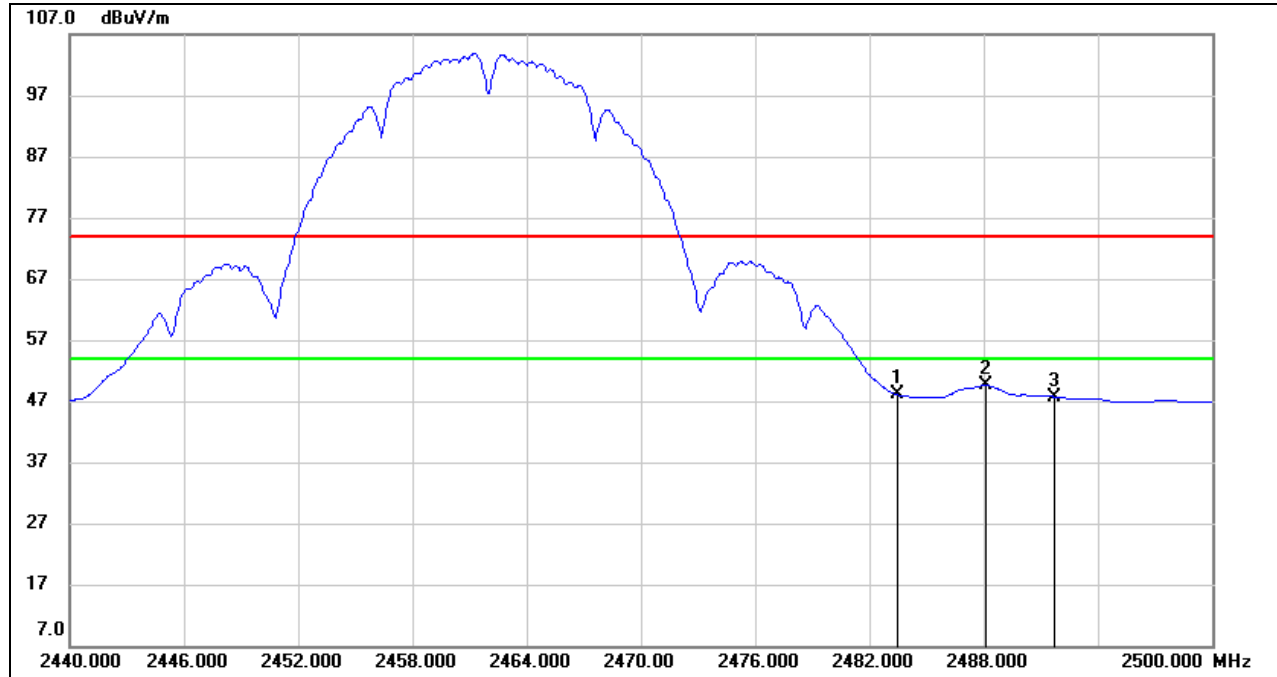

No.	Frequency (MHz)	Reading (dBuV)	Correct (dB/m)	Result (dBuV/m)	Limit (dBuV/m)	Margin (dB)	Remark
1	2483.500	14.94	33.10	48.04	54.00	-5.96	AVG
2	2488.120	16.50	33.11	49.61	54.00	-4.39	AVG
3	2491.720	14.57	33.13	47.70	54.00	-6.30	AVG

Note: 1. Measurement = Reading Level + Correct Factor.  
 2. AVG:  $VBW=1/Ton$ , where: Ton is the transmitting duration.  
 3. For the transmitting duration, please refer to clause 7.1.  
 4. Only the worst data was recorded, if it complies with the limit, the other emissions deemed to comply with the limit.

Note: All the polarities (Vertical & Horizontal) and antennas had been tested, only the worst data was recorded in the report.

Note: Both antennas have been tested, only the worst data was recorded in the report.

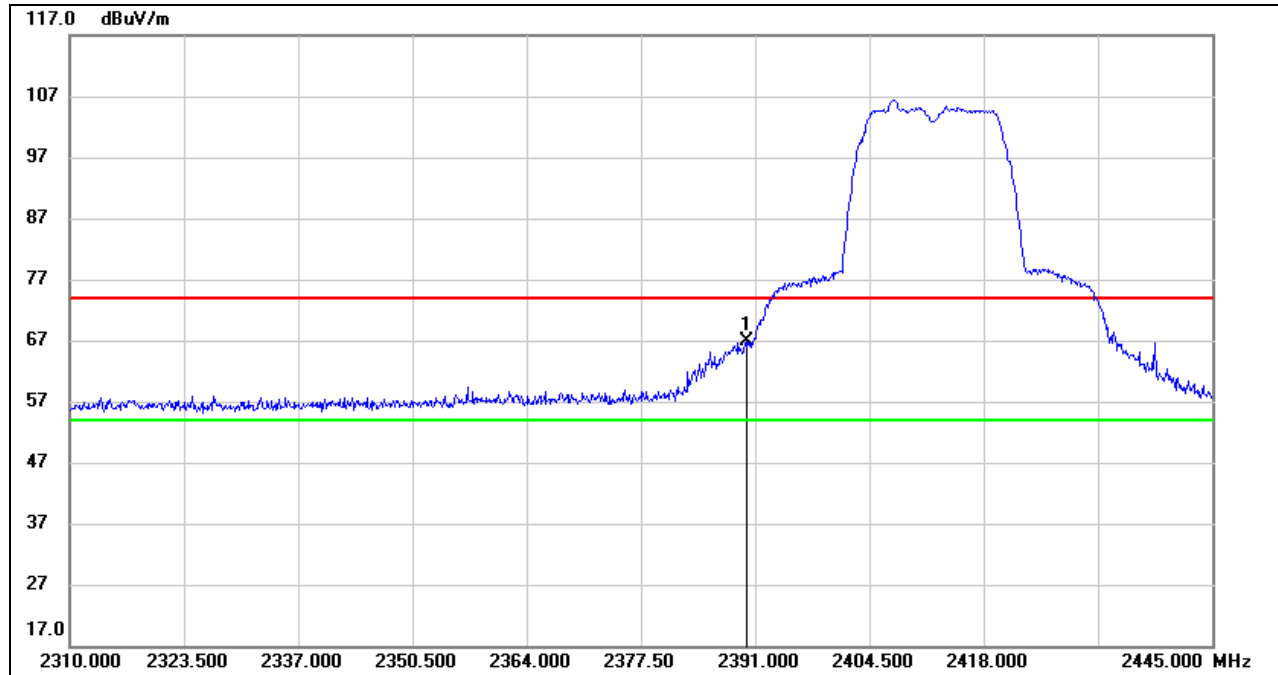
**8.1.2. 802.11g MODE**
**ANTENNA 1 TEST RESULTS (WORST CASE)**
**RESTRICTED BANDEDGE (LOW CHANNEL, VERTICAL)**
**PEAK**

No.	Frequency (MHz)	Reading (dBuV)	Correct (dB/m)	Result (dBuV/m)	Limit (dBuV/m)	Margin (dB)	Remark
1	2390.000	34.27	32.66	66.93	74.00	-7.07	peak

Note: 1. Measurement = Reading Level + Correct Factor.

2. Peak: Peak detector.

3. Only the worst data was recorded, if it complies with the limit, the other emissions deemed to comply with the limit.

**AVG**

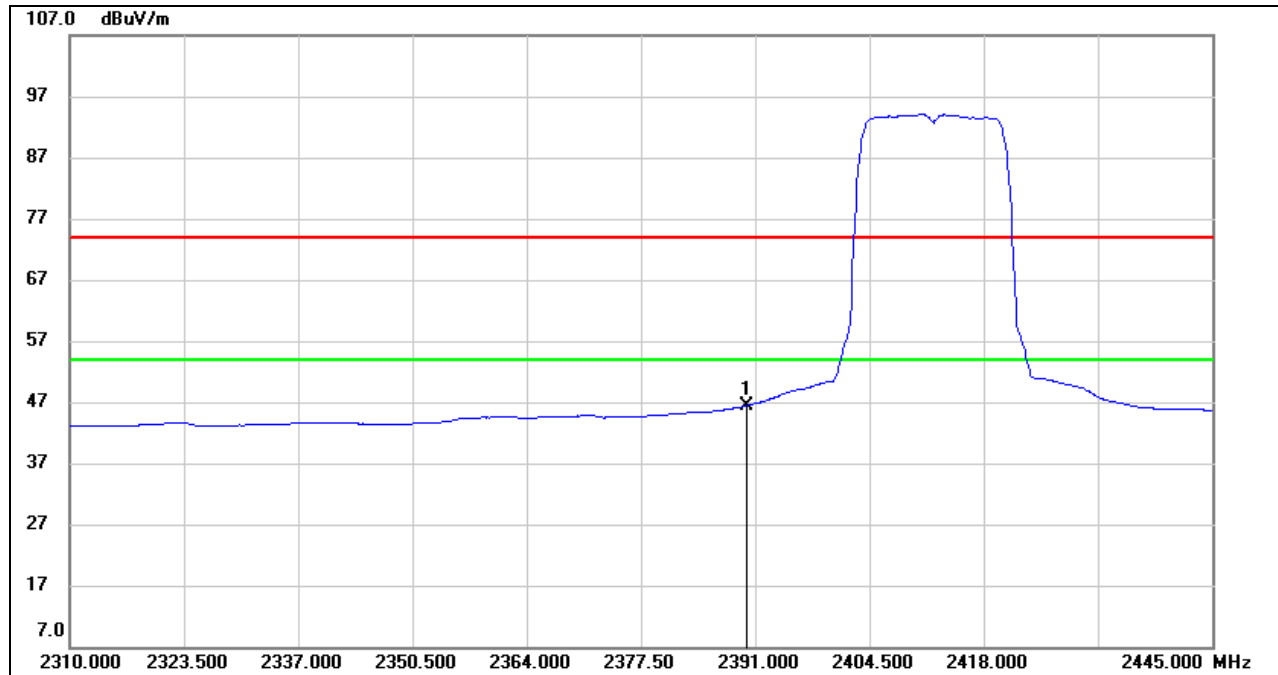

No.	Frequency (MHz)	Reading (dBuV)	Correct (dB/m)	Result (dBuV/m)	Limit (dBuV/m)	Margin (dB)	Remark
1	2390.000	13.81	32.66	46.47	54.00	-7.53	AVG

- Note: 1. Measurement = Reading Level + Correct Factor.  
 2. AVG:  $VBW=1/Ton$ , where: Ton is the transmitting duration.  
 3. For the transmitting duration, please refer to clause 7.1.  
 4. Only the worst data was recorded, if it complies with the limit, the other emissions deemed to comply with the limit.



**RESTRICTED BANDEDGE (HIGH CHANNEL, VERTICAL)**

**PEAK**

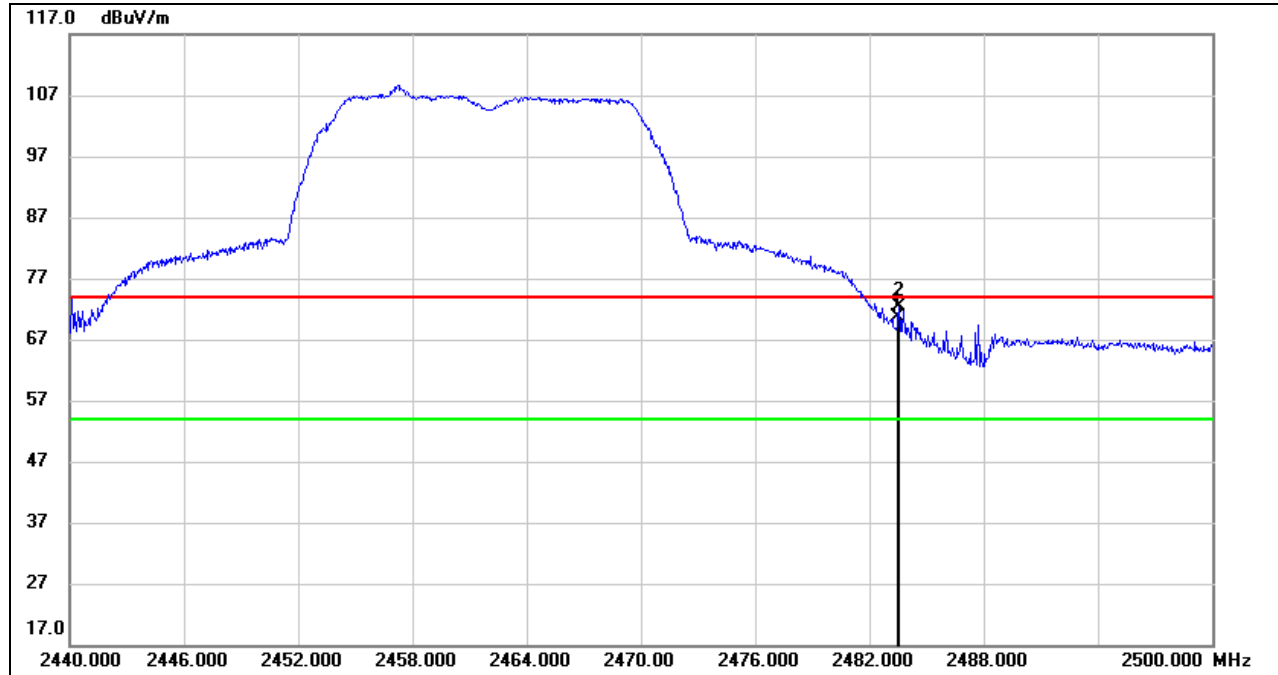

No.	Frequency (MHz)	Reading (dBuV)	Correct (dB/m)	Result (dBuV/m)	Limit (dBuV/m)	Margin (dB)	Remark
1	2483.500	37.60	33.10	70.70	74.00	-3.30	peak
2	2483.560	39.27	33.10	72.37	74.00	-1.63	peak

Note: 1. Measurement = Reading Level + Correct Factor.  
 2. Peak: Peak detector.  
 3. Only the worst data was recorded, if it complies with the limit, the other emissions deemed to comply with the limit.

**AVG**

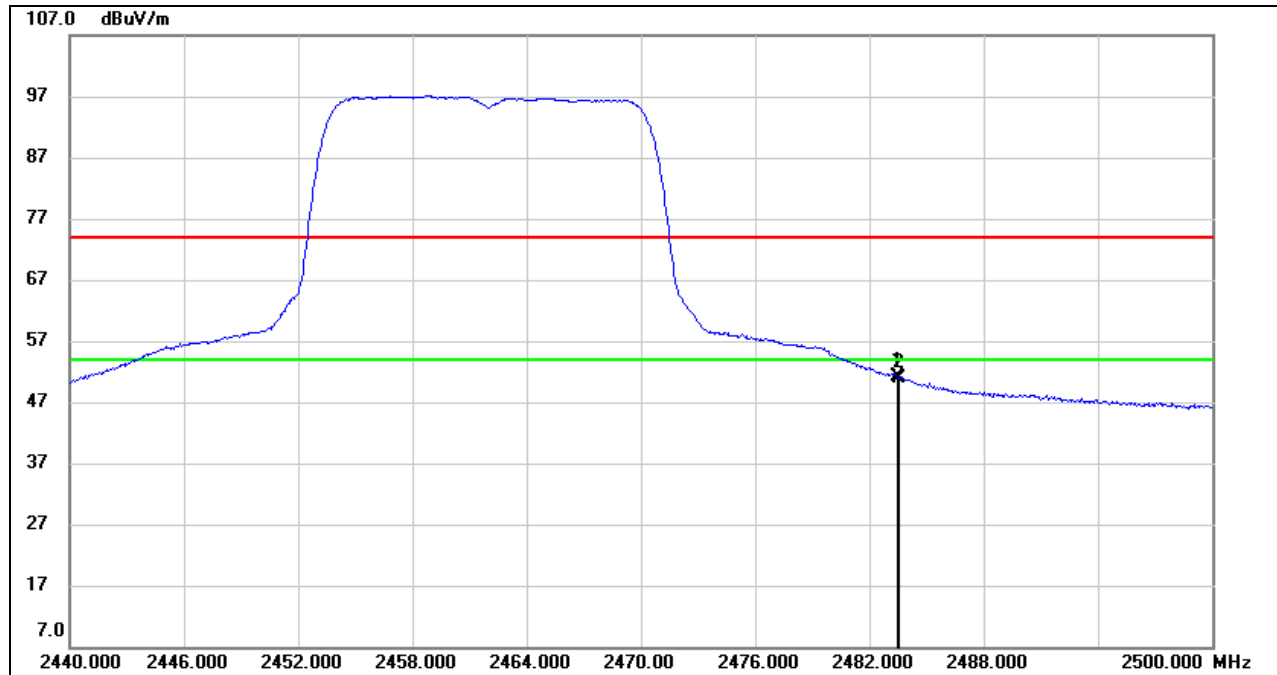

No.	Frequency (MHz)	Reading (dBuV)	Correct (dB/m)	Result (dBuV/m)	Limit (dBuV/m)	Margin (dB)	Remark
1	2483.500	18.01	33.10	51.11	54.00	-2.89	AVG
2	2483.560	17.90	33.10	51.00	54.00	-3.00	AVG

- Note: 1. Measurement = Reading Level + Correct Factor.  
 2. AVG:  $VBW=1/Ton$ , where: Ton is the transmitting duration.  
 3. For the transmitting duration, please refer to clause 7.1.  
 4. Only the worst data was recorded, if it complies with the limit, the other emissions deemed to comply with the limit.

Note: All the polarities (Vertical & Horizontal) and antennas had been tested, only the worst data was recorded in the report.

Note: Both antennas have been tested, only the worst data was recorded in the report.

8.1.3. 802.11n HT20 MODE

RESTRICTED BANDEDGE (LOW CHANNEL, VERTICAL)

PEAK

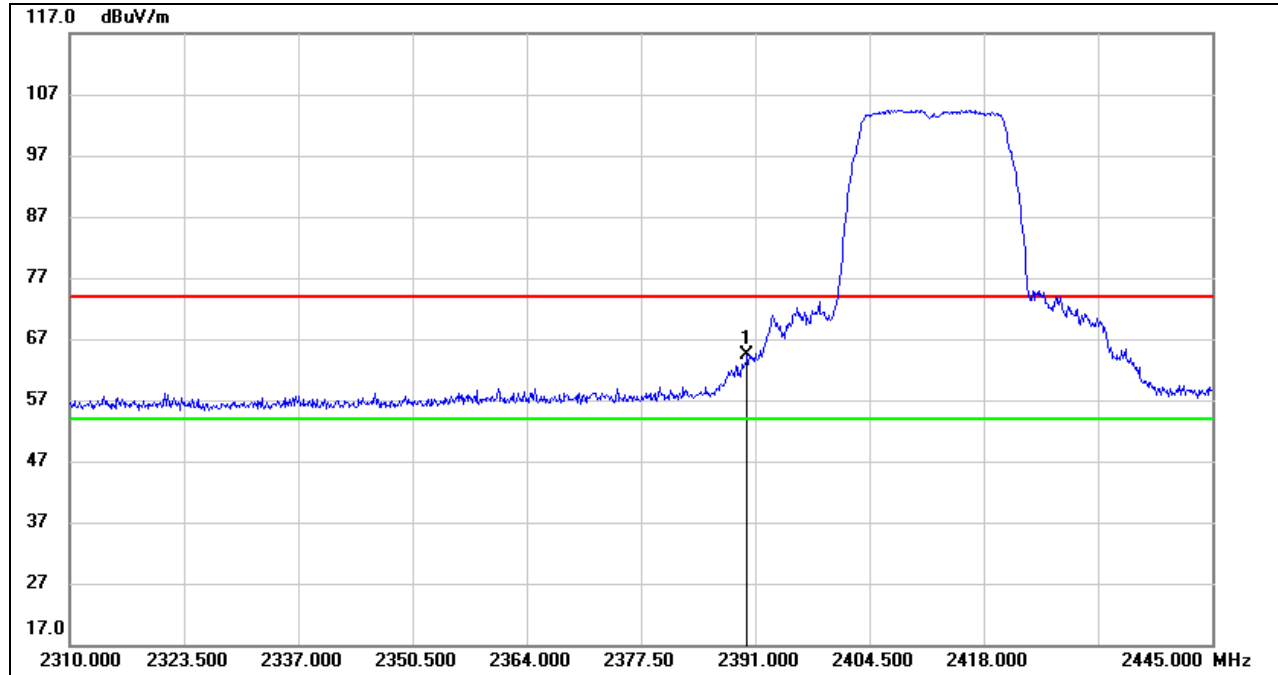

No.	Frequency (MHz)	Reading (dBuV)	Correct (dB/m)	Result (dBuV/m)	Limit (dBuV/m)	Margin (dB)	Remark
1	2390.000	31.84	32.66	64.50	74.00	-9.50	peak

Note: 1. Measurement = Reading Level + Correct Factor.  
 2. Peak: Peak detector.  
 3. Only the worst data was recorded, if it complies with the limit, the other emissions deemed to comply with the limit.



**AVG**

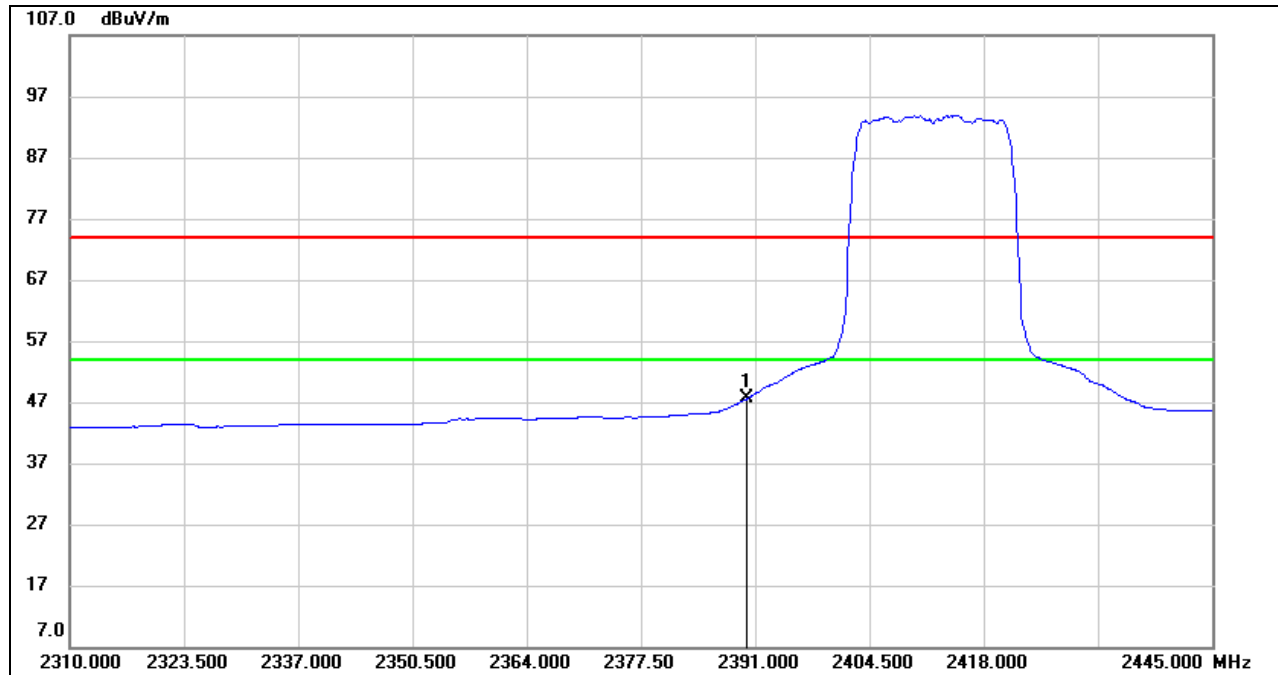

No.	Frequency (MHz)	Reading (dBuV)	Correct (dB/m)	Result (dBuV/m)	Limit (dBuV/m)	Margin (dB)	Remark
1	2390.000	14.95	32.66	47.61	54.00	-6.39	AVG

- Note:
1. Measurement = Reading Level + Correct Factor.
  2. AVG:  $VBW=1/Ton$ , where: Ton is the transmitting duration.
  3. For the transmitting duration, please refer to clause 7.1.
  4. Only the worst data was recorded, if it complies with the limit, the other emissions deemed to comply with the limit.



**RESTRICTED BANDEDGE (HIGH CHANNEL, VERTICAL)**

**PEAK**

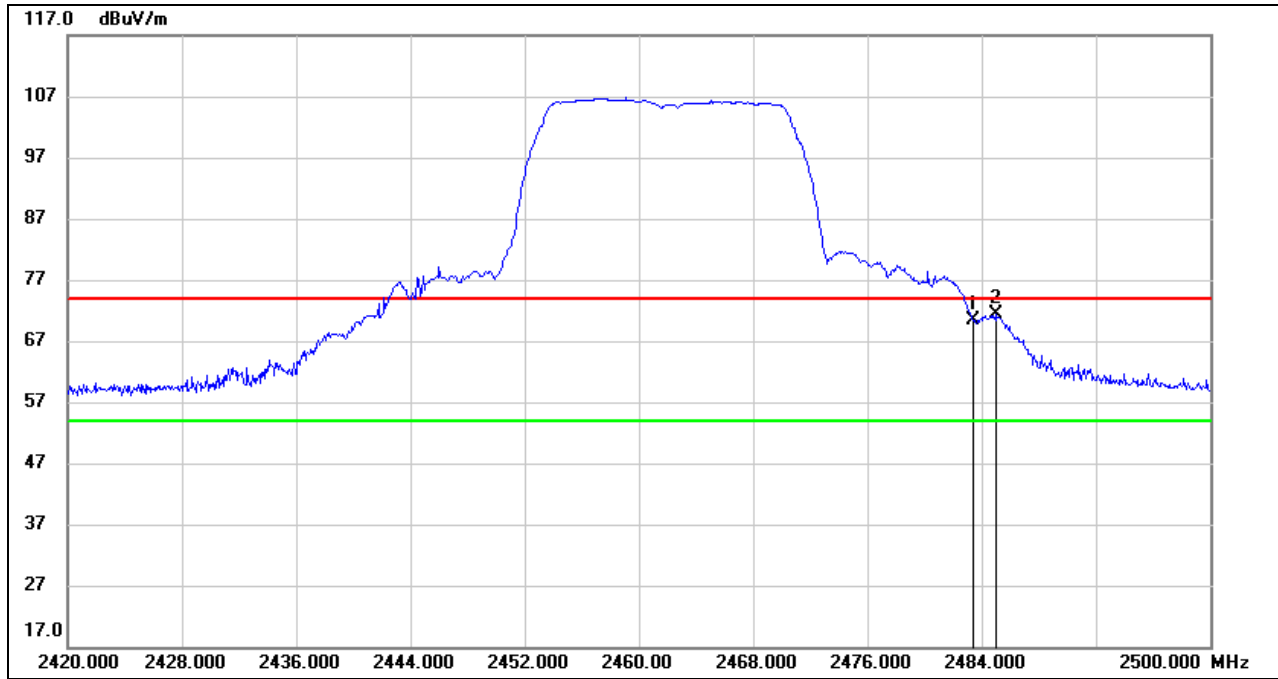

No.	Frequency (MHz)	Reading (dBuV)	Correct (dB/m)	Result (dBuV/m)	Limit (dBuV/m)	Margin (dB)	Remark
1	2483.500	37.24	33.10	70.34	74.00	-3.66	peak
2	2484.960	38.17	33.10	71.27	74.00	-2.73	peak

Note: 1. Measurement = Reading Level + Correct Factor.

2. Peak: Peak detector.

3. Only the worst data was recorded, if it complies with the limit, the other emissions deemed to comply with the limit.





**AVG**

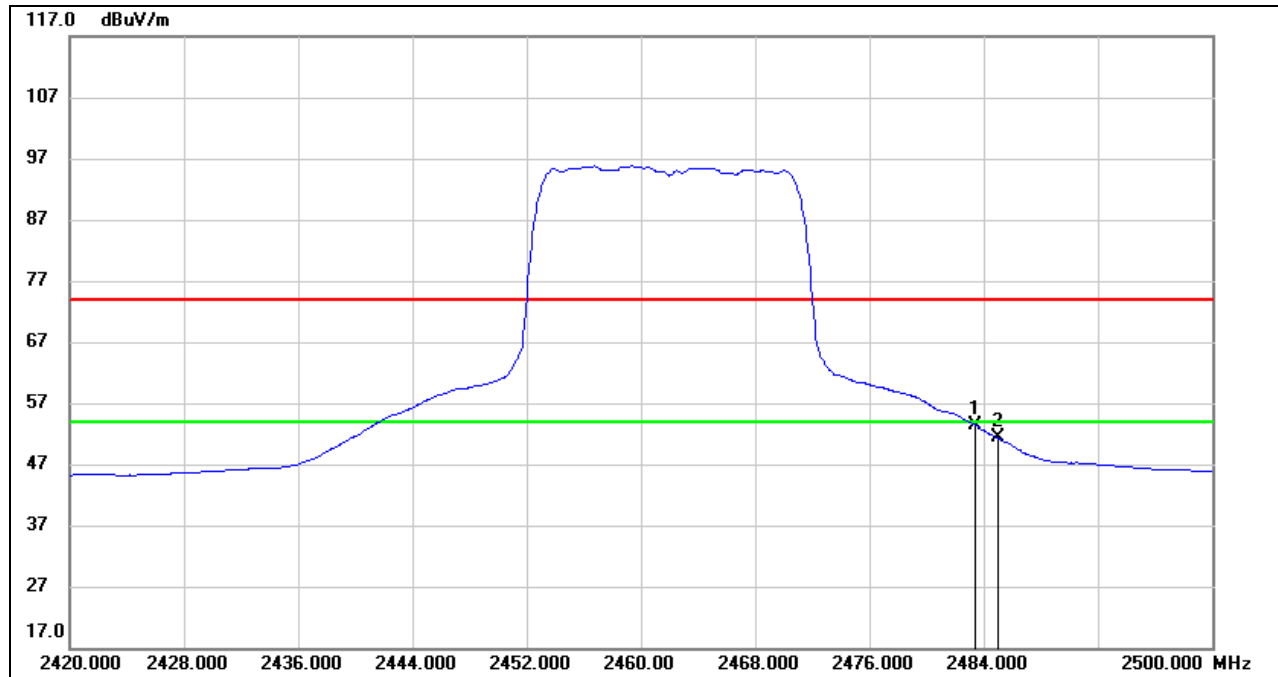

No.	Frequency (MHz)	Reading (dBuV)	Correct (dB/m)	Result (dBuV/m)	Limit (dBuV/m)	Margin (dB)	Remark
1	2483.500	20.20	33.10	53.30	54.00	-0.70	AVG
2	2484.960	18.17	33.10	51.27	54.00	-2.73	AVG

- Note: 1. Measurement = Reading Level + Correct Factor.  
 2. AVG:  $VBW=1/Ton$ , where: Ton is the transmitting duration.  
 3. For the transmitting duration, please refer to clause 7.1.  
 4. Only the worst data was recorded, if it complies with the limit, the other emissions deemed to comply with the limit.

Note: All the polarities (Vertical & Horizontal) had been tested, only the worst data was recorded in the report.

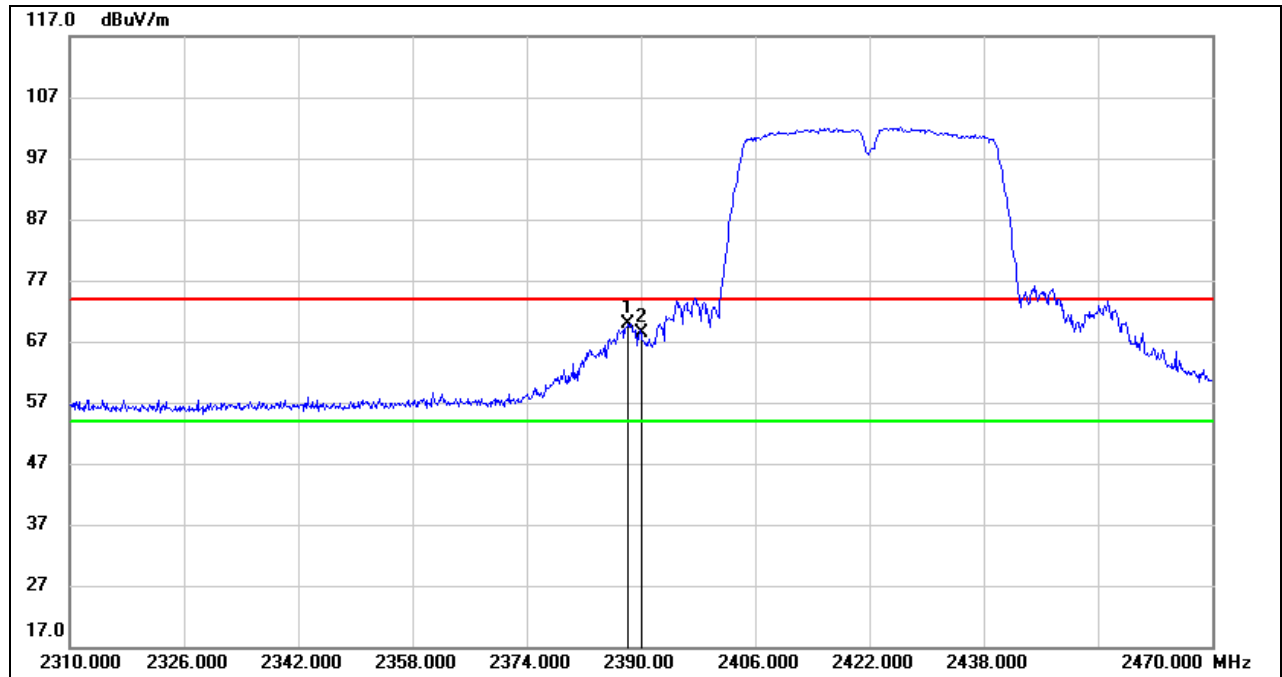
**8.1.4. 802.11n HT40 MODE**
**RESTRICTED BANDEDGE (LOW CHANNEL, VERTICAL)**
**PEAK**

No.	Frequency (MHz)	Reading (dBuV)	Correct (dB/m)	Result (dBuV/m)	Limit (dBuV/m)	Margin (dB)	Remark
1	2388.240	37.30	32.65	69.95	74.00	-4.05	peak
2	2390.000	35.70	32.66	68.36	74.00	-5.64	peak

Note: 1. Measurement = Reading Level + Correct Factor.

2. Peak: Peak detector.

3. Only the worst data was recorded, if it complies with the limit, the other emissions deemed to comply with the limit.



**AVG**

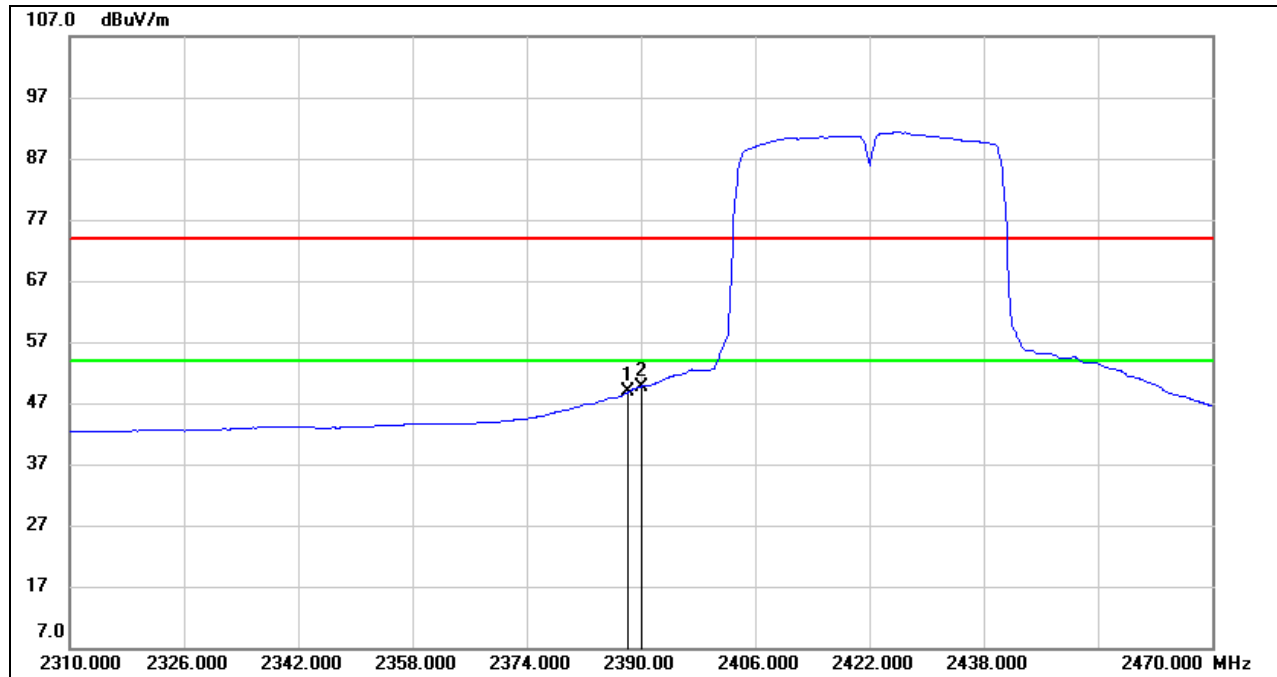

No.	Frequency (MHz)	Reading (dBuV)	Correct (dB/m)	Result (dBuV/m)	Limit (dBuV/m)	Margin (dB)	Remark
1	2388.240	16.16	32.65	48.81	54.00	-5.19	AVG
2	2390.000	17.08	32.66	49.74	54.00	-4.26	AVG

- Note: 1. Measurement = Reading Level + Correct Factor.  
 2. AVG:  $VBW=1/Ton$ , where: Ton is the transmitting duration.  
 3. For the transmitting duration, please refer to clause 7.1.  
 4. Only the worst data was recorded, if it complies with the limit, the other emissions deemed to comply with the limit.

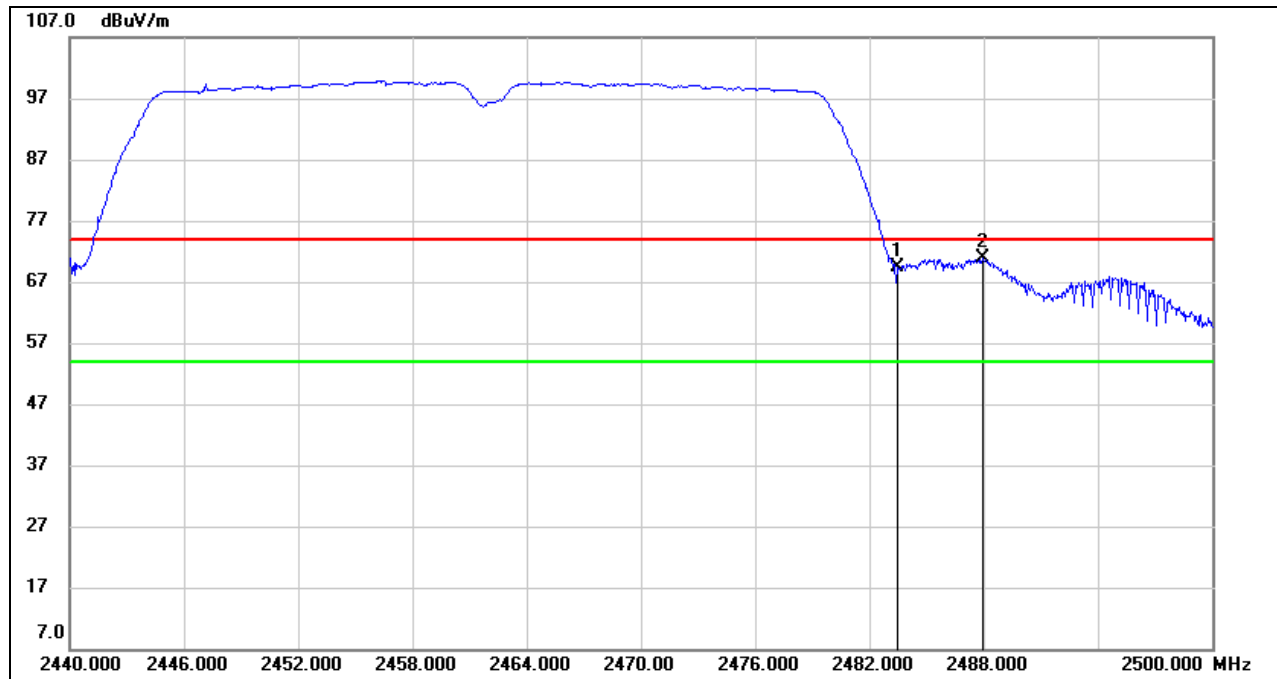
**RESTRICTED BANDEDGE (HIGH CHANNEL, VERTICAL)**
**PEAK**

No.	Frequency (MHz)	Reading (dBuV)	Correct (dB/m)	Result (dBuV/m)	Limit (dBuV/m)	Margin (dB)	Remark
1	2483.500	36.17	33.10	69.27	74.00	-4.73	peak
2	2487.940	37.78	33.11	70.89	74.00	-3.11	peak

Note: 1. Measurement = Reading Level + Correct Factor.

2. Peak: Peak detector.

3. Only the worst data was recorded, if it complies with the limit, the other emissions deemed to comply with the limit.

**AVG**

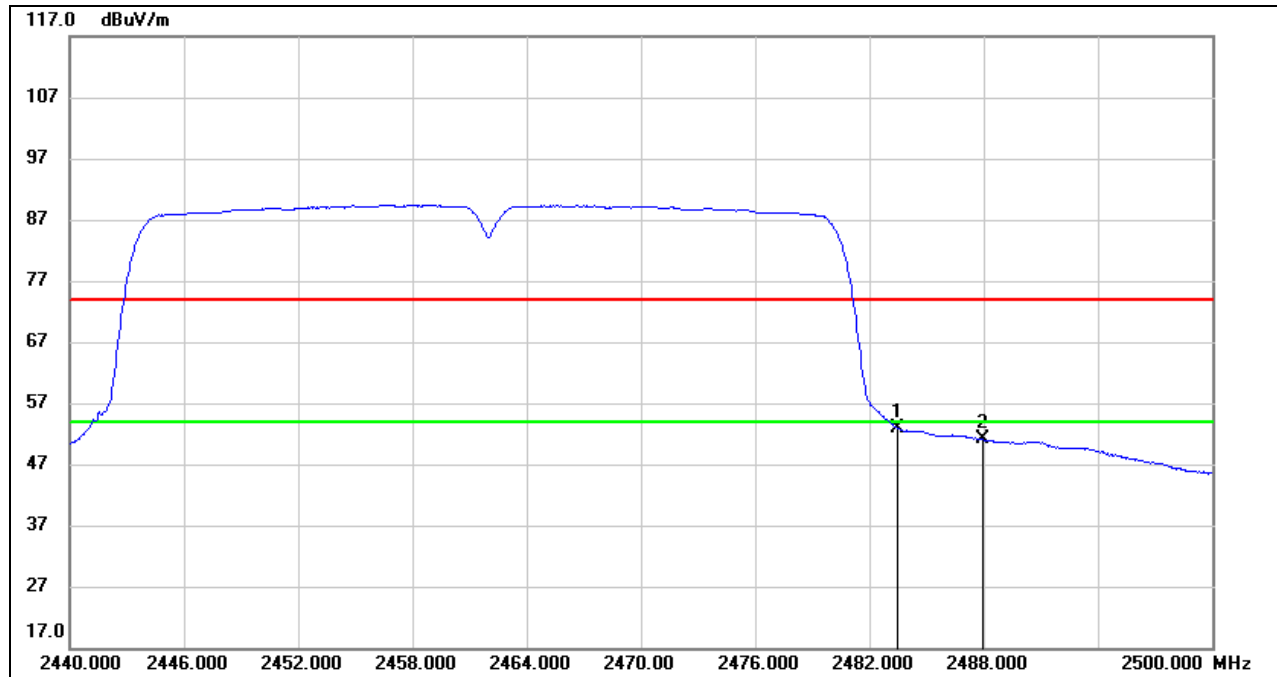

No.	Frequency (MHz)	Reading (dBuV)	Correct (dB/m)	Result (dBuV/m)	Limit (dBuV/m)	Margin (dB)	Remark
1	2483.500	19.75	33.10	52.85	54.00	-1.15	AVG
2	2487.940	17.90	33.11	51.01	54.00	-2.99	AVG

- Note: 1. Measurement = Reading Level + Correct Factor.  
 2. AVG:  $VBW=1/Ton$ , where: Ton is the transmitting duration.  
 3. For the transmitting duration, please refer to clause 7.1.  
 4. Only the worst data was recorded, if it complies with the limit, the other emissions deemed to comply with the limit.

Note: All the polarities (Vertical & Horizontal) had been tested, only the worst data was recorded in the report.

## 8.2. SPURIOUS EMISSIONS (1 GHz ~ 3 GHz)

### 8.2.1. 802.11 b MODE

#### HARMONICS AND SPURIOUS EMISSIONS (LOW CHANNEL, HORIZONTAL)

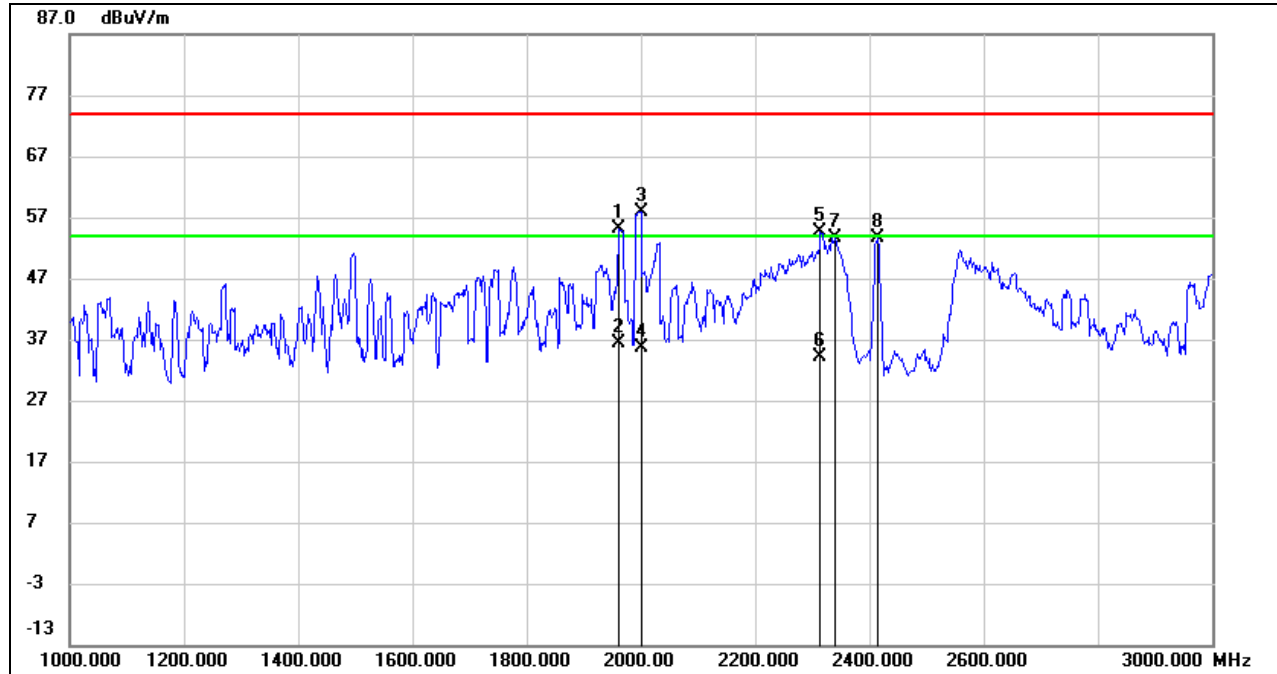

No.	Frequency (MHz)	Reading (dBuV)	Correct (dB/m)	Result (dBuV/m)	Limit (dBuV/m)	Margin (dB)	Remark
1	1962.000	66.13	-10.89	55.24	74.00	-18.76	peak
2	1962.000	47.38	-10.89	36.49	54.00	-17.51	AVG
3	2000.000	68.87	-10.96	57.91	74.00	-16.09	peak
4	2000.000	46.64	-10.96	35.68	54.00	-18.32	AVG
5	2314.000	63.93	-9.27	54.66	74.00	-19.34	peak
6	2314.000	43.43	-9.27	34.16	54.00	-19.84	AVG
7	2340.000	62.78	-9.18	53.60	74.00	-20.40	peak
8	2414.000	62.46	-8.91	53.55	74.00	-20.45	peak

- Note:
1. Peak Result = Reading Level + Correct Factor.
  2. If Peak Result complies with AV limit, AV Result is deemed to comply with AV limit.
  3. Peak: Peak detector.
  4. Filter losses were only considered in then spurious frequency bands and the authorized band was not corrected for Band reject filter losses.
  5. Proper operation of the transmitter prior to adding the filter to the measurement chain.

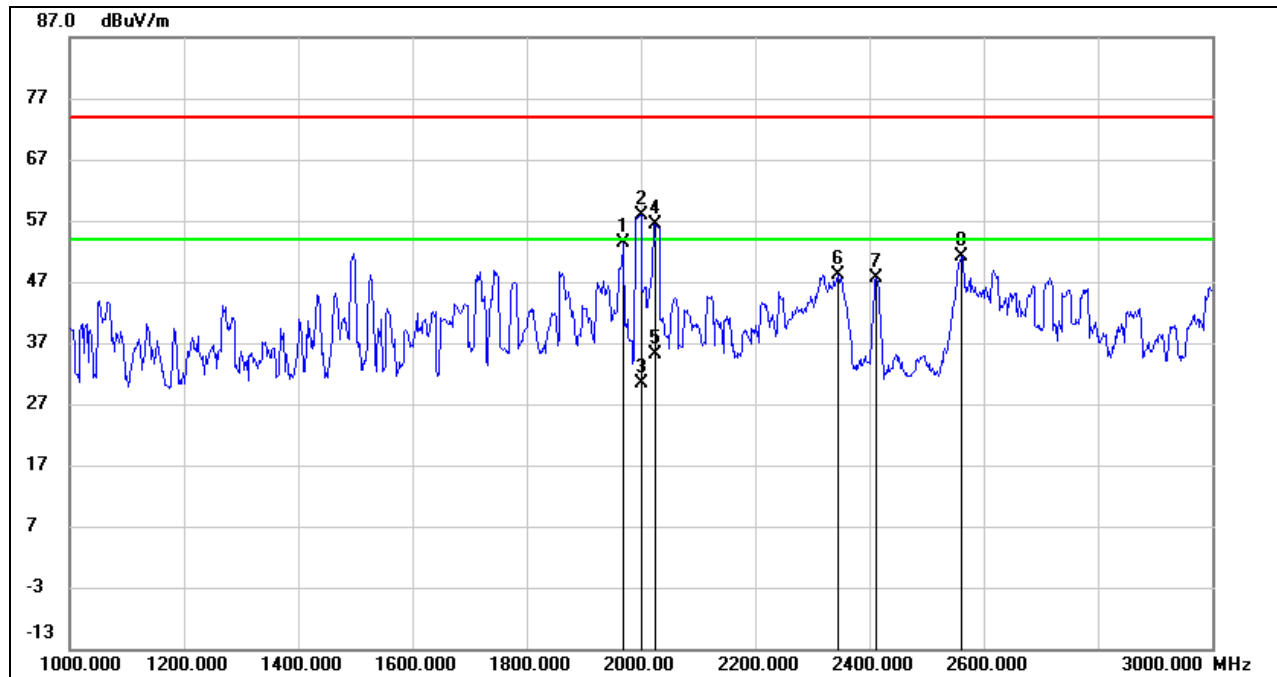
**HARMONICS AND SPURIOUS EMISSIONS (LOW CHANNEL, VERTICAL)**

No.	Frequency (MHz)	Reading (dBuV)	Correct (dB/m)	Result (dBuV/m)	Limit (dBuV/m)	Margin (dB)	Remark
1	1968.000	64.16	-10.90	53.26	74.00	-20.74	peak
2	2000.000	68.79	-10.96	57.83	74.00	-16.17	peak
3	2000.000	41.22	-10.96	30.26	54.00	-23.74	AVG
4	2024.000	67.26	-10.81	56.45	74.00	-17.55	peak
5	2024.000	46.04	-10.81	35.23	54.00	-18.77	AVG
6	2346.000	57.23	-9.16	48.07	74.00	-25.93	peak
7	2412.000	56.51	-8.92	47.59	74.00	-26.41	peak
8	2562.000	59.69	-8.63	51.06	74.00	-22.94	peak

- Note:
1. Peak Result = Reading Level + Correct Factor.
  2. If Peak Result complies with AV limit, AV Result is deemed to comply with AV limit.
  3. Peak: Peak detector.
  4. Filter losses were only considered in then spurious frequency bands and the authorized band was not corrected for Band reject filter losses.
  5. Proper operation of the transmitter prior to adding the filter to the measurement chain.

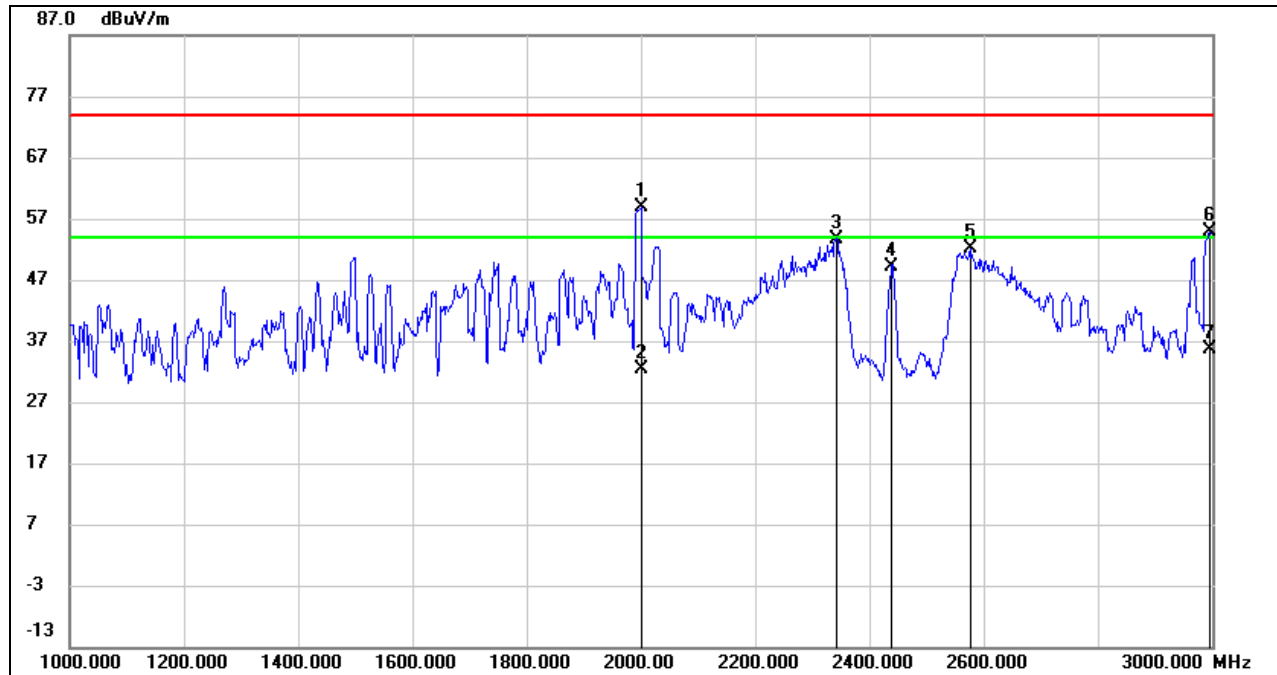
**HARMONICS AND SPURIOUS EMISSIONS (MID CHANNEL, HORIZONTAL)**

No.	Frequency (MHz)	Reading (dBuV)	Correct (dB/m)	Result (dBuV/m)	Limit (dBuV/m)	Margin (dB)	Remark
1	2000.000	69.81	-10.96	58.85	74.00	-15.15	peak
2	2000.000	43.22	-10.96	32.26	54.00	-21.74	AVG
3	2342.000	62.92	-9.17	53.75	74.00	-20.25	peak
4	2437.000	57.95	-8.86	49.09	74.00	-24.91	peak
5	2576.000	60.81	-8.61	52.20	74.00	-21.80	peak
6	2996.000	61.99	-7.13	54.86	74.00	-19.14	peak
7	2996.000	42.67	-7.13	35.54	54.00	-18.46	AVG

- Note: 1. Peak Result = Reading Level + Correct Factor.  
 2. If Peak Result complies with AV limit, AV Result is deemed to comply with AV limit.  
 3. Peak: Peak detector.  
 4. Filter losses were only considered in then spurious frequency bands and the authorized band was not corrected for Band reject filter losses.  
 5. Proper operation of the transmitter prior to adding the filter to the measurement chain.

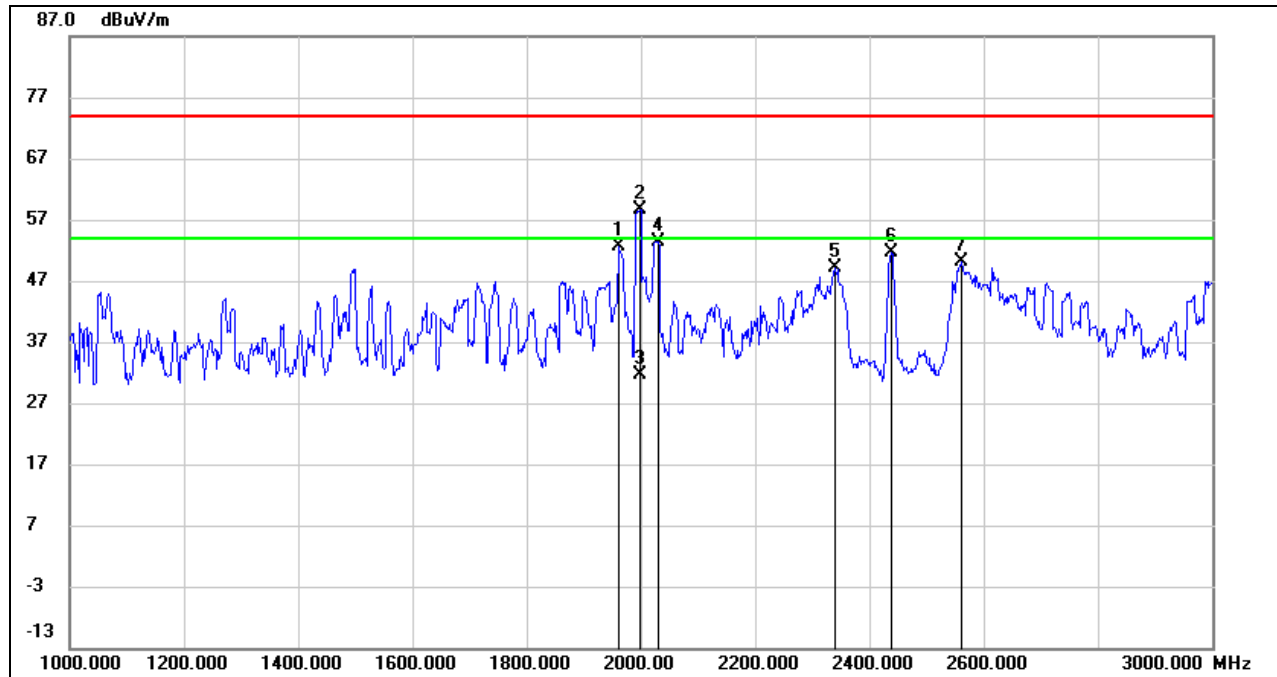

**HARMONICS AND SPURIOUS EMISSIONS (MID CHANNEL, VERTICAL)**

No.	Frequency (MHz)	Reading (dBuV)	Correct (dB/m)	Result (dBuV/m)	Limit (dBuV/m)	Margin (dB)	Remark
1	1960.000	63.45	-10.89	52.56	74.00	-21.44	peak
2	1998.000	69.55	-10.95	58.60	74.00	-15.40	peak
3	1998.000	42.63	-10.95	31.68	54.00	-22.32	AVG
4	2030.000	64.18	-10.77	53.41	74.00	-20.59	peak
5	2340.000	58.24	-9.18	49.06	74.00	-24.94	peak
6	2438.000	60.44	-8.86	51.58	74.00	-22.42	peak
7	2562.000	58.65	-8.63	50.02	74.00	-23.98	peak

- Note:
1. Peak Result = Reading Level + Correct Factor.
  2. If Peak Result complies with AV limit, AV Result is deemed to comply with AV limit.
  3. Peak: Peak detector.
  4. Filter losses were only considered in then spurious frequency bands and the authorized band was not corrected for Band reject filter losses.
  5. Proper operation of the transmitter prior to adding the filter to the measurement chain.

**HARMONICS AND SPURIOUS EMISSIONS (HIGH CHANNEL, HORIZONTAL)**

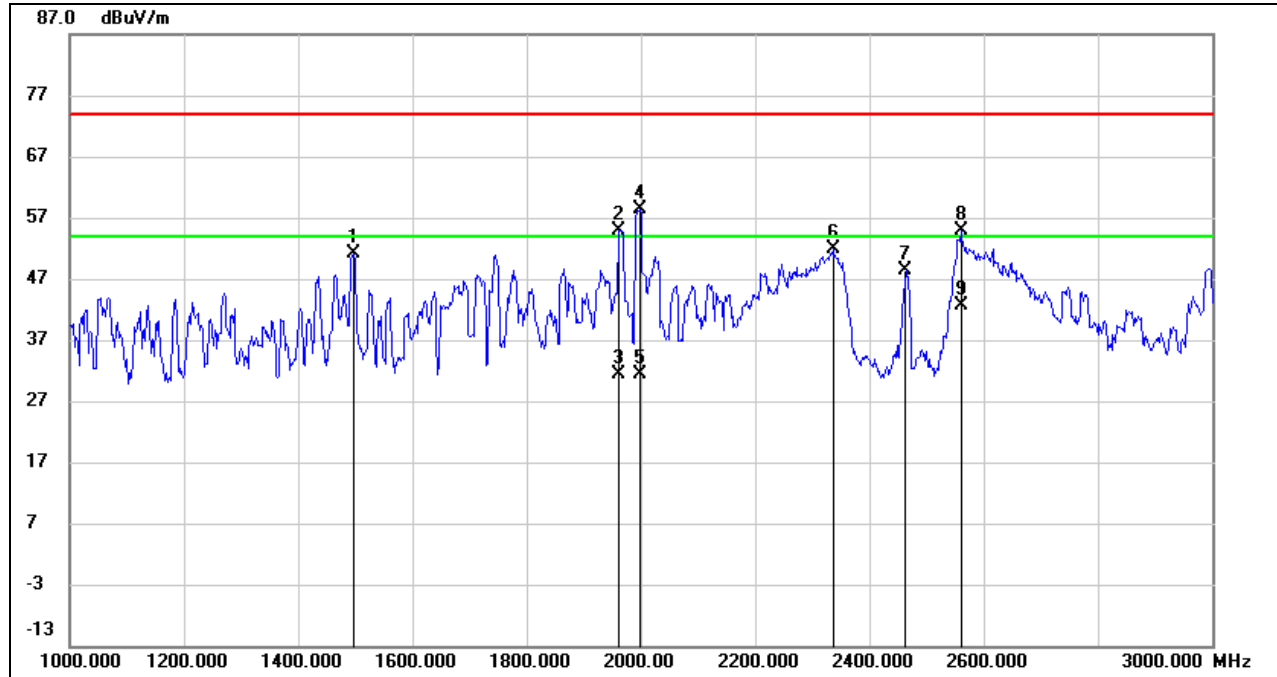

No.	Frequency (MHz)	Reading (dBuV)	Correct (dB/m)	Result (dBuV/m)	Limit (dBuV/m)	Margin (dB)	Remark
1	1496.000	63.51	-12.43	51.08	74.00	-22.92	peak
2	1960.000	65.89	-10.89	55.00	74.00	-19.00	peak
3	1960.000	42.25	-10.89	31.36	54.00	-22.64	AVG
4	1998.000	69.25	-10.95	58.30	74.00	-15.70	peak
5	1998.000	42.30	-10.95	31.35	54.00	-22.65	AVG
6	2336.000	61.01	-9.19	51.82	74.00	-22.18	peak
7	2462.000	57.11	-8.81	48.30	74.00	-25.70	peak
8	2560.000	63.52	-8.63	54.89	74.00	-19.11	peak
9	2560.000	51.28	-8.63	42.65	54.00	-11.35	AVG

- Note:
1. Peak Result = Reading Level + Correct Factor.
  2. If Peak Result complies with AV limit, AV Result is deemed to comply with AV limit.
  3. Peak: Peak detector.
  4. Filter losses were only considered in then spurious frequency bands and the authorized band was not corrected for Band reject filter losses.
  5. Proper operation of the transmitter prior to adding the filter to the measurement chain.

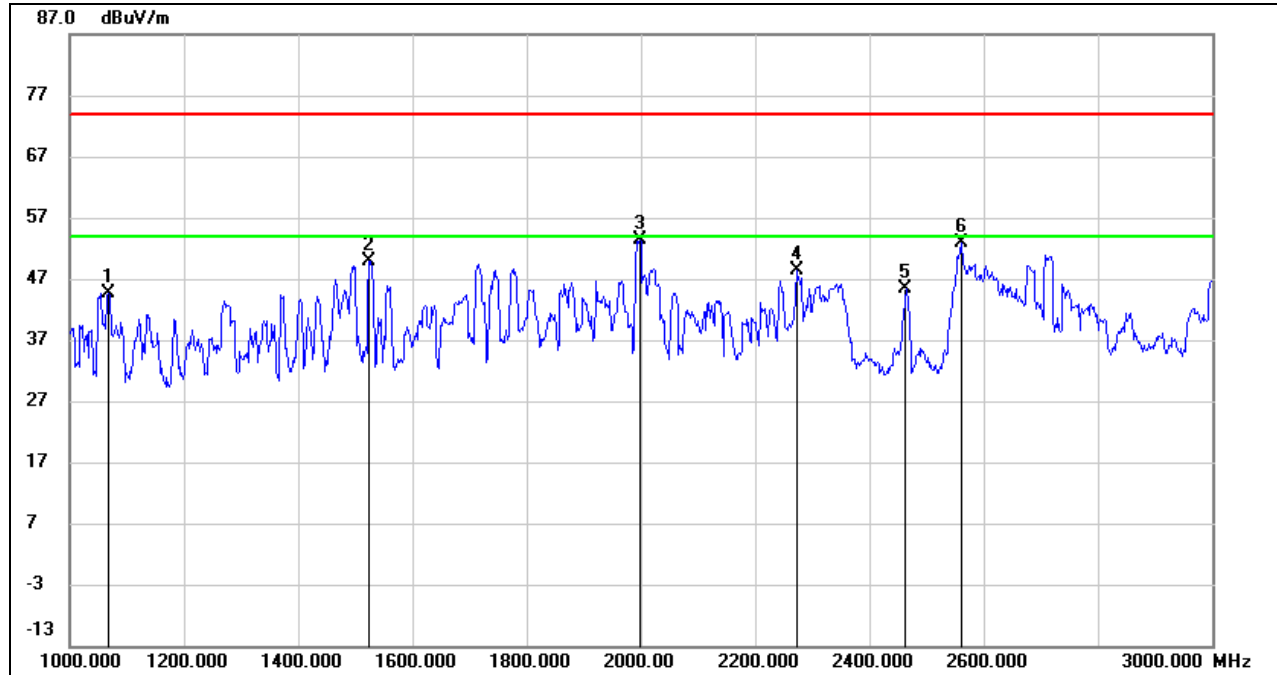
**HARMONICS AND SPURIOUS EMISSIONS (HIGH CHANNEL, VERTICAL)**

No.	Frequency (MHz)	Reading (dBuV)	Correct (dB/m)	Result (dBuV/m)	Limit (dBuV/m)	Margin (dB)	Remark
1	1068.000	59.27	-14.60	44.67	74.00	-29.33	peak
2	1524.000	62.16	-12.27	49.89	74.00	-24.11	peak
3	1998.000	64.24	-10.95	53.29	74.00	-20.71	peak
4	2272.000	57.69	-9.43	48.26	74.00	-25.74	peak
5	2462.000	54.19	-8.81	45.38	74.00	-28.62	peak
6	2562.000	61.57	-8.63	52.94	74.00	-21.06	peak

- Note: 1. Peak Result = Reading Level + Correct Factor.  
 2. If Peak Result complies with AV limit, AV Result is deemed to comply with AV limit.  
 3. Peak: Peak detector.  
 4. Filter losses were only considered in then spurious frequency bands and the authorized band was not corrected for Band reject filter losses.  
 5. Proper operation of the transmitter prior to adding the filter to the measurement chain.

Note: All modes and channels have been tested, only the worst data was recorded in the report.

### 8.3. SPURIOUS EMISSIONS (3 GHz ~ 18 GHz)

#### 8.3.1. 802.11b MODE

##### ANTENNA 1 TEST RESULTS (WORST CASE)

##### HARMONICS AND SPURIOUS EMISSIONS (LOW CHANNEL, HORIZONTAL)

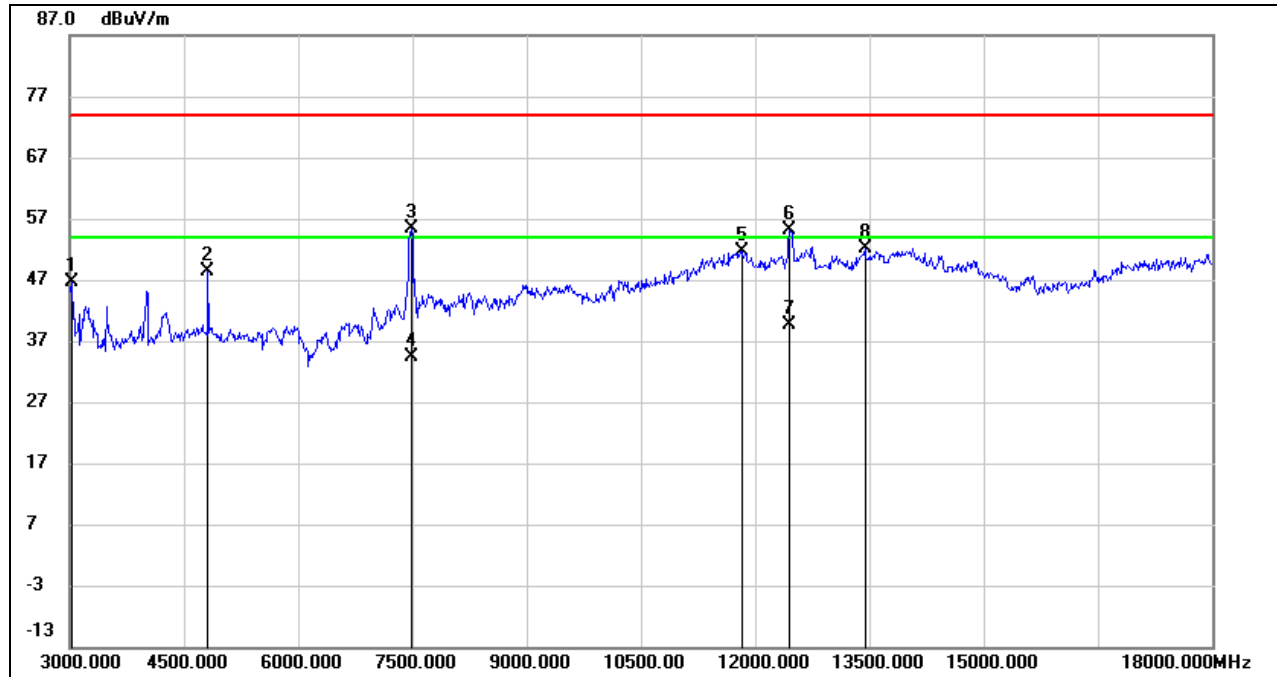

No.	Frequency (MHz)	Reading (dBuV)	Correct (dB/m)	Result (dBuV/m)	Limit (dBuV/m)	Margin (dB)	Remark
1	3030.000	53.61	-7.04	46.57	74.00	-27.43	peak
2	4822.500	49.48	-1.14	48.34	74.00	-25.66	peak
3	7492.500	49.77	5.66	55.43	74.00	-18.57	peak
4	7492.500	28.60	5.66	34.26	54.00	-19.74	AVG
5	11827.500	34.39	17.20	51.59	74.00	-22.41	peak
6	12457.500	38.27	16.92	55.19	74.00	-18.81	peak
7	12457.500	22.61	16.92	39.53	54.00	-14.47	AVG
8	13440.000	32.85	19.35	52.20	74.00	-21.80	peak

Note: 1. Peak Result = Reading Level + Correct Factor.

2. If Peak Result complies with AV limit, AV Result is deemed to comply with AV limit.

3. Peak: Peak detector.

4. Filter losses were only considered in the spurious frequency bands and the authorized band was not corrected for High Pass Filter losses.

5. Proper operation of the transmitter prior to adding the filter to the measurement chain.

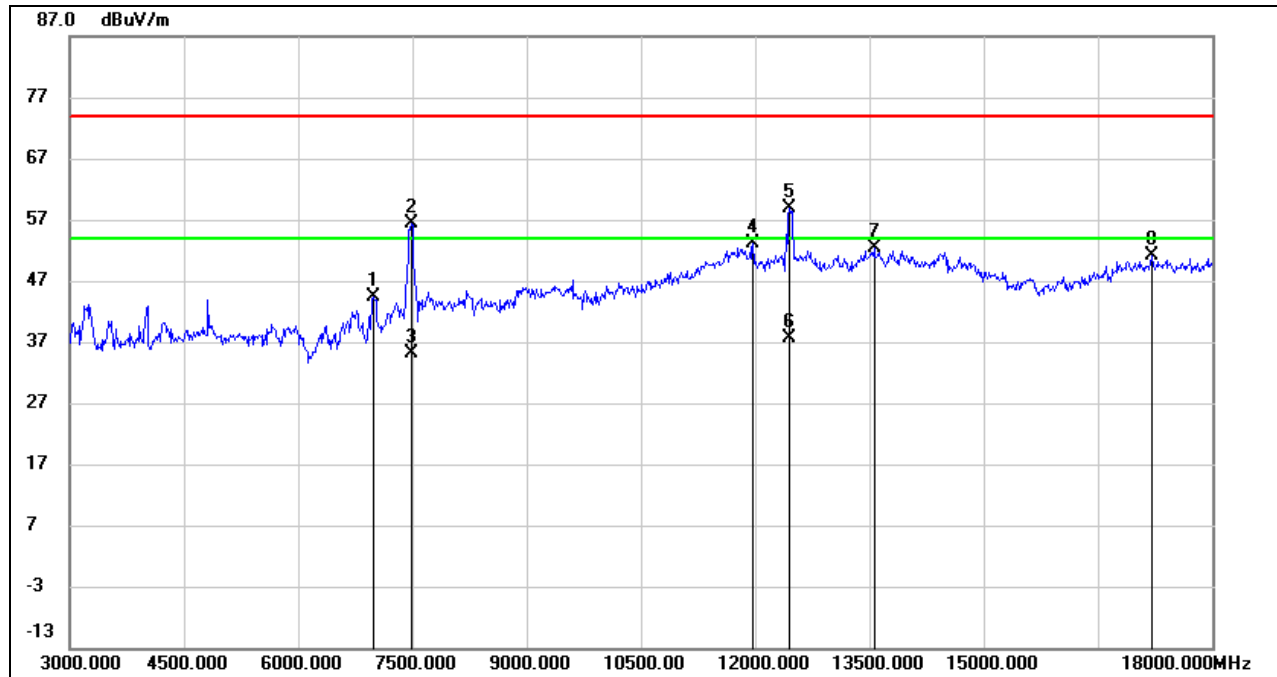
**HARMONICS AND SPURIOUS EMISSIONS (LOW CHANNEL, VERTICAL)**

No.	Frequency (MHz)	Reading (dBuV)	Correct (dB/m)	Result (dBuV/m)	Limit (dBuV/m)	Margin (dB)	Remark
1	6997.500	39.97	4.32	44.29	74.00	-29.71	peak
2	7485.000	50.83	5.67	56.50	74.00	-17.50	peak
3	7485.000	29.49	5.67	35.16	54.00	-18.84	AVG
4	11977.500	35.90	17.11	53.01	74.00	-20.99	peak
5	12450.000	41.88	16.94	58.82	74.00	-15.18	peak
6	12450.000	20.67	16.94	37.61	54.00	-16.39	AVG
7	13560.000	32.64	19.67	52.31	74.00	-21.69	peak
8	17212.500	30.97	20.16	51.13	74.00	-22.87	peak

Note: 1. Peak Result = Reading Level + Correct Factor.

2. If Peak Result complies with AV limit, AV Result is deemed to comply with AV limit.

3. Peak: Peak detector.

4. Filter losses were only considered in the spurious frequency bands and the authorized band was not corrected for High Pass Filter losses.

5. Proper operation of the transmitter prior to adding the filter to the measurement chain.

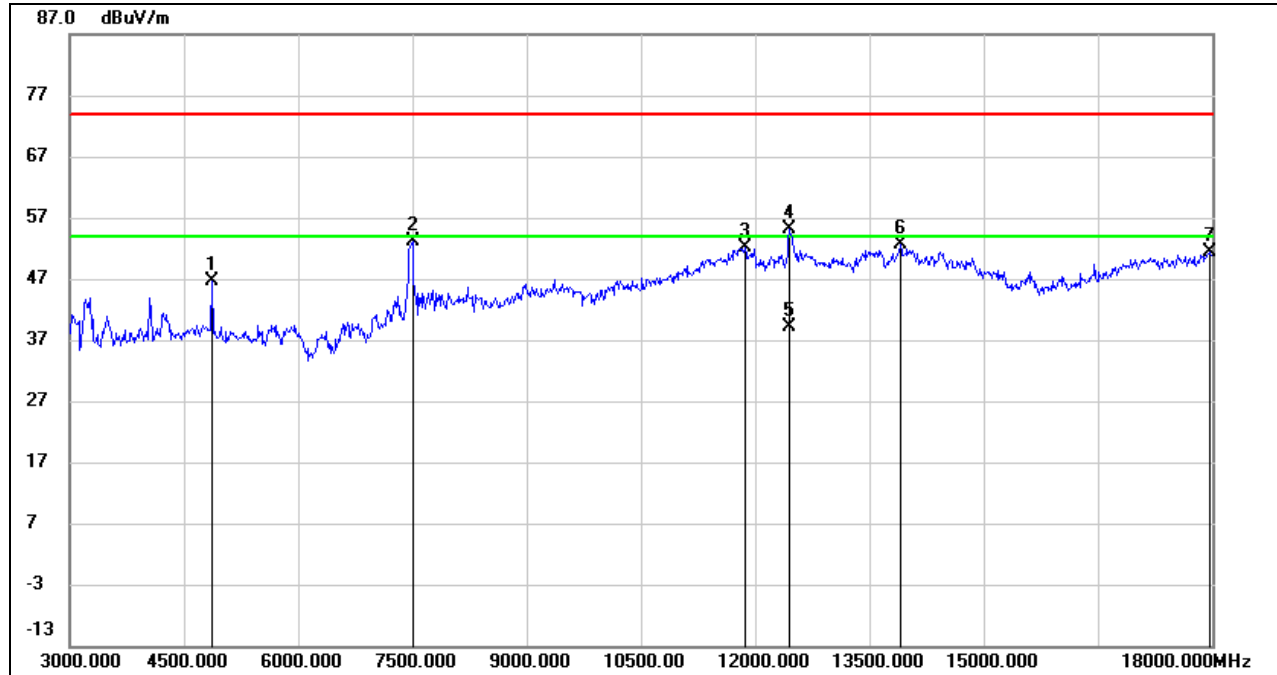
**HARMONICS AND SPURIOUS EMISSIONS (MID CHANNEL, HORIZONTAL)**

No.	Frequency (MHz)	Reading (dBuV)	Correct (dB/m)	Result (dBuV/m)	Limit (dBuV/m)	Margin (dB)	Remark
1	4867.500	47.87	-1.14	46.73	74.00	-27.27	peak
2	7500.000	47.46	5.65	53.11	74.00	-20.89	peak
3	11872.500	34.89	17.18	52.07	74.00	-21.93	peak
4	12457.500	38.12	16.92	55.04	74.00	-18.96	peak
5	12457.500	22.20	16.92	39.12	54.00	-14.88	AVG
6	13912.500	31.94	20.58	52.52	74.00	-21.48	peak
7	17977.500	27.86	23.63	51.49	74.00	-22.51	peak

Note: 1. Peak Result = Reading Level + Correct Factor.

2. If Peak Result complies with AV limit, AV Result is deemed to comply with AV limit.

3. Peak: Peak detector.

4. Filter losses were only considered in the spurious frequency bands and the authorized band was not corrected for High Pass Filter losses.

5. Proper operation of the transmitter prior to adding the filter to the measurement chain.

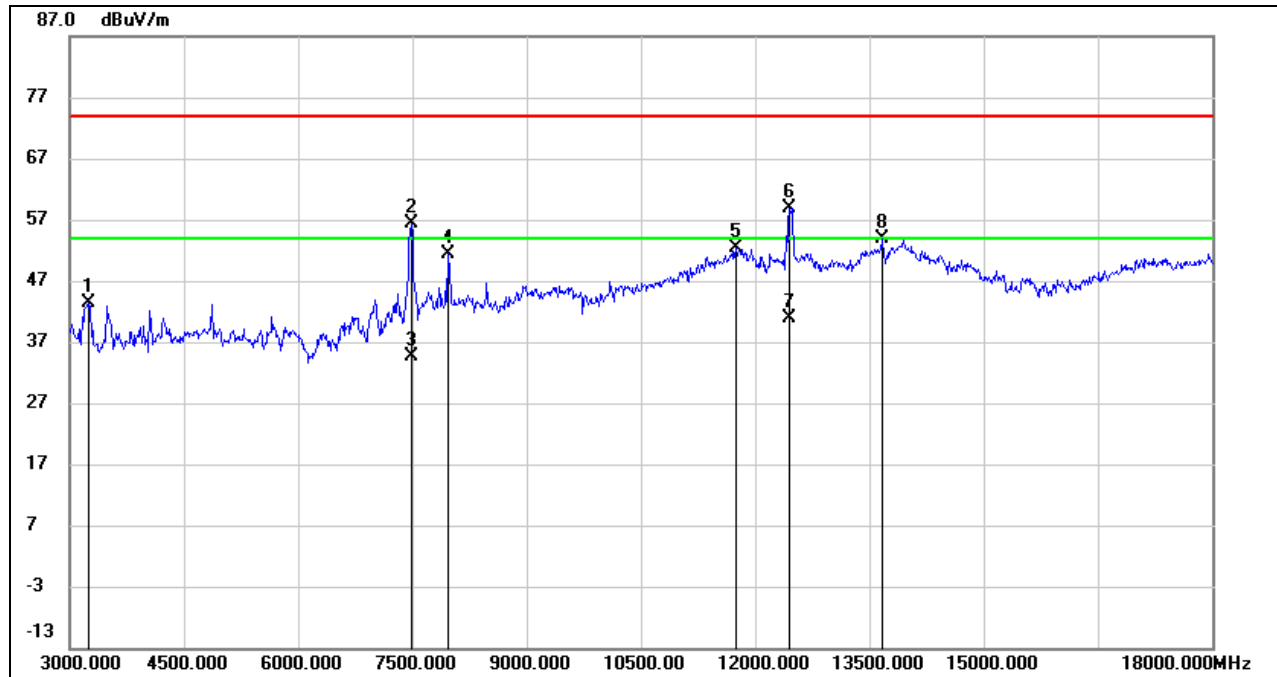
**HARMONICS AND SPURIOUS EMISSIONS (MID CHANNEL, VERTICAL)**

No.	Frequency (MHz)	Reading (dBuV)	Correct (dB/m)	Result (dBuV/m)	Limit (dBuV/m)	Margin (dB)	Remark
1	3240.000	49.82	-6.55	43.27	74.00	-30.73	peak
2	7492.500	50.78	5.66	56.44	74.00	-17.56	peak
3	7492.500	29.02	5.66	34.68	54.00	-19.32	AVG
4	7965.000	45.79	5.48	51.27	74.00	-22.73	peak
5	11745.000	35.53	16.88	52.41	74.00	-21.59	peak
6	12457.500	41.89	16.92	58.81	74.00	-15.19	peak
7	12457.500	23.93	16.92	40.85	54.00	-13.15	AVG
8	13672.500	33.76	20.00	53.76	74.00	-20.24	peak

- Note: 1. Peak Result = Reading Level + Correct Factor.  
 2. If Peak Result complies with AV limit, AV Result is deemed to comply with AV limit.  
 3. Peak: Peak detector.  
 4. Filter losses were only considered in the spurious frequency bands and the authorized band was not corrected for High Pass Filter losses.  
 5. Proper operation of the transmitter prior to adding the filter to the measurement chain.

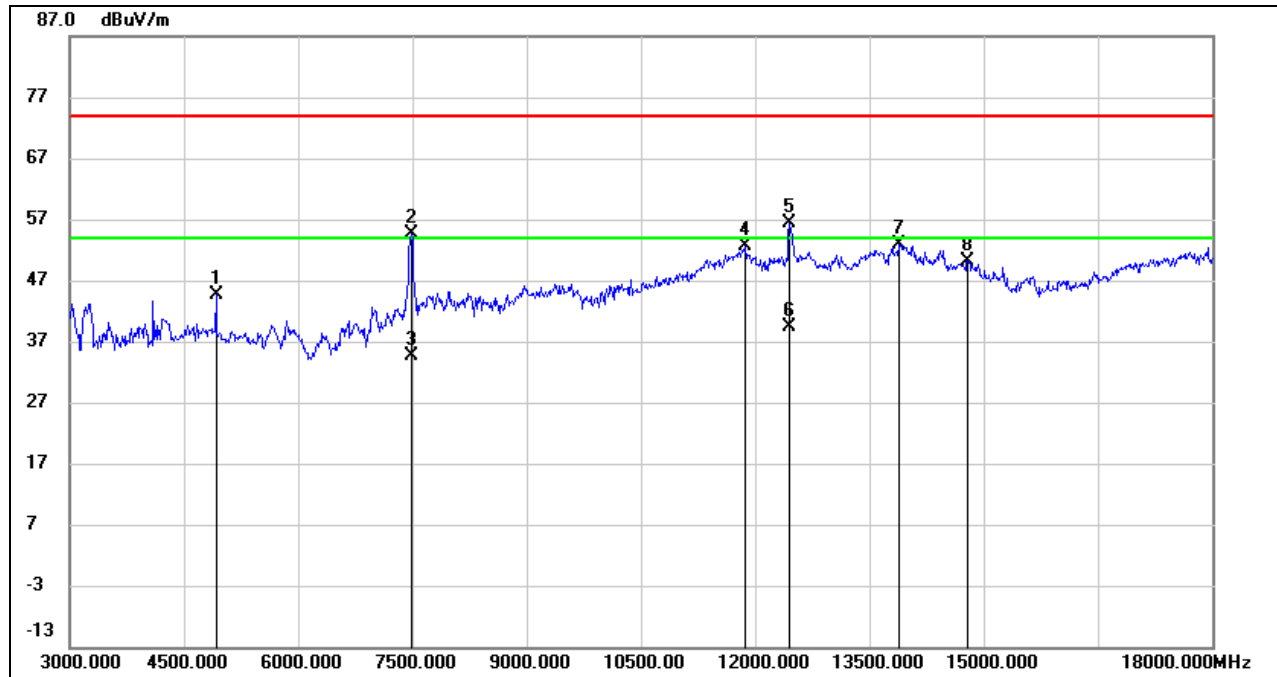
**HARMONICS AND SPURIOUS EMISSIONS (HIGH CHANNEL, HORIZONTAL)**

No.	Frequency (MHz)	Reading (dBuV)	Correct (dB/m)	Result (dBuV/m)	Limit (dBuV/m)	Margin (dB)	Remark
1	4920.000	45.70	-1.13	44.57	74.00	-29.43	peak
2	7492.500	48.96	5.66	54.62	74.00	-19.38	peak
3	7492.500	28.91	5.66	34.57	54.00	-19.43	AVG
4	11872.500	35.52	17.18	52.70	74.00	-21.30	peak
5	12457.500	39.37	16.92	56.29	74.00	-17.71	peak
6	12457.500	22.49	16.92	39.41	54.00	-14.59	AVG
7	13890.000	32.29	20.56	52.85	74.00	-21.15	peak
8	14790.000	32.96	17.29	50.25	74.00	-23.75	peak

- Note: 1. Peak Result = Reading Level + Correct Factor.  
 2. If Peak Result complies with AV limit, AV Result is deemed to comply with AV limit.  
 3. Peak: Peak detector.  
 4. Filter losses were only considered in the spurious frequency bands and the authorized band was not corrected for High Pass Filter losses.  
 5. Proper operation of the transmitter prior to adding the filter to the measurement chain.





**HARMONICS AND SPURIOUS EMISSIONS (HIGH CHANNEL, VERTICAL)**

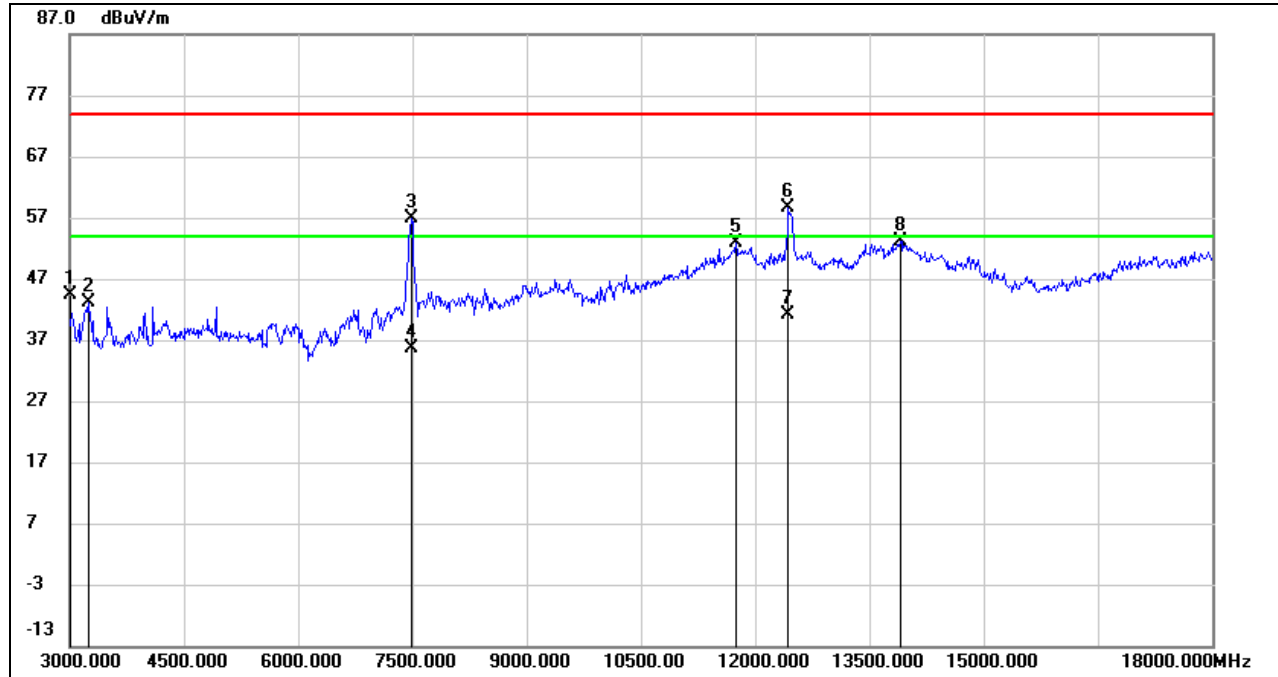

No.	Frequency (MHz)	Reading (dBuV)	Correct (dB/m)	Result (dBuV/m)	Limit (dBuV/m)	Margin (dB)	Remark
1	3000.000	51.49	-7.12	44.37	74.00	-29.63	peak
2	3240.000	49.57	-6.55	43.02	74.00	-30.98	peak
3	7492.500	51.20	5.66	56.86	74.00	-17.14	peak
4	7492.500	30.09	5.66	35.75	54.00	-18.25	AVG
5	11745.000	36.04	16.88	52.92	74.00	-21.08	peak
6	12442.500	41.64	16.95	58.59	74.00	-15.41	peak
7	12442.500	24.21	16.95	41.16	54.00	-12.84	AVG
8	13912.500	32.64	20.58	53.22	74.00	-20.78	peak

- Note: 1. Peak Result = Reading Level + Correct Factor.  
 2. If Peak Result complies with AV limit, AV Result is deemed to comply with AV limit.  
 3. Peak: Peak detector.  
 4. Filter losses were only considered in the spurious frequency bands and the authorized band was not corrected for High Pass Filter losses.  
 5. Proper operation of the transmitter prior to adding the filter to the measurement chain.

Note: All modes and channels have been tested, only the worst data was recorded in the report.

Note: Both antennas have been tested, only the worst data was recorded in the report.

**8.3.2. 802.11g MODE**

**ANTENNA 1 TEST RESULTS (WORST CASE)**

**HARMONICS AND SPURIOUS EMISSIONS (LOW CHANNEL, HORIZONTAL)**

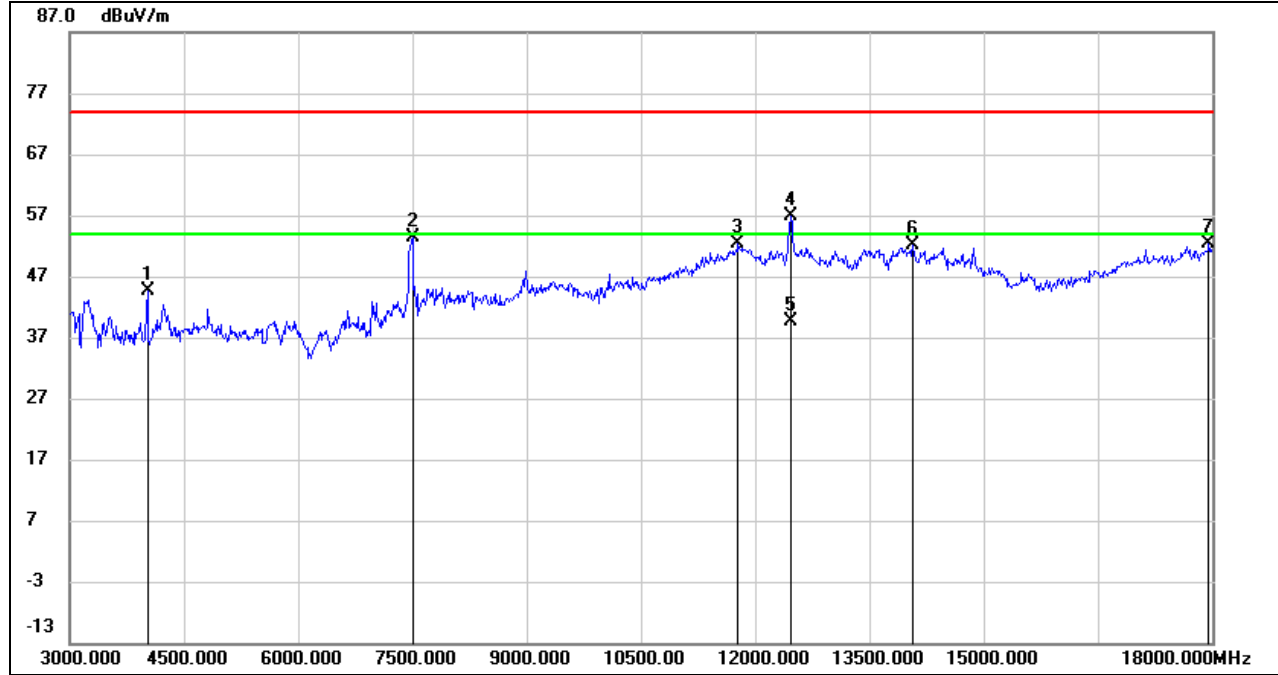

No.	Frequency (MHz)	Reading (dBuV)	Correct (dB/m)	Result (dBuV/m)	Limit (dBuV/m)	Margin (dB)	Remark
1	4020.000	49.23	-4.49	44.74	74.00	-29.26	peak
2	7500.000	47.84	5.65	53.49	74.00	-20.51	peak
3	11782.500	35.15	17.11	52.26	74.00	-21.74	peak
4	12465.000	39.95	16.91	56.86	74.00	-17.14	peak
5	12465.000	22.71	16.91	39.62	54.00	-14.38	AVG
6	14077.500	31.86	20.26	52.12	74.00	-21.88	peak
7	17962.500	28.72	23.58	52.30	74.00	-21.70	peak

- Note: 1. Peak Result = Reading Level + Correct Factor.  
 2. If Peak Result complies with AV limit, AV Result is deemed to comply with AV limit.  
 3. Peak: Peak detector.  
 4. Filter losses were only considered in the spurious frequency bands and the authorized band was not corrected for High Pass Filter losses.  
 5. Proper operation of the transmitter prior to adding the filter to the measurement chain.

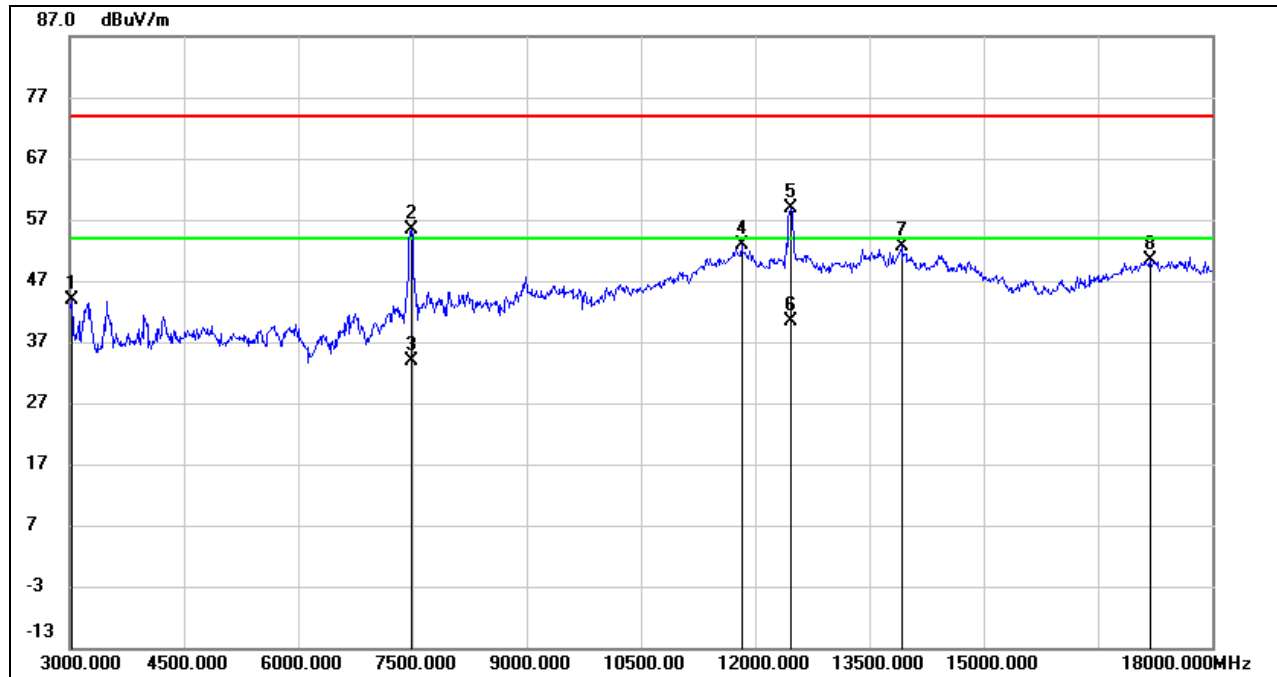
**HARMONICS AND SPURIOUS EMISSIONS (LOW CHANNEL, VERTICAL)**

No.	Frequency (MHz)	Reading (dBuV)	Correct (dB/m)	Result (dBuV/m)	Limit (dBuV/m)	Margin (dB)	Remark
1	3030.000	50.82	-7.04	43.78	74.00	-30.22	peak
2	7485.000	49.59	5.67	55.26	74.00	-18.74	peak
3	7485.000	28.26	5.67	33.93	54.00	-20.07	AVG
4	11827.500	35.75	17.20	52.95	74.00	-21.05	peak
5	12465.000	41.98	16.91	58.89	74.00	-15.11	peak
6	12465.000	23.40	16.91	40.31	54.00	-13.69	AVG
7	13927.500	31.95	20.59	52.54	74.00	-21.46	peak
8	17190.000	30.41	20.09	50.50	74.00	-23.50	peak

Note: 1. Peak Result = Reading Level + Correct Factor.

2. If Peak Result complies with AV limit, AV Result is deemed to comply with AV limit.

3. Peak: Peak detector.

4. Filter losses were only considered in the spurious frequency bands and the authorized band was not corrected for High Pass Filter losses.

5. Proper operation of the transmitter prior to adding the filter to the measurement chain.

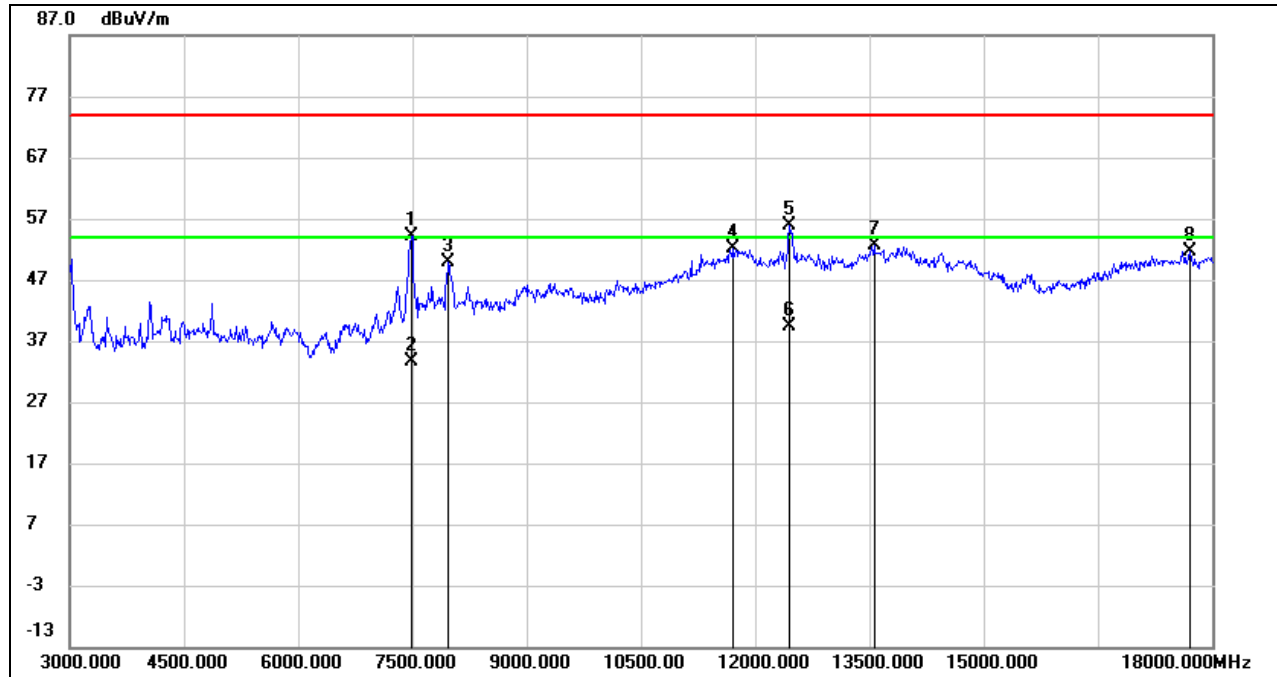
**HARMONICS AND SPURIOUS EMISSIONS (MID CHANNEL, HORIZONTAL)**

No.	Frequency (MHz)	Reading (dBuV)	Correct (dB/m)	Result (dBuV/m)	Limit (dBuV/m)	Margin (dB)	Remark
1	7492.500	48.50	5.66	54.16	74.00	-19.84	peak
2	7492.500	28.02	5.66	33.68	54.00	-20.32	AVG
3	7965.000	44.34	5.48	49.82	74.00	-24.18	peak
4	11715.000	35.48	16.68	52.16	74.00	-21.84	peak
5	12457.500	38.98	16.92	55.90	74.00	-18.10	peak
6	12457.500	22.45	16.92	39.37	54.00	-14.63	AVG
7	13567.500	32.92	19.67	52.59	74.00	-21.41	peak
8	17707.500	29.43	22.22	51.65	74.00	-22.35	peak

- Note: 1. Peak Result = Reading Level + Correct Factor.  
 2. If Peak Result complies with AV limit, AV Result is deemed to comply with AV limit.  
 3. Peak: Peak detector.  
 4. Filter losses were only considered in the spurious frequency bands and the authorized band was not corrected for High Pass Filter losses.  
 5. Proper operation of the transmitter prior to adding the filter to the measurement chain.

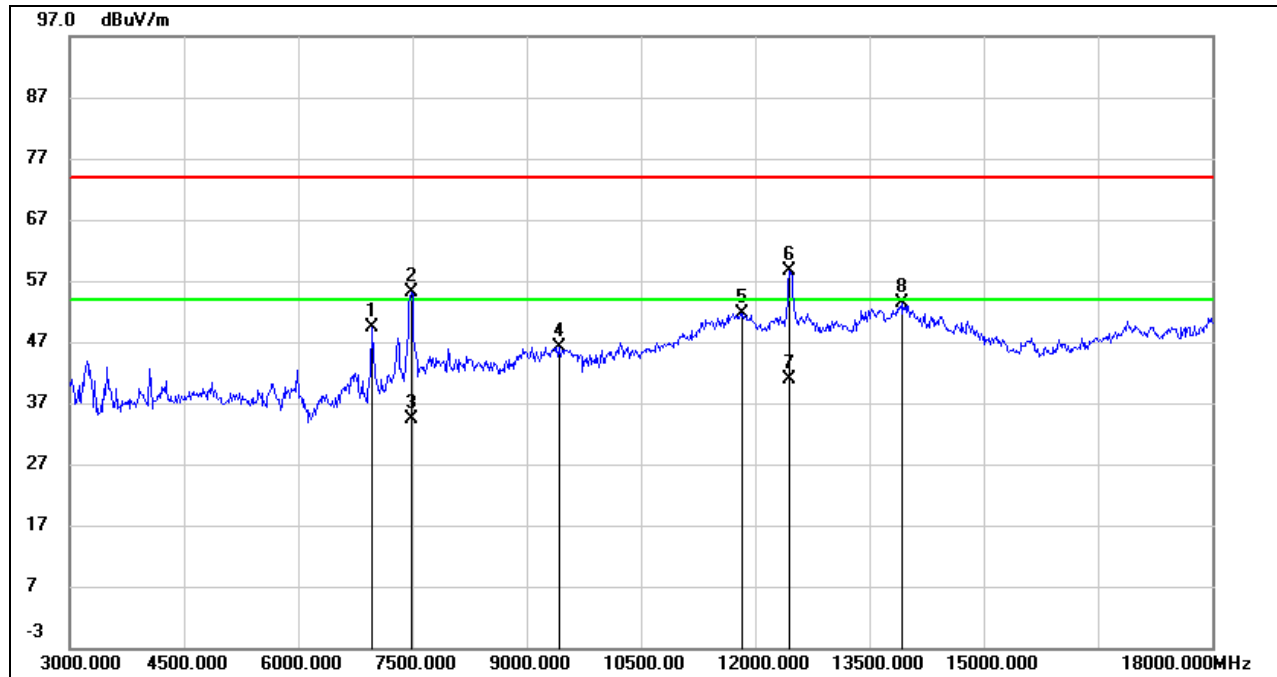
**HARMONICS AND SPURIOUS EMISSIONS (MID CHANNEL, VERTICAL)**

No.	Frequency (MHz)	Reading (dBuV)	Correct (dB/m)	Result (dBuV/m)	Limit (dBuV/m)	Margin (dB)	Remark
1	6967.500	45.13	4.23	49.36	74.00	-24.64	peak
2	7492.500	49.56	5.66	55.22	74.00	-18.78	peak
3	7492.500	28.70	5.66	34.36	54.00	-19.64	AVG
4	9427.500	36.44	9.75	46.19	74.00	-27.81	peak
5	11820.000	34.47	17.21	51.68	74.00	-22.32	peak
6	12457.500	41.60	16.92	58.52	74.00	-15.48	peak
7	12457.500	24.01	16.92	40.93	54.00	-13.07	AVG
8	13920.000	32.87	20.58	53.45	74.00	-20.55	peak

Note: 1. Peak Result = Reading Level + Correct Factor.

2. If Peak Result complies with AV limit, AV Result is deemed to comply with AV limit.

3. Peak: Peak detector.

4. Filter losses were only considered in the spurious frequency bands and the authorized band was not corrected for High Pass Filter losses.

5. Proper operation of the transmitter prior to adding the filter to the measurement chain.

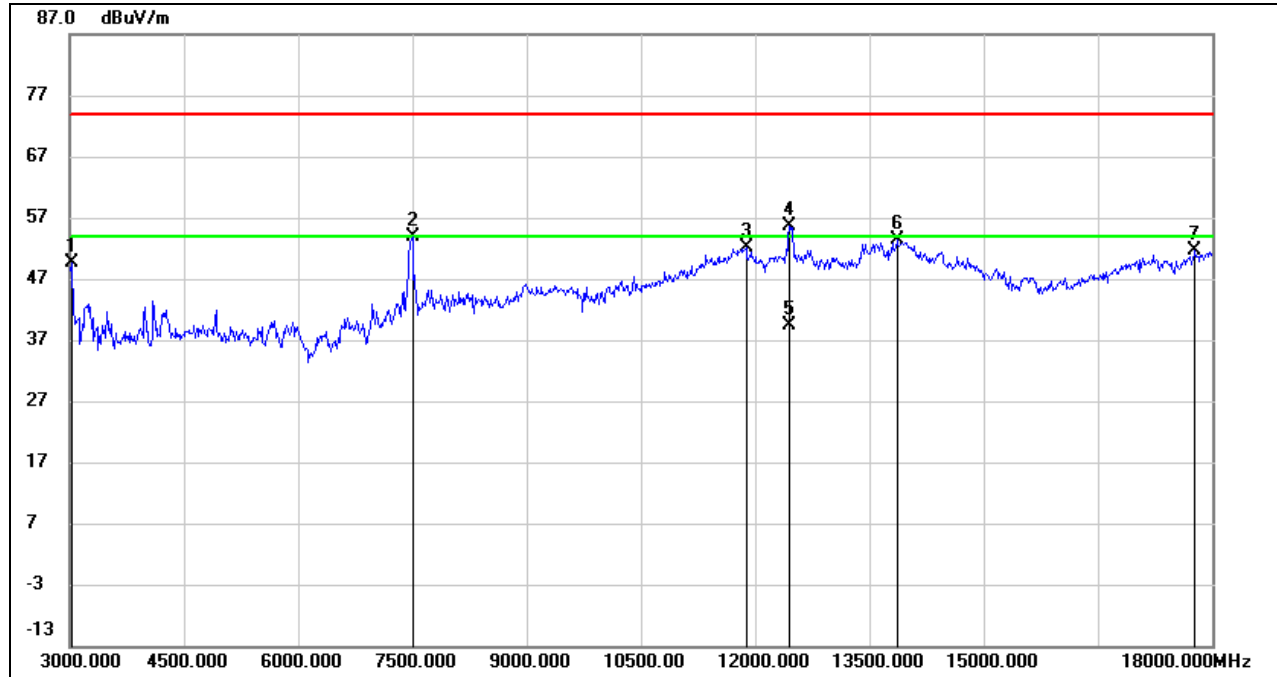
**HARMONICS AND SPURIOUS EMISSIONS (HIGH CHANNEL, HORIZONTAL)**

No.	Frequency (MHz)	Reading (dBuV)	Correct (dB/m)	Result (dBuV/m)	Limit (dBuV/m)	Margin (dB)	Remark
1	3030.000	56.60	-7.04	49.56	74.00	-24.44	peak
2	7500.000	48.25	5.65	53.90	74.00	-20.10	peak
3	11887.500	34.86	17.17	52.03	74.00	-21.97	peak
4	12450.000	38.74	16.94	55.68	74.00	-18.32	peak
5	12450.000	22.41	16.94	39.35	54.00	-14.65	AVG
6	13867.500	32.87	20.54	53.41	74.00	-20.59	peak
7	17782.500	28.63	23.01	51.64	74.00	-22.36	peak

Note: 1. Peak Result = Reading Level + Correct Factor.

2. If Peak Result complies with AV limit, AV Result is deemed to comply with AV limit.

3. Peak: Peak detector.

4. Filter losses were only considered in the spurious frequency bands and the authorized band was not corrected for High Pass Filter losses.

5. Proper operation of the transmitter prior to adding the filter to the measurement chain.

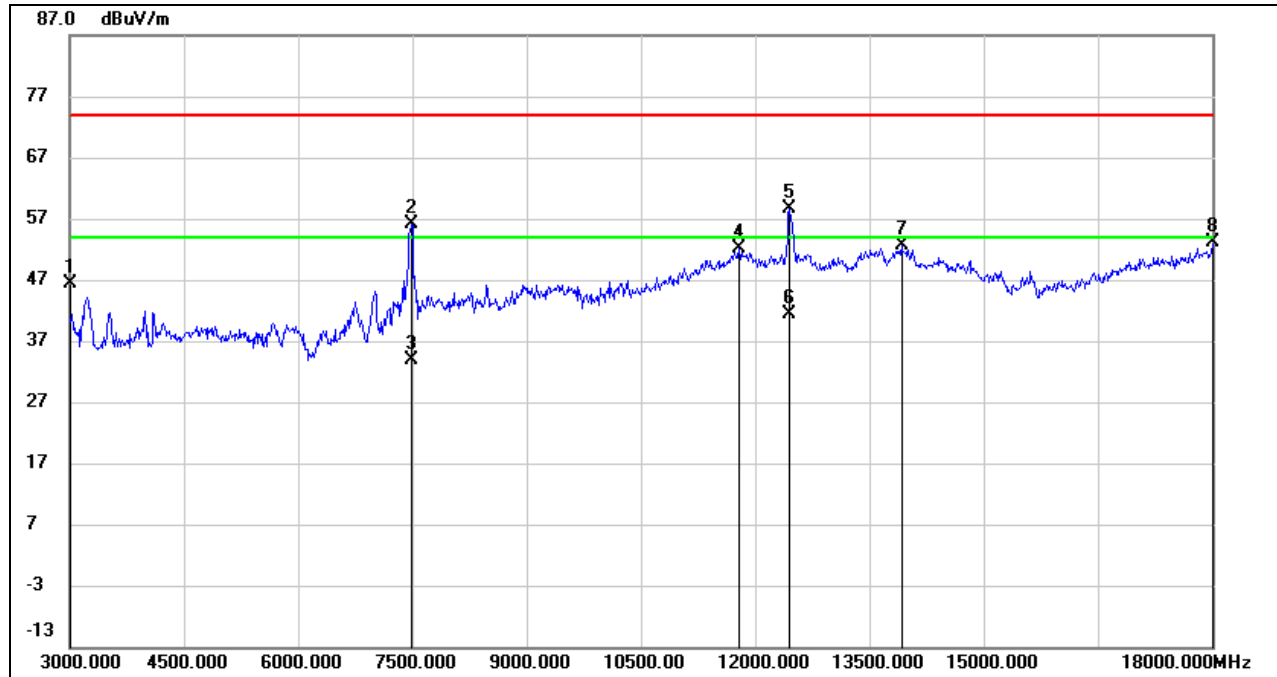
**HARMONICS AND SPURIOUS EMISSIONS (HIGH CHANNEL, VERTICAL)**

No.	Frequency (MHz)	Reading (dBuV)	Correct (dB/m)	Result (dBuV/m)	Limit (dBuV/m)	Margin (dB)	Remark
1	3000.000	53.62	-7.12	46.50	74.00	-27.50	peak
2	7485.000	50.40	5.67	56.07	74.00	-17.93	peak
3	7485.000	28.29	5.67	33.96	54.00	-20.04	AVG
4	11790.000	35.09	17.15	52.24	74.00	-21.76	peak
5	12457.500	41.63	16.92	58.55	74.00	-15.45	peak
6	12457.500	24.37	16.92	41.29	54.00	-12.71	AVG
7	13920.000	31.96	20.58	52.54	74.00	-21.46	peak
8	18000.000	29.42	23.68	53.10	74.00	-20.90	peak

Note: 1. Peak Result = Reading Level + Correct Factor.

2. If Peak Result complies with AV limit, AV Result is deemed to comply with AV limit.

3. Peak: Peak detector.

4. Filter losses were only considered in the spurious frequency bands and the authorized band was not corrected for High Pass Filter losses.

5. Proper operation of the transmitter prior to adding the filter to the measurement chain.

Note: All modes and channels have been tested, only the worst data was recorded in the report.

Note: Both antennas have been tested, only the worst data was recorded in the report.

### 8.3.3. 802.11n HT20 MODE

#### HARMONICS AND SPURIOUS EMISSIONS (LOW CHANNEL, HORIZONTAL)

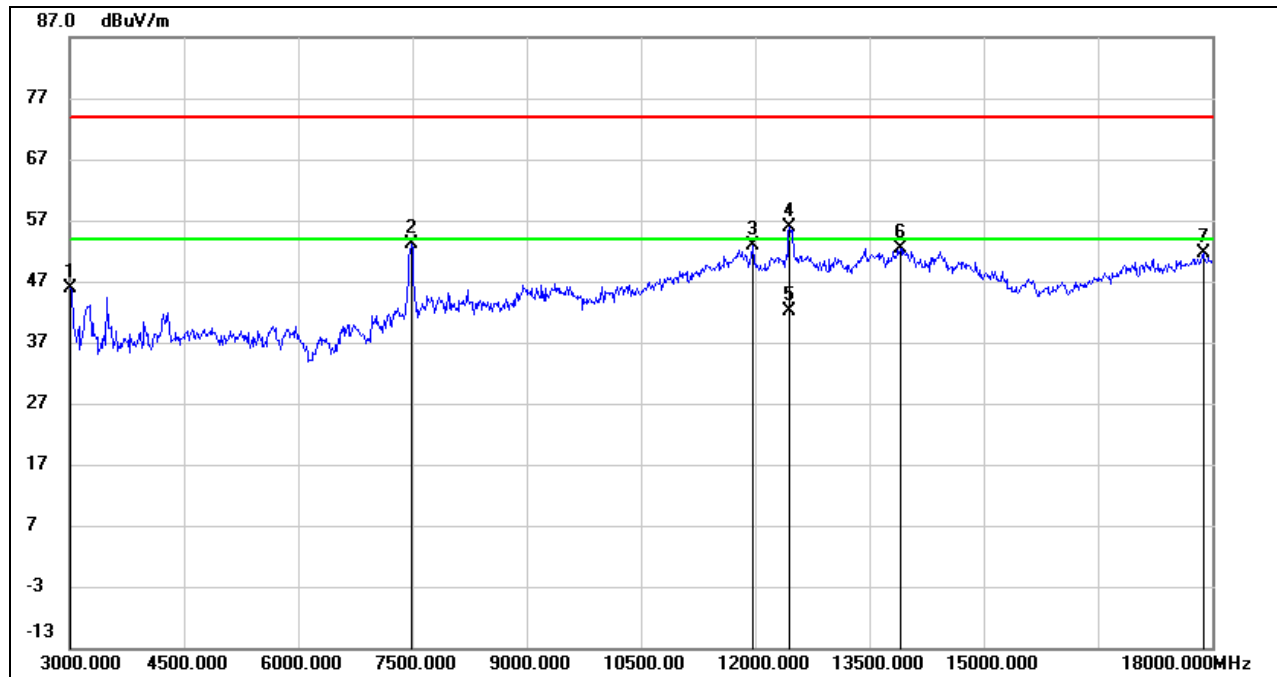

No.	Frequency (MHz)	Reading (dBuV)	Correct (dB/m)	Result (dBuV/m)	Limit (dBuV/m)	Margin (dB)	Remark
1	3015.000	53.05	-7.09	45.96	74.00	-28.04	peak
2	7492.500	47.58	5.66	53.24	74.00	-20.76	peak
3	11970.000	35.72	17.12	52.84	74.00	-21.16	peak
4	12450.000	38.86	16.94	55.80	74.00	-18.20	peak
5	12450.000	25.31	16.94	42.25	54.00	-11.75	AVG
6	13912.500	31.75	20.58	52.33	74.00	-21.67	peak
7	17887.500	28.25	23.41	51.66	74.00	-22.34	peak

Note: 1. Peak Result = Reading Level + Correct Factor.

2. If Peak Result complies with AV limit, AV Result is deemed to comply with AV limit.

3. Peak: Peak detector.

4. Filter losses were only considered in the spurious frequency bands and the authorized band was not corrected for High Pass Filter losses.

5. Proper operation of the transmitter prior to adding the filter to the measurement chain.



**HARMONICS AND SPURIOUS EMISSIONS (LOW CHANNEL, VERTICAL)**

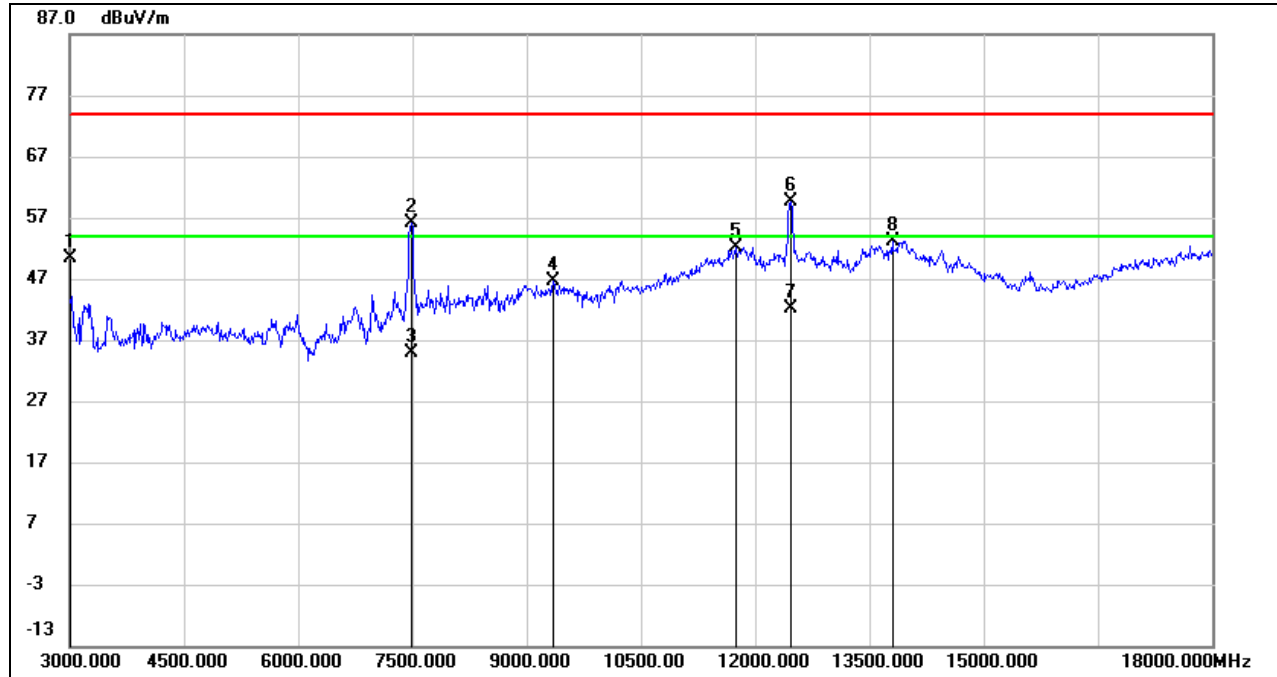

No.	Frequency (MHz)	Reading (dBuV)	Correct (dB/m)	Result (dBuV/m)	Limit (dBuV/m)	Margin (dB)	Remark
1	3000.000	57.50	-7.12	50.38	74.00	-23.62	peak
2	7492.500	50.39	5.66	56.05	74.00	-17.95	peak
3	7492.500	29.10	5.66	34.76	54.00	-19.24	AVG
4	9345.000	37.29	9.34	46.63	74.00	-27.37	peak
5	11745.000	35.32	16.88	52.20	74.00	-21.80	peak
6	12465.000	42.67	16.91	59.58	74.00	-14.42	peak
7	12465.000	25.34	16.91	42.25	54.00	-11.75	AVG
8	13807.500	32.68	20.51	53.19	74.00	-20.81	peak

- Note: 1. Peak Result = Reading Level + Correct Factor.  
 2. If Peak Result complies with AV limit, AV Result is deemed to comply with AV limit.  
 3. Peak: Peak detector.  
 4. Filter losses were only considered in the spurious frequency bands and the authorized band was not corrected for High Pass Filter losses.  
 5. Proper operation of the transmitter prior to adding the filter to the measurement chain.

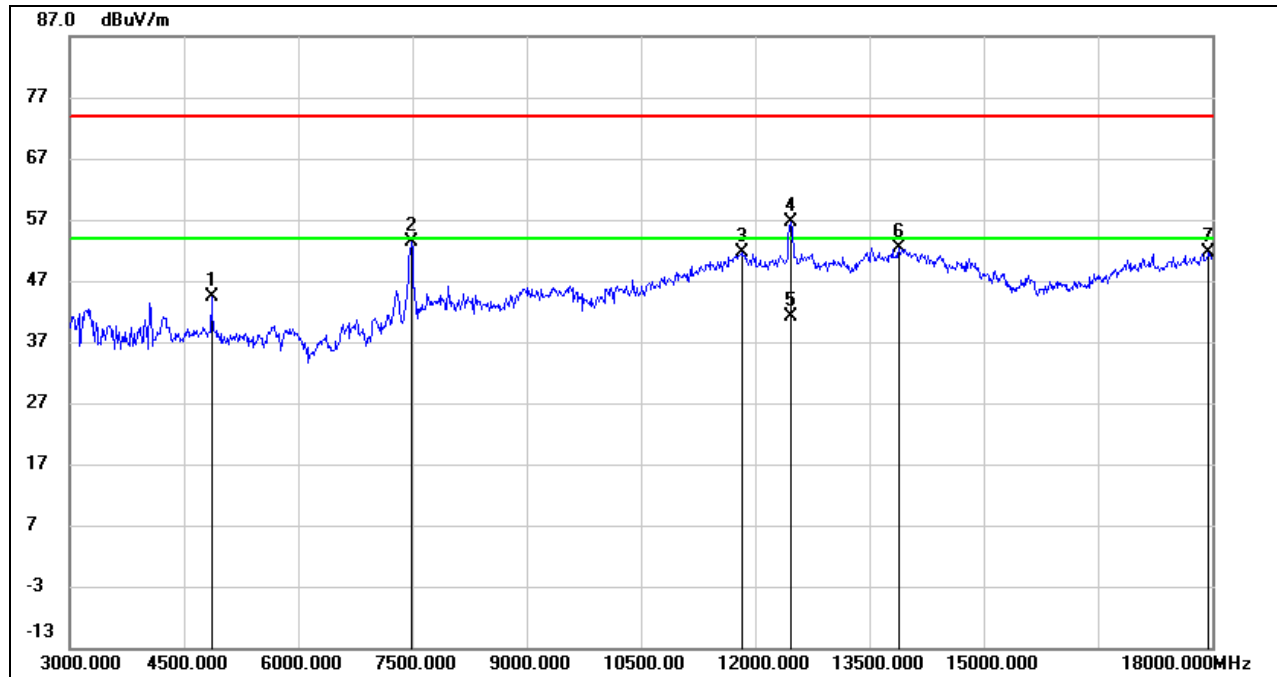
**HARMONICS AND SPURIOUS EMISSIONS (MID CHANNEL, HORIZONTAL)**

No.	Frequency (MHz)	Reading (dBuV)	Correct (dB/m)	Result (dBuV/m)	Limit (dBuV/m)	Margin (dB)	Remark
1	4867.500	45.54	-1.14	44.40	74.00	-29.60	peak
2	7485.000	47.65	5.67	53.32	74.00	-20.68	peak
3	11835.000	34.32	17.20	51.52	74.00	-22.48	peak
4	12472.500	39.79	16.90	56.69	74.00	-17.31	peak
5	12472.500	24.35	16.90	41.25	54.00	-12.75	AVG
6	13897.500	31.94	20.56	52.50	74.00	-21.50	peak
7	17962.500	27.98	23.58	51.56	74.00	-22.44	peak

Note: 1. Peak Result = Reading Level + Correct Factor.

2. If Peak Result complies with AV limit, AV Result is deemed to comply with AV limit.

3. Peak: Peak detector.

4. Filter losses were only considered in the spurious frequency bands and the authorized band was not corrected for High Pass Filter losses.

5. Proper operation of the transmitter prior to adding the filter to the measurement chain.

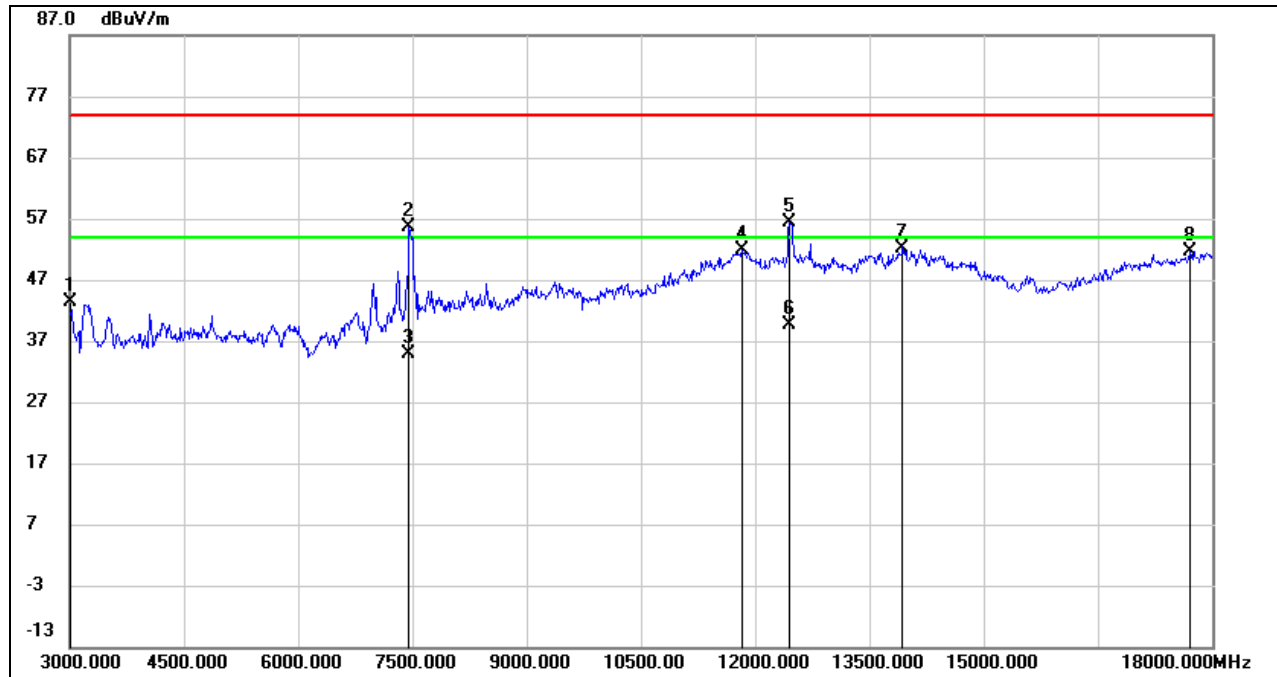
**HARMONICS AND SPURIOUS EMISSIONS (MID CHANNEL, VERTICAL)**

No.	Frequency (MHz)	Reading (dBuV)	Correct (dB/m)	Result (dBuV/m)	Limit (dBuV/m)	Margin (dB)	Remark
1	3000.000	50.56	-7.12	43.44	74.00	-30.56	peak
2	7462.500	50.02	5.70	55.72	74.00	-18.28	peak
3	7462.500	29.22	5.70	34.92	54.00	-19.08	AVG
4	11827.500	34.77	17.20	51.97	74.00	-22.03	peak
5	12450.000	39.53	16.94	56.47	74.00	-17.53	peak
6	12450.000	22.80	16.94	39.74	54.00	-14.26	AVG
7	13942.500	31.65	20.60	52.25	74.00	-21.75	peak
8	17707.500	29.44	22.22	51.66	74.00	-22.34	peak

- Note: 1. Peak Result = Reading Level + Correct Factor.  
 2. If Peak Result complies with AV limit, AV Result is deemed to comply with AV limit.  
 3. Peak: Peak detector.  
 4. Filter losses were only considered in the spurious frequency bands and the authorized band was not corrected for High Pass Filter losses.  
 5. Proper operation of the transmitter prior to adding the filter to the measurement chain.



**HARMONICS AND SPURIOUS EMISSIONS (HIGH CHANNEL, HORIZONTAL)**

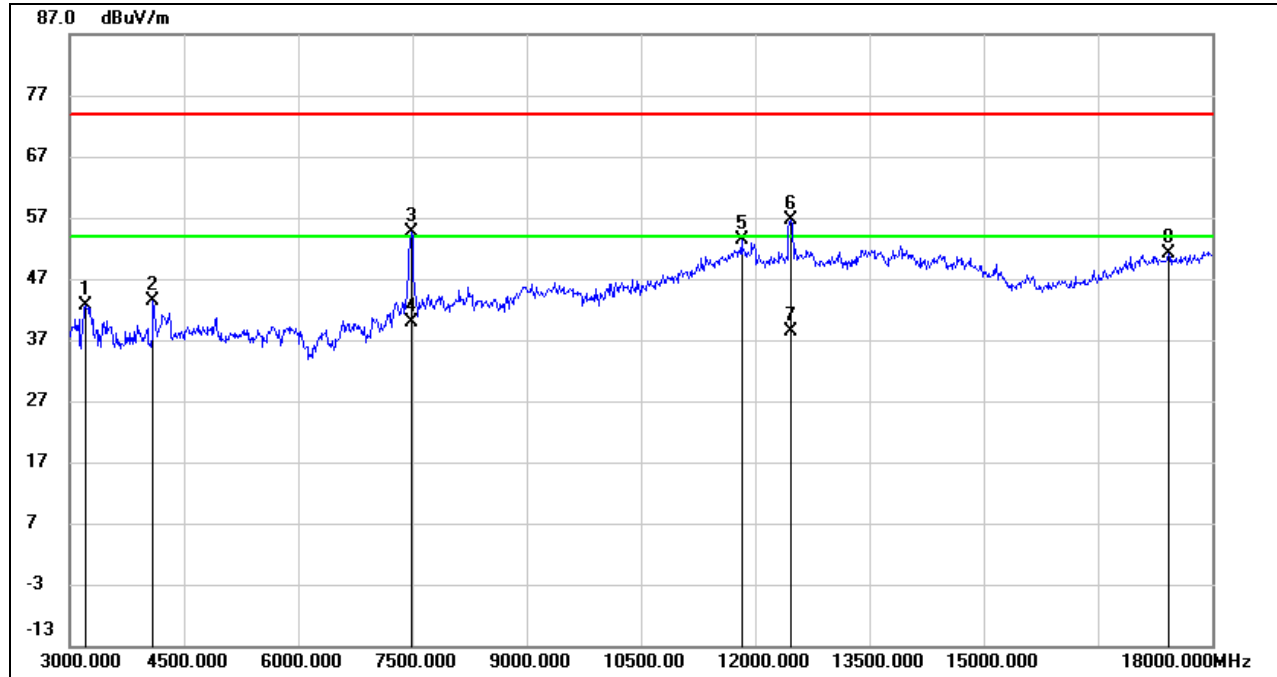

No.	Frequency (MHz)	Reading (dBuV)	Correct (dB/m)	Result (dBuV/m)	Limit (dBuV/m)	Margin (dB)	Remark
1	3210.000	49.13	-6.59	42.54	74.00	-31.46	peak
2	4095.000	47.07	-3.79	43.28	74.00	-30.72	peak
3	7492.500	49.08	5.66	54.74	74.00	-19.26	peak
4	7492.500	34.20	5.66	39.86	54.00	-14.14	AVG
5	11827.500	36.12	17.20	53.32	74.00	-20.68	peak
6	12465.000	39.72	16.91	56.63	74.00	-17.37	peak
7	12465.000	21.38	16.91	38.29	54.00	-15.71	AVG
8	17430.000	30.87	20.30	51.17	74.00	-22.83	peak

Note: 1. Peak Result = Reading Level + Correct Factor.  
 2. If Peak Result complies with AV limit, AV Result is deemed to comply with AV limit.  
 3. Peak: Peak detector.  
 4. Filter losses were only considered in the spurious frequency bands and the authorized band was not corrected for High Pass Filter losses.  
 5. Proper operation of the transmitter prior to adding the filter to the measurement chain.

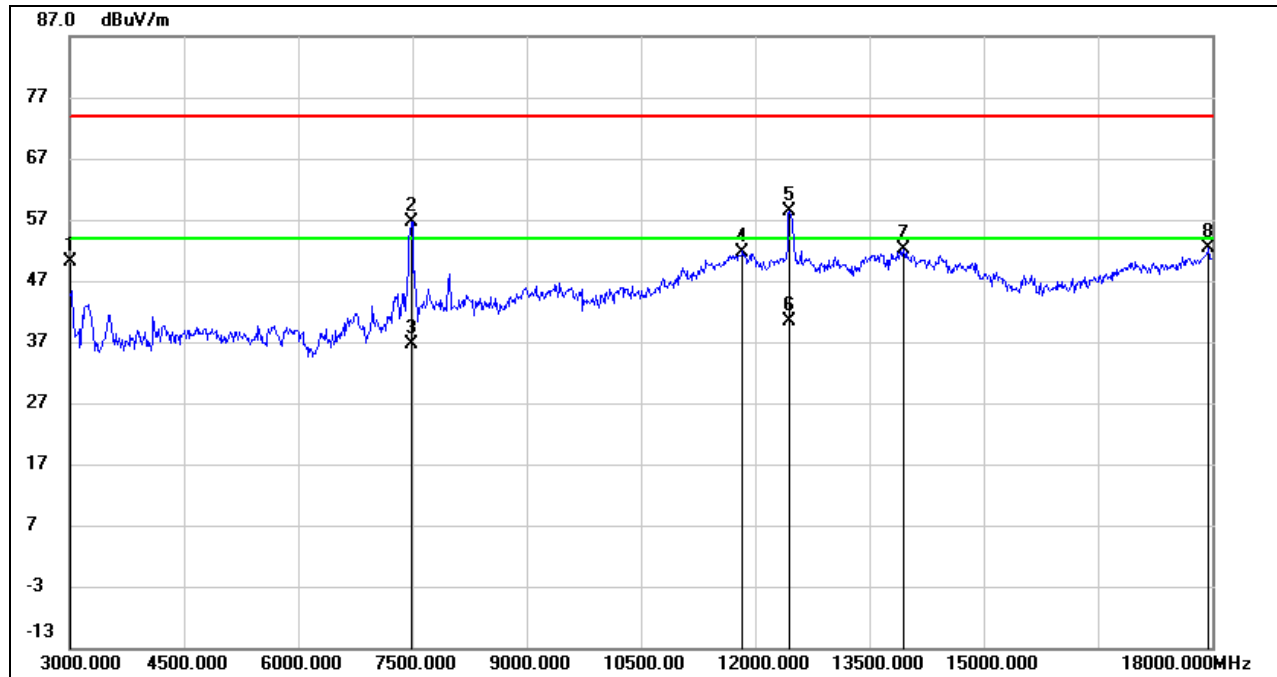
**HARMONICS AND SPURIOUS EMISSIONS (HIGH CHANNEL, VERTICAL)**

No.	Frequency (MHz)	Reading (dBuV)	Correct (dB/m)	Result (dBuV/m)	Limit (dBuV/m)	Margin (dB)	Remark
1	3000.000	57.17	-7.12	50.05	74.00	-23.95	peak
2	7492.500	50.92	5.66	56.58	74.00	-17.42	peak
3	7492.500	30.91	5.66	36.57	54.00	-17.43	AVG
4	11835.000	34.55	17.20	51.75	74.00	-22.25	peak
5	12457.500	41.58	16.92	58.50	74.00	-15.50	peak
6	12457.500	23.34	16.92	40.26	54.00	-13.74	AVG
7	13957.500	31.59	20.61	52.20	74.00	-21.80	peak
8	17955.000	28.91	23.57	52.48	74.00	-21.52	peak

- Note: 1. Peak Result = Reading Level + Correct Factor.  
 2. If Peak Result complies with AV limit, AV Result is deemed to comply with AV limit.  
 3. Peak: Peak detector.  
 4. Filter losses were only considered in the spurious frequency bands and the authorized band was not corrected for High Pass Filter losses.  
 5. Proper operation of the transmitter prior to adding the filter to the measurement chain.

### 8.3.4. 802.11n HT40 MODE

#### HARMONICS AND SPURIOUS EMISSIONS (LOW CHANNEL, HORIZONTAL)

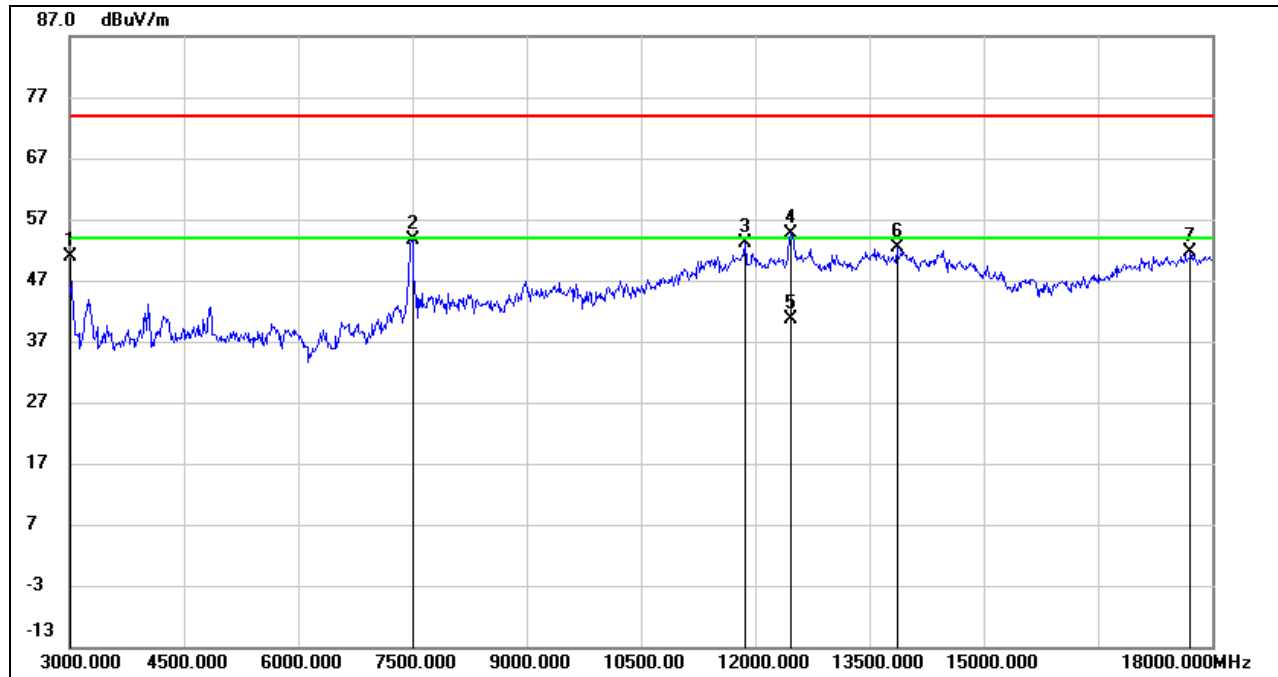

No.	Frequency (MHz)	Reading (dBuV)	Correct (dB/m)	Result (dBuV/m)	Limit (dBuV/m)	Margin (dB)	Remark
1	3000.000	58.04	-7.12	50.92	74.00	-23.08	peak
2	7500.000	47.94	5.65	53.59	74.00	-20.41	peak
3	11865.000	35.97	17.18	53.15	74.00	-20.85	peak
4	12465.000	37.71	16.91	54.62	74.00	-19.38	peak
5	12465.000	23.68	16.91	40.59	54.00	-13.41	AVG
6	13860.000	31.73	20.55	52.28	74.00	-21.72	peak
7	17715.000	29.37	22.31	51.68	74.00	-22.32	peak

- Note: 1. Peak Result = Reading Level + Correct Factor.  
 2. If Peak Result complies with AV limit, AV Result is deemed to comply with AV limit.  
 3. Peak: Peak detector.  
 4. Filter losses were only considered in the spurious frequency bands and the authorized band was not corrected for High Pass Filter losses.  
 5. Proper operation of the transmitter prior to adding the filter to the measurement chain.

**HARMONICS AND SPURIOUS EMISSIONS (LOW CHANNEL, VERTICAL)**

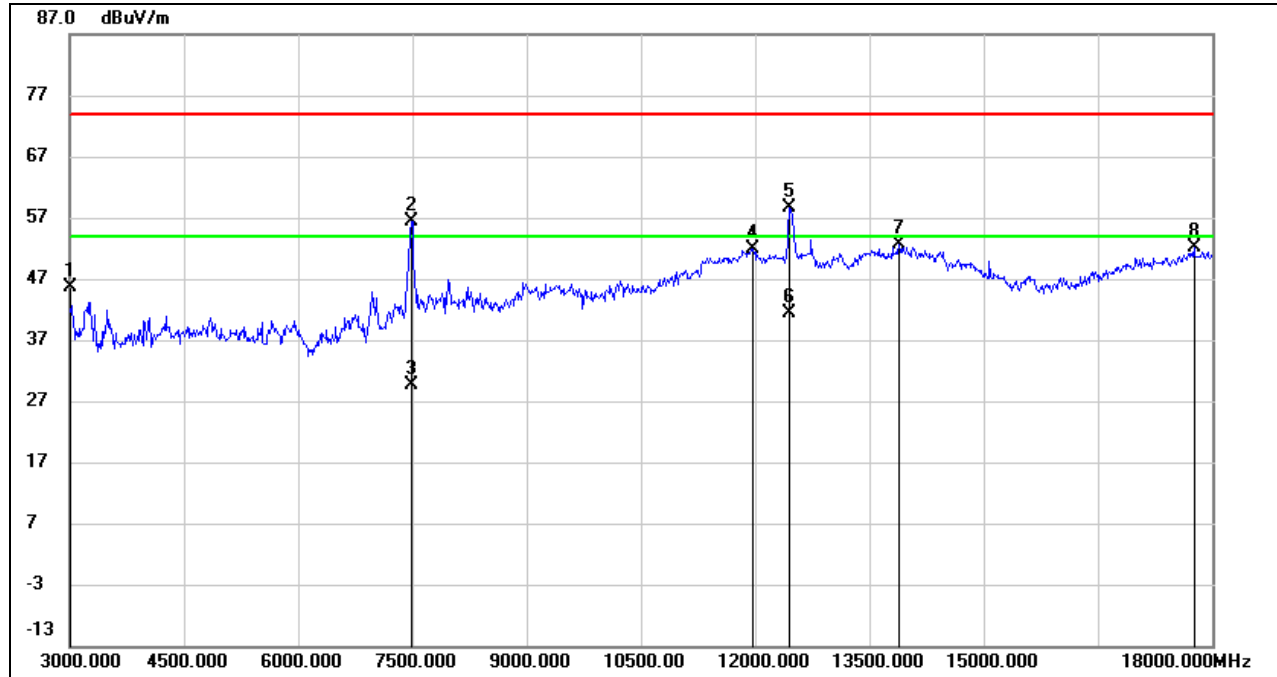

No.	Frequency (MHz)	Reading (dBuV)	Correct (dB/m)	Result (dBuV/m)	Limit (dBuV/m)	Margin (dB)	Remark
1	3000.000	52.68	-7.12	45.56	74.00	-28.44	peak
2	7485.000	50.73	5.67	56.40	74.00	-17.60	peak
3	7485.000	23.90	5.67	29.57	54.00	-24.43	AVG
4	11970.000	34.85	17.12	51.97	74.00	-22.03	peak
5	12450.000	41.69	16.94	58.63	74.00	-15.37	peak
6	12450.000	24.45	16.94	41.39	54.00	-12.61	AVG
7	13890.000	32.04	20.56	52.60	74.00	-21.40	peak
8	17760.000	29.32	22.77	52.09	74.00	-21.91	peak

- Note: 1. Peak Result = Reading Level + Correct Factor.  
 2. If Peak Result complies with AV limit, AV Result is deemed to comply with AV limit.  
 3. Peak: Peak detector.  
 4. Filter losses were only considered in the spurious frequency bands and the authorized band was not corrected for High Pass Filter losses.  
 5. Proper operation of the transmitter prior to adding the filter to the measurement chain.

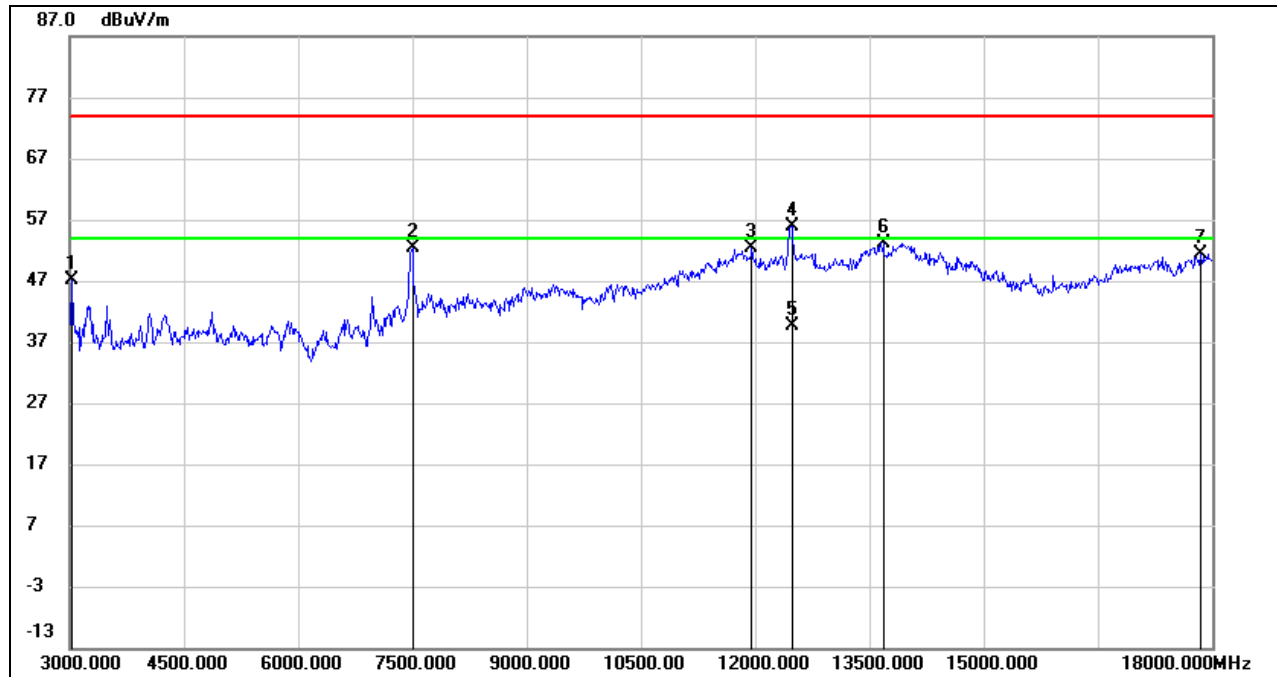
**HARMONICS AND SPURIOUS EMISSIONS (MID CHANNEL, HORIZONTAL)**

No.	Frequency (MHz)	Reading (dBuV)	Correct (dB/m)	Result (dBuV/m)	Limit (dBuV/m)	Margin (dB)	Remark
1	3030.000	54.08	-7.04	47.04	74.00	-26.96	peak
2	7500.000	46.63	5.65	52.28	74.00	-21.72	peak
3	11955.000	35.32	17.12	52.44	74.00	-21.56	peak
4	12480.000	39.07	16.88	55.95	74.00	-18.05	peak
5	12480.000	22.77	16.88	39.65	54.00	-14.35	AVG
6	13680.000	33.19	20.04	53.23	74.00	-20.77	peak
7	17850.000	28.00	23.32	51.32	74.00	-22.68	peak

Note: 1. Peak Result = Reading Level + Correct Factor.

2. If Peak Result complies with AV limit, AV Result is deemed to comply with AV limit.

3. Peak: Peak detector.

4. Filter losses were only considered in the spurious frequency bands and the authorized band was not corrected for High Pass Filter losses.

5. Proper operation of the transmitter prior to adding the filter to the measurement chain.

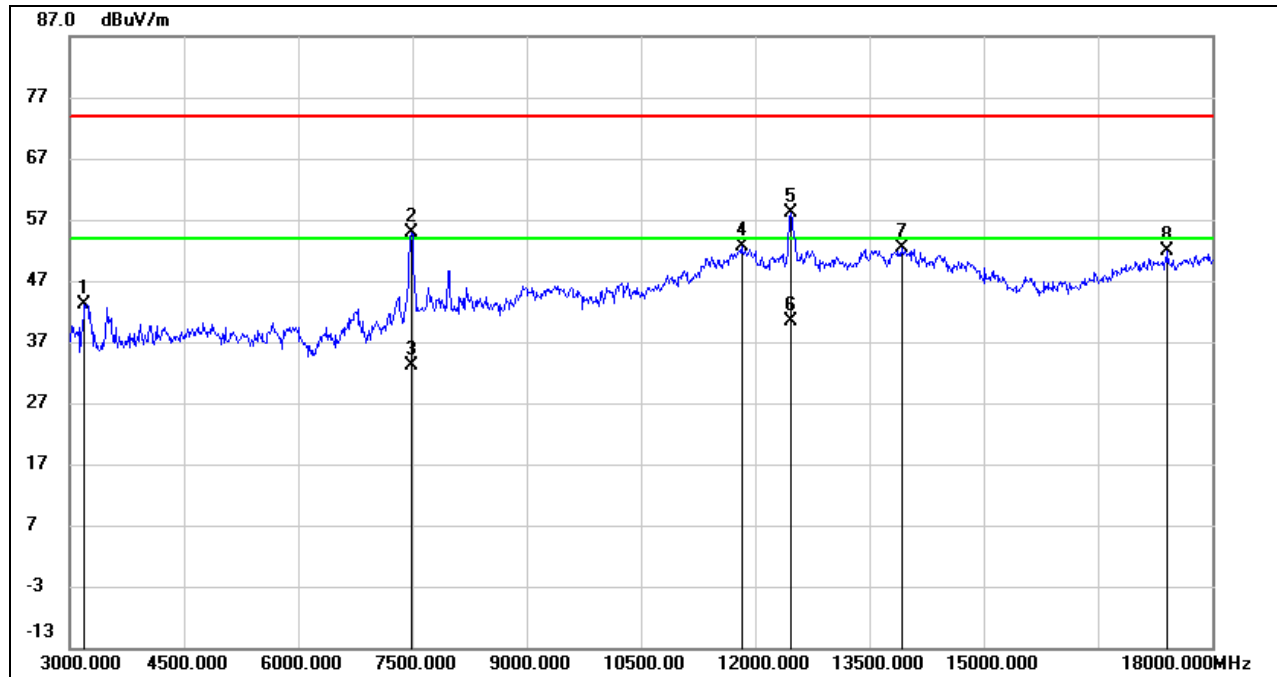

**HARMONICS AND SPURIOUS EMISSIONS (MID CHANNEL, VERTICAL)**

No.	Frequency (MHz)	Reading (dBuV)	Correct (dB/m)	Result (dBuV/m)	Limit (dBuV/m)	Margin (dB)	Remark
1	3195.000	49.73	-6.62	43.11	74.00	-30.89	peak
2	7485.000	49.25	5.67	54.92	74.00	-19.08	peak
3	7485.000	27.49	5.67	33.16	54.00	-20.84	AVG
4	11820.000	35.46	17.21	52.67	74.00	-21.33	peak
5	12465.000	41.28	16.91	58.19	74.00	-15.81	peak
6	12465.000	23.45	16.91	40.36	54.00	-13.64	AVG
7	13920.000	31.68	20.58	52.26	74.00	-21.74	peak
8	17415.000	31.59	20.25	51.84	74.00	-22.16	peak

Note: 1. Peak Result = Reading Level + Correct Factor.

2. If Peak Result complies with AV limit, AV Result is deemed to comply with AV limit.

3. Peak: Peak detector.

4. Filter losses were only considered in the spurious frequency bands and the authorized band was not corrected for High Pass Filter losses.

5. Proper operation of the transmitter prior to adding the filter to the measurement chain.

**HARMONICS AND SPURIOUS EMISSIONS (HIGH CHANNEL, HORIZONTAL)**

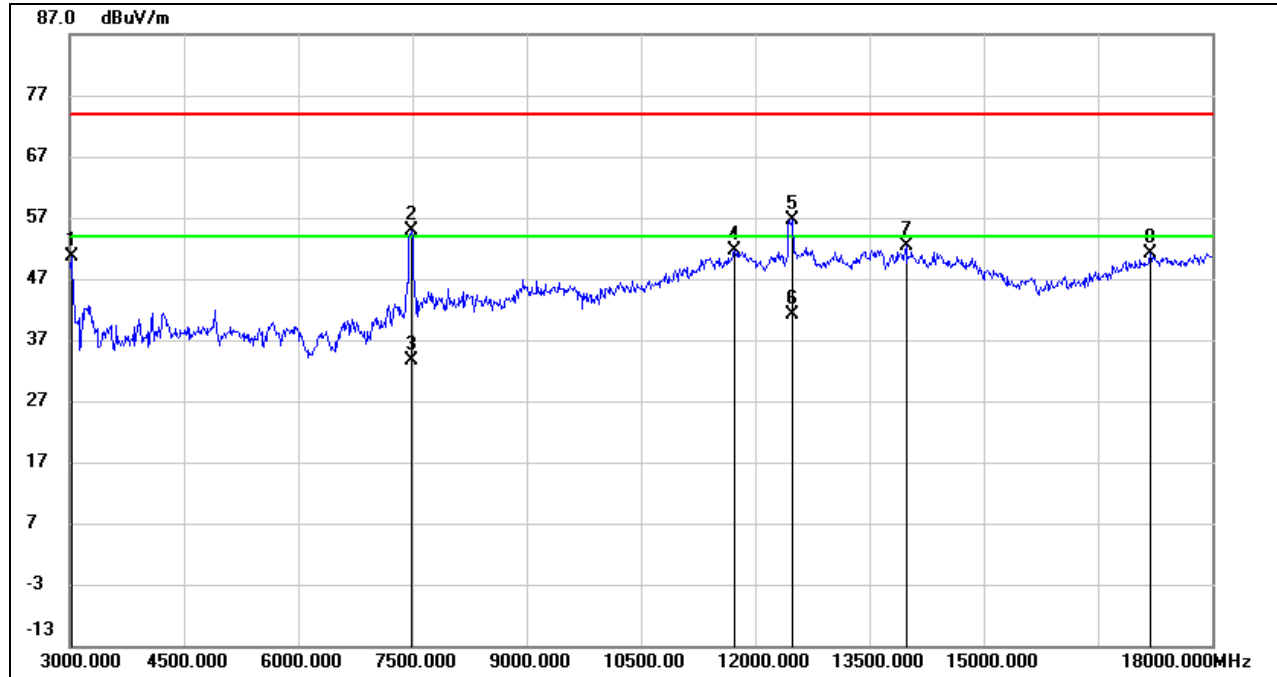

No.	Frequency (MHz)	Reading (dBuV)	Correct (dB/m)	Result (dBuV/m)	Limit (dBuV/m)	Margin (dB)	Remark
1	3030.000	57.64	-7.04	50.60	74.00	-23.40	peak
2	7492.500	49.15	5.66	54.81	74.00	-19.19	peak
3	7492.500	28.02	5.66	33.68	54.00	-20.32	AVG
4	11737.500	34.69	16.82	51.51	74.00	-22.49	peak
5	12495.000	39.74	16.84	56.58	74.00	-17.42	peak
6	12495.000	24.31	16.84	41.15	54.00	-12.85	AVG
7	13987.500	31.66	20.62	52.28	74.00	-21.72	peak
8	17197.500	31.05	20.13	51.18	74.00	-22.82	peak

- Note: 1. Peak Result = Reading Level + Correct Factor.  
 2. If Peak Result complies with AV limit, AV Result is deemed to comply with AV limit.  
 3. Peak: Peak detector.  
 4. Filter losses were only considered in the spurious frequency bands and the authorized band was not corrected for High Pass Filter losses.  
 5. Proper operation of the transmitter prior to adding the filter to the measurement chain.

**HARMONICS AND SPURIOUS EMISSIONS (HIGH CHANNEL, VERTICAL)**

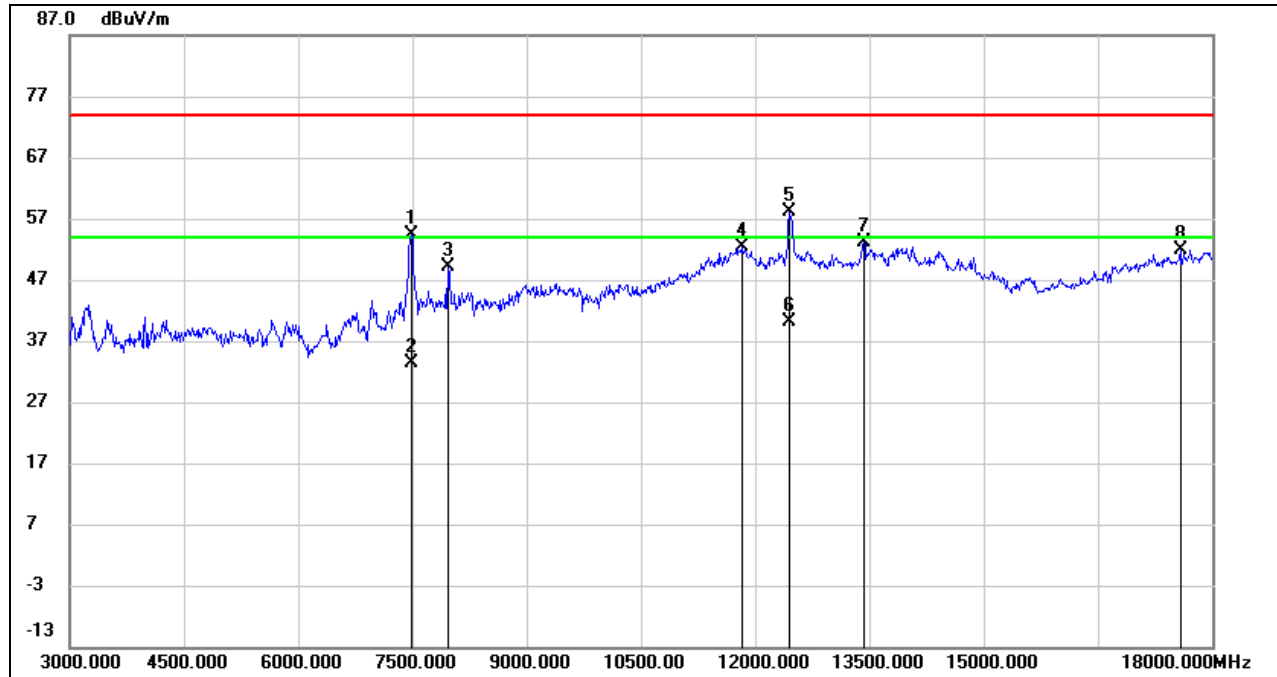

No.	Frequency (MHz)	Reading (dBuV)	Correct (dB/m)	Result (dBuV/m)	Limit (dBuV/m)	Margin (dB)	Remark
1	7492.500	48.71	5.66	54.37	74.00	-19.63	peak
2	7492.500	27.72	5.66	33.38	54.00	-20.62	AVG
3	7965.000	43.57	5.48	49.05	74.00	-24.95	peak
4	11820.000	35.27	17.21	52.48	74.00	-21.52	peak
5	12450.000	41.27	16.94	58.21	74.00	-15.79	peak
6	12450.000	23.31	16.94	40.25	54.00	-13.75	AVG
7	13432.500	33.88	19.32	53.20	74.00	-20.80	peak
8	17587.500	30.89	21.03	51.92	74.00	-22.08	peak

- Note: 1. Peak Result = Reading Level + Correct Factor.  
 2. If Peak Result complies with AV limit, AV Result is deemed to comply with AV limit.  
 3. Peak: Peak detector.  
 4. Filter losses were only considered in the spurious frequency bands and the authorized band was not corrected for High Pass Filter losses.  
 5. Proper operation of the transmitter prior to adding the filter to the measurement chain.

## 8.4. SPURIOUS EMISSIONS (18 GHz ~ 26 GHz)

### 8.4.1. 802.11b MODE

#### SPURIOUS EMISSIONS (LOW CHANNEL, WORST-CASE CONFIGURATION, HORIZONTAL)

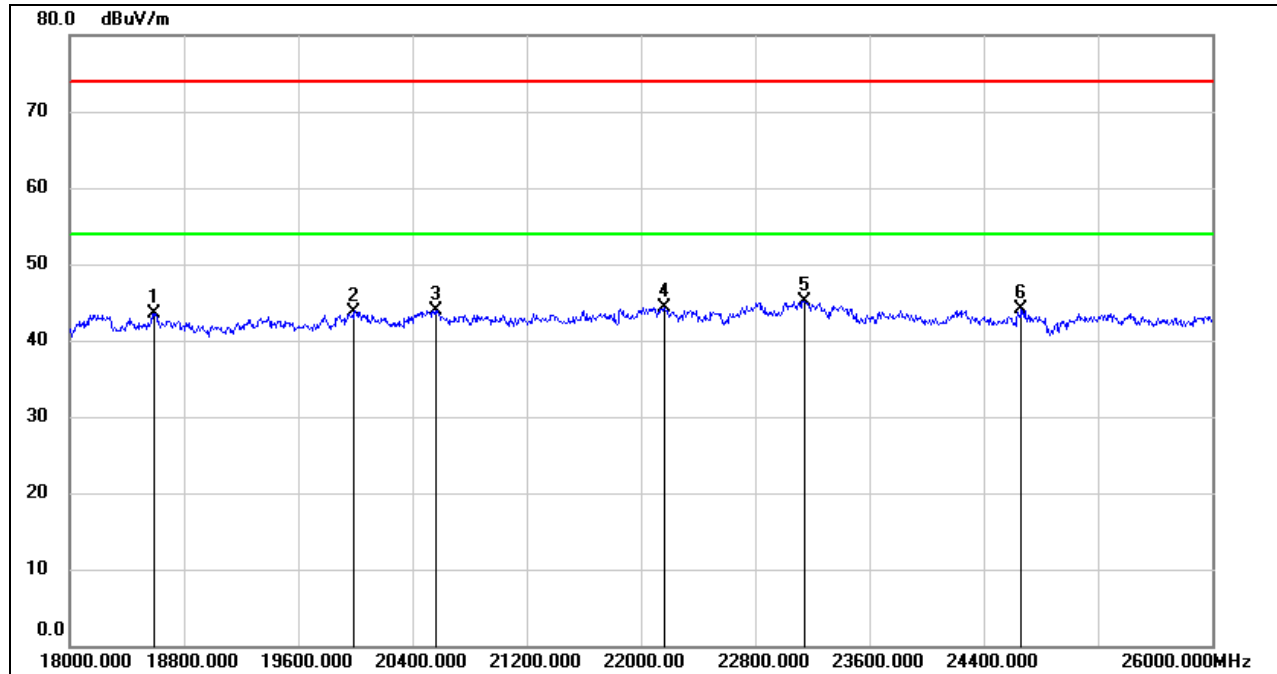

No.	Frequency (MHz)	Reading (dBuV)	Correct (dB/m)	Result (dBuV/m)	Limit (dBuV/m)	Margin (dB)	Remark
1	18592.000	48.75	-5.31	43.44	74.00	-30.56	peak
2	19992.000	49.15	-5.45	43.70	74.00	-30.30	peak
3	20560.000	49.23	-5.30	43.93	74.00	-30.07	peak
4	22160.000	48.58	-4.31	44.27	74.00	-29.73	peak
5	23144.000	48.55	-3.40	45.15	74.00	-28.85	peak
6	24664.000	46.40	-2.33	44.07	74.00	-29.93	peak

- Note: 1. Measurement = Reading Level + Correct Factor.  
 2. If Peak Result complies with AV limit, AV Result is deemed to comply with AV limit.  
 3. Peak: Peak detector.

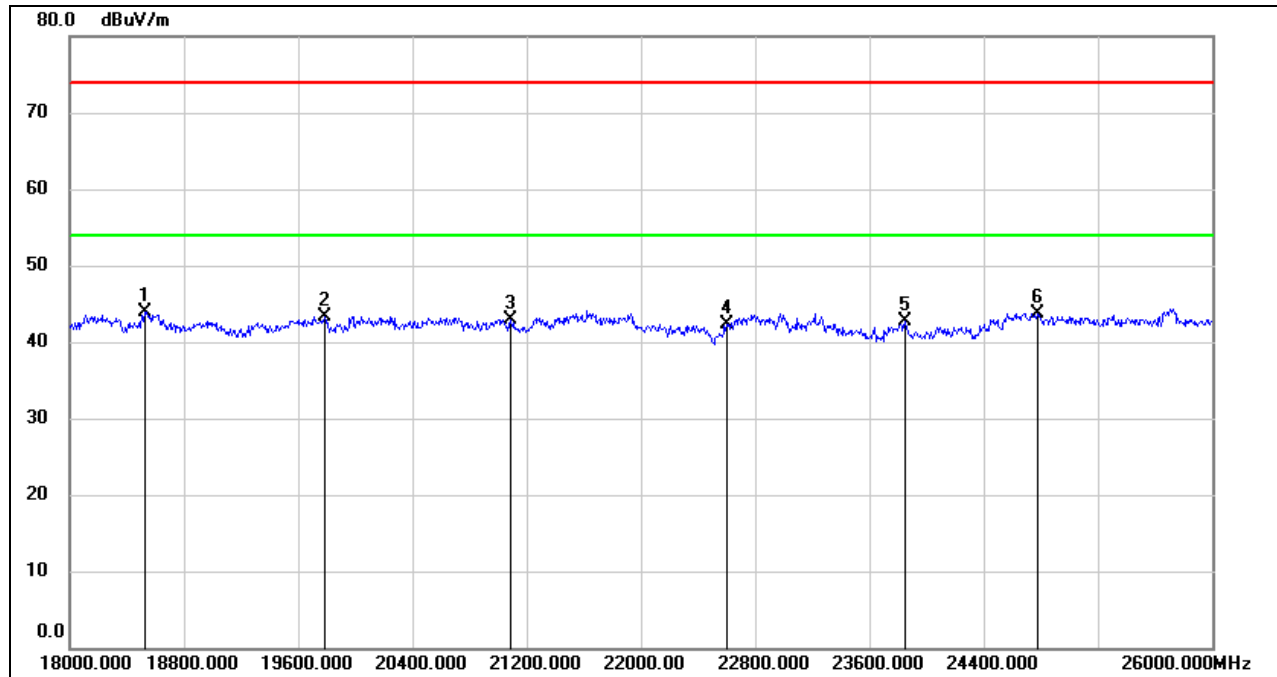
**SPURIOUS EMISSIONS (LOW CHANNEL, WORST-CASE CONFIGURATION, VERTICAL)**

No.	Frequency (MHz)	Reading (dBuV)	Correct (dB/m)	Result (dBuV/m)	Limit (dBuV/m)	Margin (dB)	Remark
1	18528.000	49.11	-5.26	43.85	74.00	-30.15	peak
2	19784.000	48.57	-5.28	43.29	74.00	-30.71	peak
3	21088.000	47.78	-4.84	42.94	74.00	-31.06	peak
4	22600.000	46.17	-3.80	42.37	74.00	-31.63	peak
5	23848.000	45.68	-3.03	42.65	74.00	-31.35	peak
6	24776.000	45.99	-2.29	43.70	74.00	-30.30	peak

Note: 1. Measurement = Reading Level + Correct Factor.

2. If Peak Result complies with AV limit, AV Result is deemed to comply with AV limit.

3. Peak: Peak detector.

Note: All the modes had been tested, but only the worst data was recorded in the report.

## 8.5. SPURIOUS EMISSIONS (30 MHz ~ 1 GHz)

### 8.5.1. 802.11b MODE

#### SPURIOUS EMISSIONS (LOW CHANNEL, WORST-CASE CONFIGURATION, HORIZONTAL)

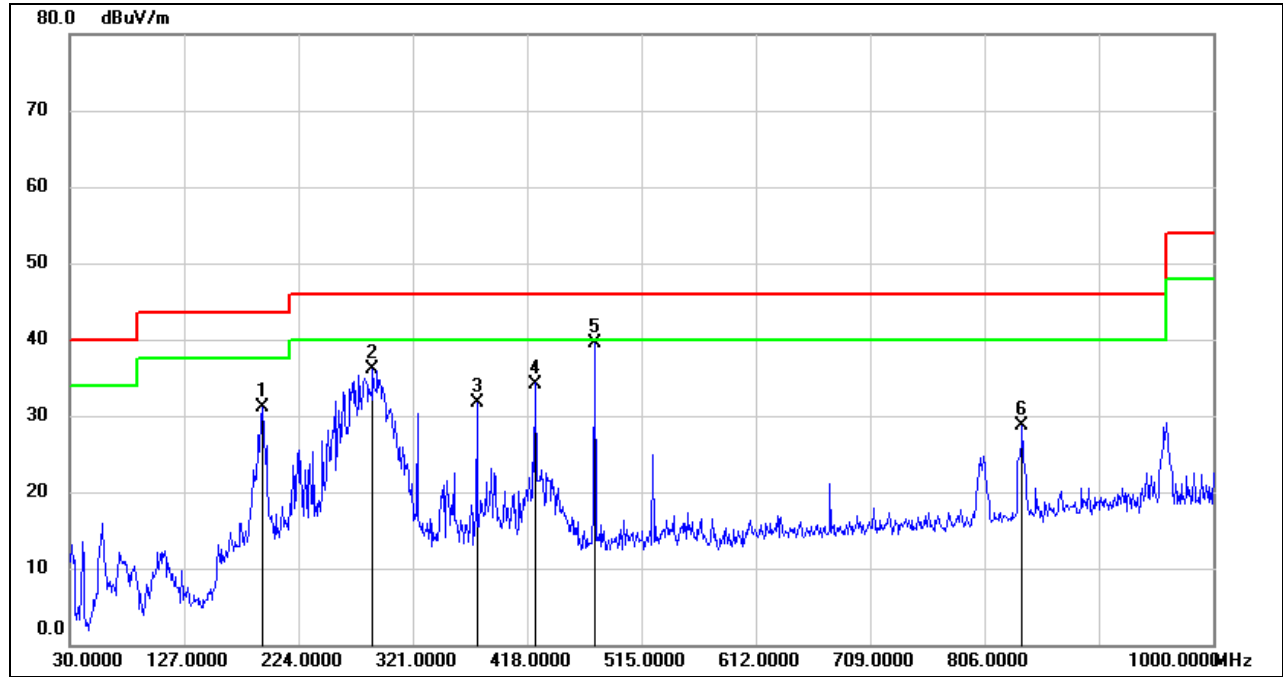

No.	Frequency (MHz)	Reading (dBuV)	Correct (dB/m)	Result (dBuV/m)	Limit (dBuV/m)	Margin (dB)	Remark
1	193.9299	47.53	-16.51	31.02	43.50	-12.48	QP
2	287.0500	52.32	-16.14	36.18	46.00	-9.82	QP
3	375.3200	45.50	-13.79	31.71	46.00	-14.29	QP
4	424.7900	47.06	-12.86	34.20	46.00	-11.80	QP
5	475.2300	51.49	-11.90	39.59	46.00	-6.41	QP
6	838.0100	35.30	-6.52	28.78	46.00	-17.22	QP

- Note: 1. Result Level = Read Level + Correct Factor.  
 2. If Peak Result complies with QP limit, QP Result is deemed to comply with QP limit.  
 3. Test setup: RBW: 120 kHz, VBW: 300 kHz, Sweep time: auto.

**SPURIOUS EMISSIONS (LOW CHANNEL, WORST-CASE CONFIGURATION, VERTICAL)**

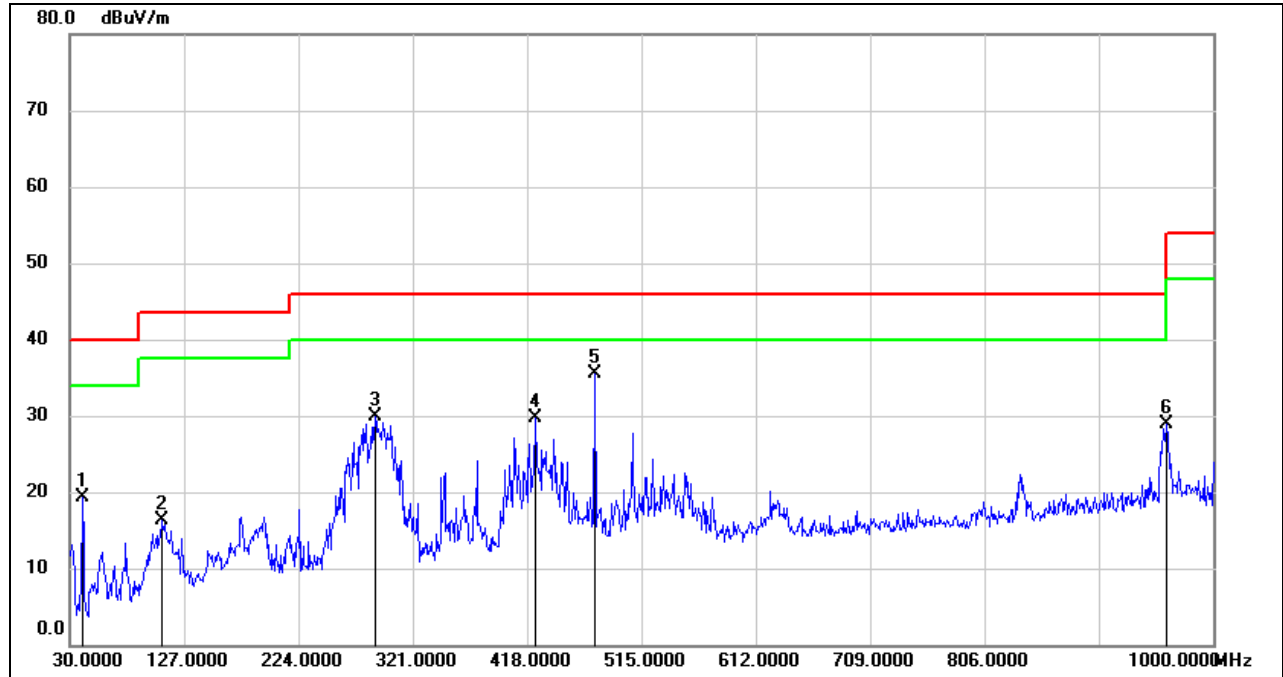

No.	Frequency (MHz)	Reading (dBuV)	Correct (dB/m)	Result (dBuV/m)	Limit (dBuV/m)	Margin (dB)	Remark
1	40.6699	39.36	-20.05	19.31	40.00	-20.69	QP
2	108.5700	36.85	-20.53	16.32	43.50	-27.18	QP
3	288.9900	45.79	-15.98	29.81	46.00	-16.19	QP
4	424.7900	42.55	-12.86	29.69	46.00	-16.31	QP
5	475.2300	47.35	-11.90	35.45	46.00	-10.55	QP
6	960.2300	33.36	-4.54	28.82	54.00	-25.18	QP

- Note: 1. Result Level = Read Level + Correct Factor.  
 2. If Peak Result complies with QP limit, QP Result is deemed to comply with QP limit.  
 3. Test setup: RBW: 120 kHz, VBW: 300 kHz, Sweep time: auto

Note: All the modes and channels had been tested, but only the worst data was recorded in the report.

## 8.6. SPURIOUS EMISSIONS BELOW 30 MHz

### 8.6.1. 802.11b MODE

#### SPURIOUS EMISSIONS (LOW CHANNEL, LOOP ANTENNA FACE ON TO THE EUT, WORST-CASE CONFIGURATION)

9 kHz ~ 150 kHz

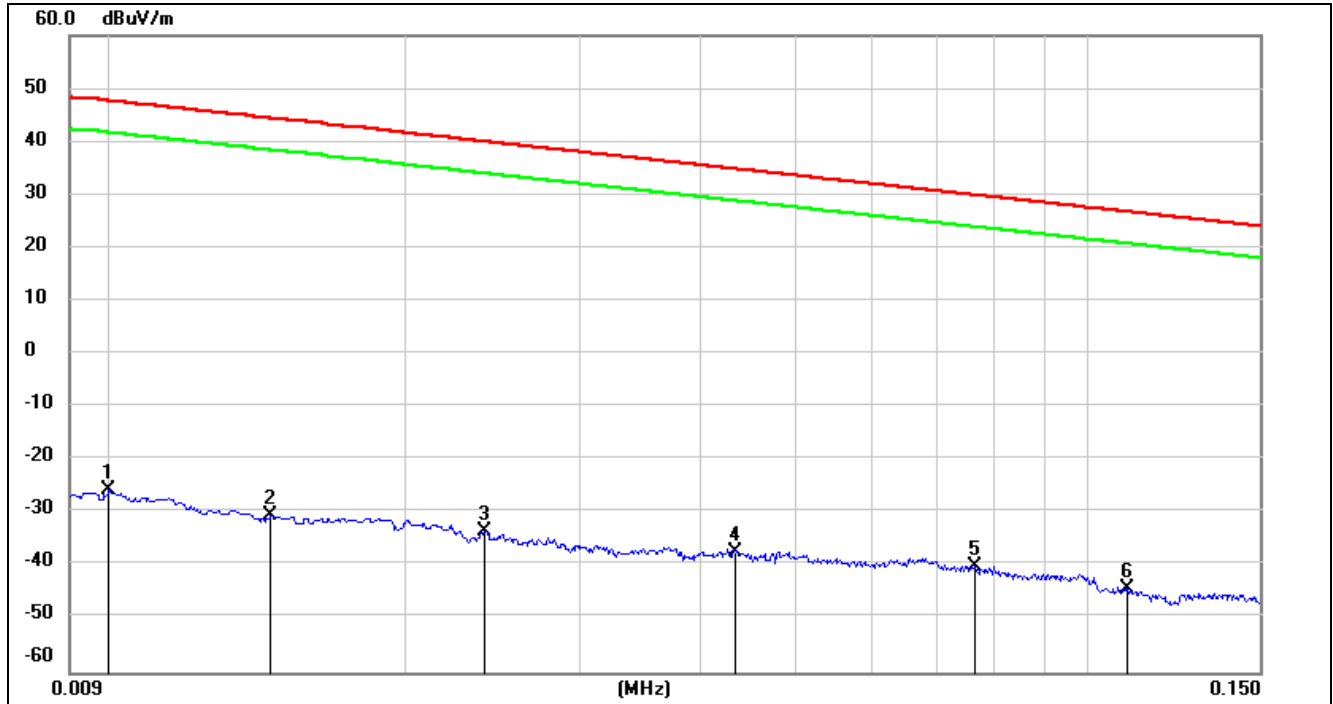

No.	Frequency (MHz)	Reading (dBuV)	Correct (dB/m)	FCC Result (dBuV/m)	FCC Limit (dBuV/m)	ISED Result (dBuA/m)	ISED Limit (dBuA/m)	Margin (dB)	Remark
1	0.0100	75.72	-101.40	-25.68	47.6	-77.18	-3.90	-73.28	peak
2	0.0145	71.05	-101.38	-30.33	44.37	-81.83	-7.13	-74.70	peak
3	0.0240	67.82	-101.36	-33.54	40	-85.04	-11.50	-73.54	peak
4	0.0434	64.11	-101.45	-37.34	34.85	-88.84	-16.65	-72.19	peak
5	0.0767	61.59	-101.61	-40.02	29.91	-91.52	-21.59	-69.93	peak
6	0.1100	57.42	-101.77	-44.35	26.78	-95.85	-24.72	-71.13	peak

Note: 1. Measurement = Reading Level + Correct Factor (dBuA/m= dBuV/m- 20Log10[120π] = dBuV/m- 51.5).

2. If Peak Result complies with AV and QP limit, AV and QP Result are deemed to comply with AV limit.

3. All 3 polarizations (Horizontal, Face-on and Face-off) of the loop antenna had been tested, but only the worst data recorded in the report.



**150 kHz ~ 490 kHz**

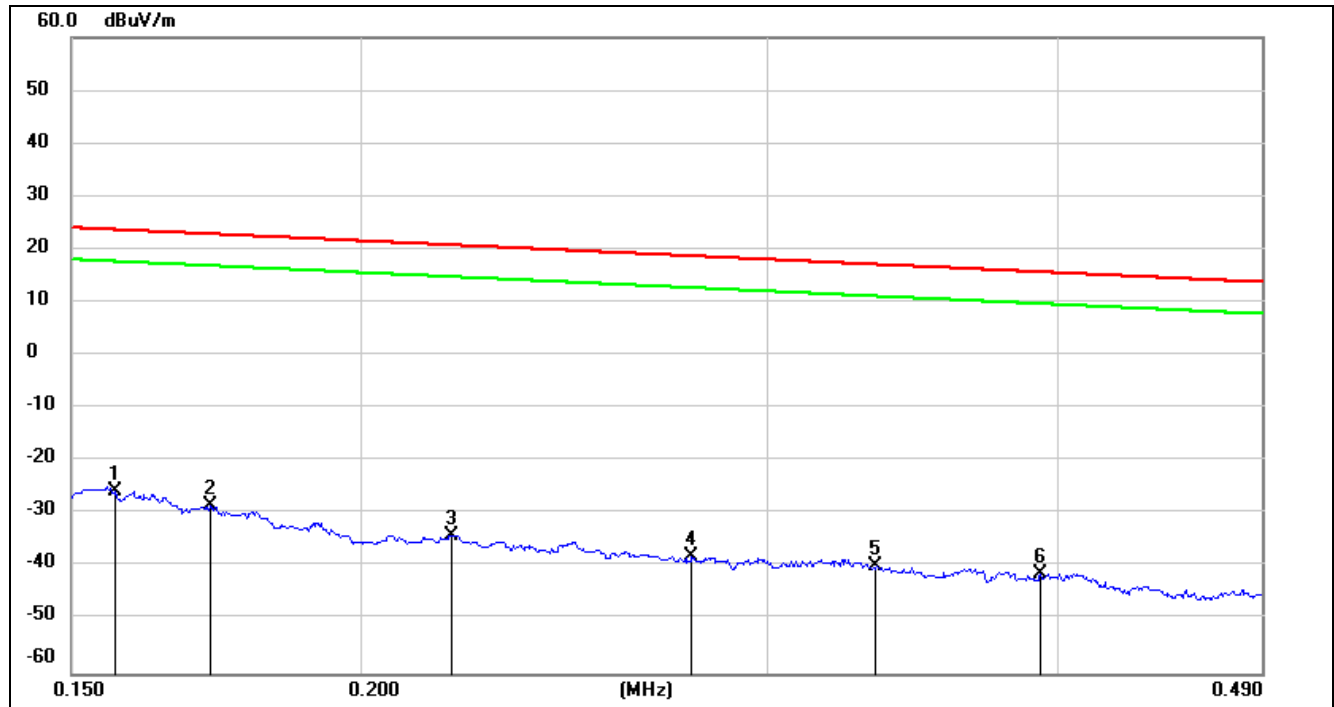

No.	Frequency (MHz)	Reading (dBuV)	Correct (dB/m)	FCC Result (dBuV/m)	FCC Limit (dBuV/m)	ISED Result (dBuA/m)	ISED Limit (dBuA/m)	Margin (dB)	Remark
1	0.1567	75.95	-101.65	-25.7	23.7	-77.20	-27.80	-49.40	peak
2	0.1720	73.19	-101.67	-28.48	22.9	-79.98	-28.60	-51.38	peak
3	0.2190	67.77	-101.75	-33.98	20.79	-85.48	-30.71	-54.77	peak
4	0.2782	63.79	-101.83	-38.04	18.71	-89.54	-32.79	-56.75	peak
5	0.3336	62.02	-101.89	-39.87	17.14	-91.37	-34.36	-57.01	peak
6	0.3933	60.72	-101.96	-41.24	15.71	-92.74	-35.79	-56.95	peak

Note: 1. Measurement = Reading Level + Correct Factor (dBuA/m= dBuV/m- 20Log10[120π] = dBuV/m- 51.5).

2. If Peak Result complies with AV and QP limit, AV and QP Result are deemed to comply with AV limit.

3. All 3 polarizations (Horizontal, Face-on and Face-off) of the loop antenna had been tested, but only the worst data recorded in the report.

**490 kHz ~ 30 MHz**

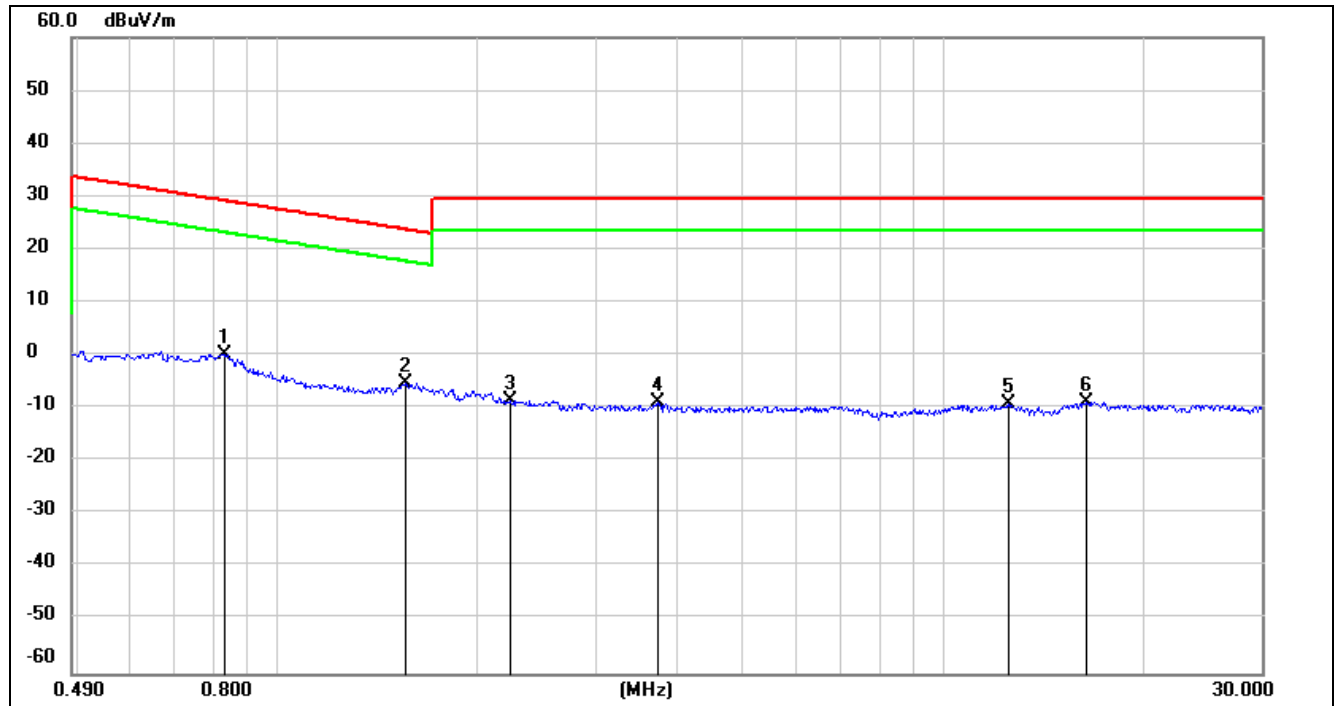

No.	Frequency (MHz)	Reading (dBuV)	Correct (dB/m)	FCC Result (dBuV/m)	FCC Limit (dBuV/m)	ISED Result (dBuA/m)	ISED Limit (dBuA/m)	Margin (dB)	Remark
1	0.8296	62.44	-62.17	0.27	29.23	-51.23	-22.27	-28.96	peak
2	1.5564	56.68	-62.02	-5.34	23.76	-56.84	-27.74	-29.10	peak
3	2.2364	53.30	-61.76	-8.46	29.54	-59.96	-21.96	-38.00	peak
4	3.7100	52.70	-61.41	-8.71	29.54	-60.21	-21.96	-38.25	peak
5	12.5006	51.82	-60.91	-9.09	29.54	-60.59	-21.96	-38.63	peak
6	16.3959	52.17	-60.96	-8.79	29.54	-60.29	-21.96	-38.33	peak

Note: 1. Measurement = Reading Level + Correct Factor (dBuA/m= dBuV/m- 20Log10[120π] = dBuV/m- 51.5).

2. If Peak Result complies with AV and QP limit, AV and QP Result are deemed to comply with AV limit.

3. All 3 polarizations (Horizontal, Face-on and Face-off) of the loop antenna had been tested, but only the worst data recorded in the report.

Note: All the modes and channels had been tested, but only the worst data was recorded in the report.

## 9. AC POWER LINE CONDUCTED EMISSIONS

### LIMITS

Please refer to CFR 47 FCC §15.207 (a) and ISED RSS-Gen Clause 8.8

FREQUENCY (MHz)	Quasi-peak	Average
0.15 -0.5	66 - 56 *	56 - 46 *
0.50 -5.0	56.00	46.00
5.0 -30.0	60.00	50.00

### TEST SETUP AND PROCEDURE

Refer to ANSI C63.10-2013 clause 6.2.

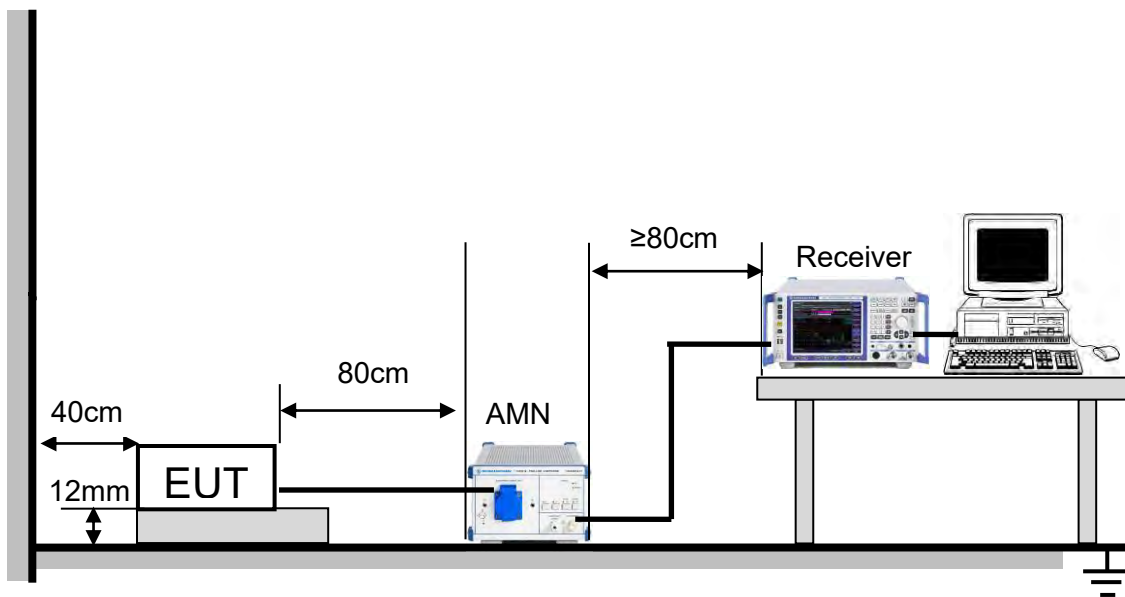

The EUT is put on a table of non-conducting material that is 12 mm high. The vertical conducting wall of shielding is located 40 cm to the rear of the EUT. The power line of the EUT is connected to the AC mains through a Artificial Mains Network (A.M.N.). A EMI Measurement Receiver (R&S Test Receiver ESR3) is used to test the emissions from both sides of AC line. According to the requirements in Section 6.2 of ANSI C63.10-2013. Conducted emissions from the EUT measured in the frequency range between 0.15 MHz and 30 MHz using CISPR Quasi-Peak and average detector mode. The bandwidth of EMI test receiver is set at 9 kHz.

The arrangement of the equipment is installed to meet the standards and operating in a manner, which tends to maximize its emission characteristics in a normal application.



**TEST ENVIRONMENT**

Temperature	21.6 °C	Relative Humidity	52.4 %
Atmosphere Pressure	101 kPa	Test Voltage	AC 120 V, 60 Hz

**RESULTS**

**9.1.1. 802.11b MODE**

**LINE L RESULTS (LOW CHANNEL, WORST-CASE CONFIGURATION)**

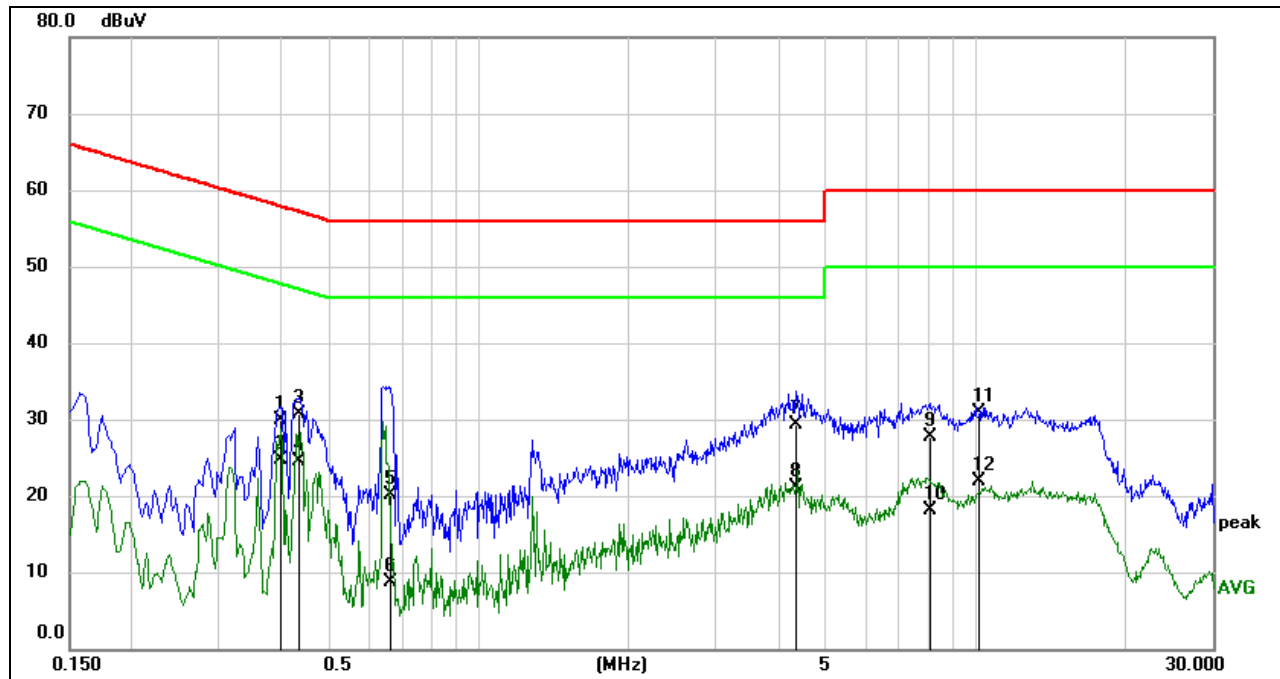

No.	Frequency (MHz)	Reading (dBuV)	Correct (dB)	Result (dBuV)	Limit (dBuV)	Margin (dB)	Remark
1	0.4000	20.58	9.39	29.97	57.85	-27.88	QP
2	0.4000	15.34	9.39	24.73	47.85	-23.12	AVG
3	0.4350	21.34	9.36	30.70	57.16	-26.46	QP
4	0.4350	15.20	9.36	24.56	47.16	-22.60	AVG
5	0.6673	10.62	9.55	20.17	56.00	-35.83	QP
6	0.6673	-0.80	9.55	8.75	46.00	-37.25	AVG
7	4.3580	19.69	9.60	29.29	56.00	-26.71	QP
8	4.3580	11.51	9.60	21.11	46.00	-24.89	AVG
9	8.0577	18.14	9.64	27.78	60.00	-32.22	QP
10	8.0577	8.51	9.64	18.15	50.00	-31.85	AVG
11	10.0952	21.13	9.72	30.85	60.00	-29.15	QP
12	10.0952	12.19	9.72	21.91	50.00	-28.09	AVG

Note: 1. Result = Reading +Correct Factor.  
2. If QP Result complies with AV limit, AV Result is deemed to comply with AV limit.

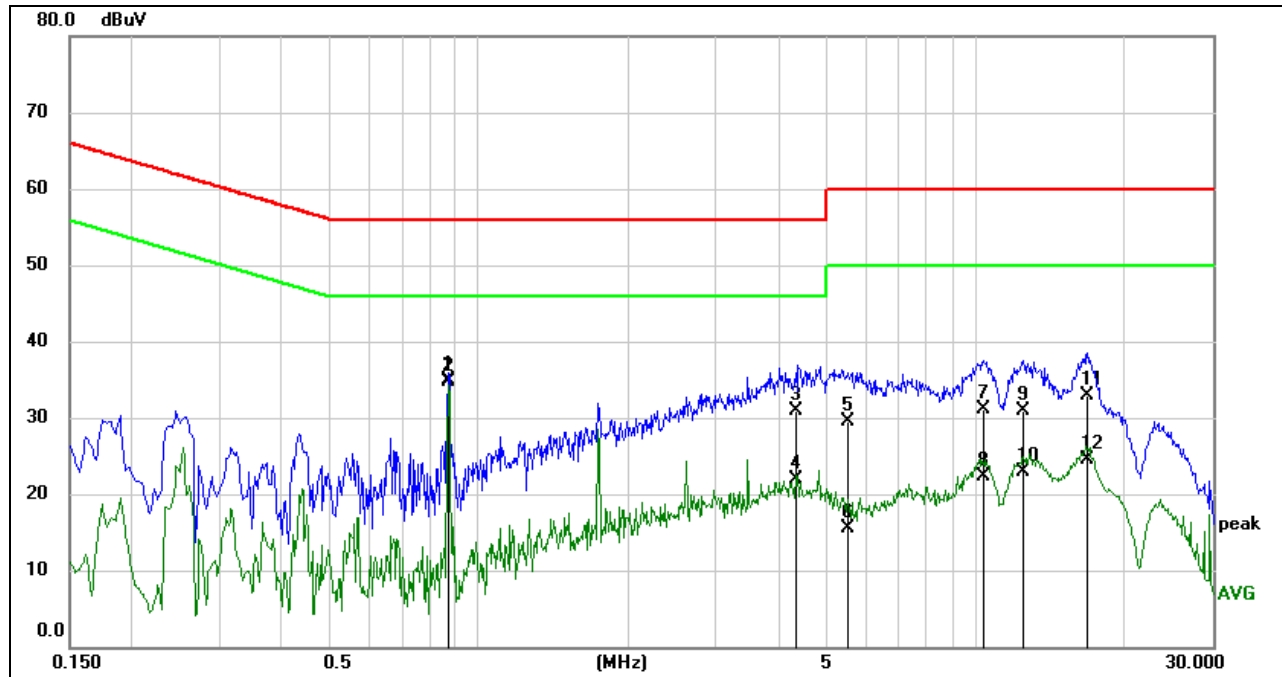

- 
3. Test setup: RBW: 200 Hz (9 kHz ~ 150 kHz), 9 kHz (150 kHz ~ 30 MHz).
  4. Step size: 80 Hz (0.009 MHz ~ 0.15 MHz), 4 kHz (0.15 MHz ~ 30 MHz), Scan time: auto.

**LINE N RESULTS (LOW CHANNEL, WORST-CASE CONFIGURATION)**

No.	Frequency (MHz)	Reading (dBuV)	Correct (dB)	Result (dBuV)	Limit (dBuV)	Margin (dB)	Remark
1	0.8722	25.37	9.60	34.97	56.00	-21.03	QP
2	0.8722	25.04	9.60	34.64	46.00	-11.36	AVG
3	4.3576	21.33	9.60	30.93	56.00	-25.07	QP
4	4.3576	12.36	9.60	21.96	46.00	-24.04	AVG
5	5.5200	19.95	9.63	29.58	60.00	-30.42	QP
6	5.5200	5.89	9.63	15.52	50.00	-34.48	AVG
7	10.3610	21.40	9.72	31.12	60.00	-28.88	QP
8	10.3610	12.49	9.72	22.21	50.00	-27.79	AVG
9	12.4680	21.13	9.76	30.89	60.00	-29.11	QP
10	12.4680	13.11	9.76	22.87	50.00	-27.13	AVG
11	16.7658	23.19	9.73	32.92	60.00	-27.08	QP
12	16.7658	14.75	9.73	24.48	50.00	-25.52	AVG

Note: 1. Result = Reading +Correct Factor.

2. If QP Result complies with AV limit, AV Result is deemed to comply with AV limit.

3. Test setup: RBW: 200 Hz (9 kHz ~ 150 kHz), 9 kHz (150 kHz ~ 30 MHz).

4. Step size: 80 Hz (0.009 MHz ~ 0.15 MHz), 4 kHz (0.15 MHz ~ 30 MHz), Scan time: auto.

Note: All the modes and channels had been tested, but only the worst data was recorded in the report.



## 10. ANTENNA REQUIREMENTS

### APPLICABLE REQUIREMENTS

Please refer to FCC §15.203

An intentional radiator shall be designed to ensure that no antenna other than that furnished by the responsible party shall be used with the device. The use of a permanently attached antenna or of an antenna that uses a unique coupling to the intentional radiator shall be considered sufficient to comply with the provisions of this section. The manufacturer may design the unit so that a broken antenna can be replaced by the user, but the use of a standard antenna jack or electrical connector is prohibited.

Please refer to FCC §15.247(b)(4)

The conducted output power limit specified in paragraph (b) of this section is based on the use of antennas with directional gains that do not exceed 6 dBi. Except as shown in paragraph (c) of this section, if transmitting antennas of directional gain greater than 6 dBi are used, the conducted output power from the intentional radiator shall be reduced below the stated values in paragraphs (b)(1), (b)(2), and (b)(3) of this section, as appropriate, by the amount in dB that the directional gain of the antenna exceeds 6 dBi.

### RESULTS

Complies



## 11. Appendix

### 11.1. Appendix A: DTS Bandwidth

#### 11.1.1. Test Result

Test Mode	Antenna	Channel	DTS BW [MHz]	FL[MHz]	FH[MHz]	Limit[MHz]	Verdict
11B	Ant1	2412	10.040	2407.000	2417.040	0.5	PASS
		2437	10.040	2432.000	2442.040	0.5	PASS
		2462	10.040	2457.000	2467.040	0.5	PASS
11G	Ant1	2412	16.360	2403.840	2420.200	0.5	PASS
		2437	16.320	2428.840	2445.160	0.5	PASS
		2462	16.320	2453.840	2470.160	0.5	PASS
11N20SISO	Ant1	2412	17.560	2403.200	2420.760	0.5	PASS
		2437	17.560	2428.200	2445.760	0.5	PASS
		2462	17.560	2453.200	2470.760	0.5	PASS
11N40SISO	Ant1	2422	35.120	2404.480	2439.600	0.5	PASS
		2437	35.040	2419.480	2454.520	0.5	PASS
		2452	35.120	2434.480	2469.600	0.5	PASS



11.1.2. Test Graphs



11B Ant1 2412



11B Ant1 2437



11B Ant1 2462



11G Ant1 2412



11G Ant1 2437



11G Ant1 2462



11N20SISO Ant1\_2412

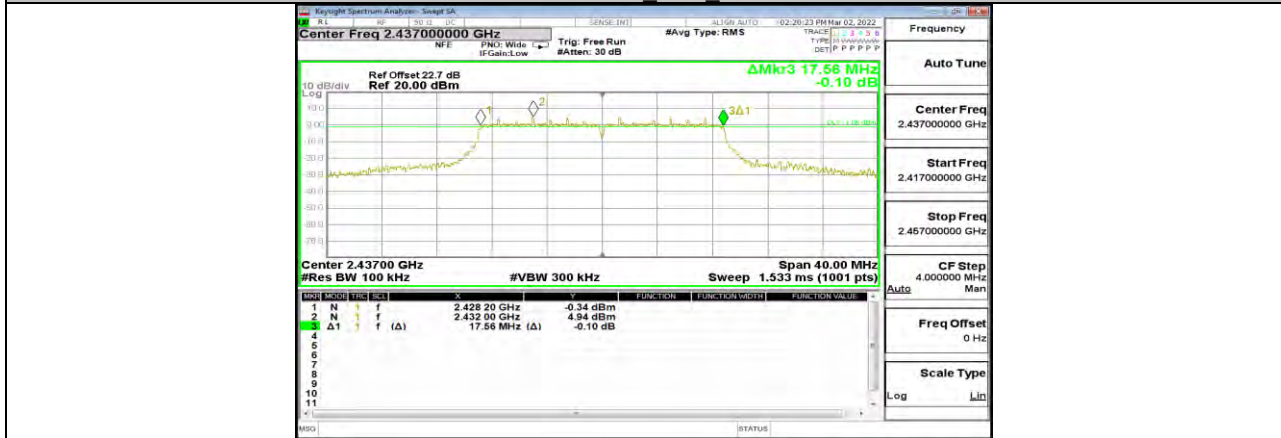

11N20SISO Ant1\_2437



11N20SISO Ant1\_2462



11N40SISO Ant1\_2422

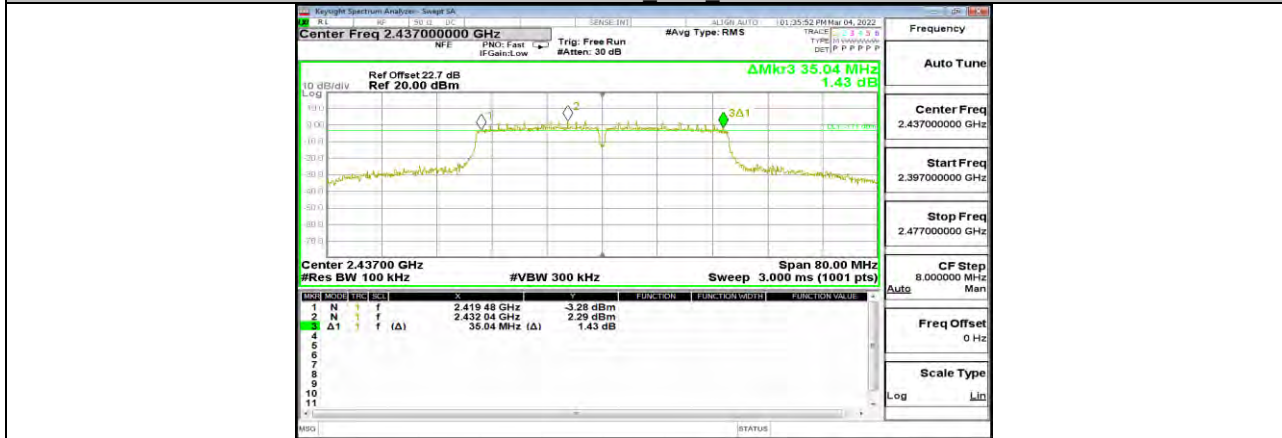

11N40SISO Ant1\_2437

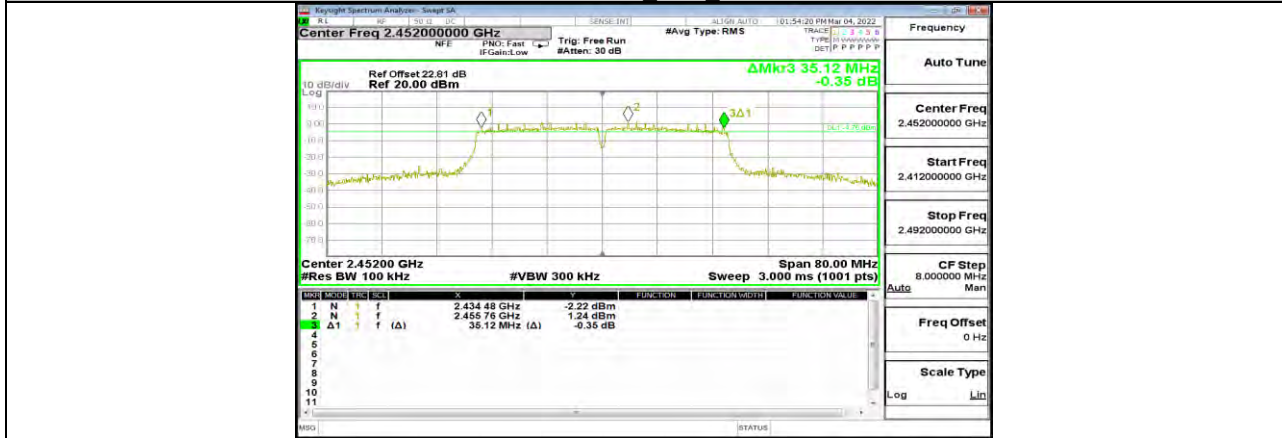

11N40SISO Ant1\_2452



## 11.2. Appendix B: Occupied Channel Bandwidth

### 11.2.1. Test Result

Test Mode	Antenna	Channel	OCB [MHz]	FL[MHz]	FH[MHz]	Verdict
11B	Ant1	2412	15.146	2404.467	2419.613	PASS
		2437	15.152	2429.437	2444.589	PASS
		2462	15.169	2454.425	2469.594	PASS
11G	Ant1	2412	17.330	2403.380	2420.710	PASS
		2437	17.647	2428.142	2445.789	PASS
		2462	17.293	2453.358	2470.651	PASS
11N20SISO	Ant1	2412	18.144	2402.908	2421.052	PASS
		2437	18.502	2427.728	2446.230	PASS
		2462	18.227	2452.913	2471.140	PASS
11N40SISO	Ant1	2422	36.358	2403.878	2440.236	PASS
		2437	36.645	2418.732	2455.377	PASS
		2452	36.421	2433.849	2470.270	PASS



11.2.2. Test Graphs



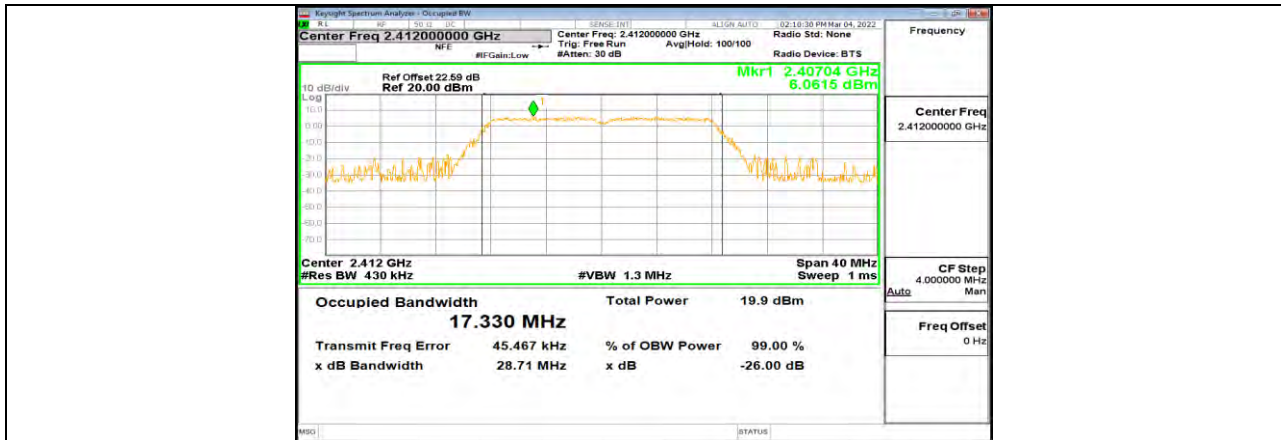

11G Ant1 2412

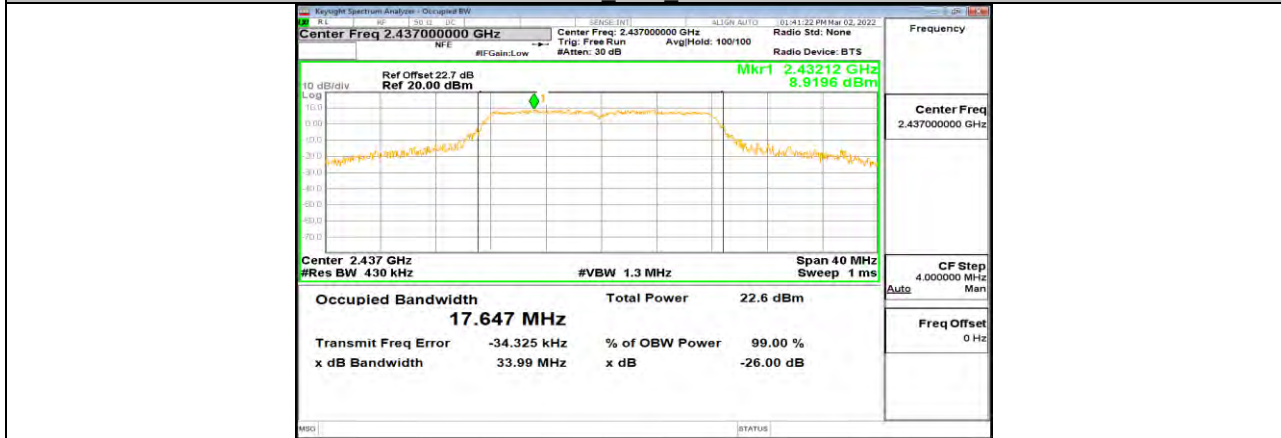

11G Ant1 2437

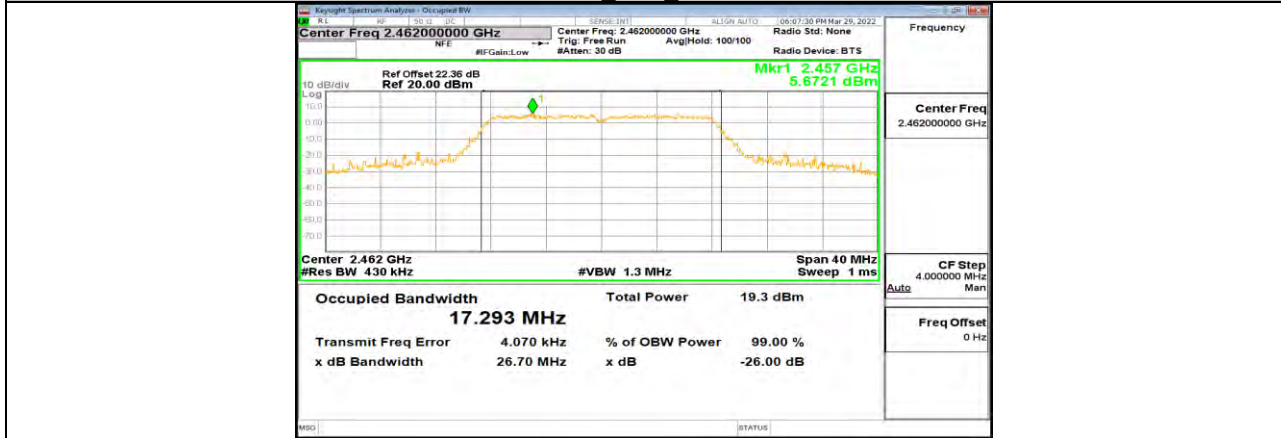

11G Ant1 2462

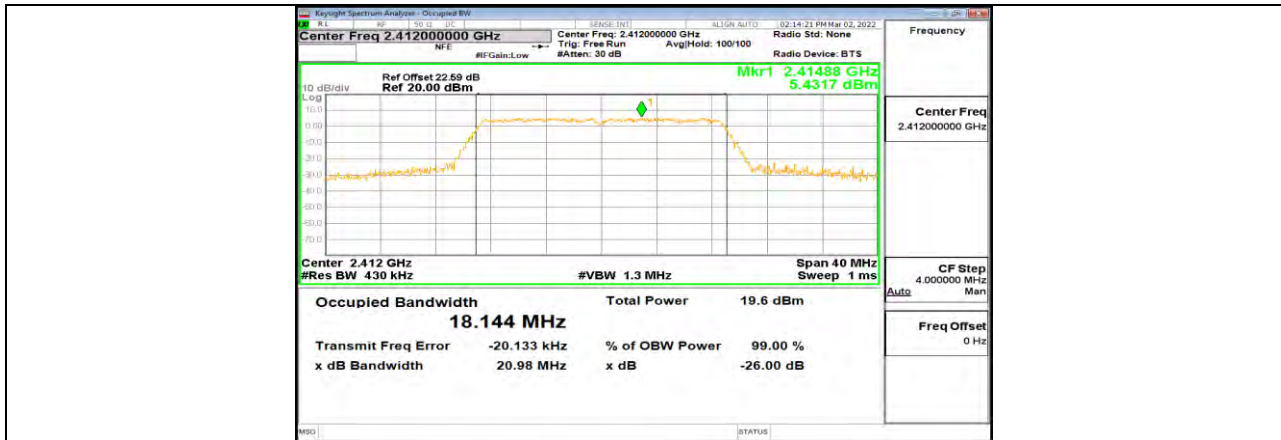

11N20SISO Ant1\_2412

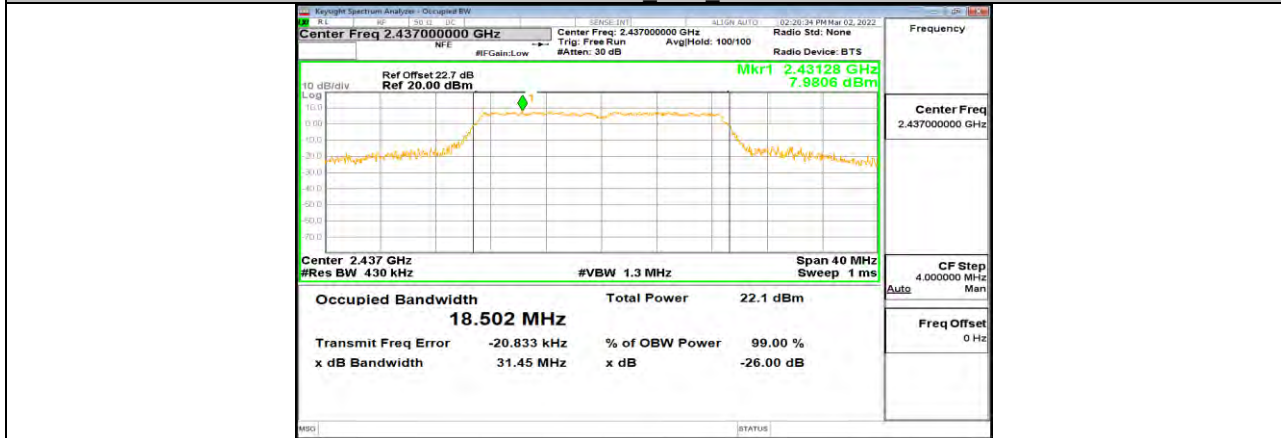

11N20SISO Ant1\_2437

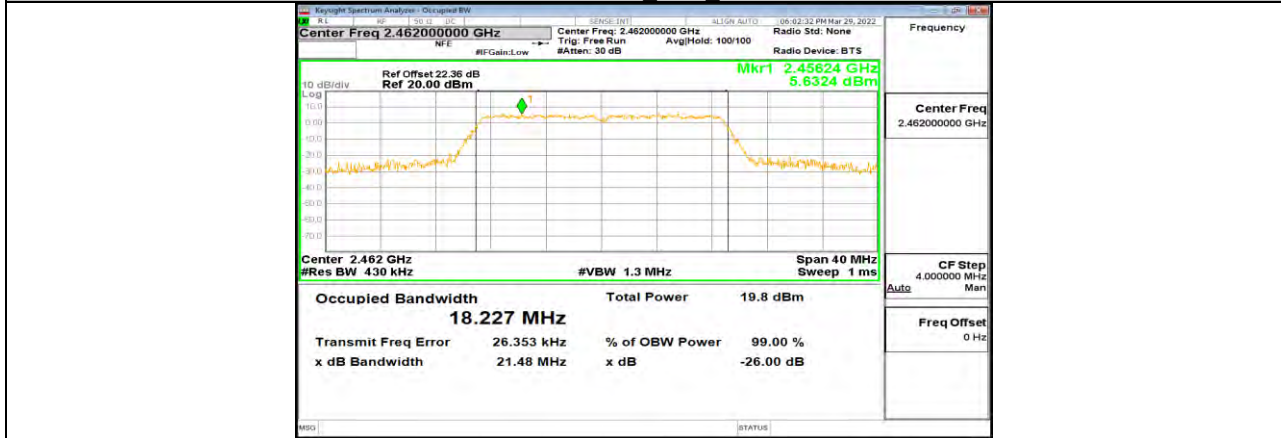

11N20SISO Ant1\_2462



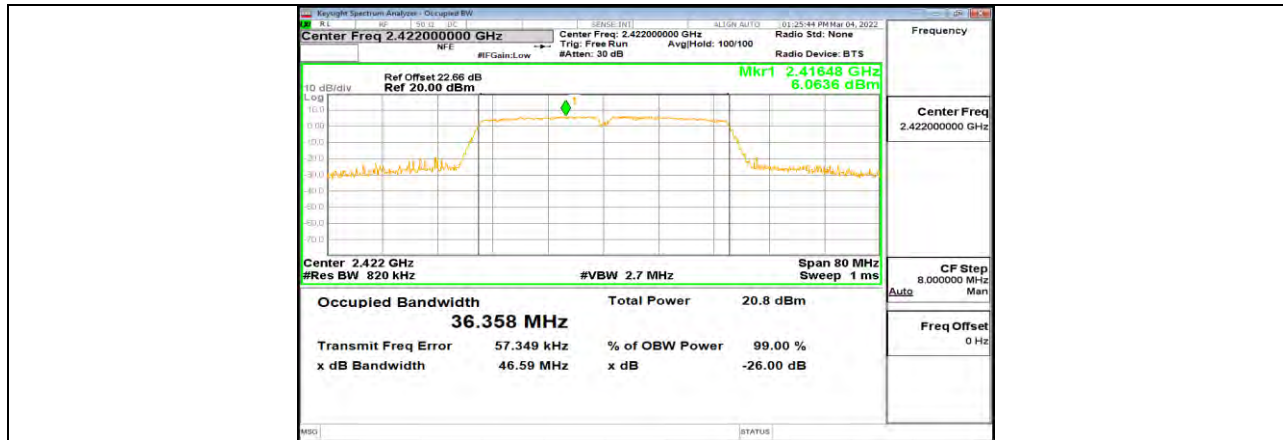

11N40SISO Ant1\_2422

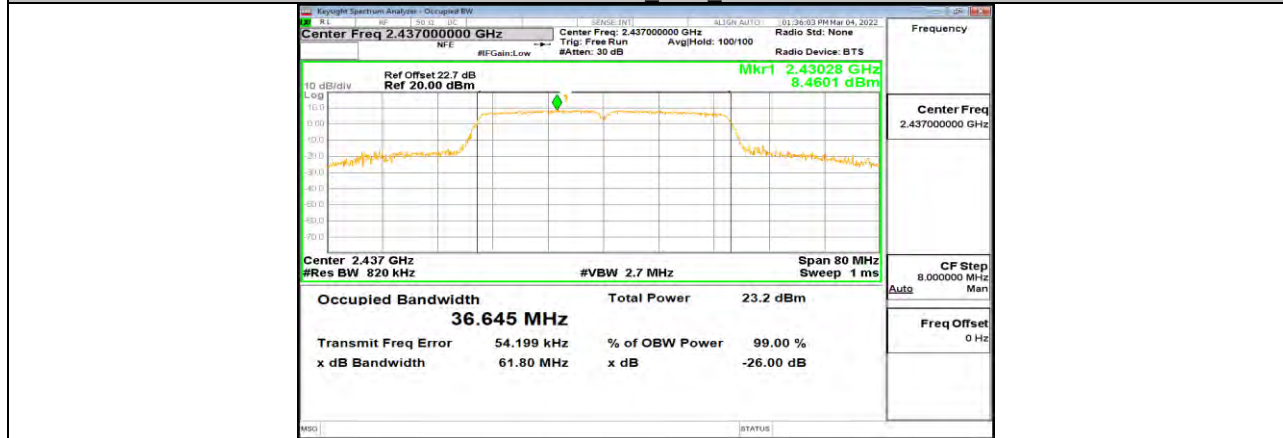

11N40SISO Ant1\_2437

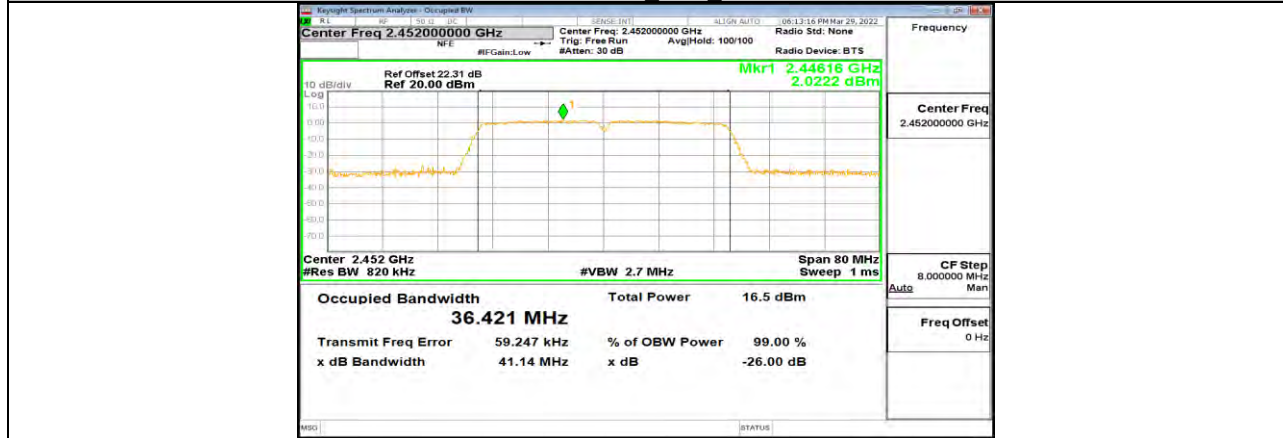

11N40SISO Ant1\_2452



### 11.3. Appendix C: Maximum conducted output power

#### 11.3.1. Test Result

Test Mode	Antenna	Channel	Result[dBm]	Limit[dBm]	Verdict
11B	Ant1	2412	17.12	≤30.00	PASS
		2437	17.07	≤30.00	PASS
		2462	16.87	≤30.00	PASS
11G	Ant1	2412	13.82	≤30.00	PASS
		2437	13.43	≤30.00	PASS
		2462	13.31	≤30.00	PASS
11N20SISO	Ant1	2412	13.38	≤30.00	PASS
		2437	13.71	≤30.00	PASS
		2462	13.67	≤30.00	PASS
11N40SISO	Ant1	2422	9.64	≤30.00	PASS
		2437	9.58	≤30.00	PASS
		2452	9.65	≤30.00	PASS

Note: 1. Conducted Power=Meas. Level+ Correction Factor

2. The Duty Cycle Factor (refer to section 7.1) had already compensated to the test data.



## 11.4. Appendix D: Maximum power spectral density

### 11.4.1. Test Result

Test Mode	Antenna	Channel	Result[dBm/3kHz]	Limit[dBm/3kHz]	Verdict
11B	Ant1	2412	-14.45	≤8.00	PASS
		2437	-14.49	≤8.00	PASS
		2462	-14.75	≤8.00	PASS
11G	Ant1	2412	-18.48	≤8.00	PASS
		2437	-18.68	≤8.00	PASS
		2462	-19.25	≤8.00	PASS
11N20SISO	Ant1	2412	-19.85	≤8.00	PASS
		2437	-19.54	≤8.00	PASS
		2462	-19.74	≤8.00	PASS
11N40SISO	Ant1	2422	-25.59	≤8.00	PASS
		2437	-25.66	≤8.00	PASS
		2452	-25.18	≤8.00	PASS

Note:

1. The Duty Cycle Factor has compensated to the Graph.

### 11.4.2. Test Graphs

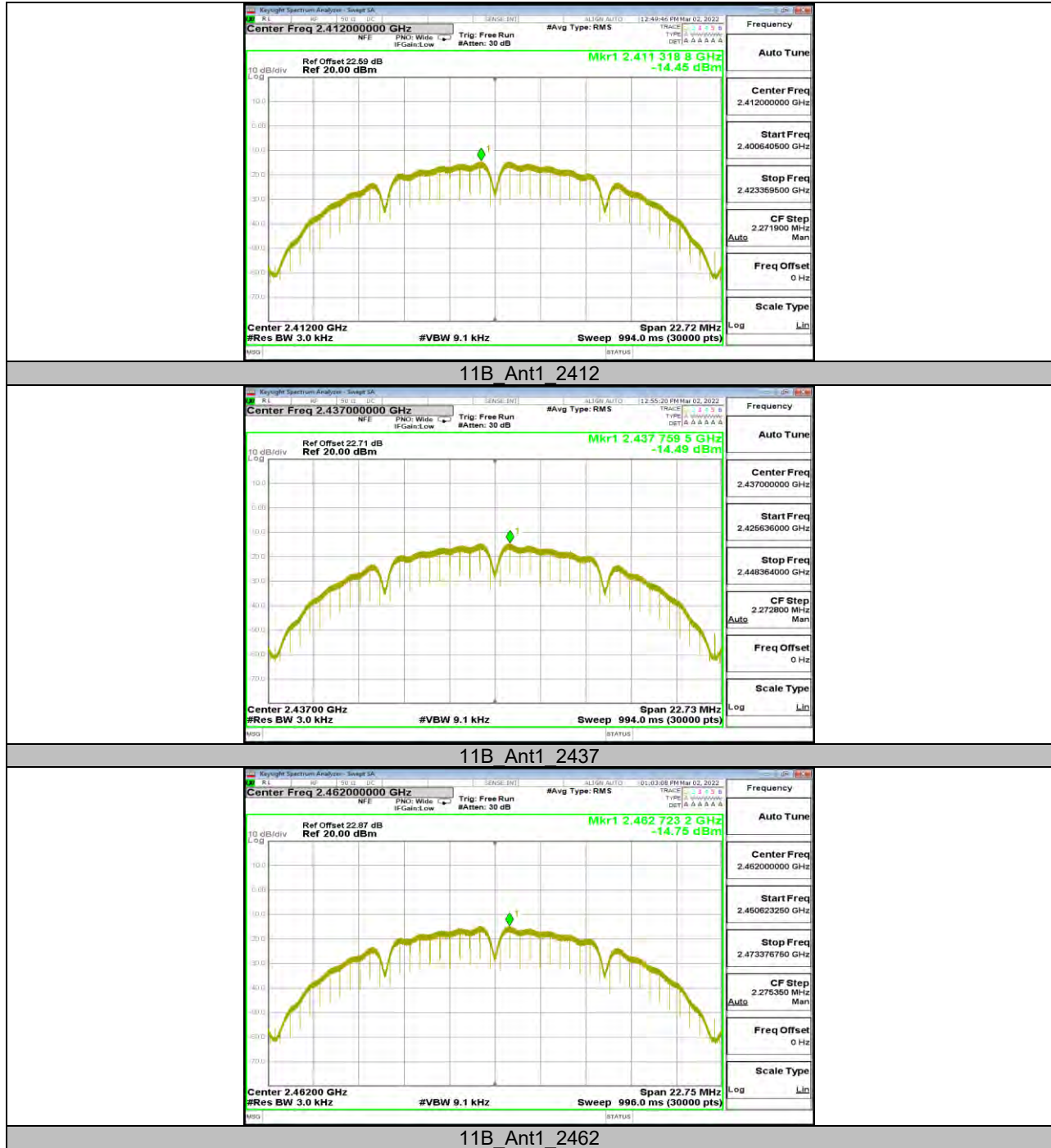

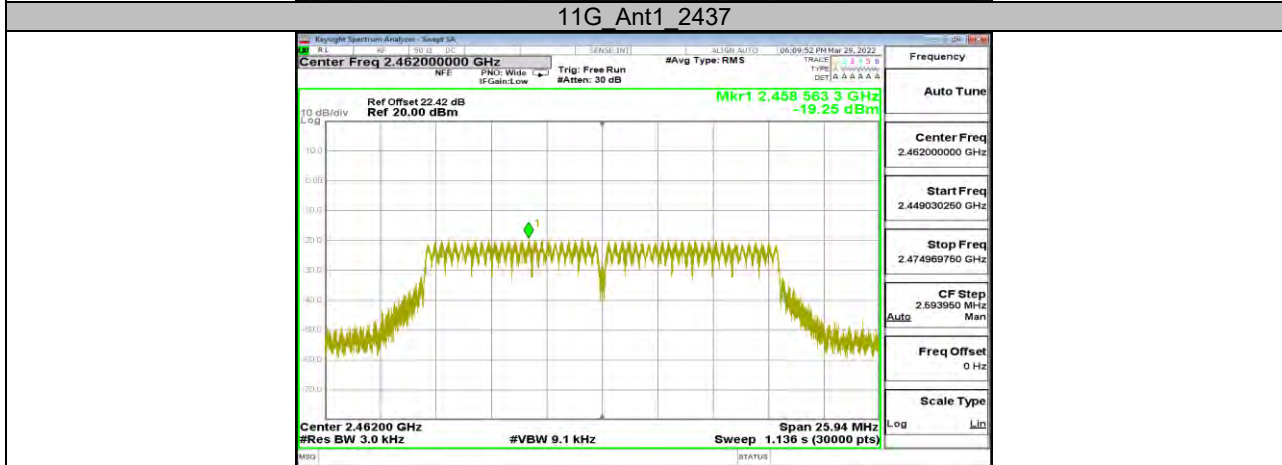

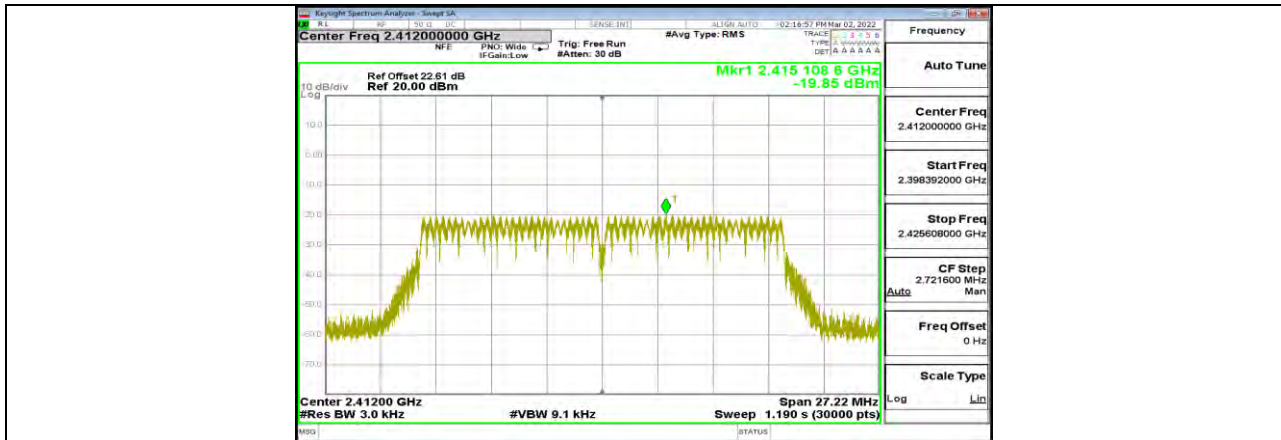

11N20SISO Ant1\_2412



11N20SISO Ant1\_2437



11N20SISO Ant1\_2462

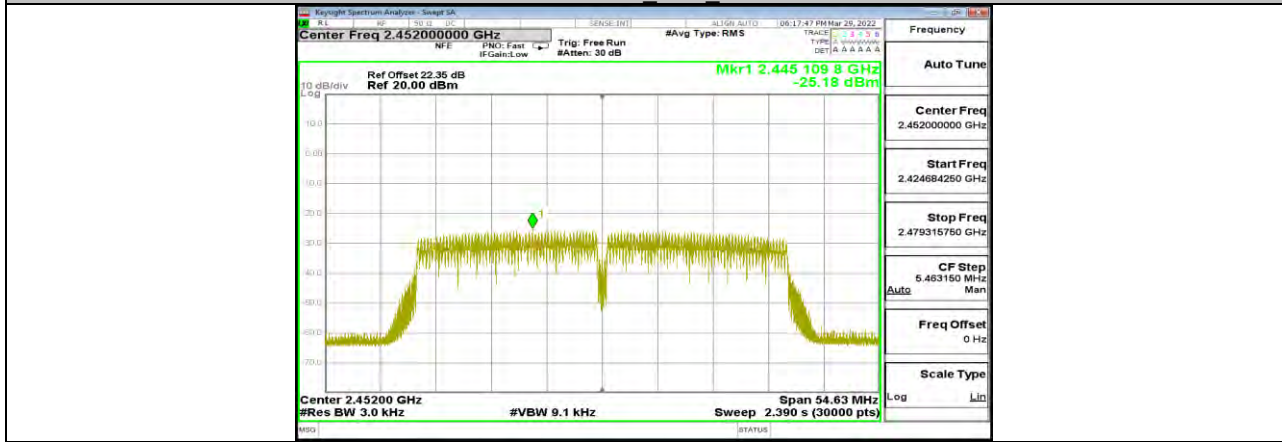
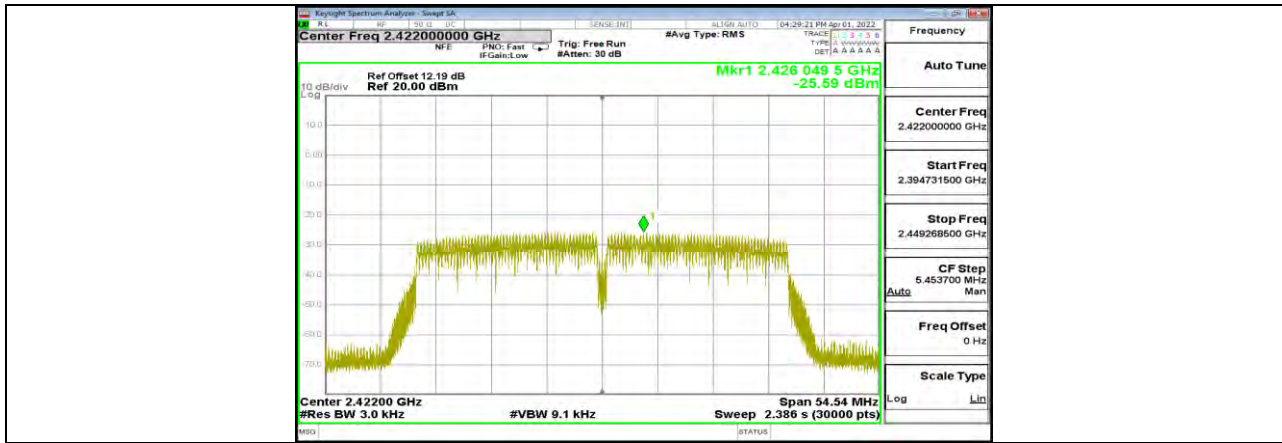



## 11.5. Appendix E: Band edge measurements

### 11.5.1. Test Result

Test Mode	Antenna	ChName	Channel	RefLevel[dBm]	Result[dBm]	Limit[dBm]	Verdict
11B	Ant1	Low	2412	7.13	-26.07	≤-22.87	PASS
		High	2462	6.91	-36.99	≤-23.09	PASS
11G	Ant1	Low	2412	2.22	-28.53	≤-27.78	PASS
		High	2462	5.05	-30.65	≤-24.95	PASS
11N20SISO	Ant1	Low	2412	2.02	-32.25	≤-27.98	PASS
		High	2462	4.44	-31.84	≤-25.56	PASS
11N40SISO	Ant1	Low	2422	-4.44	-40.82	≤-34.44	PASS
		High	2452	-4.52	-41.94	≤-34.52	PASS



### 11.5.2. Test Graphs



11B Ant1 Low 2412



11B Ant1 High 2462

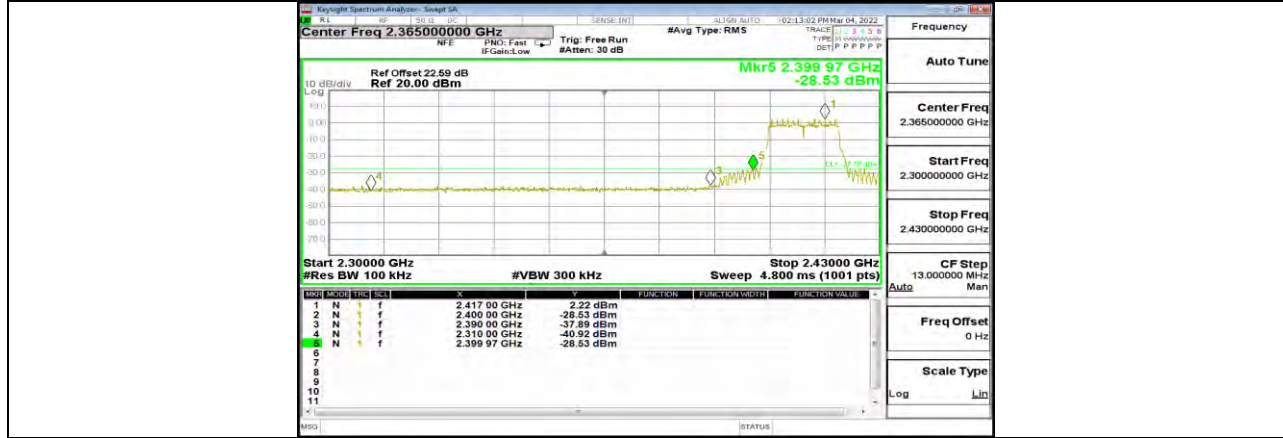

11G Ant1 Low 2412



11G Ant1 High 2462

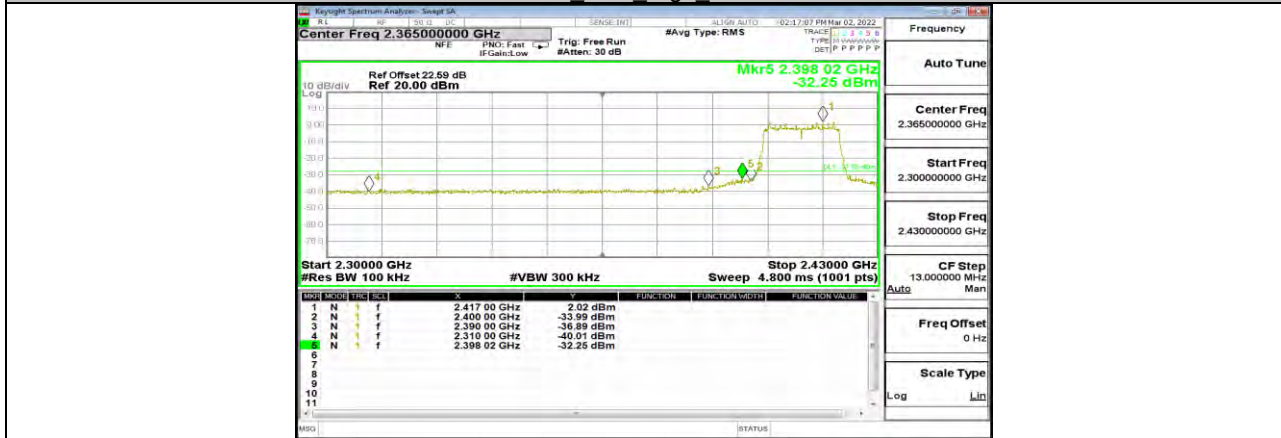

11N20SISO Ant1 Low 2412



11N20SISO Ant1 High 2462

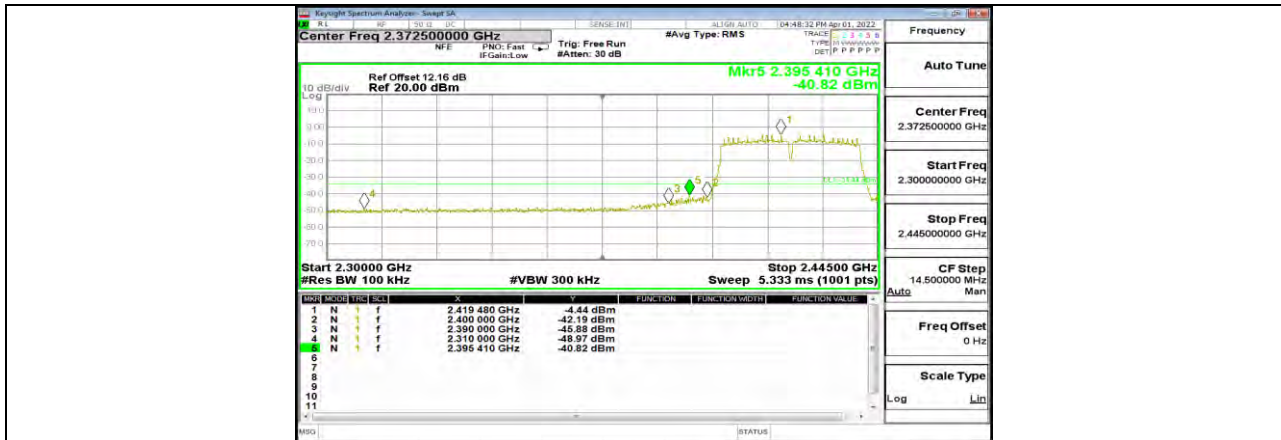

11N40SISO Ant1 Low 2422

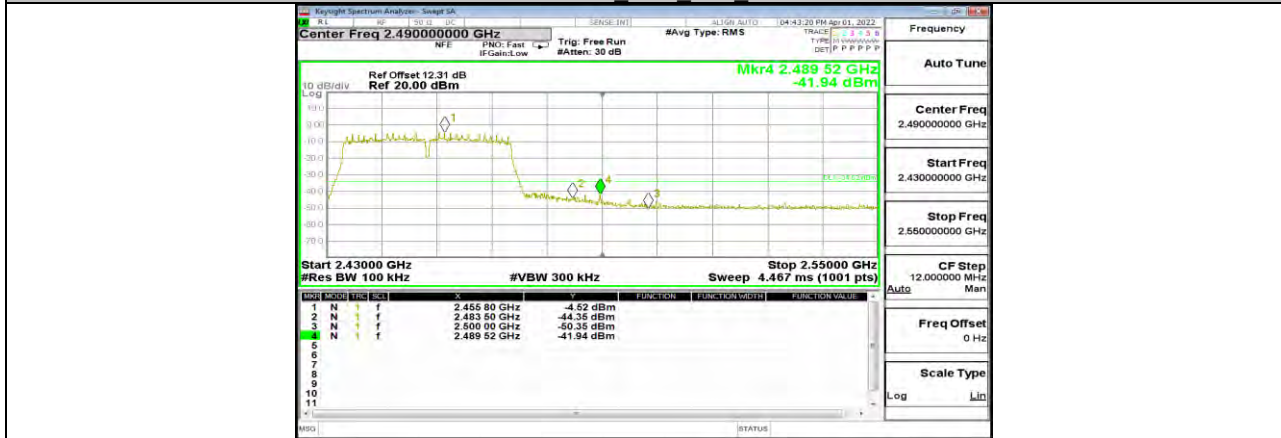

11N40SISO Ant1 High 2452

**11.6. Appendix F: Conducted Spurious Emission****11.6.1. Test Result**

Test Mode	Antenna	Channel	FreqRange [Mhz]	Result [dBm]	Limit [dBm]	Verdict
11B	Ant1	2412	Reference	7.14	---	PASS
			30~1000	-49.64	≤-22.86	PASS
			1000~26500	-41.87	≤-22.86	PASS
		2437	Reference	7.12	---	PASS
			30~1000	-49.69	≤-22.88	PASS
			1000~26500	-40.87	≤-22.88	PASS
		2462	Reference	6.87	---	PASS
			30~1000	-49.08	≤-23.13	PASS
			1000~26500	-41.7	≤-23.13	PASS
11G	Ant1	2412	Reference	2.29	---	PASS
			30~1000	-48.9	≤-27.71	PASS
			1000~26500	-41.48	≤-27.71	PASS
		2437	Reference	5.39	---	PASS
			30~1000	-49.38	≤-24.61	PASS
			1000~26500	-40.89	≤-24.61	PASS
		2462	Reference	5.17	---	PASS
			30~1000	-48.63	≤-24.83	PASS
			1000~26500	-40.6	≤-24.83	PASS
11N20SISO	Ant1	2412	Reference	2.01	---	PASS
			30~1000	-49.16	≤-27.99	PASS
			1000~26500	-40.53	≤-27.99	PASS
		2437	Reference	4.93	---	PASS
			30~1000	-48.86	≤-25.07	PASS
			1000~26500	-41.24	≤-25.07	PASS
		2462	Reference	4.72	---	PASS
			30~1000	-49.37	≤-25.28	PASS
			1000~26500	-41.1	≤-25.28	PASS
11N40SISO	Ant1	2422	Reference	-4.43	---	PASS
			30~1000	-59.4	≤-34.43	PASS
			1000~26500	-50.47	≤-34.43	PASS
		2437	Reference	-4.59	---	PASS
			30~1000	-59.42	≤-24.59	PASS
			1000~26500	-51.85	≤-24.59	PASS
		2452	Reference	-4.61	---	PASS
			30~1000	-59.53	≤-34.61	PASS
			1000~26500	-51.64	≤-34.61	PASS

### 11.6.2. Test Graphs

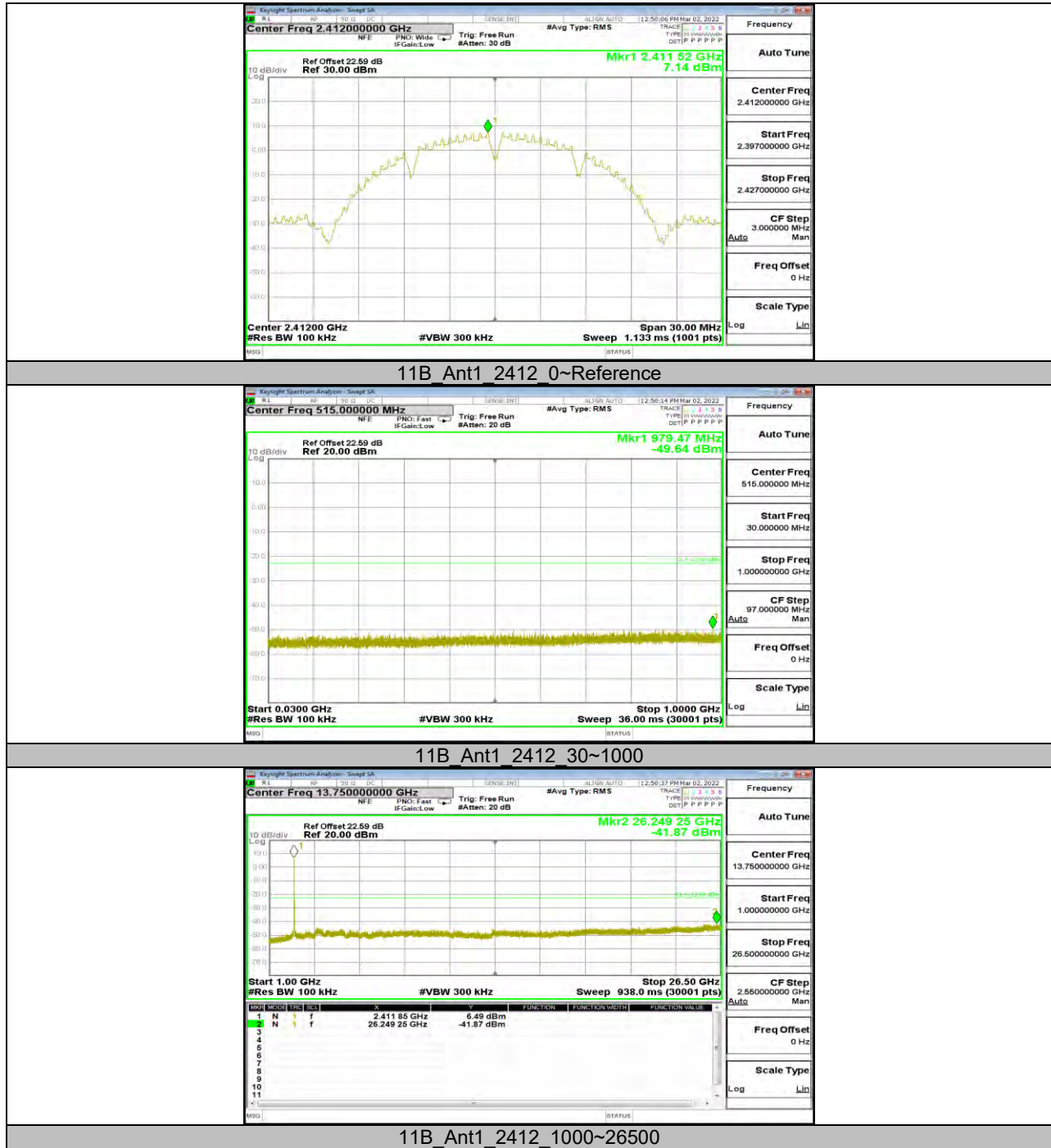

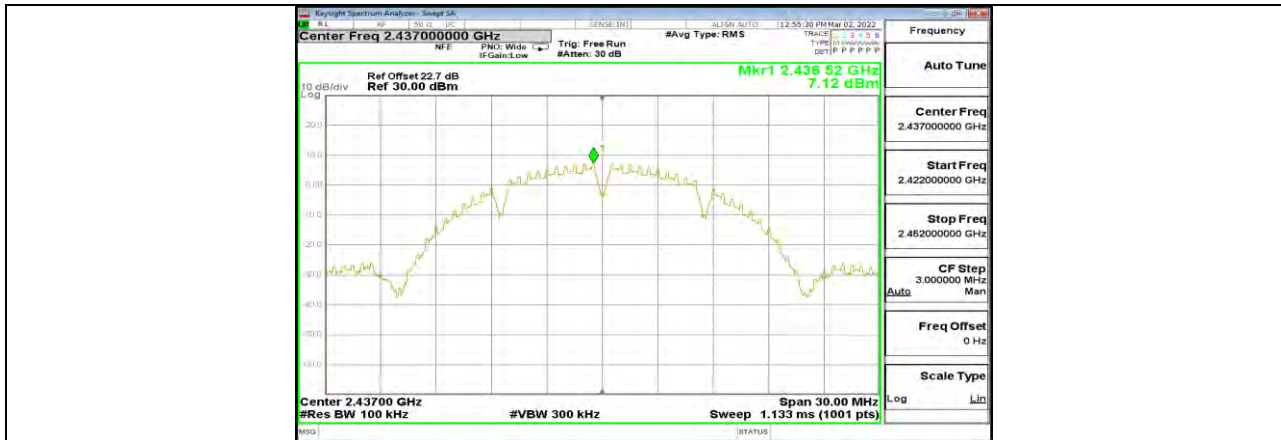

11B Ant1 2437 0~Reference

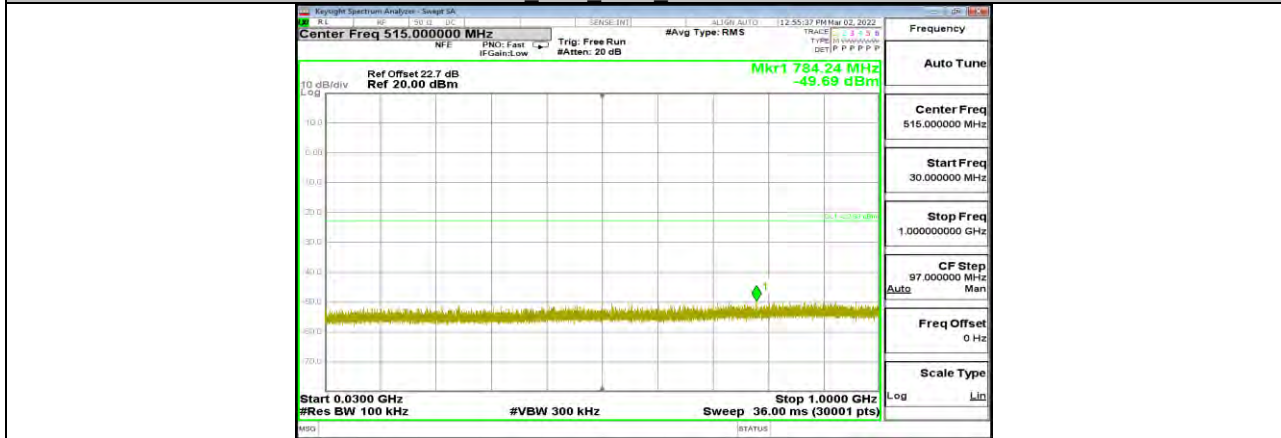

11B Ant1 2437 30~1000

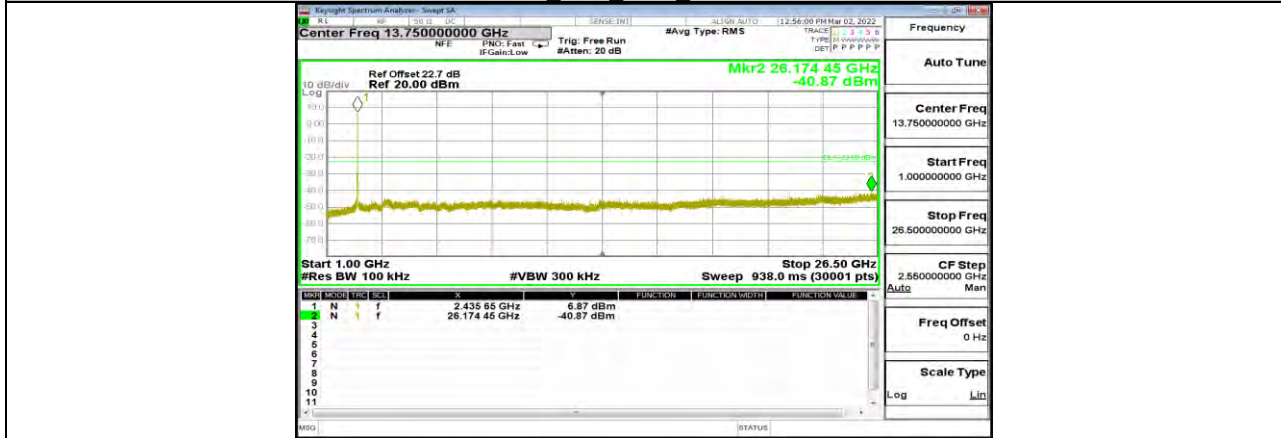

11B Ant1 2437 1000~26500

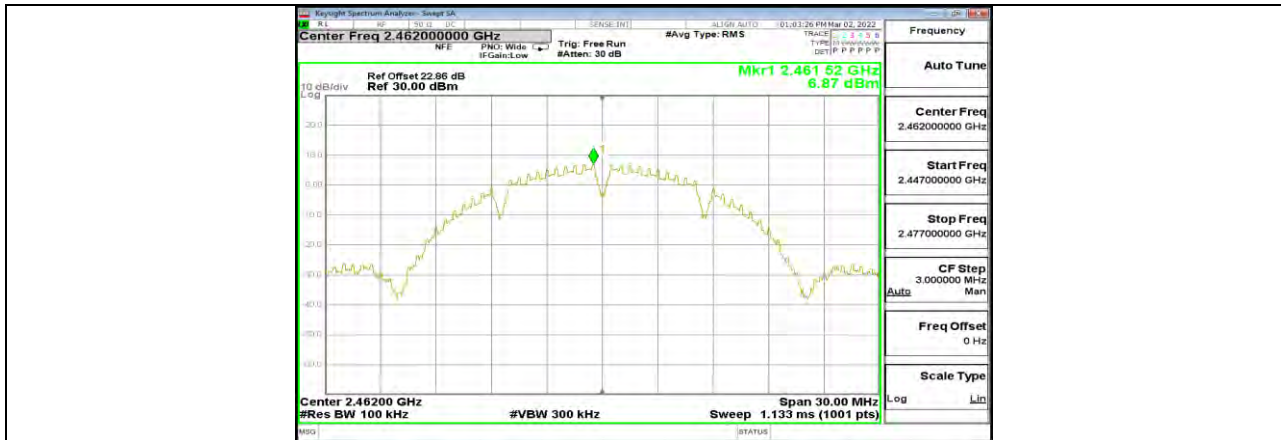

11B\_Ant1\_2462\_0~Reference

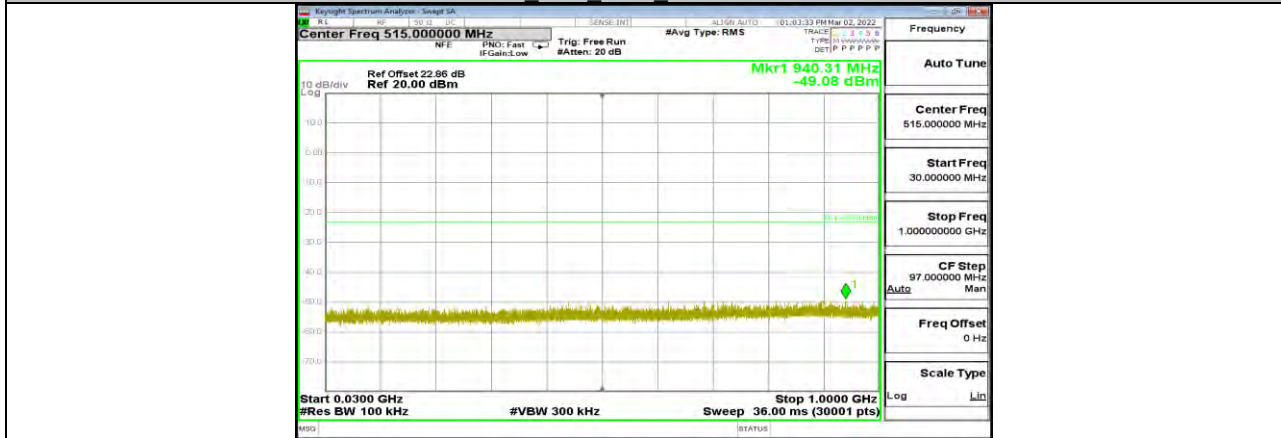

11B\_Ant1\_2462\_30~1000

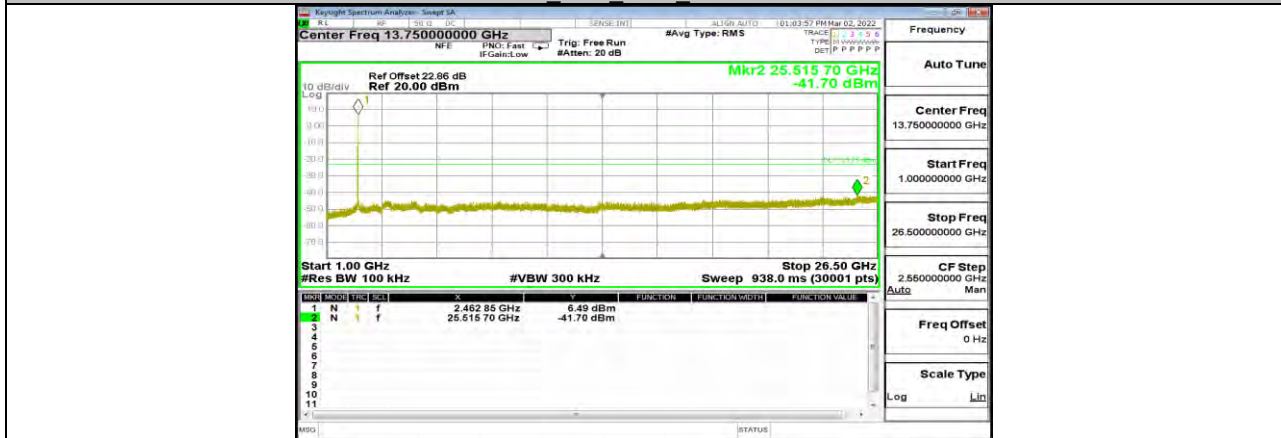

11B\_Ant1\_2462\_1000~26500

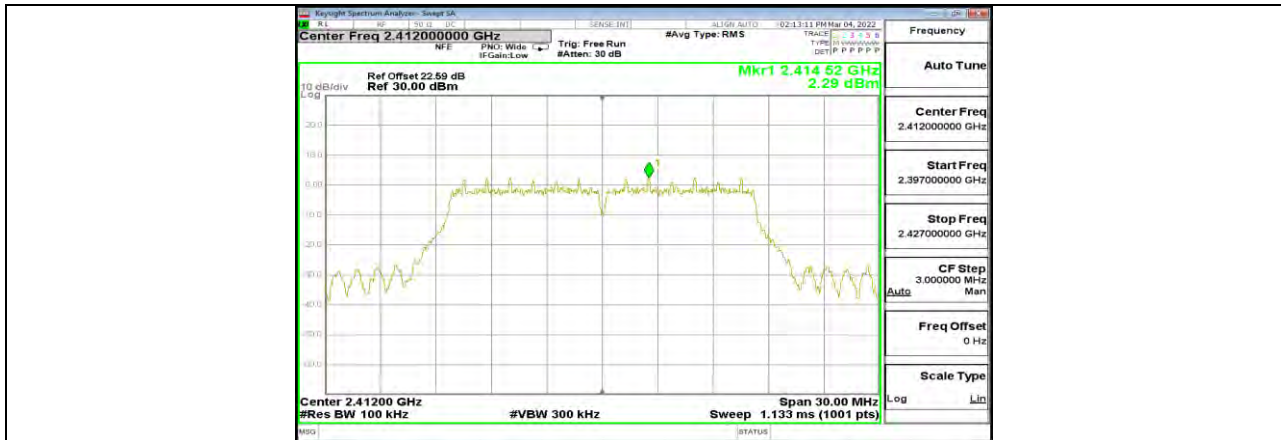

11G Ant1 2412 0-Reference

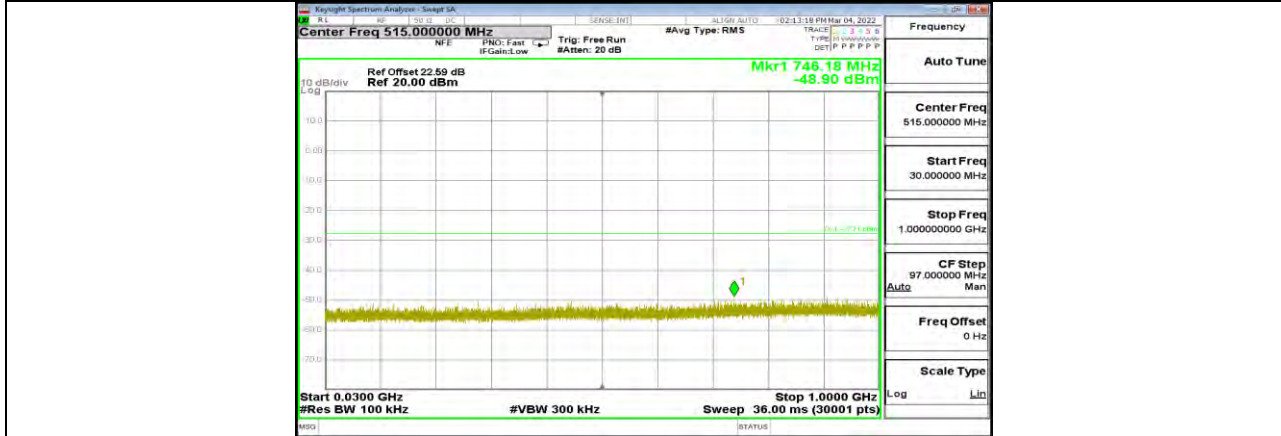

11G Ant1 2412 30~1000

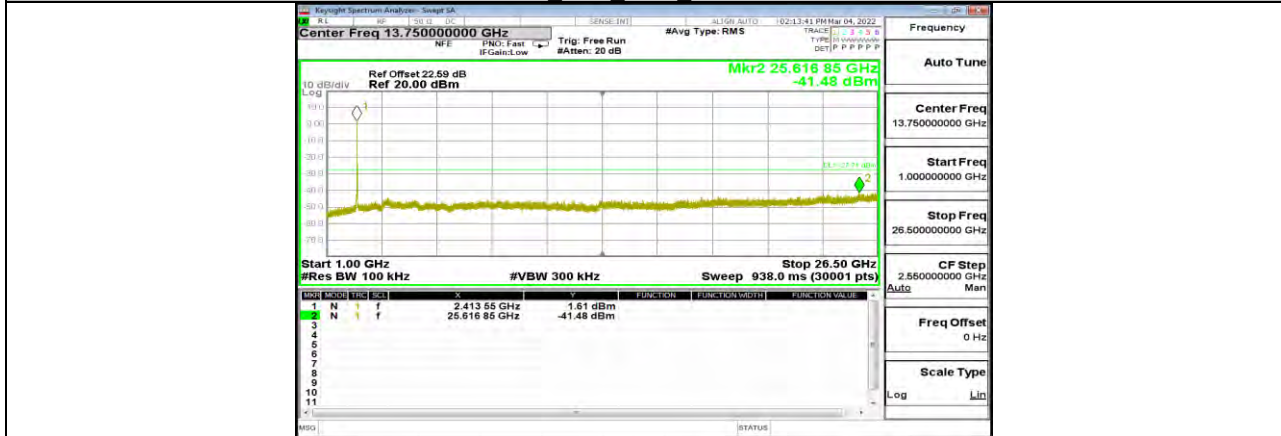

11G Ant1 2412 1000~26500



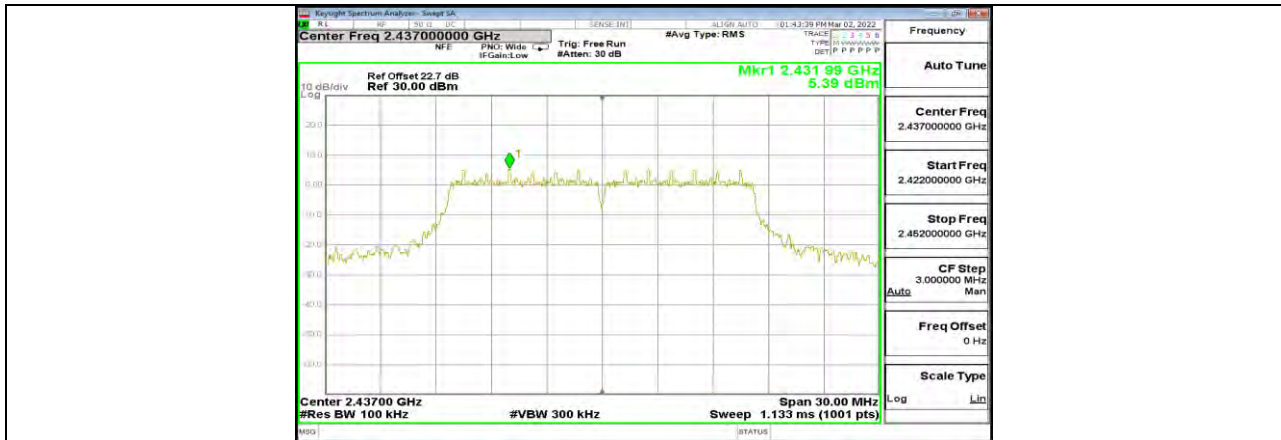

11G Ant1 2437 0-Reference

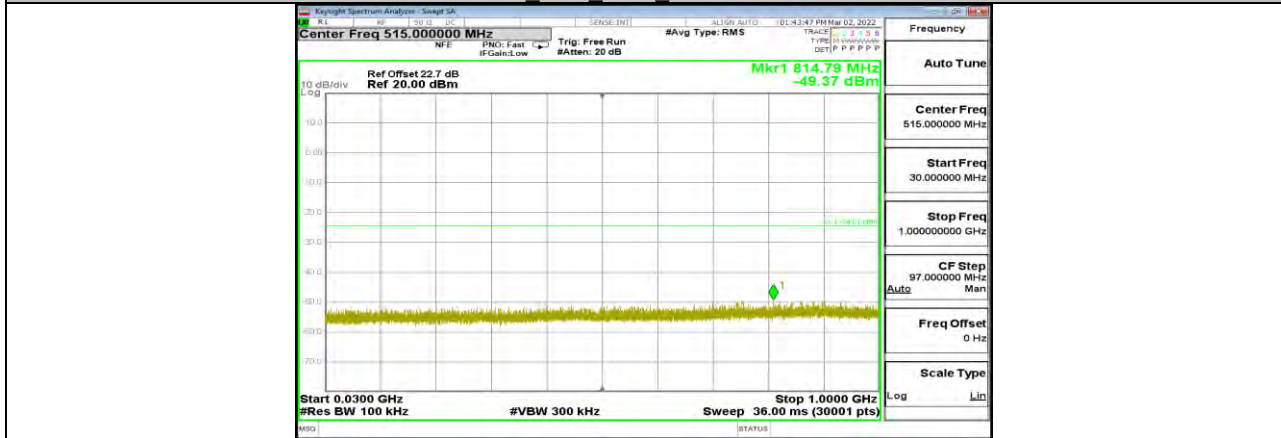

11G Ant1 2437 30~1000

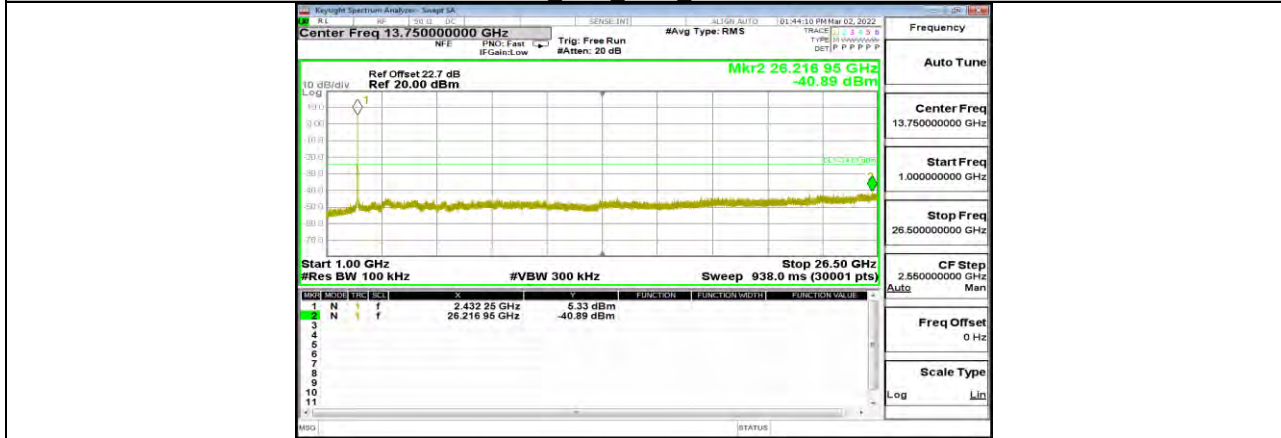

11G Ant1 2437 1000~26500

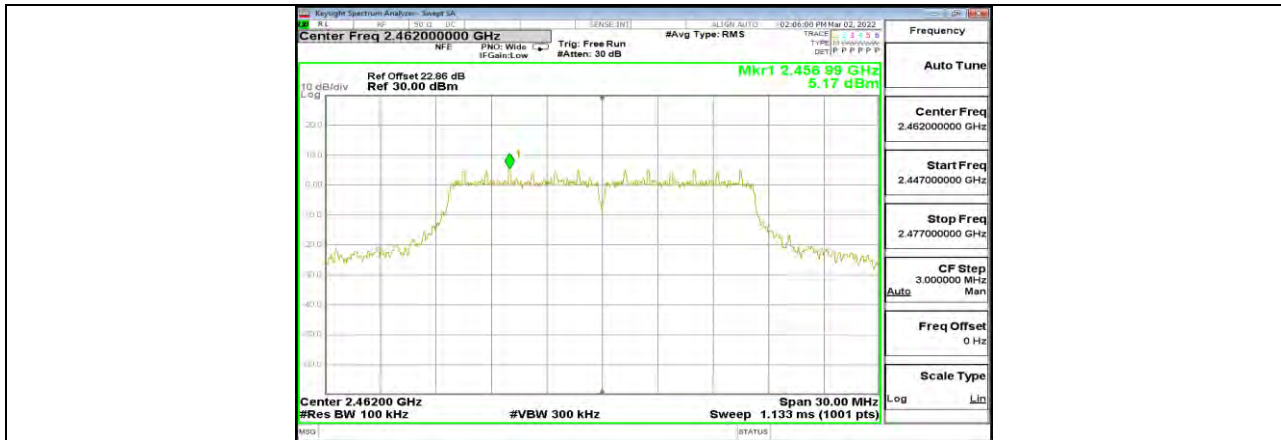

11G Ant1 2462 0-Reference

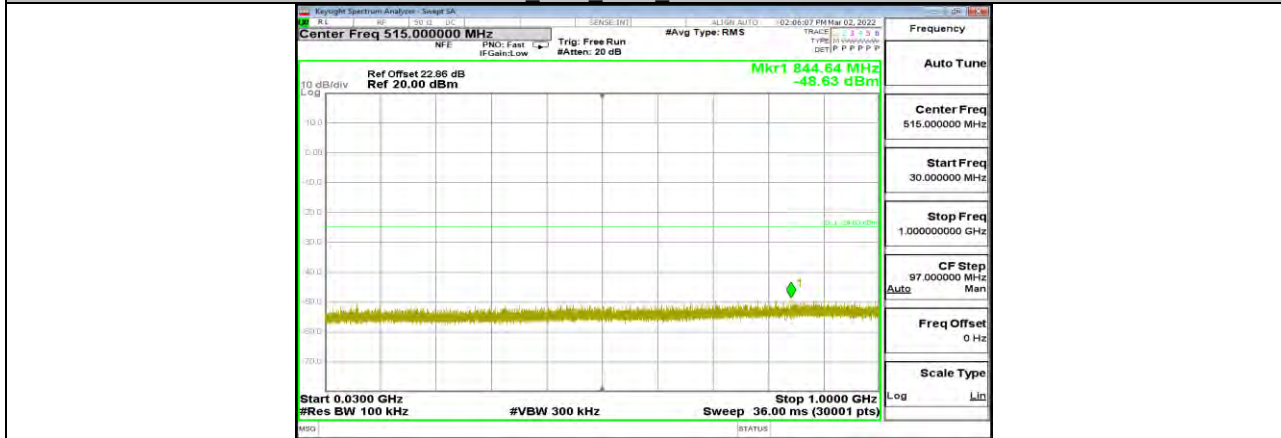

11G Ant1 2462 30~1000

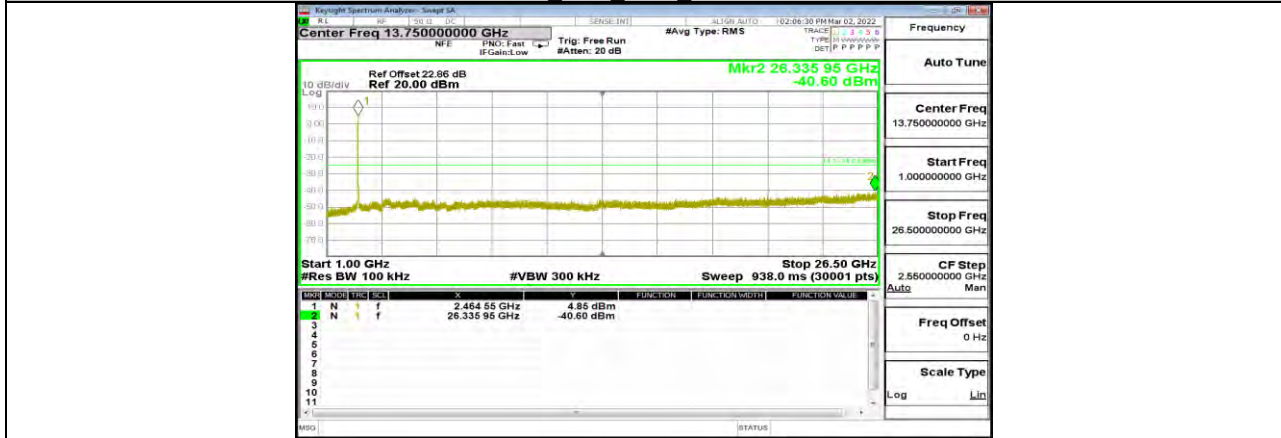

11G Ant1 2462 1000~26500

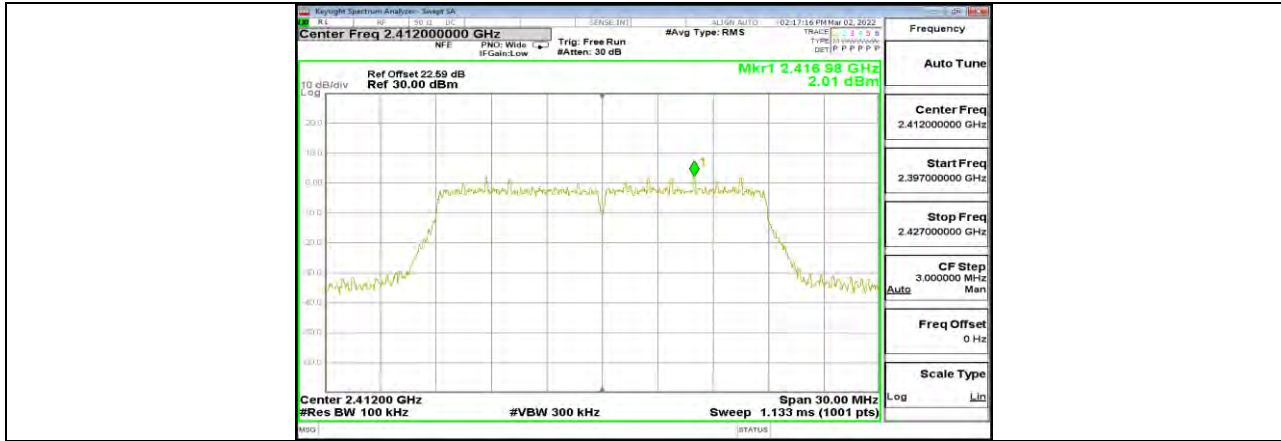

11N20SISO Ant1 2412 0~Reference

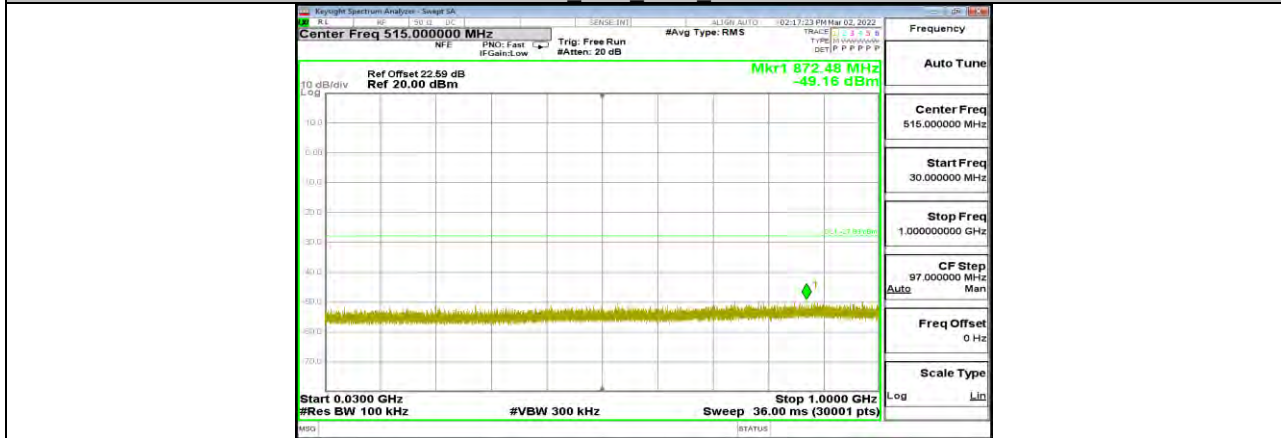

11N20SISO Ant1 2412 30~1000

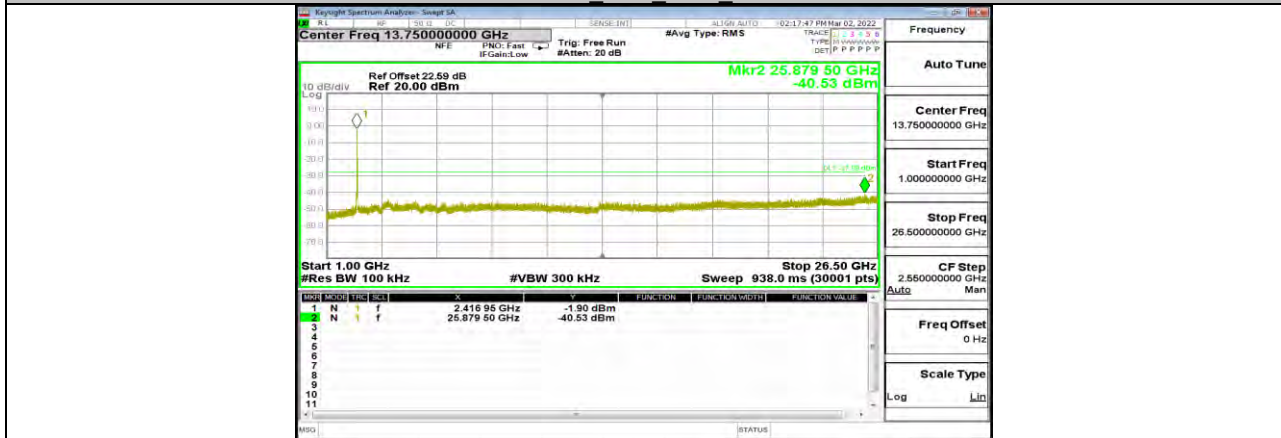

11N20SISO Ant1 2412 1000~26500

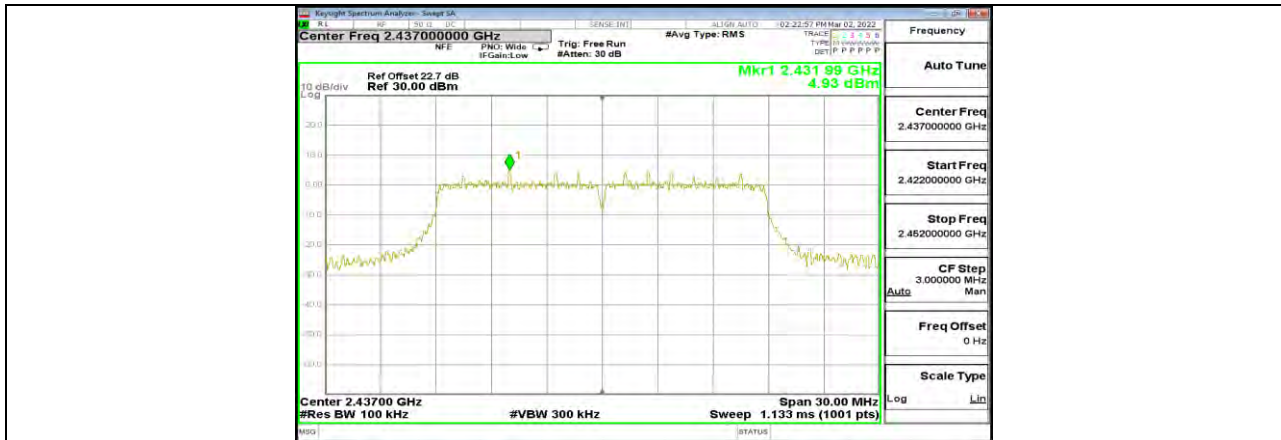

11N20SISO Ant1 2437 0~Reference

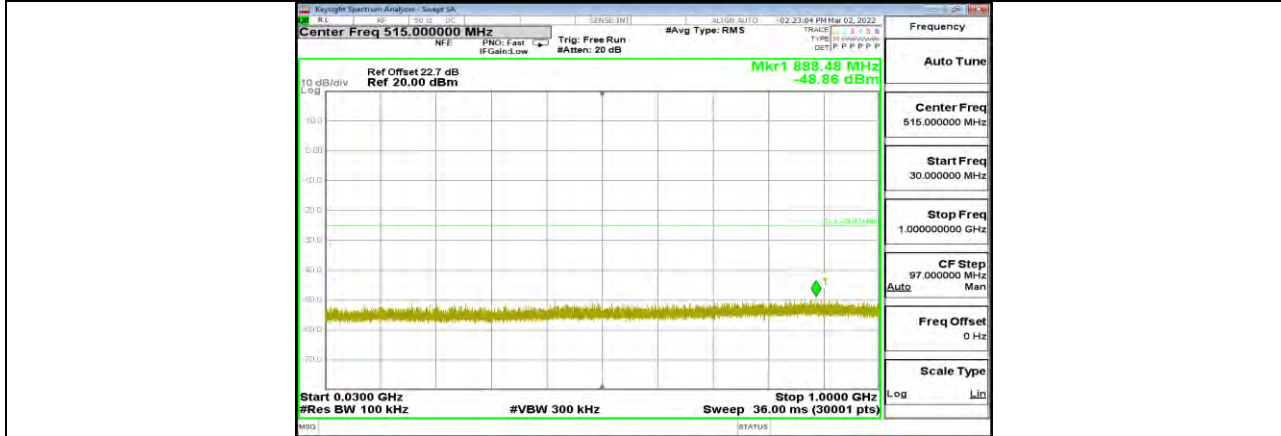

11N20SISO Ant1 2437 30~1000

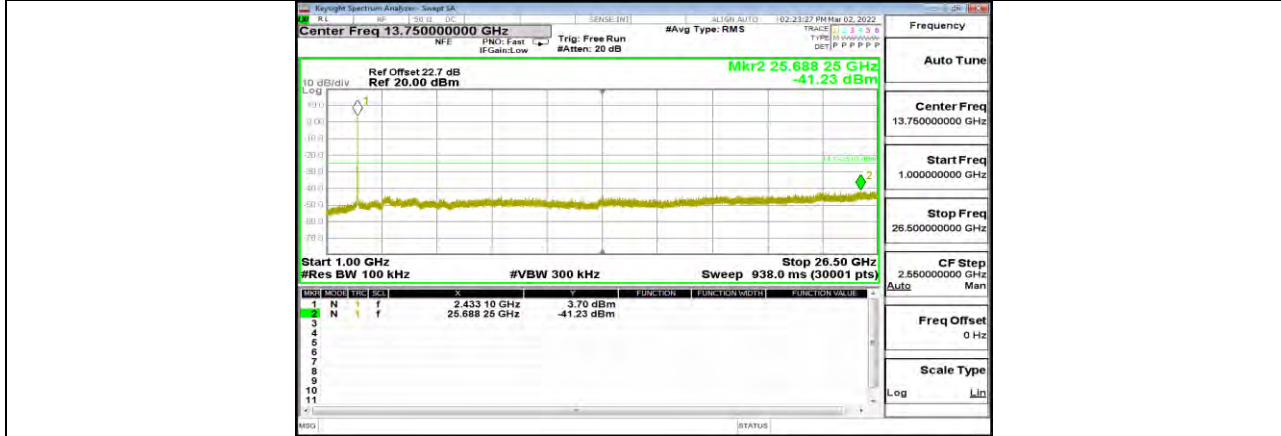

11N20SISO Ant1 2437 1000~26500



11N20SISO Ant1 2462 0~Reference

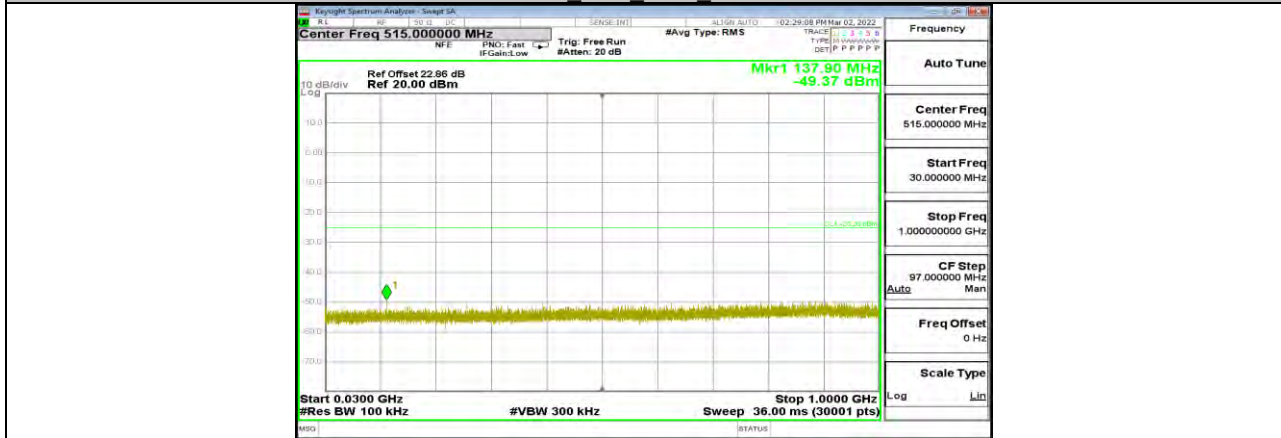

11N20SISO Ant1 2462 30~1000

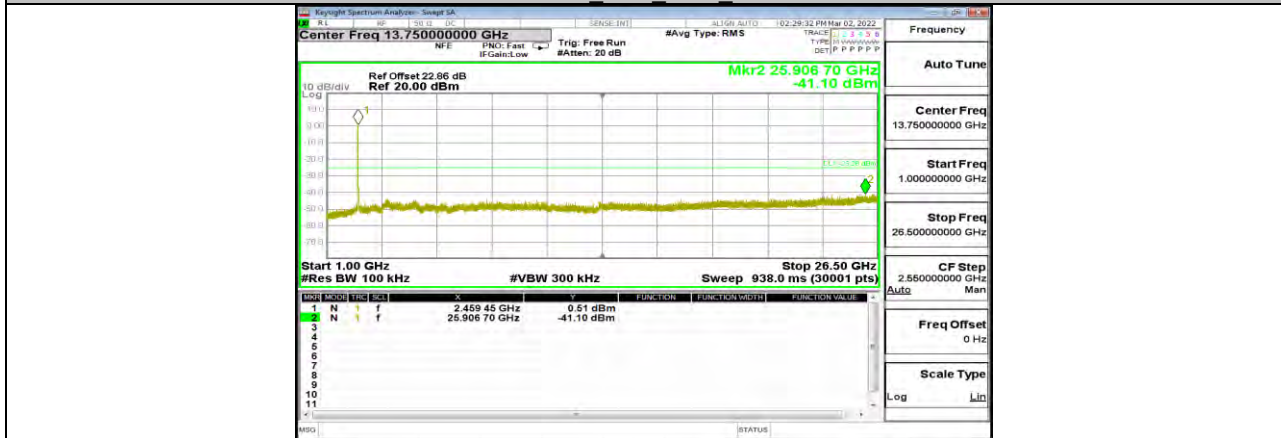

11N20SISO Ant1 2462 1000~26500

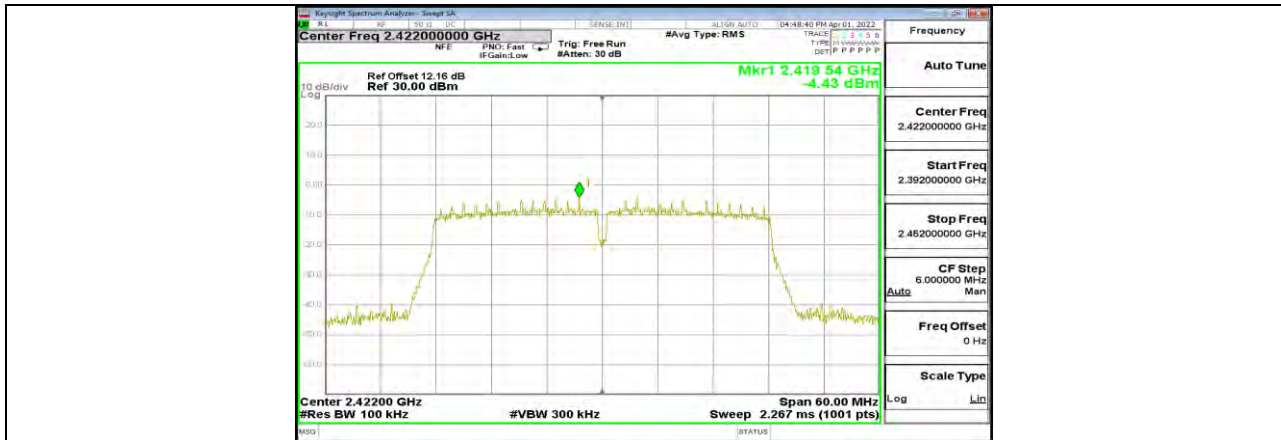

11N40SISO Ant1 2422 0~Reference

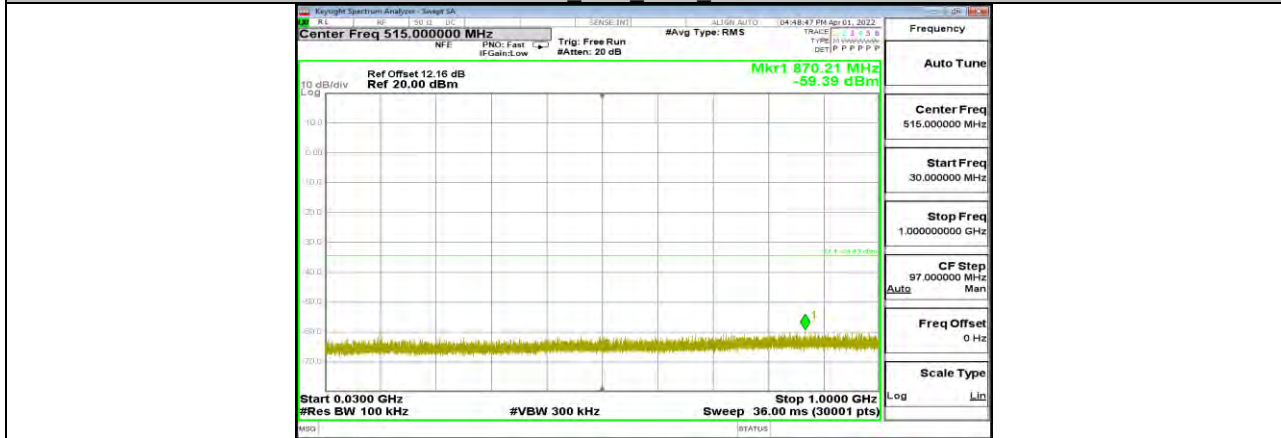

11N40SISO Ant1 2422 30~1000

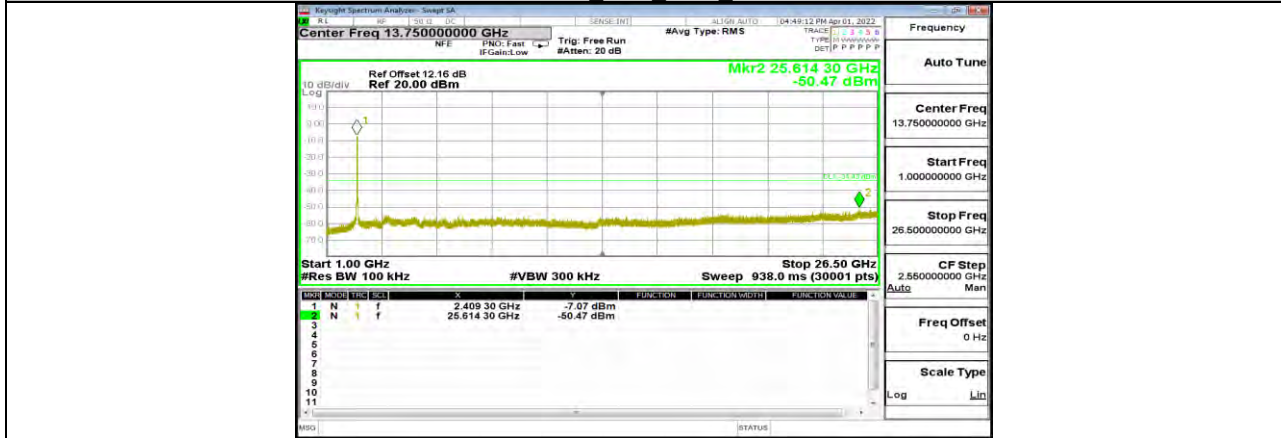

11N40SISO Ant1 2422 1000~26500

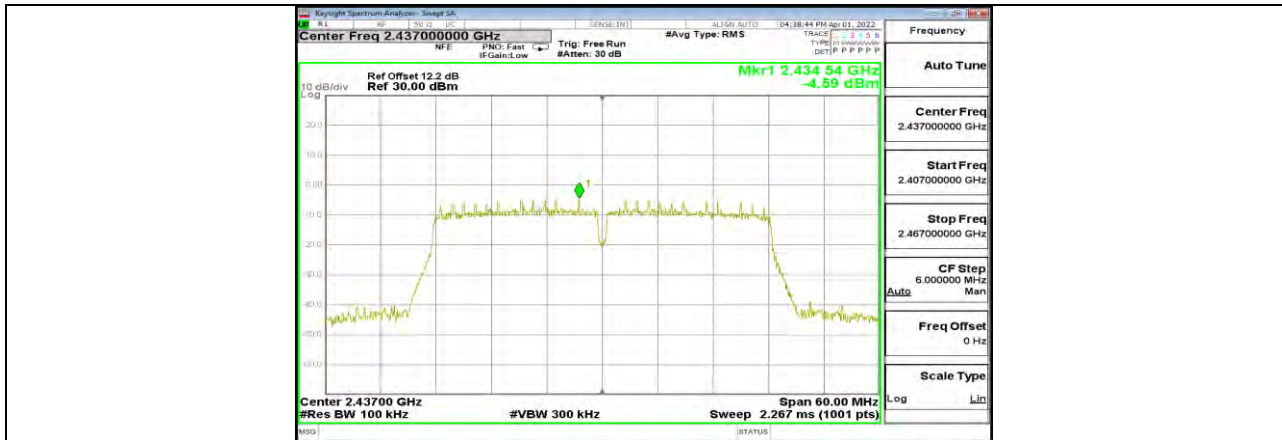

11N40SISO Ant1 2437 0~Reference

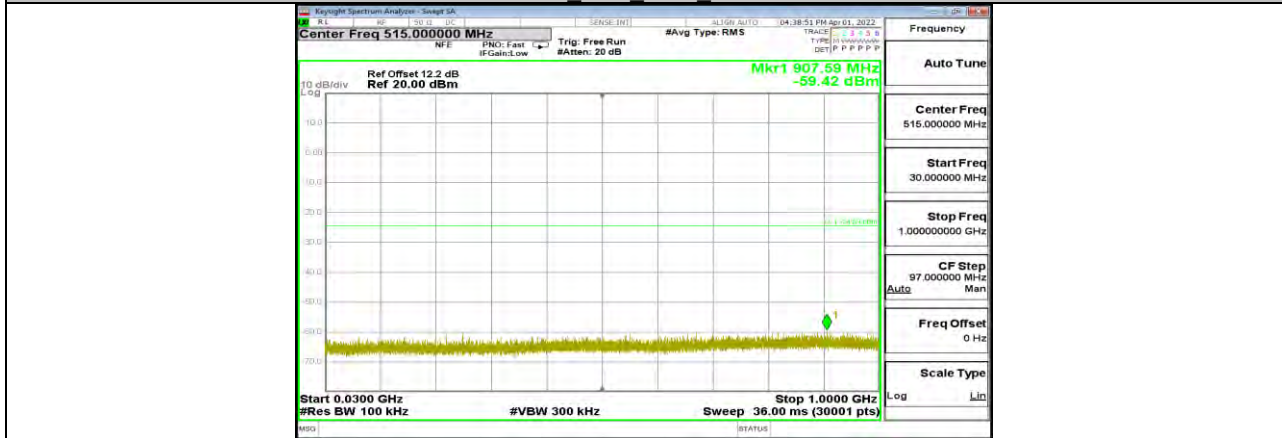

11N40SISO Ant1 2437 30~1000

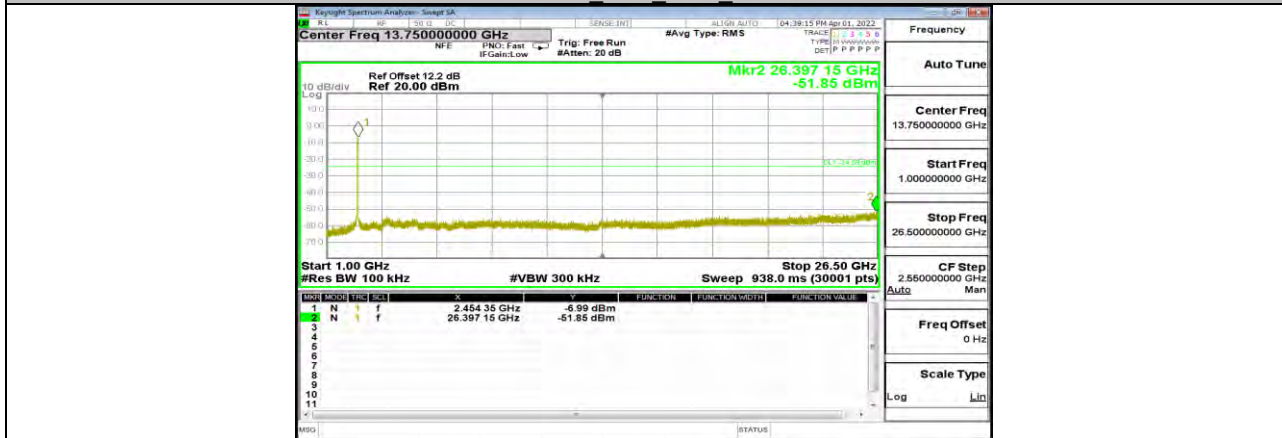

11N40SISO Ant1 2437 1000~26500



11N40SISO Ant1 2452 0~Reference

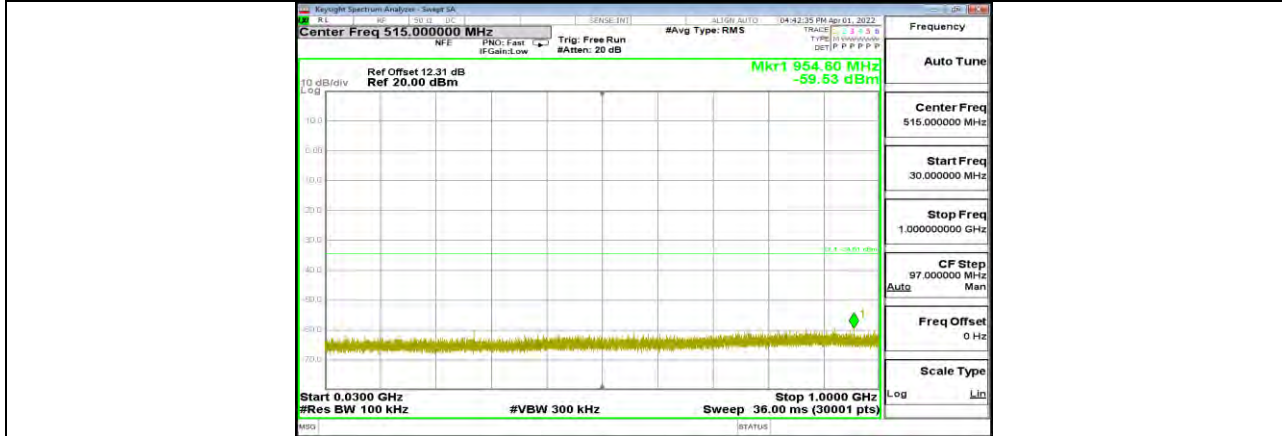

11N40SISO Ant1 2452 30~1000

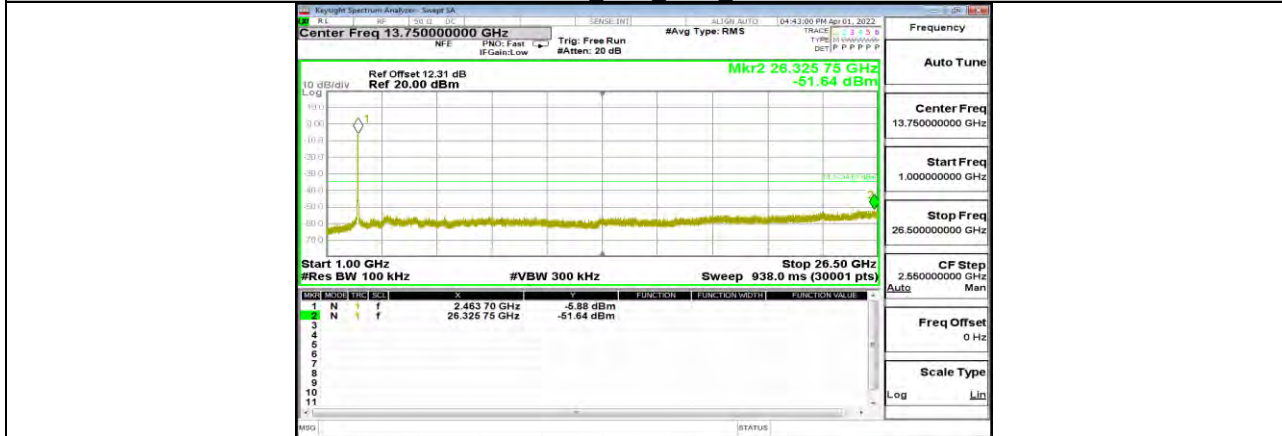

11N40SISO Ant1 2452 1000~26500





## 11.7. Appendix G: Duty Cycle

### 11.7.1. Test Result

Test Mode	On Time (msec)	Period (msec)	Duty Cycle x (Linear)	Duty Cycle (%)	Duty Cycle Correction Factor (dB)	1/T Minimum VBW (kHz)	Final setting For VBW (kHz)
11b	8.39	8.4	0.9988	99.88	0.01	0.12	0.01
11g	1.39	1.41	0.9858	98.58	0.06	0.72	0.01
11N20SISO	5.08	5.1	0.9961	99.61	0.02	0.20	0.01
11N40SISO	2.46	2.48	0.9919	99.19	0.04	0.41	0.01

**Note:**

Duty Cycle Correction Factor=10log (1/x).

Where: x is Duty Cycle (Linear)

Where: T is On Time

If that calculated VBW is not available on the analyzer then the next higher value should be used.

11.7.2. Test Graphs



11B Ant1 2437



11G Ant1 2437



11N20SISO Ant1 2437

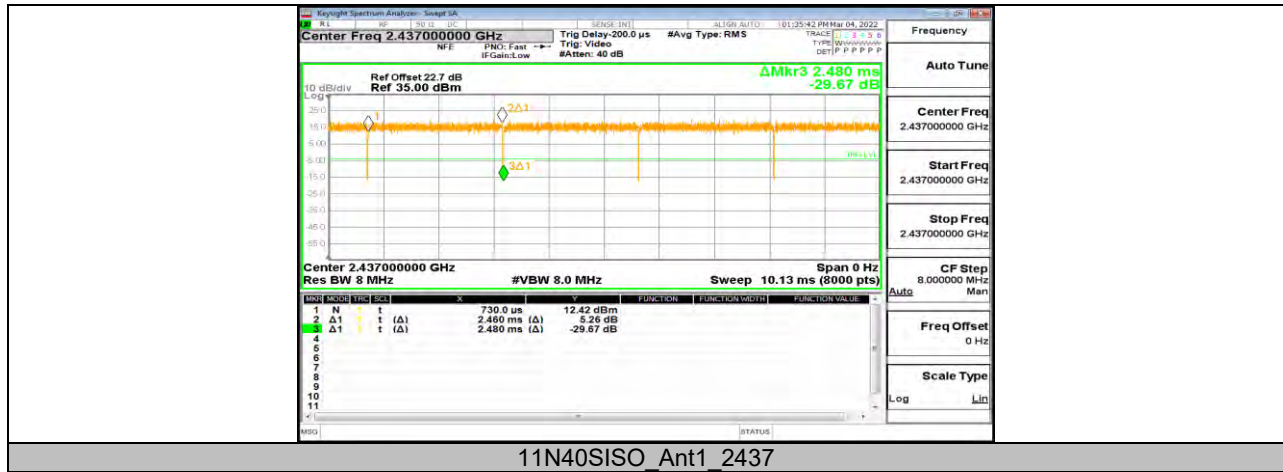

**END OF REPORT**