

石头科技产品包装图纸

模切

标注

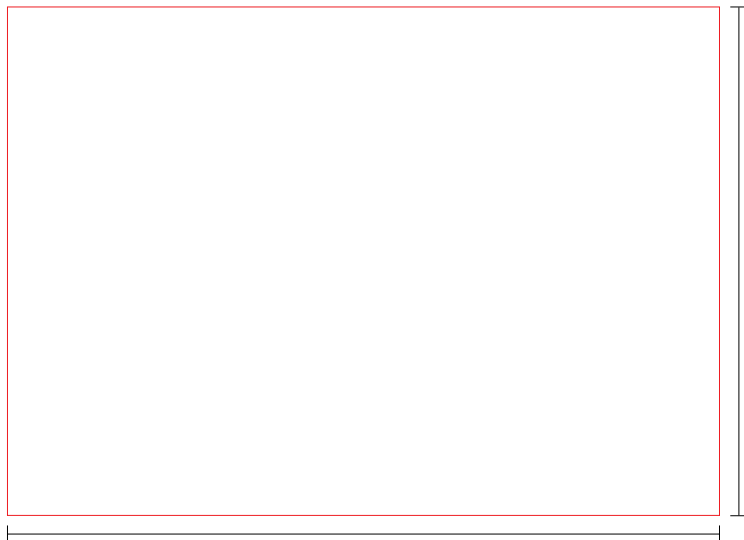

182mm

130mm

图纸
提供
单位

北京石头科技有限公司

材
质
工
艺
要
求

材质: 105g 哑粉, 骑钉
成品尺寸: 182*130mm
页数: 36P
参考色: PANTONE Cool Gray 11 C
PANTONE 185 C
尺寸偏差: $\pm 0.5\text{mm}$
印刷偏位: $\pm 1\text{mm}$

备
注



项目名称 RUBYS-E 说明书 FCC 版本

料号 4.03.0249

版本号 V3.0

设计时间 2020.07.21

设计师 刘超

设计师

比例 1:1 单位 mm

历史
版本

- 版本号: v2.0
- 修改时间: 2020.07.17 修改点: buttont
- 修改 button
- 修改人: 刘超

- 版本号: v3.0
- 修改时间: 2020.07.21
- 修改点: 修改封底 BEIJING 字母加1
- 修改人: 刘超



Roborock S4 Max Robot Vacuum Cleaner User Manual

Read this user manual carefully before using this product and store it properly for future reference.

Safety Information

IMPORTANT SAFETY INSTRUCTIONS

When using an electrical appliance, basic precautions should always be followed, including the following: READ ALL INSTRUCTIONS BEFORE USING (THIS APPLIANCE), Failure to follow the warnings and instructions may result in electric shock, fire and/or serious injury.

WARNING

To reduce the risk of fire, electric shock, or injury:

- Do not use outdoors or on wet surfaces.
- Do not allow to be used as a toy. Close attention is necessary when used by or near children, pets or plants.
- Use only as described in this manual. Use only manufacturer's recommended attachments.
- Do not use with damaged cord or plug. If appliance is not working as it should, has been dropped, damaged, left outdoors, or dropped into water, return it to a service center.
- Do not pull or carry by cord, use cord as a handle, close a door on cord, or pull cord around sharp edges or corners.
- Do not run appliance over cord. Keep cord away from heated surfaces.
- Do not unplug by pulling on cord. To unplug, grasp the plug, not the cord.
- Do not handle charger, including charger plug, and charger terminals with wet hands.
- Do not put any object into openings. Do not use with any opening blocked; keep free of dust, lint, hair, and anything that may reduce air flow.

Safety Information

- Keep hair, loose clothing, fingers, and all parts of body away from openings and moving parts.
- Do not use to pick up flammable or combustible liquids, such as gasoline, or use in areas where they may be present.
- Do not pick up anything that is burning or smoking, such as cigarettes, matches, or hot ashes.
- Do not use without dust bag.
- Prevent unintentional starting. Ensure the switch is in the off-position before connecting to battery pack, picking up or carrying the appliance. Carrying the appliance with your finger on the switch or energizing appliance that have the switch on invites accidents.
- For use only with roborock CDZ11RR or CDZ12RR charger. Recharge only with the charger specified by the manufacturer. A charger that is suitable for one type of battery pack may create a risk of fire when used with another battery pack.
- Use appliances only with specifically designated battery packs. Use of any other battery packs may create a risk of injury and fire.
- Turn off the appliance before making any adjustments, changing accessories, or storing appliance. Such preventive safety measures reduce the risk of starting the appliance accidentally.
- When battery pack is not in use, keep it away from other metal objects, like paper clips, coins, keys, nails, screws or other small metal objects, that can make a connection from one terminal to another. Shorting the battery terminals together may cause burns or a fire.
- Under abusive conditions, liquid may be ejected from the battery; avoid contact. If contact accidentally occurs, flush with water. If liquid contacts eyes, additionally seek medical help. Liquid ejected from the battery may cause irritation or burns.
- Do not use a battery pack or appliance that is damaged or modified. Damaged or modified batteries may exhibit unpredictable behavior resulting in fire, explosion or risk of injury.

Safety Information

- Do not expose a battery pack or appliance to fire or excessive temperature. Exposure to fire or temperature above 130°C may cause explosion.
- Follow all charging instructions and do not charge the battery pack or appliance outside of the temperature range specified in the instructions. Charging improperly or at temperatures outside of the specified range may damage the battery and increase the risk of fire.
- Have servicing performed by a qualified repair person using only identical replacement parts. This will ensure that the safety of the product is maintained.
- Do not modify or attempt to repair the appliance or the battery pack except as indicated in the instructions for use and care.
- Place the cords from other appliances out of the area to be cleaned.
- Do not operate the vacuum in a room where an infant or child is sleeping.
- Do not operate the vacuum in an area where there are lit candles or fragile objects on the floor to be cleaned.
- Do not operate the vacuum in a room that has lit candles on furniture that the vacuum may accidentally hit or bump into.
- Do not allow children to sit on the vacuum.
- Do not use the vacuum cleaner on a wet surface.
- Risk Of Injury. Brush May Start Unexpectedly. Disconnect the main Brush Before Cleaning or Servicing.
- Do not use the product when the temperature is higher than 40°C or lower than 4°C, or there is any liquid or sticky substance on the floor.

Safety Information

SAVE THESE INSTRUCTIONS

Household use only.

IMPORTANTES MESURES DE S CURIT

L'utilisation d'un appareil électrique demande certaines précautions:

LIRE TOUTES LES INSTRUCTIONS AVANT DE FAIRE FONCTIONNER (CETAPPAREIL), Le non-respect des mises en garde et des instructions peut causer des chocs électriques, des incendies et/ou des blessures graves.

AVERTISSEMENT

- Pour réduire les risques d'incendie, de choc électrique ou de blessure:
- Ne pas exposer à la pluie, Ranger à l'intérieur.
- Ne pas permettre aux enfants de jouer avec l'appareil. Une attention particulière est nécessaire lorsque l'appareil est utilisé par des enfants ou à proximité de ces derniers.
- N'utiliser que conformément à cette notice avec les accessoires recommandés par le fabricant.
- Ne pas utiliser si le cordon ou la fiche est endommagé. Retourner l'appareil à un atelier de réparation s'il ne fonctionne pas bien, s'il est tombé ou s'il a été endommagé, oublié à l'extérieur ou immergé.
- Ne pas tirer soulever ni trainer l'appareil par le cordon. Ne pas utiliser le cordon comme une

Safety Information

poignée, le coincer dans l'embrasure d'une porte ou l'appuyer contre des arêtes vives ou des coins. Ne pas faire rouler l'appareil sur le cordon.

- Garder le cordon à l'écart des surfaces chaudes. Ne pas débrancher en tyrant sur le cordon. Tirer plutôt la fiche. Ne pas manipuler le chargeur, y compris la prise du chargeur, et les bornes du chargeur avec les mains mouillées.
- N'insérer aucun objet dans les ouvertures. Ne pas utiliser l'appareil lorsqu'une ouverture est bloquée. S'assurer que de la poussière, de la peluche, des cheveux ou d'autres matières ne réduisent pas le débit d'air. Maintenir les cheveux, les vêtements amples, les doigts et toutes les parties du corps à l'écart des ouvertures et des pièces mobiles.
- User de prudence lors du nettoyage des escaliers.
- Ne pas aspirer des liquides inflammables ou combustibles, comme de l'essence, et ne pas faire fonctionner dans des endroits où peuvent se trouver de tels liquides.
- Ne pas aspirer de matières en combustion ou qui dégagent de la fumée, comme des cigarettes, des allumettes ou des cendres chaudes.
- Ne pas utiliser l'appareil si le sac à poussière ou le filtre n'est pas en place.
- Éviter une mise en marche accidentelle. S'assurer que l'interrupteur est à la position arrêt avant de raccorder la batterie, de lever ou de déplacer l'appareil. Transporter l'appareil en gardant un doigt sur l'interrupteur, ou mettre sous tension un appareil dont l'interrupteur est à la position marche peut causer un accident.
- Pour emploi seulement avec roborock CDZ11RR or CDZ12RR chargeur. Recharger uniquement avec le chargeur prescrit par le fabricant. Un chargeur convenant à un type de batterie peut présenter un risque d'incendie lorsqu'il est utilisé avec une autre batterie.
- Retirer la batterie de l'appareil avant d'effectuer des réglages, changer les accessoires ou ranger

Safety Information

l'appareil. Ces mesures de sécurité ont pour but d'éviter une mise en marche accidentelle de l'appareil.

- Utiliser uniquement les batteries recommandées pour l'appareil. L'utilisation d'autres types de batteries peut présenter un risque de blessure ou d'incendie.
- Lorsque l'appareil n'est pas utilisé, tenir la batterie loin d'objets métalliques comme des trombones, des pièces de monnaie, des clés, des clous, des vis ou autres petits objets qui pourraient établir une liaison entre les bornes. Un court-circuit des bornes des batteries peut causer des brûlures ou un incendie.
- En condition d'usage abusif, du liquide peut s'échapper de la batterie ; éviter tout contact avec ce liquide.
- En cas de contact accidentel, rincer abondamment avec de l'eau. En cas de contact avec les yeux, consulter également un médecin. Le liquide projeté peut causer des irritations ou des brûlures.
- Ne pas utiliser une batterie ou un appareil endommagé ou qui a été modifié. Des batteries endommagées ou modifiées peuvent avoir un comportement imprévisible pouvant causer un incendie, une explosion ou un risque de blessure.
- Ne pas exposer une batterie ou un appareil à la flamme ou à des températures excessives. L'exposition à une flamme ou à des températures supérieures à 130 °C peut causer une explosion.
- Respecter toutes les instructions de chargement et ne pas charger la batterie ou l'appareil à des températures qui ne sont pas incluses dans la gamme de températures indiquées dans la notice d'instructions. Un chargement mal effectué.
- Confier les réparations à une personne qualifiée qui utilisera uniquement des pièces de remplacement identiques. Cette façon de faire garantira la sécurité du produit.
- Ne pas modifier ni tenter de réparer l'appareil ou la batterie sauf comme il est indiqué dans les

Safety Information

instructions d'utilisation et d'entretien.

- Éloigner les cordons d'autres appareils de la zone à nettoyer.
- Ne pas utiliser l'aspirateur dans une pièce où un nourrisson ou un enfant dort.
- Ne pas utiliser l'aspirateur dans un endroit où il ya des bougies allumées ou des objets fragiles sur le plancher à nettoyer.
- Ne pas utiliser l'aspirateur dans une pièce où il ya des bougies allumées sur les meubles que l'aspirateur peut heurter ou se cogner accidentellement.
- Ne pas laisser les enfants s'asseoir sur l'aspirateur.
- Ne pas utiliser l'aspirateur sur une surface mouillée. Risque de blessures. La brosse motorisée peut se mettre en marche d'une manière imprévue.
- Déconnecter la brosse principale avant le nettoyage ou le service.

CONSERVER CES INSTRUCTIONS

Usage Domestique seulement.

Laser Safety

Class 1 laser product, Complies with FDA 21 CFR 1040.10 and 1040.11 except for conformance with IEC 60825-1 Ed. 3., as described in Laser Notice 56, dated May 8, 2019.

FCC IC Statement

Compliance Information	
Product Name	Robotic Vacuum Cleaner with Dock Charger
Produce Model	Robotic Vacuum Cleaner Model: roborock S4 Max Dock Charger Model: CDZ11RR or CDZ12RR
Compliance Statement	<p>This device complies with part 15 of the FCC Rules. This device contains licence-exempt transmitter(s)/receiver(s) that comply with Innovation, Science and Economic Development Canada's licence-exempt RSS(s). Operation is subject to the following two conditions: (1) This device may not cause harmful interference, and (2) this device must accept any interference received, including interference that may cause undesired operation.</p>
Correspondence of the responsible party in USA	
Company	Roborock Technology Co.
Address	108 West 13th Street, Wilmington, Delaware 19801.
Email	support@roborock.com

FCC IC Statement

Warning

Any changes or modifications to this unit not expressly approved by the party responsible for compliance could void the user's authority to operate the equipment.

Le présent appareil est conforme aux CNR d'Industrie Canada applicables aux appareils radio exempts de licence.

L'exploitation est autorisée aux deux conditions suivantes :

(1) l'appareil ne doit pas produire de brouillage, et

(2) l'utilisateur de l'appareil doit accepter tout brouillage radioélectrique subi, même si le brouillage est susceptible d'en compromettre le fonctionnement.

This equipment has been tested and found to comply with the limits for a Class B digital device, pursuant to part 15 of the FCC Rules. These limits are designed to provide reasonable protection against harmful interference in a residential installation. This equipment generates uses and can radiate radio frequency energy and, if not installed and used in accordance with the instructions, may cause harmful interference to radio communications. However, there is no guarantee that interference will not occur in a particular installation. If this equipment does cause harmful interference to radio or television reception, which can be determined by turning the equipment off and on, the user is encouraged to try to correct the interference by one or more of the following measures:

—Reorient or relocate the receiving antenna.

—Increase the separation between the equipment and receiver.

—Connect the equipment into an outlet on a circuit different from that to which the receiver is

FCC IC Statement

connected.

—Consult the dealer or an experienced radio/TV technician for help.

MPE Requirements

To satisfy FCC / IC RF exposure requirements, a separation distance of 20 cm or more should be maintained between the antenna of this device and persons during device operation. To ensure compliance, operations at closer than this distance is not recommended.

L'antenne installée doit être située de façon à ce que la population ne puisse être exposée à une distance de moins de 20 cm. Installer l'antenne de façon à ce que le personnel ne puisse approcher à 20 cm ou moins de la position centrale de l'antenne. La FCC des États-Unis stipule que cet appareil doit être en tout temps éloigné d'au moins 20 cm des personnes pendant son fonctionnement.

CAN ICES-3 (B)/NMB-3(B)

Holiday Energy Saving Function

When the robot is docked, press and hold "Recharge" for 10 seconds or until you hear an alert sound. This will activate Holiday mode.

In this mode the robot will switch to Low Power mode to minimize power consumption. This includes a dimming of the LED indicator, and the stopping of all non-charging related functions including cleaning, remote control over WiFi, and more.

To deactivate Holiday mode, press and hold "Recharge" for 10 seconds until the LED indicator brightens.

Battery and Charging

- Keep the dock charger away from heat (such as heating plates).
- Do not wipe or clean the charging contact with a piece of wet cloth or wet hands.
- Make sure the cleaner is powered off in shipment and original packaging is advised.
- If left unused for a long period, please store the cleaner in a cool and dry place after having it fully charged and switched off, charge it at least every three months to avoid the battery being over discharged.
- Do not use the product when the temperature is higher than 40°C or lower than 4°C , or there is any liquid or sticky substance on the floor.

Battery pack charging temperature		4°C ~ 40°C	@Max Charging Current:0.5C
Battery pack using temperature		4°C ~ 40°C	@Max Discharge Current:0.5C
Battery pack storage temperature	Storage(1month)	-20°C ~ 60°C @Less than 70% RH	If the battery pack store at 25°C over the 3 months period, it should be recharged.
	Long Storage(3months)	-20°C ~ 45°C @Less than 70% RH	
	Long Storage(1year)	-20°C ~ 20°C @Less than 70% RH	

Product Introduction

Robot

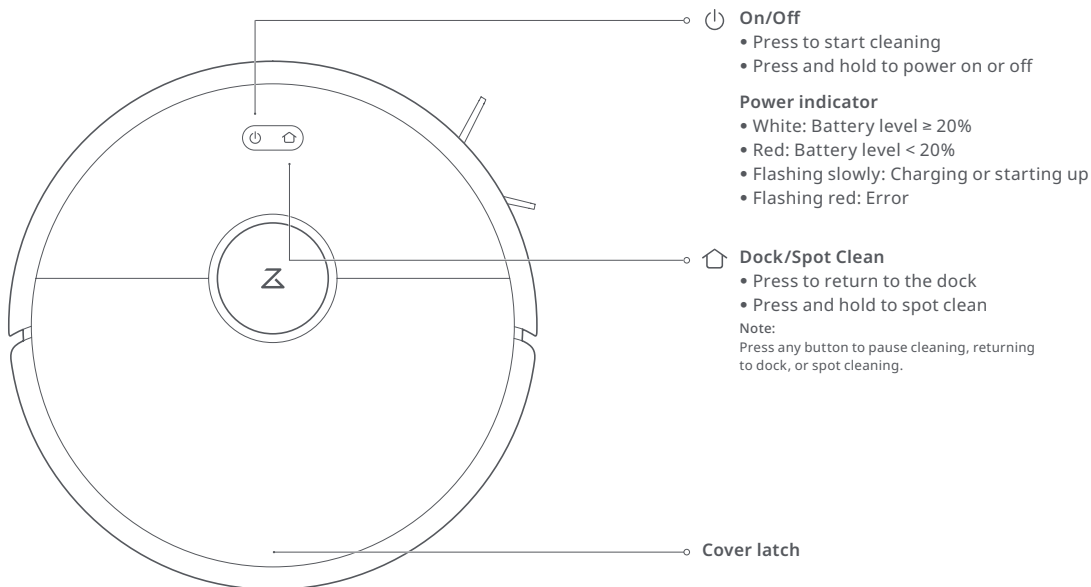

Product Introduction

Parts list

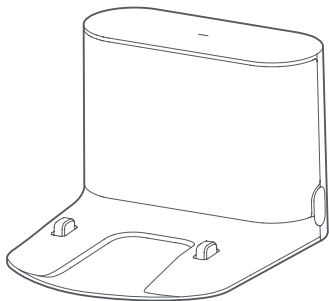

Charging dock

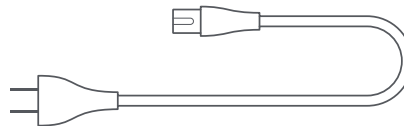

Power cable

Product Introduction

Dustbin

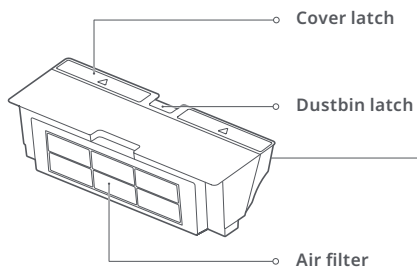

Robot

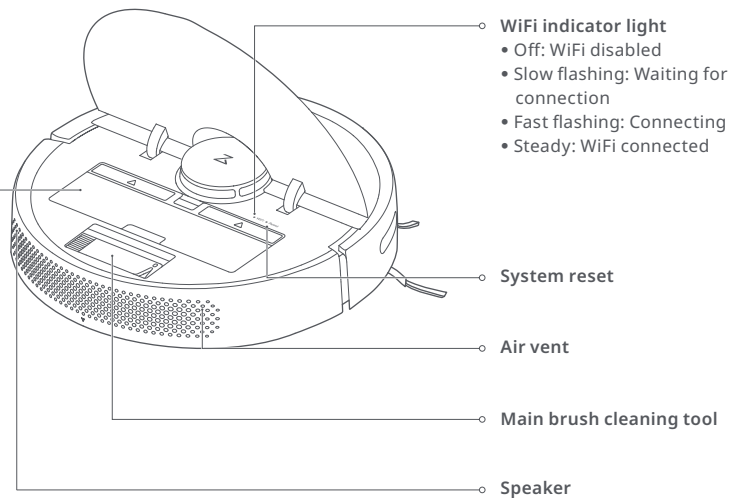

Product Introduction

Robot and sensors

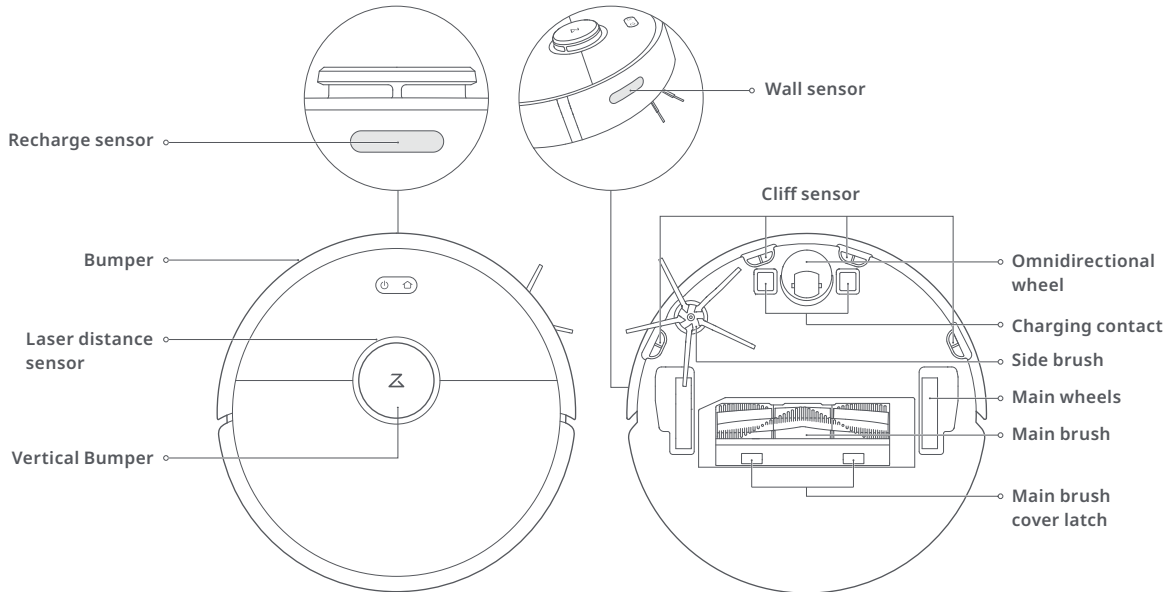

Product Introduction

Charging dock

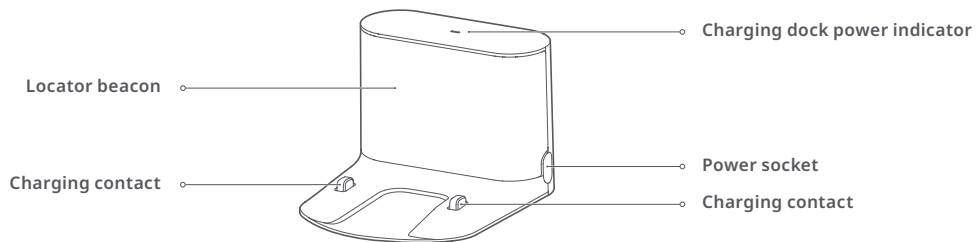

Installation

Important Information

1. Tidy cables and loose items from the ground and move any unstable, fragile, precious, or dangerous items to prevent personal injury or property damage due to items becoming tangled in, struck by, or knocked over by the robot.

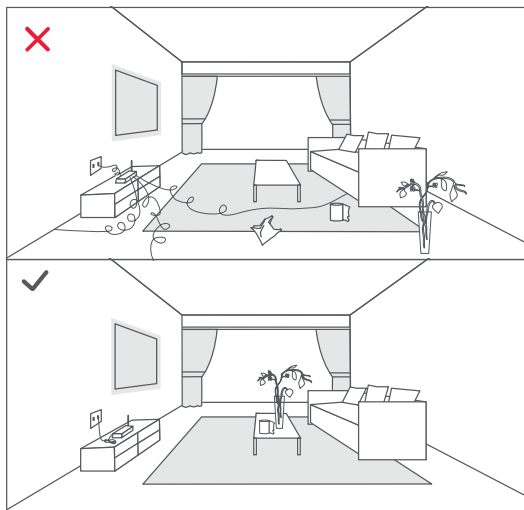

2. If using this robot in a raised area, always use a secure physical barrier to prevent accidental falls that may result in personal injury or property damage.

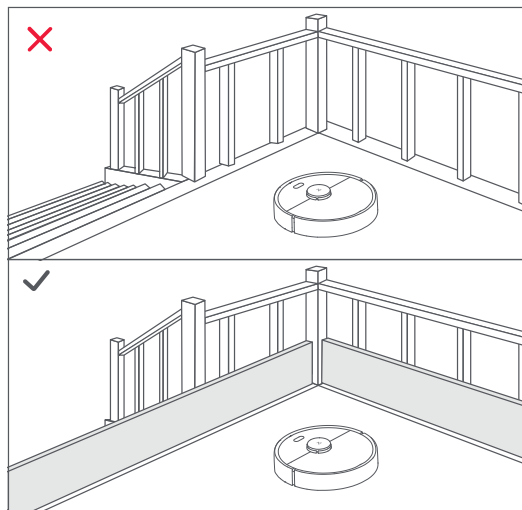

Note:

When using the robot for the first time, follow it throughout its whole cleaning route and watch for major obstacles. The robot will be able to clean by itself in future uses.

Installation

Using the robot

1. Place the charging dock against the wall on a flat surface and plug it into the mains power.

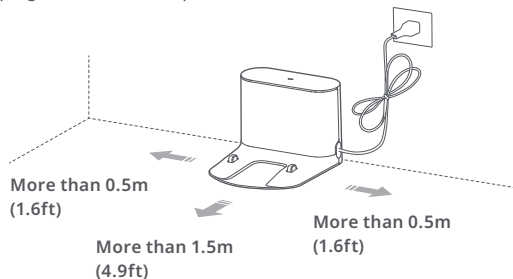

Note:

- The charging dock should have more than 0.5m (1.6ft) of clearance on each side, and more than 1.5m (4.9ft) in the front.
- If the power cable is vertical to the ground, it may be caught by the robot, causing the charging dock to be disconnected.
- The charging dock indicator is on when the charging dock is electrified, and off when the robot is charging.

2. Secure the charging dock with the adhesive tape. Wipe the floor of the area where the charging dock will be placed with a dry cloth, then stick the enclosed double-sided tape to the floor. Place the dock onto the double-sided tape to secure it in place.

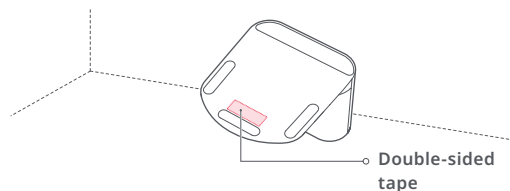

Note:

- Use of the double-sided tape to secure the charging dock is optional.
- When necessary, remove the double-sided tape slowly to reduce residue glue.

3. Power on and charge.

Press and hold the  button to turn on the robot. When the power indicator lights up, place the robot onto the charging dock to begin charging. The robot uses a high-performance lithium-ion rechargeable battery. To maintain peak battery performance, always keep the robot charged.

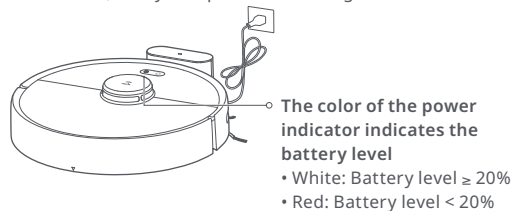

Note:

The robot will not turn on when the battery is low. Place the robot directly onto the charging dock to begin charging.

Installation

Connect to the app



4. Connect to the app. (recommended)

① Download the Roborock app

Search "Roborock" in the App Store or Google Play, or scan the QR code below, then download and install the app.



② Reset WiFi

- Open the top cover of the robot to reveal the WiFi indicator light.
- Press and hold the  button and the  button until you hear the "Resetting WiFi" voice alert. When the WiFi indicator light is flashing slowly, the robot has entered network configuration mode.

Note:

If you cannot connect your phone to the robot, reset the WiFi, and add your robot as a new device.

③ Add device

Open the app and tap "+" in the top right corner, then follow the instructions in-app. Once your robot has been added, it will be found in a list on the homepage.

Note:

- Due to ongoing app development, the actual process may differ slightly from the above description. Always follow the instructions given in the app.
- Only 2.4GHz WiFi is supported.

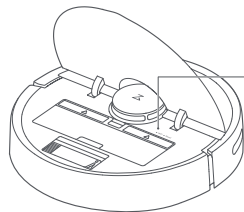

WiFi indicator light

- Off: WiFi disabled
- Slow flashing: Waiting for connection
- Fast flashing: Connecting
- Steady: WiFi connected



Using the robot

5. Start cleaning.

When the battery is fully charged, the power indicator will remain lit. Press the  button or use the app to start a cleanup.

Instructions for use

On/off

Press and hold the  button to turn on the robot. The power indicator will turn on and the robot will enter Standby mode. If the robot is in Sleep mode, press and hold the  button to turn it off and end the current cleanup.

Note:

The robot cannot be turned off when it is charging.

Start cleanup

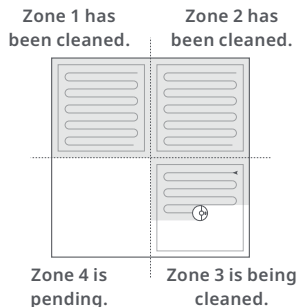

Press the  button to start cleaning. Once started, the robot will plan its cleaning route based on its scan of the area. It cleans along the edges of a zone first and then moves in a Z-shaped cleaning route to cover the internal area efficiently and thoroughly.



Note:

- Cleaning cannot start if the battery level is too low. Allow the robot to charge before restarting cleanup.
- Tidy away any cables on the ground (including the power cable of the charging dock) before cleaning to avoid losing power or damaging either the robot or the connected device.
- If a cleanup finishes within 10 minutes, cleaning repeats by default.
- If the battery runs low before cleanup is complete, the robot will carry out a top-up charge before resuming cleanup from where it left off.

Pause

When the robot is cleaning, press any button to pause it. Then press the  button to continue cleaning or the  button to return it to the charging dock and stop the cleaning cycle.

Note:

Placing a paused robot on the charging dock manually will end the current cleanup.

Sleep

If the robot is paused for over 10-minutes, it will go to sleep, and its power indicator will flash slowly. Press any button to wake it back up.

Note:

- The robot will not go to sleep when it is on the charging dock.
- The robot will automatically shut down if left in sleep mode for more than 12 hours.

Instructions for use

Charging

Auto: After cleaning, the robot will automatically return to the charging dock to recharge.

Manual: In Pause mode, press the  button to send the robot back to the charging dock.

The power indicator will flash slowly as the robot charges.

Note:

If the cleaning cycle was started away from the charging dock and the robot could not return to the dock after cleaning, it will instead return to its starting point. Place the robot directly on the dock to recharge it.

Error

If an error occurs while the robot is cleaning, the power indicator will flash red quickly, and you will hear a voice alert. See "Troubleshooting" for resolution options.

Note:

- The robot will go to sleep automatically if left in an Error state for over 10-minutes.
- Placing the robot on the charging dock in an error state will stop the current cleanup.

Reset WiFi

If your phone cannot connect to the robot because you have changed your router configuration, forgotten your password, or any other reason, open the top cover to see the WiFi indicator light, then press and hold the Spot Cleaning button and the Recharge button until you hear the "Resetting WiFi" voice alert. When the WiFi indicator light flashes slowly, the robot has entered network configuration mode.

Note:

If the robot is left connecting to the network for over an hour, its WiFi will be disabled. Reset WiFi before attempting reconnection.

Spot Cleaning

In Standby or Pause mode, press and hold the  button to start spot cleaning. This mode is used to clean a 1.5m x 1.5m square area centered on the robot. After cleanup, the robot will return to the center of the square.

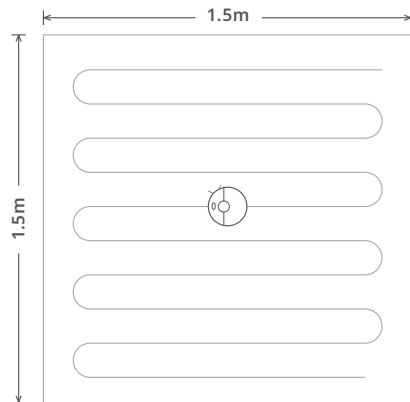

Note:

Starting spot cleaning in pause mode will stop the current cleaning cycle.

Instructions for use

Selective Room Cleaning

Select specific rooms for cleaning in the app. In this mode, the robot will only clean the selected rooms.

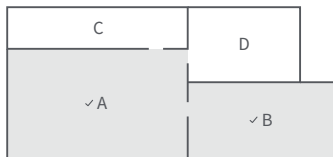

Note:

- A full map must be created and Map Saving mode switched on before this function can be used.
- After cleaning starts, the robot may move beyond the defined areas. Make sure there are no obstacles preventing the robot's access to the target rooms.

Scheduled Cleaning

Use the app to set start times for scheduled cleanups.
The robot will return to the charging dock after each cleanup.

Zone Cleaning

Use the app to draw a specific zone for the robot to clean.

Note:

While cleaning the designated zone, the robot may move outside zone borders.
Make sure that there are no cables or obstacles placed close to the cleanup zone.

Pin n Go

Use the app to set a destination for the robot to go to.

Cleaning mode

Use the app to choose from Quiet, Balanced, Strong, or MAX modes. The Balanced mode is the default.

Do Not Disturb (DND) mode

In DND mode, no cleanups will start, no voice alerts will play, and the power indicator will dim. DND Mode is set from 22:00 to 08:00 by default and can be disabled or modified in the app.

Instructions for use

Virtual No-go Zone and Invisible Wall

The app can be used to draw Virtual No-go Zone and Invisible Wall to keep the robot from entering the areas you define.

Note:

- "Map Saving Mode" must be turned on in the app to use virtual No-go Zone.
- Virtual No-go Zone and Invisible Wall should only be used to customize the cleaning area. They should not be used to isolate hazards.
- Moving the robot manually or making significant changes to the home environment may cause the loss of virtual No-go Zone and Invisible Wall.

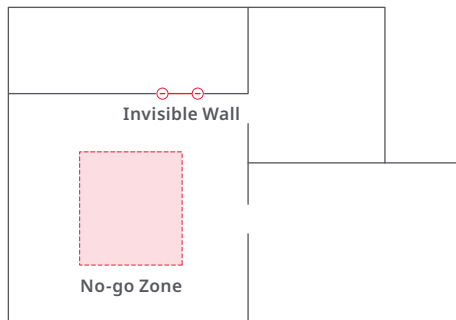

More app functions

Real-time map updates	Carpet Boost	Robot location
Change cleaning mode	Part replacement schedule	Do Not Disturb (DND) mode
View cleaning history	Remote control	Firmware update
Change robot voice	View robot status	

Note:

Functions and details of the app may vary slightly due to continuous app development and upgrades.

Charging Dock

The charging dock should be plugged in and placed against a wall on level ground, with more than 0.5m (1.6ft) of clearance on each side, and more than 1.5m (4.9ft) in front. For the best experience when using the mobile app, place the charging dock in an area with strong WiFi coverage.

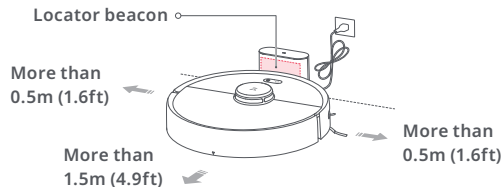

Note:

Do not place the charging dock in direct sunlight or block the locator beacon; otherwise, the robot may not be able to return to the charging dock.

Routine maintenance

Main brush

*Clean weekly

1. Turn the robot over then unlatch and remove the main brush cover.
2. Take out the main brush, remove and clean its bearings.
3. Remove the main brush cap, rotating in the unlock direction.
4. Use the supplied main brush cleaning tool to remove any entangled hair.
5. Re-install the cap and bearings following the lock direction.
6. Re-insert the main brush and secure the brush cover.

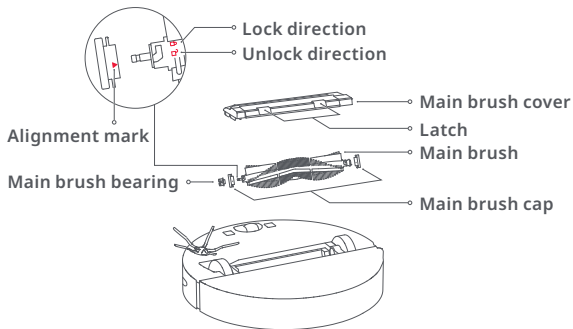

Note:
Main brush replacement every 6-12 months is recommended.

Using the main brush cleaning tool

Use the main brush cleaning tool to remove any hair entangled around the main brush.

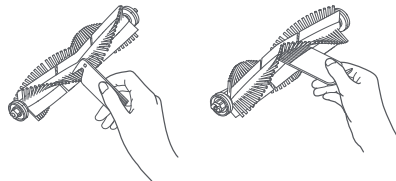

Note:
If there is a large amount of hair, or hair is tightly entangled, remove it carefully to avoid damage to the main brush.

Dustbin and filter

*Weekly cleaning is recommended

1. Open the top cover of the robot, squeeze the dustbin latch, and remove the dustbin.

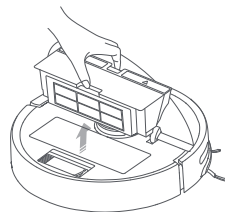

Routine maintenance

Dustbin and filter

*Weekly cleaning is recommended

2. Open the dust bin lid as indicated by the arrow and pour out the contents.

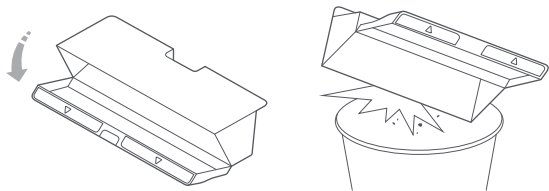

Clean the washable filter

*Clean every two weeks

1. Open the dust bin lid as indicated by the arrow and pour out the contents.

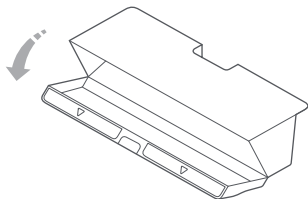

2. Fill the dust bin with clean water and close the cover. Gently shake the dust bin, then pour out the dirty water.

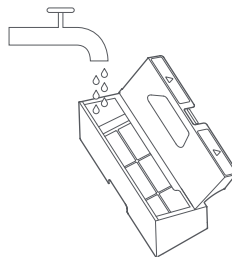

Note:

To prevent blockage, only use fresh water without cleaning liquid.

3. Remove the filter and clean it with water.

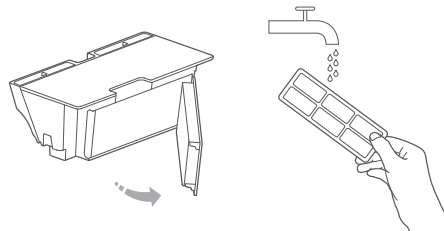

Note:

To avoid damage, do not touch the surface of the filter with hands, brushes, or sharp objects.

Routine maintenance

Clean the washable filter

*Clean every two weeks

4. Rinse repeatedly and tap the filter frame to remove as much dirt as possible.



5. Leave the filter to dry before reinstalling it.

Note:

Allow the filter to dry thoroughly before use. 24-hours of drying is recommended. Alternating between two filters is recommended.

Battery

The robot is equipped with a high-performance lithium-ion rechargeable battery pack. To maintain battery performance, keep the robot charged.

Note:

If the robot is to be left unused for an extended period, turn it off before storage and charge it at least once every three months to avoid battery damage resulting from over-discharging.

Charging dock

*Monthly cleaning recommended

Use a soft dry cloth to clean the charging contacts of the charging dock.

Side brush

*Monthly cleaning recommended

1. Turn the robot over and remove the screw holding the side brush.
2. Remove and clean the side brush.
3. Reinstall the side brush and tighten the screw.

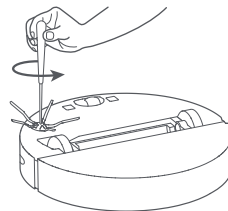

Note:

Side brush replacement every 3-6 months is recommended to maintain cleaning quality.

Routine maintenance

Omnidirectional wheel

*Clean as required

1. Turn the robot over.
2. Use a small screwdriver to pry out the axle and remove the wheel.
3. Rinse the axle and the wheel with water to remove any hair and dirt.
4. Dry and reinstall the wheel, then press it back in place.

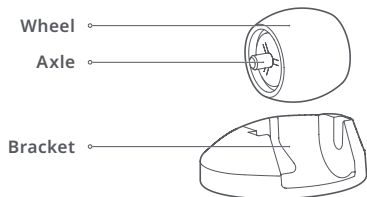

Note:

The omnidirectional wheel bracket cannot be removed.

System Reset

If the robot does not respond when you press a button or the robot cannot be shut down, press the Reset button. The robot will then restart.

Note:

After a system reset, cleaning schedules, WiFi and other settings will be restored to factory settings.

Restore factory settings

If the robot is not functioning after a system reset, turn it on, then press the  button, and then press and hold the Reset button until you hear the "Start restoring initial version" voice alert. The robot will then be restored to factory settings.

Routine maintenance

Robot sensors

*Clean monthly

Use a soft dry cloth to wipe and clean all sensors, including:

1. Four cliff sensors at the bottom of the robot.
2. The wall sensor on the right of the robot.
3. The charging contact on the bottom of the robot.
4. Robot vacuum main wheel.

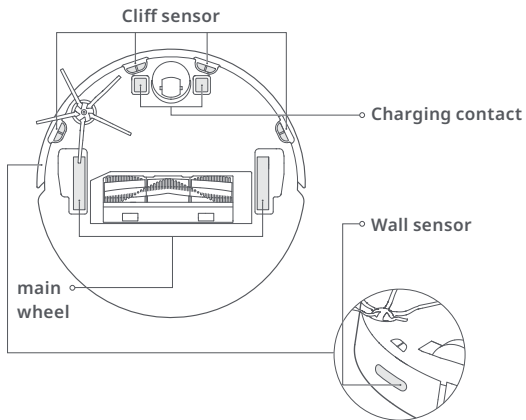

Firmware update

Update the robot using the app. Place the robot on the charging dock and ensure that the battery level is higher than 20% before updating. The power indicator will flash white quickly during a firmware update.

Basic parameters

Robot

Name	Parameters
Model	roborock S4 Max
Dimensions	350 x 350 x 96.5mm
Battery	14.4V/5200mAh lithium battery
Weight	Approx. 3.3kg
Wireless connection	WiFi Smart Connect
Rated voltage	14.4VDC
Rated power	58W
Charging time	<6h

Note:

The serial number is on a sticker on the underside of the robot.

Charging dock

Name	Parameters
Model	CDZ11RR or CDZ12RR
Dimensions	151 x 130 x 98mm
Rated power	28W
Rated input	100-240VAC
Rated output	20VDC 1.2A
Rated frequency	50-60Hz

Troubleshooting

If an error occurs during the cleanup, the power indicator will flash red quickly, and a voice alert will play. Refer to the table below for resolution options.

Error	Solution
Error 1: Rotate the laser head to check that it turns freely.	The LDS unit is jammed. Remove any items blocking it then move the robot to a new location and restart.
Error 2: Clean and lightly tap the bumper.	The bumper is stuck. Tap the bumper repeatedly to dislodge any jammed items. If nothing falls out, move the robot to a new location and restart.
Error 3: Move the robot to a new location and restart.	A wheel is suspended. Move the robot to a new location and restart it.
Error 4: Wipe the cliff sensors, move the robot away from raised edges, and restart.	The robot is suspended. Move it to a new location and restart. If the problem persists, clean the cliff sensors. This error may also be caused by a dirty cliff sensor. Try wiping all sensors clean.
Error 5: Remove the main brush and clean the brush and bearing.	The main brush may be tangled up. Remove and clean it.
Error 6: Remove and clean the side brush.	The side brush may be tangled up. Remove and clean it.
Error 7: Look for anything stuck in the main wheels then move the robot to a new location and restart.	The main wheels may be jammed. Remove and clean them.
Error 8: Clear away any obstacles around the robot.	The robot may be stuck. Clear any obstacles around it.
Error 9: Install the dustbin and filter.	Reinstall the dustbin and filter and check that they are correctly installed. If the problem persists, try replacing the filter.
Error 10: Make sure that the filter is dry or clean the filter.	The filter is not completely dry. Dry the filter for at least 24 hours. The filter may also be blocked and require cleaning. If the problem persists, replace the filter.

Troubleshooting

If an error occurs during the cleanup, the power indicator will flash red quickly, and a voice alert will play. Refer to the table below for resolution options.

Error	Solution
Error 11: High-intensity magnetic field detected.	The robot is too close to magnetic tape and cannot start. Move it to a new location and restart.
Error 12: Battery level is too low. Recharge before use.	Low battery. Recharge before use.
Error 13: Charging error. Clean the charging contact area.	Use a dry cloth to clean the charging contacts on the robot and on the charging dock.
Error 14: Battery error.	The battery temperature is either too high or too low. Wait until it returns to normal.
Error 16: Robot is tilted. Place it on flat ground and restart.	The robot is tilted. Move it to flat ground and restart.
Error 17: Side brush module error. Reset the system.	The side brush module is experiencing a fault. Reset the system.
Error 18: Vacuum fan error. Reset the system.	The vacuum fan is experiencing a fault. Reset the system.
Error 21: Vertical bumper pressed. Release it and retry.	The vertical bumper has been pressed. Relocate the robot and retry.
Error 22: Wipe the recharge sensor.	The recharge sensor is blocked by dust. Wipe the dust off.
Error 23: Clean the charging dock locator beacon.	The charging dock is jammed. Clear it and retry.
Error 24: Virtual no-go zone or wall detected. Move the robot to a new location and restart.	Move the robot away from the virtual no-go zone or barrier and restart.
Error 26: Wipe the wall sensor.	The wall sensor is dirty. Wipe it clean.
Internal error. Reset the system. *	Malfunction due to an internal error. Reset the system.

* Note: A system reset may not resolve all problems.

If the problem persists after using the recommendations in the table above, please email our after-sales service team:
US/Non-Europe Support: support@roborock.com Europe Support: support@roborock-eu.com

FAQs

Problem	Solution
Unable to power on	The battery level is low. Put the robot on the charging dock and charge it before use. The battery temperature is too low or too high. Only use the robot within the range of 4-40°C (39-104°F).
Unable to charge	If the charging dock is not receiving power, check that both ends of the power cable are properly connected. If contact is poor, clean the contact areas of the charging dock and the robot. Power is restored when the power indicator light turns on.
Slow charging	When used at high or low temperatures, the robot will automatically reduce its charging speed to extend battery life. Charging contacts may be dirty. Clean them with a dry cloth.
Unable to return to dock	There are too many obstacles near the charging dock. Move it to an open area. The robot is too far from the charging dock. Place it closer and retry.
Abnormal behavior	Restart the robot.
Noise during cleaning	The main brush, side brush, or main wheels may jammed. Turn off the robot and clean them. If the omnidirectional wheel is jammed, use a screwdriver to remove it for cleaning.
Poor cleaning performance and/or leaking dust	The Dustbin is full and needs emptying. The Filter is blocked and needs cleaning. The main brush is dirty. Clean it and retry.
Unable to connect to WiFi	WiFi is disabled. Reset the WiFi and try again. WiFi signal is poor. Make sure that the robot is in an area with good WiFi signal reception. Abnormal WiFi connection. Reset the WiFi, download the latest mobile app and retry. The current device is not supported. You can find supported models inside the app. Unable to connect to WiFi. There may be an error with your router settings. Contact Roborock customer service for help with troubleshooting.

FAQs

Problem	Solution
Scheduled cleaning is not working	The battery level is too low. Scheduled cleaning can only begin when the battery level is above 20%.
Is power always being drawn when the robot is on the charging dock?	The robot will draw power while it is docked to maintain battery performance, but power consumption is extremely low.
Does the robot need to be charged for at least 16 hours the first three times it is used?	No. The robot can be used any time after it has been fully charged once.
Cleaning does not resume after recharging	Make sure that the robot is not in DND mode. DND mode will prevent cleanup. When cleaning a space requiring a top-up charge, if the robot was placed manually on the Charging Dock before it is recharged automatically, it will not be able to continue cleanup.
The robot cannot return to the charging dock after spot cleaning or when it has been moved manually.	After spot cleaning or a significant position change, the robot will regenerate the map. If the charging dock is too far away, it may not be able to return for recharging and must be placed on the charger manually.
The robot has begun to miss certain spots	The wall sensor or cliff sensors may be dirty. Clean them with a soft dry cloth.

Robot Vacuum Cleaner

Manufacturer: Beijing Roborock Technology Co., Ltd.

Product Model: roborock S4 Max

Address of Manufacturer: Floor 6, Suite 6016, 6017, 6018, Building C, Kangjian Baosheng Plaza,
No.8 Heiquan Road, Haidian District, Beijing, P.R.CHINA

For more product information, visit our website: www.roborock.com

For after-sales support, email our after-sales service team:

US/Non-Europe Support: support@roborock.com

Europe Support: support@roborock-eu.com

