

FCC&ISED RF TEST REPORT

No. 170901088SHA-001

Applicant : Beijing Roborock Technology Co., Ltd.
Floor 6, Suite 6016, 6017, 6018, Building C, Kangjian
Baosheng Plaza, No.8 Heiquan Road, Haidian District, Beijing,
P.R. China

Manufacturing site : Sunwoda Electronic Co., Ltd
The northeast of Intersection between Keyu Rd. and
Tongguan Blvd., Gongming Street, Guangming New district,
Shenzhen City, Guangdong, PR.China

Product Name : Automatic battery-operated cleaner for household use

Type/Model : S501-01, S551-01

TEST RESULT : PASS

SUMMARY

The equipment complies with the requirements according to the following standard(s) or specification:

47CFR Part 15 (2016): Radio Frequency Devices (Subpart C)

ANSI C63.10 (2013): American National Standard of Procedures for Compliance Testing of Unlicensed Wireless Devices

RSS-247 Issue 2 (February 2017): Digital Transmission Systems (DTSs), Frequency Hopping Systems (FHSs) and Licence-Exempt Local Area Network (LE-LAN) Devices

RSS-Gen Issue 4 (November 2014): General Requirements for Compliance of Radio Apparatus

Date of issue: November 14, 2017

Prepared by:



Wade Zhang (Project engineer)

Reviewed by:

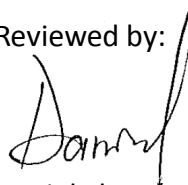

Daniel Zhao (Reviewer)

Description of Test Facility

Name: Intertek Testing Service Limited Shanghai
Address: Building No.86, 1198 Qinzhou Road (North), Shanghai 200233, P.R. China

FCC Designation Number: CN1175
IC Assigned Code: 2042B-1

Name of contact: Leah Xu
Tel: 86 21 61278200
Fax: 86 21 54262353

Content

SUMMARY.....	1
DESCRIPTION OF TEST FACILITY	2
1 GENERAL INFORMATION	4
1.1 DESCRIPTION OF CLIENT	4
1.2 IDENTIFICATION OF THE EUT	4
1.3 TECHNICAL SPECIFICATION	5
2 TEST SPECIFICATIONS.....	6
2.1 STANDARDS OR SPECIFICATION	6
2.2 MODE OF OPERATION DURING THE TEST.....	6
2.3 TEST SOFTWARE LIST	7
2.4 TEST PERIPHERALS LIST	7
2.5 INSTRUMENT LIST	8
2.6 TEST SUMMARY	9
2.7 MEASUREMENT UNCERTAINTY	10
3 MINIMUM 6DB BANDWIDTH.....	11
3.1 LIMIT	11
3.2 TEST CONFIGURATION	11
3.3 TEST PROCEDURE AND TEST SETUP	11
3.4 TEST PROTOCOL	12
4 MAXIMUM CONDUCTED OUTPUT POWER	19
4.1 TEST LIMIT	19
4.2 TEST CONFIGURATION	19
4.3 TEST PROCEDURE AND TEST SETUP	19
4.4 TEST PROTOCOL	20
5 POWER SPECTRUM DENSITY	21
5.1 TEST LIMIT	21
5.2 TEST CONFIGURATION	21
5.3 TEST PROCEDURE AND TEST SETUP	22
5.4 TEST PROTOCOL	23
6 EMISSION OUTSIDE THE FREQUENCY BAND	30
6.1 TEST LIMIT	30
6.2 TEST CONFIGURATION	30
6.3 TEST PROCEDURE AND TEST SETUP	31
6.4 TEST PROTOCOL	32
7 RADIATED EMISSIONS	57
7.1 TEST LIMIT	57
7.2 TEST CONFIGURATION	57
7.3 TEST PROCEDURE AND TEST SETUP	58
7.4 TEST PROTOCOL	59
8 POWER LINE CONDUCTED EMISSION.....	63
8.1 LIMIT	63
8.2 TEST CONFIGURATION	63
8.3 TEST PROCEDURE AND TEST SET UP	64
8.4 TEST PROTOCOL	65

1 GENERAL INFORMATION

1.1 Description of Client

Applicant : Beijing Roborock Technology Co., Ltd.
Floor 6, Suite 6016, 6017, 6018, Building C, Kangjian Baosheng Plaza, No.8 Heiquan Road, Haidian District, Beijing, P.R. China

Name of contact : Ruby Hu

Tel : 010-53241660

Fax : /

Manufacturer : Beijing Roborock Technology Co., Ltd.
Floor 6, Suite 6016, 6017, 6018, Building C, Kangjian Baosheng Plaza, No.8 Heiquan Road, Haidian District, Beijing, P.R. China

Manufacturing site : Sunwoda Electronic Co., Ltd
The northeast of Intersection between Keyu Rd. and Tongguan Blvd., Gongming Street, Guangming New district, Shenzhen City, Guangdong, PR.China

1.2 Identification of the EUT

Product Name : Automatic battery-operated cleaner for household use

Type/model : S501-01, S551-01

FCC ID : 2AN2O-RS001

IC : 23317-RS001

1.3 Technical Specification

- Operation Frequency : 2400~2483.5 MHz
Band
- Type of Modulation : DBPSK, DQPSK, CCK, BPSK, QPSK, 16-QAM,
64-QAM
- EUT Modes of Modulation : 802.11b, 802.11g, 802.11n(HT20), 802.11n(HT40)
- Channel Number : 11Channels for 802.11b, 802.11g and 802.11n(HT20),
7 Channels for 802.11n(HT40)
- Description of EUT : The EUT is a vacuum cleaner which contains a WIFI module,
there have two models, the two models are same except for
different colors, we tested S501-01 and listed the WIFI result in
this report.
- Antenna : PCB antenna, 3.7dBi Peak gain
Rating : DC14,4V
Docking station(CDZ02RR):
Input: 100-240V~, 50/60Hz, 42W
Output: 20V DC, 1,8A
- Category of EUT : Class B
- EUT type : Table top
 Floor standing
- Sample received date : September 11, 2017
Date of test : September 11, 2017 to October 23, 2017

2 TEST SPECIFICATIONS

2.1 Standards or specification

47CFR Part 15 (2016)
ANSI C63.10 (2013)
RSS-247 Issue 2 (February 2017)
RSS-Gen Issue 4 (November 2014)
KDB 558074 (v04)

2.2 Mode of operation during the test

While testing transmitting mode of EUT, the internal modulation and continuously transmission was applied.

The lowest, middle and highest channel were tested as representatives.

Frequency Band (MHz)	Mode	Lowest (MHz)	Middle (MHz)	Highest (MHz)
2400-2483.5	802.11b	2412	2437	2462
	802.11g	2412	2437	2462
	802.11n(HT20)	2412	2437	2462
	802.11n(HT40)	2422	2437	2452

Data rate VS Power:

The pre-scan for the conducted power with all rates in each modulation and bands was used, and the worst case was found and used in all test cases.

After this pre-scan, we choose the following table of the data rata as the worst case.

Frequency Band (MHz)	Mode	Worst case data rate
2400-2483.5	802.11b	1Mbps
	802.11g	6Mbps
	802.11n(HT20)	MCS0
	802.11n(HT40)	MCS0

2.3 Test software list

Test Items	Software	Manufacturer	Version
Conducted emission	ESxS-K1	R&S	V2.1.0
Radiated emission	ES-K1	R&S	V1.71

2.4 Test peripherals list

Item No.	Name	Band and Model	Description
1	Laptop computer	HP ProBook 6470b	100-240V AC, 50/60Hz

2.5 Instrument list

Radiated Emission					
Used	Equipment	Manufacturer	Type	Internal no.	Due date
<input checked="" type="checkbox"/>	Test Receiver	R&S	ESIB 26	EC 3045	2018-10-18
<input checked="" type="checkbox"/>	Bilog Antenna	TESEQ	CBL 6112D	EC 4206	2018-05-30
<input checked="" type="checkbox"/>	Horn antenna	R&S	HF 906	EC 3049	2018-09-22
<input checked="" type="checkbox"/>	Horn antenna	ETS	3117	EC 4792-1	2018-08-23
<input checked="" type="checkbox"/>	Horn antenna	TOYO	HAP18-26W	EC 4792-3	2020-07-09
<input checked="" type="checkbox"/>	Pre-amplifier	R&S	Pre-amp 18	EC5881	2018-06-19
<input checked="" type="checkbox"/>	Semi-anechoic chamber	Albatross project	-	EC 3048	2018-09-08
RF test					
Used	Equipment	Manufacturer	Type	Internal no.	Due date
<input checked="" type="checkbox"/>	PXA Signal Analyzer	Keysight	N9030A	EC 5338	2018-09-10
<input checked="" type="checkbox"/>	Power sensor	Agilent	U2021XA	EC 5338-1	2018-03-03
<input checked="" type="checkbox"/>	Vector Signal Generator	Agilent	N5182B	EC 5175	2018-03-06
<input checked="" type="checkbox"/>	MXG Analog Signal Generator	Agilent	N5181A	EC 5338-2	2018-03-03
<input checked="" type="checkbox"/>	Mobile Test System	Litepoint	lqxel	EC 5176	2018-01-11
<input checked="" type="checkbox"/>	Test Receiver	R&S	ESCI 7	EC 4501	2018-02-23
Additional instrument					
Used	Equipment	Manufacturer	Type	Internal no.	Due date
<input checked="" type="checkbox"/>	Therom-Hygrograph	ZJ1-2A	S.M.I.F.	EC 3323	2018-06-14
<input checked="" type="checkbox"/>	Therom-Hygrograph	ZJ1-2A	S.M.I.F.	EC 3324	2018-04-09
<input checked="" type="checkbox"/>	Therom-Hygrograph	ZJ1-2A	S.M.I.F.	EC 3325	2018-03-23
<input checked="" type="checkbox"/>	Pressure meter	YM3	Shanghai Mengde	EC 3320	2018-06-28

2.6 Test Summary

This report applies to tested sample only. The test results have been compared directly with the limits, and the measurement uncertainty is recorded. This report shall not be reproduced in part without written approval of Intertek Testing Service Shanghai Limited.

TEST ITEM	FCC REFERANCE	IC REFERANCE	RESULT
Minimum 6dB Bandwidth	15.247(a)(2)	RSS-247 Issue 2 Clause 5.2	Pass
Maximum peak output power	15.247(b)	RSS-247 Issue 2 Clause 5.4	Pass
Power spectrum density	15.247(e)	RSS-247 Issue 2 Clause 5.2	Pass
Radiated emission	15.205 & 15.209	RSS-247 Issue 2 Clause 5.5	Pass
Emission outside the frequency band	15.247(d)	RSS-Gen Issue 4 Clause 8.9	Pass
Power line conducted emission	15.207	RSS-Gen Issue 4 Clause 8.8	Pass
Occupied bandwidth	-	RSS-Gen Issue 4 Clause 6.6	Tested

Notes: 1: NA =Not Applicable

2: This report is for the exclusive use of Intertek's Client and is provided pursuant to the agreement between Intertek and its Client. Intertek's responsibility and liability are limited to the terms and conditions of the agreement. Intertek assumes no liability to any party, other than to the Client in accordance with the agreement, for any loss, expense or damage occasioned by the use of this report. Only the Client is authorized to permit copying or distribution of this report and then only in its entirety. Any use of the Intertek name or one of its marks for the sale or advertisement of the tested material, product or service must first be approved in writing by Intertek. The observations and test results in this report are relevant only to the sample tested. This report by itself does not imply that the material, product, or service is or has ever been under an Intertek certification program.

2.7 Measurement uncertainty

The measurement uncertainty represents an expanded uncertainty expressed at approximately the 95% confidence level using a coverage factor of k=2.

Test item	Measurement uncertainty
Maximum peak output power	± 0.74dB
Radiated Emissions in restricted frequency bands below 1GHz	± 4.90dB
Radiated Emissions in restricted frequency bands above 1GHz	± 5.02dB
Emission outside the frequency band	± 2.89dB
Power line conducted emission	± 3.19dB

3 Minimum 6dB Bandwidth

Test result: Pass

3.1 Limit

For systems using digital modulation techniques that may operate in the 902 - 928 MHz, 2400 - 2483.5 MHz and 5725 - 5850 MHz bands, the minimum 6 dB bandwidth shall be at least 500 kHz.

3.2 Test Configuration

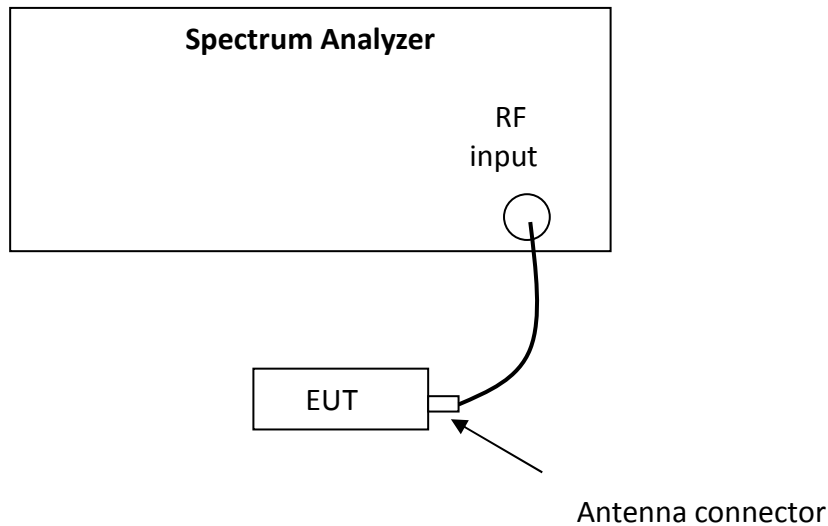

3.3 Test Procedure and test setup

The minimum 6dB bandwidth per FCC §15.247(a)(2) is measured using the Spectrum Analyzer according to DTS test procedure of "KDB558074 D01 DTS Meas Guidance" for compliance to FCC 47CFR 15.247 requirements (clause 8.2).

- a) Set RBW = 100 kHz.
- b) Set the video bandwidth (VBW) $\geq 3 \times$ RBW.
- c) Detector = Peak.
- d) Trace mode = max hold.
- e) Sweep = auto couple.
- f) Allow the trace to stabilize.
- g) Measure the maximum width of the emission that is constrained by the frequencies associated with the two outermost amplitude points (upper and lower frequencies) that are attenuated by 6 dB relative to the maximum level measured in the fundamental emission.

3.4 Test Protocol

Temperature: 25 °C
Relative Humidity: 55 %

Mode	Channel	Minimum 6dB Bandwidth (MHz)	Limits (MHz)
802.11b	L	10.07	> 0.5
	M	10.08	> 0.5
	H	10.07	> 0.5
802.11g	L	16.57	> 0.5
	M	16.57	> 0.5
	H	16.57	> 0.5
802.11n (HT20)	L	17.80	> 0.5
	M	17.80	> 0.5
	H	17.80	> 0.5
802.11n (HT40)	L	36.45	> 0.5
	M	36.46	> 0.5
	H	36.46	> 0.5

Mode	Channel	99% Occupy Bandwidth (MHz)	Limits (MHz)
802.11b	L	15.245	-
	M	15.401	-
	H	15.435	-
802.11g	L	16.504	-
	M	16.512	-
	H	16.508	-
802.11n (HT20)	L	17.700	-
	M	17.707	-
	H	17.713	-
802.11n (HT40)	L	36.054	-
	M	36.061	-
	H	36.070	-

Test Plots:

802.11b-2412MHz

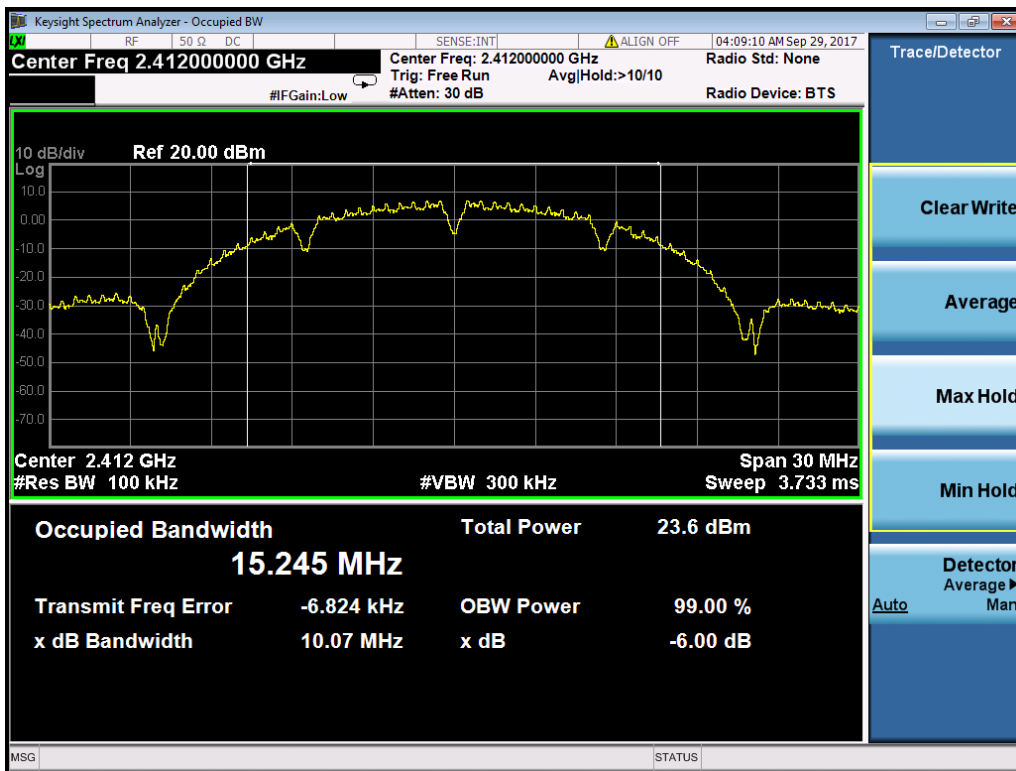

802.11b-2437MHz

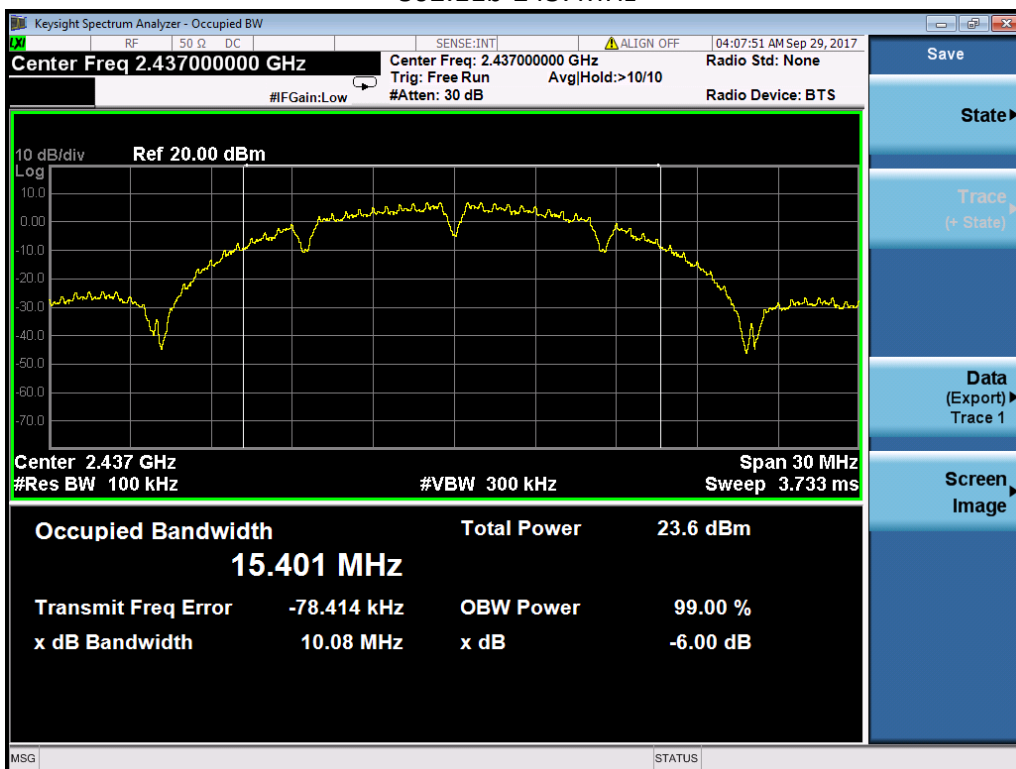

802.11b-2462MHz

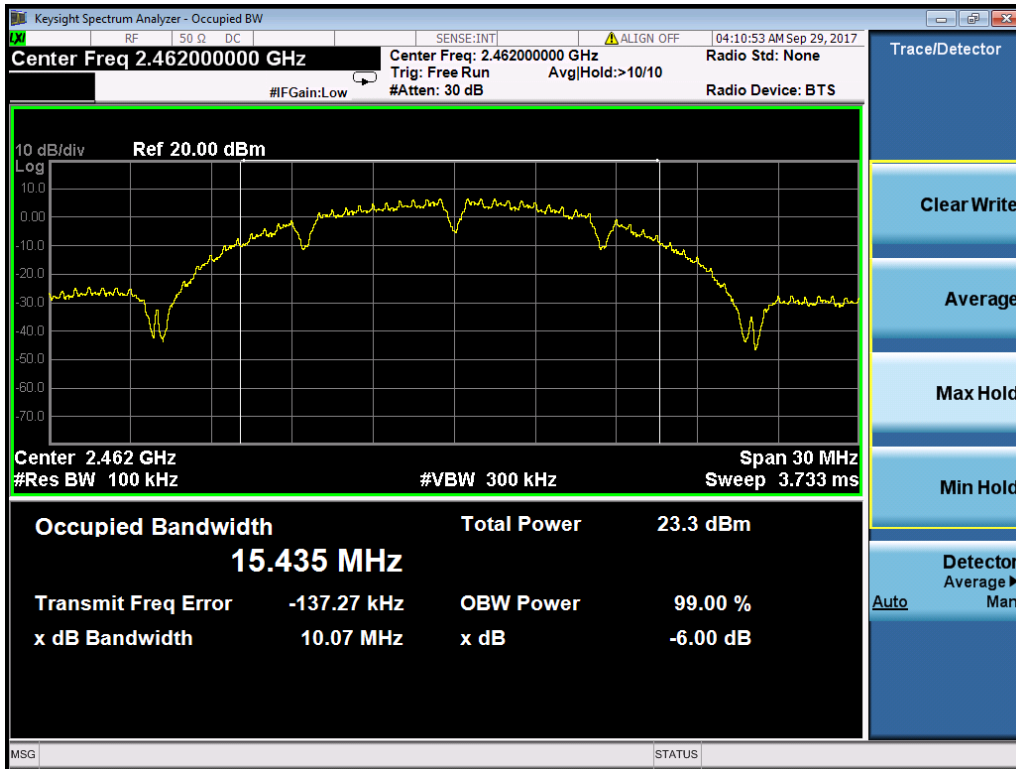

802.11g-2412MHz

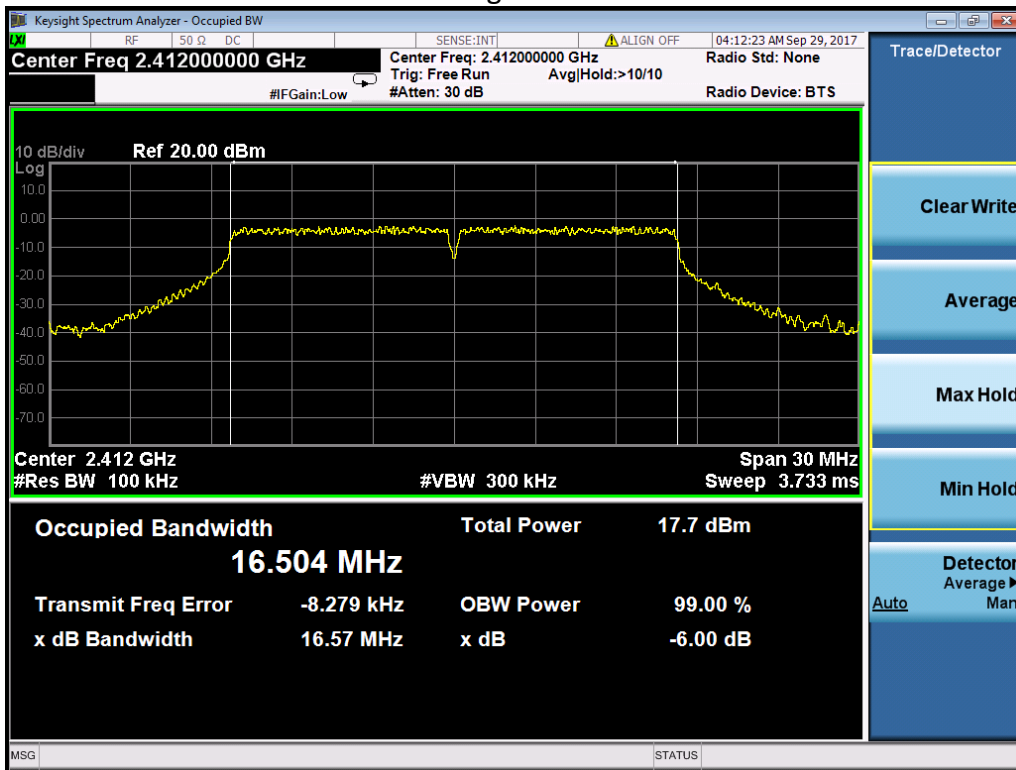

802.11g-2437MHz

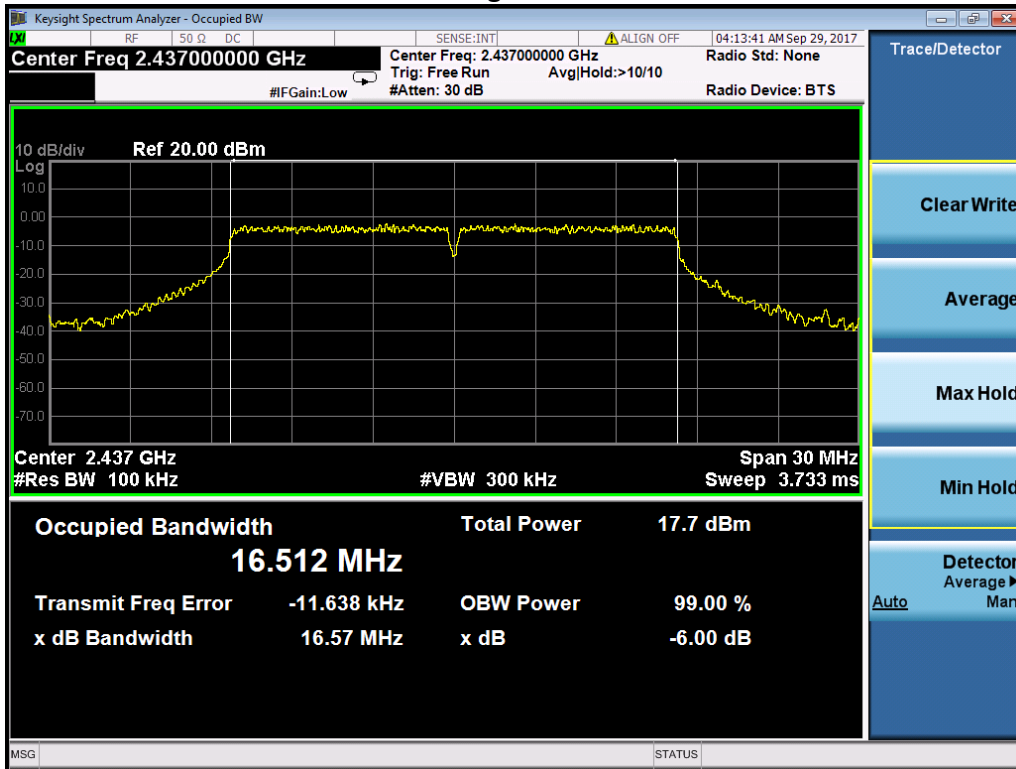

802.11g-2462MHz

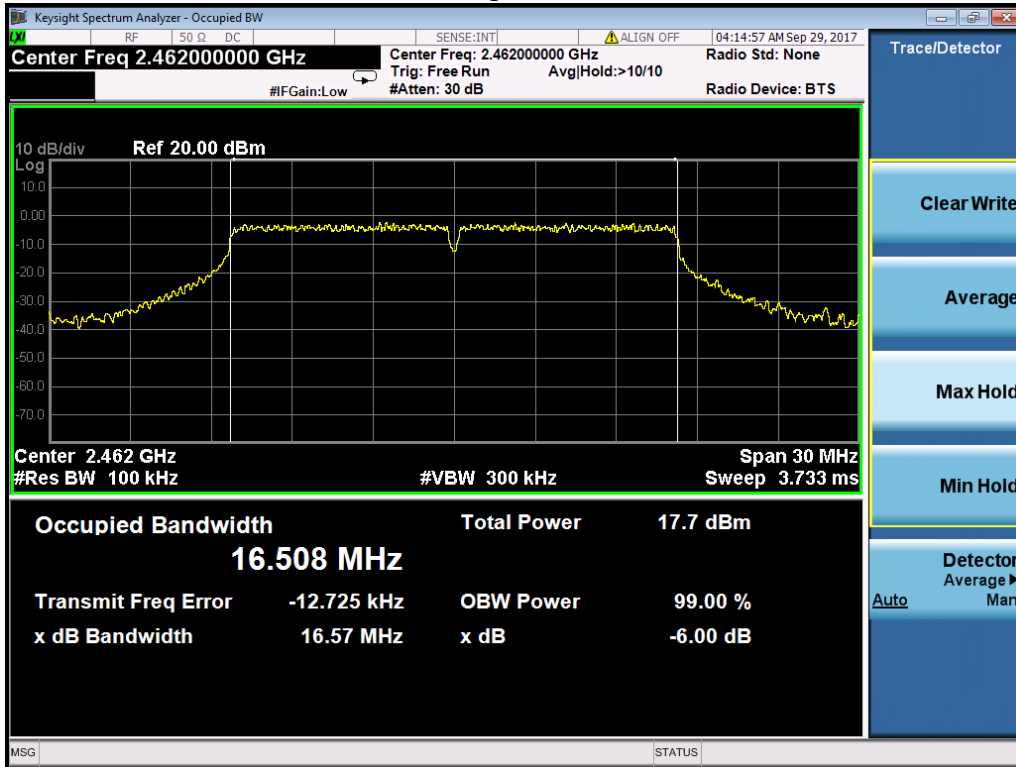

802.11n20-2412MHz

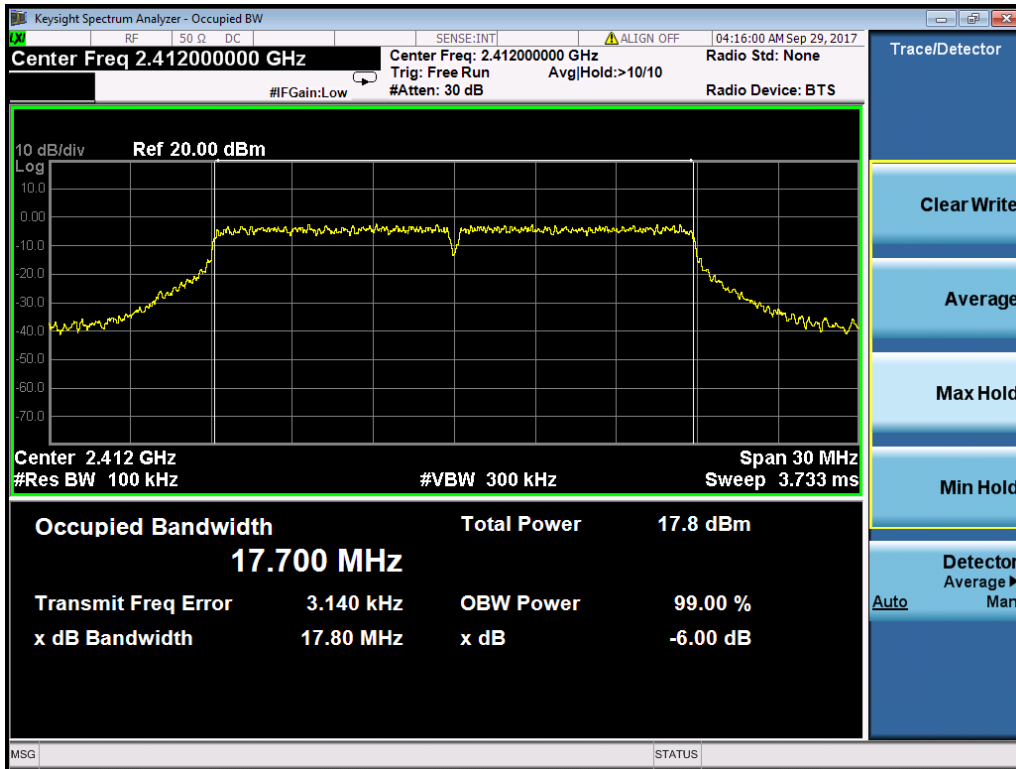

802.11n20-2437MHz

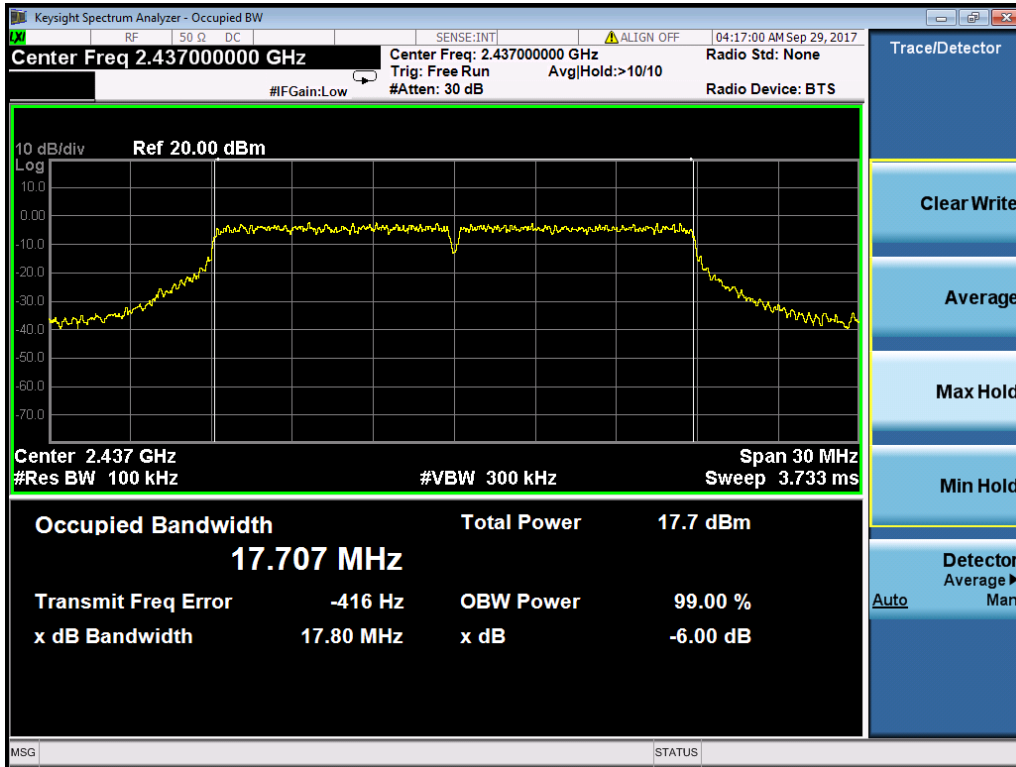

802.11n20-2462MHz

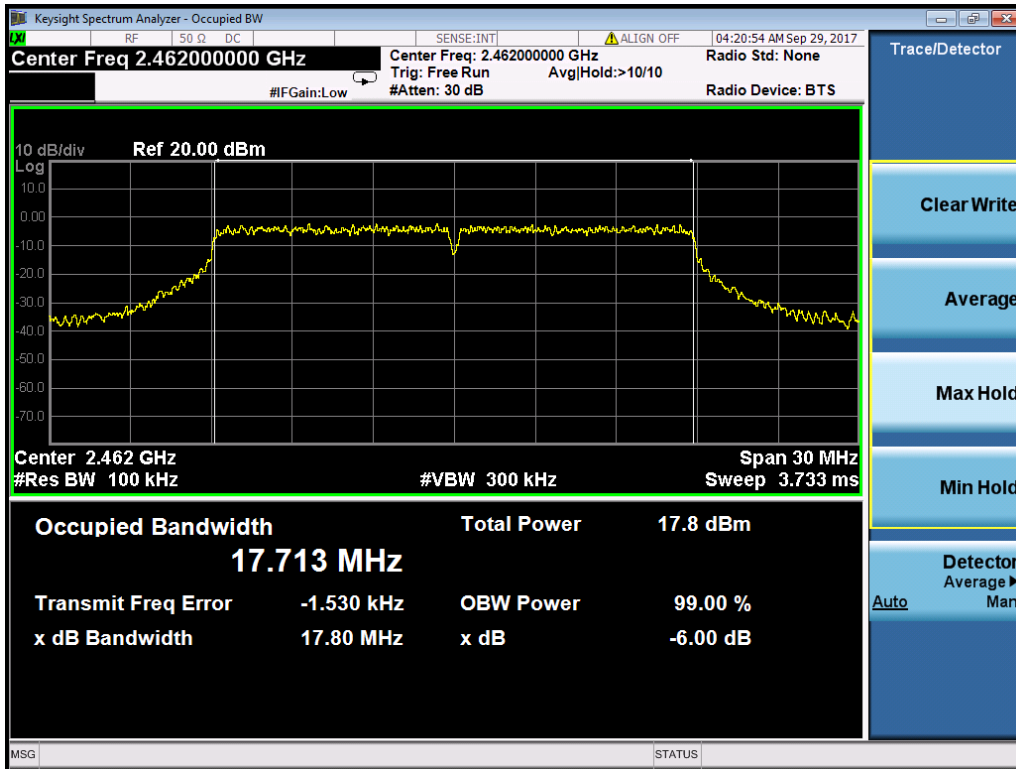

802.11n40-2422MHz

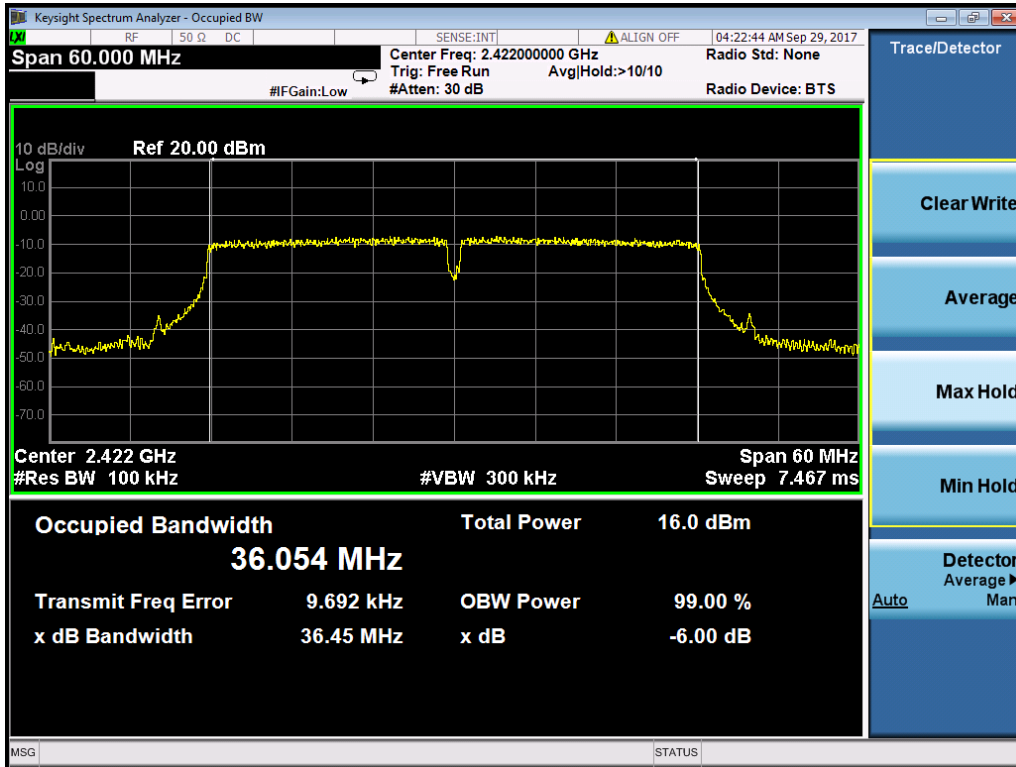

802.11n40-2437MHz

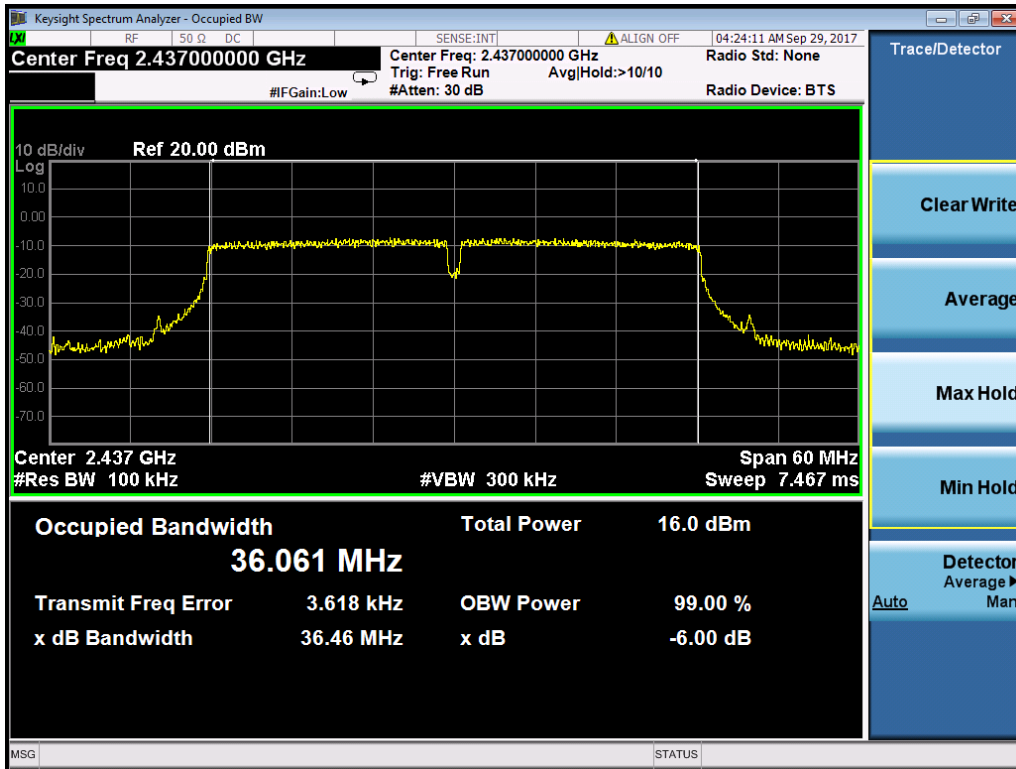

802.11n40-2452MHz

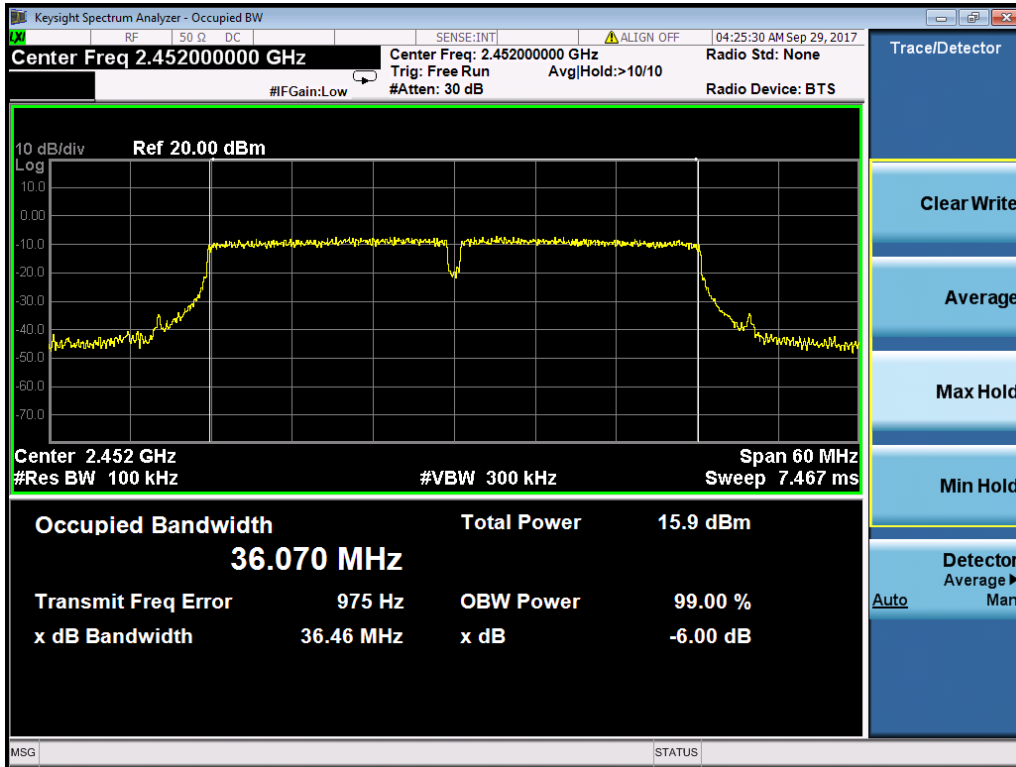

4 Maximum Conducted Output power

Test result: Pass

4.1 Test limit

- For frequency hopping systems operating in the 2400-2483.5 MHz band employing at least 75 non-overlapping hopping channels, and all frequency hopping systems in the 5725-5850 MHz band: 1 watt
- For all other frequency hopping systems in the 2400-2483.5 MHz band: 0.125 watts
- For systems using digital modulation in the 902-928 MHz, 2400-2483.5 MHz, and 5725-5850 MHz bands: 1 Watt and the e.i.r.p. shall not exceed 4 W.

If the transmitting antenna of directional gain greater than 6dBi is used, the power shall be reduced by the amount in dB that the directional gain of the antenna exceeds 6dBi. If there have a beam forming type, the limit should be the minimum of 30dBm and 30+ (6 –antenna gain-beam forming gain).

4.2 Test Configuration

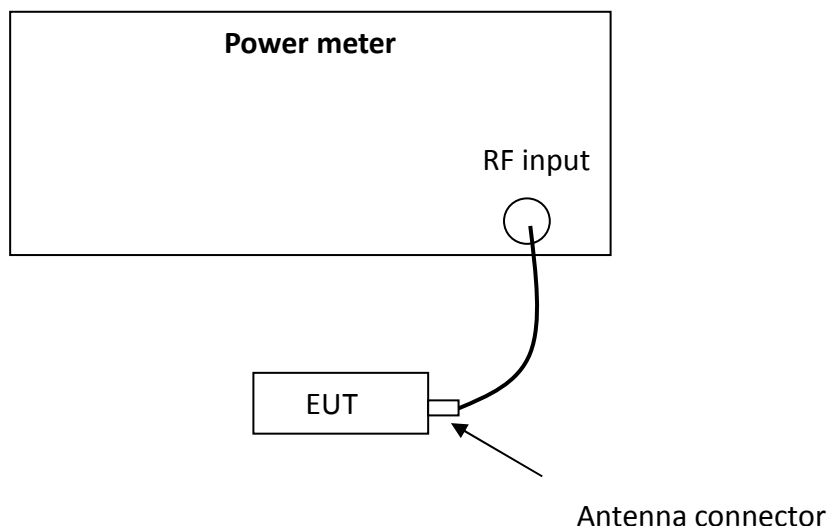

4.3 Test procedure and test setup

The EUT was tested according to DTS test procedure of “KDB558074 D01 DTS Meas Guidance” for compliance to FCC 47CFR 15.247 requirements (clause 9.1.3 PKPM Method.).

4.4 Test protocol

Temperature: 25 °C
Relative Humidity: 55 %

Mode	Channel	Corrected Reading (dBm)	Limit (dBm)	Result
802.11b	L	20.82	30.00	Pass
	M	20.59	30.00	Pass
	H	20.37	30.00	Pass
802.11g	L	22.56	30.00	Pass
	M	22.05	30.00	Pass
	H	21.96	30.00	Pass
802.11n (HT20)	L	21.99	30.00	Pass
	M	21.65	30.00	Pass
	H	21.45	30.00	Pass
802.11n (HT40)	L	21.01	30.00	Pass
	M	20.85	30.00	Pass
	H	20.70	30.00	Pass

Conclusion: The maximum EIRP = 22.56dBm+3.7dBi = 26.26dBm = 0.423W which is lower than the limit of 4W listed in RSS-247.

5 Power spectrum density

Test result:Pass

5.1 Test limit

For digitally modulated systems, the power spectral density conducted from the intentional radiator to the antenna shall not be greater than 8dBm in any 3kHz band during any time interval of continuous transmission.

If the transmitting antenna of directional gain greater than 6dBi is used, the power shall be reduced by the amount in dB that the directional gain of the antenna exceeds 6dBi. If there have a beam forming type, the limit should be the minimum of 8dBm/3kHz and $8 + (6 - \text{antenna gain} - \text{beam forming gain})$.

5.2 Test Configuration

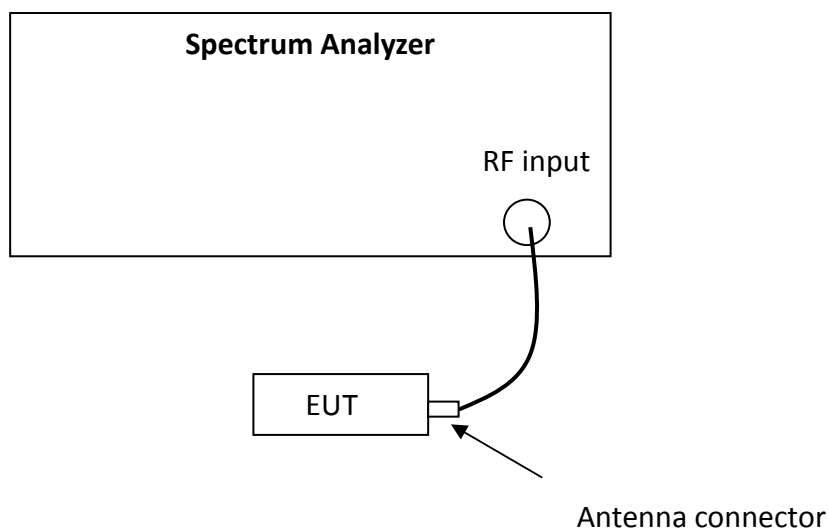

5.3 Test procedure and test setup

The power output per FCC §15.247(e) was tested according to DTS test procedure of “KDB558074 D01 DTS Meas Guidance” (clause 10.2) for compliance to FCC 47CFR 15.247 requirements.

- a) Set analyzer center frequency to DTS channel center frequency.
- b) Set the span to 1.5 times the *DTS bandwidth*.
- c) Set the RBW to: $3 \text{ kHz} \leq \text{RBW} \leq 100 \text{ kHz}$.
- d) Set the VBW $\geq 3 \times \text{RBW}$.
- e) Detector = peak.
- f) Sweep time = auto couple.
- g) Trace mode = max hold.
- h) Allow trace to fully stabilize.
- i) Use the peak marker function to determine the maximum amplitude level within the RBW.
- j) If measured value exceeds limit, reduce RBW (no less than 3 kHz) and repeat.

5.4 Test Protocol

Temperature: 25 °C
Relative Humidity: 55 %

Mode	Channel	Max PSD (dBm/100KHz)	Limit (dBm /3kHz)	Result
802.11b	L	7.434	8	Pass
	M	7.086	8	Pass
	H	6.984	8	Pass
802.11g	L	-2.302	8	Pass
	M	-2.247	8	Pass
	H	-2.278	8	Pass
802.11n (HT20)	L	-2.074	8	Pass
	M	-1.973	8	Pass
	H	-2.004	8	Pass
802.11n (HT40)	L	-5.900	8	Pass
	M	-5.928	8	Pass
	H	-6.090	8	Pass

Test Plots:

802.11b-2412MHz

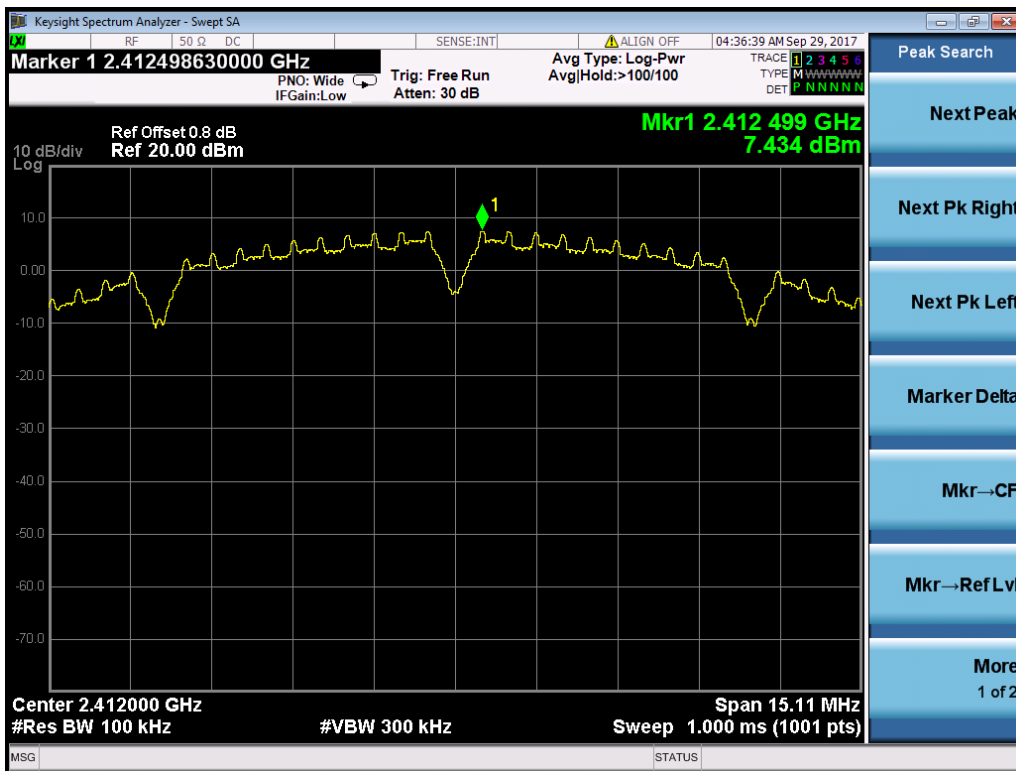

802.11b-2437MHz

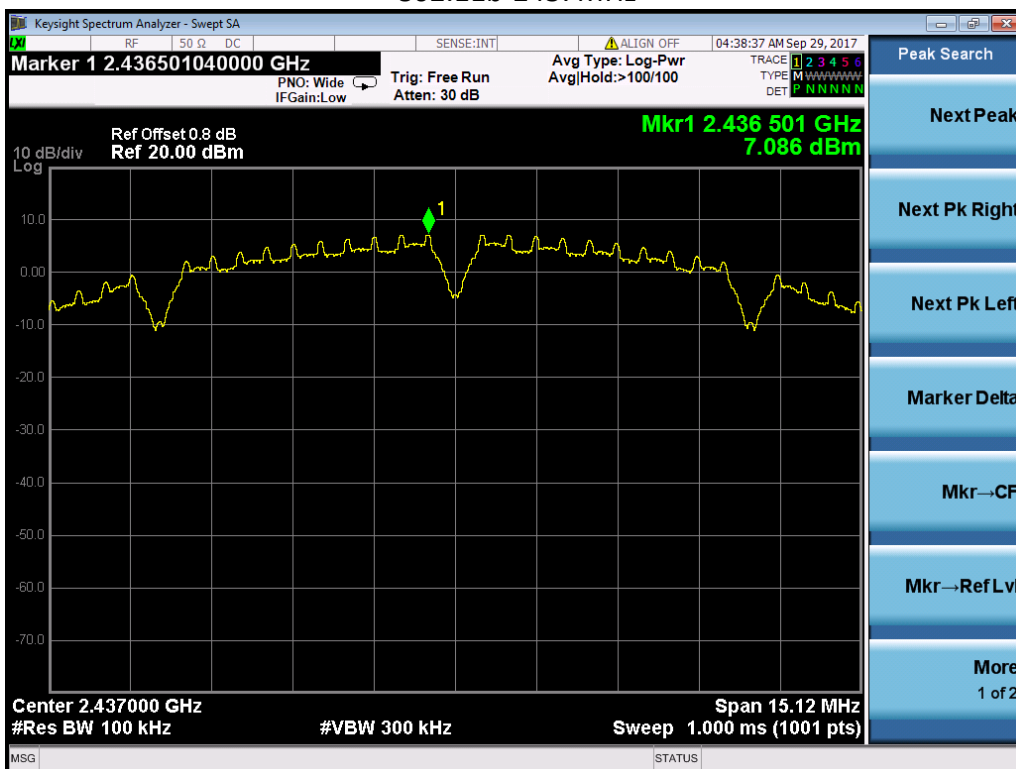

802.11b-2462MHz

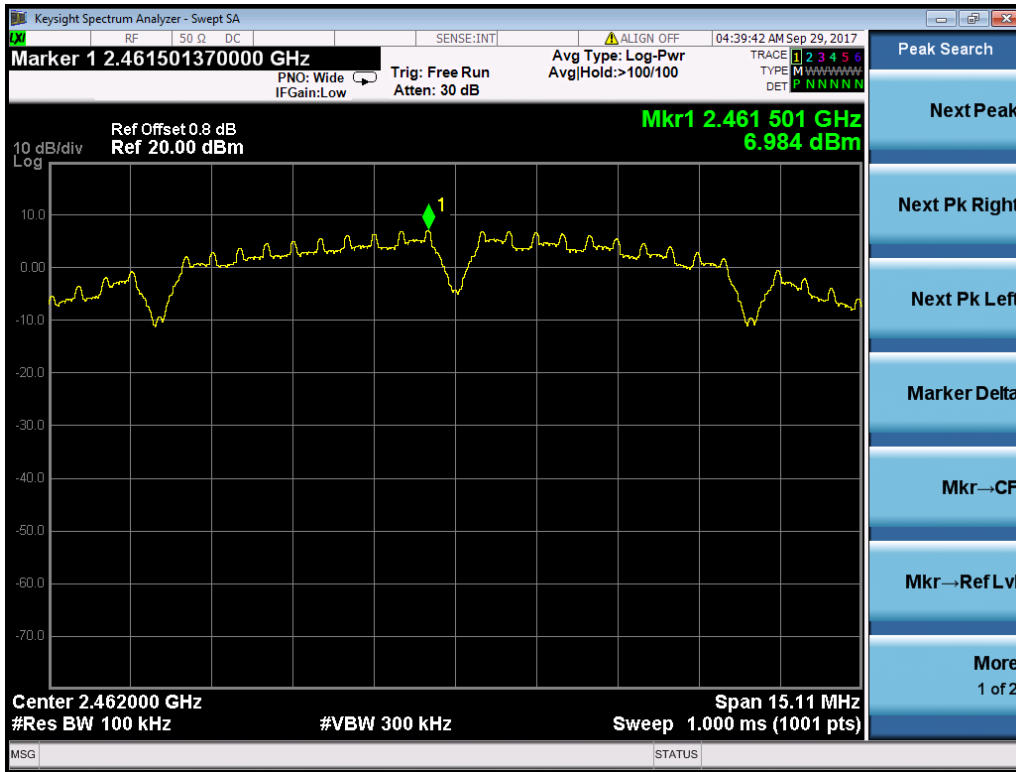

802.11g-2412MHz

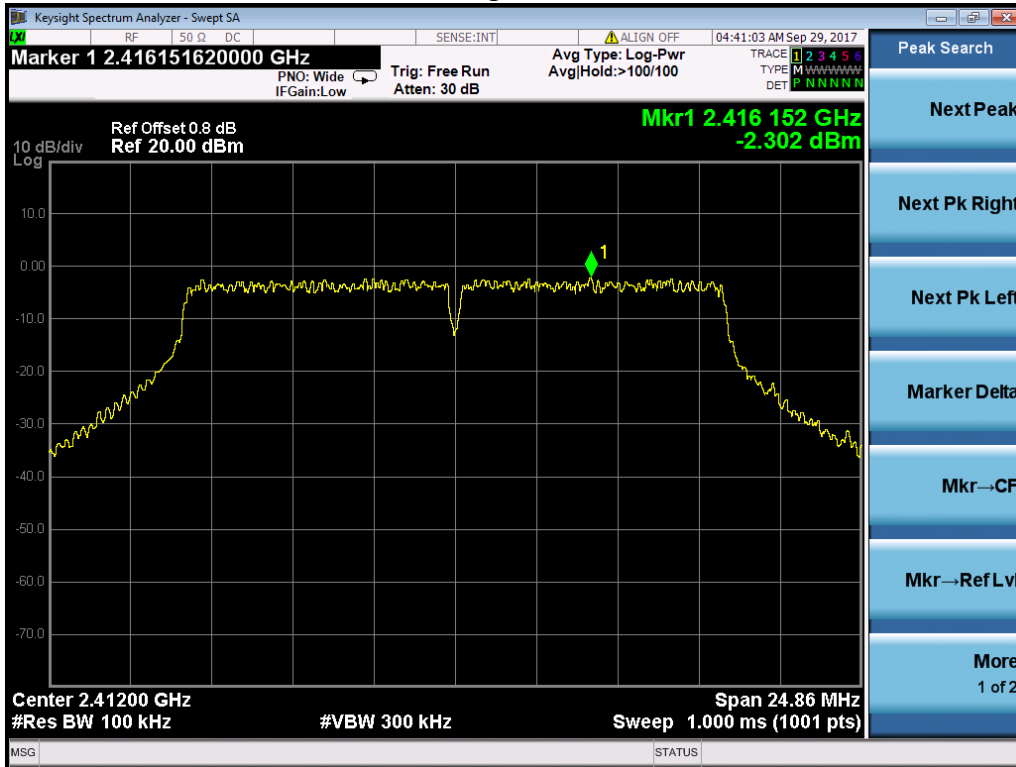

802.11g-2437MHz

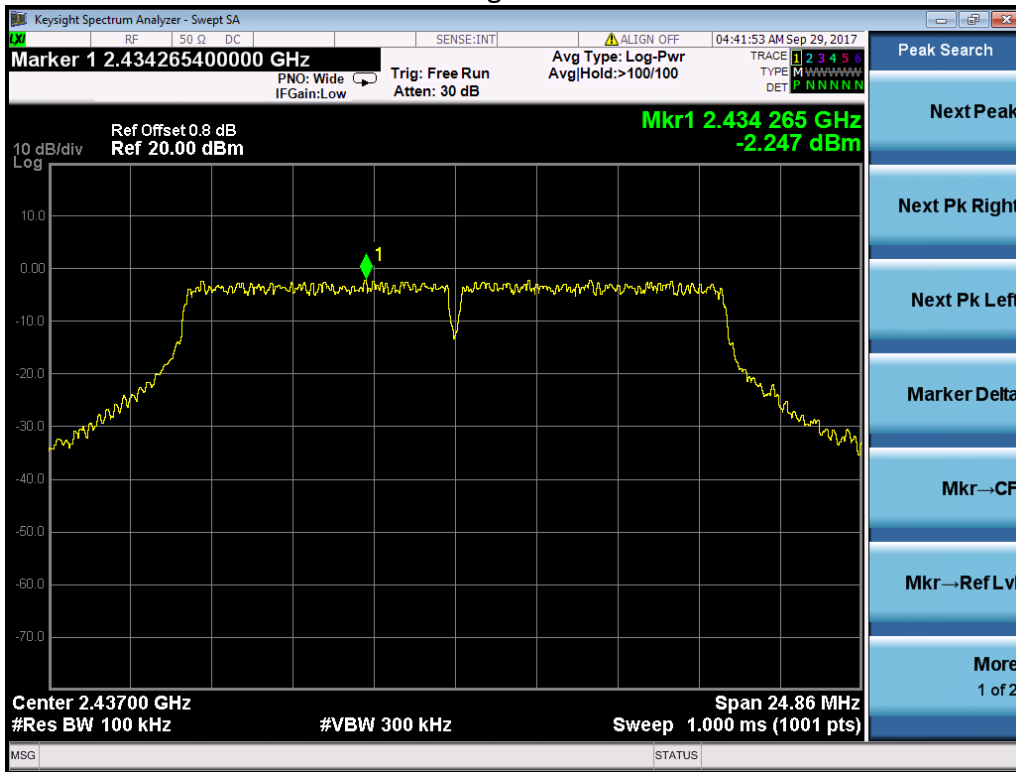

802.11g-2462MHz

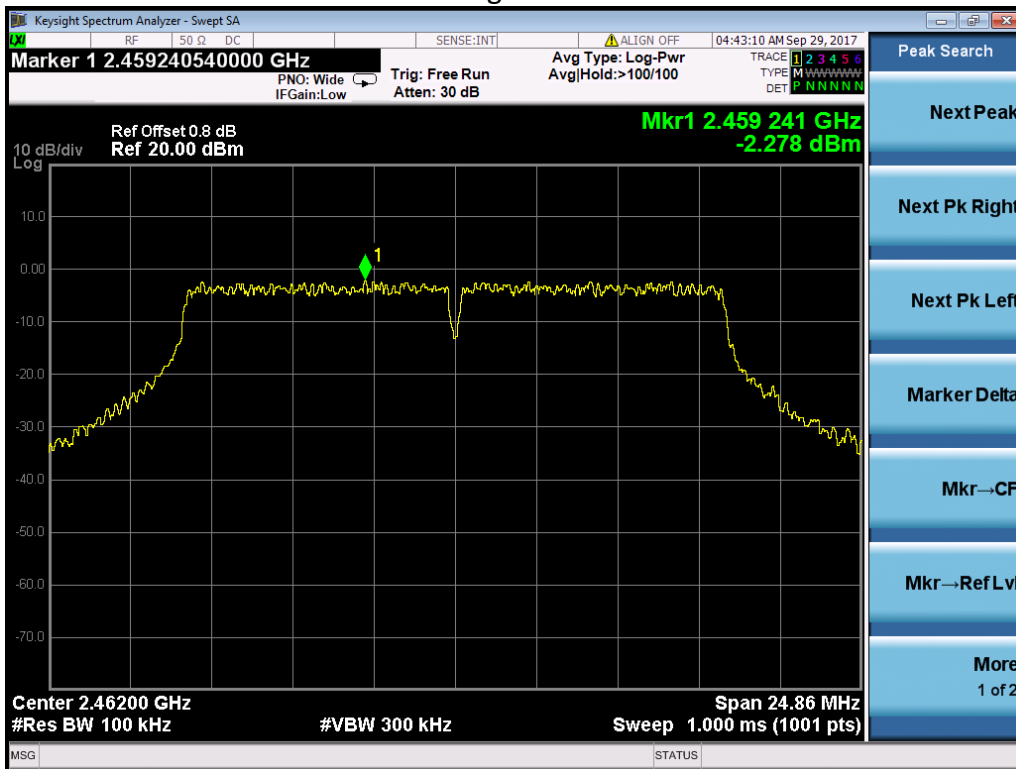

802.11n20-2412MHz

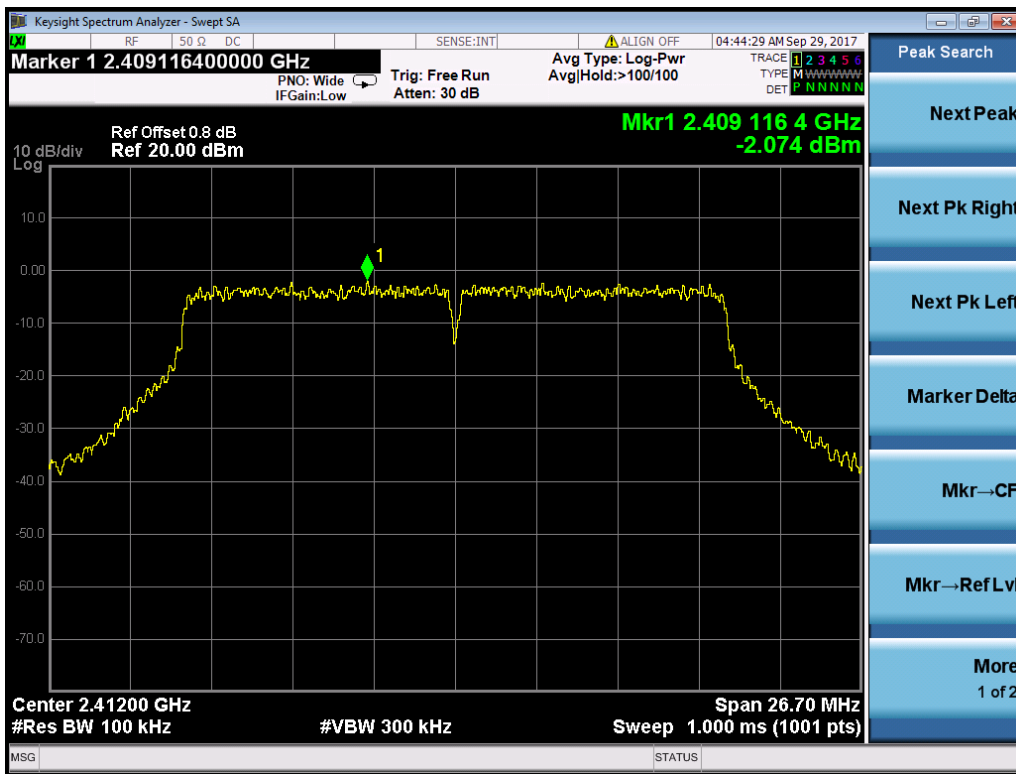

802.11n20-2437MHz

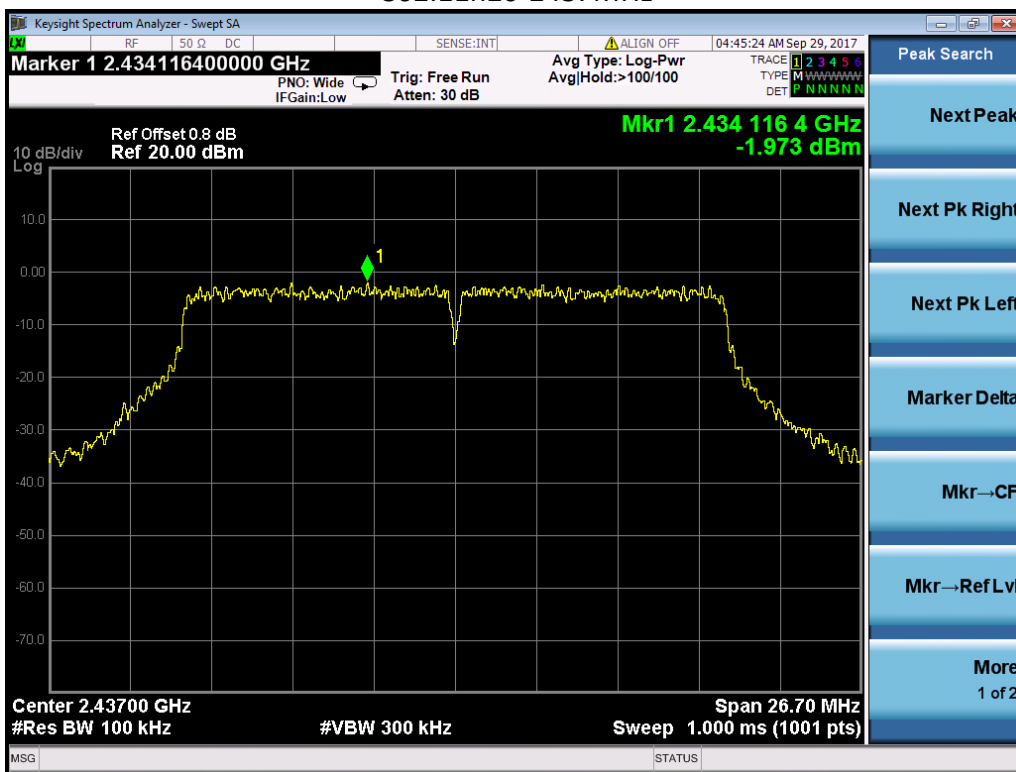

802.11n20-2462MHz

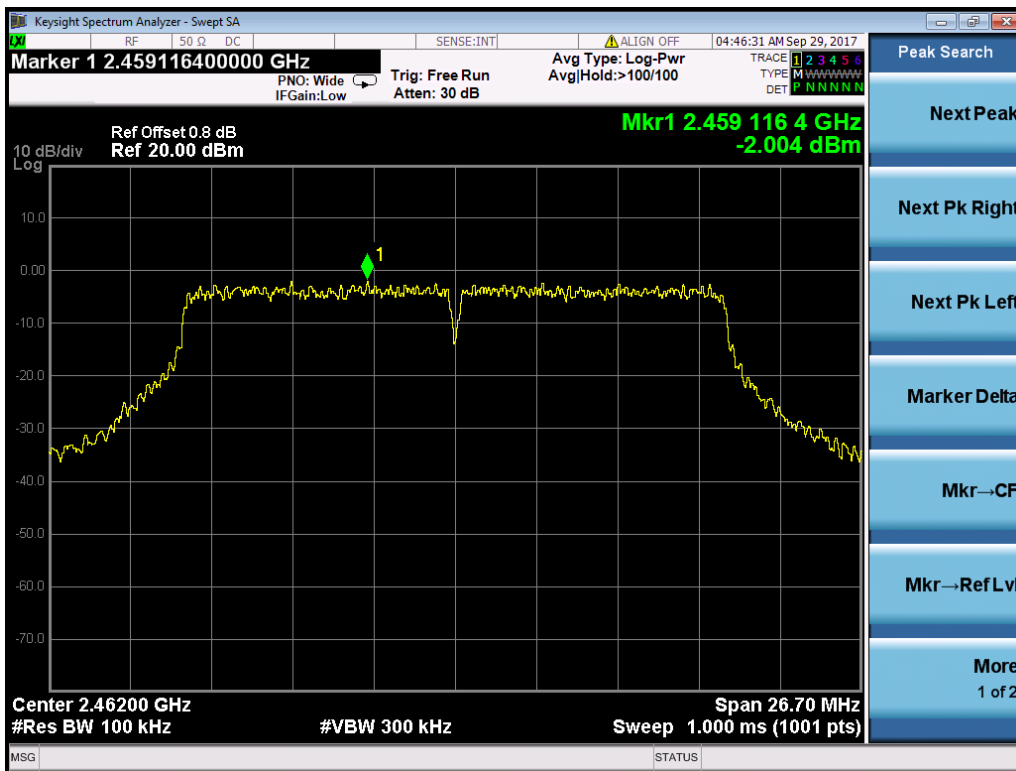

802.11n40-2422MHz

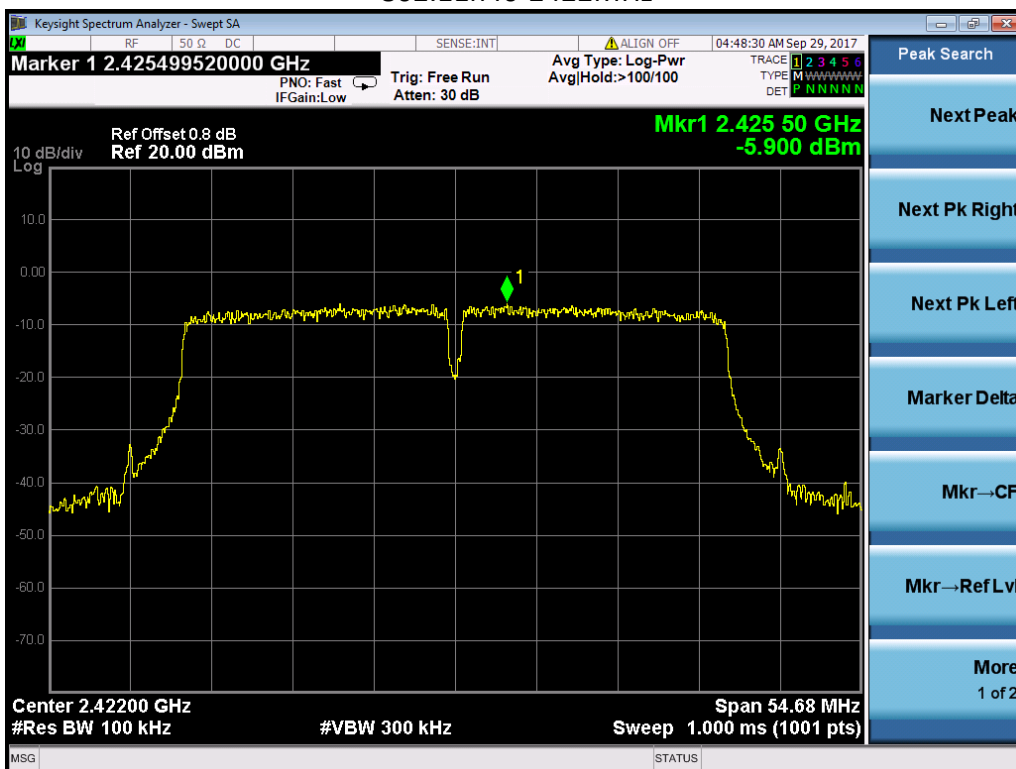

802.11n40-2437MHz

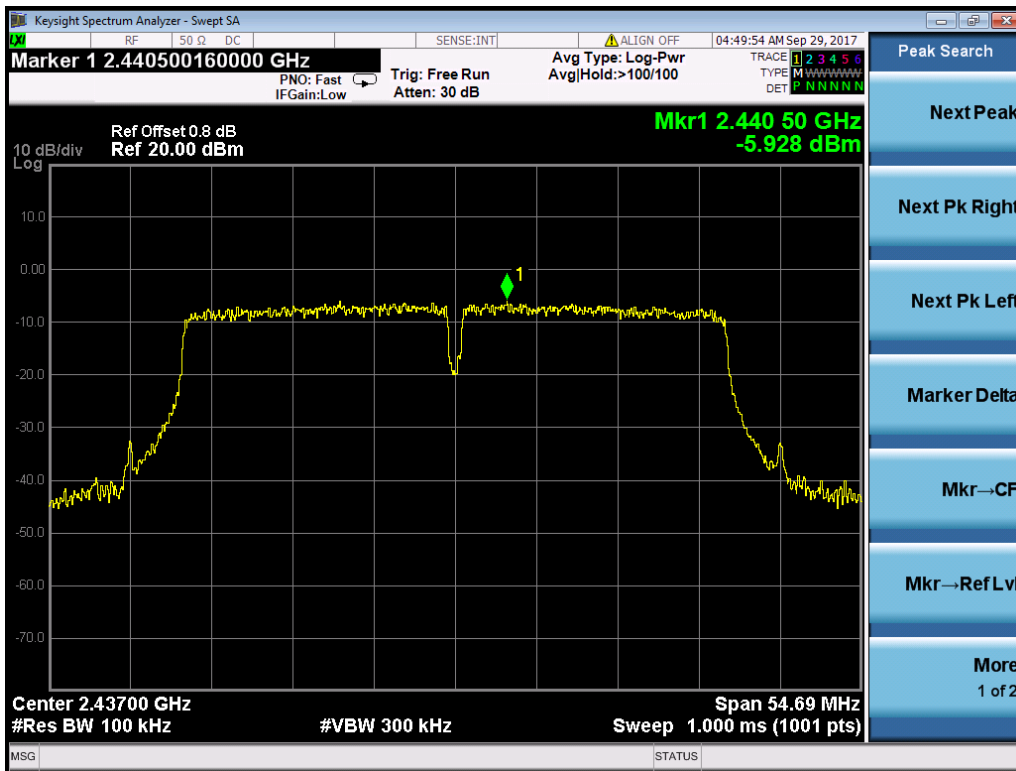

802.11n40-2452MHz

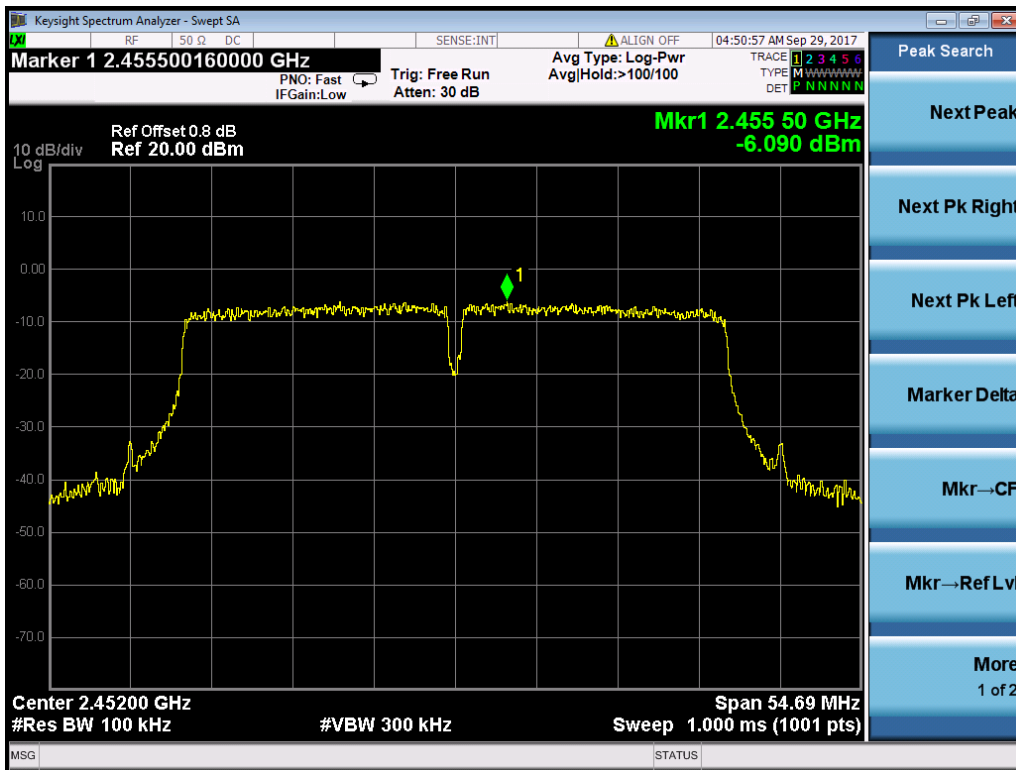

6 Emission outside the frequency band

Test result: Pass

6.1 Test limit

In any 100kHz bandwidth outside the frequency band in which the spread spectrum intentional radiator is operating, the radio frequency power that is produced by the intentional radiator shall be at least 20dB below that in the 100kHz bandwidth within the band that contains the highest level of the desired power.

6.2 Test Configuration

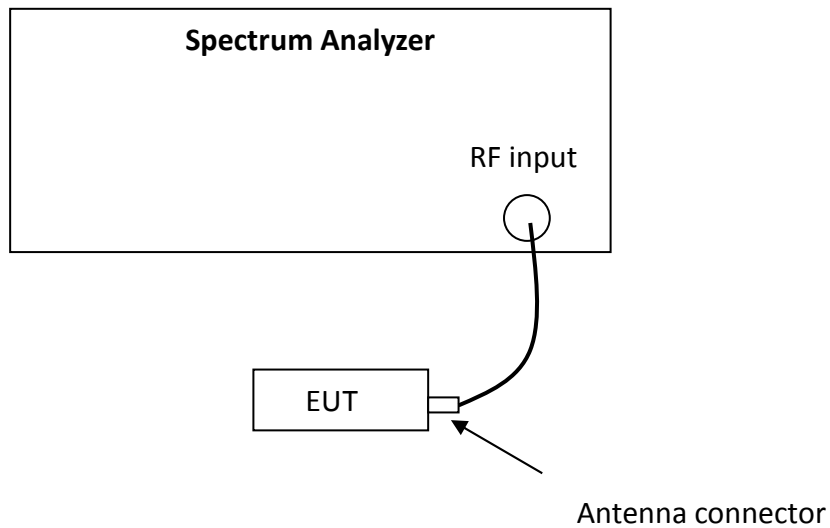

6.3 Test procedure and test setup

The EUT was tested according to DTS test procedure of “KDB558074 D01 DTS Meas Guidance” (clause 11.0) for compliance to FCC 47CFR 15.247 requirements.

Reference level measurement

Establish a reference level by using the following procedure:

- a) Set instrument center frequency to DTS channel center frequency.
- b) Set the span to ≥ 1.5 times the *DTS bandwidth*.
- c) Set the RBW = 100 kHz.
- d) Set the VBW $\geq 3 \times$ RBW.
- e) Detector = peak.
- f) Sweep time = auto couple.
- g) Trace mode = max hold.
- h) Allow trace to fully stabilize.
- i) Use the peak marker function to determine the maximum PSD level.

Note that the channel found to contain the maximum PSD level can be used to establish the reference level.

Emission level measurement

- a) Set the center frequency and span to encompass frequency range to be measured.
- b) Set the RBW = 100 kHz.
- c) Set the VBW $\geq 3 \times$ RBW.
- d) Detector = peak.
- e) Sweep time = auto couple.
- f) Trace mode = max hold.
- g) Allow trace to fully stabilize.
- h) Use the peak marker function to determine the maximum amplitude level.

Ensure that the amplitude of all unwanted emissions outside of the authorized frequency band (excluding restricted frequency bands) are attenuated by at least the minimum requirements specified in 11.1 a) or 11.1 b). Report the three highest emissions relative to the limit.

6.4 Test Protocol

Temperature: 25 °C
Relative Humidity: 55 %

Mode	Channel	Results	Limits (dB)
802.11b	L	Pass	≥20
	M	Pass	≥20
	H	Pass	≥20
802.11g	L	Pass	≥20
	M	Pass	≥20
	H	Pass	≥20
802.11n (HT20)	L	Pass	≥20
	M	Pass	≥20
	H	Pass	≥20
802.11n (HT40)	L	Pass	≥20
	M	Pass	≥20
	H	Pass	≥20

Test Plots of Spurious emission:

802.11b-2412MHz

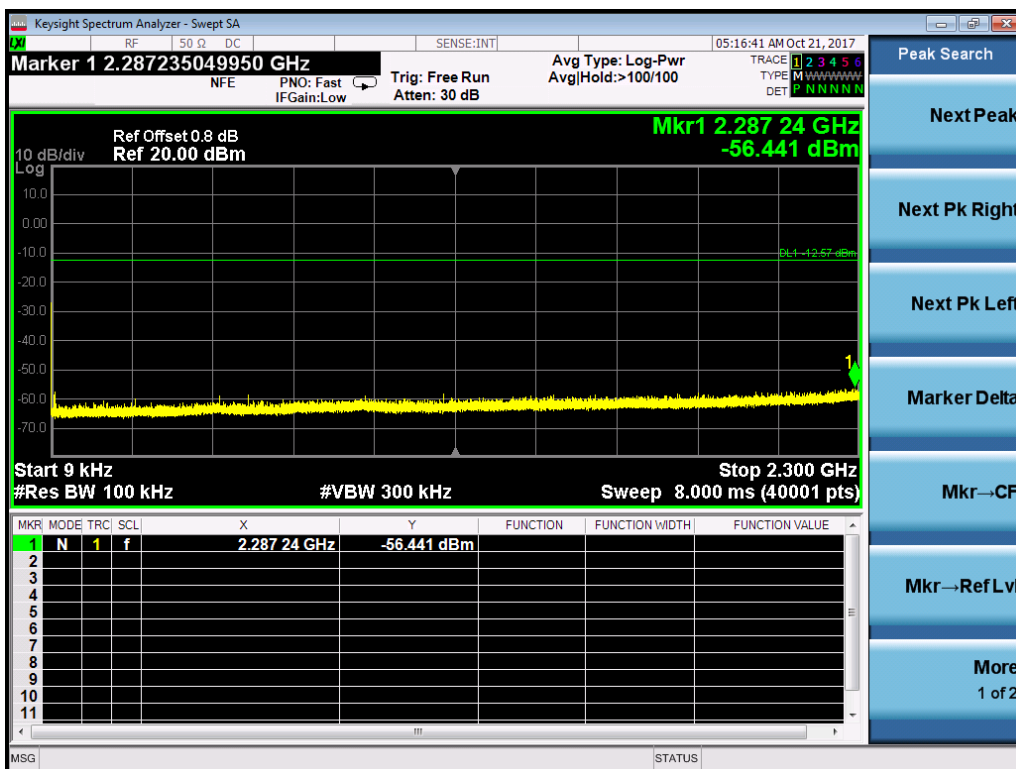
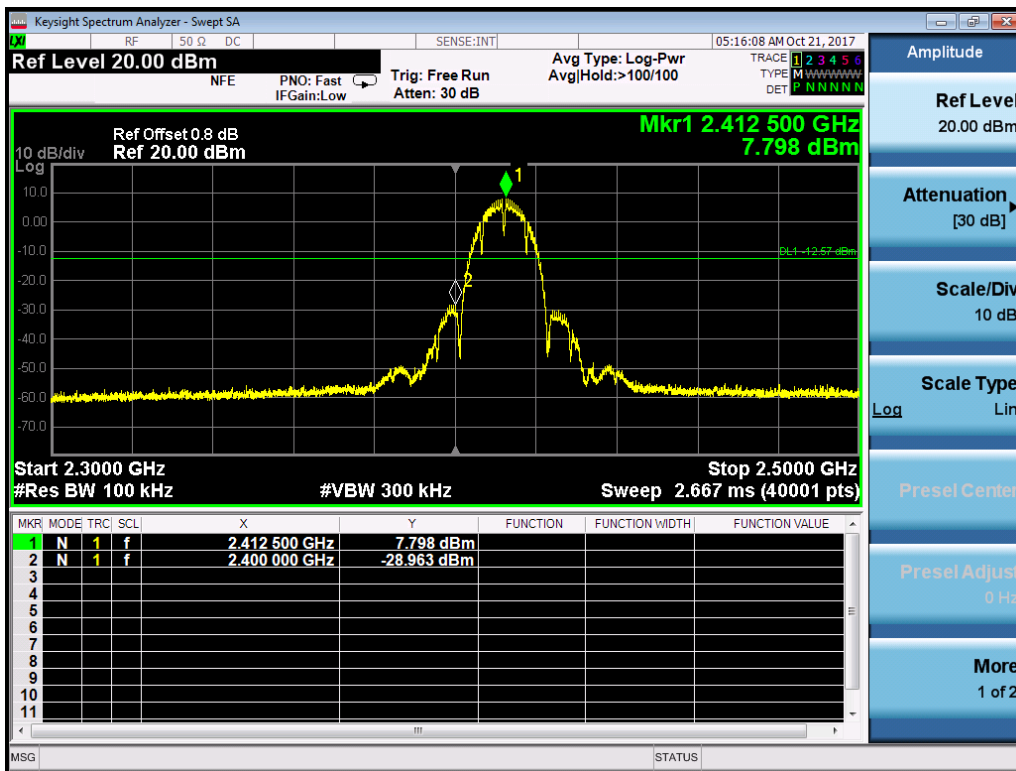

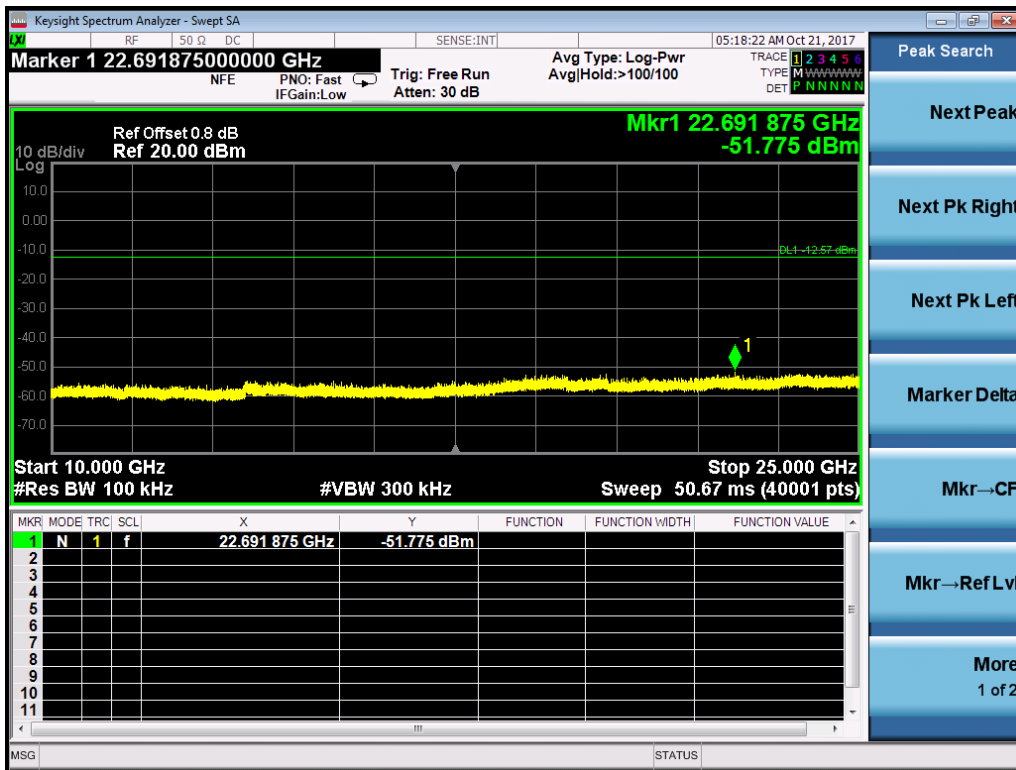
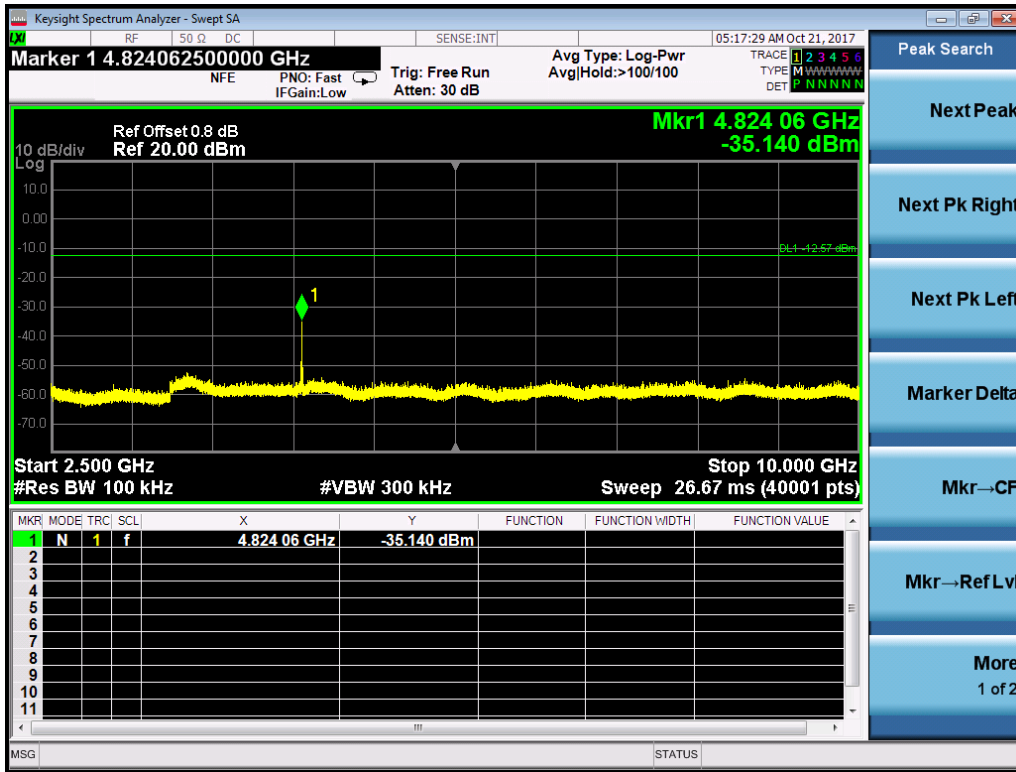

802.11b-2437MHz

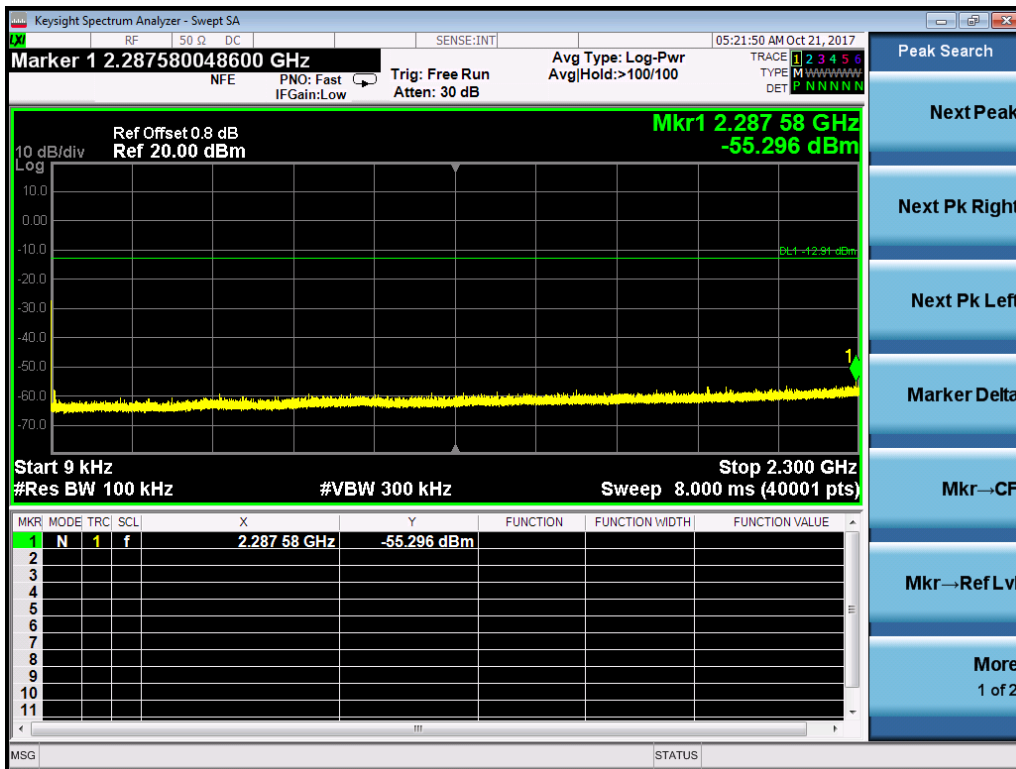
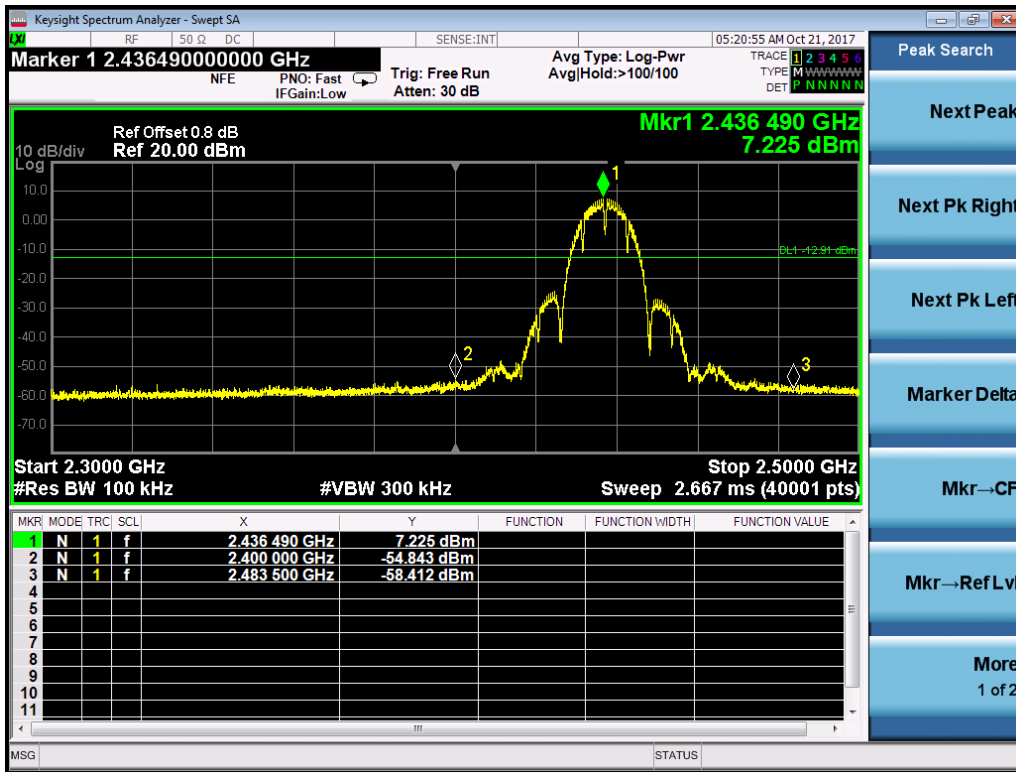

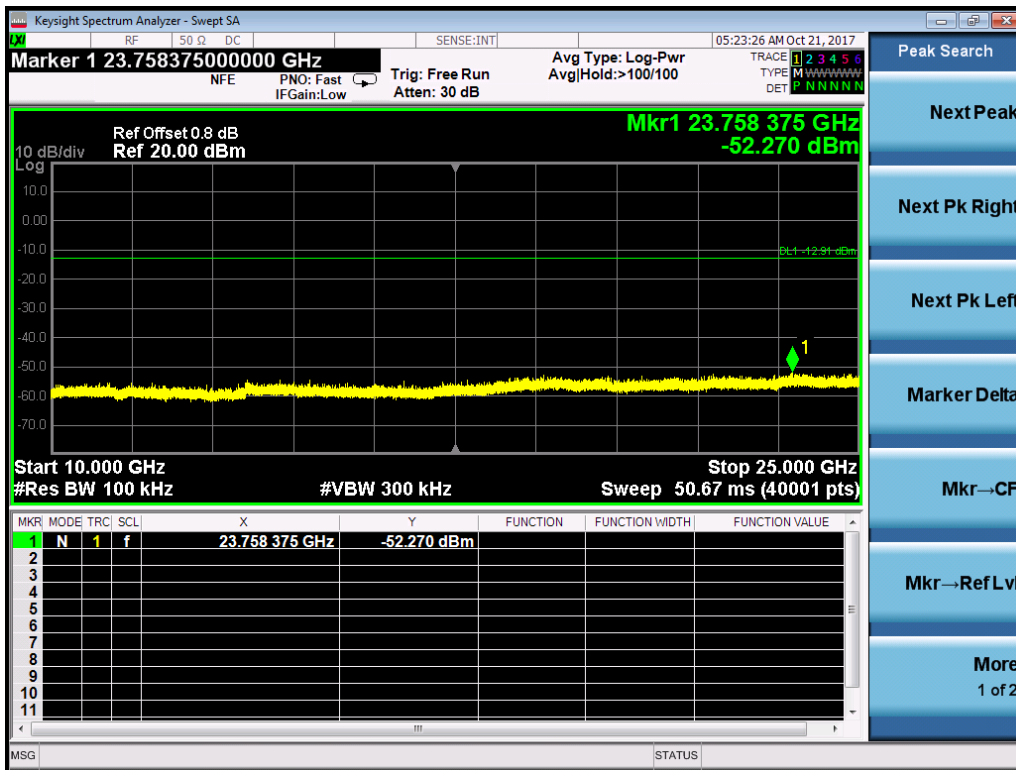
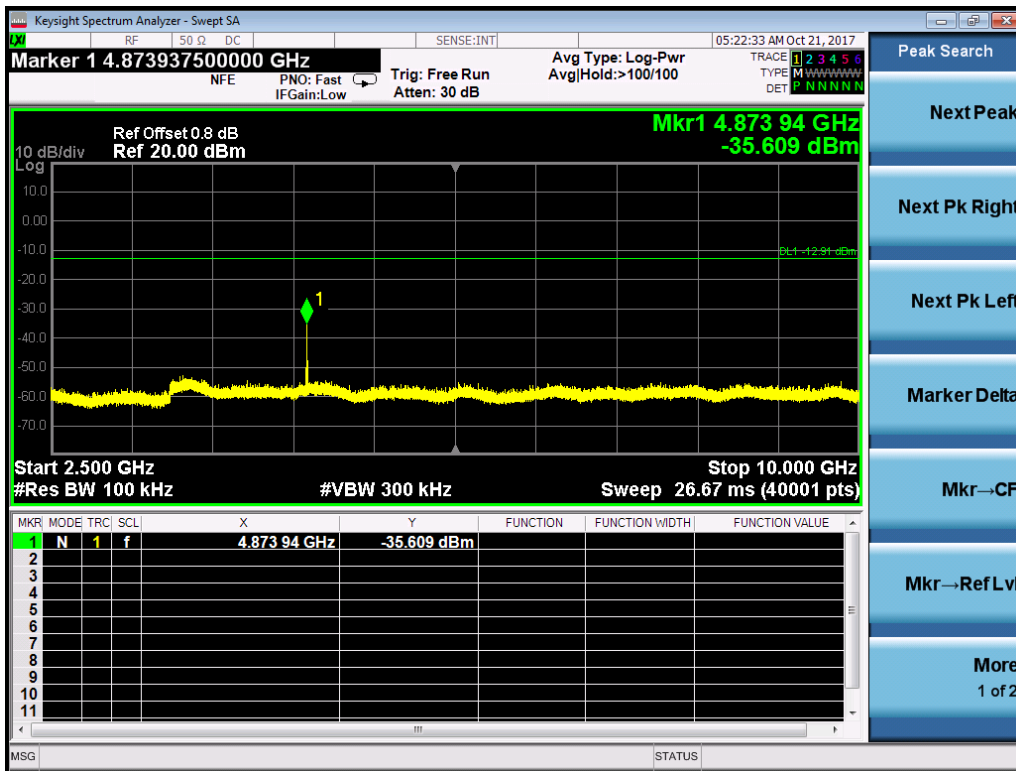

802.11b-2462MHz

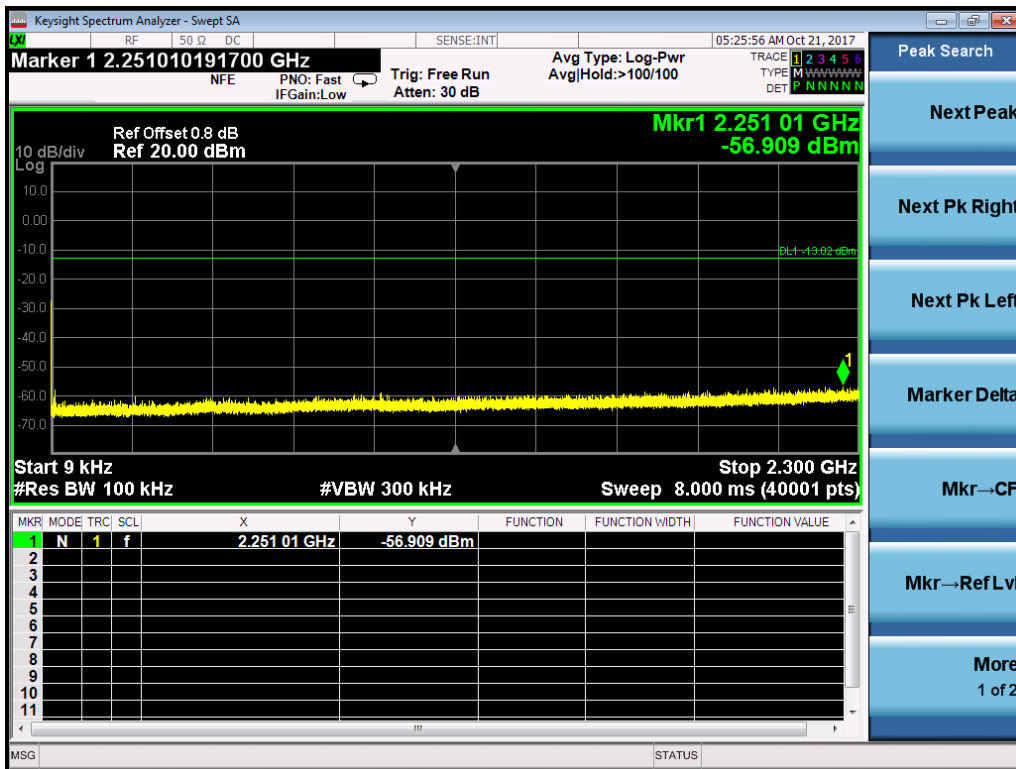
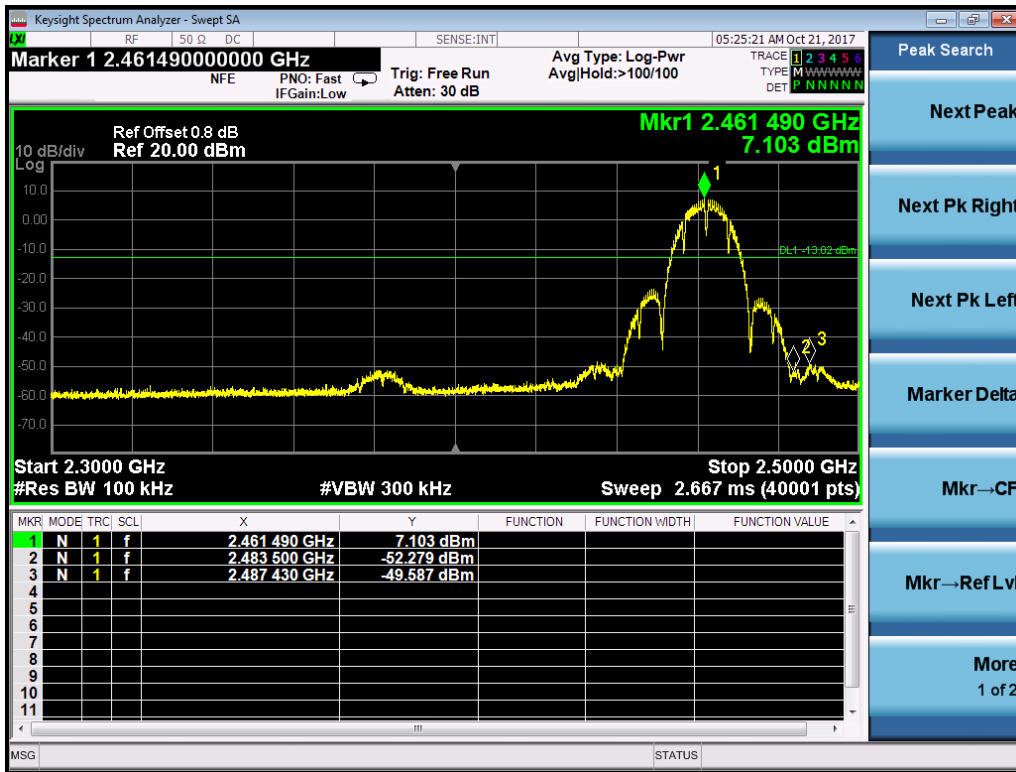

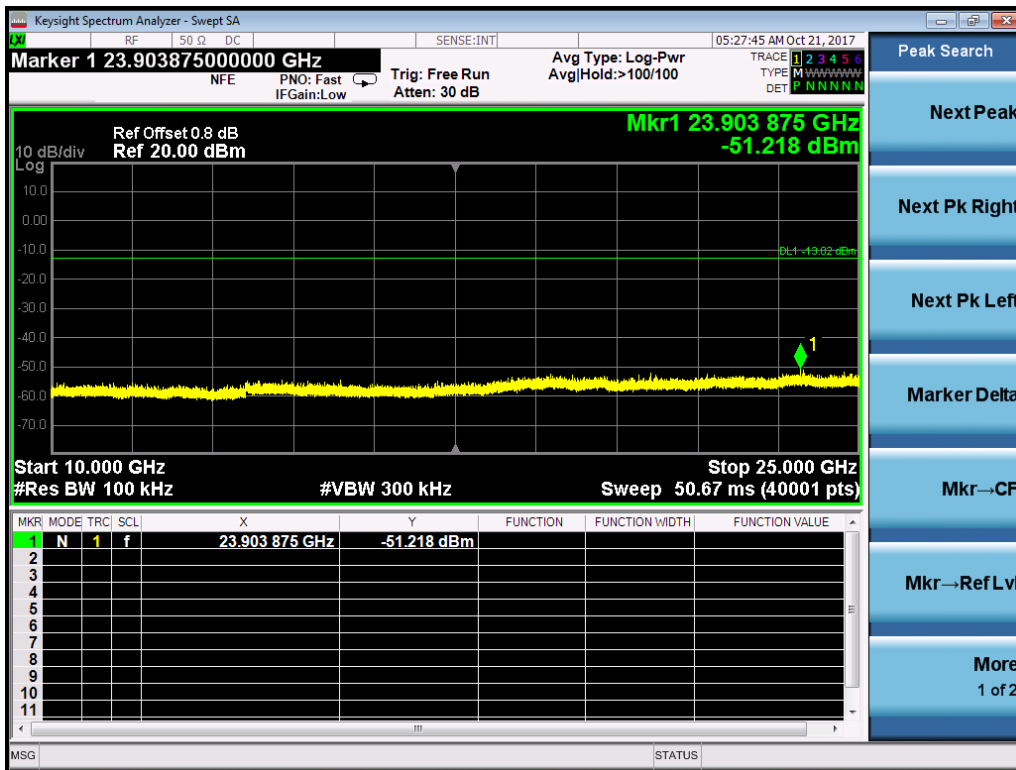
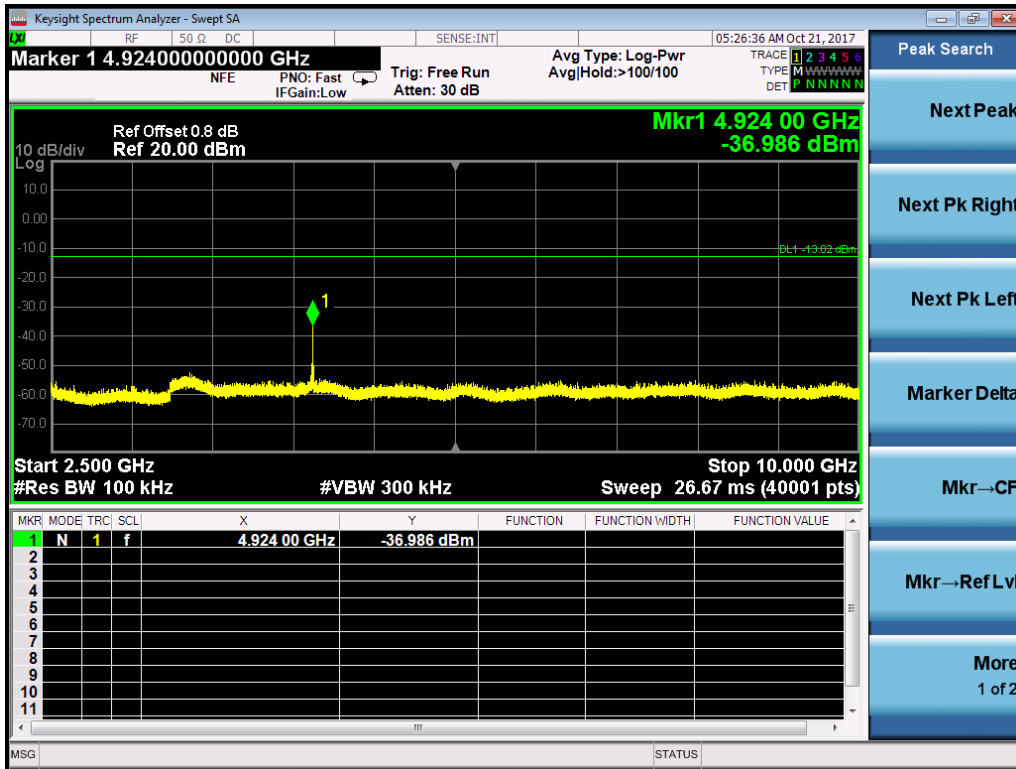

802.11g-2412MHz

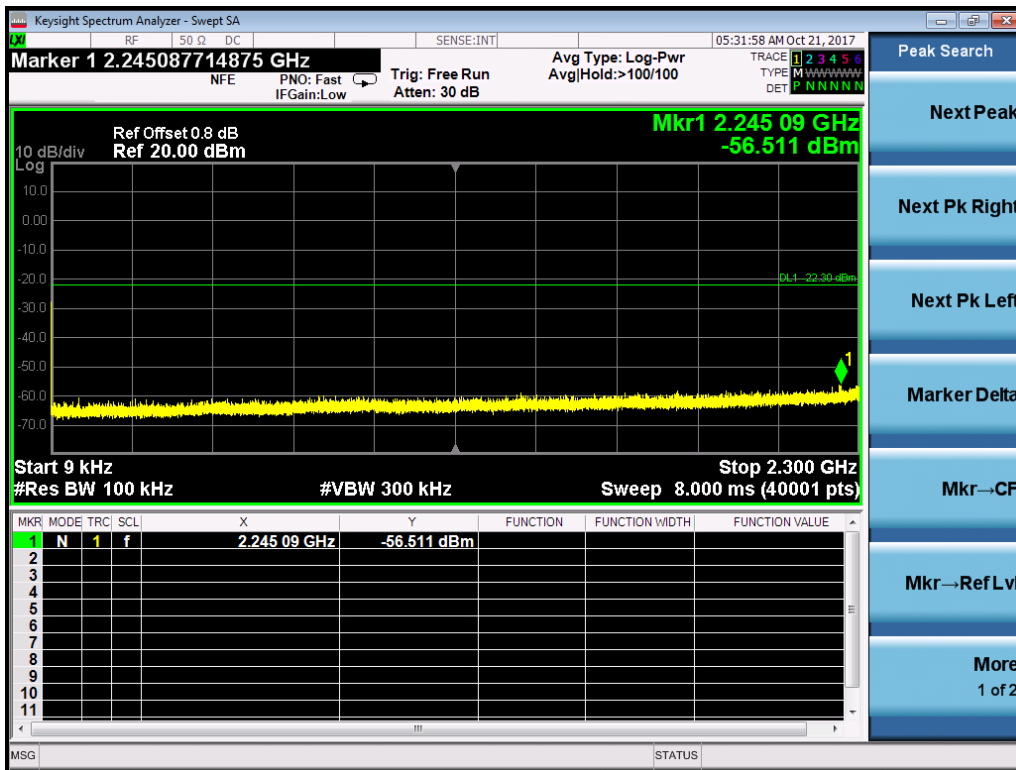
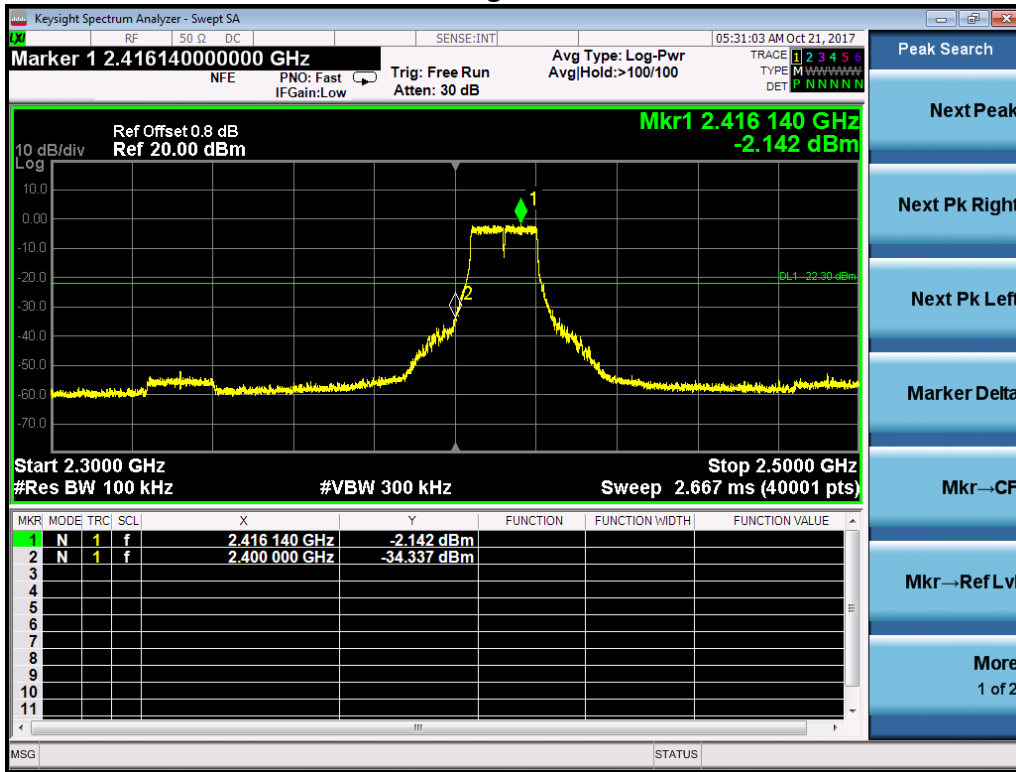

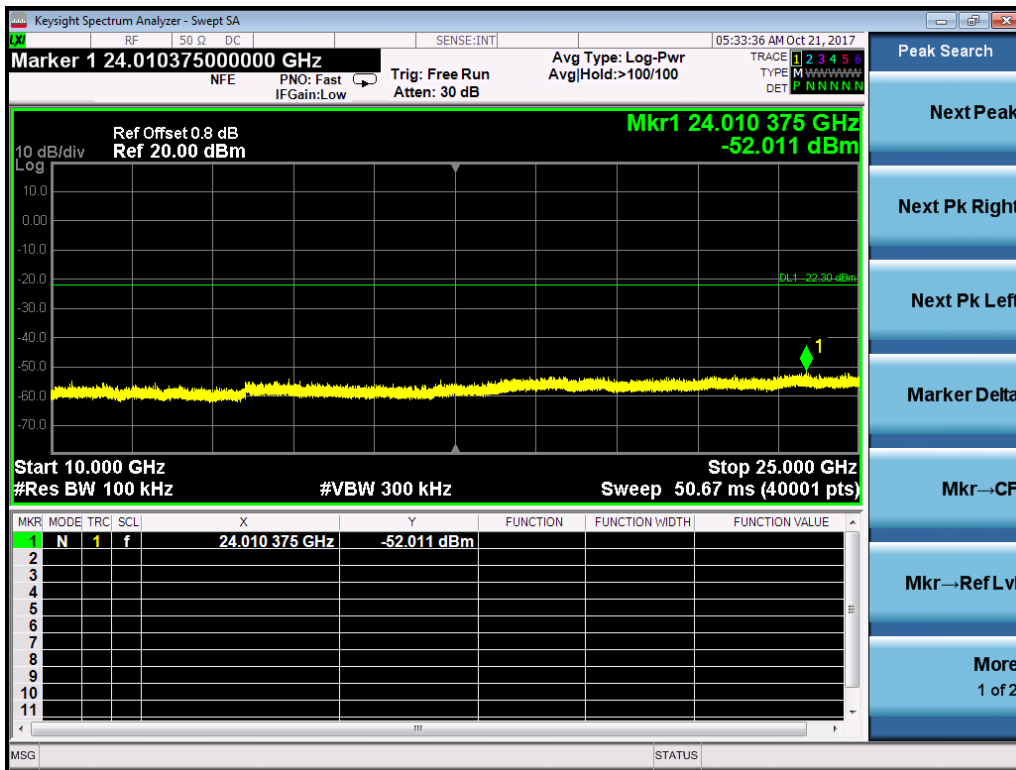
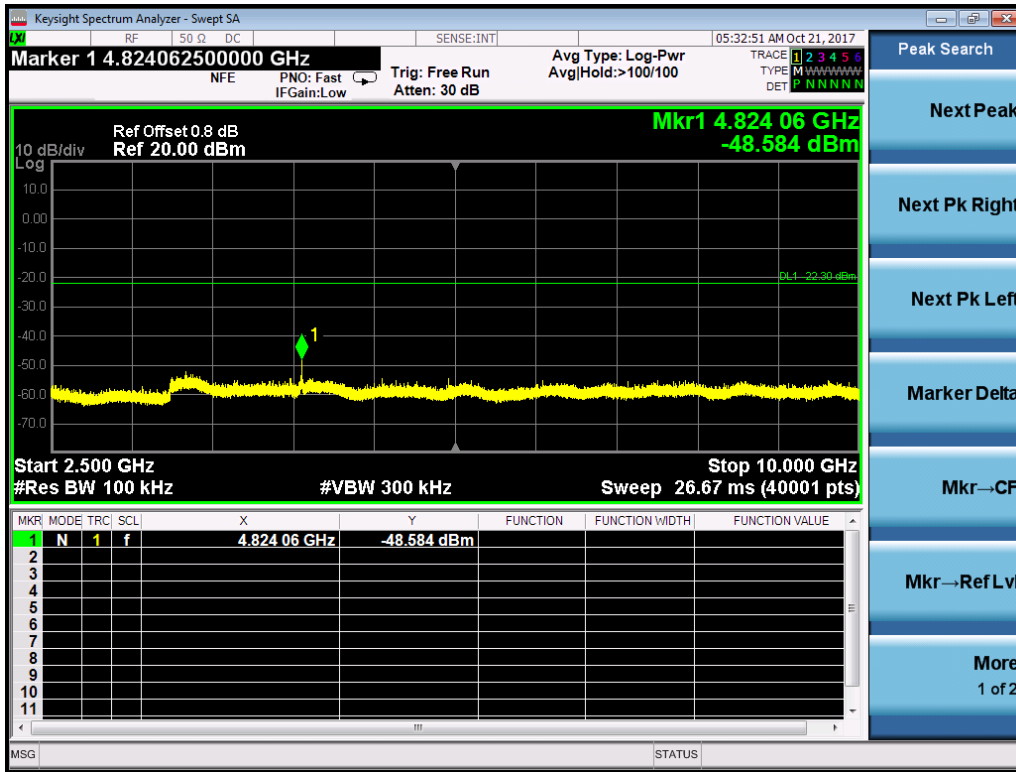

802.11g-2437MHz

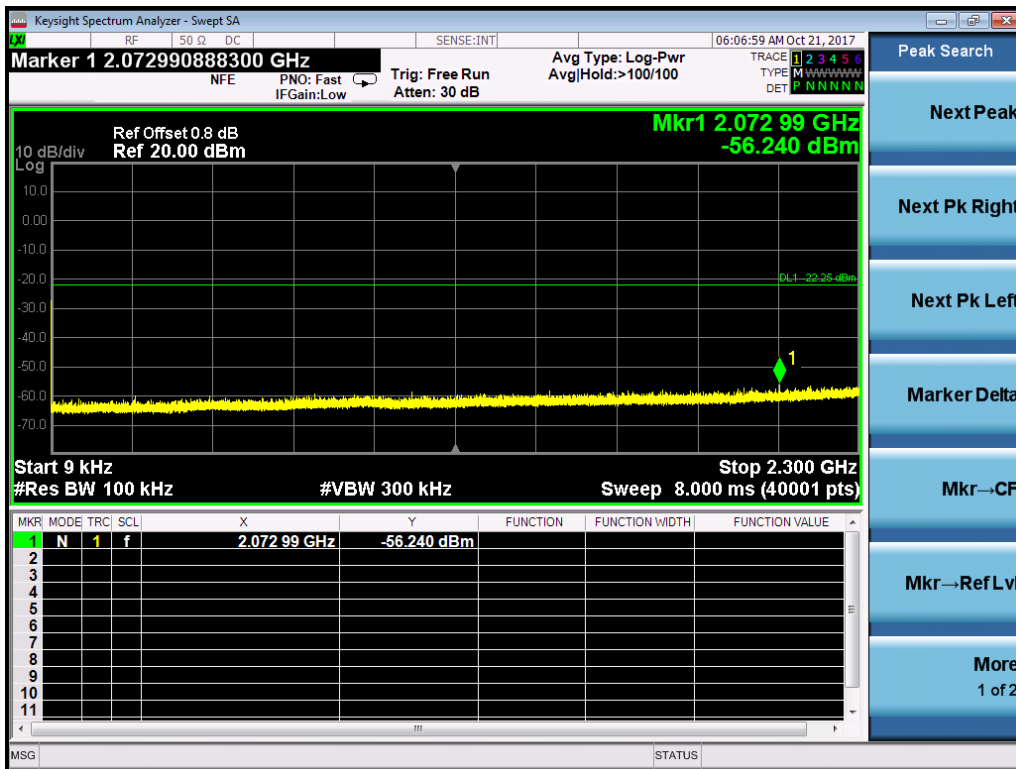
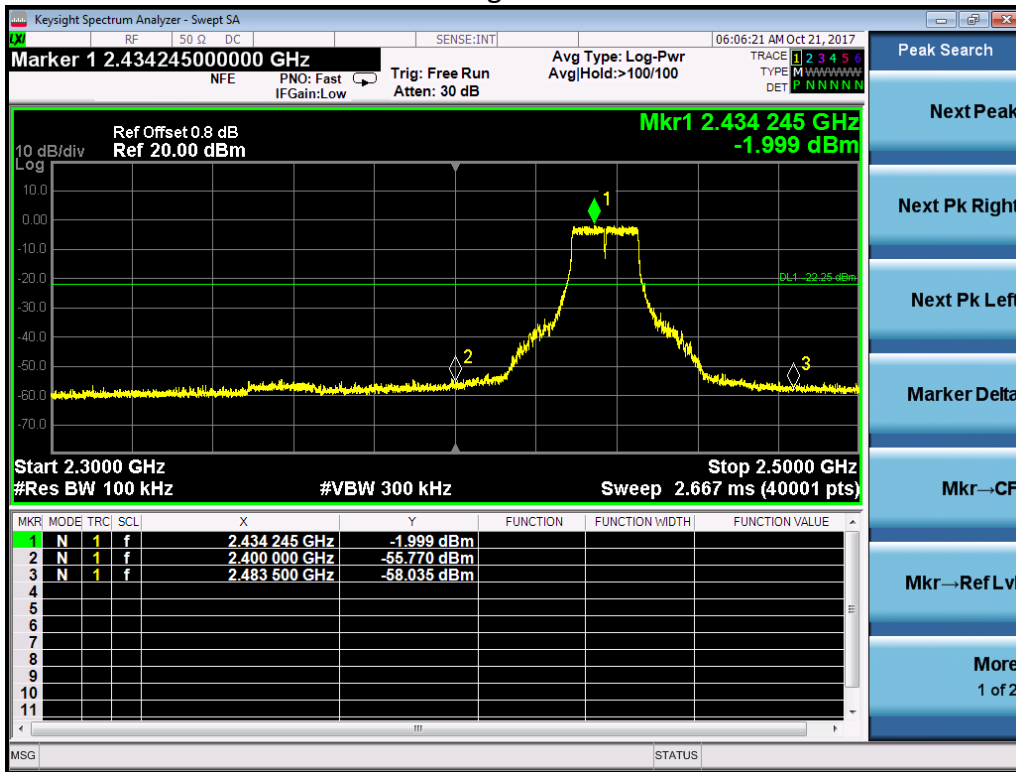

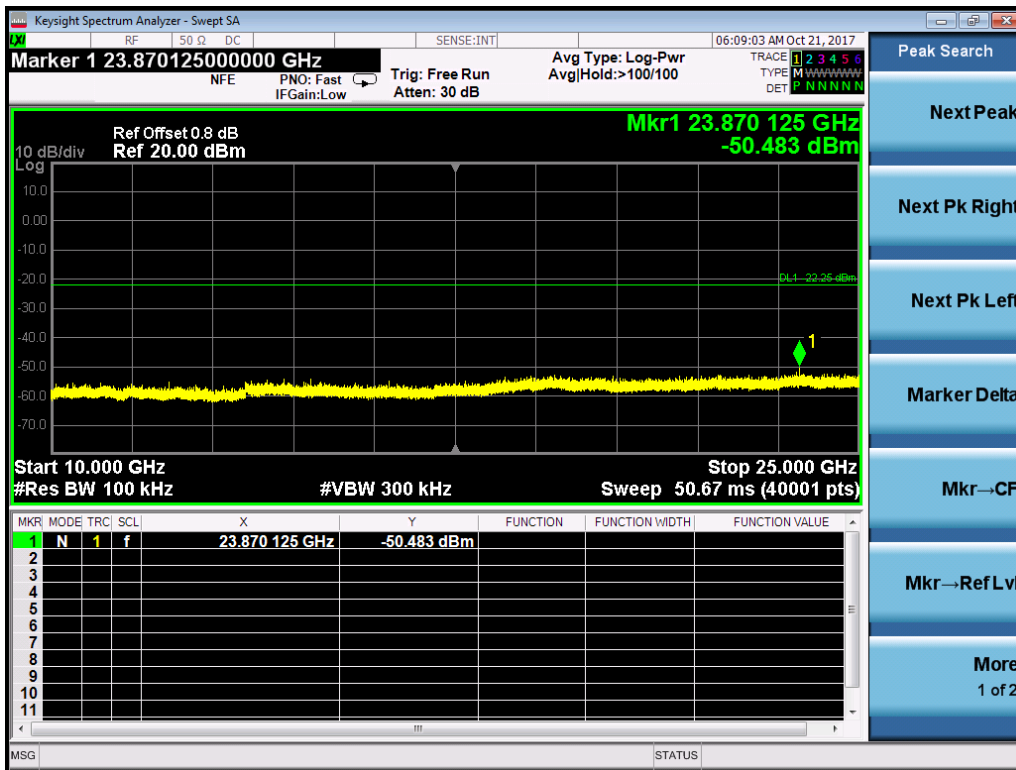
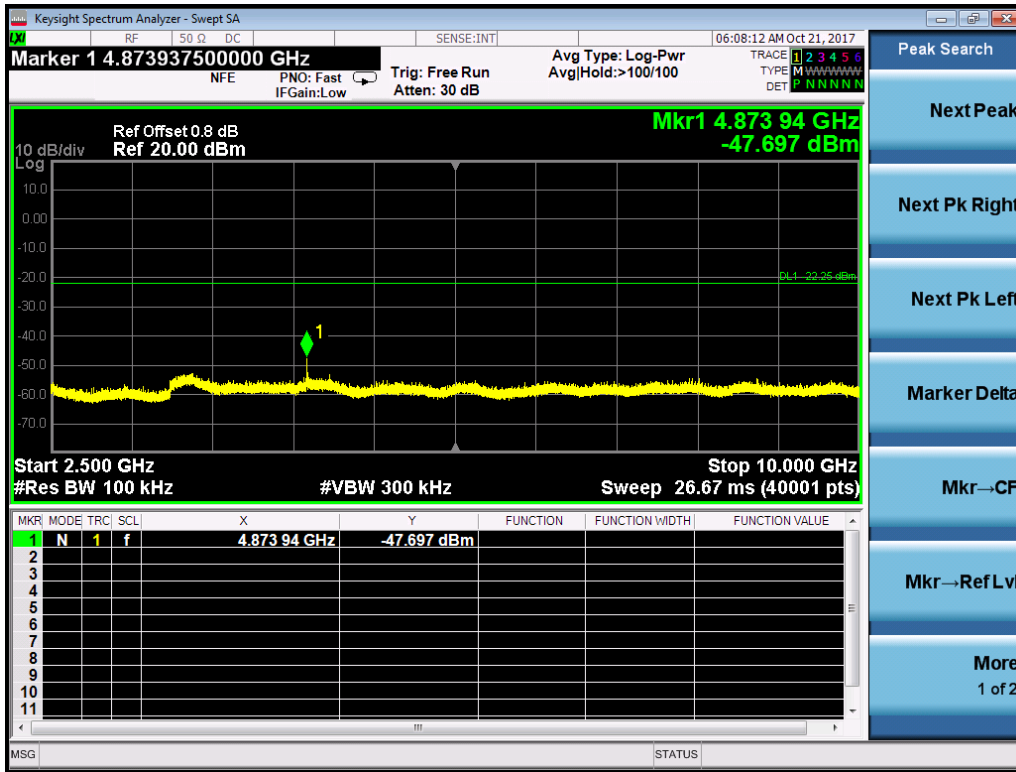

802.11g-2462MHz

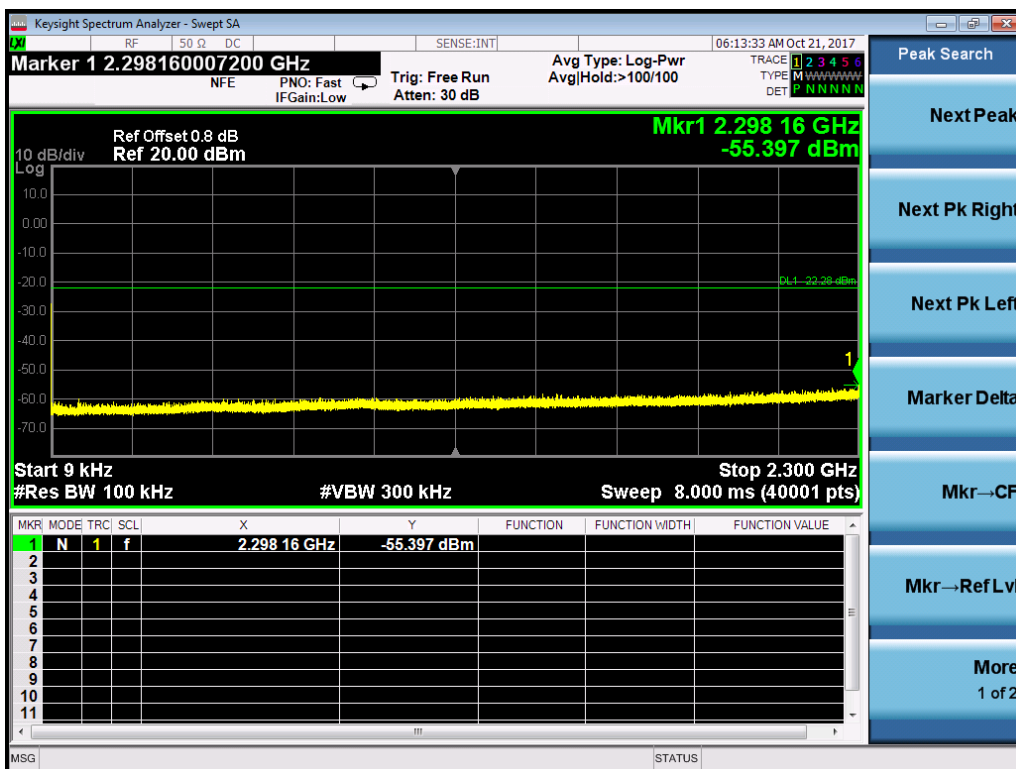
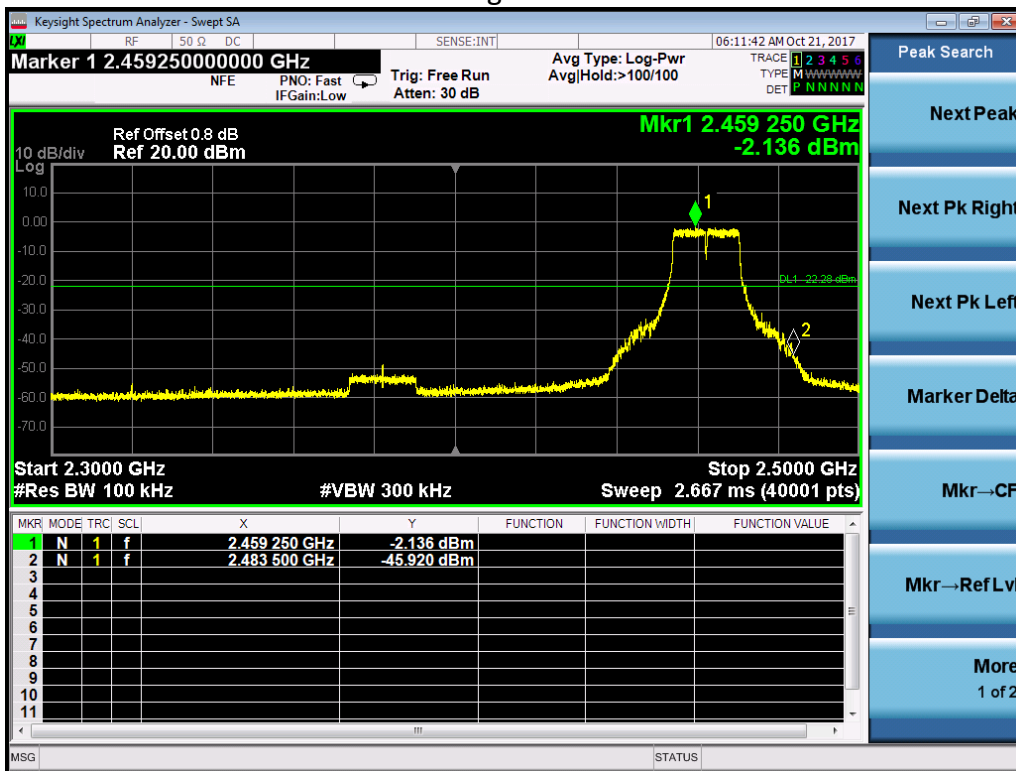

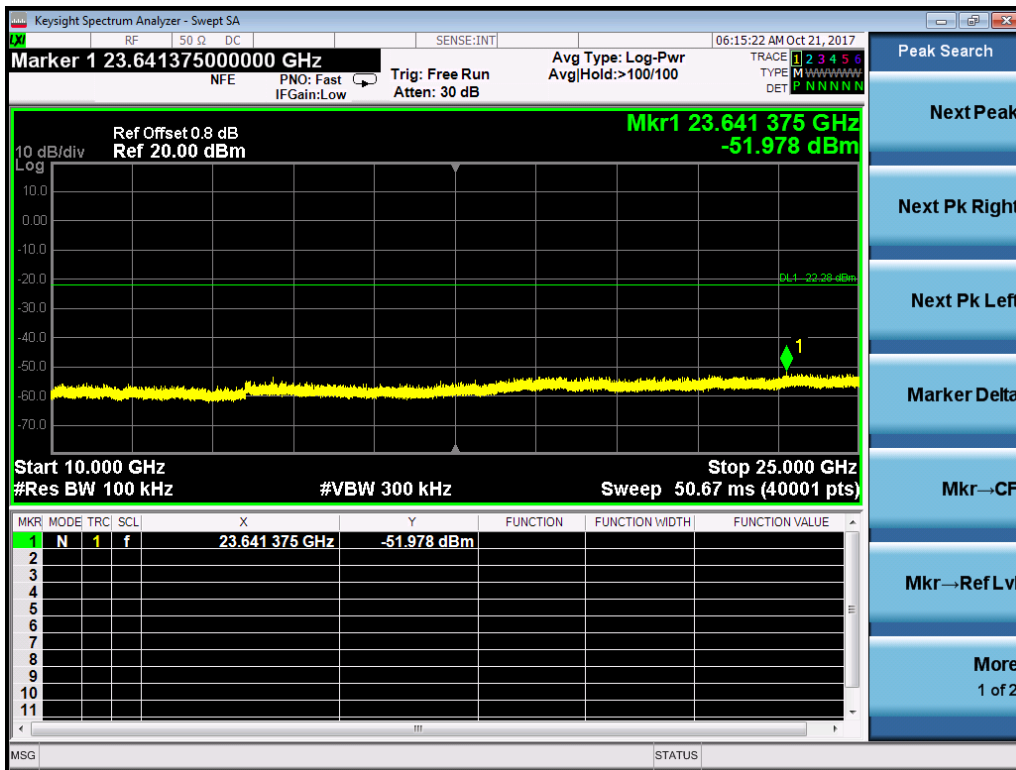
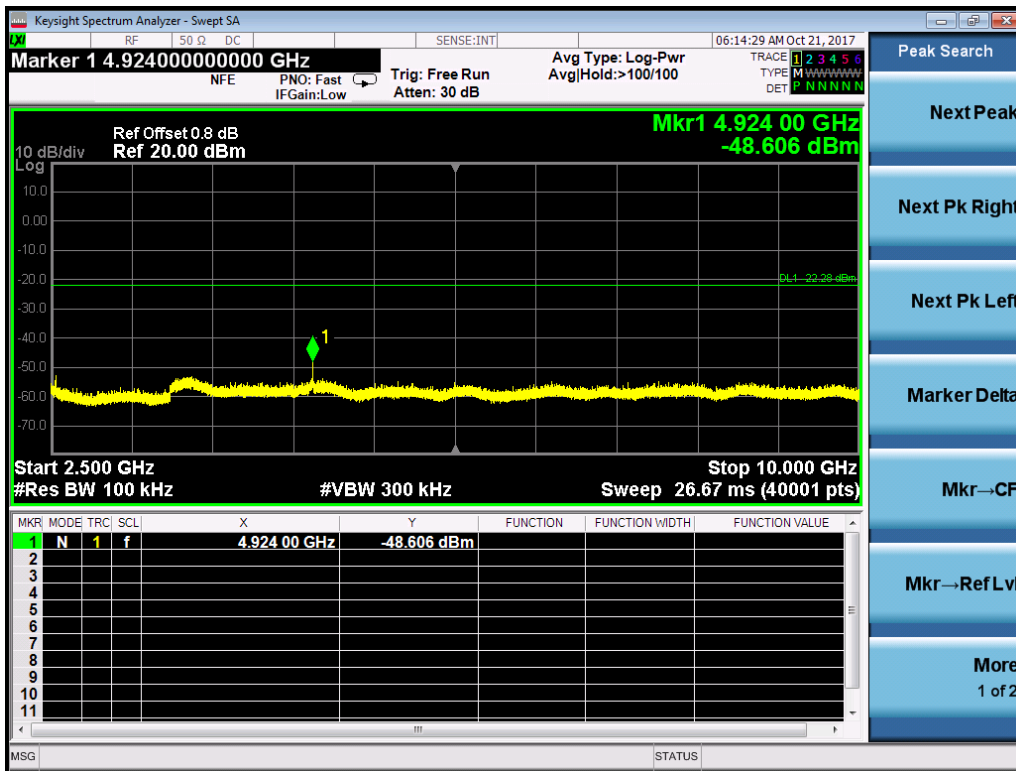

802.11n20-2412MHz

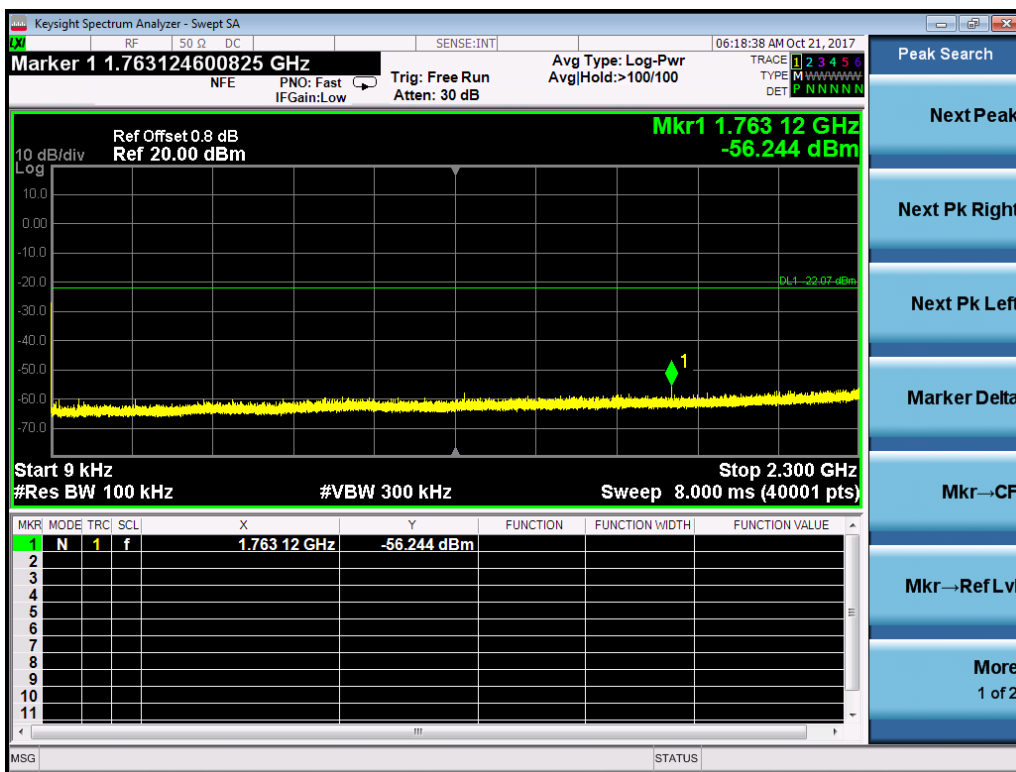
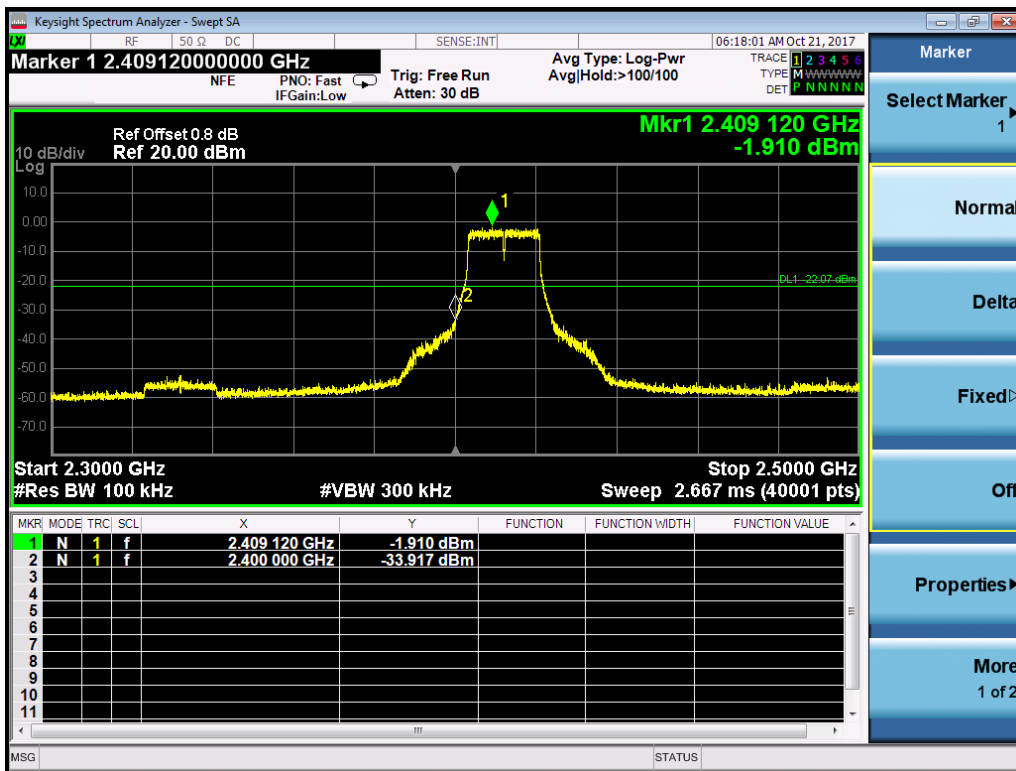

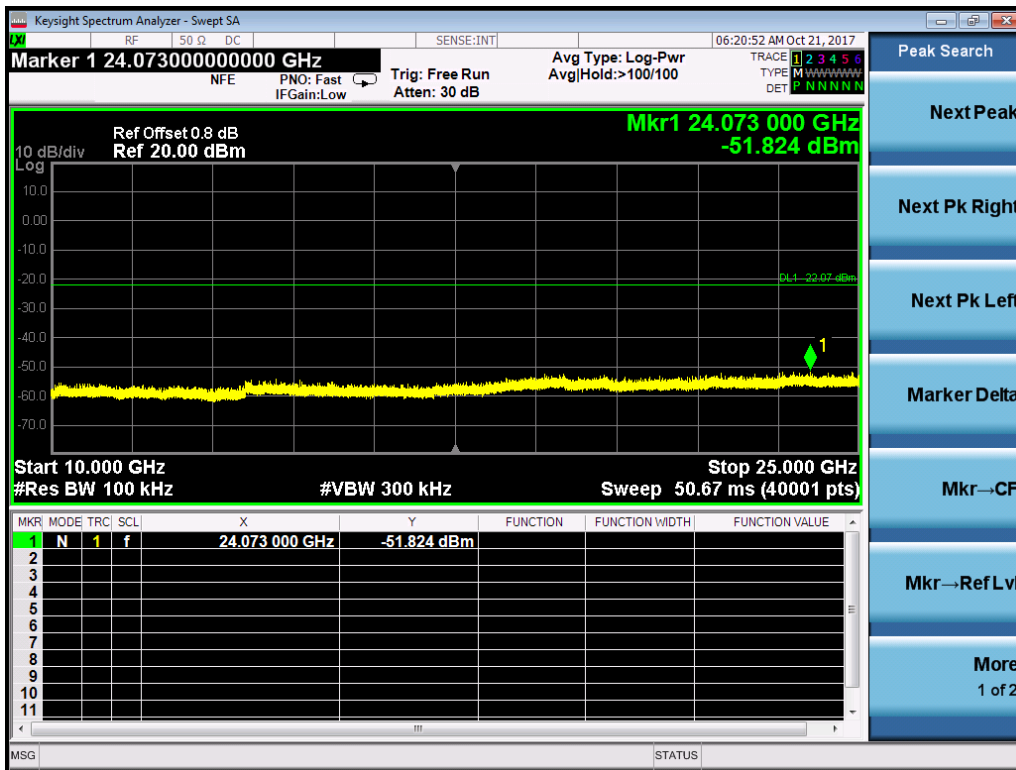
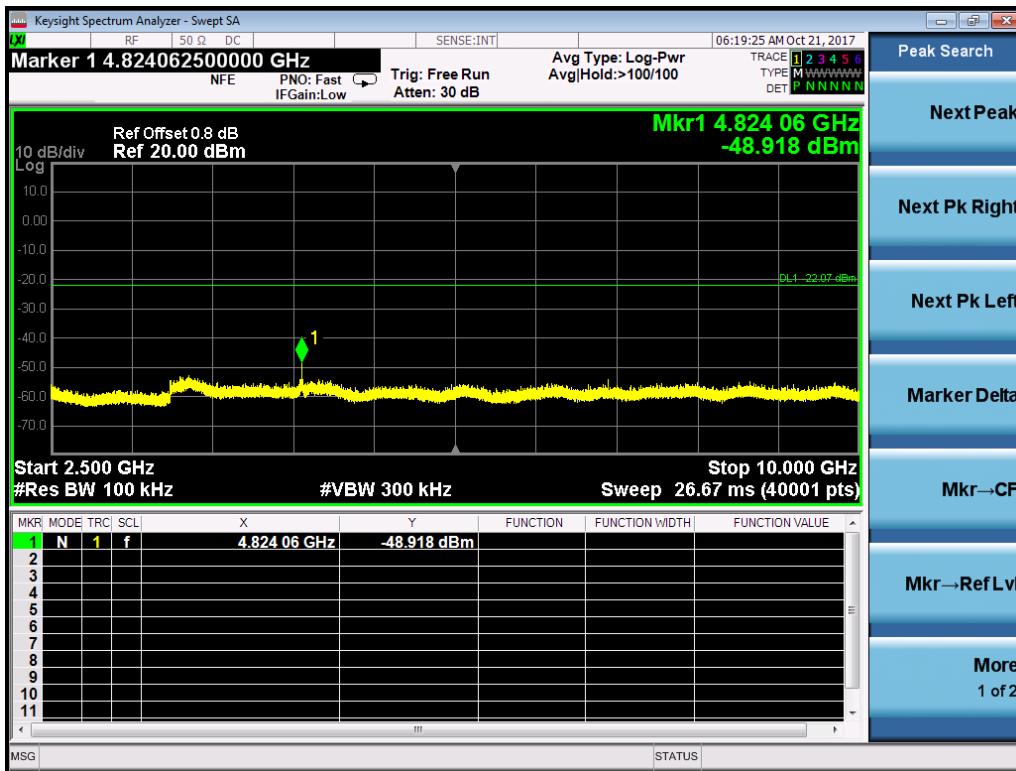

802.11n20-2437MHz

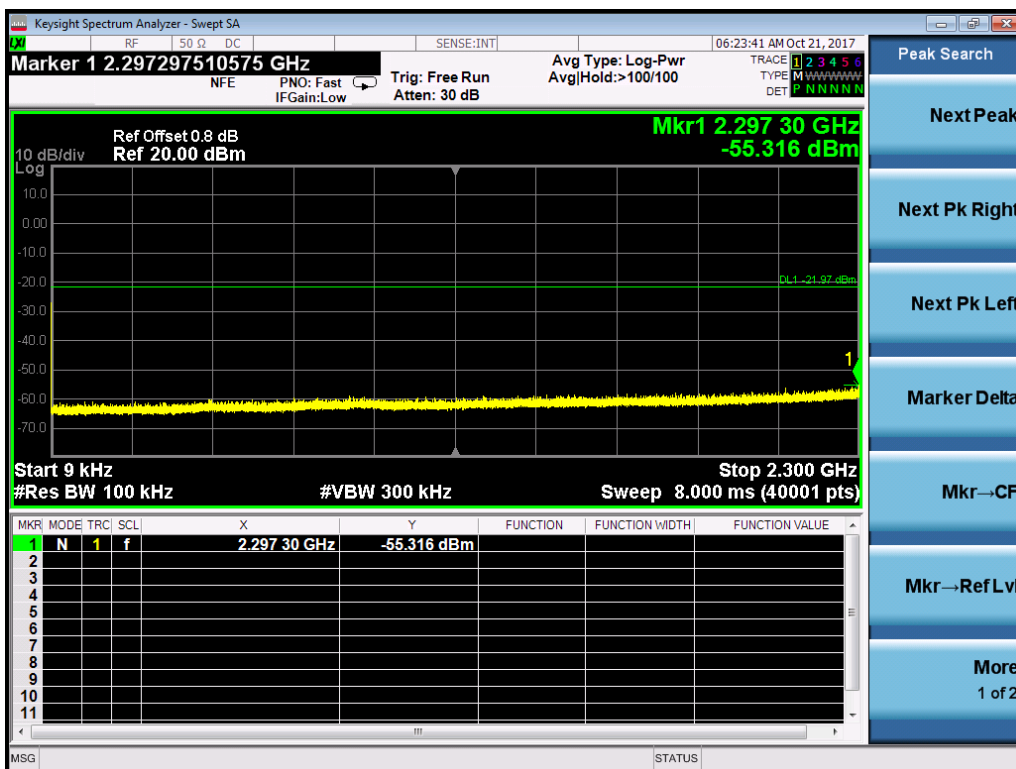
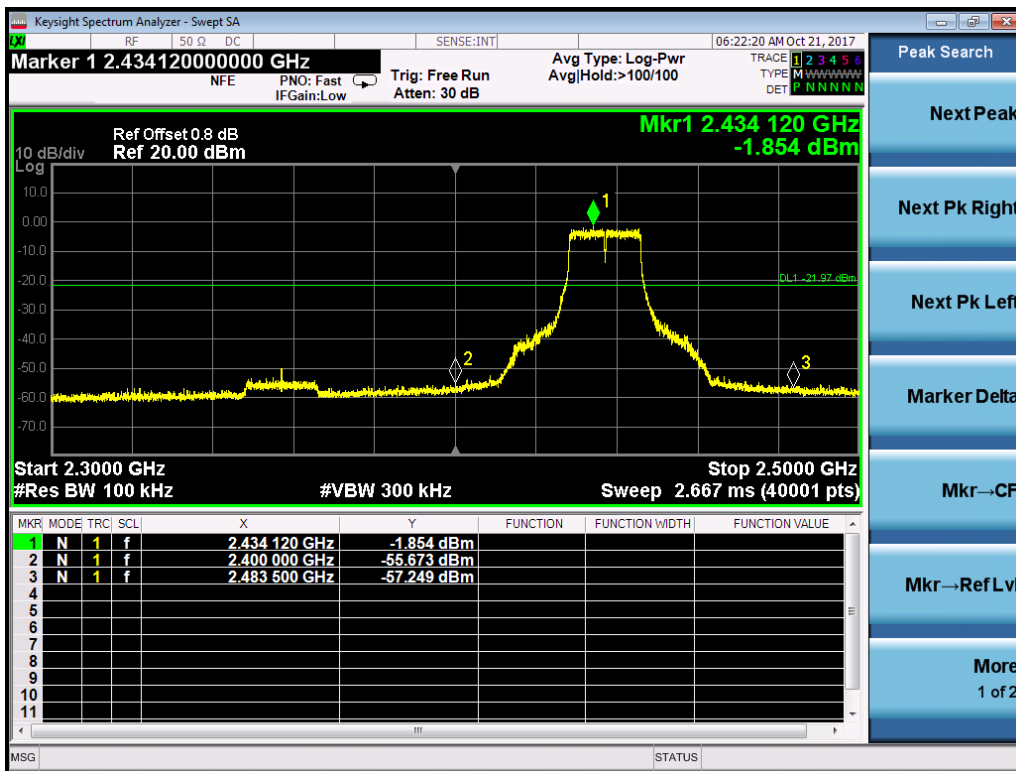

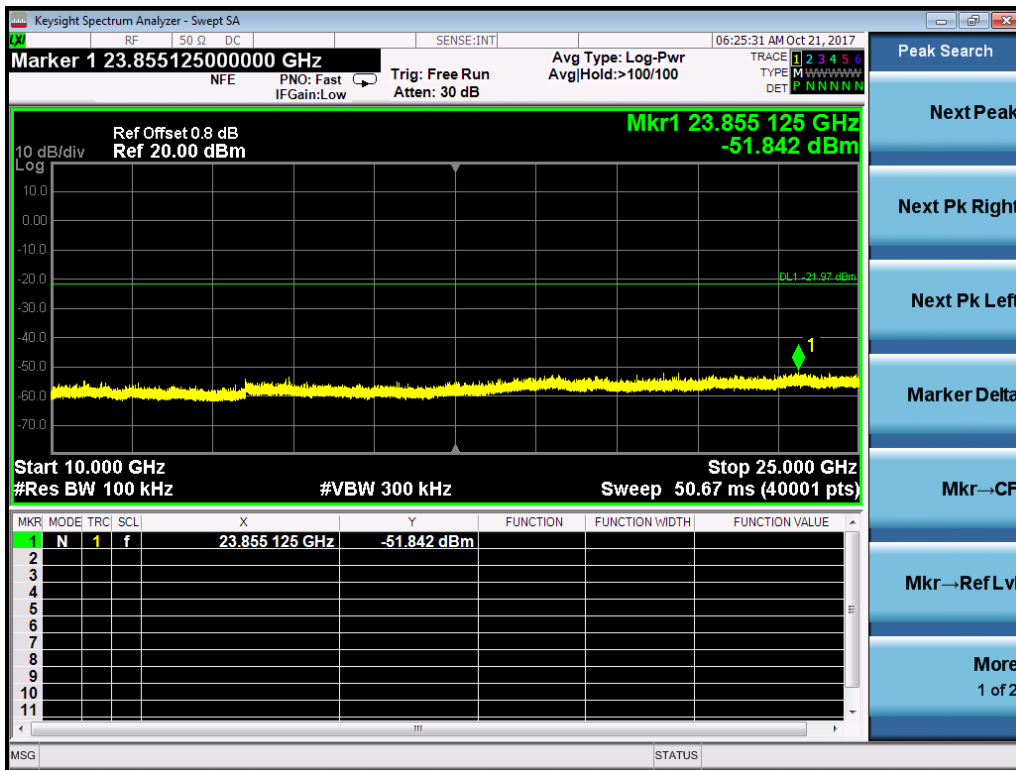
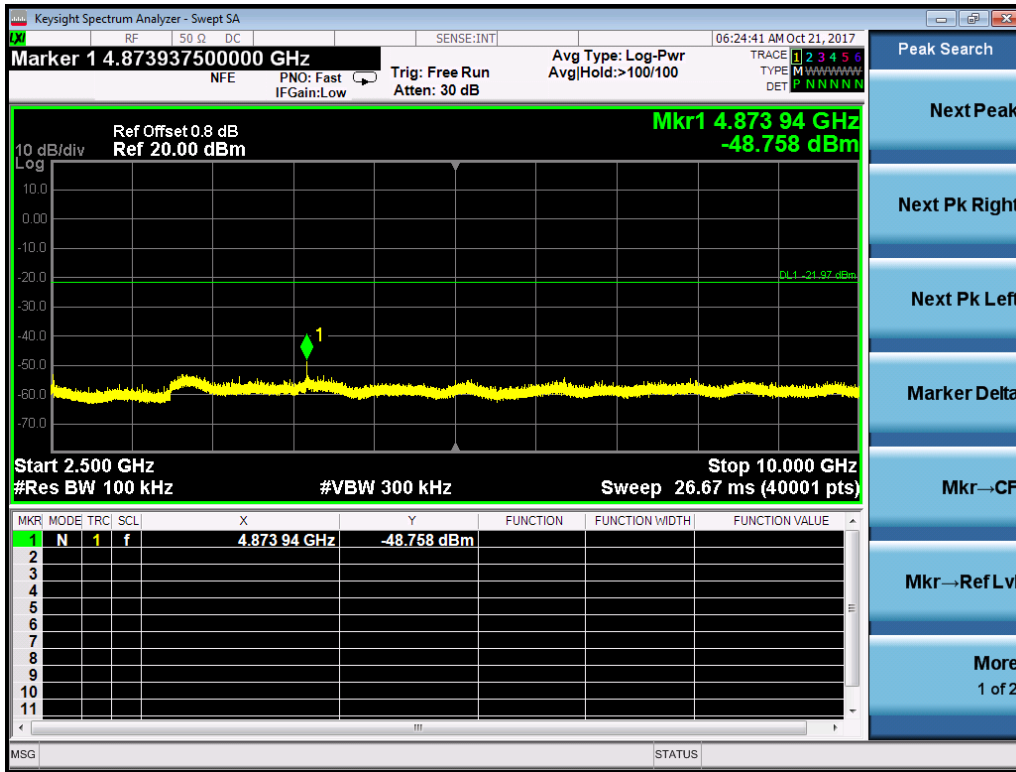

802.11n20-2462MHz

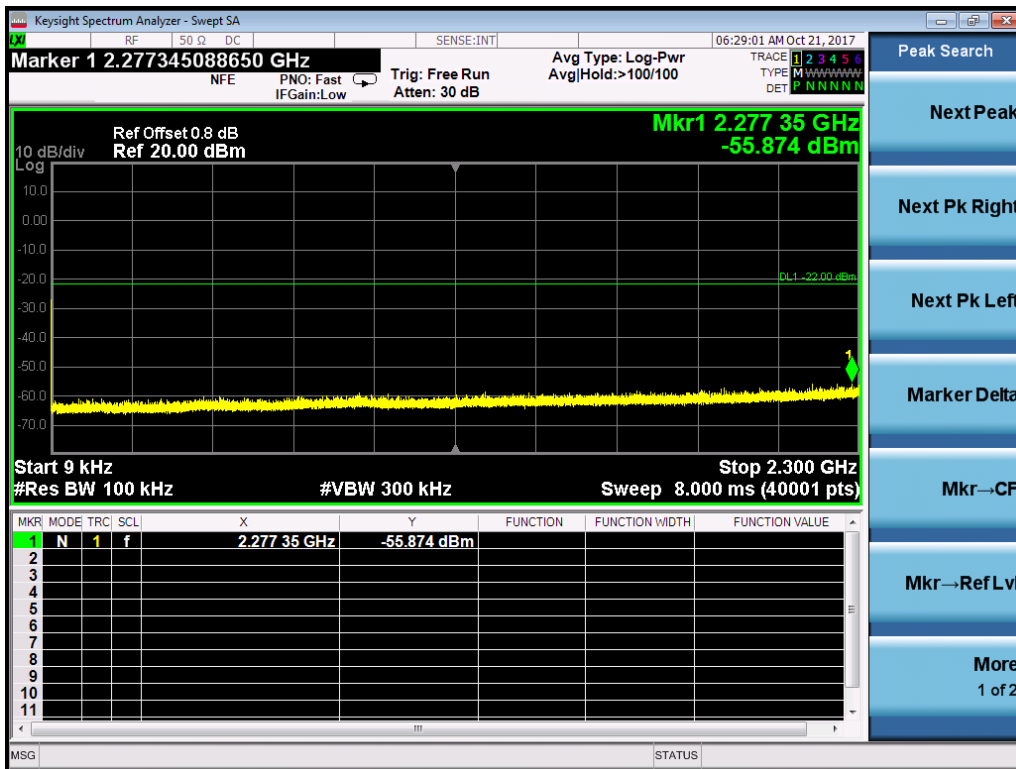
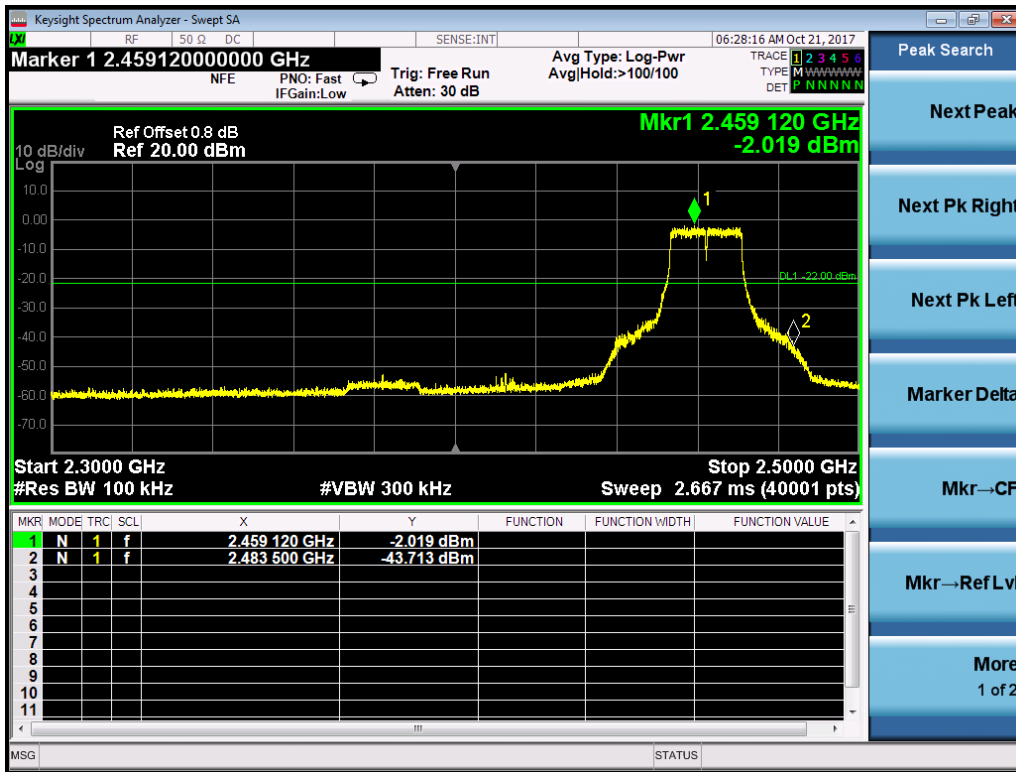

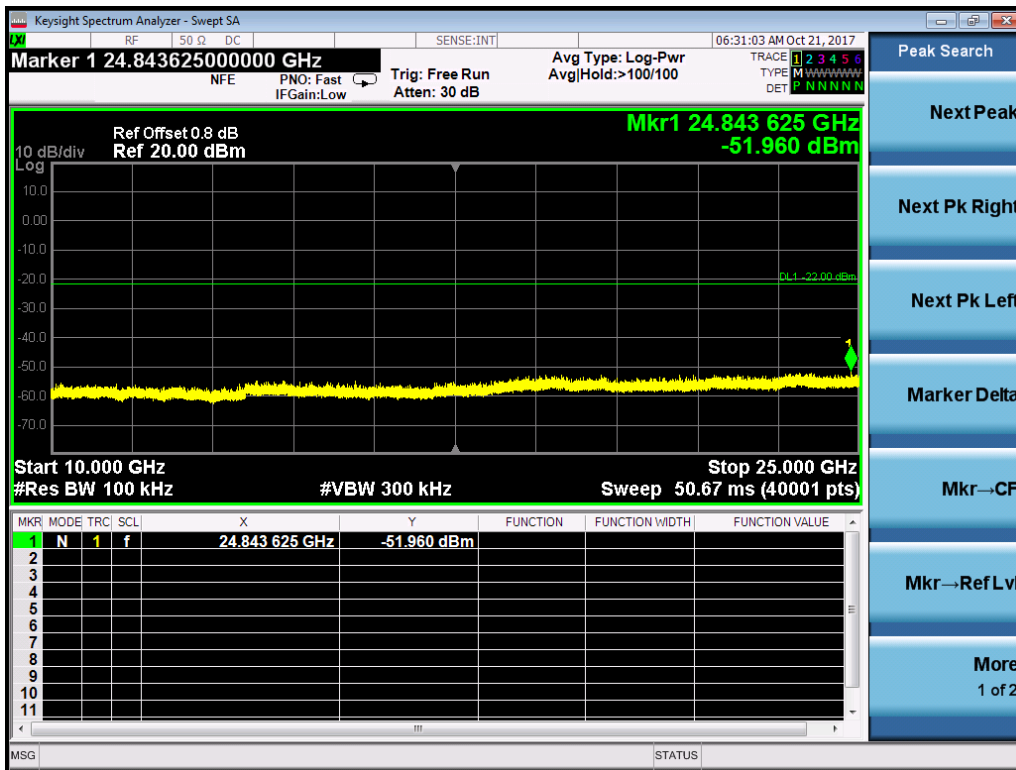
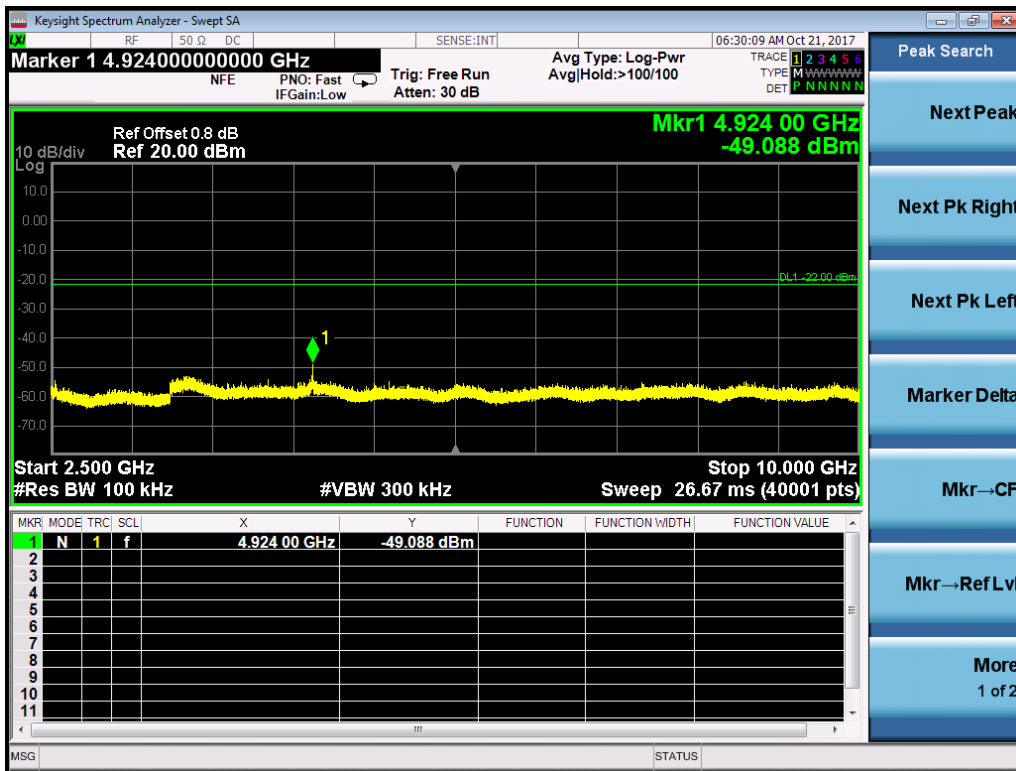

802.11n40-2422MHz

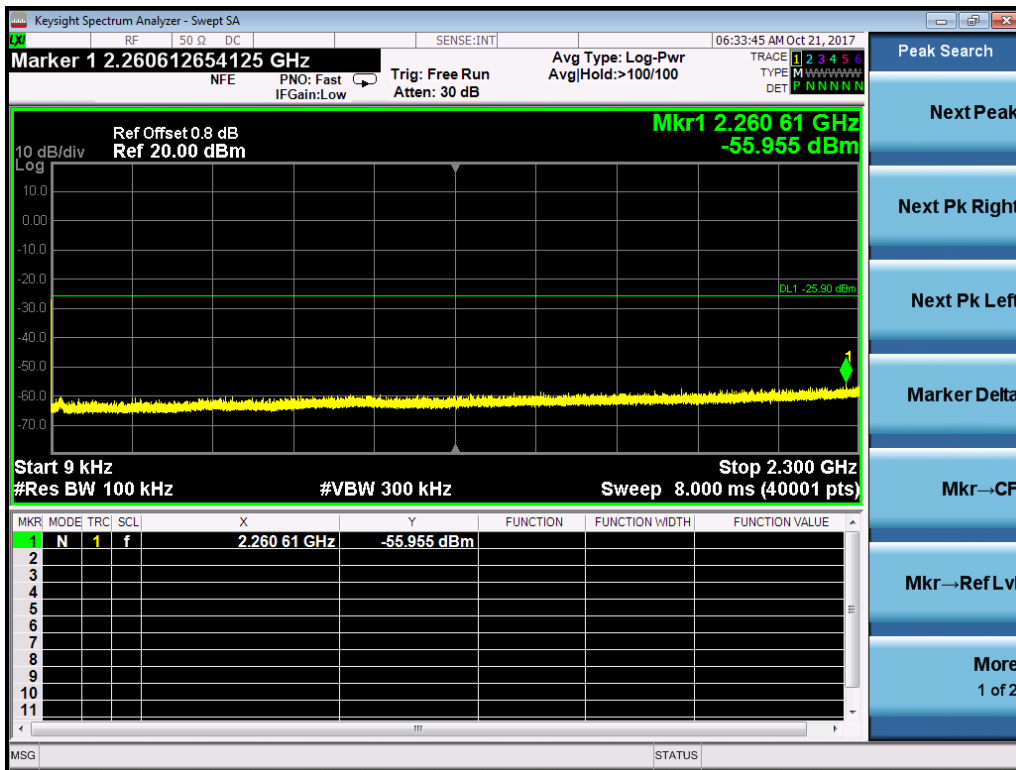
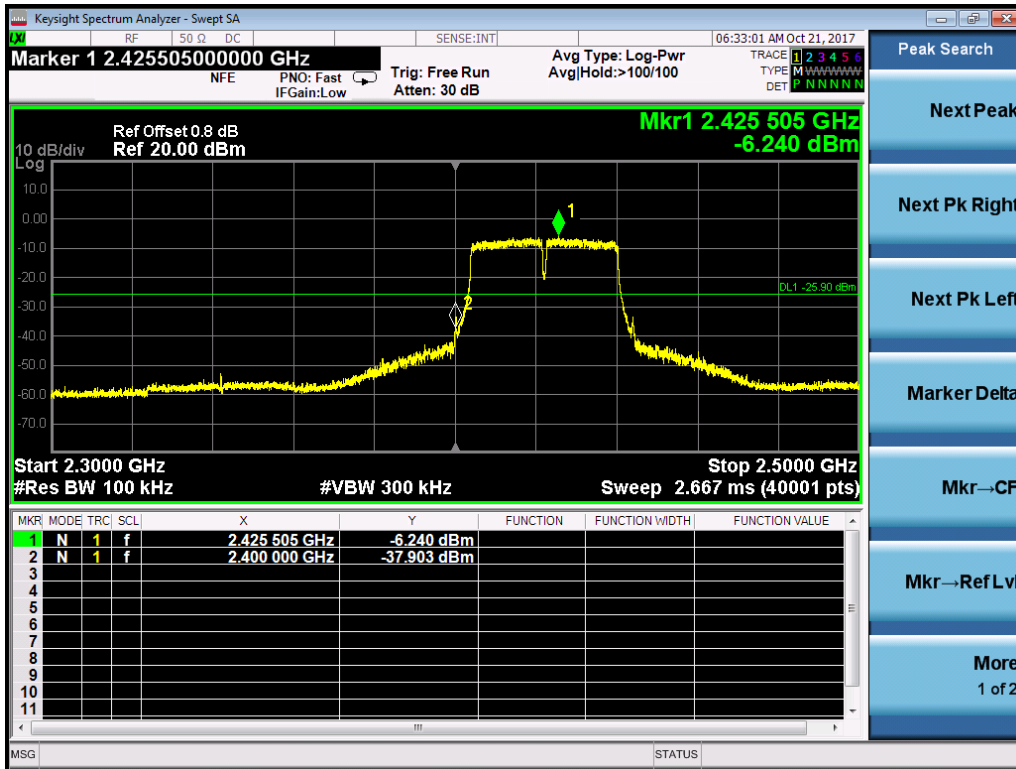

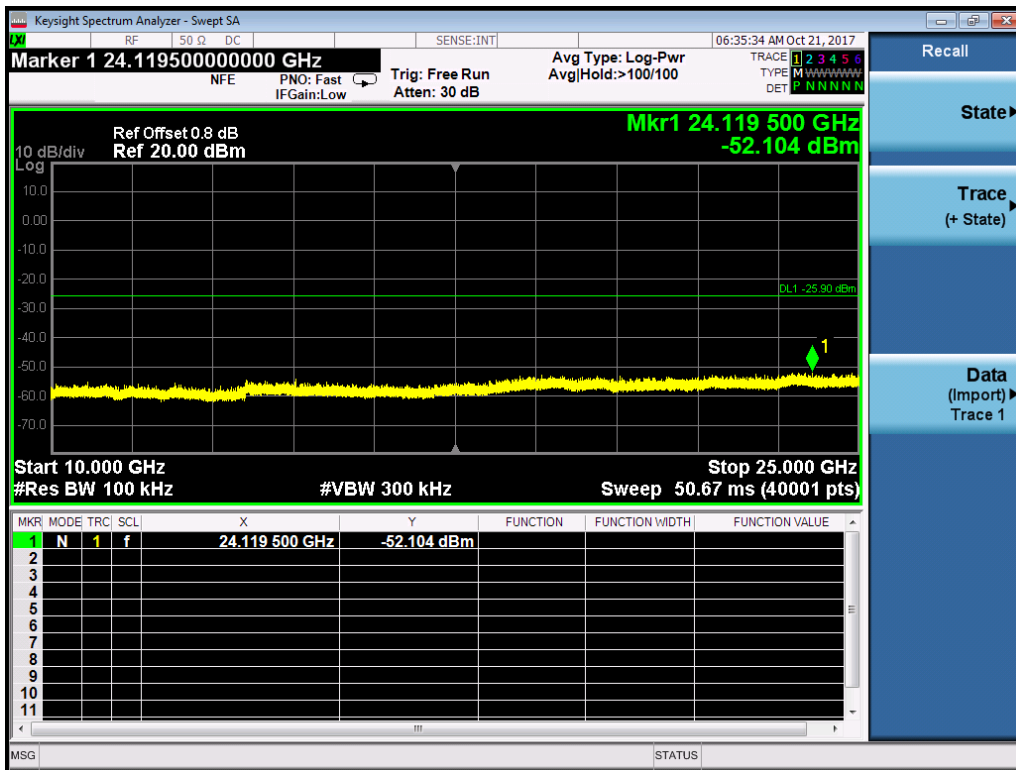
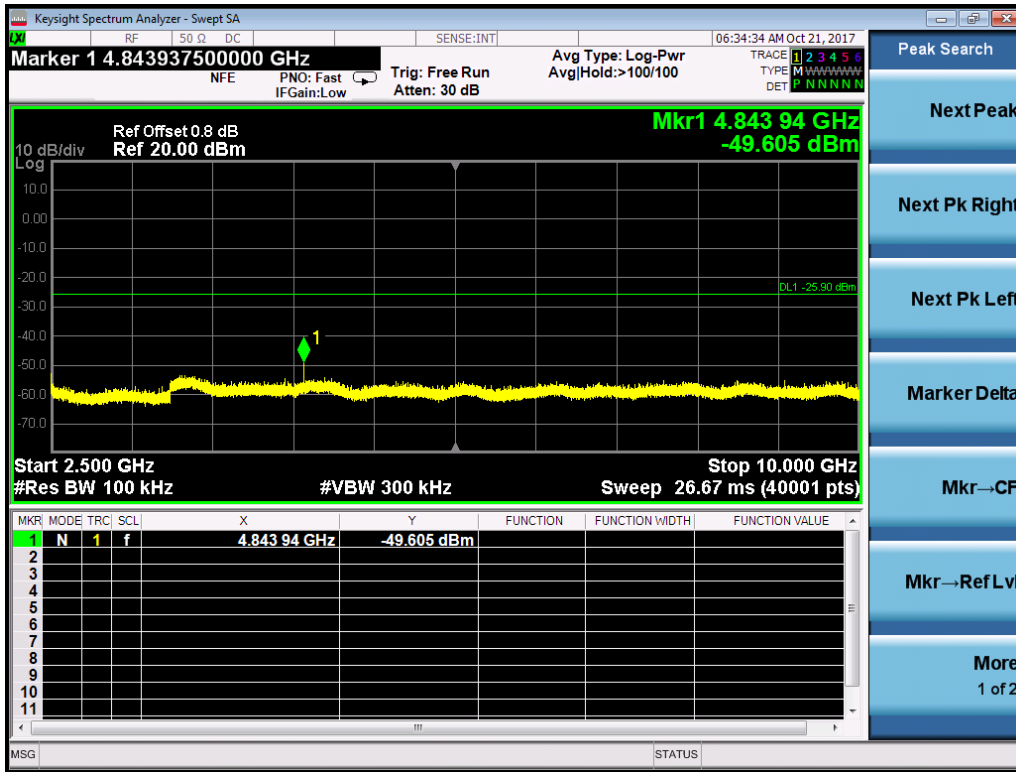

802.11n40-2437MHz

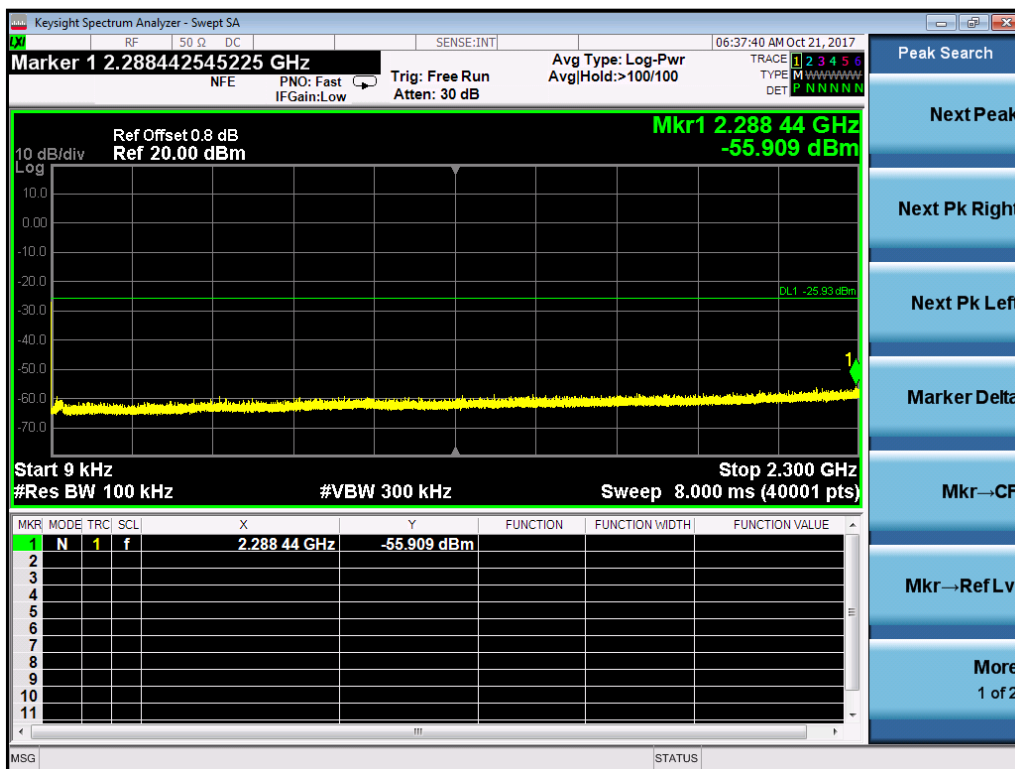
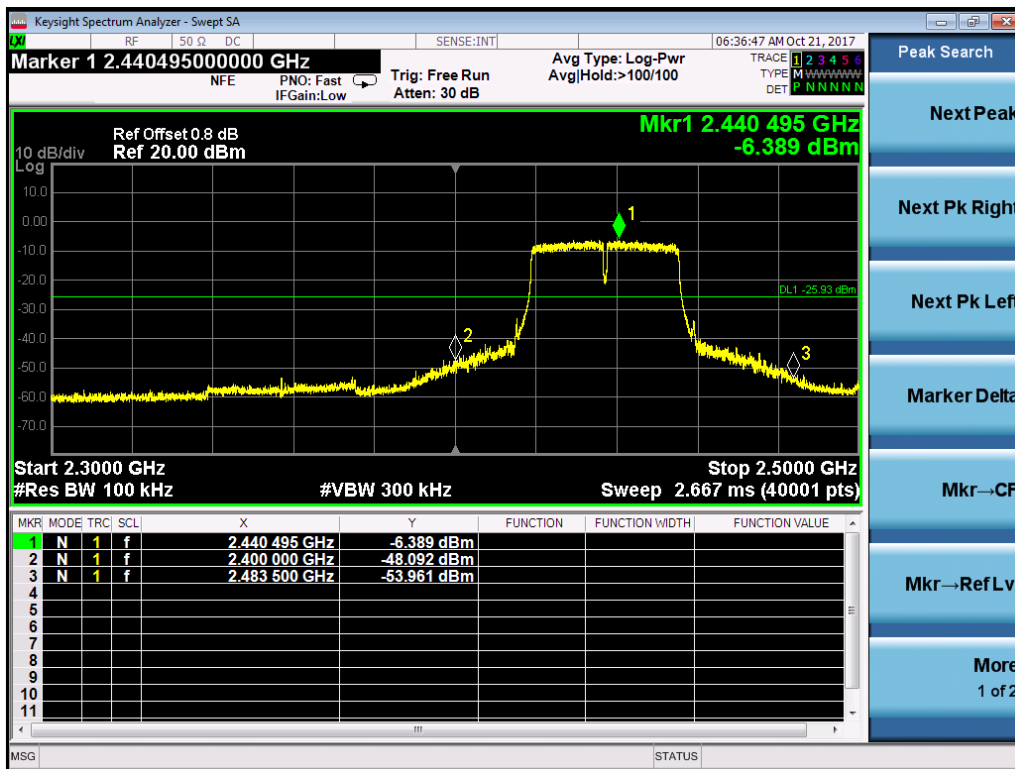

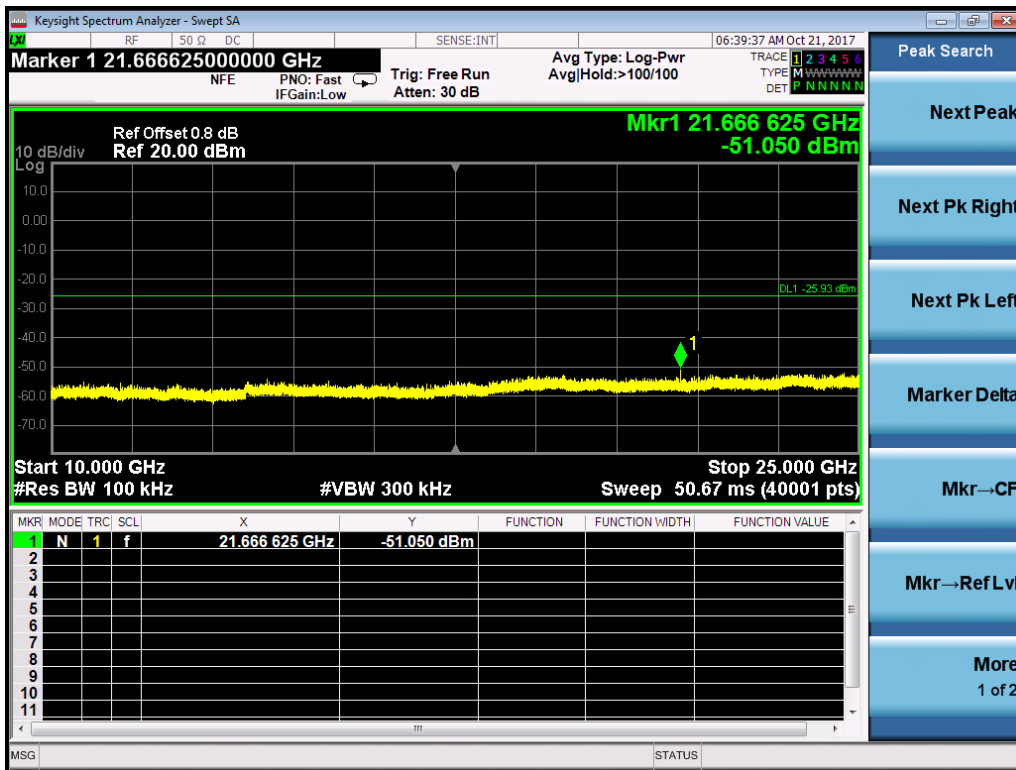
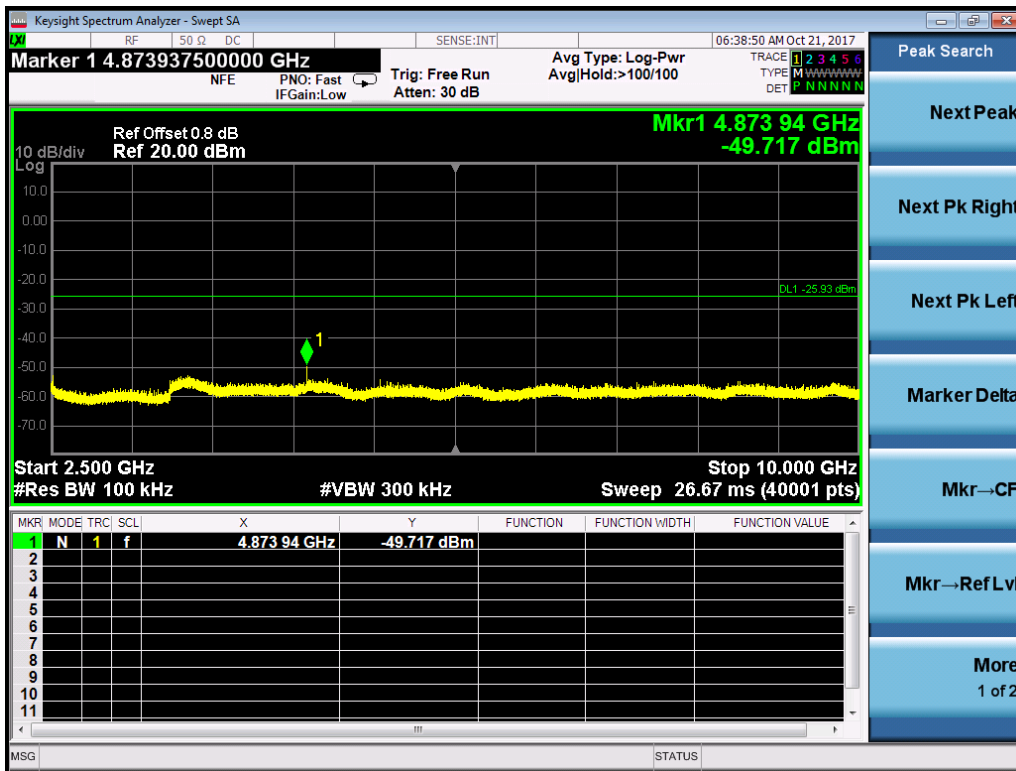

802.11n40-2452MHz

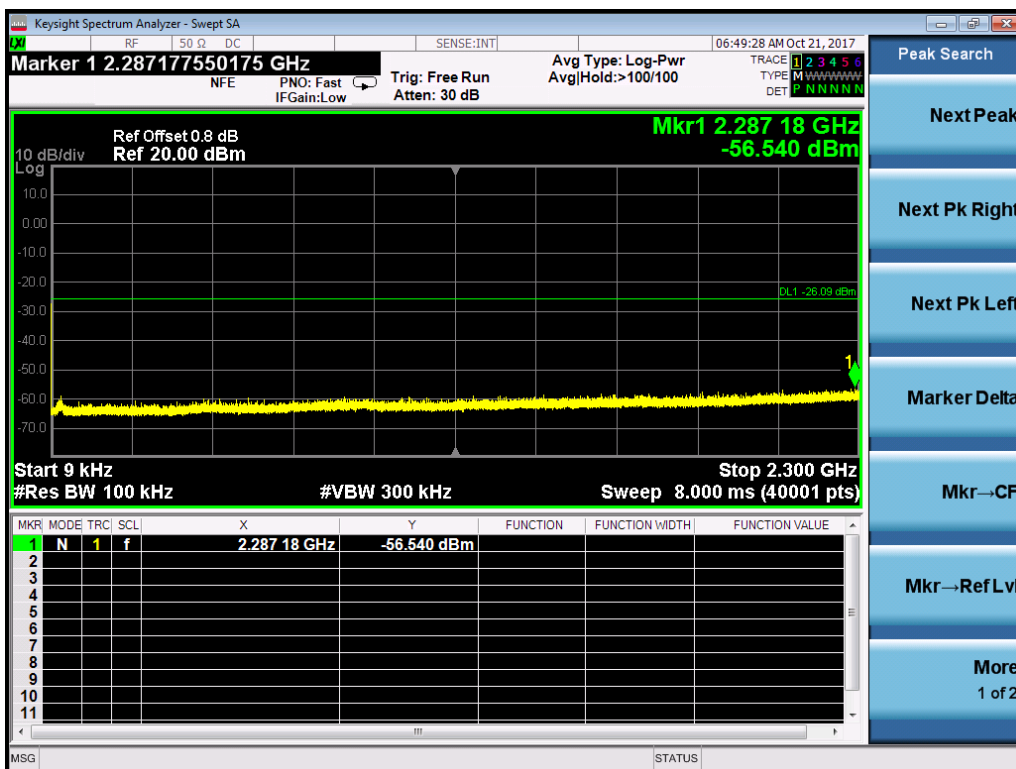
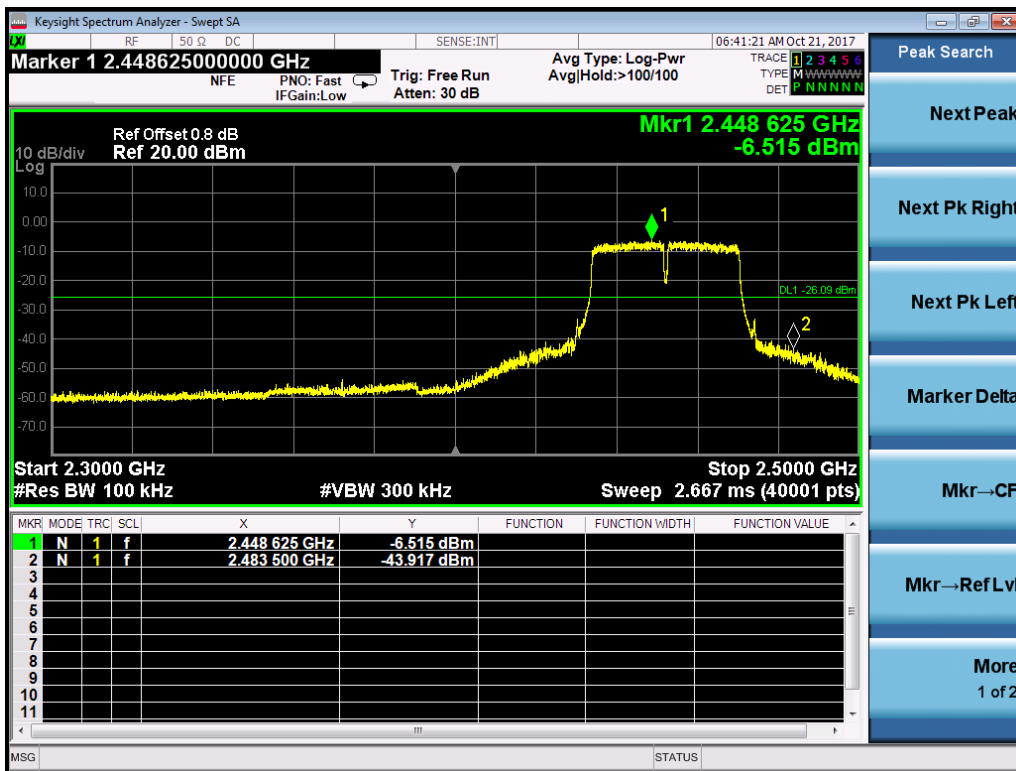

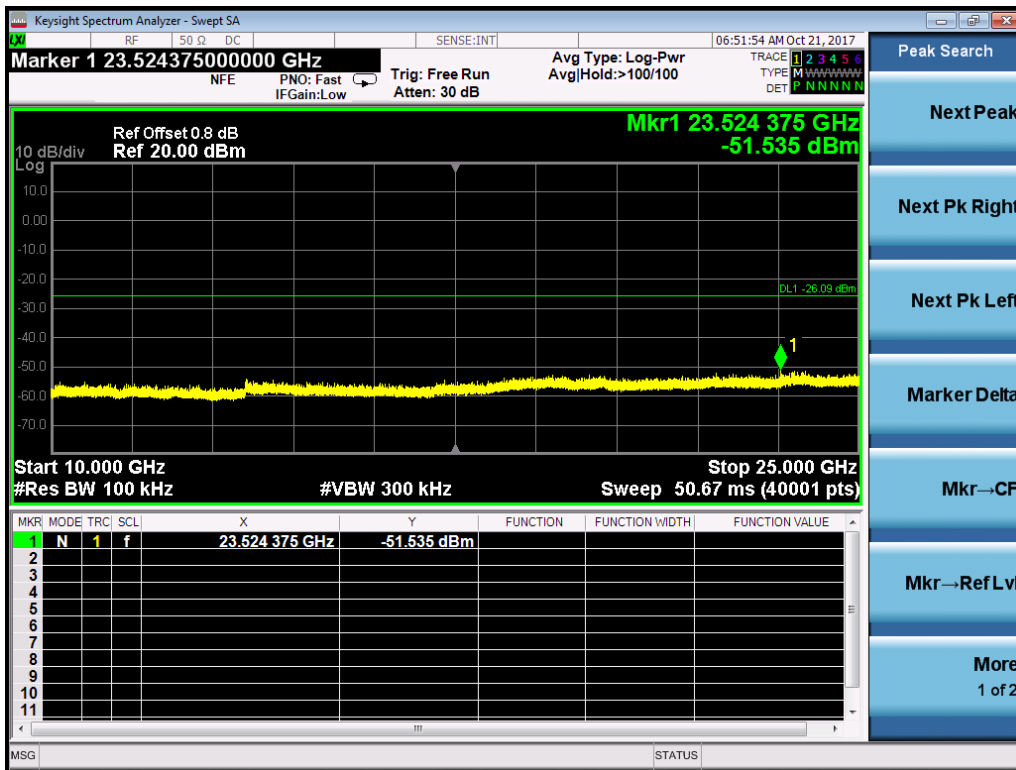
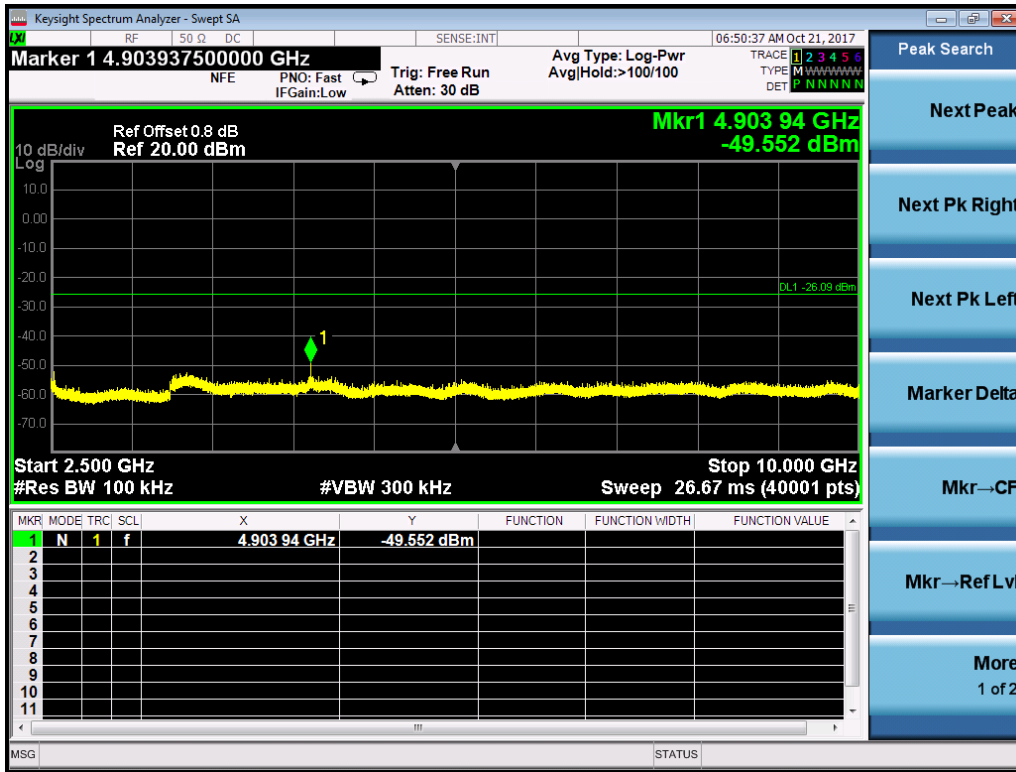

7 Radiated Emissions

Test result: Pass

7.1 Test limit

The radiated emissions which fall in the restricted bands, as defined in §15.205(a), must also comply with the radiated emission limits specified in §15.209(a) showed as below:

Frequencies (MHz)	Field Strength (microvolts/meter)	Measurement Distance (meters)
0.009 ~ 0.490	2400/F(kHz)	300
0.490 ~ 1.705	24000/F(kHz)	30
1.705 ~ 30.0	30	30
30 ~ 88	100	3
88 ~ 216	150	3
216 ~ 960	200	3
Above 960	500	3

7.2 Test Configuration

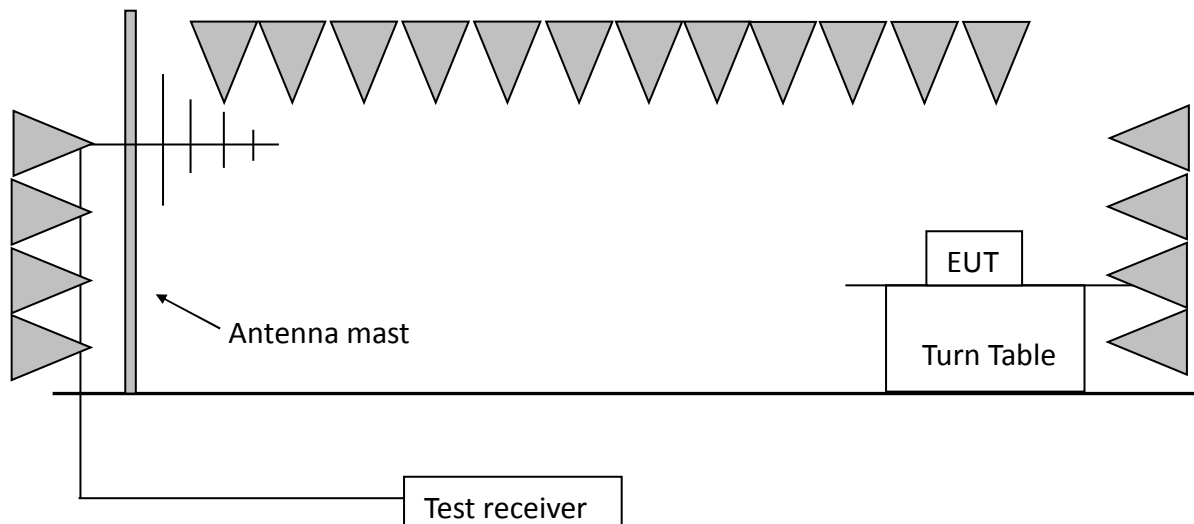

7.3 Test procedure and test setup

The measurement was applied in a semi-anechoic chamber. While testing for spurious emission higher than 1GHz, if applied, the pre-amplifier would be equipped just at the output terminal of the antenna.

Tabletop devices shall be placed on a nonconducting platform with nominal top surface dimensions 1 m by 1.5 m. For emissions testing at or below 1 GHz, the table height shall be 80 cm above the reference ground plane. For emission measurements above 1 GHz, the table height shall be 1.5 m.

The turntable rotated 360 degrees to determine the position of the maximum emission level. The EUT was set 3 meters away from the receiving antenna which was mounted on an antenna mast. The antenna moved up and down between from 1meter to 4 meters to find out the maximum emission level.

The EUT was tested according to DTS test procedure of KDB558074 D01 DTS "Meas Guidance" for compliance to FCC 47CFR 15.247 requirements.

The radiated emission was measured using the Spectrum Analyzer with the resolutions bandwidth set as:

RBW = 300 Hz, VBW = 1 kHz (9 kHz~150 kHz);
RBW = 10 kHz, VBW = 30 kHz (150 kHz~30MHz);
RBW = 100 kHz, VBW = 300 kHz (30MHz~1GHz for PK)
RBW = 1MHz, VBW = 3MHz (>1GHz for PK);

Remark:

1. Factor= Antenna Factor + Cable Loss (-Amplifier, is employed)
2. Measured level= Original Receiver Reading + Factor
3. Margin = Limit – Measured level
4. If the PK measured level is lower than AV limit, the AV test can be elided.

Example:

Assuming Antenna Factor = 30.20dB/m, Cable Loss = 2.00dB,
Gain of Preamplifier = 32.00dB, Original Receiver Reading = 10dBuV.
Then Factor = 30.20 + 2.00 – 32.00 = 0.20dB/m;
Measured level = 10dBuV + 0.20dB/m = 10.20dBuV/m
Assuming limit = 54dBuV/m,
Measured level = 10.20dBuV/m, then Margin = 54 - 10.20 = 43.80dBuV/m.

7.4 Test Protocol

Temperature: 25 °C
Relative Humidity: 55 %

The low frequency, which started from 9 kHz to 30MHz, was pre-scanned and the result which was 20dB lower than the limit line per 15.31(o) was not reported.

The worst waveform from 30MHz to 1000MHz is listed as below:

Horizontal

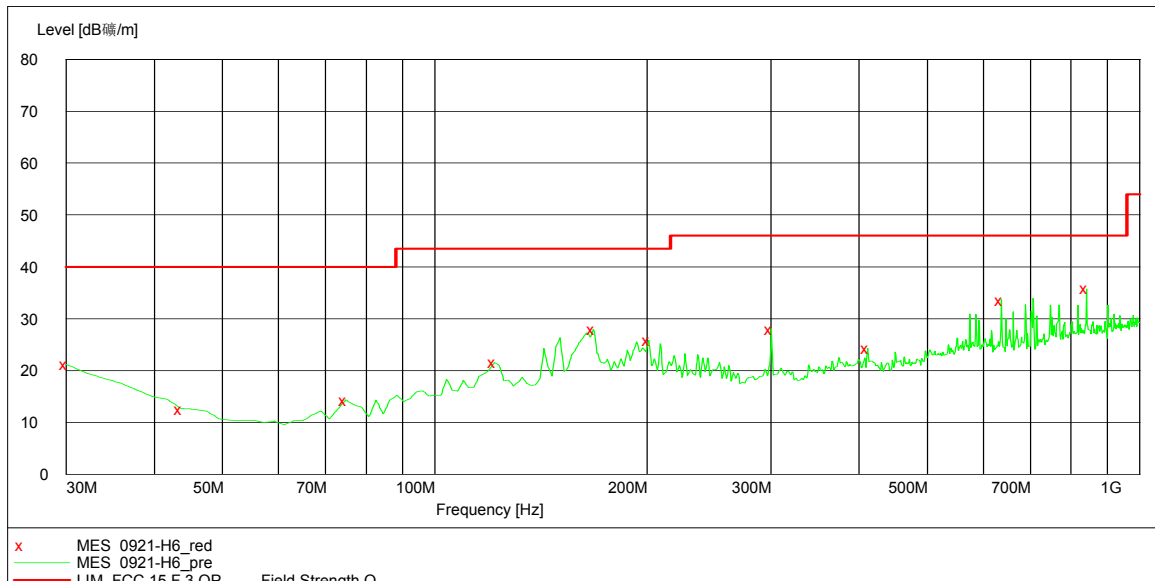

Vertical



Test data 30MHz~1GHz:

Polarization	Frequency (MHz)	Measured level (dB μ V/m)	Limits (dB μ V/m)	Margin (dB)	Detector
H	30.00	21.2	40.0	18.8	PK
	43.61	12.7	40.0	27.3	PK
	74.71	14.3	40.0	25.7	PK
	121.36	21.5	43.5	22.0	PK
	168.02	27.9	43.5	15.6	PK
	201.06	25.8	43.5	17.7	PK
	300.20	28.1	46.0	17.9	PK
	411.00	24.3	46.0	21.7	PK
	636.49	33.6	46.0	12.4	PK
	840.60	35.8	46.0	10.2	PK
V	30.00	20.8	40.0	19.2	PK
	43.61	14.2	40.0	25.8	PK
	74.71	13.2	40.0	26.8	PK
	103.87	17.5	43.5	26.0	PK
	166.07	18.1	43.5	25.4	PK
	193.29	17.2	43.5	26.3	PK
	335.19	19.4	46.0	26.6	PK
	494.59	24.5	46.0	21.5	PK
	556.79	27.6	46.0	18.4	PK
	935.85	29.9	46.0	16.1	PK

Note: The worst test result (30MHz to 1GHz) of 802.11g channel L (2412MHz) was chosen to list in the report as representative.

Test result above 1GHz:

The emission was conducted from 1GHz to 25GHz.

802.11b:

CH	Antenna	Frequency (MHz)	Measure Level (dBuV/m)	Reading Level (dBuV)	Over Limit (dB)	Limit (dBuV/m)	Factor (dB)	Type
L	H	2390.00	51.35	20.15	-22.65	74.00	31.20	PK
	H	2390.00	40.33	9.13	-13.67	54.00	31.20	AV
	H	4824.00	49.84	47.14	-24.16	74.00	2.70	PK
	V	4824.00	45.32	42.62	-28.68	74.00	2.70	PK
M	H	4874.00	48.64	45.97	-25.36	74.00	2.68	PK
	V	4874.00	44.82	42.15	-29.18	74.00	2.68	PK
H	H	2483.50	51.14	19.95	-22.86	74.00	31.19	PK
	H	2483.50	40.94	9.75	-11.46	54.00	31.19	AV
	H	4924.00	47.97	45.21	-26.03	74.00	2.77	PK
	V	4924.00	42.41	39.64	-31.59	74.00	2.77	PK

802.11g:

CH	Antenna	Frequency (MHz)	Measure Level (dBuV/m)	Reading Level (dBuV)	Over Limit (dB)	Limit (dBuV/m)	Factor (dB)	Type
L	V	2390.00	52.17	20.97	-21.83	74.00	31.20	PK
	V	2390.00	44.45	13.25	-9.55	54.00	31.20	AV
	V	4824.00	46.32	43.62	-27.68	74.00	2.70	PK
	V	4824.00	42.17	39.47	-31.83	74.00	2.70	PK
M	V	4874.00	45.33	42.66	-28.67	74.00	2.68	PK
	V	4874.00	41.38	38.71	-32.62	74.00	2.68	PK
	V	7311.00	44.23	36.24	-29.77	74.00	7.99	PK
	V	7311.00	40.41	32.42	-33.59	74.00	7.99	PK
H	V	2483.50	51.88	20.69	-22.12	74.00	31.19	PK
	V	2483.50	42.54	11.35	-31.46	74.00	31.19	AV
	V	4924.00	44.74	41.98	-29.26	74.00	2.77	PK
	V	4924.00	41.42	38.65	-32.58	74.00	2.77	PK

802.11n (HT20):

CH	Antenna	Frequency (MHz)	Measure Level (dBuV/m)	Reading Level (dBuV)	Over Limit (dB)	Limit (dBuV/m)	Factor (dB)	Type
L	V	2390.00	52.33	21.13	-21.67	74.00	31.20	PK
	V	2390.00	44.26	13.06	-9.74	54.00	31.20	AV
	V	4824.00	45.32	42.62	-28.68	74.00	2.70	PK
	V	4824.00	40.23	37.53	-33.77	74.00	2.70	PK
M	V	4874.00	45.39	42.72	-28.61	74.00	2.67	PK
	V	4874.00	39.61	36.94	-34.39	74.00	2.67	PK
H	V	2483.50	52.61	21.42	-21.39	74.00	31.19	PK
	V	2483.50	42.93	11.74	-11.07	54.00	31.19	AV
	V	4924.00	44.53	41.77	-29.47	74.00	2.76	PK
	V	4924.00	39.68	36.92	-34.32	74.00	2.76	PK

802.11n (HT40):

CH	Antenna	Frequency (MHz)	Measure Level (dBuV/m)	Reading Level (dBuV)	Over Limit (dB)	Limit (dBuV/m)	Factor (dB)	Type
L	V	2390.00	51.38	20.18	-22.62	74.00	31.20	PK
	V	2390.00	43.85	12.65	-10.15	54.00	31.20	AV
	V	4844.00	46.33	43.65	-27.67	74.00	2.68	PK
	V	4844.00	41.42	38.74	-32.58	74.00	2.68	PK
M	V	4874.00	45.25	42.58	-28.75	74.00	2.67	PK
	V	4874.00	41.34	38.67	-32.66	74.00	2.67	PK
H	V	2483.50	50.55	19.36	-23.45	74.00	31.19	PK
	V	2483.50	43.14	11.95	-10.86	54.00	31.19	AV
	V	4904.00	42.39	39.74	-31.61	74.00	2.65	PK
	V	4904.00	38.57	35.92	-35.43	74.00	2.65	PK

8 Power line conducted emission

Test result: Pass

8.1 Limit

Frequency of Emission (MHz)	Conducted Limit (dBuV)	
	QP	AV
0.15-0.5	66 to 56*	56 to 46 *
0.5-5	56	46
5-30	60	50

* Decreases with the logarithm of the frequency.

8.2 Test configuration

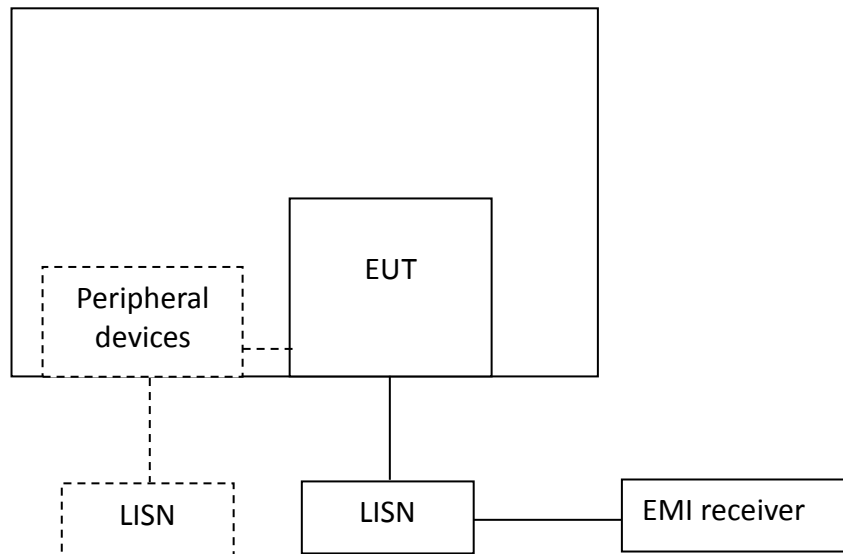

For table top equipment, wooden support is 0.8m height table

For floor standing equipment, wooden support is 0.1m height rack.

8.3 Test procedure and test set up

Measured levels of ac power-line conducted emission shall be the emission voltages from the voltage probe, where permitted, or across the 50 Ω LISN port (to which the EUT is connected), where permitted, terminated into a 50 Ω measuring instrument. All emission voltage and current measurements shall be made on each current-carrying conductor at the plug end of the EUT power cord by the use of mating plugs and receptacles on the LISN, if used. Equipment shall be tested with power cords that are normally supplied or recommended by the manufacturer and that have electrical and shielding characteristics that are the same as those cords normally supplied or recommended by the manufacturer. For those measurements using a LISN, the 50 Ω measuring port is terminated by a measuring instrument having 50 Ω input impedance. All other ports are terminated in 50 Ω loads.

Tabletop devices shall be placed on a platform of nominal size 1 m by 1.5 m, raised 80 cm above the reference ground plane. The vertical conducting plane or wall of an RF-shielded (screened) room shall be located 40 cm to the rear of the EUT. Floor-standing devices shall be placed either directly on the reference ground-plane or on insulating material as described in ANSI C63.4. All other surfaces of tabletop or floor-standing EUTs shall be at least 80 cm from any other grounded conducting surface, including the case or cases of one or more LISNs.

The bandwidth of the test receiver is set at 9 kHz.

8.4 Test protocol

Temperature: 22 °C
Relative Humidity: 52 %

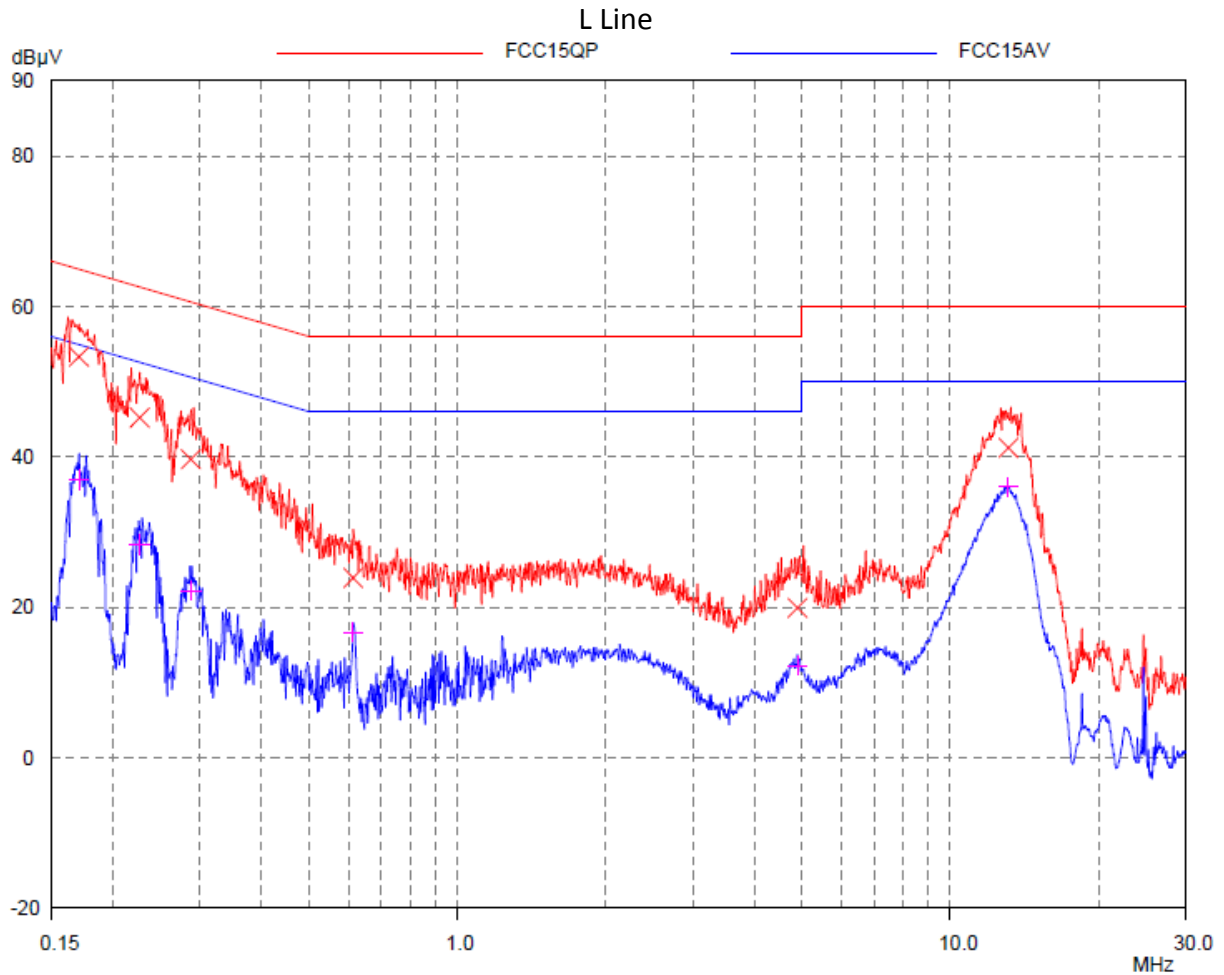

Test Data:

Frequency (MHz)	Quasi-peak			Average		
	level dB(µV)	Limit dB(µV)	Margin (dB)	level dB(µV)	limit dB(µV)	Margin (dB)
0.170	53.32	64.94	11.62	36.97	54.94	17.97
0.226	45.23	62.59	17.36	28.38	52.59	24.21
0.288	39.69	60.60	20.91	22.23	50.60	28.37
0.614	23.93	56.00	32.07	16.73	46.00	29.27
4.894	19.91	56.00	36.09	12.25	46.00	33.75
13.117	41.21	60.00	18.79	36.00	50.00	14.00

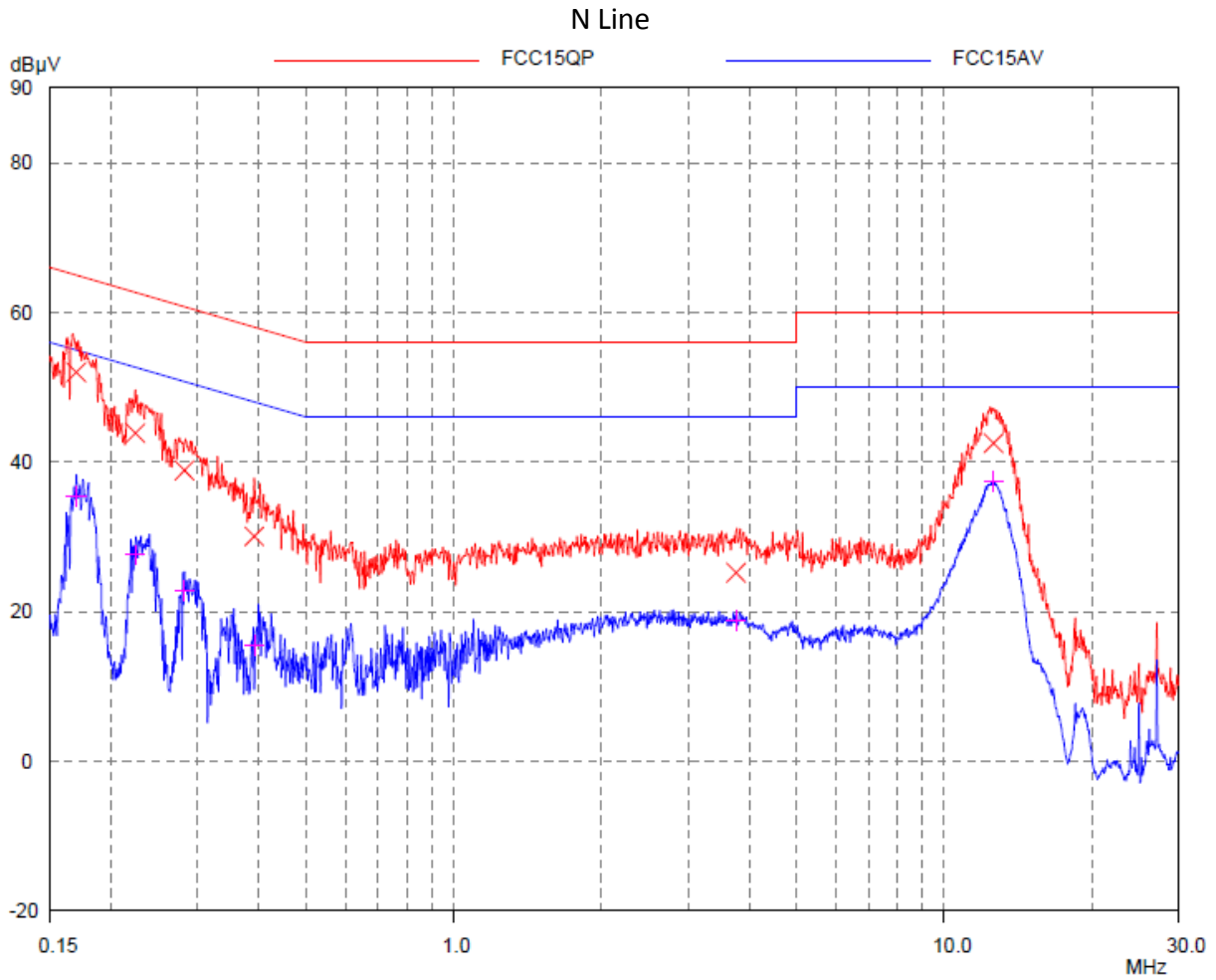

Test Data:

Frequency (MHz)	Quasi-peak			Average		
	level dB(µV)	Limit dB(µV)	Margin (dB)	level dB(µV)	limit dB(µV)	Margin (dB)
0.170	52.01	64.97	12.96	35.47	54.97	19.50
0.224	43.87	62.68	18.81	27.60	52.68	25.08
0.282	38.91	60.76	21.85	22.85	50.76	27.91
0.391	30.06	58.04	27.98	15.48	48.04	32.56
3.760	25.22	56.00	30.78	18.85	46.00	27.15
12.604	42.52	60.00	17.48	37.41	50.00	12.59