

Dump all debris from the dust box into the garbage.

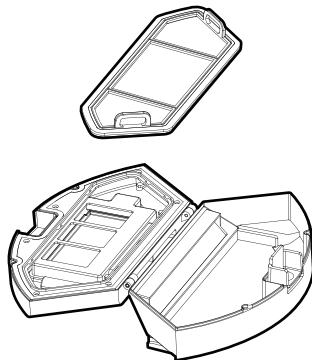

Remove the pre-filter.

### 3.2 Product Specifications

#### Structure Type

Diameter of main body	330 mm
Thickness of main body	75 mm
Net weight of main body	3.0 kg

#### Electronic Type

Voltage	14.4 V
Battery capacity	2500 mAh
Main body button type	LED button

#### Accessory Type

Dust box capacity	600 ml
Cleaning modes	Plan Cleaning / Edge Cleaning

#### Process Parameters

Charging Type	Manual/Automatic
Operating duration	$\leq$ 100 min
Charging duration	240 – 360 min

The ambient temperature range for storage of the product is 0-40 degrees Celsius

### 3.3 Product Characteristics

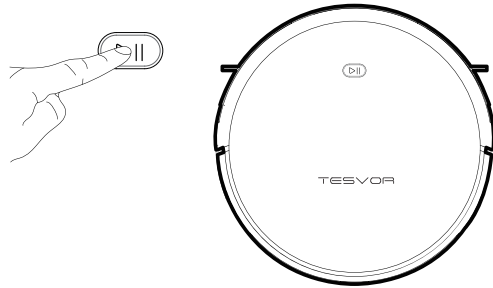

#### Humanized Design

It is simple to operate. You can control the robot only by pressing the Control button! Follow the prompt tone to operate the robot!

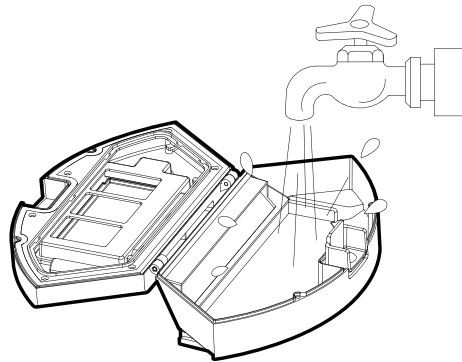

#### Dust box can be washed with water

The dust box and the pre-filter can be directly flushed with water without too much labor, which can avoid secondary pollution caused by dust flying!

### 5.1 Side Brush Cleaning and Replacement

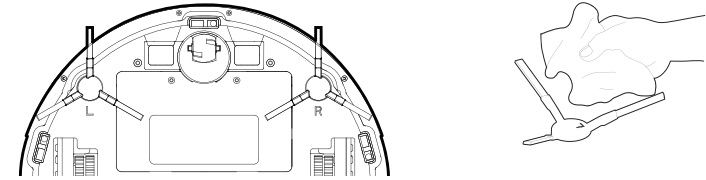

Check the side brush's condition frequently to see if it has been damaged or entangled with other objects. Clean the side brush with a cleaning tool or cloth. When the side brush is damaged and cannot be used, please replace it as soon as possible. L and R correspond to each other.

### 5.2 Cleaning of Dust Box and Filter

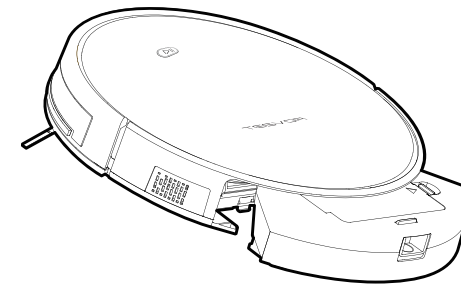

Press the release button on the dust box to remove it.

## Cleaning Modes

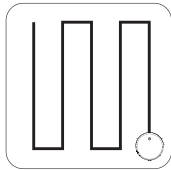

### Plan Cleaning

The robot will perform the smart Plan Cleaning according to the room environment.

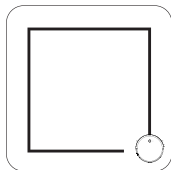

### Edge Cleaning

The robot will clean along the longest edge of the room.

## 4.1 Remote Control Instructions

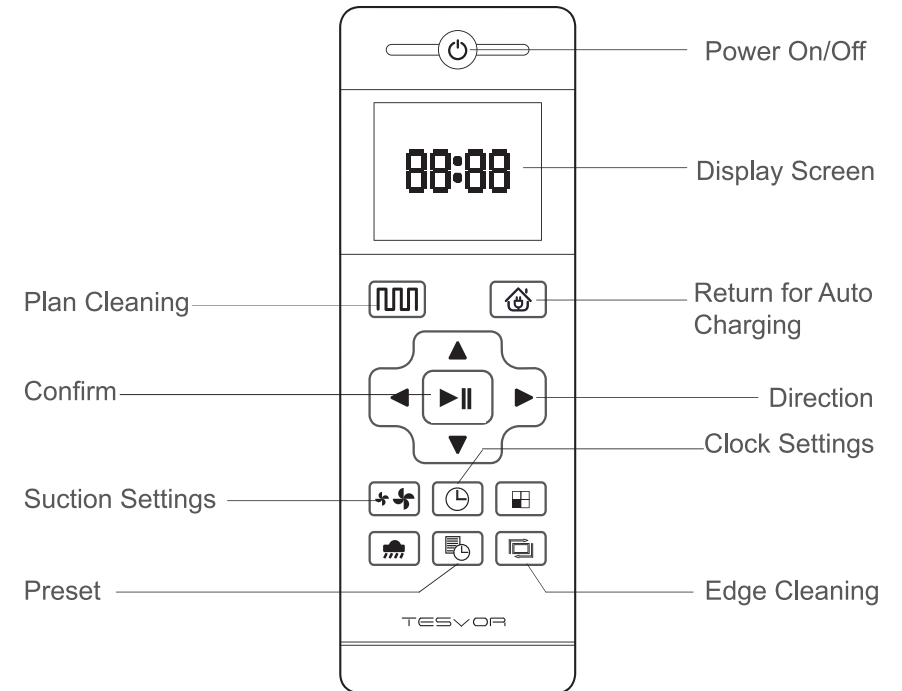

When the robot is in the vicinity of the charging base and the virtual protection wall, it may not be able to distinguish the instructions issued by the remote control. If you do not use the remote control for a long time, please remove the battery.

### Plan Cleaning button

At any cleaning mode, press this button to enter the Plan Cleaning mode.

### Auto Charging

Press this button to enter the auto charging mode, and the screen displays of remote control.

**▲ Forward /+**

At the standby mode, press this button to continue moving forwards, and release it to return to the standby mode.

At the Preset mode or the Time Settings mode, press this button to increase the number.

**▼ Backwards /-**

At the standby mode, press this button to continue moving backwards, and release it to return to the standby mode.

At the Preset mode or the Time Settings mode, press this button to decrease the number.

**◀ Left Arrow**

At the standby mode, press this button to continue turning left, and release it to return to the standby mode.

At the Preset mode or the Time Settings mode, press this button to switch from minute to hour.

**▶ Right Arrow**

At the standby mode, press this button to continue turning right, and release it to return to the standby mode.

At the Preset mode or the Time Settings mode, press this button to switch from hour to minute.

**▶|| Confirm button**

During operation, press this button to stop the robot, and it is still working at the pause.

At the Preset or Clock Settings mode, press this button to save the settings.

**✦✦ Suction Settings button**

At any cleaning mode, press this button to adjust the suction power.

**🕒 Clock Settings button**

Press this button to enter the Clock Setting mode and press the OK button to exit.

**🕒 Preset button**

At the standby mode, press this button to enter the presetting mode, and the display flashes icon 🕒.

At the preset mode, press this button to save the data and exit the preset mode, and the display will always display the icon 🕒.

At the preset mode, press the preset button for 3S to cancel the preset function, and the displayed icon 🕒 will disappear.

**🏠 Edge Cleaning button**

Press this button to enter the Edge Cleaning mode.



Display preset time



Display clock time

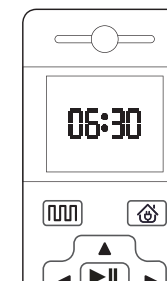

- ☆ Once the power switch is turned off, all pre-settings will be cancelled.
- ☆ Once the presetting is in effect, the robot will start working at the appointed time every day.

Press the "Preset" button to set the robot's scheduled cleaning time. (e.g. Set the robot to 6:30 am at the standby mode, the machine will start cleaning at 6:30 am every day).

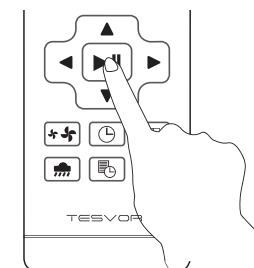

- ☆ At the preset cleaning mode, all operations will be prompted to confirm.

- ① Press the Preset button so that the robot enters the Preset mode and set the preset time on the remote control.
- ② After setting is completed, press the Power on/off button or Preset button to complete the setting of Preset. During the setting, you need to face the robot.
- ③ If you need to cancel the presetting, you can press the Preset button for 3 seconds.

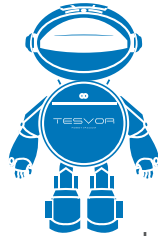

### Charging Instructions

01. The battery should be repaired and replaced by the aftersales department.
02. For the very first operation, please let the robot run out of power.
03. When the robot is charged, the Control button will flash a green lamp in a circular manner.
04. If the robot is out of service for a long time, please turn off the power switch.
05. Please charge the robot as soon as possible after the battery is used up.
06. The product can only use the power adapter and charger provided by the factory.
07. Please charge the robot for 12 hours for the first time of operation. When the charge is done, the Control button light turns off.

### 4.2 Operating Instructions

#### Placement of the Charging Base

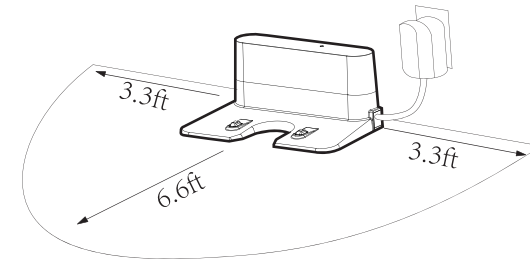

Place the seat flat against the wall. Do not place any objects within 3.3 ft to the left / right and 6.6 ft to the front, and do not place any mirrors or other reflective objects within this distance.

#### Preset cleaning

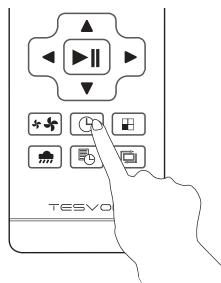

You can set the robot by pressing the Time Settings button on the remote control to the current U.S. time, and press OK button.

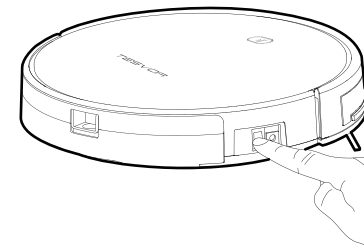

Switch on the robot, which makes the Control button green, and enter the Select mode. If the robot is not active within 3 minutes, the robot will enter Sleep mode.

### Charging Modes

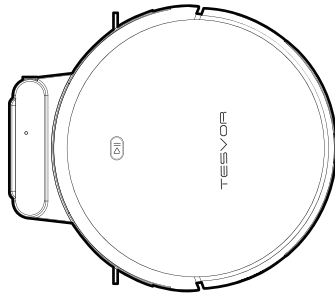

At any mode, select the Return for Auto Charging button on the remote control to make the robot return for charging.

### Auto Charging

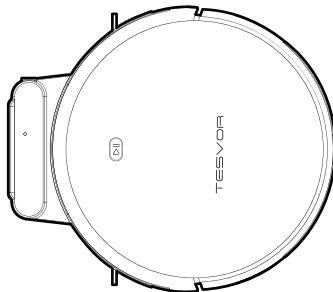

When cleaning is completed or the battery is too low, the robot will automatically start finding the charging base to charge itself. Please keep the charging base energized, otherwise the machine will not be able to find the charging base.

### Switching Modes

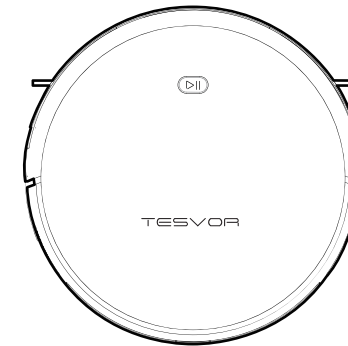

### Startup

01. Make sure the power switch on the side of the robot is turned on.
02. Press the Control button or the Cleaning mode on the remote control to start the robot.

### Pause

The pause function is to switch the robot from the operating mode to the selected mode, and the robot can be paused by the following operations:

01. Press the Control button on the robot to pause the robot.
02. Press the power on/off button on the remote control to pause the robot.

### Sleep

Sleep mode means that the robot is stopped and the indicator light is off.

If the robot is not active within 3 minutes, the robot will enter Sleep mode automatically.

Note: If the robot is out of service for a long time, please turn off the power switch.