

# ROBOTIC VACUUM CLEANER

USER MANUAL

(Before using this product, please read the safety instructions below and follow all the routine safety precautions)



# Content

---

## 1. Wi-Fi Setup Instructions

## 2. Safety Instructions

## 3. Product Components

- 3.1 Name of Parts
- 3.2 Products Specifications
- 3.3 Product feature

## 4. Instructions for Use

- 4.1 Attention
- 4.2 Remote Controller Instructions
- 4.3 Operating Instructions

## 5. Product Maintenance

- 5.1 Side Brush Cleaning and Replacement
- 5.2 Cleaning of Dust Box and Filter
- 5.3 Maintenance of Water Tank Components
- 5.4 Maintenance of Rolling Brush Components
- 5.5 Maintenance of Other Components

## 6. Common Faults

- 6.1 Common Faults
- 6.2 Replaceable Modules

## 7. Product hazardous material labeling

# Wi-Fi Setup Instructions

## Wi-Fi Setup Instructions

1

Scan the QR code in Figure 1 to download and install "WeBack" APP, or download and install from other APP stores.



IOS



Google Play

Figure 1



Figure 2



Figure 3

2

Open App, directly log in if you have a "WeBack" account; if not, you can select "New User" to sign up, and click on "+" after login.



3

Scan the QR code on the device or the QR code on the right side, or manual input the QR code/Barcode to confirm the device model, turn on the "Power switch" by following APP instructions and go to the next step.



Figure 4



x560-plus

# Wi-Fi Setup Instructions

## Wi-Fi Setup Instructions



Figure 5

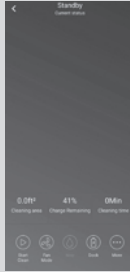

Figure 6

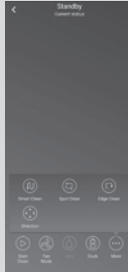

Figure 7

When you see the APP enter interface Figure 5, you can start using APP to control your ROBOT. Tap the device to enter the main interface of APP (Figure 5), from this interface you can choose different cleaning modes, also to check the cleaning process/status. Tap the "more" Key (Figure 6) to enter the multi-functional panel (Figure 7).

# 4

# 5

On the device management page, click the button "⚙️" (Figure 8), in the upper right corner of the device to enter the settings page (Figure 9).



Figure 8

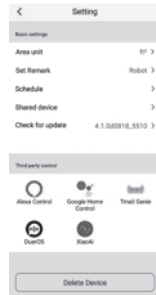

Figure 9

# Safety Instruction

---

Before using this product, please read the safety instructions below and follow all the routine safety precautions.

Please read the instructions carefully and keep them for future reference.

Any operation that does not conform to the instructions may cause damage to the product.

## Safety considerations of Main Body and Accessories

### **Warning**

01. Do not disassemble, repair or refit the product without authorization; otherwise it may damage the product or pose a hazard.
02. Do not use the product in an environment with risk of fire or explosion.
03. This product can only use the original power adapter; otherwise the product may be damaged or catch on fire.
04. Do not stand or sit on this product; doing so could damage the product or cause it to fall over.
05. When the metal part of the power plug is dusty, please wipe it with a dry cloth.
06. The power adapter is applied to a 100-240V AC voltage. Please plug into the socket properly and keep away from children.
07. Do not wash or soak the main body and electronic accessories in the water; otherwise the product may be damaged by a short circuit.
08. Do not damage, load weight on, heat, pull, or bend it.
09. During cleaning, please pay attention to the safety of toddlers and elders at home to avoid injury. (Please pay special attention to toddlers).
10. This product is for home use. Please do not use it outdoors.
11. Do not allow metal and conductive materials to come in contact with the battery; doing so may cause a short circuit.

### **Attentions**

01. Do not touch the product with wet hands; doing so may cause an electric shock.
02. Please do not place the product in places where it could easily fall, such as tables, chairs, high platforms in room, etc.
03. The product has a sophisticated design and should be protected from long-term exposure to sunlight.
04. Please do not use the product in humid environments, such as bath-rooms.
05. Please do not place the product near cigarette butts, lighters or other open fires.
06. Please clean the product after finishing charging.
07. Please turn off the power switch on the side of the robot when the product is out of service for a long time.
08. Please check carefully to see if the power adapter is connected to the socket prior to use, to avoid damage to the robot.

# Safety Instruction

---

09. Before using the product, please remove all vulnerable items on the floor, such as glass, lamps, and items such as wires and curtains that may entangle with the side brush and suction passages.
10. When the dust box is full, please empty it before using again.
11. Please do not use the robot to clean the construction waste.
12. The operating temperature of the product ranges from 0 degree Celsius to 40 degrees Celsius; please do not use it in a high temperature environment.
13. Before the product is scrapped, please remove the battery from the robot. When you remove the battery, please ensure that the product is not connected to a power supply. Please recycle the battery safety or environmental protection.

## Safety Considerations for Rechargeable Battery

### ⚠ **Danger**

01. Always use a dedicated battery adapter to avoid leakage, heating or rupture.
02. Do not short-circuit the battery or remove the battery; doing so may cause leakage, heating or rupture.
03. Do not transport or preserve with necklaces, hairpins, and other metal objects; doing so may lead to short circuit, resulting in leakage, heating or rupture.
04. Do not burn or heat the battery; doing so may cause leakage, heating or rupture.

### ⚠ **Attention**

01. If abnormal overheating is discovered during charging, stop using it immediately to avoid leakage, heating or rupture.
02. To prolong the service life of the battery, please remove the battery and place it in a cool, dry environment if it is out of service for a long time; this will avoid leakage, heating or rupture.
03. Do not soak in water or let it come into contact with any liquid; otherwise it may cause leakage, heating and rupture.
04. Be sure to stop using it immediately in case of any exception (e.g. discoloration or deformation), to avoid leakage, heating and rupture.
05. Always use tape to insulate the battery's electrode when recycling or disposing of it.
06. If the battery leaks, wipe it clean with a dry cloth, recycle it in time, or discard it.
07. Put the recycled batteries in the recycling bins set up by the community, hotels, schools, large shopping malls, supermarkets, etc or the hazardous trash can collected by professional recycling agencies. Discarded product batteries must be removed and discarded in accordance with local laws and regulations.

# Safety Instruction

## ⚠ Warning

01. When skin or clothing is exposed to the battery electrolyte, immediately wash with clean water to avoid inflammation of skin, etc.
02. Do not use the rechargeable battery on other devices. This battery is only suitable for this robot.
03. If the battery's outer box is found to be deformed and expanded, or leakage of electrolytes is found, do not charge or continue to use to avoid danger.
04. Do not throw or inflict a strong impact on the battery; doing so may cause leakage, heating and rupture.
05. Do not disassemble the battery pack; doing so may cause battery rupture and electrolyte outflow, leading to fire, explosion and other dangers.

## How to remove the battery

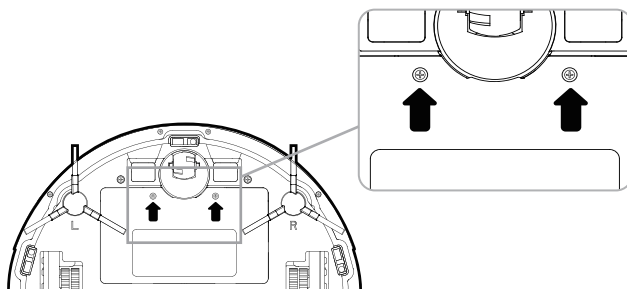

01. Take out two screws on the battery cover with a screw driver.
02. Take out the battery cover.
03. Take out the battery and unplug the electric wires to remove the battery.



# Product Components

## 3.1 Name of Parts

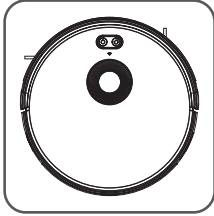

Main Body

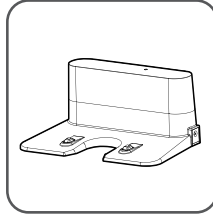

Charging Base

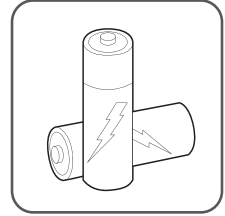

2XAAA batteries

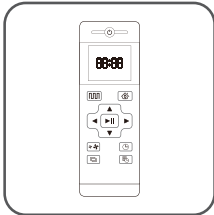

Remote Controller

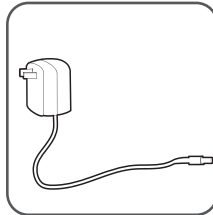

Power Adapter

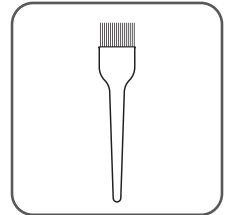

Cleaning Tool

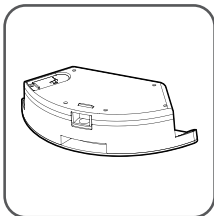

Water Tank Component

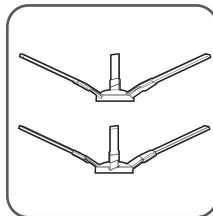

Side Brushes

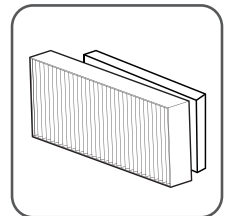

High-efficient Filter

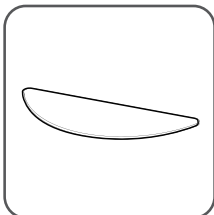

Mop

Accessories of some models may be slightly different and they are subject to the actual received products.

# Product Components

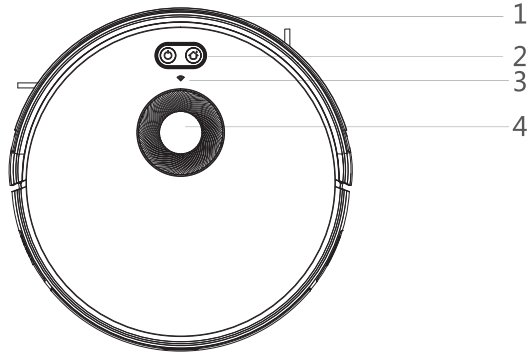

Main Body

1. Bumper    2. Control Button    3. WIFI Indicator    4. Laser Components

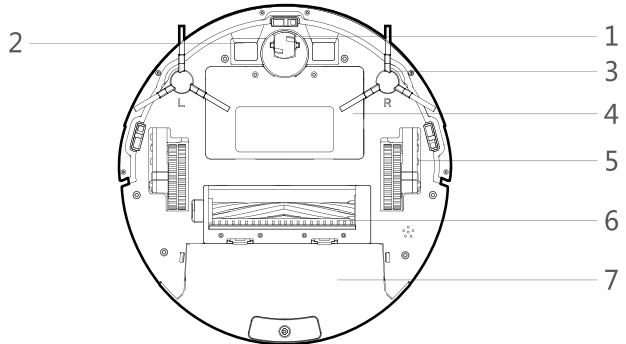

Main Body

1. Universal Wheel    2. Electrode Slice    3. Side Brush    4. Battery Cover  
5. Side Wheel    6. Suction Port    7. Dust box

# Product Components

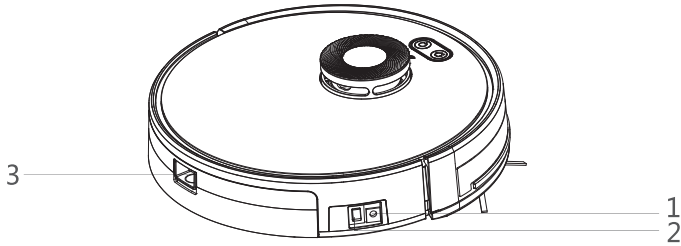

## Main Body

1.DC Power Jack

2.Power Switch

3.Dust box/Water tank release botton

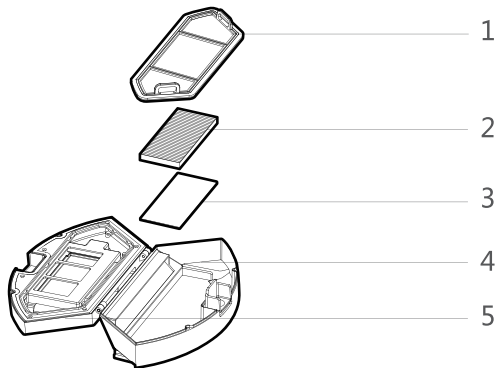

## Dust Box

1. Pre-filter

2.High-efficient filter

3.Filter sponge

4.Dust Box

5. Dust box cover

# Product Components

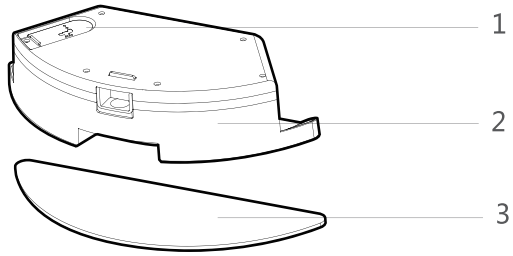

## Water Tank Component

1. Tank sealing cap

2. Water tank

3. Mop

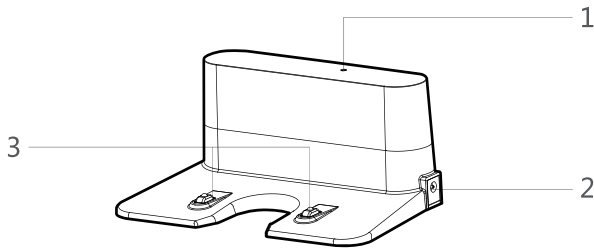

## Charging base

1. Charging indicator

2. DC power jack

3. Charging terminal

# Product Components

---

## 3.2 Product Specification

### Structure

Diameter of the main body	330mm
Thickness of the main body	101mm
Net weigh of the main body	3.1kg

### Electronic

Voltage	14.8V
Battery capacity	2600mAh
Main body button type	LED button

### Accessory

Water tank capacity	350ml
Dust box capacity	600ml
Cleaning cloth (polyester cotton)	295X100X4mm

### Process Parameters

Charging Type	Manual/Automatic
Operating Duration	Approx.100min
Charging duration	240-360min

# Product Components

---

## 3.3 Product Characteristics

### Multiple smart cleaning modes

4 cleaning modes are designed to suit different needs, which can be switched by the remote controller and App, greatly improves the cleaning efficiency and saves 30% of the power.

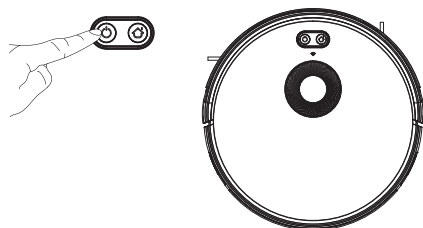

### Humanized design

It is simple to operate, pressing the Control Button to start cleaning. Follow the Voice Prompt and let the robot start working for you.

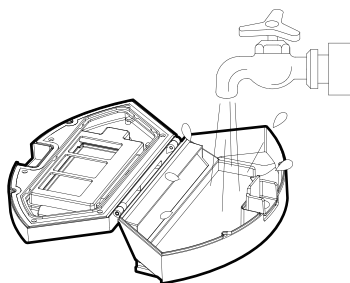

### Dust box can be washed with water

The dust box and the pre-filter can be directly flushed with water without too much labor, which can avoid secondary pollution caused by dust flying!

# Instructions for Use

## 4.1 Attention

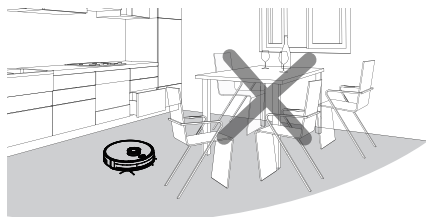

When it is working, please help to remove the unfriendly obstacles. Put the furniture and home appliances such as tables and chairs in the house neatly, the robot will clean up smoothly to give you a clean new home.

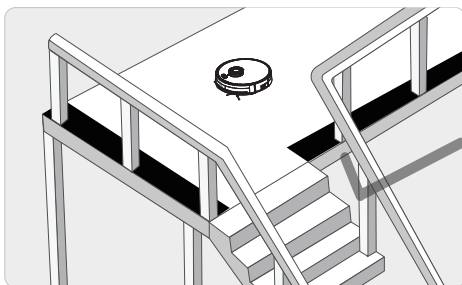
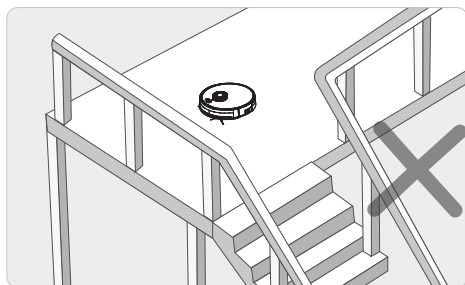

If the robot works at the stairway, the edge of the step, or the entrance to the narrow area among the furniture, etc, please place a fence to ensure it is safe and running smoothly.

## Instructions for Use

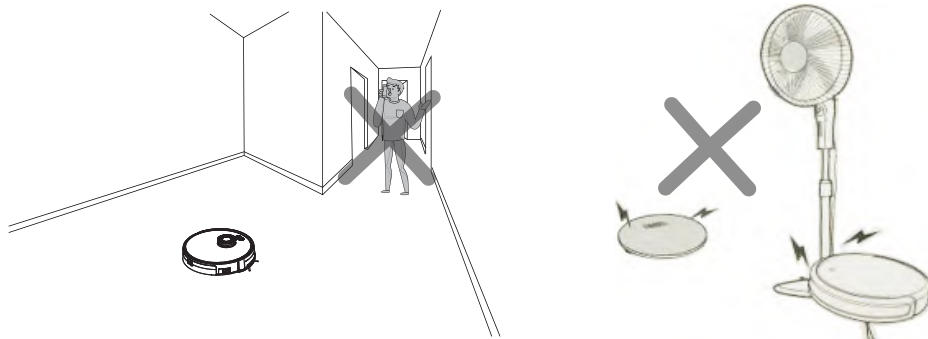

Please do not stand in narrow places such as thresholds and aisles to avoid missing sweeping. When the robot is working, please ensure that the object with the thickness less than 1.8 cm is not placed in the cleaning area to prevent the machine from climbing and jamming.

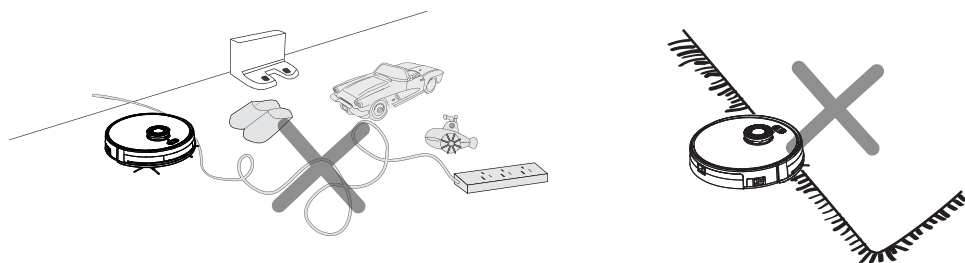

Please pay attention to remove sundries , such as the power cords, toys, etc, which are scattered on the ground may catch or entangle the Robot.  
Do not use the mopping function on the carpet! If there is a carpet in the house, please roll up the edge of the carpet in advance.



# Instructions for Use

## 4.2 Remote controller instruction

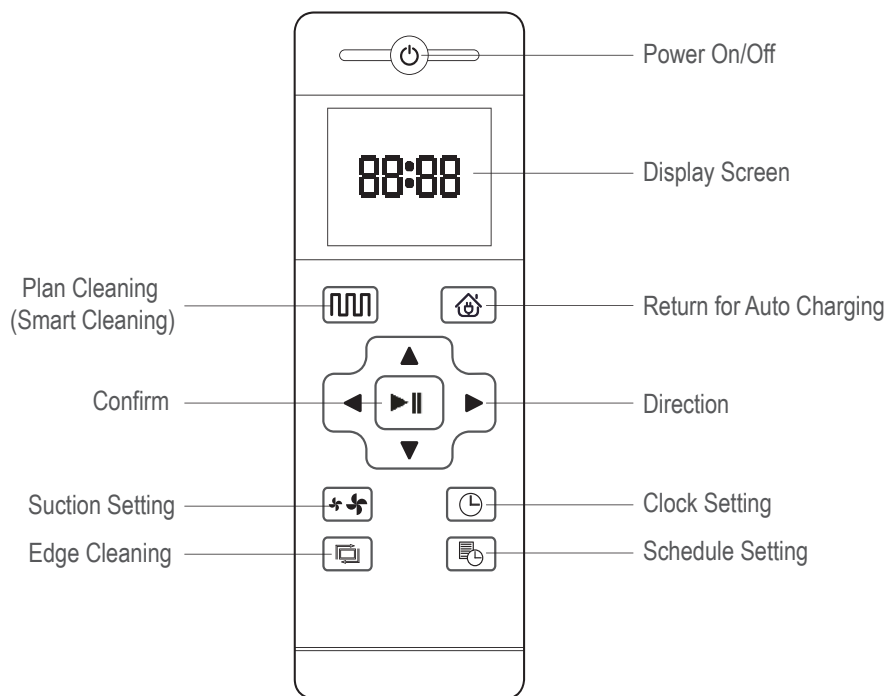

When the robot is in the vicinity of the charging base and the virtual protection wall, it may not be able to distinguish the instructions issued by the remote controller. If you do not use the remote controller for a long time, please take out the battery.

# Instructions for Use

---

## Plan Cleaning button

No matter what mode the robot is in, this button will bring it to the plan cleaning mode.

## Return for Auto Charging

Pressing this button to shift the mode as recharging, and the logo will be displayed on the screen of the remote controller.

## Forward /+

At the standby mode, press this button to continue moving forwards, and release it to return to standby mode. At the Schedule setting mode, press this button to increase the number.

## Back Button /-

Press this button and robot will rotate 180 degrees in situ.

In the modes of Schedule Setting and Clock Setting, press this button will decrease the number.

## Left Arrow

At the standby mode, press this button to continue turning left, and release it to return to standby mode. At the Schedule setting mode, press this button to switch from minute to hour.

## Right Arrow

At the standby mode, press this button to continue turning right, and release it to return to standby mode. At the Schedule setting mode, press this button to switch from hour to minute.

## Confirm button

During operation, press this button to stop the robot, and it is still working at the pause. In the Schedule setting mode or Clock setting mode, this button can save all settings.



## Suction Setting button

At any cleaning mode, press this button to adjust the suction power. There are Normal suction and Powerful Suction for your option.

## Clock Setting button

Press this button to enter the Clock Setting mode and press the Confirm button to exit.

## Schedule Setting button

At the standby mode, press this button to enter the Schedule Setting mode, and the display flashes icon . At the Schedule Setting mode, press this button to save the data and exit the Schedule Setting mode, and the display will always display the icon . At the Schedule setting mode, press this button for 3S to cancel the Schedule Setting function, and the displayed icon  will disappear.

## Edge Cleaning button

Press this button to enter the Edge Cleaning mode.



Display preset time



Display clock time

# Instructions for Use

## 4.3 Operating Instructions

### Placement of the Charging Base

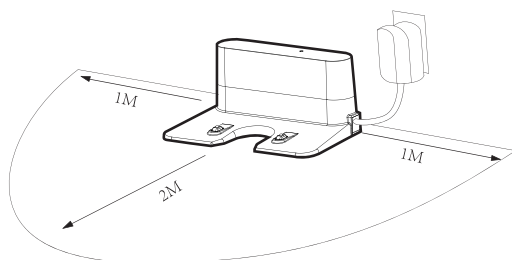

Place the charging base on the flat floor and against the wall. Do not place any objects

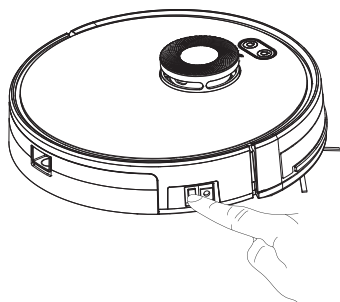

Switch on the robot, then the Control button will turn on the white light, and enter the Selected mode. if the Robot is not activated within 10 minutes, the robot will enter Sleep mode.

# Instructions for Use

## Charging modes

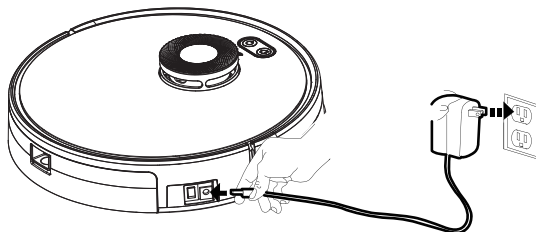

Please keep the power switch turned on before charging the machine.

### Charge mode A

Fix the charging pin into the DC power jack of the robot and plug in the power supply.

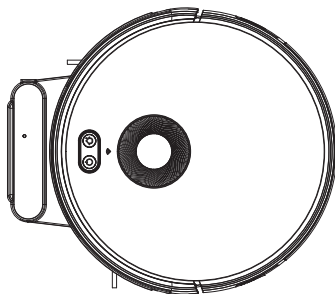

### Charge mode B:

Press Return for Auto charging button on the remote controller or Press Recharge icon on App to auto dock the Robot with the charging base.

# Instructions for Use

## Automatic Recharge

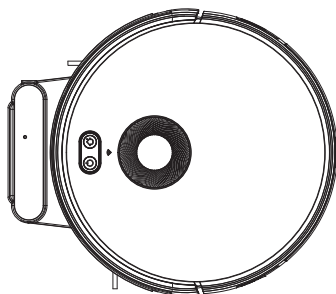

This product conforms to European ERP energy consumption standard

When Cleaning is completed or the battery is too low, the robot will automatically start finding the charging base to charge itself.

Pls keep the charging base in power, otherwise the machine will not be able to find the charging base.

### Charging instruction

01. For the very first operation, please let the robot run out of power.
02. Please charge the robot for 12 hours for the first time of operation. When the charge is done, the Control button light turns off.
03. If the robot is out of service for a long time, please turn off the power switch.
04. Please charge the robot as soon as possible after the battery is used up.
05. The product can only use the power adapter and charger provided by the factory.
06. The battery should be repaired and replaced by the after-sales service center.

# Instructions for Use

---

## Switching Modes

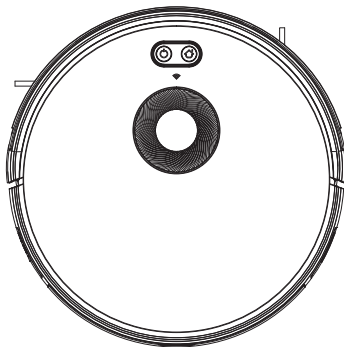

### Power on

01. Make sure the power switch on the side of the robot is turned on.
02. Press the Control button “” or the Cleaning mode on the remote controller to run the robot.

### Pause

The pause function is to switch the robot from the operating mode to the selected mode, and the robot can be paused by the following operations:

01. Press the Control button on the robot to pause the robot.
02. Press the power on/off button on the remote controller to pause the robot.

Notice: After the machine is paused, the machine can be re-operated.

### Sleep

Sleep mode means that the robot is stopped and the indicator light is off. If the Robot is not active within 10 minutes, the robot will enter Sleep mode automatically.

Note: If the robot is out of service for a long time, please turn off the power switch.

# Instructions for Use

## Use of Water Tank

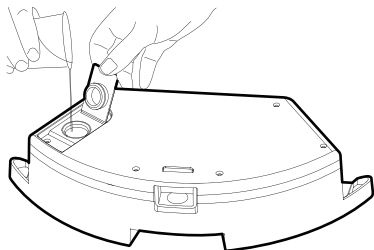

When charging, please remove the water tank to avoid danger

### How to add water

Open the tank sealing cap, fill it with enough water and slowly inject water

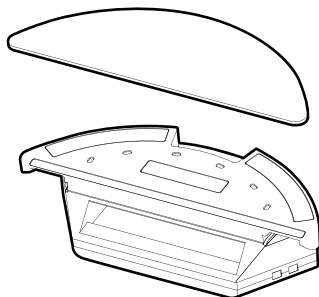

When charging, please remove the water tank to avoid danger

### How to fix the microfiber mop?

Seal the tank sealing cap, then fix the microfiber mop to the velcro on the bottom of the water tank

# Instructions for Use

---

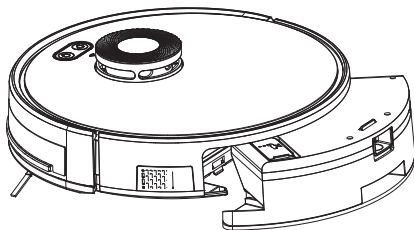

When charging, please remove the water tank to avoid danger

## How to install the water tank?

Press the release button on the dust box to remove it then install the water tank

## Schedule Cleaning

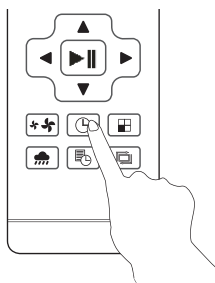

You can set the current local time on your robot by pressing the Clock Setting



# Instructions for Use

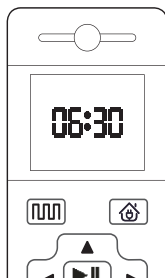

- ☆ Once the power switch is turned off, all schedule will be canceled.
- ☆ Once the schedule setting is succeeded, the robot will start working at the scheduled time everyday

Press the "Schedule Setting" button to set the scheduled cleaning time for the robot. (e.g. Setting 6:30 am to the robot, the robot will start cleaning at 6:30am every day at the standby mode.)

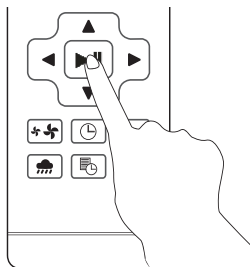

- ☆ At the Schedule Setting mode, follow the voice prompts to confirm all your operations.

1. Press the Schedule Setting button to enter the Schedule Setting mode and set the schedule on the remote controller or APP.
2. If you need cancel the schedule, just press the Schedule Setting button for 3 seconds.

# Instructions for Use

---

## Cleaning Modes

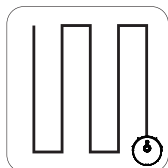

### Plan Cleaning (S shape Cleaning)

The robot will perform the plan cleaning in S shape according to the room environment.

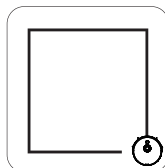

### PIEdge Cleaning

The robot will clean along the longest edge of the room

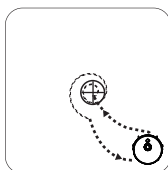

### Customize Cleaning Area

This function is only applicable to APP

Operation in a map recorded the same environment

### Single room cleaning

Planning cleaning with the biggest suction power

### Mopping mode

The Robot will perform the S shape cleaning with mop according to the room environment

### Customize cleaning area

In plan cleaning mode, once the robot set up a partial map in the same environment, just press the button of “customize cleaning area” on the APP, the robot will go to the designated area for cleaning, and it will return to the original planned cleaning area after finishing the cleaning work.

# Instructions for Use

---

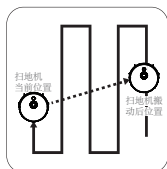

## Relocation

During the cleaning process, move the robot after the suspension, when restart, the robot will seek relocation

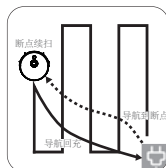

## Resume

During cleaning process, the robot will back to charging base automatically. After fully charged, the robot will back to the place where it stopped before and continuing cleaning

## Laser Relocation

In a single room, when the robot moves for a few rounds(at least one round), the laser module will establish the map of current environmental, if you suspend the robot at this time and move it, after putting down the robot, press the start button, the robot will report the "positioning" voice, and it will start rotating to seek relocation. If the relocation is successful, the robot will report the voice"successful relocation, continue to plan cleaning". If the relocation fail, the robot will report "enter into new district, star new plan cleaning", at the same time, the robot will clear all previous states.

## Resume

During the cleaning process, the robot will back to the charging base automatically if the battery power is lower than 20% capacity. After fully charged, the robot will back to the place where it stopped before and continuing cleaning

# Product Maintenance

## 5.1 Side brush cleaning and replacement

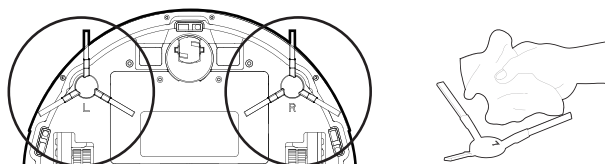

Check the side brush condition from time to time to see if it has been damaged or wrapped with foreign objects. Clean the side brush with a cleaning tool or a rag. When the side brush is damaged and cannot be used, please replace it in time, L and R side brush should be corresponding.

## 5.2 Dust box and filter cleaning

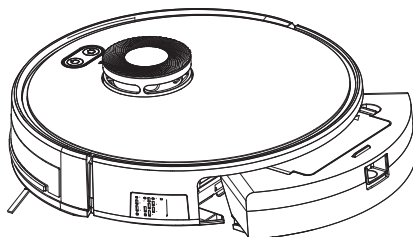

Press the dust box release button to remove the dust box

## Product Maintenance

---

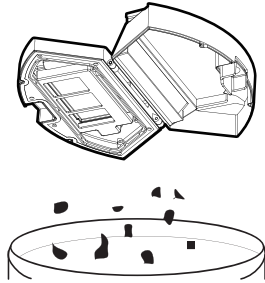

Open dust bin cover, and dump garbage

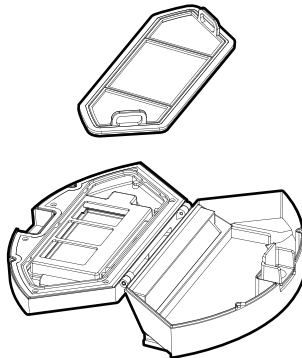

Remove the primary filter

## Product Maintenance

---

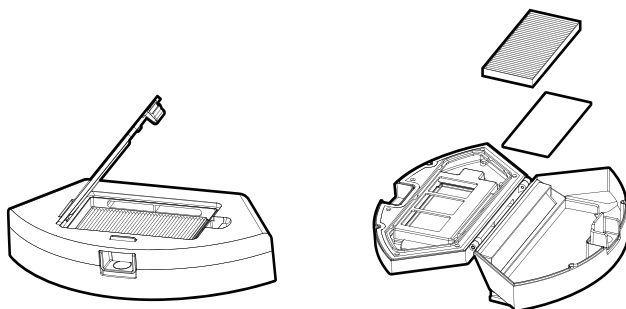

Open the high-efficient filter cover, and remove the high-efficient filter and filter sponge. It is not recommended to wash the high-efficient filter with water. Please put off the debris carefully.

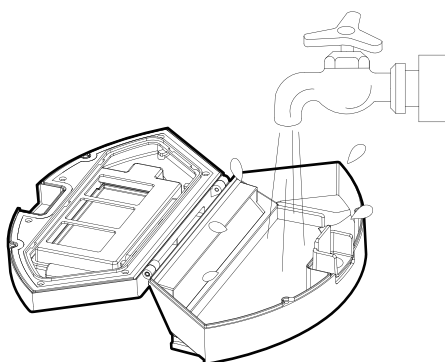

Wash the dust box and pre-filter.

## Product Maintenance

---

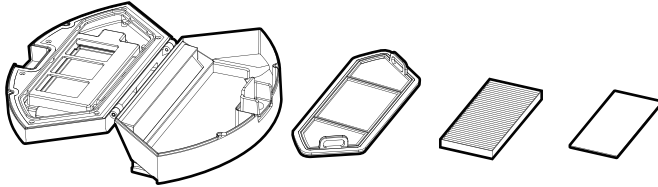

1. Dry the dust box and filter components. Keep them dry to ensure a longer service.
2. After the pre-filter is used for 15-30 days, it should be washed once.
3. The maximum service life of the high-efficient filter is 3 months.

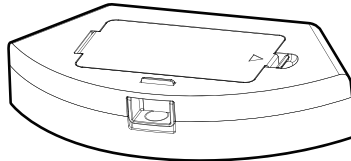

1. Reinstall the pre-filter and high-efficient filter in the dust box.
2. Before installing the filter, make sure that the high-efficient filter and the pre-filter are dry.
3. Do not expose the high-efficient filter and the pre-filter to sunlight.

## Product Maintenance

---

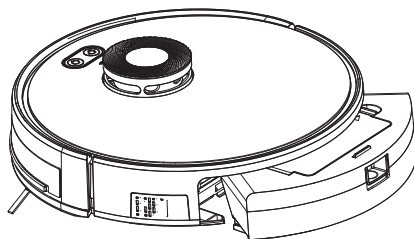

Cover the dust box and fix it into the main body.

### 5.3 Maintenance of Water Tank

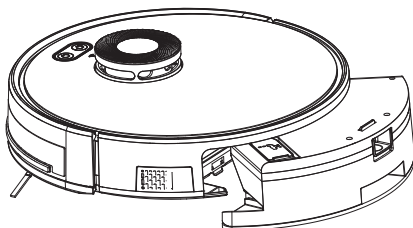

Press the release button to take out the water tank.



## Product Maintenance

---

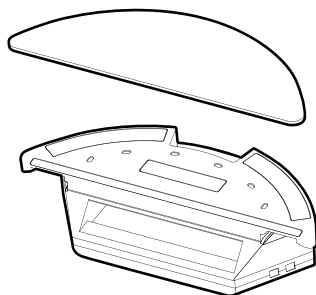

Remove the mop

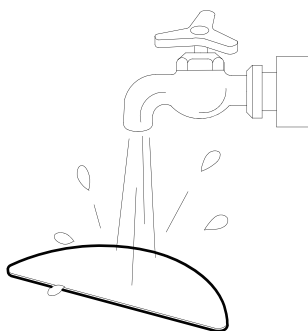

Wash and dry th

## Product Maintenance

---

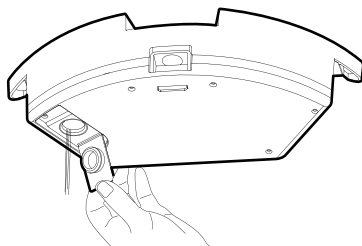

Pour out the rest of water from the water tank

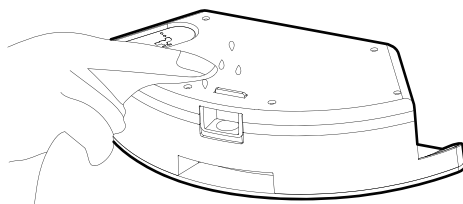

Clean the water tank and dry

# Product Maintenance

---

## 5.4 Maintenance of Rolling Brush Components

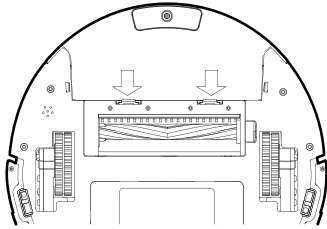

Open the rolling brush components

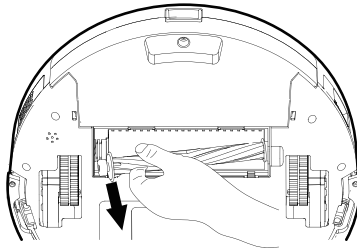

Remove the rolling brush and clean off all debris and hair.