

TEST REPORT

Product Name : Fitness watch
Model Number : SCMAX
FCC ID : 2AMX804

Prepared for : Behavioral Technology Group Inc.
Address : Pavlok 539 W. Commerce St. #3141, Dallas, TX 75208,
USA

Prepared by : EMTEK (NINGBO) CO., LTD.
Address : No. 8, Building 8, Lane 216, Qingyi Road, Ningbo Hi-Tech
Zone, Ningbo, Zhejiang, China

Tel: +86-574-27907998
Fax: +86-574-27721538

Report Number : ENB2311300253W00101R
Date(s) of Tests : November 30, 2023 to December 26, 2023
Date of Issue : December 28, 2023

Table of Contents

1	TEST RESULT CERTIFICATION	3
2	EUT TECHNICAL DESCRIPTION	4
3	SUMMARY OF TEST RESULT	5
4	TEST METHODOLOGY	6
4.1	GENERAL DESCRIPTION OF APPLIED STANDARDS.....	6
4.2	MEASUREMENT EQUIPMENT USED.....	6
4.3	DESCRIPTION OF TEST MODES	8
4.4	TEST SOFTWARE.....	8
5	FACILITIES AND ACCREDITATIONS	9
5.1	FACILITIES	9
5.2	LABORATORY ACCREDITATIONS AND LISTINGS	9
6	TEST SYSTEM UNCERTAINTY	10
7	SETUP OF EQUIPMENT UNDER TEST	11
7.1	RADIO FREQUENCY TEST SETUP 1	11
7.2	RADIO FREQUENCY TEST SETUP 2	11
7.3	CONDUCTED EMISSION TEST SETUP.....	13
7.4	BLOCK DIAGRAM CONFIGURATION OF TEST SYSTEM.....	14
7.5	SUPPORT EQUIPMENT	14
8	TEST REQUIREMENTS.....	15
8.1	DTS 6DB BANDWIDTH	15
8.2	MAXIMUM PEAK CONDUCTED OUTPUT POWER	18
8.3	MAXIMUM POWER SPECTRAL DENSITY	21
8.4	UNWANTED EMISSIONS IN NON-RESTRICTED FREQUENCY BANDS	24
8.5	RADIATED SPURIOUS EMISSION.....	29
8.6	CONDUCTED EMISSIONS TEST	41
8.7	ANTENNA APPLICATION.....	44

1 TEST RESULT CERTIFICATION

Applicant : Behavioral Technology Group Inc.
 Address : Pavlok 539 W. Commerce St. #3141, Dallas, TX 75208, USA
 Manufacturer : Makk Design Inc.
 Address : 152 William Street, Victoria Harbour, ON, L0K 2A0
 EUT : Fitness watch
 Model Name : SCMAX
 Trademark : Pavlok

Measurement Procedure Used:

APPLICABLE STANDARDS	
STANDARD	TEST RESULT
FCC 47 CFR Part 2 , Subpart J FCC 47 CFR Part 15, Subpart C	PASS

The above equipment was tested by EMTEK (NINGBO) CO., LTD. The test data, data evaluation, test procedures, and equipment configurations shown in this report were made in accordance with the procedures given in ANSI C63.10 (2013) and the energy emitted by the sample EUT tested as described in this report is in compliance with the requirements of FCC Rules Part 2 and Part 15.247

The test results of this report relate only to the tested sample identified in this report

Date of Test : November 30, 2023 to December 26, 2023

Prepared by : 
June Gao /Engineer

Reviewer : 
Vinay /Supervisor

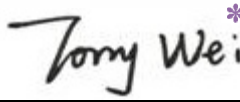
Approve & Authorized Signer : 
Tony wei/Manager



2 EUT TECHNICAL DESCRIPTION

Characteristics	Description
Product	Fitness watch
Model Number	SCMAX
Sample Number	ENB2311300253W001-1-1
Device Type	Bluetooth V5.2
Data Rate :	Up to 1 Mbps
Modulation:	GFSK
Operating Frequency Range:	2402-2480 MHz
Number of Channels:	40 Channels
Transmit Power Max:	0.92 dBm
Antenna Type:	Ceramic Antenna
Antenna Gain:	-2.72 dBi
Tset Voltage:	DC 3.7V for Battery
Temperature Range:	0°C to +40°C
Date of Received:	November 30, 2023

Note: for more details, please refer to the User's manual of the EUT.

3 SUMMARY OF TEST RESULT

FCC Part Clause	Test Parameter	Verdict	Remark
15.247(a)(2)	DTS (6dB) Bandwidth	PASS	
15.247(b)(3)	Maximum Peak Conducted Output Power	PASS	
15.247(e)	Maximum Power Spectral Density Level	PASS	
15.247(d)	Unwanted Emission Into Non-Restricted Frequency Bands	PASS	
15.247(d) 15.209	Unwanted Emission Into Restricted Frequency Bands (conducted)	PASS	
15.247(d) 15.209	Radiated Spurious Emission	PASS	
15.207	Conducted Emission Test	PASS	
15.247(b)	Antenna Application	PASS	
	NOTE1: N/A (Not Applicable) NOTE2: According to FCC OET KDB 558074, the report use radiated measurements in the restricted frequency bands. In addition, the radiated test is also performed to ensure the emissions emanating from the device cabinet also comply with the applicable limits.		

RELATED SUBMITTAL(S) / GRANT(S):

This submittal(s) (test report) is intended for FCC ID: 2AMX804 filing to comply with Section 15.247 of the FCC Part 15, Subpart C Rules.

4 TEST METHODOLOGY

4.1 GENERAL DESCRIPTION OF APPLIED STANDARDS

According to its specifications, the EUT must comply with the requirements of the following standards:

FCC 47 CFR Part 2, Subpart J

FCC 47 CFR Part 15, Subpart C

FCC KDB 558074 D01 15.247 Meas Guidance v05r02

4.2 MEASUREMENT EQUIPMENT USED

4.2.1 Conducted Emission Test Equipment

Equ.No.	Equipment	Manufacturer	Model No.	Serial No.	Last Cal.	Cal. Interval
ENE-002	EMI Test Receiver	R & S	ESCI	101107	July 06, 2023	1 Year
ENE-158	L.I.S.N	R & S	NNLK 8129	0373	Nov 17, 2023	1 Year
ENE-004	L.I.S.N	Schwarzbeck	NSLK 8126	8126-462	July 06, 2023	1 Year
ENE-162-1	RF Cable	TIMES	2M(N-N)	605236-0001	May 31, 2023	1 Year
ENE-070	Pulse Limiter	Schwarzbeck	VTSD 9561F-N	00525	Mar 15, 2023	1 Year
ENE-150	Conduction Test Room 2#	SKET	6.5*5*4m	/	Apr 17, 2023	3 Year

4.2.2 Radiated Emission Test Equipment

Equ. No.	Equipment	Manufacturer	Model No.	Serial No.	Last Cal.	Cal. Interval
ENE-185	EMI Test Receiver	R&S	ESR7	102480	May 18, 2023	1 Year
ENE-190	Antenna multiple	Schwarzbeck	VULB 9163	01499	May 27, 2022	2 Year
ENE-191	Horn antenna	Schwarzbeck	BBHA 9120 D	02588	May 21, 2023	2 Year
ENE-195	Pre-Amplifier	JS Denki	PA09K03-40	JSPA21019	May 27, 2023	1 Year
ENE-204	Low frequency notch filterRf switching	JS Denki	JSDSW-F	JSDSW2211D 02	May 27, 2023	1 Year
ENE-279	RF cable	Rosenberger	L17-C001-7000	/	June 01, 2023	1 Year
ENE-280	RF cable	Rosenberger	L17-C001-3500	/	June 01, 2023	1 Year
ENE-281	RF cable	Rosenberger	L08-C446-1500	/	June 01, 2023	1 Year
ENE-282-1	RF cable	Rosenberger	/	/	June 01, 2023	1 Year
ENE-282-2	RF cable	Rosenberger	/	/	June 01, 2023	1 Year

ENE-171	EXA Signal Analyzer	KEYSIGHT	N9010B	MY60242467	Feb. 28, 2023	1 Year
ENE-198	Pre-amplifier	JS Denki	PA0118-50	JSPA21022	April 28, 2023	1 Year
ENE-193	Horn antenna	Schwarzbeck	BBHA 9170	01190	May 21, 2022	2 Year
ENE-199	Pre-amplifier	JS Denki	PA1840-55	JSPA21023	April 28, 2023	1 Year
ENE-281-1	RF cable	Rosenberger	LA2-C125-3500	/	June 01, 2023	1 Year
ENE-281-2	RF cable	Rosenberger	LA2-C125-1500	/	June 01, 2023	1 Year
ENE-281-3	RF cable	Rosenberger	LU7-C1511-1200	/	June 01, 2023	1 Year
ENE-285-1	RF cable	Rosenberger	LA2-C199-6500	/	June 01, 2023	1 Year
ENE-290-1	RF cable	Schwarzbeck	LA1-C006-4000	/	June 01, 2023	1 Year
ENE-206	High frequency notch filterRf switching	JS Denki	JSDSW-F	202083582	April 28, 2023	1 Year

4.2.3 Radio Frequency Test Equipment

Equ. No.	Equipment	Manufacturer	Model No.	Serial No.	Last Cal.	Cal. Interval
ENE-256	EXA Signal Analyzer	Keysight	N9010B	MY62060219	July 05, 2023	1 Year
ENE-172	RF Control Unit	Tonscend	JS0806-2(V.6E)	21L8060521	March 01, 2023	1 Year
ENE-092	DC Power Supply	KEFUNA	KDP3603	2004D3062946	July 07, 2023	1 Year

4.3 DESCRIPTION OF TEST MODES

The EUT has been tested under its typical operating condition.

The EUT configuration for testing is installed on RF field strength measurement to meet the Commissions requirement and operating in a manner which intends to maximize its emission characteristics in a continuous normal application.

The Transmitter was operated in the normal operating mode. The TX frequency was fixed which was for the purpose of the measurements.

Test of channel included the lowest and middle and highest frequency to perform the test, then record on this report.

Those data rates (Bluetooth V5.2 DTS :1 Mbps) were used for all test.

Pre-defined engineering program for regulatory testing used to control the EUT for staying in continuous transmitting and receiving mode is programmed.

Frequency and Channel list for Bluetooth V5.2 DTS:

Channel	Frequency (MHz)	Channel	Frequency (MHz)	Channel	Frequency (MHz)
0	2402	19	2440
1	2404	20	2442	37	2476
2	2406	21	2444	38	2478
...	39	2480

Note: $f_c = 2402\text{MHz} + k \times 2\text{MHz}$ $k = 1$ to 39

Test Frequency and channel for Bluetooth V5.2 DTS:

Lowest Frequency		Middle Frequency		Highest Frequency	
Channel	Frequency (MHz)	Channel	Frequency (MHz)	Channel	Frequency (MHz)
0	2402	19	2440	39	2480

4.4 TEST SOFTWARE

Item	Software
Radiated Emission:	FCC TEST(V0.8.30)
Conducted Emission	FCC TEST(V0.8.30)

5 FACILITIES AND ACCREDITATIONS

5.1 FACILITIES

All measurement facilities used to collect the measurement data are located at

No. 8, Building 8, Lane 216, Qingyi Road, Ningbo Hi-Tech Zone, Ningbo, Zhejiang, China

The sites are constructed in conformance with the requirements of ANSI C63.7, ANSI C63.10 and CISPR Publication 32.

5.2 LABORATORY ACCREDITATIONS AND LISTINGS

Site Description

EMC Lab.

: **Accredited by CNAS**

The Certificate Registration Number is L6666.

The Laboratory has been assessed and proved to be in compliance with CNAS-CL01:2018 (identical to ISO/IEC 17025:2017)

Designation by FCC

Designation Number: CN1354

Test Firm Registration Number: 427606

Accredited by A2LA

The certificate is valid until August 4, 2023

Accredited by Industry Canada

The Conformity Assessment Body Identifier is CN0114

Test Firm Registration Number: 9469A

Name of Firm

: EMTEK (NINGBO) CO., LTD.

Site Location

: No. 8, Building 8, Lane 216, Qingyi Road, Ningbo Hi-Tech Zone, Ningbo, Zhejiang, China

6 TEST SYSTEM UNCERTAINTY

The following measurement uncertainty levels have been estimated for tests performed on the apparatus:

Parameter	Uncertainty
Radio Frequency	$\pm 1 \times 10^{-5}$ MHz
Uncertainty for Output power test	± 0.83 dB
Conducted Emissions Test	± 2.0 dB
Radiated Emission Test	± 2.0 dB
Occupied Bandwidth Test	± 1.0 dB
Power density test	± 1.85 dB
All emission, radiated	± 3 dB
Antenna Port Emission	± 3 dB
Temperature	$\pm 0.5^{\circ}\text{C}$
Humidity	$\pm 3\%$

Measurement Uncertainty for a level of Confidence of 95%



7 SETUP OF EQUIPMENT UNDER TEST

7.1 RADIO FREQUENCY TEST SETUP 1

The Bluetooth V5.2 DTS component's antenna ports(s) of the EUT are connected to the measurement instrument per an appropriate attenuator. The EUT is controlled by PC/software to emit the specified signals for the purpose of measurements.

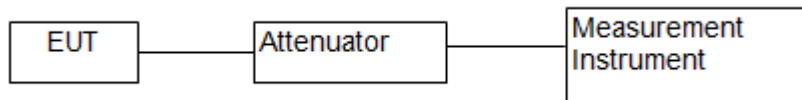

7.2 RADIO FREQUENCY TEST SETUP 2

The test site semi-anechoic chamber has met the requirement of NSA tolerance 4 dB according to the standards: ANSI C63.10. The test distance is 3m. The setup is according to the requirements in Section 13.1.4.1 of ANSI C63.10-2013 and CAN/CSA-CEI/IEC CISPR 22.

Below 30MHz:

The EUT is placed on a turntable 0.8 meters above the ground in the chamber, 3 meter away from the antenna (loop antenna). The Antenna should be positioned with its plane vertical at the specified distance from the EUT and rotated about its vertical axis for maximum response at each azimuth about the EUT. The center of the loop shall be 1 m above the ground. For certain applications, the loop antenna plane may also need to be positioned horizontally at the specified distance from the EUT.

30MHz-1GHz:

The EUT is placed on a turntable 0.8 meters above the ground in the chamber, 3 meter away from the antenna. The maximal emission value is acquired by adjusting the antenna height, polarisation and turntable azimuth. Normally, the height range of antenna is 1 m to 4 m, the azimuth range of turntable is 0° to 360°, and the receive antenna has two polarizations Vertical (V) and Horizontal (H).

Above 1GHz:

The EUT is placed on a turntable 1.5 meters above the ground in the chamber, 3 meter away from the antenna. The maximal emission value is acquired by adjusting the antenna height, polarisation and turntable azimuth. Normally, the height range of antenna is 1 m to 4 m, the azimuth range of turntable is 0° to 360°, and the receive antenna has two polarizations Vertical (V) and Horizontal (H).

(a) Radiated Emission Test Set-Up, Frequency Below 30MHz

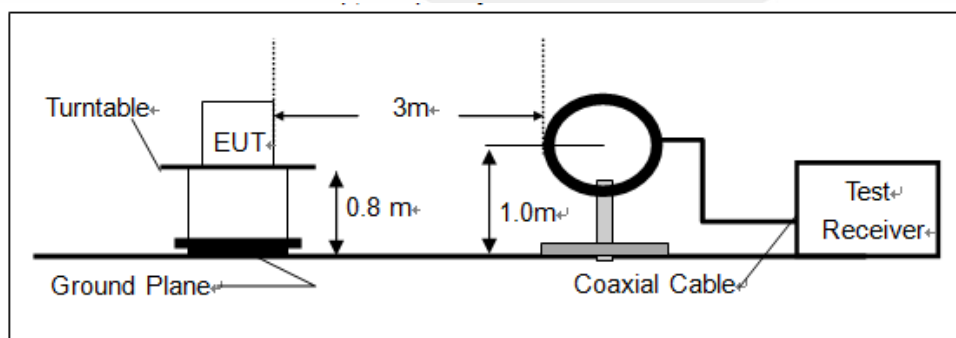

(b) Radiated Emission Test Set-Up, Frequency Below 1000MHz

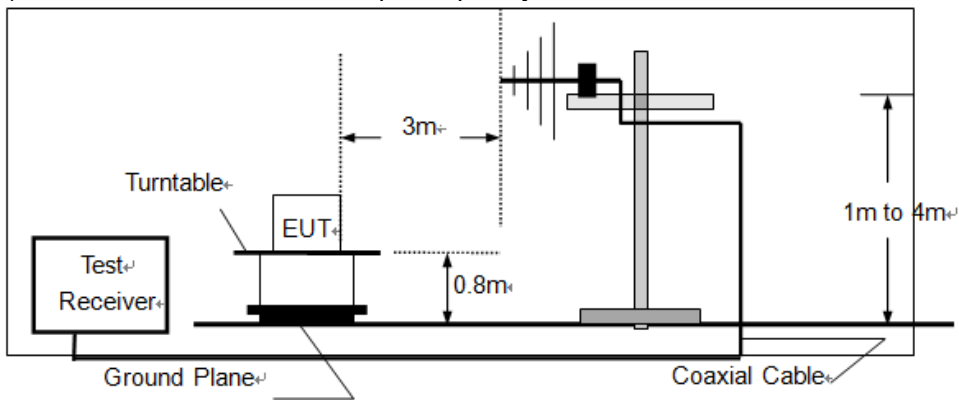

(c) Radiated Emission Test Set-Up, Frequency above 1000MHz

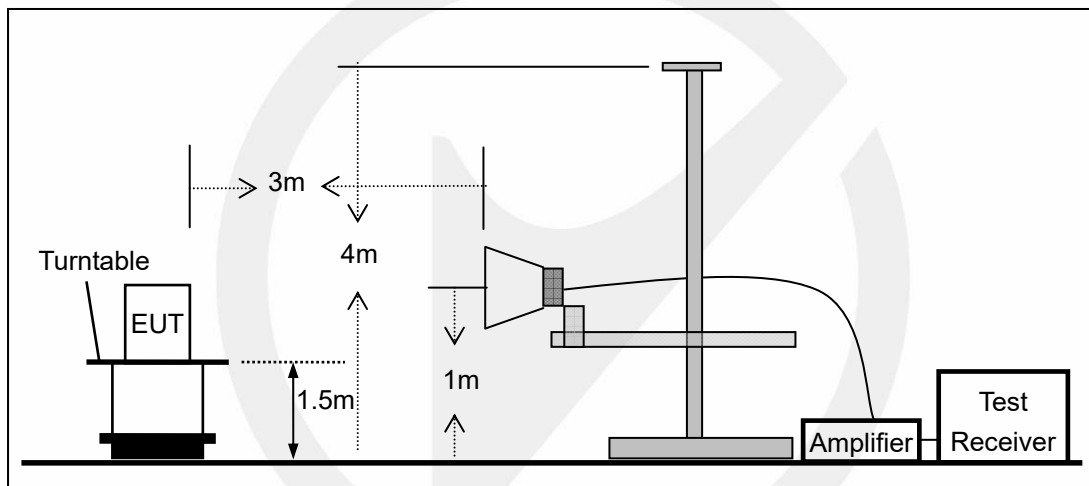

7.3 CONDUCTED EMISSION TEST SETUP

The mains cable of the EUT (maybe per AC/DC Adapter) must be connected to LISN. The LISN shall be placed 0.8 m from the boundary of EUT and bonded to a ground reference plane for LISN mounted on top of the ground reference plane. This distance is between the closest points of the LISN and the EUT. All other units of the EUT and associated equipment shall be at least 0.8m from the LISN.

Ground connections, where required for safety purposes, shall be connected to the reference ground point of the LISN and, where not otherwise provided or specified by the manufacturer, shall be of same length as the mains cable and run parallel to the mains connection at a separation distance of not more than 0.1 m.

According to the requirements in Section 13.1.4.1 of ANSI C63.10-2013 Conducted emissions from the EUT measured in the frequency range between 0.15 MHz and 30 MHz using CISPR Quasi-Peak and average detector mode.

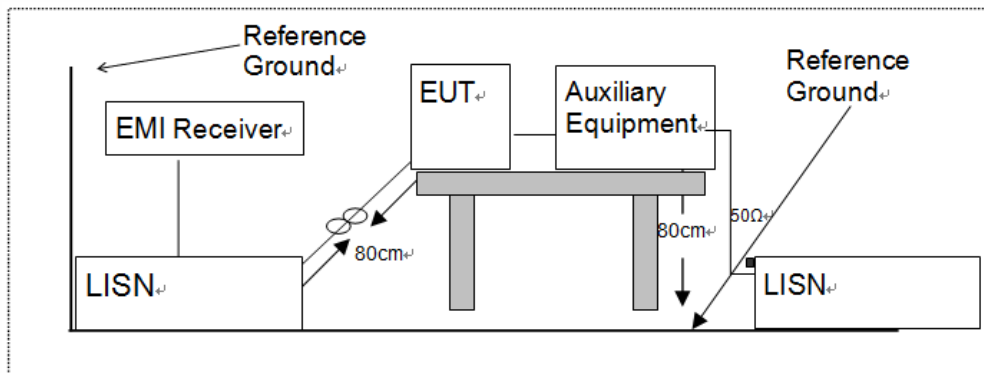

7.4 BLOCK DIAGRAM CONFIGURATION OF TEST SYSTEM

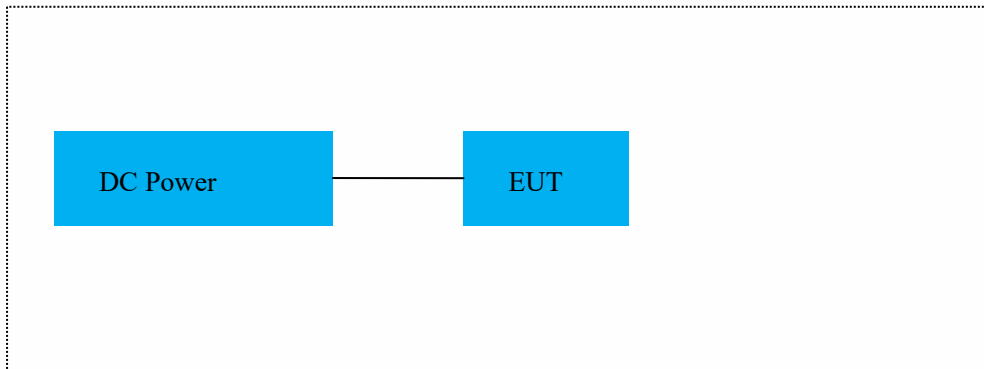

7.5 SUPPORT EQUIPMENT

EUT Cable List and Details			
Cable Description	Length (m)	Shielded/Unshielded	With / Without Ferrite
/	/	/	/

Auxiliary Cable List and Details			
Cable Description	Length (m)	Shielded/Unshielded	With / Without Ferrite
/	/	/	/

Auxiliary Equipment List and Details			
Description	Manufacturer	Model	Serial Number
/	/	/	/

Notes:

1. All the equipment/cables were placed in the worst-case configuration to maximize the emission during the test.
2. Grounding was established in accordance with the manufacturer's requirements and conditions for the intended use.

8 TEST REQUIREMENTS

8.1 DTS 6DB BANDWIDTH

8.1.1 Applicable Standard

According to FCC Part 15.247(a)(2) and KDB 558074 D01 15.247 Meas Guidance v05r02

8.1.2 Conformance Limit

The minimum -6 dB bandwidth shall be at least 500 kHz.

8.1.3 Test Configuration

Test according to clause 7.1 radio frequency test setup 1

8.1.4 Test Procedure

The EUT was operating in Bluetooth V5.2 DTS mode and controlled its channel. Printed out the test result from the spectrum by hard copy function.

The RF output of EUT was connected to the spectrum analyzer by RF cable and attenuator. The path loss was compensated to the results for each measurement.

Set to the maximum power setting and enable the EUT transmit continuously

Set RBW = 100 kHz.

Set the video bandwidth (VBW) =300 kHz.

Set Span=2 times OBW

Set Detector = Peak.

Set Trace mode = max hold.

Set Sweep = auto couple.

Allow the trace to stabilize.

Measure the maximum width of the emission that is constrained by the frequencies associated with the two outermost amplitude points (upper and lower frequencies) that are attenuated by 6 dB relative to the maximum level measured in the fundamental emission.

Measure and record the results in the test report.

Test Results

Temperature:	21° C
Relative Humidity:	47%
ATM Pressure:	1011 mbar

Operation Mode	Channel Number	Channel Frequency (MHz)	Measurement Bandwidth (kHz)	Limit (kHz)	Verdict
BLE 1M	0	2402	740.8	>500	PASS
	19	2440	742.1	>500	PASS
	39	2480	753.3	>500	PASS

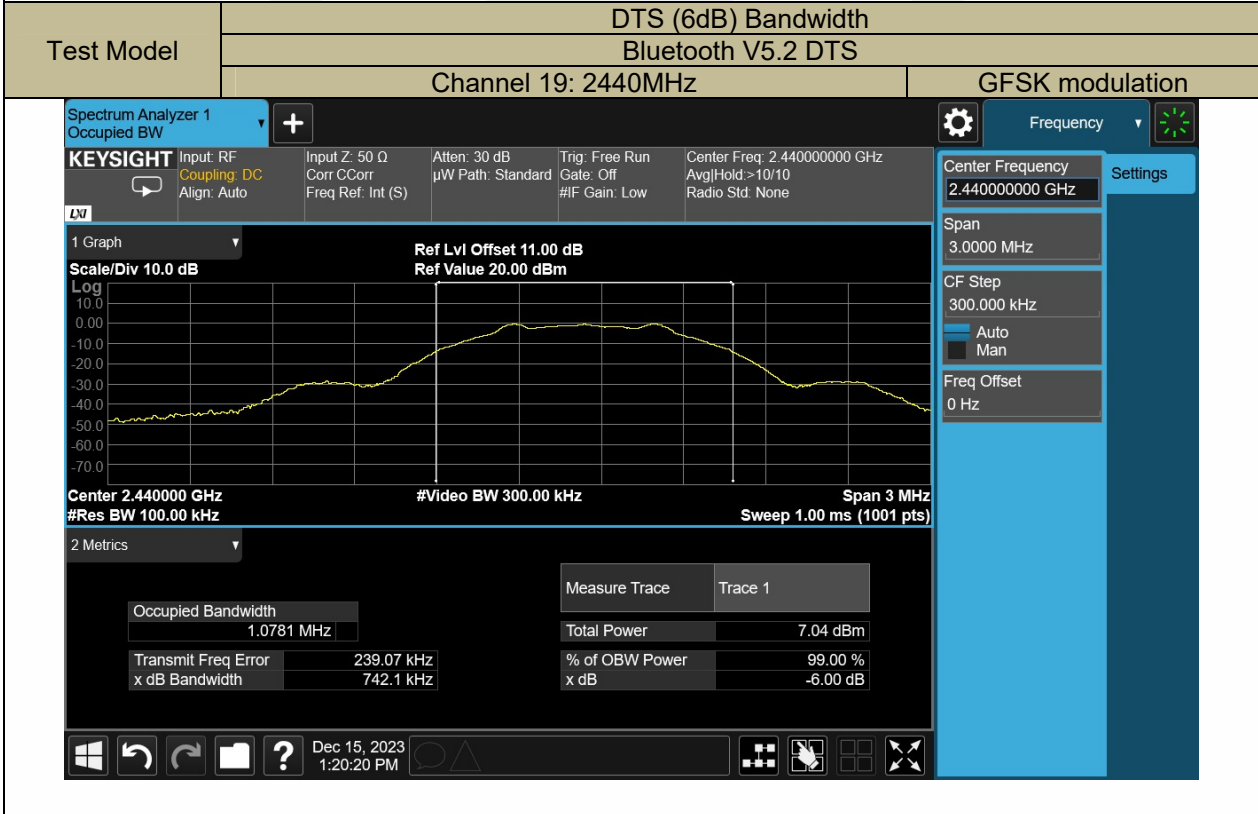
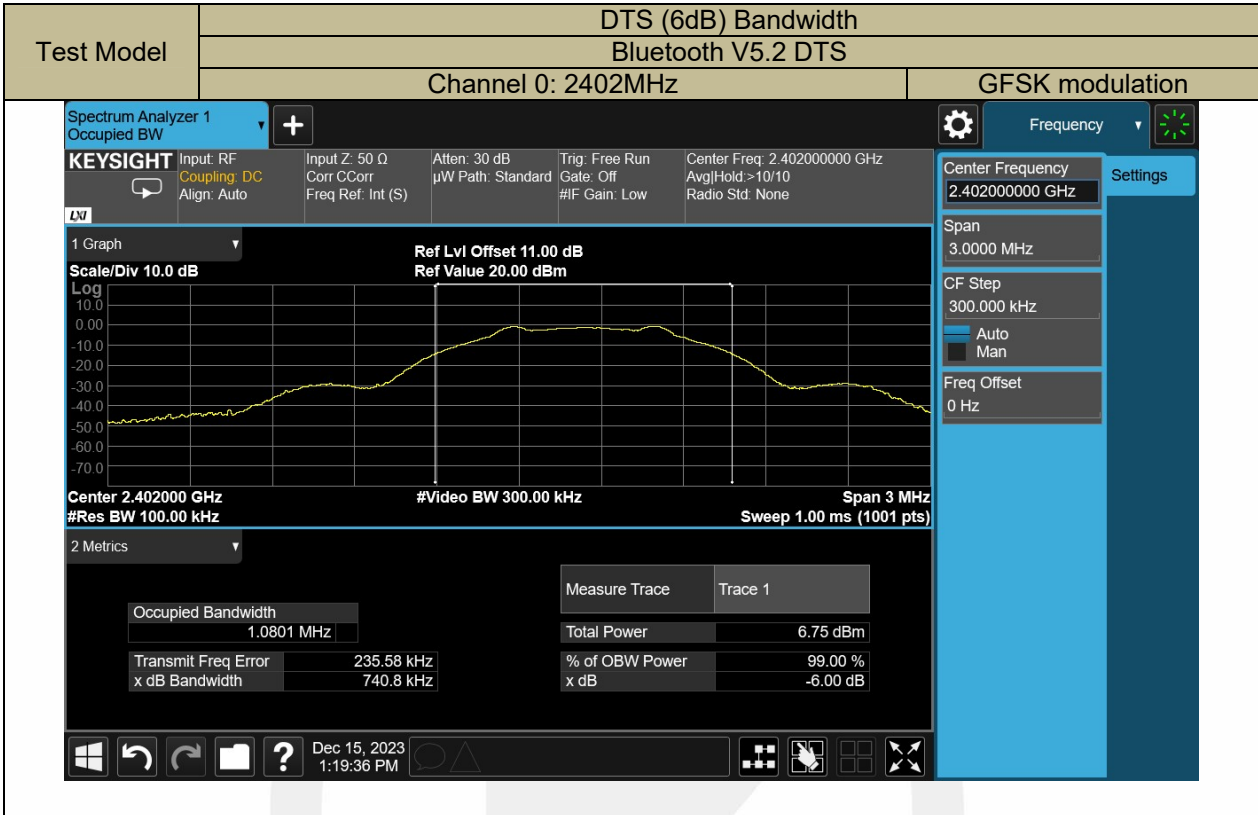

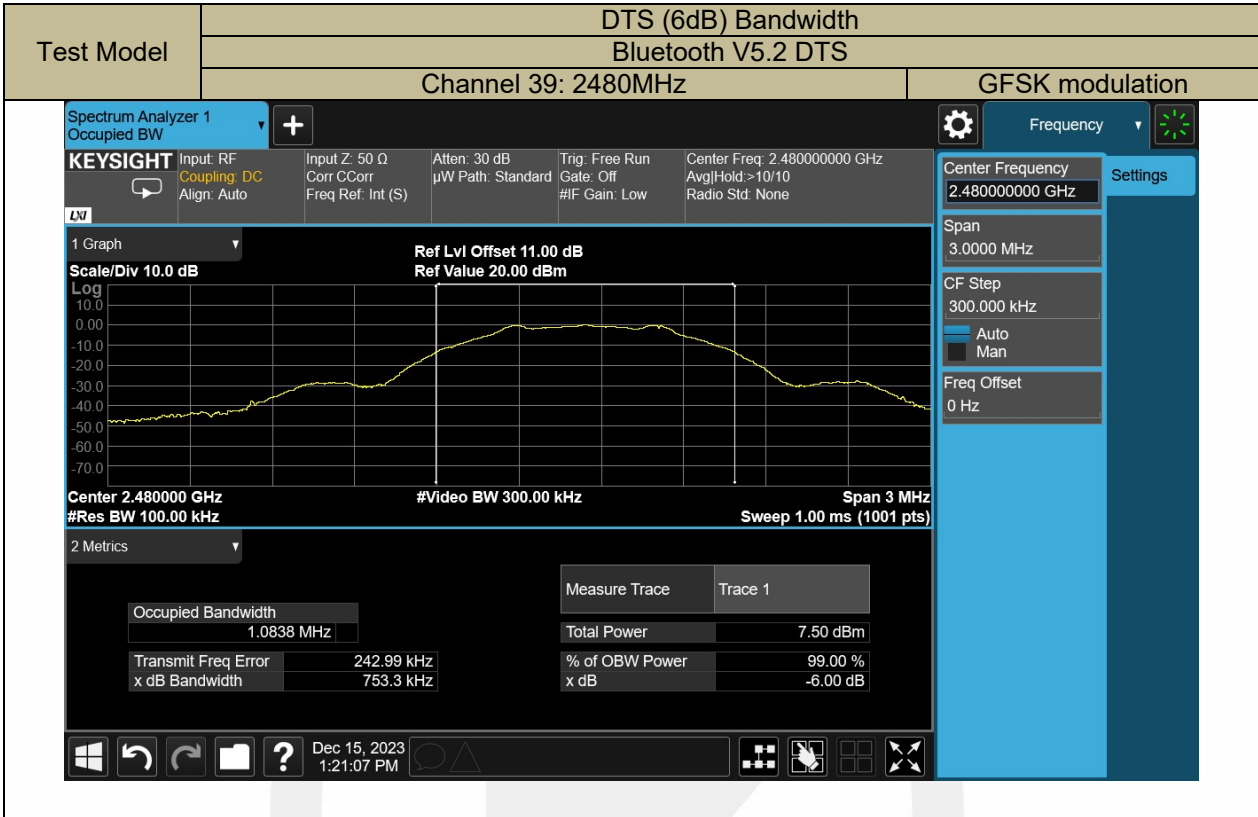

8.2 MAXIMUM PEAK CONDUCTED OUTPUT POWER

8.2.1 Applicable Standard

According to FCC Part 15.247(b)(3) and KDB 558074 D01 15.247 Meas Guidance v05r02

8.2.2 Conformance Limit

The maximum peak conducted output power of the intentional radiator for systems using digital modulation in the 2400 - 2483.5 MHz bands shall not exceed: 1 Watt (30dBm).

8.2.3 Test Configuration

Test according to clause 7.1 radio frequency test setup 1

8.2.4 Test Procedure

■ According to FCC Part 15.247(b)(3)

As an alternative to a peak power measurement, compliance with the one Watt limit can be based on a measurement of the maximum power conducted output power. For smart system, Maximum Conducted Output Power is defined as the total transmit power delivered to all antennas and antenna elements averaged across all symbols in the signaling alphabet when the transmitter is operating at its maximum power control level. Power must be summed across all antennas and antenna elements. If multiple modes of operation are possible (e.g., alternative modulation methods), the maximum conducted output power is the highest total transmit power occurring in any mode.

Set the RBW \cong DTS bandwidth (about 1MHz).

Set VBW = 3*RBW (about 3MHz)

Set the span \cong 3*RBW

Set Sweep time = auto couple.

Set Detector = peak.

Set Trace mode = max hold.

Allow trace to fully stabilize. Use peak marker function to determine the peak amplitude level.

■ According to FCC Part 15.247(b)(4):

Conducted output power limit specified in paragraph (b) of this section is based on the use of antennas with directional gains that do not exceed 6 dBi. If transmitting antennas of directional gain greater than 6 dBi are used, the conducted output power from the intentional radiator shall be reduced below the stated values in paragraphs (b)(3) of this section, as appropriate, by the amount in dB that the directional gain of the antenna exceeds 6 dBi.

Test Results

Temperature:	21° C
Relative Humidity:	47%
ATM Pressure:	1011 mbar

Operation Mode	Channel Number	Channel Frequency (MHz)	Measurement Level (dBm)	Limit (dBm)	Verdict
BLE 1M	0	2402	0.14	30	PASS
	19	2440	0.38	30	PASS
	39	2480	0.92	30	PASS

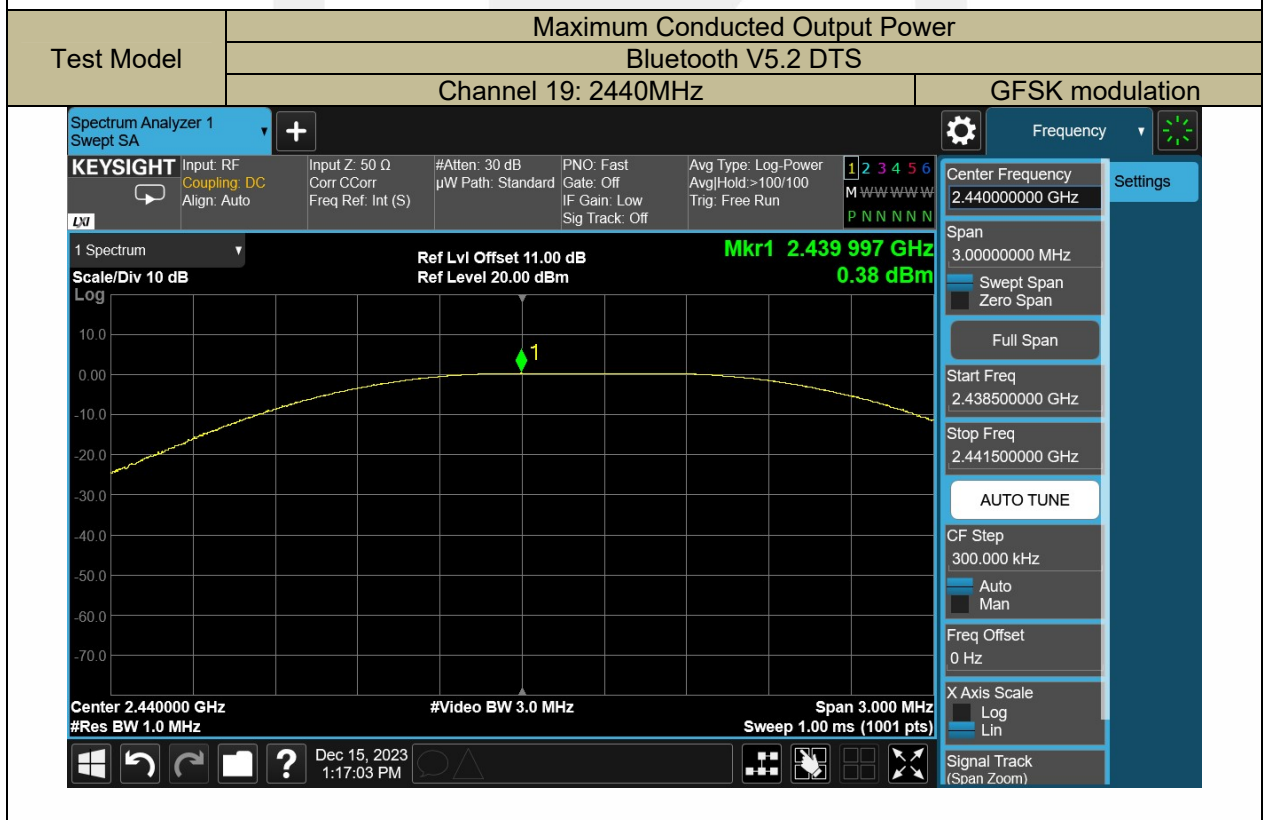
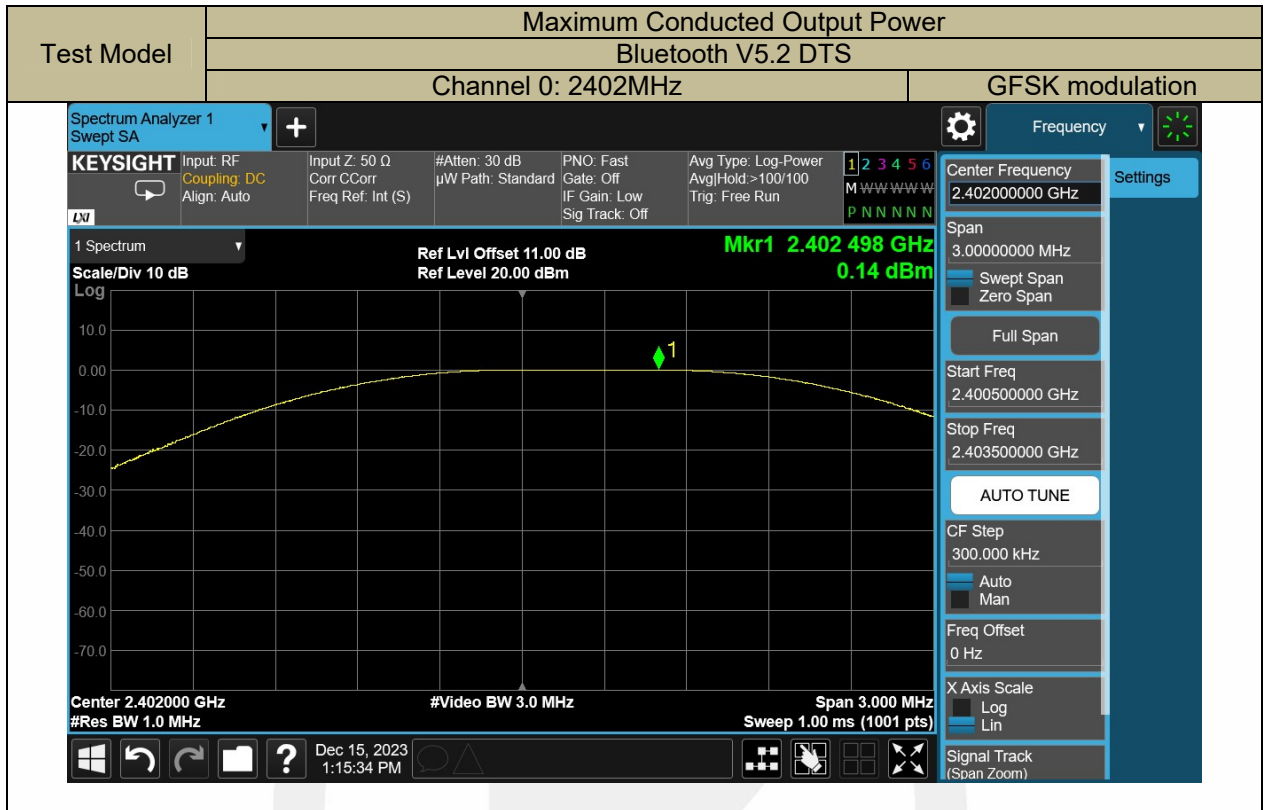

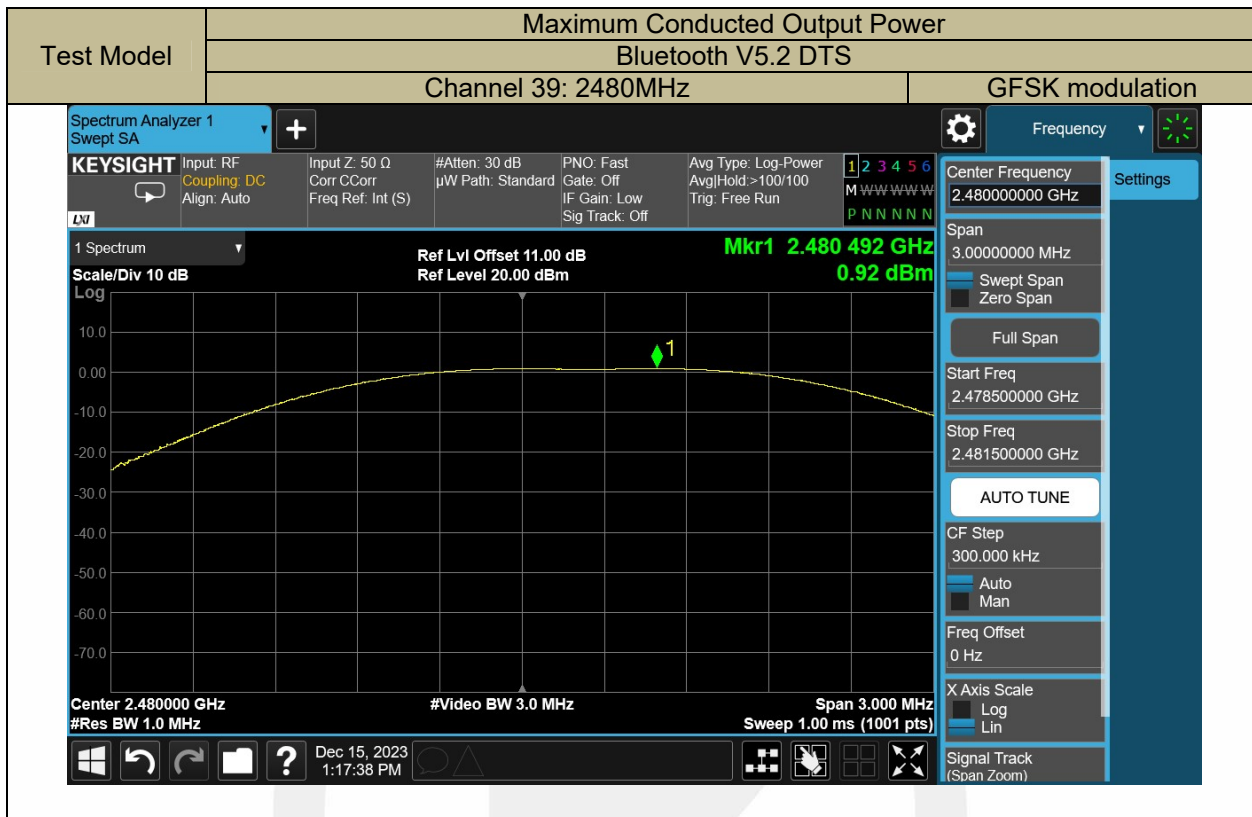

8.3 MAXIMUM POWER SPECTRAL DENSITY

8.3.1 Applicable Standard

According to FCC Part 15.247(e) and KDB 558074 D01 15.247 Meas Guidance v05r02

8.3.2 Conformance Limit

The transmitter power spectral density conducted from the transmitter to the antenna shall not be greater than 8 dBm in any 3 kHz band during any time interval of continuous transmission.

8.3.3 Test Configuration

Test according to clause 7.1 radio frequency test setup 1

8.3.4 Test Procedure

This procedure shall be used if maximum peak conducted output power was used to demonstrate compliance

The transmitter output (antenna port) was connected to the spectrum analyzer

Set analyzer center frequency to DTS channel center frequency.

Set the span to 1.5 times the DTS bandwidth.

Set the RBW to: 3 kHz

Set the VBW to: 10 kHz.

Set Detector = peak.

Set Sweep time = auto couple.

Set Trace mode = max hold.

Allow trace to fully stabilize.

Use the peak marker function to determine the maximum amplitude level within the RBW.

8.3.5 Test Results

Temperature:	21° C
Relative Humidity:	47%
ATM Pressure:	1011 mbar

Operation Mode	Channel Number	Channel Frequency (MHz)	Measurement Level (dBm/3kHz)	Limit (dBm/3kHz)	Verdict
BLE 1M	0	2402	-14.96	<8	PASS
	19	2440	-14.35	<8	PASS
	39	2480	-14.98	<8	PASS
Note: N/A					

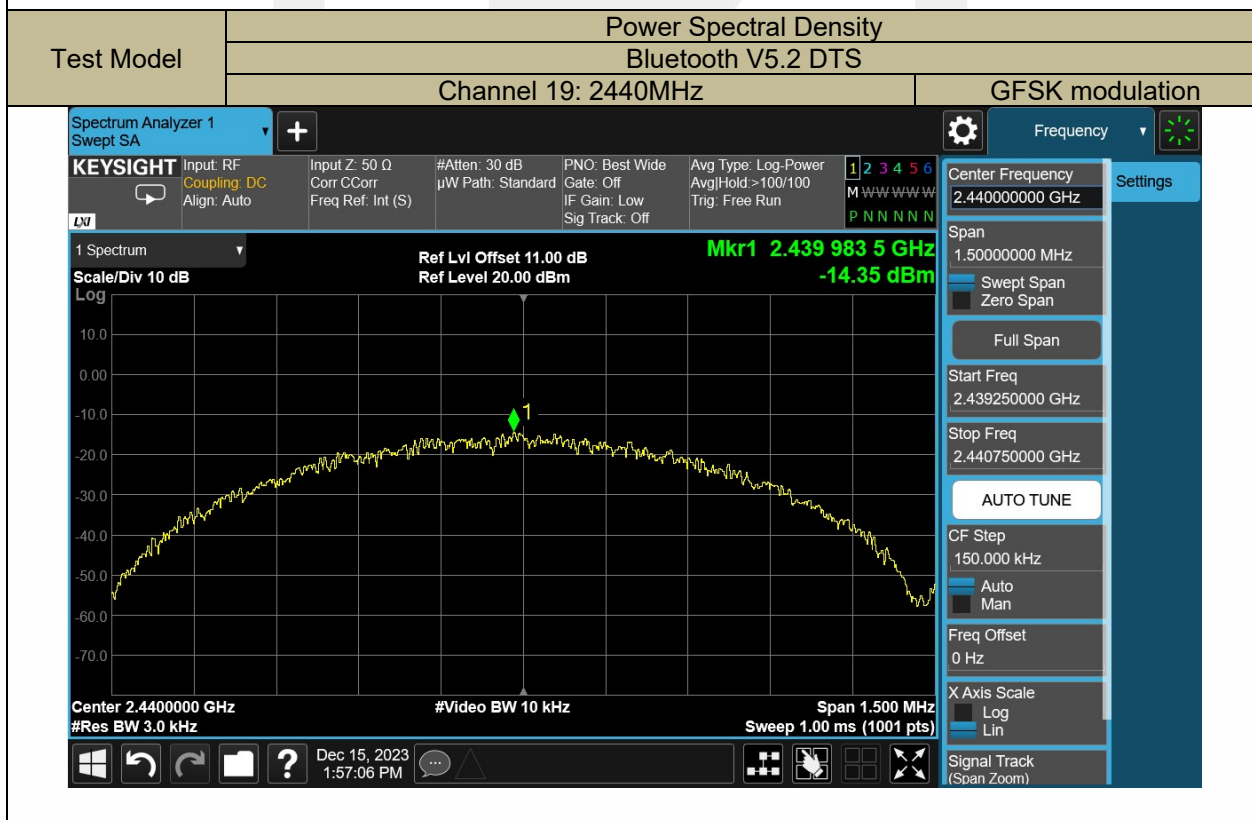
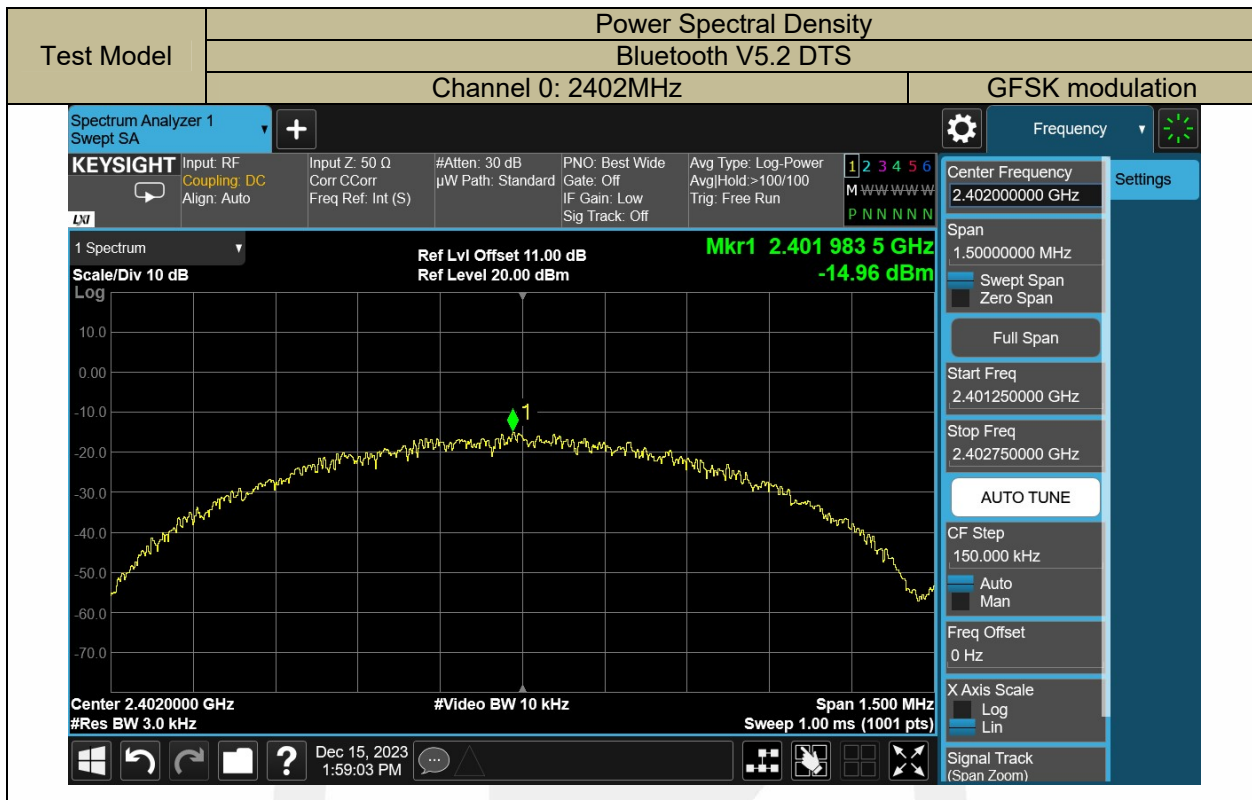

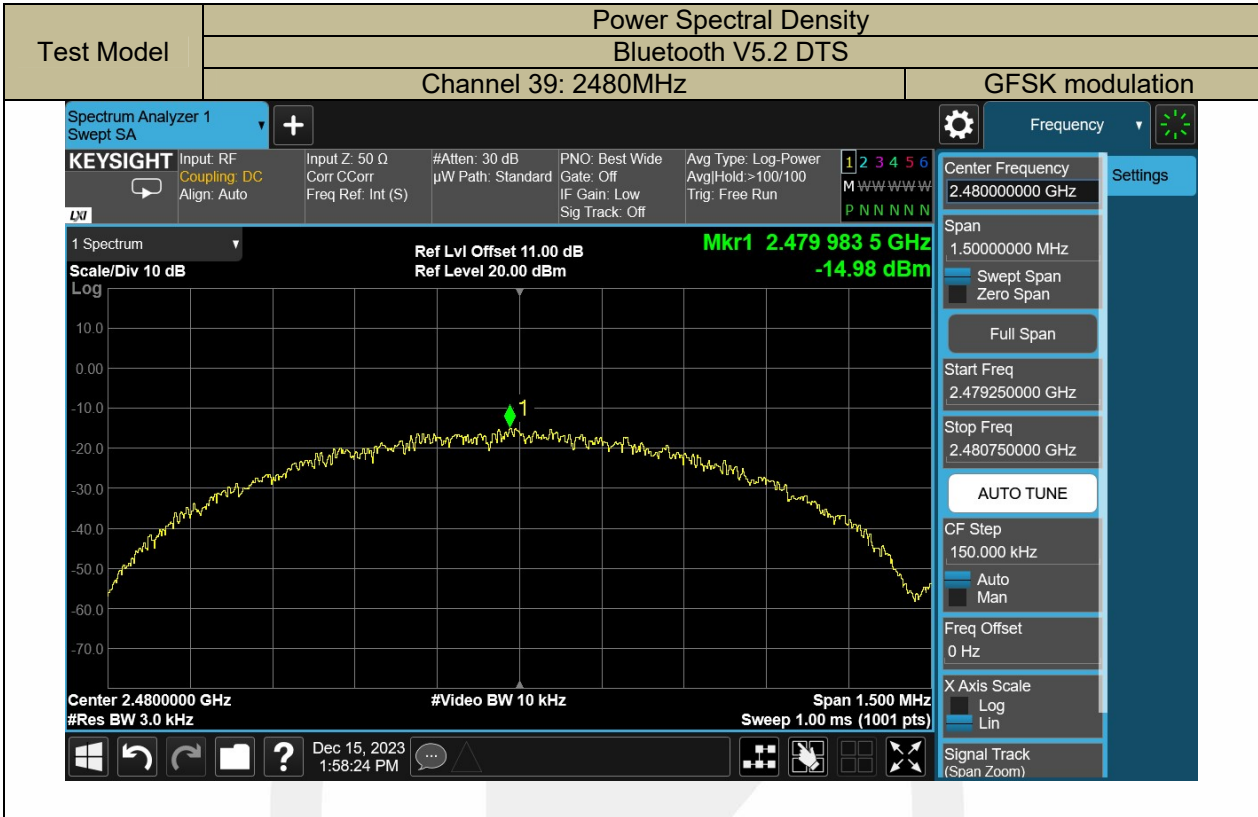

8.4 UNWANTED EMISSIONS IN NON-RESTRICTED FREQUENCY BANDS

8.4.1 Applicable Standard

According to FCC Part 15.247(d) and KDB 558074 D01 15.247 Meas Guidance v05r02

8.4.2 Conformance Limit

According to FCC Part 15.247(d):

In any 100 kHz bandwidth outside the frequency band in which the spread spectrum or digitally modulated intentional radiator is operating, the radio frequency power that is produced by the intentional radiator shall be at least 20 dB below that in the 100 kHz bandwidth within the band that contains the highest level of the desired power, based on either an RF conducted or a radiated measurement, provided the transmitter demonstrates compliance with the peak conducted power limits. If the transmitter complies with the conducted power limits based on the use of RMS averaging over a time interval, as permitted under paragraph (b)(3) of this section, the attenuation required under this paragraph shall be 30 dB instead of 20 dB.

8.4.3 Test Configuration

Test according to clause 7.1 radio frequency test setup 1

8.4.4 Test Procedure

The transmitter output (antenna port) was connected to the spectrum analyzer

■ Reference level measurement

Establish a reference level by using the following procedure:

Set instrument center frequency to DTS channel center frequency.

Set the span to = 1.5 times the DTS bandwidth.

Set the RBW = 100 kHz.

Set the VBW $\geq 3 \times$ RBW.

Set Detector = peak.

Set Sweep time = auto couple.

Set Trace mode = max hold.

Allow trace to fully stabilize.

Use the peak marker function to determine the maximum PSD level.

Note that the channel found to contain the maximum PSD level can be used to establish the reference level.

■ Emission level measurement

Set the center frequency and span to encompass frequency range to be measured.

Set the RBW = 100 kHz.

Set the VBW = 300 kHz.

Set Detector = peak

Sweep time = auto couple.

Trace mode = max hold.

Allow trace to fully stabilize.

Use the peak marker function to determine the maximum amplitude level.

Ensure that the amplitude of all unwanted emissions outside of the authorized frequency band (excluding restricted frequency bands) are attenuated by at least the minimum requirements. Report the three highest emissions relative to the limit.

8.4.5 Test Results

Temperature:	21° C
Relative Humidity:	47%
ATM Pressure:	1011 mbar

Bluetooth V5.2 DTS mode have been tested, and the worst result was report as below:

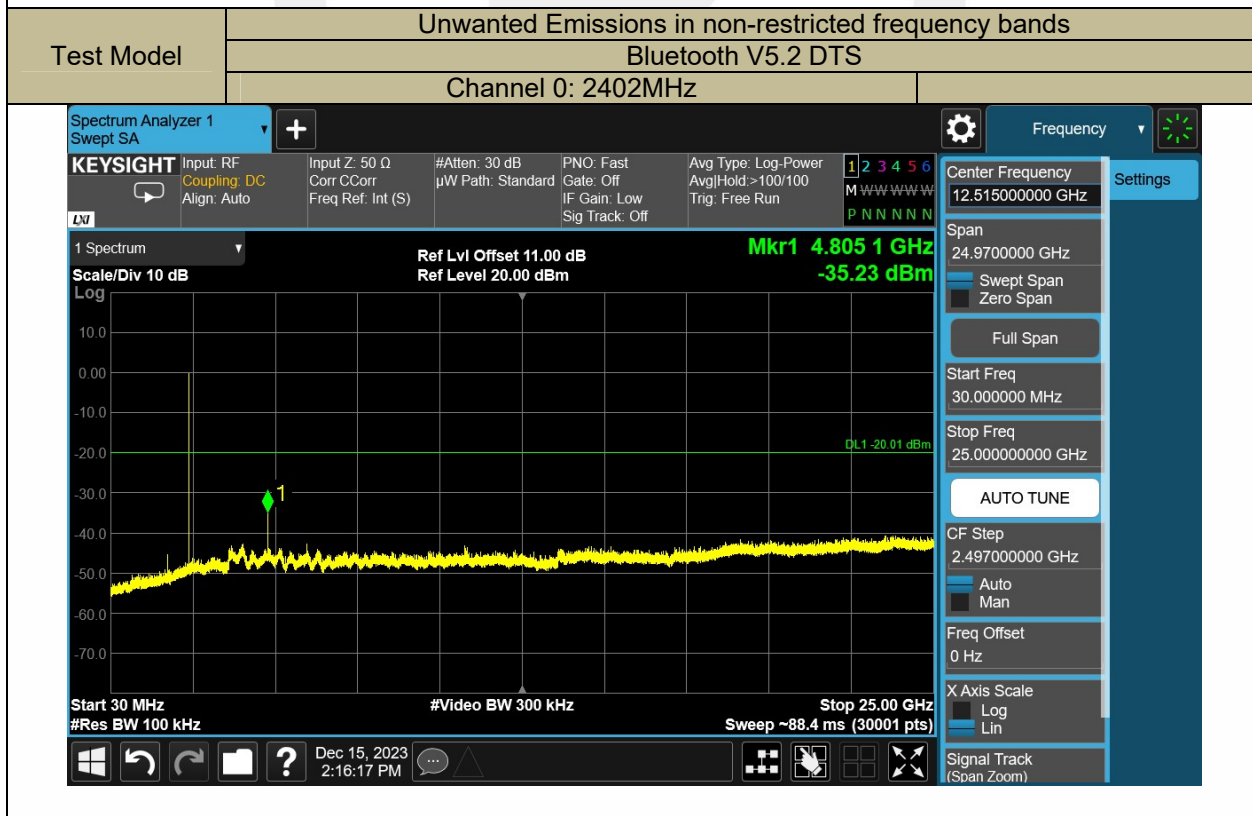
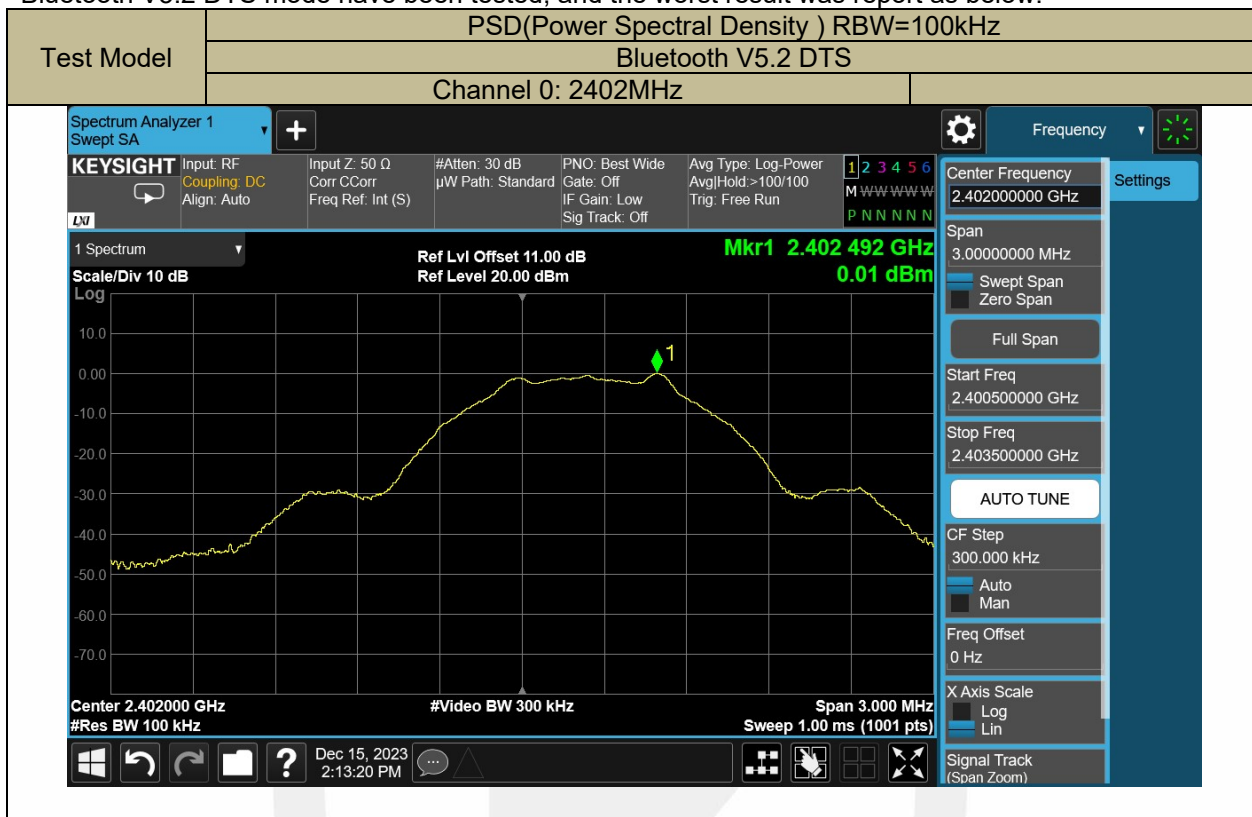

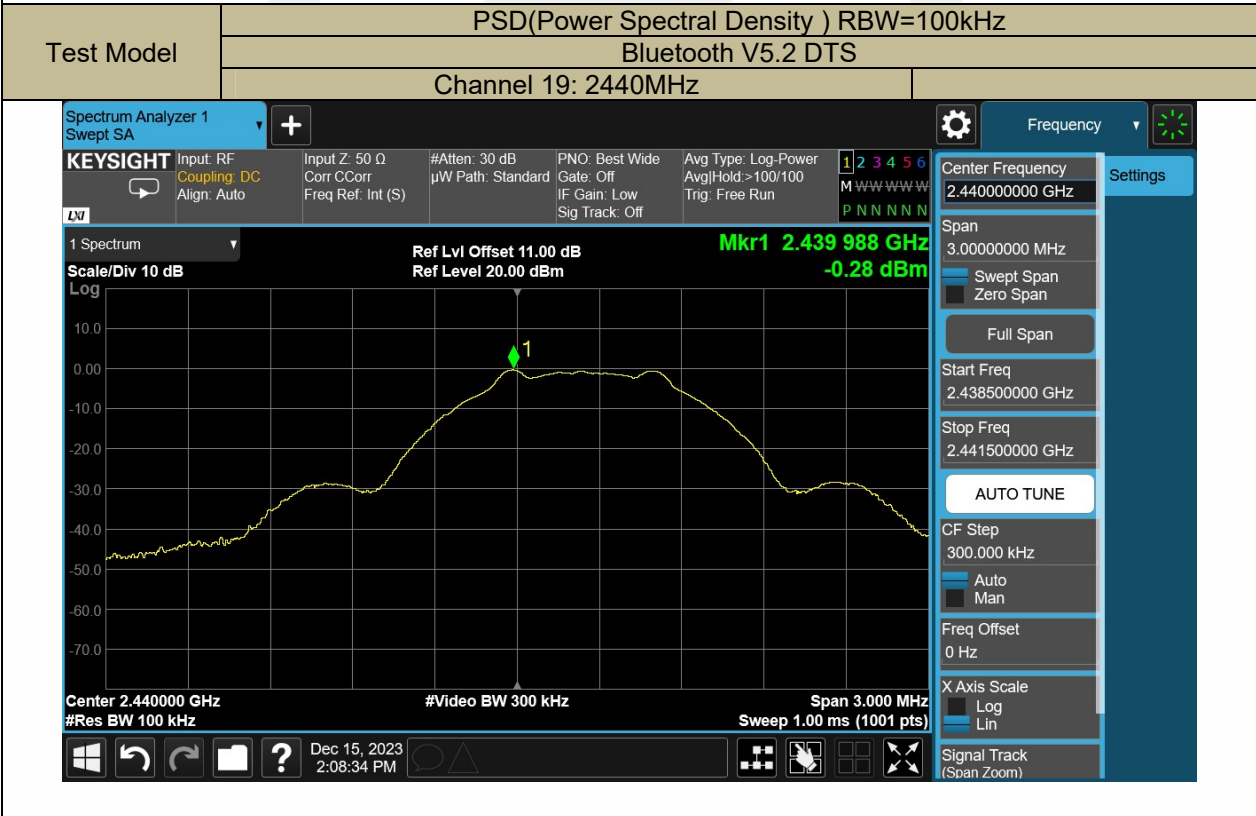
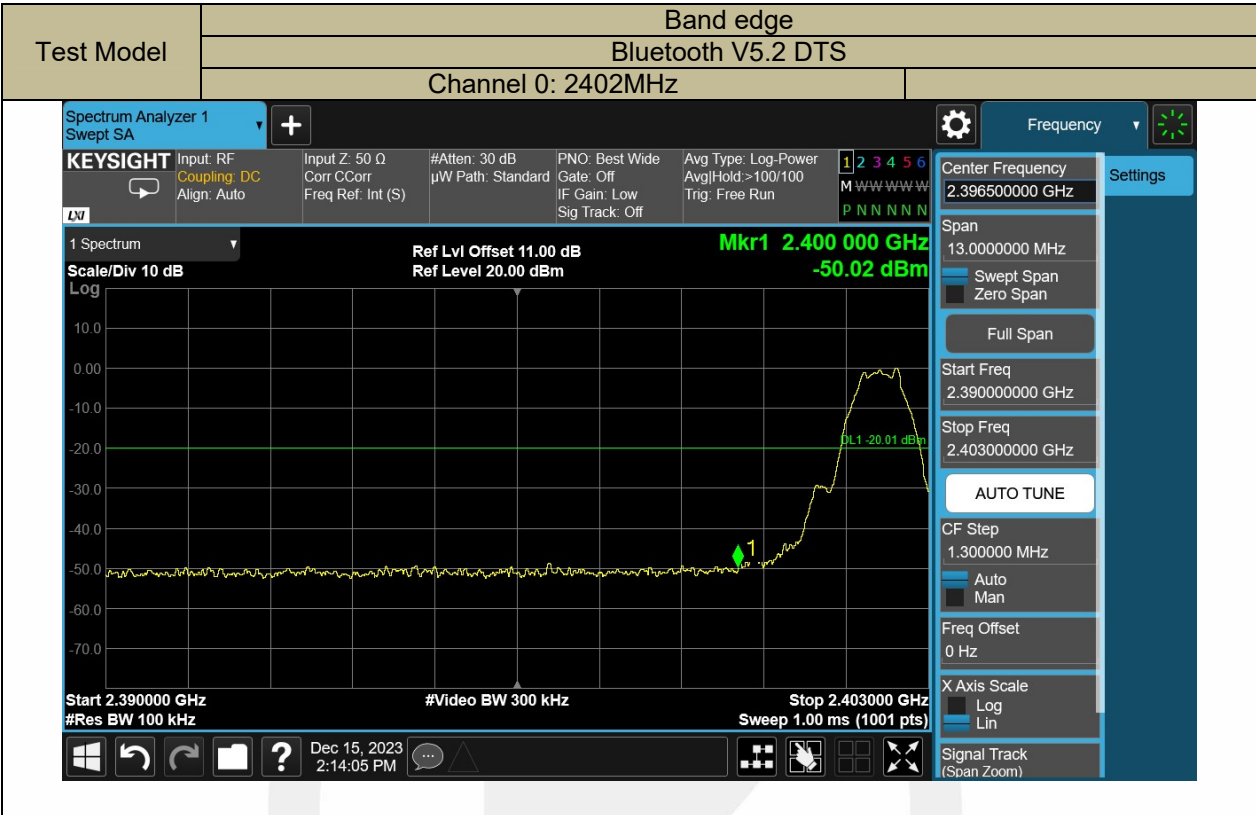

Test Model **Unwanted Emissions In Non-Restricted Frequency Bands**
Bluetooth V5.2 DTS
Channel 19: 2440MHz

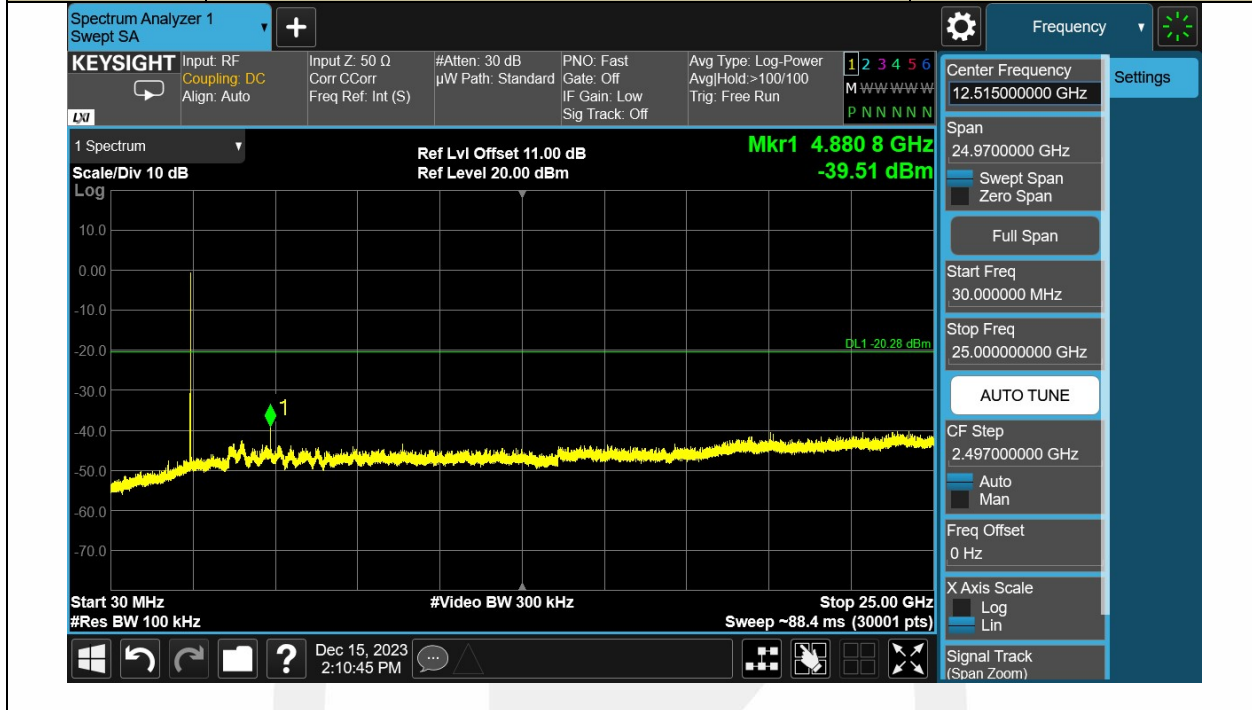

Test Model **PSD(Power Spectral Density) RBW=100kHz**
Bluetooth V5.2 DTS
Channel 19: 2480MHz



Test Model: Unwanted Emissions In Non-Restricted Frequency Bands
Bluetooth V5.2 DTS
Channel 39: 2480MHz

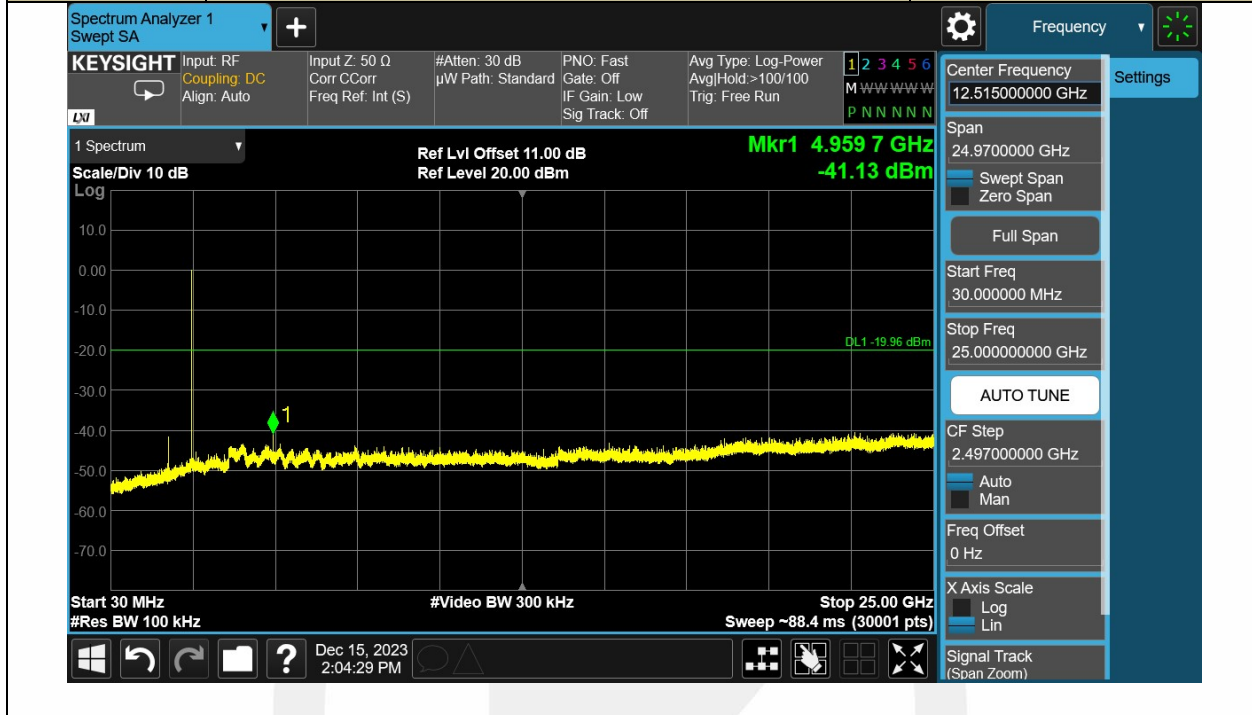

Test Model: Band edge
Bluetooth V5.2 DTS
Channel 39: 2480MHz



8.5 RADIATED SPURIOUS EMISSION

8.5.1 Applicable Standard

According to FCC Part 15.247(d) and 15.209 and KDB 558074 D01 15.247 Meas Guidance v05r02

8.5.2 Conformance Limit

According to FCC Part 15.247(d): radiated emissions which fall in the restricted bands, as defined in §15.205(a), must also comply with the radiated emission limits specified in §15.209(a) (see §15.205(c)).

According to FCC Part 15.205, Restricted bands

MHz	MHz	MHz	GHz
0.090-0.110	16.42-16.423	399.9-410	4.5-5.15
10.495-0.505	16.69475-16.69525	608-614	5.35-5.46
2.1735-2.1905	16.80425-16.80475	960-1240	7.25-7.75
4.125-4.128	25.5-25.67	1300-1427	8.025-8.5
4.17725-4.17775	37.5-38.25	1435-1626.5	9.0-9.2
4.20725-4.20775	73-74.6	1645.5-1646.5	9.3-9.5
6.215-6.218	74.8-75.2	1660-1710	10.6-12.7
6.26775-6.26825	123-138	2200-2300	14.47-14.5
8.291-8.294	149.9-150.05	2310-2390	15.35-16.2
8.362-8.366	156.52475-156.52525	2483.5-2500	17.7-21.4
8.37625-8.38675	156.7-156.9	2690-2900	22.01-23.12
8.41425-8.41475	162.0125-167.17	3260-3267	23.6-24.0
12.29-12.293	167.72-173.2	3332-3339	31.2-31.8
12.51975-12.52025	240-285	3345.8-3358	36.43-36.5
12.57675-12.57725	322-335.4	3600-4400	(2)
13.36-13.41			

According to FCC Part 15.209, the level of any transmitter spurious emission in Restricted bands shall not exceed the level of the emission specified in the following table

Restricted Frequency(MHz)	Field Strength (μV/m)	Field Strength (dBμV/m)	Measurement Distance
0.009-0.490	2400/F(KHz)	20 log (uV/m)	300
0.490-1.705	24000/F(KHz)	20 log (uV/m)	30
1.705-30	30	29.5	30
30-88	100	40	3
88-216	150	43.5	3
216-960	200	46	3
Above 960	500	54	3

8.5.3 Test Configuration

Test according to clause 7.2 radio frequency test setup 2

8.5.4 Test Procedure

This test is required for any spurious emission that falls in a Restricted Band, as defined in Section 15.205. It must be performed with the highest gain of each type of antenna proposed for use with the EUT. Use the following spectrum analyzer settings:

The EUT was placed on a turn table which is 0.8m above ground plane.

Maximum procedure was performed on the highest emissions to ensure EUT compliance.

Span = wide enough to fully capture the emission being measured

RBW = 1 MHz for $f \geq 1$ GHz(1GHz to 25GHz), 100 kHz for $f < 1$ GHz(30MHz to 1GHz)

VBW \geq RBW

Sweep = auto

Detector function = peak

Trace = max hold

Follow the guidelines in ANSI C63.10-2013 with respect to maximizing the emission by rotating the EUT, measuring the emission while the EUT is situated in three orthogonal planes (if appropriate), adjusting the measurement antenna height and polarization, etc. A pre-amp and a high pass filter are required for this test, in order to provide the measuring system with sufficient sensitivity. Allow the trace to stabilize. The peak reading of the emission, after being corrected by the antenna factor, cable loss, pre-amp gain, etc., is the peak field strength, which must comply with the limit specified in Section 15.35(b). Submit this data.

Now set the VBW to 10 Hz, while maintaining all of the other instrument settings. This peak level, once corrected, must comply with the limit specified in Section 15.209. If the dwell time per channel of the hopping signal is less than 100 ms, then the reading obtained with the 10 Hz VBW may be further adjusted by a "duty cycle correction factor", derived from $20\log(\text{dwell time}/100 \text{ ms})$, in an effort to demonstrate compliance with the 15.209 limit. Submit this data.

Repeat above procedures until all frequency measured was complete.

8.5.5 Test Results

Temperature:	17° C
Relative Humidity:	49%
ATM Pressure:	1011 mbar

■ Spurious Emission below 30MHz (9KHz to 30MHz)

Freq. (MHz)	Ant.Pol. H/V	Emission Level(dBuV/m)		Limit 3m(dBuV/m)		Over(dB)	
		PK	AV	PK	AV	PK	AV
--	--	--	--	--	--	--	--

Note: the amplitude of spurious emission that is attenuated by more than 20dB below the permissible limit has no need to be reported.

Distance extrapolation factor = $40\log(\text{Specific distance}/ \text{test distance})$ (dB);

Limit line = Specific limits(dBuV) + distance extrapolation factor

■ Spurious Emission Above 1GHz (1GHz to 25GHz)

Bluetooth V5.2 DTS mode have been tested, and the worst result was report as below:

Test mode: BLE Frequency: Channel 0: 2402MHz

Freq. (MHz)	Ant.Pol. H/V	Emission Level(dBuV/m)		Limit 3m(dBuV/m)		Over(dB)	
		PK	AV	PK	AV	PK	AV
4804.500	V	51.43	49.82	74.00	54.00	-22.57	-4.18
7207.000	V	56.34	52.96	74.00	54.00	-17.66	-1.04
17911.00	V	55.25	39.62	74.00	54.00	-18.75	-14.38
4804.500	H	48.03	45.21	74.00	54.00	-25.97	-8.79
7206.500	H	52.47	49.43	74.00	54.00	-21.53	-4.57
17882.00	H	55.18	39.88	74.00	54.00	-18.82	-14.12

Test mode: BLE Frequency: Channel 19: 2440MHz

Freq. (MHz)	Ant.Pol. H/V	Emission Level(dBuV/m)		Limit 3m(dBuV/m)		Over(dB)	
		PK	AV	PK	AV	PK	AV
4880.000	V	45.62	44.42	74.00	54.00	-28.38	-9.58
7321.000	V	54.95	53.21	74.00	54.00	-19.05	-0.79
17903.00	V	55.26	40.52	74.00	54.00	-18.74	-13.48
4880.500	H	42.82	39.14	74.00	54.00	-31.18	-14.86
7321.000	H	50.92	47.20	74.00	54.00	-23.08	-6.80
17938.00	H	55.68	40.36	74.00	54.00	-18.32	-13.64

Test mode: BLE Frequency: Channel 39: 2480MHz

Freq. (MHz)	Ant.Pol. H/V	Emission Level(dBuV/m)		Limit 3m(dBuV/m)		Over(dB)	
		PK	AV	PK	AV	PK	AV
4960.00	V	46.68	44.96	74.00	54.00	-27.32	-9.04
7440.50	V	52.72	51.73	74.00	54.00	-21.28	-2.27
17959.00	V	56.12	40.81	74.00	54.00	-17.88	-13.19
4960.500	H	42.94	39.26	74.00	54.00	-31.06	-14.74
7441.000	H	49.45	46.01	74.00	54.00	-24.55	-7.99
17958.50	H	56.36	40.62	74.00	54.00	-17.64	-13.38

- Note:**
- (1) All Readings are Peak Value (VBW=3MHz) and Average Value (VBW=10Hz).
 - (2) Emission Level= Reading Level+Correct Factor +Cable Loss.
 - (3) Correct Factor= Ant_F + Cab_L - Preamp
 - (4) The reading of emissions are attenuated more than 20dB below the permissible limits or the field strength is too small to be measured.

■ Spurious Emission in Restricted Band 2310-2390MHz and 2483.5-2500MHz

Frequency (MHz)	Polarity	PK(dBuV/m) (VBW=3MHz)	Limit 3m (dBuV/m)	AV(dBuV/m) (VBW=10Hz)	Limit 3m (dBuV/m)
2340.440	H	58.75	74.00	43.27	54.00
2356.640	V	58.44	74.00	44.65	54.00

Frequency (MHz)	Polarity	PK(dBuV/m) (VBW=3MHz)	Limit 3m (dBuV/m)	AV(dBuV/m) (VBW=10Hz)	Limit 3m (dBuV/m)
2491.247	H	58.98	74.00	43.26	54.00
2492.831	V	58.56	74.00	44.15	54.00

- Note:**
- (1) All Readings are Peak Value (VBW=3MHz) and Average Value (VBW=10Hz).
 - (2) Emission Level= Reading Level+Correct Factor +Cable Loss.
 - (3) Correct Factor= Ant_F + Cab_L - Preamp
 - (4) The reading of emissions are attenuated more than 20dB below the permissible limits or the field strength is too small to be measured.

All the modulation modes were tested, the data of the worst mode are described in the following table

Test Model	Spurious Emission in Restricted Band 2310-2390MHz		H
	Bluetooth V5.2 DTS Channel 0: 2402MHz		

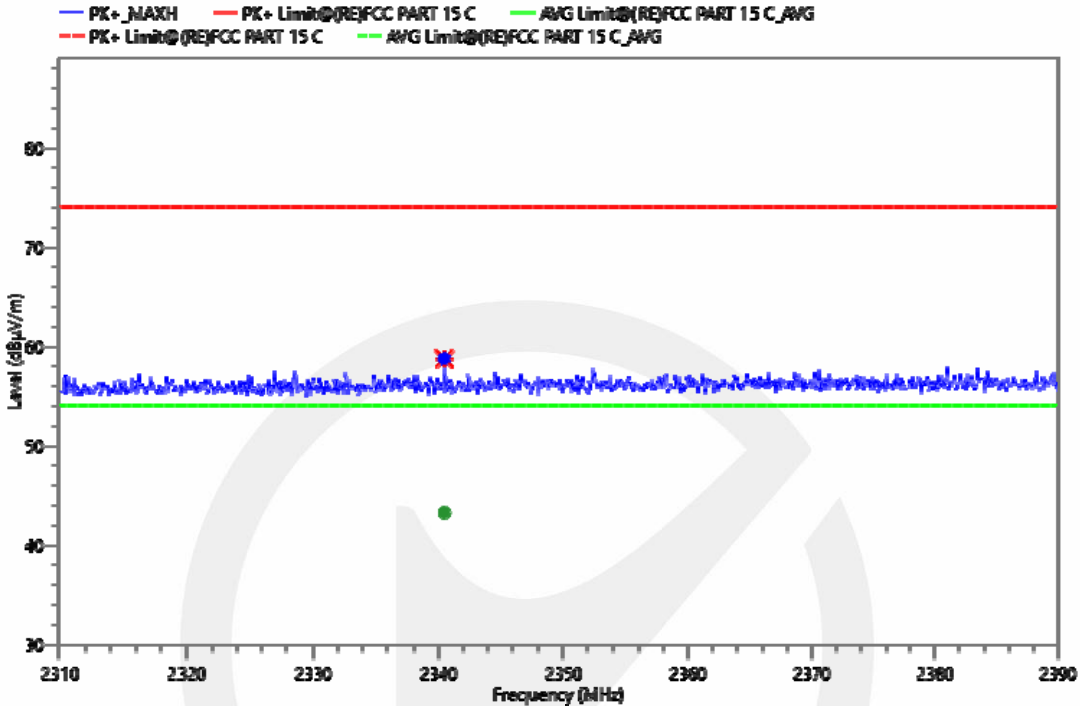

Test Model	Spurious Emission in Restricted Band 2310-2390MHz		V
	Bluetooth V5.2 DTS Channel 0: 2402MHz		

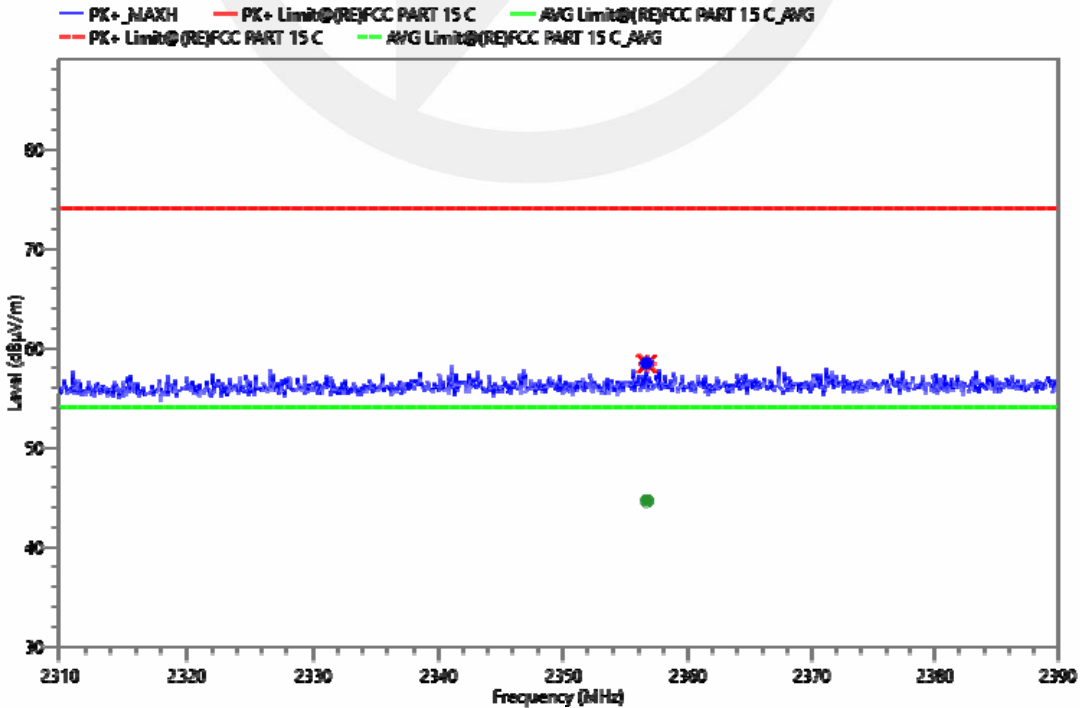

Test Model	Spurious Emission in Restricted Band 2483.5-2500MHz	
	Bluetooth V5.2 DTS	
	Channel 39: 2480MHz	H

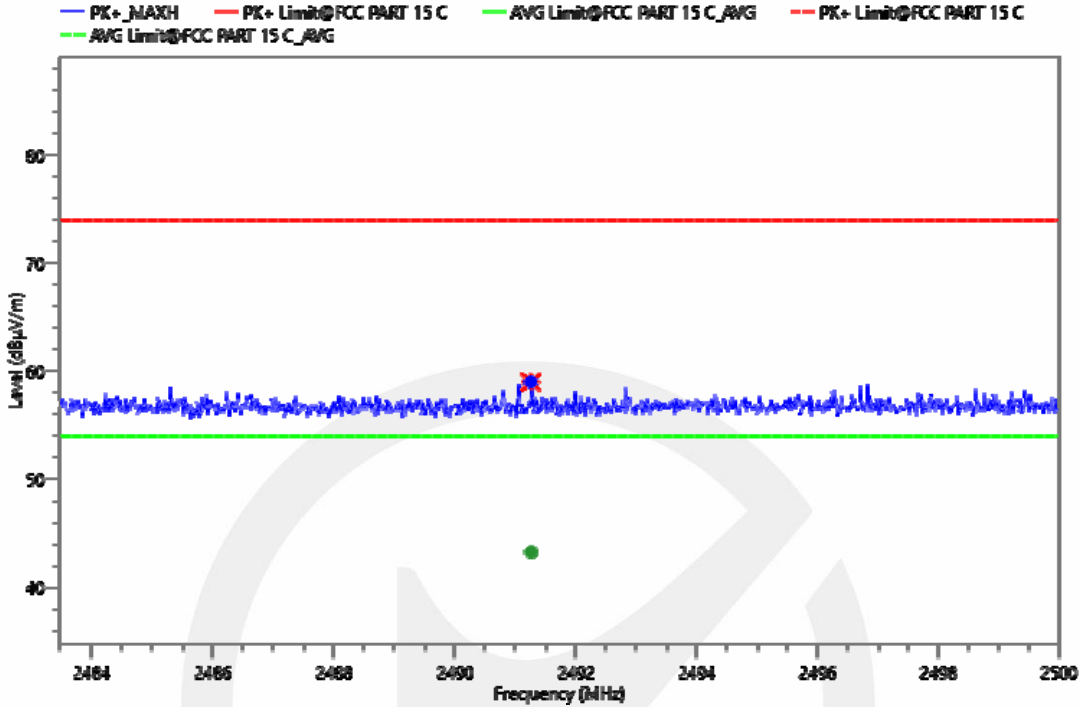

Test Model	Spurious Emission in Restricted Band 2483.5-2500MHz	
	Bluetooth V5.2 DTS	
	Channel 39: 2480MHz	V

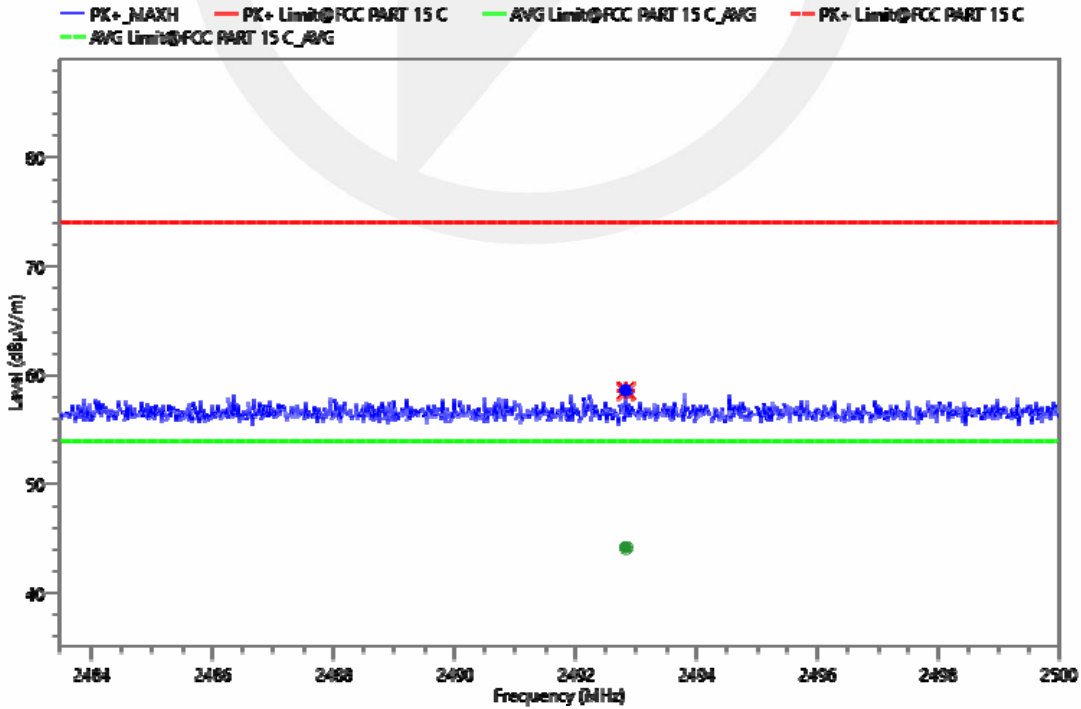

■ Spurious Emission below 1GHz (30MHz to 1GHz)

All modes have been tested, and the worst result recorded was report as below:

Project Information			
Mode:	TX 2402MHz	Voltage:	AC 120V/60Hz
Environment:	Temp: 20°C; Humi:51%	Engineer:	Jackson Xue

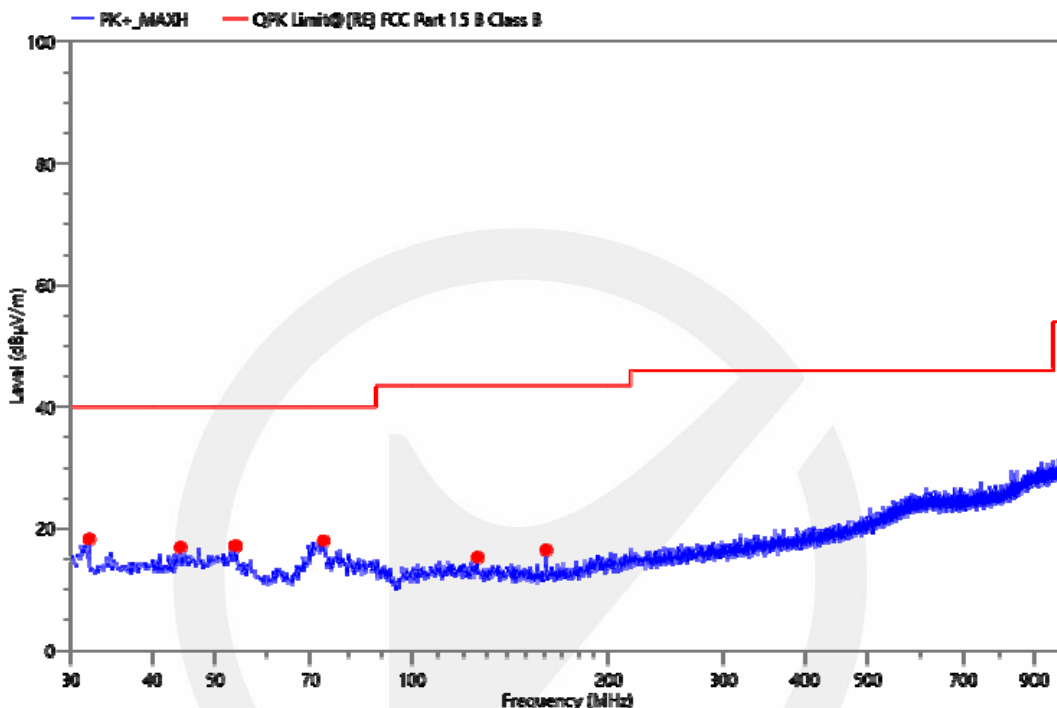

Freq. (MHz)	Reading (dBµV)	Meas. (dBµV/m)	Limit (dBµV/m)	Margin (dBµV/m)	Det.	Height (cm)	Pol.	Azimuth (deg)	Corr. (dB)	Verdict
32.037	36.33	18.29	40.00	21.71	QPK	100	V	83.7	-18.04	PASS
44.162	33.81	16.92	40.00	23.08	QPK	100	V	237.0	-16.89	PASS
53.571	34.84	17.15	40.00	22.85	QPK	200	V	266.1	-17.69	PASS
73.262	35.83	17.99	40.00	22.01	QPK	100	V	358.6	-17.84	PASS
125.739	33.67	15.28	43.50	28.22	QPK	100	V	51.2	-18.39	PASS
160.756	35.56	16.48	43.50	27.02	QPK	100	V	213.6	-19.08	PASS

Project Information			
Mode:	TX 2402MHz	Voltage:	AC 120V/60Hz
Environment:	Temp: 20°C; Humi:51%	Engineer:	Jackson Xue

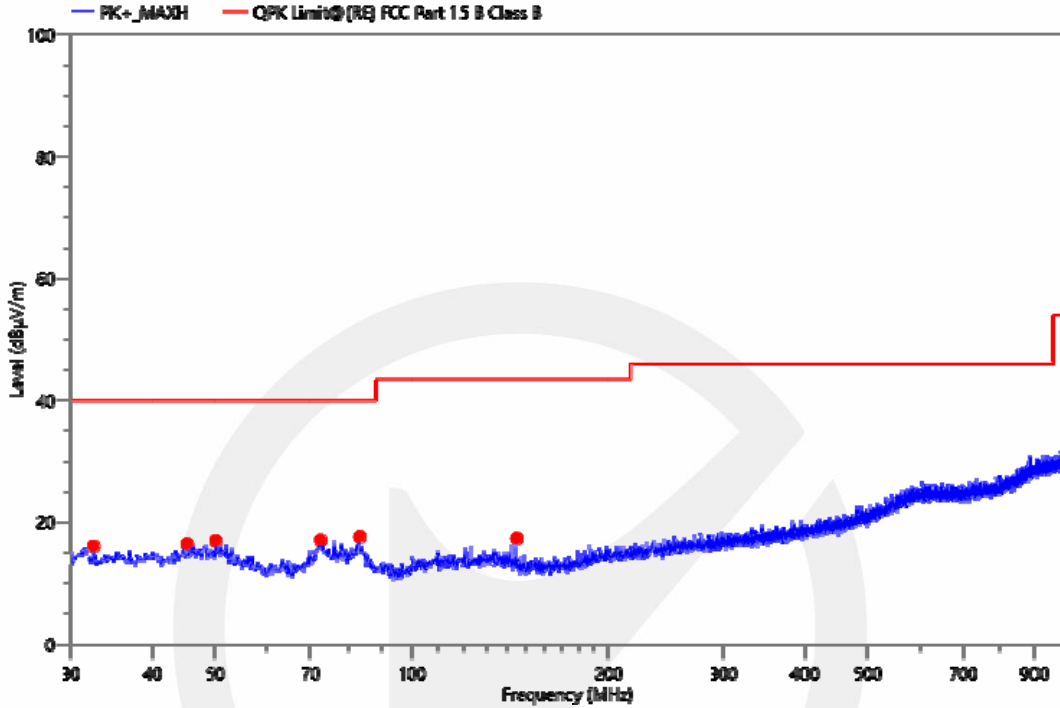

Freq. (MHz)	Reading (dBµV)	Meas. (dBµV/m)	Limit (dBµV/m)	Margin (dBµV/m)	Det.	Height (cm)	Pol.	Azimuth (deg)	Corr. (dB)	Verdict
32.522	34.05	16.11	40.00	23.89	QPK	100	H	211.8	-17.94	PASS
45.229	33.14	16.46	40.00	23.54	QPK	100	H	171.8	-16.68	PASS
50.079	33.45	17.00	40.00	23.00	QPK	200	H	341.1	-16.45	PASS
72.486	35.12	17.11	40.00	22.89	QPK	200	H	281.0	-18.01	PASS
82.962	36.12	17.67	40.00	22.33	QPK	100	H	196.9	-18.45	PASS
144.654	36.30	17.39	43.50	26.11	QPK	100	H	61.3	-18.91	PASS

Project Information			
Mode:	TX 2440MHz	Voltage:	AC 120V/60Hz
Environment:	Temp: 20°C; Humi:51%	Engineer:	Jackson Xue

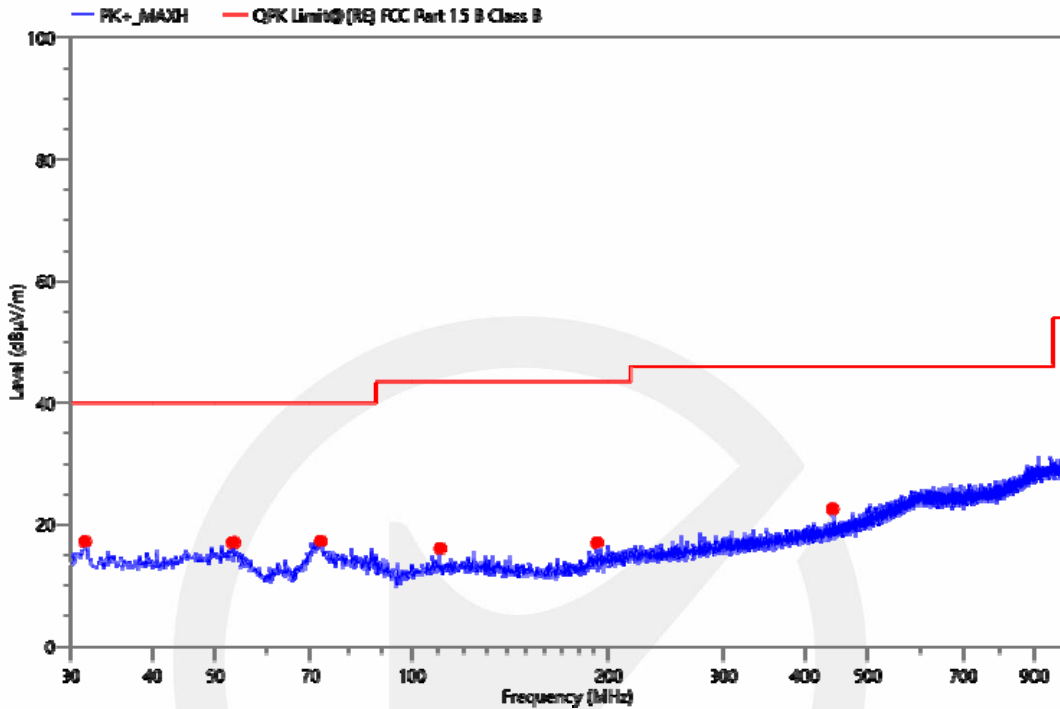

Freq. (MHz)	Reading (dBµV)	Meas. (dBµV/m)	Limit (dBµV/m)	Margin (dBµV/m)	Det.	Height (cm)	Pol.	Azimuth (deg)	Corr. (dB)	Verdict
31.552	35.35	17.22	40.00	22.78	QPK	100	V	250.1	-18.13	PASS
53.183	34.65	17.10	40.00	22.90	QPK	100	V	159.3	-17.55	PASS
72.486	35.30	17.29	40.00	22.71	QPK	100	V	118.6	-18.01	PASS
110.607	34.55	16.11	43.50	27.39	QPK	200	V	143.9	-18.44	PASS
191.796	34.41	17.02	43.50	26.48	QPK	200	V	262.6	-17.39	PASS
440.407	34.53	22.58	46.00	23.42	QPK	100	V	81.4	-11.95	PASS

Project Information			
Mode:	TX 2440MHz	Voltage:	AC 120V/60Hz
Environment:	Temp: 20°C; Humi:51%	Engineer:	Jackson Xue

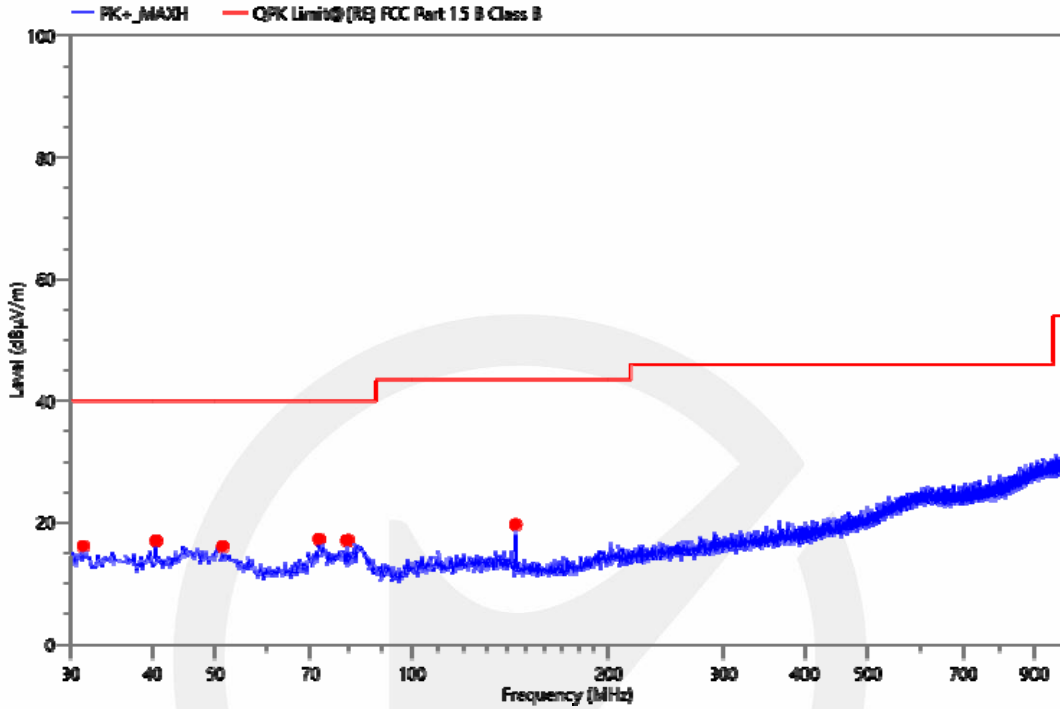

Freq. (MHz)	Reading (dBµV)	Meas. (dBµV/m)	Limit (dBµV/m)	Margin (dBµV/m)	Det.	Height (cm)	Pol.	Azimuth (deg)	Corr. (dB)	Verdict
31.358	34.29	16.12	40.00	23.88	QPK	200	H	197.1	-18.17	PASS
40.476	34.79	17.04	40.00	22.96	QPK	200	H	162.0	-17.75	PASS
51.340	32.98	16.08	40.00	23.92	QPK	100	H	132.3	-16.9	PASS
72.098	35.39	17.30	40.00	22.70	QPK	100	H	331.4	-18.09	PASS
79.567	34.81	17.11	40.00	22.89	QPK	200	H	360	-17.7	PASS
144.072	38.57	19.68	43.50	23.82	QPK	100	H	39.3	-18.89	PASS

Project Information			
Mode:	TX 2480MHz	Voltage:	AC 120V/60Hz
Environment:	Temp: 20°C; Humi:51%	Engineer:	Jackson Xue

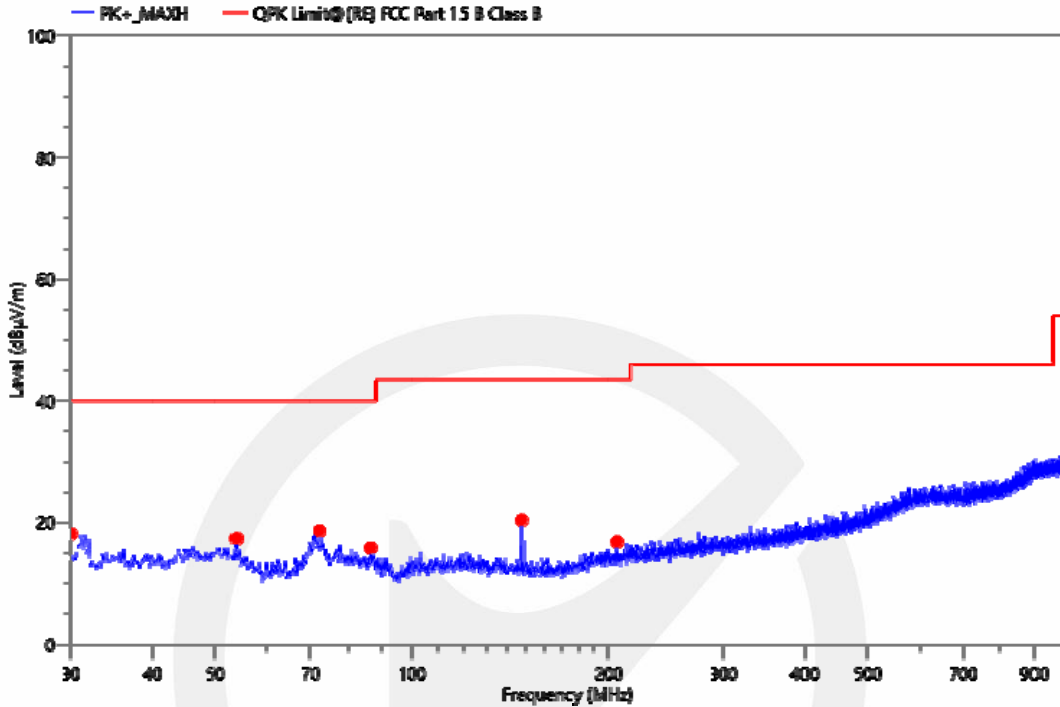

Freq. (MHz)	Reading (dBµV)	Meas. (dBµV/m)	Limit (dBµV/m)	Margin (dBµV/m)	Det.	Height (cm)	Pol.	Azimuth (deg)	Corr. (dB)	Verdict
30.000	36.62	18.18	40.00	21.82	QPK	100	V	227.5	-18.44	PASS
53.765	35.15	17.39	40.00	22.61	QPK	200	V	132.5	-17.76	PASS
72.195	36.72	18.65	40.00	21.35	QPK	100	V	141.4	-18.07	PASS
86.260	35.01	15.85	40.00	24.15	QPK	100	V	13.4	-19.16	PASS
147.273	39.41	20.42	43.50	23.08	QPK	200	V	179.0	-18.99	PASS
205.958	33.79	16.86	43.50	26.64	QPK	100	V	144.0	-16.93	PASS

Project Information			
Mode:	TX 2480MHz	Voltage:	AC 120V/60Hz
Environment:	Temp: 20°C; Humi:51%	Engineer:	Jackson Xue

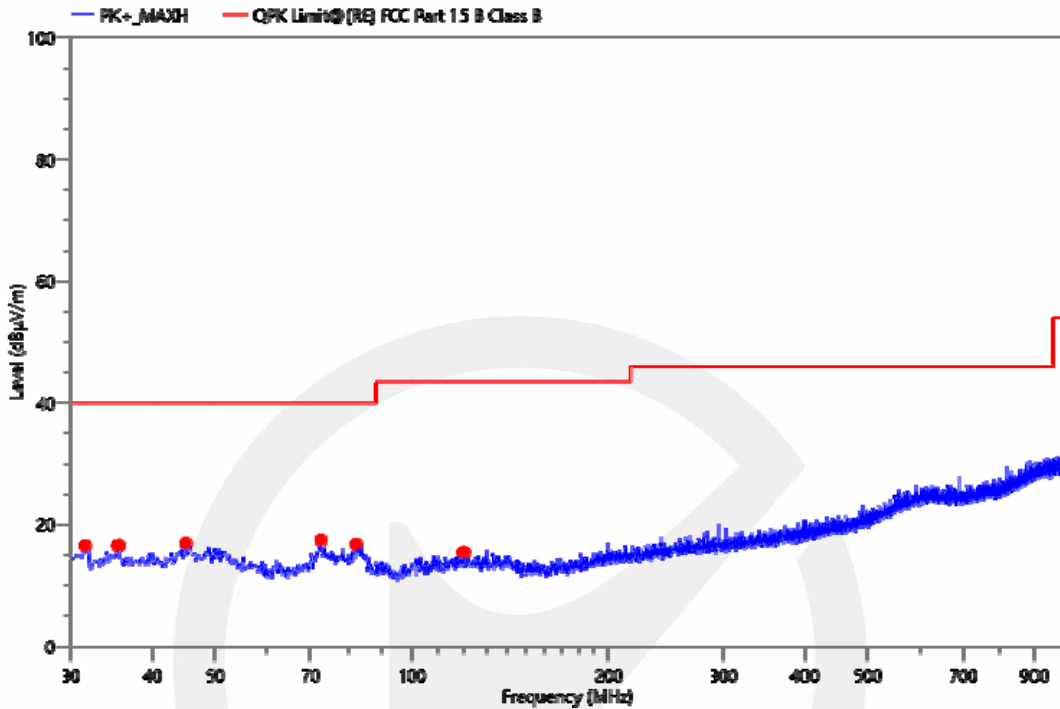

Freq. (MHz)	Reading (dBµV)	Meas. (dBµV/m)	Limit (dBµV/m)	Margin (dBµV/m)	Det.	Height (cm)	Pol.	Azimuth (deg)	Corr. (dB)	Verdict
31.552	34.70	16.57	40.00	23.43	QPK	100	H	324.0	-18.13	PASS
35.432	34.11	16.62	40.00	23.38	QPK	100	H	4.5	-17.49	PASS
45.035	33.60	16.91	40.00	23.09	QPK	100	H	199.7	-16.69	PASS
72.583	35.47	17.48	40.00	22.52	QPK	100	H	260.7	-17.99	PASS
81.895	34.97	16.78	40.00	23.22	QPK	200	H	80.3	-18.19	PASS
119.919	33.60	15.44	43.50	28.06	QPK	200	H	198.6	-18.16	PASS

8.6 CONDUCTED EMISSIONS TEST

8.6.1 Applicable Standard

According to FCC Part 15.207(a)

8.6.2 Conformance Limit

Frequency(MHz)	Conducted Emission Limit	
	Quasi-peak	Average
0.15-0.5	66-56	56-46
0.5-5.0	56	46
5.0-30.0	60	50

Note: 1. The lower limit shall apply at the transition frequencies
 2. The limit decreases in line with the logarithm of the frequency in the range of 0.15 to 0.50MHz.

8.6.3 Test Configuration

Test according to clause 7.3 conducted emission test setup

8.6.4 Test Procedure

The EUT was placed on a table which is 0.8 m above ground plane.
 Maximum procedure was performed on the highest emissions to ensure EUT compliance.
 Repeat above procedures until all frequency measured were complete.

8.6.5 Test Results

Pass.
 All modes have been tested, and the worst result recorded was report as below:

Project Information			
Mode:	TX2402	Voltage:	AC 120V/60Hz
Environment:	Temp: 21°C; Humi:33%	Engineer:	Ace Li

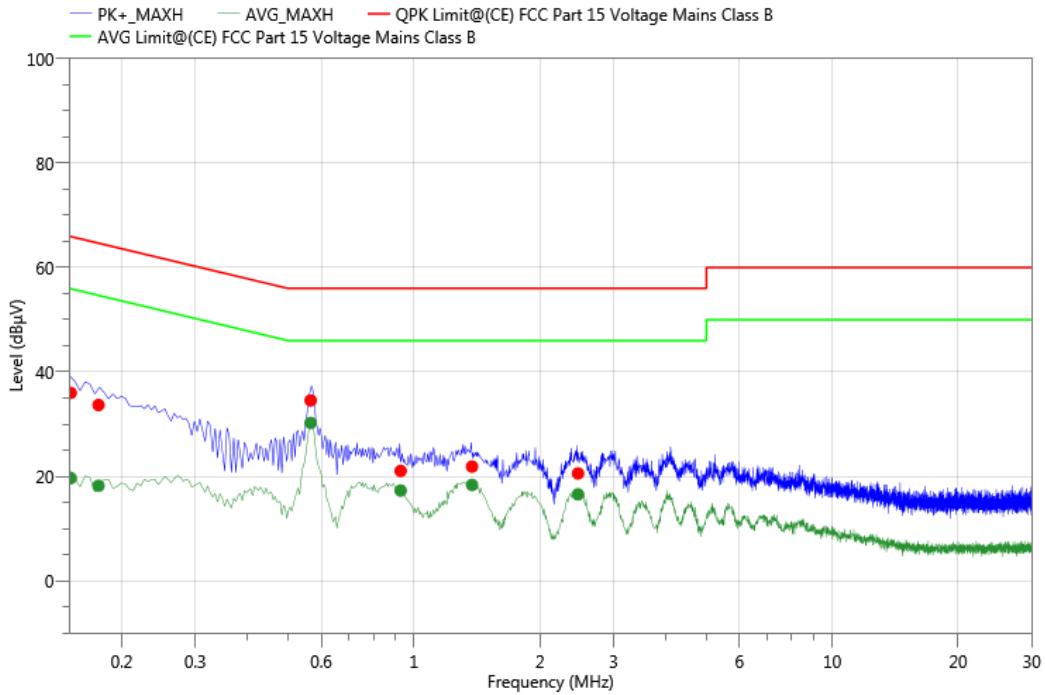

Freq. (MHz)	Reading (dBµV)	Meas. (dBµV)	Limit (dBµV)	Margin (dB)	Det.	Line	Corr. (dB)	Verdict
0.151	25.79	35.98	65.94	29.96	QPK	N	10.19	PASS
0.151	9.47	19.66	55.94	36.28	AVG	N	10.19	PASS
0.176	23.47	33.66	64.67	31.01	QPK	N	10.19	PASS
0.176	7.99	18.18	54.67	36.49	AVG	N	10.19	PASS
0.566	24.29	34.54	56.00	21.46	QPK	N	10.25	PASS
0.566	19.99	30.24	46.00	15.76	AVG	N	10.25	PASS
0.929	10.77	21.03	56.00	34.97	QPK	N	10.26	PASS
0.929	7.01	17.27	46.00	28.73	AVG	N	10.26	PASS
1.376	11.62	21.87	56.00	34.13	QPK	N	10.25	PASS
1.376	8.10	18.35	46.00	27.65	AVG	N	10.25	PASS
2.466	10.31	20.55	56.00	35.45	QPK	N	10.24	PASS
2.466	6.31	16.55	46.00	29.45	AVG	N	10.24	PASS

Project Information			
Mode:	TX2402	Voltage:	AC 120V/60Hz
Environment:	Temp: 21°C; Humi:33%	Engineer:	Ace Li

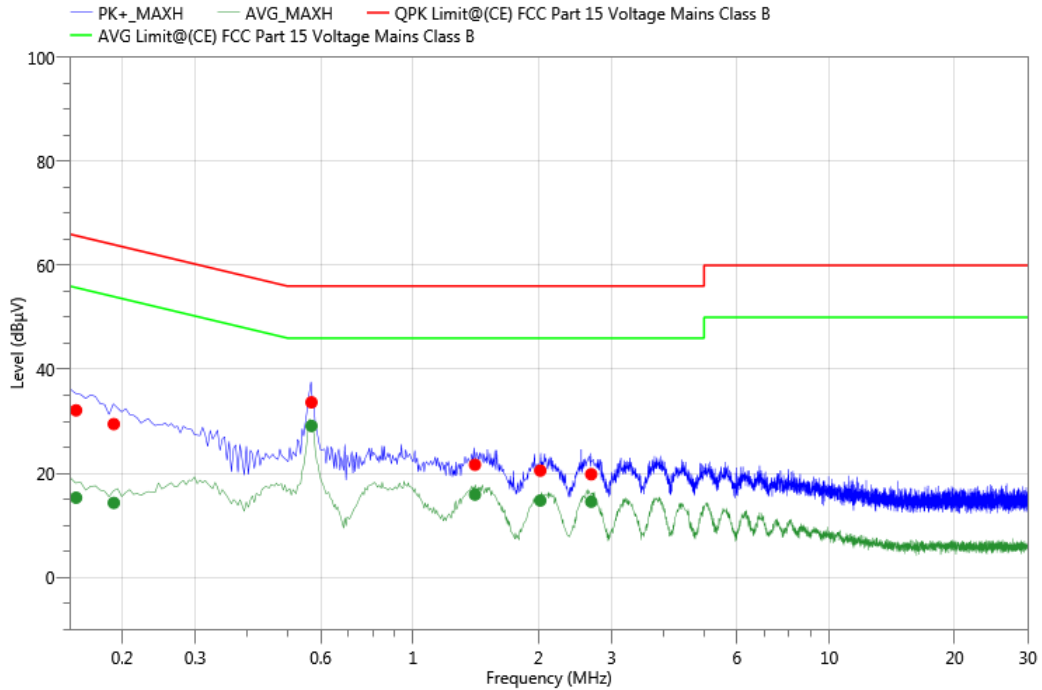

Freq. (MHz)	Reading (dBµV)	Meas. (dBµV)	Limit (dBµV)	Margin (dB)	Det.	Line	Corr. (dB)	Verdict
0.155	21.92	32.11	65.73	33.62	QPK	L1	10.19	PASS
0.155	5.11	15.30	55.73	40.43	AVG	L1	10.19	PASS
0.191	19.28	29.46	63.99	34.53	QPK	L1	10.18	PASS
0.191	4.12	14.30	53.99	39.69	AVG	L1	10.18	PASS
0.570	23.40	33.65	56.00	22.35	QPK	L1	10.25	PASS
0.570	18.86	29.11	46.00	16.89	AVG	L1	10.25	PASS
1.408	11.40	21.64	56.00	34.36	QPK	L1	10.24	PASS
1.408	5.66	15.90	46.00	30.10	AVG	L1	10.24	PASS
2.021	10.29	20.51	56.00	35.49	QPK	L1	10.22	PASS
2.021	4.54	14.76	46.00	31.24	AVG	L1	10.22	PASS
2.679	9.57	19.81	56.00	36.19	QPK	L1	10.24	PASS
2.679	4.29	14.53	46.00	31.47	AVG	L1	10.24	PASS

8.7 ANTENNA APPLICATION

8.7.1 Antenna Requirement

Standard	Requirement
FCC CRF Part 15.203	An intentional radiator shall be designed to ensure that no antenna other than that furnished by the responsible party shall be used with the device. The use of a permanently attached antenna or of an antenna that uses a unique coupling to the intentional radiator shall be considered sufficient to comply with the provisions of this section. The manufacturer may design the unit so that a broken antenna can be replaced by the user, but the use of a standard antenna jack or electrical connector is prohibited. This requirement does not apply to carrier current devices or to devices operated under the provisions of §15.211, §15.213, §15.217, §15.219, or §15.221. Further, this requirement does not apply to intentional radiators that must be professionally installed, such as perimeter protection systems and some field disturbance sensors, or to other intentional radiators which, in accordance with §15.31(d), must be measured at the installation site. However, the installer shall be responsible for ensuring that the proper antenna is employed so that the limits in this part are not exceeded.

For intentional device, according to FCC 47 CFR Section 15.203, an intentional radiator shall be designed to ensure that no antenna other than that furnished by the responsible party shall be used with the device. And according to FCC 47 CFR Section 15.247 (b), if transmitting antennas of directional gain greater than 6dBi are used, the power shall be reduced by the amount in dB that the directional gain of the antenna exceeds 6dBi.

8.7.2 Result

PASS.

The EUT has 1 antenna: a Ceramic Antenna gain is -2.72 dBi;

Note: Antenna use a permanently attached antenna which is not replaceable.
 Not using a standard antenna jack or electrical connector for antenna replacement
 The antenna has to be professionally installed (please provide method of installation)

which in accordance to section 15.203, please refer to the internal photos.

*** End of Report ***

声明 Statement

1. 本报告无授权批准人签字及“检验检测专用章”无效;
This report will be void without authorized signature or special seal for testing report.
2. 未经许可本报告不得部分复制;
This report shall not be copied partly without authorization.
3. 本报告的检测结果仅对送测样品有效, 委托方对样品的代表性和资料的真实性负责;
The test results or observations are applicable only to tested sample. Client shall be responsible for representativeness of the sample and authenticity of the material.
4. 本检测报告中检测项目标注有特殊符号则该项目不在资质认定范围内, 仅作为客户委托、科研、教学或内部质量控制等目的使用;
The observations or tests with special mark fall outside the scope of accreditation, and are only used for purpose of commission, research, training, internal quality control etc.
5. 本检测报告以实测值进行符合性判定, 未考虑不确定度所带来的风险, 本实验室不承担相关责任, 特别约定、标准或规范中有明确规定的除外;
The test results or observations are provided in accordance with measured value, without taking risks caused by uncertainty into account. Without explicit stipulation in special agreements, standards or regulations, EMTEK shall not assume any responsibility.
6. 对本检测报告若有异议, 请于收到报告之日起 20 日内提出;
Objections shall be raised within 20 days from the date receiving the report.