

TEST REPORT

Report No.: BCTC2203512699-1E

Applicant: Fpc security Corp

Product Name: Keypad/Readers

Model/Type reference: VIS-3000

Tested Date: 2022-03-08 to 2022-04-12

Issued Date: 2022-04-12

Shenzhen BCTC Testing Co., Ltd.



FCC ID: 2AMWNVIS-3000

Product Name: Keypad/Readers
Trademark: VISIONIS
Model/Type Ref.: VIS-3000
Prepared For: Fpc security Corp
Address: 10025 NW 116 Way, Suite # 12 Medley, FL 33178 USA
Manufacturer: SIB
Address: 8/F,Block B, Banwei Industry Park,Yongxiang Road, Bantian St., Longgang District , 518129, Shenzhen, China.
Prepared By: Shenzhen BCTC Testing Co., Ltd.
Address: 1-2/F., Building B, Pengzhou Industrial Park, No.158, Fuyuan 1st Road, Tangwei, Fuhai Subdistrict, Bao'an District, Shenzhen, Guangdong, China
Sample Received Date: 2022-03-08
Sample tested Date: 2022-03-08 to 2022-04-12
Issue Date: 2022-04-12
Report No.: BCTC2203512699-1E
Test Standards: FCC Part15.225
ANSI C63.10-2013
Test Results: PASS
Remark: This is NFC radio test report.

Tested by:

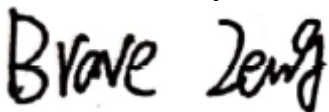

Brave Zeng/ Project Handler

Approved by:



Zero Zhou/Reviewer

The test report is effective only with both signature and specialized stamp. This result(s) shown in this report refer only to the sample(s) tested. Without written approval of Shenzhen BCTC Testing Co., Ltd, this report can't be reproduced except in full. The tested sample(s) and the sample information are provided by the client.

Table Of Content

Test Report Declaration	Page
1. Version	5
2. Test Summary	6
3. Measurement Uncertainty	7
4. Product Information And Test Setup	8
4.1 Product Information.....	8
4.2 Test Setup Configuration	8
4.3 Support Equipment	8
4.4 Channel List	8
4.5 Test Mode	9
5. Test Facility And Test Instrument Used.....	10
5.1 Test Facility.....	10
5.2 Test Instrument Used.....	10
6. Conducted Emissions.....	12
6.1 Block Diagram Of Test Setup.....	12
6.2 Limit	12
6.3 Test Procedure	12
6.4 EUT operating Conditions	13
6.5 Test Result.....	13
7. Radiated Emissions.....	14
7.1 Block Diagram Of Test Setup.....	14
7.2 Limit	15
7.3 EUT Operating Conditions	16
7.4 Test Result.....	17
8. Radiated Band Emission Measurement	20
8.1 Block Diagram Of Test Setup.....	20
8.2 Limit	20
8.3 Test Procedure	21
8.4 EUT Operating Conditions	21
8.5 Test Result.....	22
9. Bandwidth Test.....	23
9.1 Block Diagram Of Test Setup.....	23
9.2 Test Procedure	23
9.3 EUT Operation Conditions	23
9.4 Test Result.....	24
10. Transmitter Frequency Stability.....	25
10.1 Block Diagram Of Test Setup.....	25
10.2 Limit	25
10.3 Test Procedure	25
10.4 EUT Operating Conditions	25
10.5 Test Result.....	26
11. Antenna Requirement	27
11.1 Standard Requirement.....	27

11.2 EUT Antenna	27
12. EUT Photographs.....	28
13. EUT Test Setup Photographs.....	29

(Note: N/A Means Not Applicable)

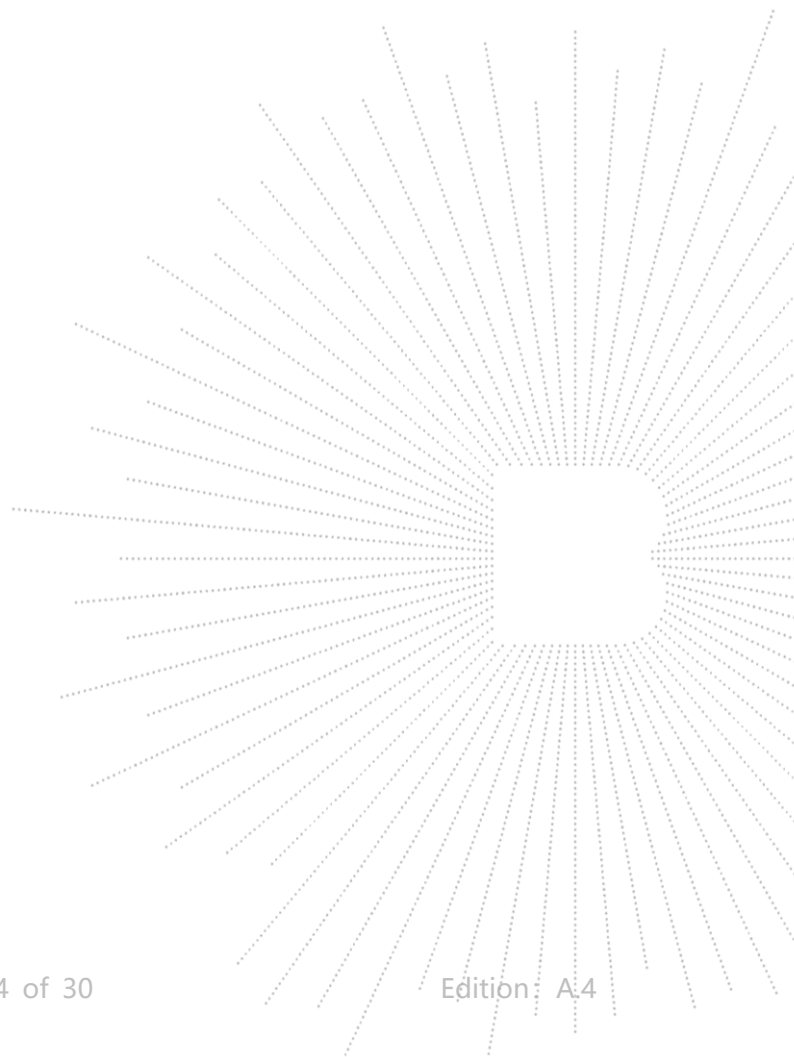

1. Version

Report No.	Issue Date	Description	Approved
BCTC2203512699-1E	2022-04-12	Original	Valid

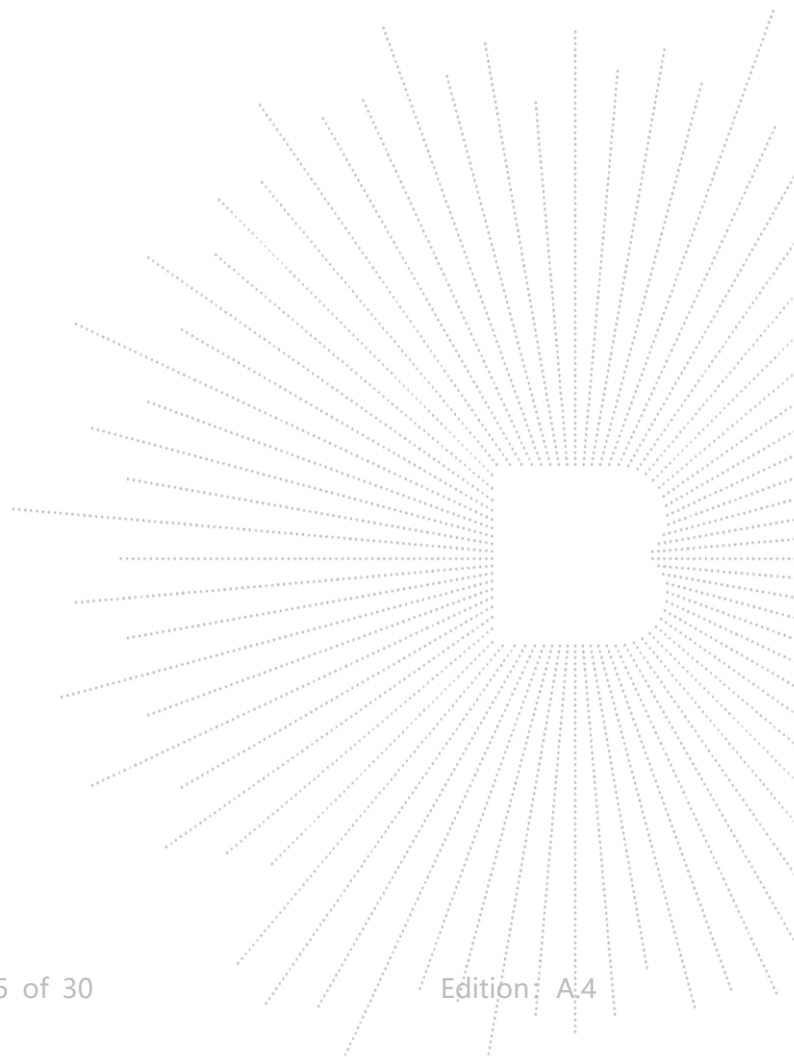

2. Test Summary

The Product has been tested according to the following specifications:

No.	Test Parameter	Clause No	Results
1	15.207	Conducted Emission	N/A
2	Part 15.209(a), 15.225(d)	Radiated Spurious Emission	PASS
3	15.215	Bandwidth	PASS
4	Part 15.209(a), 15.225(a)(b)(c)(d)	Band Edge Emission	PASS
5	Part 15.225(e)	Transmitter Frequency Stability (Temperature & Voltage Variation)	PASS
6	15.203	Antenna Requirement	PASS

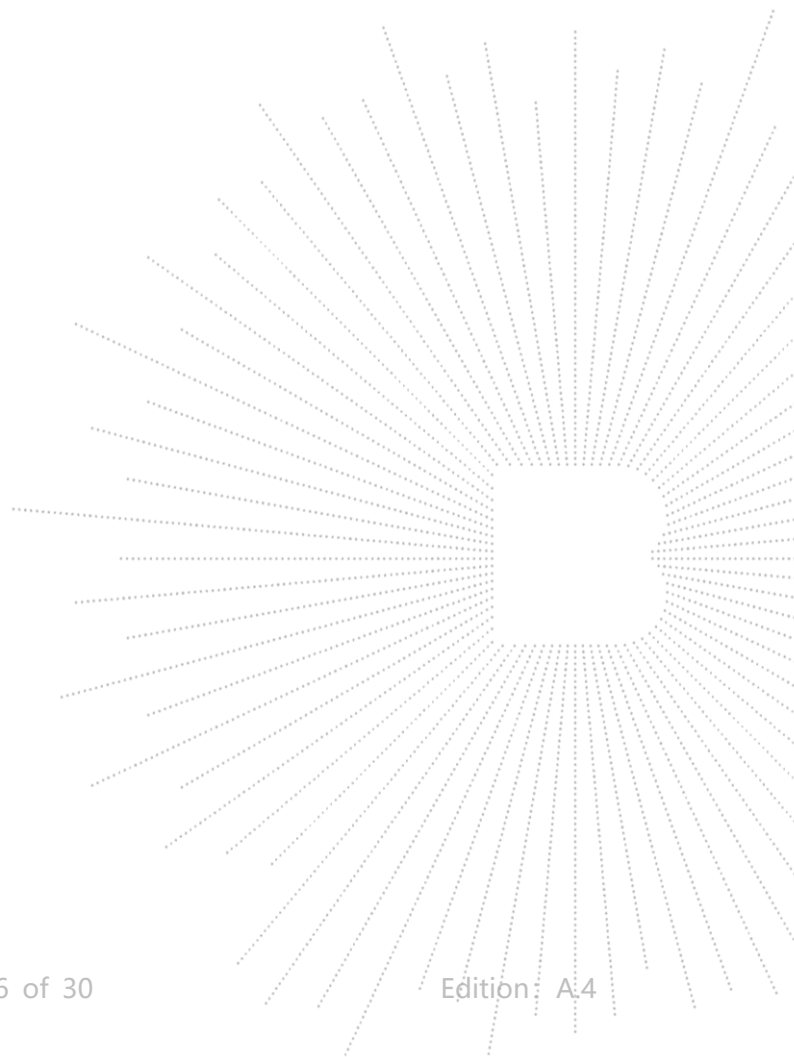

3. Measurement Uncertainty

Where relevant, the following measurement uncertainty levels have been estimated for tests performed on the Product as specified in CISPR 16-4-2. This uncertainty represents an expanded uncertainty expressed at approximately the 95% confidence level using a coverage factor of $k=2$.

No.	Item	Uncertainty
1	3m chamber Radiated spurious emission(30MHz-1GHz)	U=4.3dB
2	3m chamber Radiated spurious emission(9KHz-30MHz)	U=3.7dB
3	3m chamber Radiated spurious emission(1GHz-18GHz)	U=4.5dB
4	3m chamber Radiated spurious emission(18GHz-40GHz)	U=3.34dB
5	Conducted Emission (150kHz-30MHz)	U=3.20dB
6	Conducted Adjacent channel power	U=1.38dB
7	Conducted output power uncertainty Above 1G	U=1.576dB
8	Conducted output power uncertainty below 1G	U=1.28dB
9	humidity uncertainty	U=5.3%
10	Temperature uncertainty	U=0.59°C

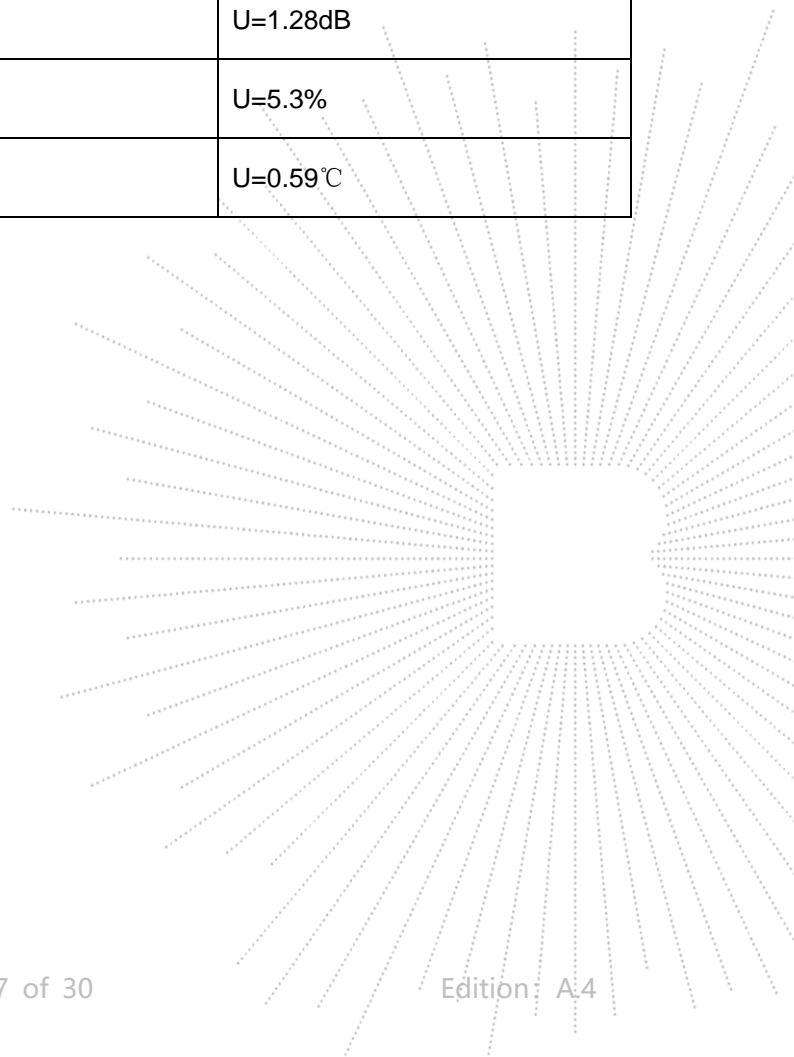

4. Product Information And Test Setup

4.1 Product Information

Model/Type Ref.:	VIS-3000
Model differences:	N/A
Hardware Version:	N/A
Software Version:	N/A
Operation Frequency:	13.56 MHz
Modulation Type:	ASK
Number Of Channel	1 CH
Antenna installation:	Coil Antenna
Antenna Gain:	0dBi
Ratings:	DC 12V

4.2 Test Setup Configuration

See test photographs attached in *EUT TEST SETUP PHOTOGRAPHS* for the actual connections between Product and support equipment.
Radiated Spurious Emission

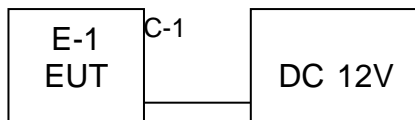

4.3 Support Equipment

No.	Device Type	Brand	Model	Series No.	Note
E-1	Keypad/Readers	N/A	VIS-3000	N/A	EUT

Item	Shielded Type	Ferrite Core	Length	Note
C-1	NO	NO	0.3M	DC cable unshielded

Notes:

- All the equipment/cables were placed in the worst-case configuration to maximize the emission during the test.
- Grounding was established in accordance with the manufacturer's requirements and conditions for the intended use.

4.4 Channel List

Channel List	
Channel	Frequency(MHz)
01	13.56

4.5 Test Mode

To investigate the maximum EMI emission characteristics generates from EUT, the test system was pre-scanning tested base on the consideration of following EUT operation mode or test configuration mode which possible have effect on EMI emission level. Each of these EUT operation mode(s) or test configuration mode(s) mentioned above was evaluated respectively.

For All Mode	Description
Mode 1	TX Mode

Link mode(conducted emission and Radiated emission)	
Final Test Mode	Description
Mode 1	TX Mode

Notes:

- (1) The measurements are performed at the highest, middle, lowest available channels.
- (2) Fully-charged battery is used during the test.

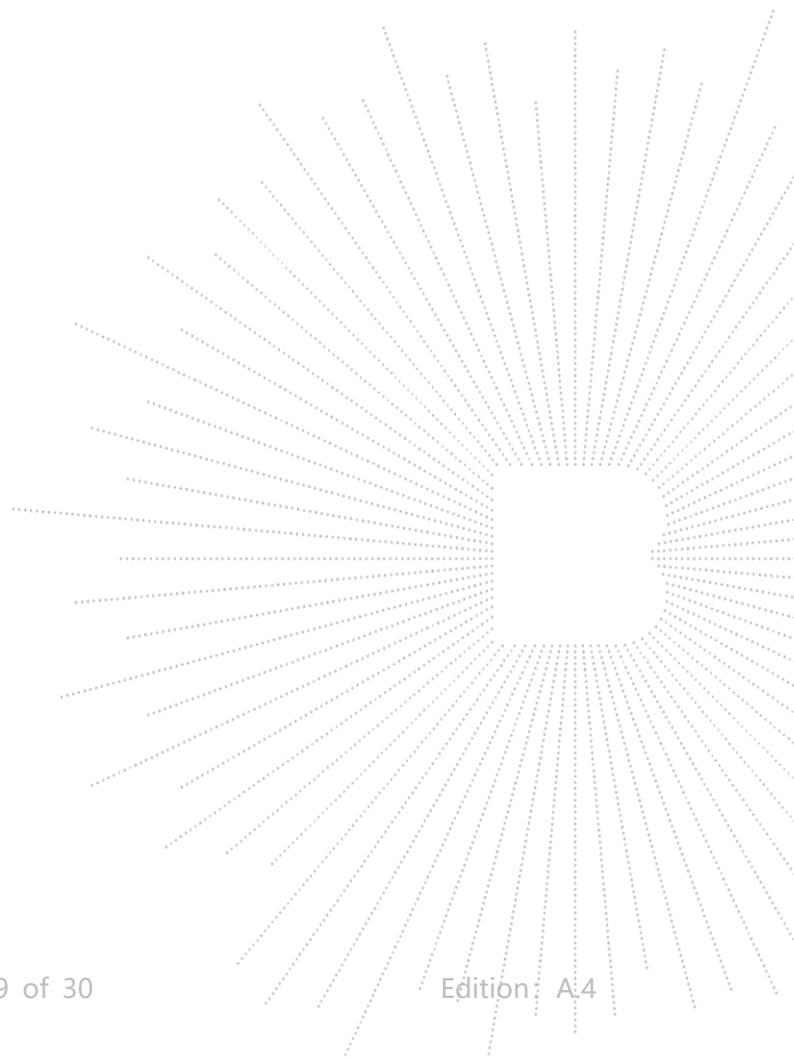

5. Test Facility And Test Instrument Used

5.1 Test Facility

All measurement facilities used to collect the measurement data are located at Shenzhen BCTC Testing Co., Ltd. Address:1-2/F., Building B, Pengzhou Industrial Park, No.158, Fuyuan 1st Road, Tangwei, Fuhai Subdistrict, Bao'an District, Shenzhen, Guangdong, China. The site and apparatus are constructed in conformance with the requirements of ANSI C63.4 and CISPR 16-1-1 other equivalent standards.

FCC Test Firm Registration Number: 712850

IC Registered No.: 23583

5.2 Test Instrument Used

RF Conducted Test					
Equipment	Manufacturer	Model#	Serial#	Last Cal.	Next Cal.
Power Metter	Keysight	E4419	\	May 28, 2021	May 27, 2022
Power Sensor (AV)	Keysight	E9300A	\	May 28, 2021	May 27, 2022
Signal Analyzer20kHz-26.5GHz	Keysight	N9020A	MY49100060	May 28, 2021	May 27, 2022
Spectrum Analyzer9kHz-40GHz	R&S	FSP40	\	May 28, 2021	May 27, 2022

Radiated emissions Test (966 chamber)					
Equipment	Manufacturer	Model#	Serial#	Last Cal.	Next Cal.
966 chamber	ChengYu	966 Room	966	Jun. 06. 2020	Jun. 05, 2023
Receiver	R&S	ESR3	102075	May 28, 2021	May 27, 2022
Receiver	R&S	ESRP	101154	May 28, 2021	May 27, 2022
Amplifier	SKET	LAPA_01G18 G-45dB	\	May 28, 2021	May 27, 2022
Amplifier	Schwarzbeck	BBV9744	9744-0037	May 28, 2021	May 27, 2022
TRILOG Broadband Antenna	Schwarzbeck	VULB9163	942	Jun. 01, 2021	May 31, 2022
Horn Antenna	Schwarzbeck	BBHA9120D	1541	Jun. 02, 2021	Jun. 01, 2022
Horn Antenn(18GHz -40GHz)	Schwarzbeck	BBHA9170	00822	Jun. 15, 2021	Jun. 14, 2022
Amplifier(18G Hz-40GHz)	MITEQ	TTA1840-35- HG	2034381	May 28, 2021	May 27, 2022
Loop Antenna(9kHz -30MHz)	Schwarzbeck	FMZB1519B	00014	Jun. 02, 2021	Jun. 01, 2022
RF cables1(9kHz- 30MHz)	Huber+Suhnar	9kHz-30MHz	B1702988-00 08	May 28, 2021	May 27, 2022
RF cables2(30MH z-1GHz)	Huber+Suhnar	30MHz-1GH z	1486150	May 28, 2021	May 27, 2022
RF cables3(1GHz- 40GHz)	Huber+Suhnar	1GHz-40GHz	1607106	May 28, 2021	May 27, 2022
Power Metter	Keysight	E4419	\	May 28, 2021	May 27, 2022
Power Sensor (AV)	Keysight	E9300A	\	May 28, 2021	May 27, 2022
Signal Analyzer20kHz -26.5GHz	Keysight	N9020A	MY49100060	May 28, 2021	May 27, 2022
Spectrum Analyzer9kHz- 40GHz	R&S	FSP40	\	May 28, 2021	May 27, 2022
Software	Frad	EZ-EMC	FA-03A2 RE	\	\

6. Conducted Emissions

6.1 Block Diagram Of Test Setup



6.2 Limit

FREQUENCY (MHz)	Limit (dBuV)	
	Quas-peak	Average
0.15 -0.5	66 - 56 *	56 - 46 *
0.50 -5.0	56.00	46.00
5.0 -30.0	60.00	50.00

Notes:

- *Decreasing linearly with logarithm of frequency.
- The lower limit shall apply at the transition frequencies.

6.3 Test Procedure

Receiver Parameters	Setting
Attenuation	10 dB
Start Frequency	0.15 MHz
Stop Frequency	30 MHz
IF Bandwidth	9 kHz

- The Product was placed on a nonconductive table 0.8 m above the horizontal ground reference plane, and 0.4 m from the vertical ground reference plane, and connected to the main through Line Impedance Stability Network (L.I.S.N).
- The RBW of the receiver was set at 9 kHz in 150 kHz ~ 30MHz with Peak and AVG detector in Max Hold mode. Run the receiver's pre-scan to record the maximum disturbance generated from Product in all power lines in the full band.
- For each frequency whose maximum record was higher or close to limit, measure its QP and AVG values and record.

6.4 EUT operating Conditions

The EUT was configured for testing in a typical fashion (as a customer would normally use it). The EUT has been programmed to continuously transmit during test. This operating condition was tested and used to collect the included data.

6.5 Test Result

N/A

Note: The EUT is powered by the DC only, the test item is not applicable.

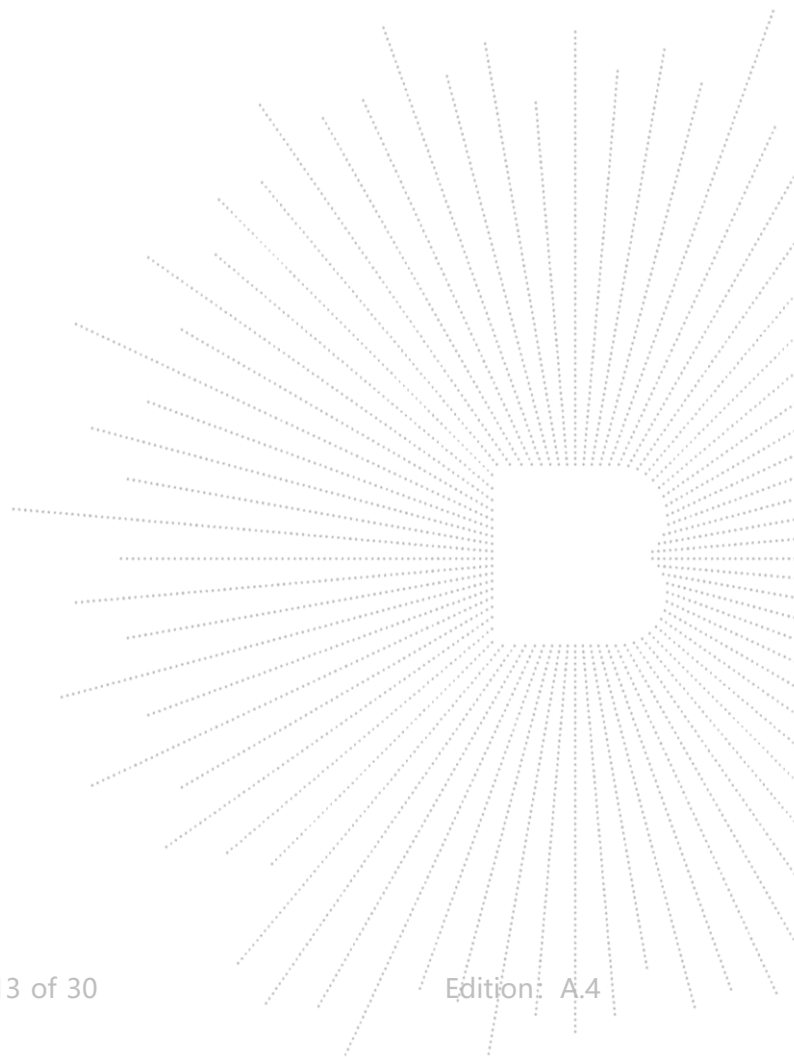

7. Radiated Emissions

7.1 Block Diagram Of Test Setup

(A) Radiated Emission Test-Up Frequency Below 30MHz

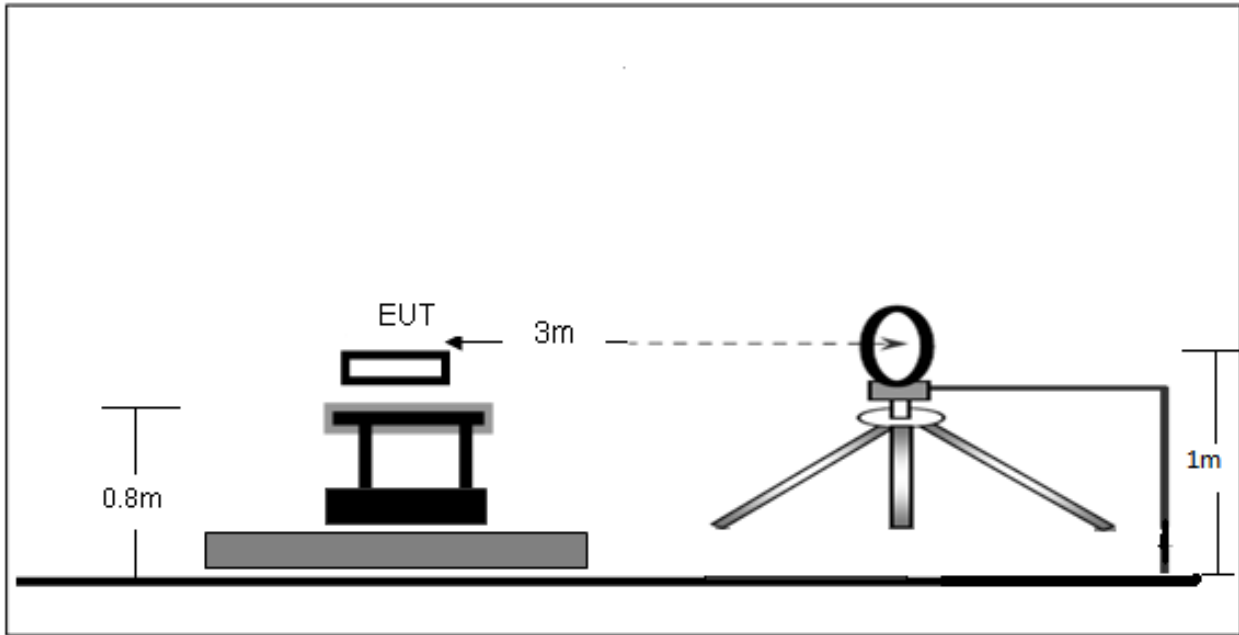

(B) Radiated Emission Test-Up Frequency 30MHz~1GHz

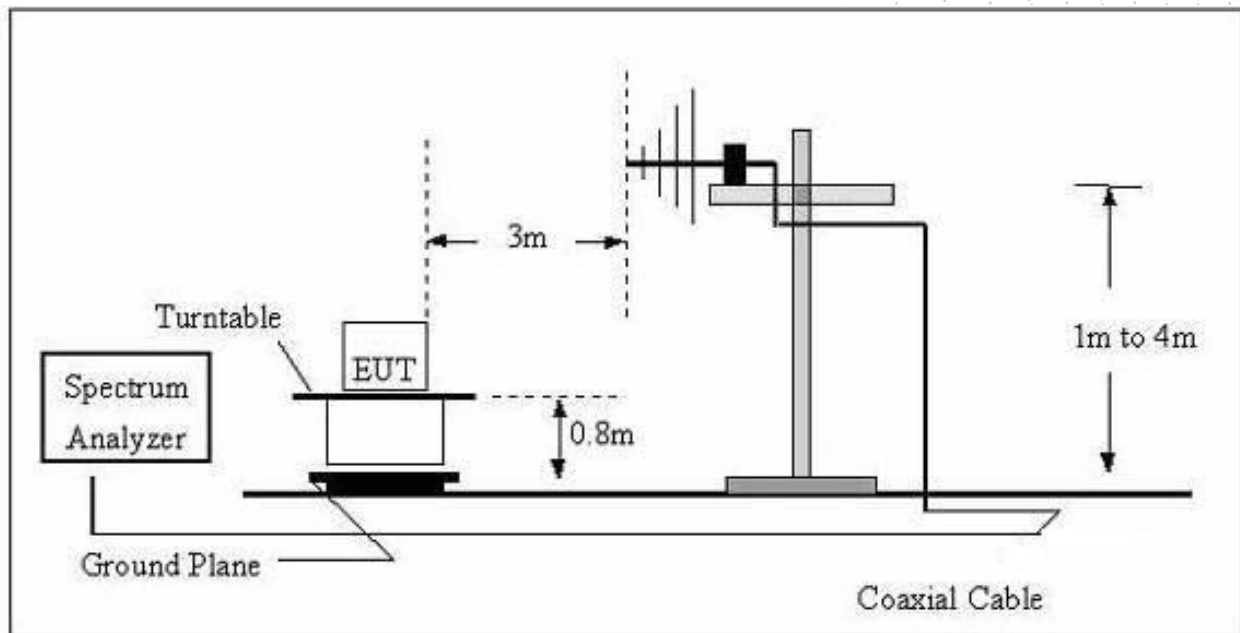

7.2 Limit

20dBc in any 100 kHz bandwidth outside the operating frequency band. In case the emission fall within the restricted band specified on 15.205(a), then the 15.209(a) limit in the table below has to be followed.

Frequency (MHz)	Field Strength uV/m	Distance (m)	Field Strength Limit at 3m Distance	
			uV/m	dBuV/m
0.009 ~ 0.490	2400/F(kHz)	300	10000 * 2400/F(kHz)	20log ^{(2400/F(kHz))} + 80
0.490 ~ 1.705	24000/F(kHz)	30	100 * 24000/F(kHz)	20log ^{(24000/F(kHz))} + 40
1.705 ~ 30	30	30	100 * 30	20log ⁽³⁰⁾ + 40
30 ~ 88	100	3	100	20log ⁽¹⁰⁰⁾
88 ~ 216	150	3	150	20log ⁽¹⁵⁰⁾
216 ~ 960	200	3	200	20log ⁽²⁰⁰⁾
Above 960	500	3	500	20log ⁽⁵⁰⁰⁾

Receiver Parameter	Setting
Attenuation	Auto
Start ~ Stop Frequency	9kHz~150kHz / RB 200Hz for QP
Start ~ Stop Frequency	150kHz~30MHz / RB 9kHz for QP
Start ~ Stop Frequency	30MHz~1000MHz / RB 120kHz for QP

Below 1GHz test procedure as below:

- a. The EUT was placed on the top of a rotating table 0.8 meters above the ground at a 3 meter semi-anechoic chamber. The table was rotated 360 degrees to determine the position of the highest radiation.
- b. The EUT was set 3 meters away from the interference-receiving antenna, which was mounted on the top of a variable-height antenna tower.
- c. The antenna height is varied from one meter to four meters above the ground to determine the maximum value of the field strength. Both horizontal and vertical polarizations of the antenna are set to make the measurement.
- d. For each suspected emission, the EUT was arranged to its worst case and then the antenna was tuned to heights from 1 meter to 4 meters (for the test frequency of below 30MHz, the antenna was tuned to heights 1 meter) and the rotatable table was turned from 0 degrees to 360 degrees to find the maximum reading.
- e. The test-receiver system was set to Peak Detect Function and Specified Bandwidth with Maximum Hold Mode.
- f. If the emission level of the EUT in peak mode was 10dB lower than the limit specified, then testing could be stopped and the peak values of the EUT would be reported. Otherwise the emissions that did not have 10dB margin would be re-tested one by one using peak, quasi-peak or average method as specified and then reported in a data sheet.

Above 1GHz test procedure as below:

- g. Different between above is the test site, change from Semi- Anechoic Chamber to fully Anechoic Chamber and change form table 0.8 metre to 1.5 metre(Above 18GHz the distance is 1 meter and table is 1.5 metre).
- h. Test the EUT in the lowest channel ,the middle channel ,the Highest channel.

Note:

Both horizontal and vertical antenna polarities were tested and performed pretest to three orthogonal axis. The worst case emissions were reported.

7.3 EUT Operating Conditions

The EUT was configured for testing in a typical fashion (as a customer would normally use it). The EUT has been programmed to continuously transmit during test. This operating condition was tested and used to collect the included data.

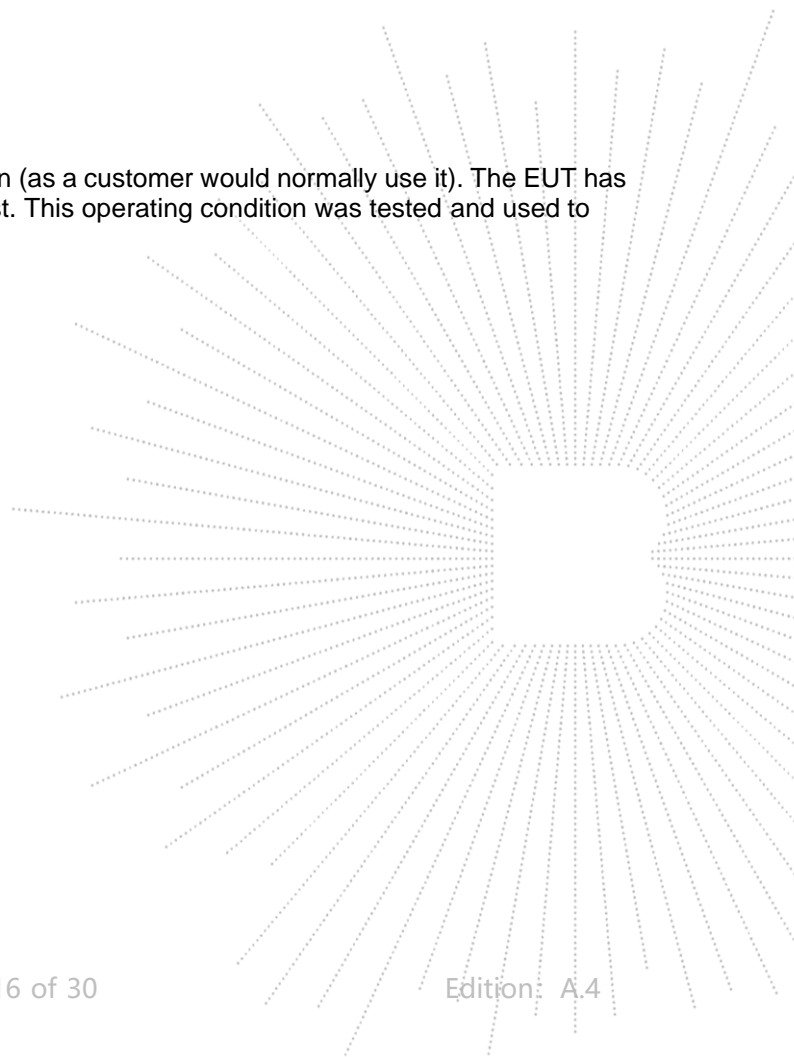

7.4 Test Result

Temperature:	26°C	Relative Humidity:	54%
Pressure:	101 kpa	Test Voltage :	DC 12V
Test Mode :	Mode 1	Polarization:	-

Frequency (MHz)	Meter Reading (dBμV)	Factor (dB)	Emission Level (dBμV/m)	Limits (dBμV/m)	Margin (dB)	Detector Type
0.0731	64.14	20.15	84.29	130.33	-46.04	PK
0.0731	40.34	20.15	60.49	110.33	-49.84	AV
0.2145	52.48	20.33	72.81	120.98	-48.17	PK
0.2145	38.24	20.33	58.57	100.98	-42.41	AV
0.3898	54.01	20.55	74.56	115.79	-41.23	PK
0.3898	47.35	20.55	67.90	95.79	-27.89	AV
0.7486	25.46	20.64	46.10	70.12	-24.02	QP
1.3527	29.80	21.26	51.06	64.98	-13.92	QP
1.6480	18.69	22.32	41.01	63.27	-22.26	QP

Note:

Pre-scan in the all of mode, the worst case in of was recorded.

Factor = antenna factor + cable loss – pre-amplifier.

Margin = Emission Level- Limit.

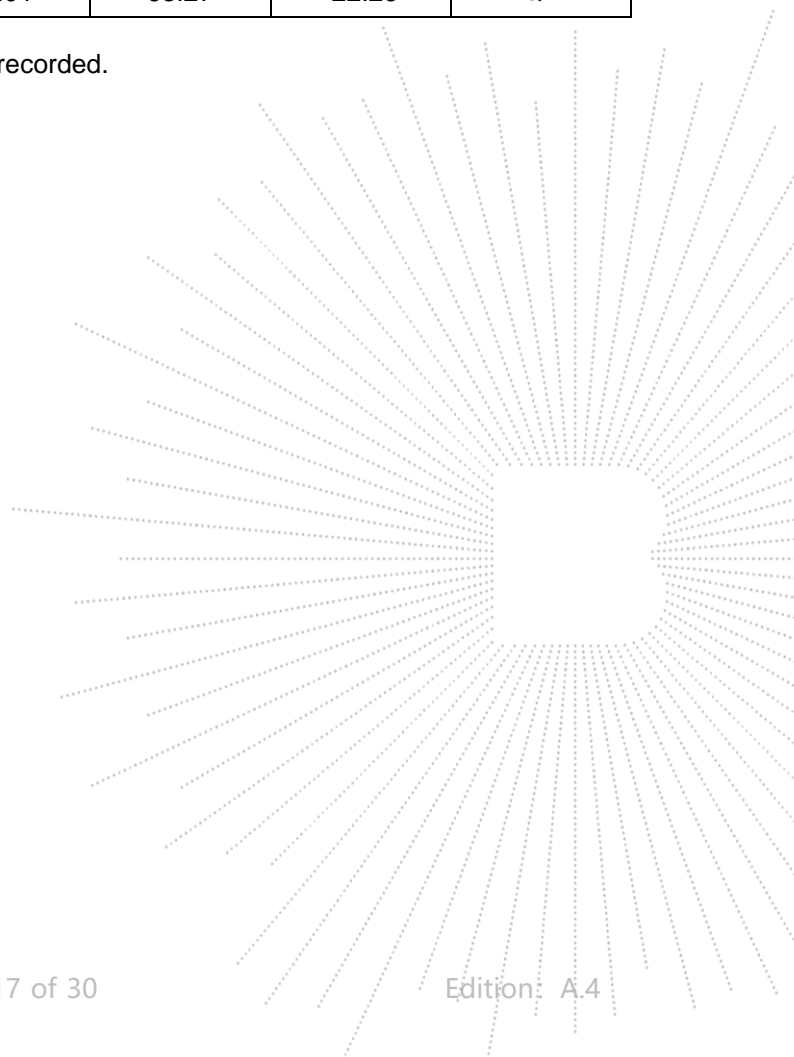

Between 30MHz – 1GHz

Temperature:	26 °C	Relative Humidity:	54%
Pressure:	101KPa	Phase :	Horizontal
Test Mode:	Mode 1	Remark:	N/A

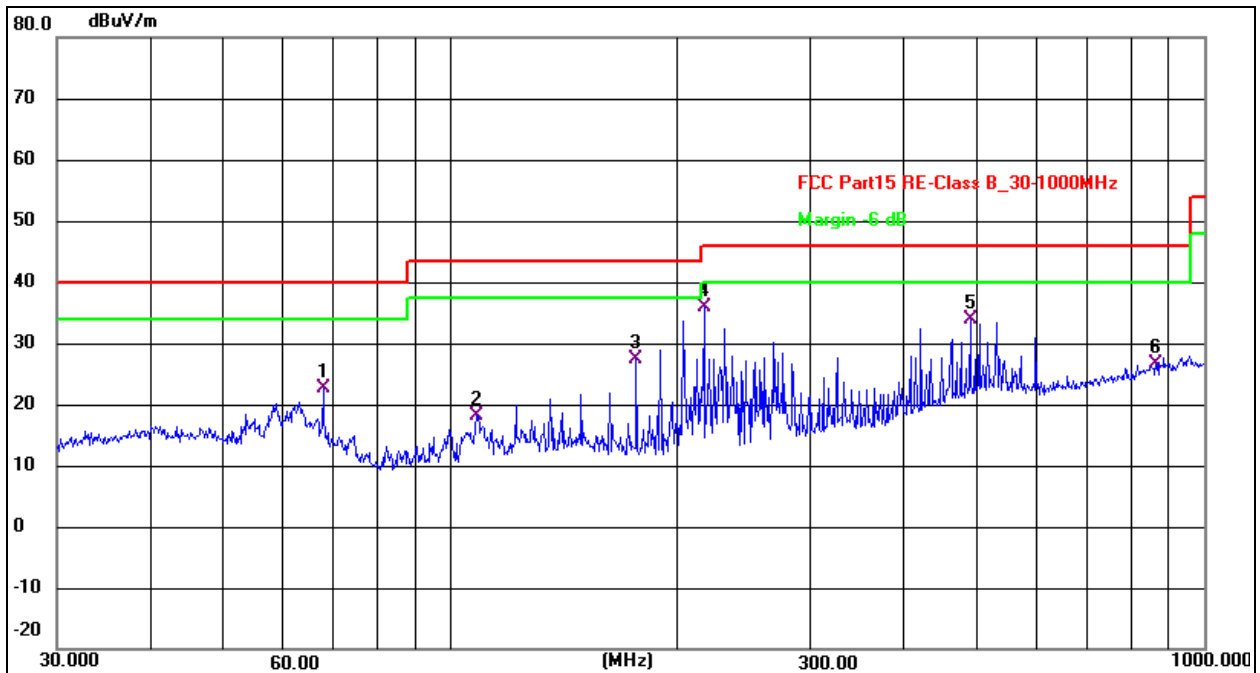

Remark:

1. Factor = Antenna Factor + Cable Loss – Pre-amplifier.
2. Measurement=Reading Level+ Correct Factor
3. Over=Measurement-Limit

No.	Frequency (MHz)	Reading (dBuV)	Factor (dB/m)	Level (dBuV/m)	Limit (dBuV/m)	Margin (dB)	Detector
1	67.6751	35.70	-13.13	22.57	40.00	-17.43	QP
2	108.2664	33.00	-14.91	18.09	43.50	-25.41	QP
3	176.2684	40.82	-13.45	27.37	43.50	-16.13	QP
4 *	216.7828	49.48	-13.52	35.96	46.00	-10.04	QP
5	489.0269	37.51	-3.66	33.85	46.00	-12.15	QP
6	863.0561	25.96	0.74	26.70	46.00	-19.30	QP

Temperature:	26 °C	Relative Humidity:	54%
Pressure:	101KPa	Phase :	Vertical
Test Mode:	Mode 1	Remark:	N/A

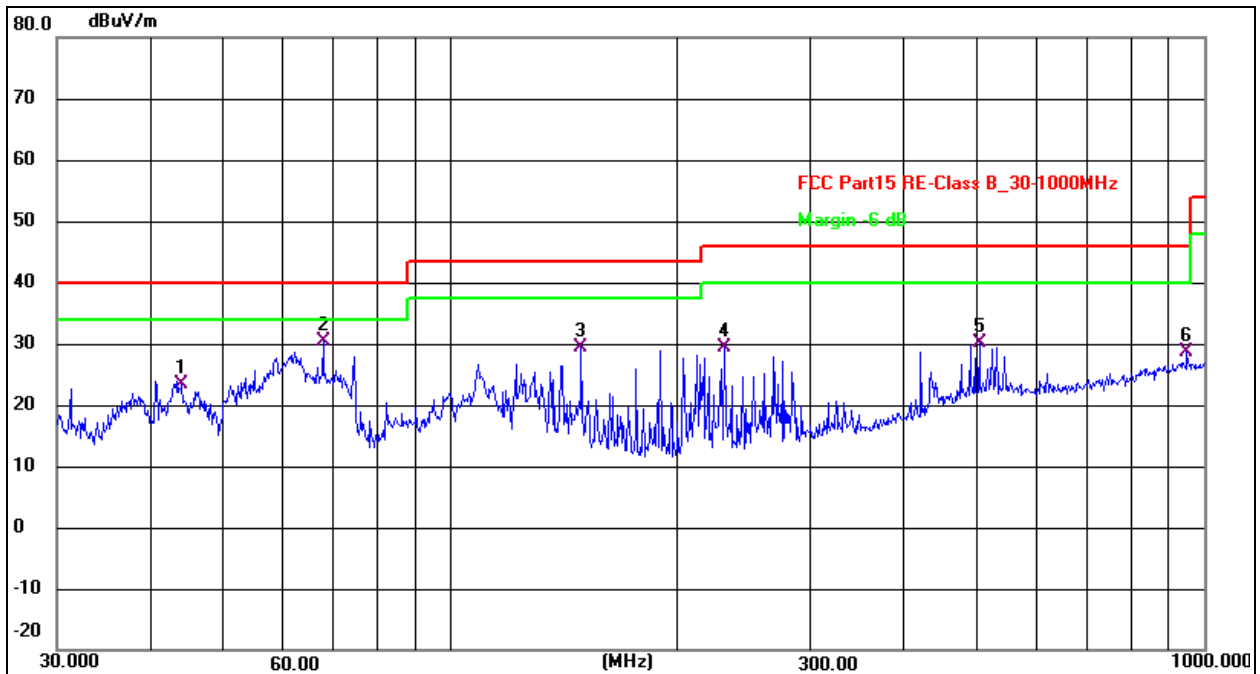

Remark:

1. Factor = Antenna Factor + Cable Loss – Pre-amplifier.
2. Measurement=Reading Level+ Correct Factor
3. Over= Measurement-Limit

No.	Frequency (MHz)	Reading (dBuV)	Factor (dB/m)	Level (dBuV/m)	Limit (dBuV/m)	Margin (dB)	Detector
1	43.9658	34.41	-11.10	23.31	40.00	-16.69	QP
2 *	67.6751	43.44	-13.13	30.31	40.00	-9.69	QP
3	148.9625	42.13	-12.71	29.42	43.50	-14.08	QP
4	230.9067	42.36	-12.97	29.39	46.00	-16.61	QP
5	502.9395	33.31	-3.14	30.17	46.00	-15.83	QP
6	948.7608	26.91	1.71	28.62	46.00	-17.38	QP

8. Radiated Band Emission Measurement

8.1 Block Diagram Of Test Setup

Radiated Emission Test-Up Frequency Below 30MHz

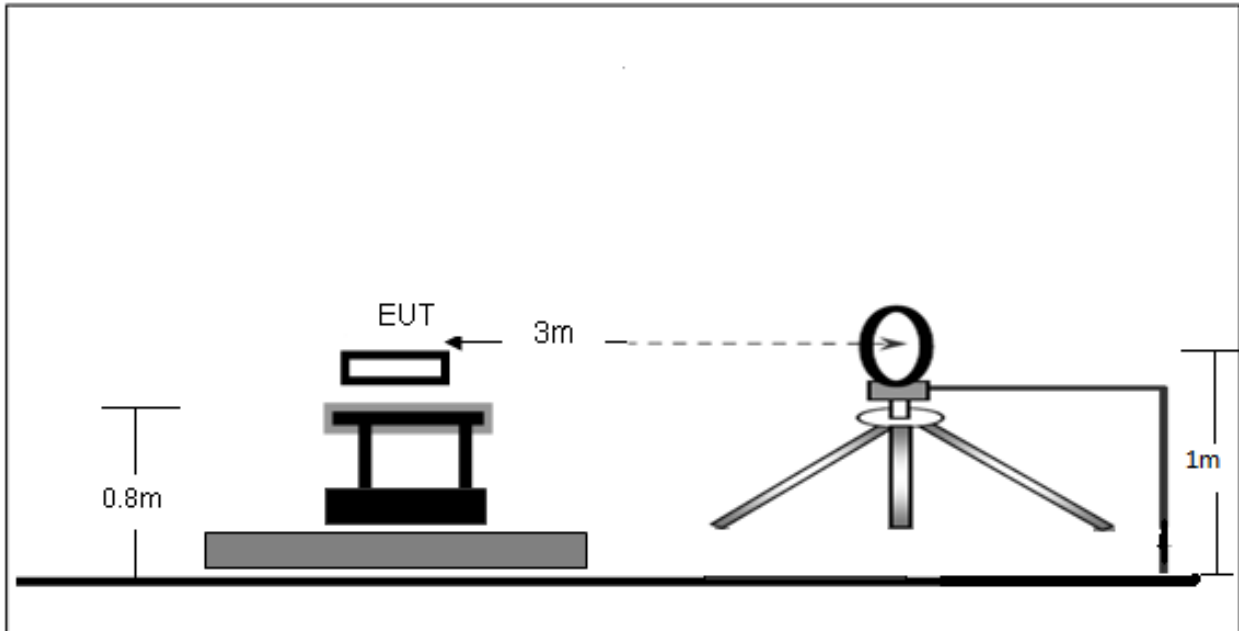

8.2 Limit

FCC Part15 C Section 15.209 and 15.225

LIMITS OF RADIATED EMISSION MEASUREMENT (Below 30MHz)

- 15.848 microvolts/m (84 dB μ V/m) at 30 m, within the band 13.553– 13.567 MHz.
- 334 microvolts/m (50.5 dB μ V/m) at 30 m, within the bands 13.410– 13.553 MHz and 13.567– 13.710 MHz.
- 106 microvolts/m (40.5 dB μ V/m) at 30 m, within the bands 13.110– 13.410 MHz and 13.710– 14.010 MHz.
- 30 microvolts/m (29.5 dB μ V/m) at 30 m, outside the band 13.110– 14.010 MHz.

Notes:

- (1) The limit for radiated test was performed according to FCC PART 15C.
- (2) The tighter limit applies at the band edges.
- (3) Emission level (dB μ V/m)=20log Emission level (uV/m).

8.3 Test Procedure

- a. The Product is placed on a turntable 0.8 meters above the ground in the chamber, 3 meter away from the antenna (loop antenna). The maximum values of the field strength are recorded by adjusting the polarizations of the test antenna and rotating the turntable.
- b. For each suspected emission, the Product was arranged to its worst case and then turn table was turned from 0 degrees to 360 degrees to find the maximum reading.
- c. The test frequency analyzer system was set to Peak Detect (300Hz RBW in 9kHz to 150kHz and 10kHz RBW in 150kHz to 30MHz) Function and Specified Bandwidth with Maximum Hold Mode.

8.4 EUT Operating Conditions

The EUT tested system was configured as the statements of 4.5 Unless otherwise a special operating condition is specified in the follows during the testing.
The report only show the worst antenna Polarity's data.

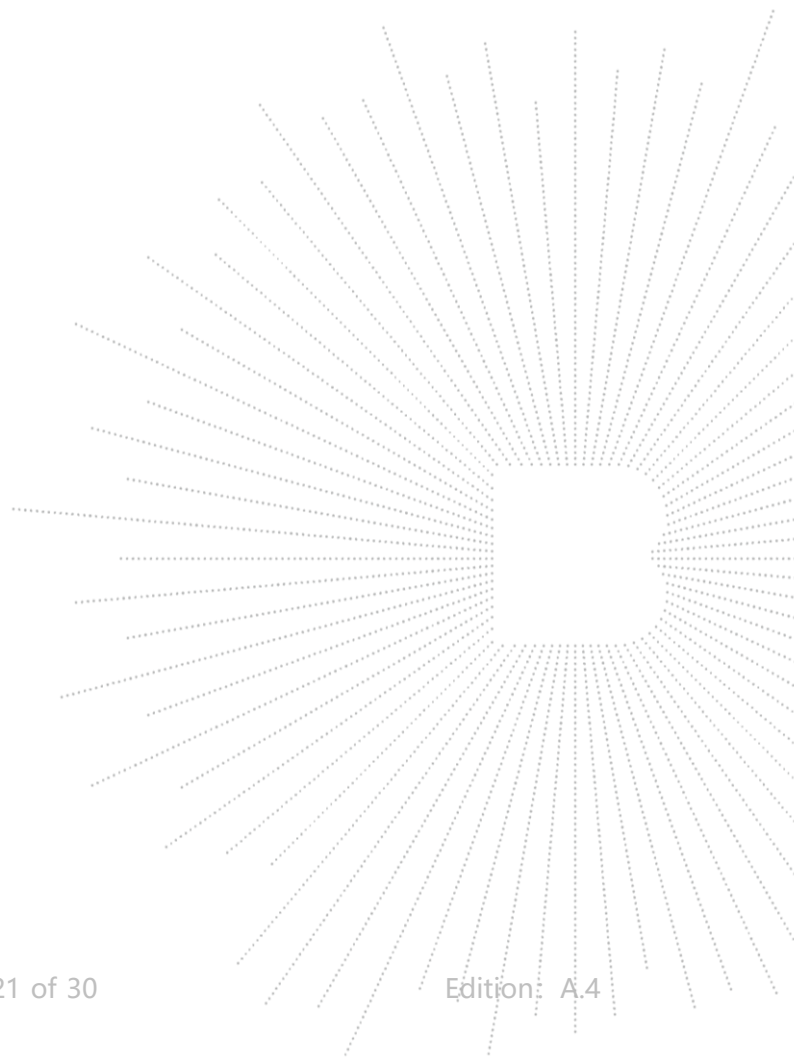

8.5 Test Result

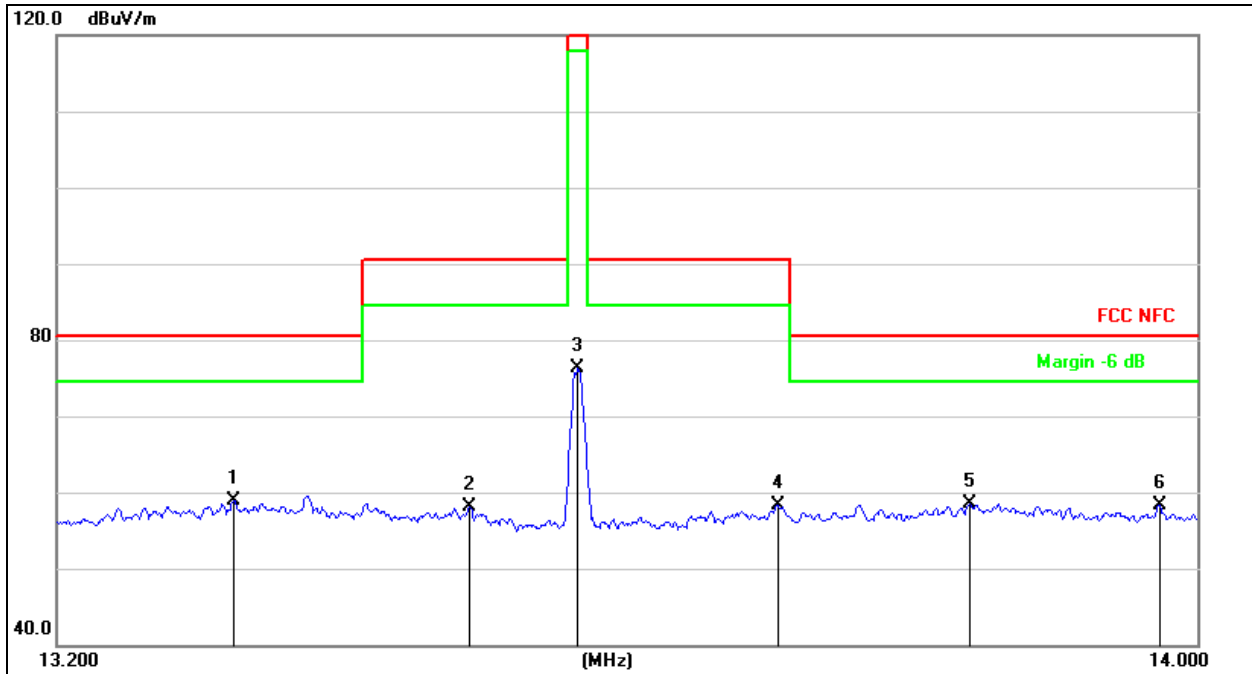

No.	Mk.	Freq. MHz	Reading Level dBuV	Correct Factor dB	Measure- ment dBuV/m	Limit dB/m	Over dB	Detector
1	*	13.3216	38.47	20.43	58.90	80.50	-21.60	peak
2		13.4847	37.60	20.44	58.04	90.50	-32.46	peak
3		13.5600	55.83	20.44	76.27	124.0	-47.73	peak
4		13.7005	37.89	20.45	58.34	90.50	-32.16	peak
5		13.8368	38.08	20.46	58.54	80.50	-21.96	peak
6		13.9725	37.91	20.47	58.38	80.50	-22.12	peak

9. Bandwidth Test

9.1 Block Diagram Of Test Setup

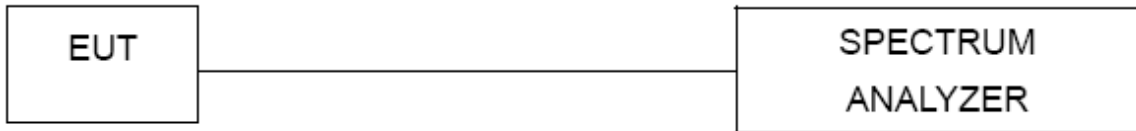

9.2 Test Procedure

FCC Part15 (15.215)	
Section	Test Item
15.215	Bandwidth

1. Set RBW = 1% to 5% of the OBW
2. Set the video bandwidth (VBW) \geq RBW.
3. Detector = Peak.
4. Trace mode = max hold.
5. Sweep = auto couple.
6. Allow the trace to stabilize.
7. Measure the maximum width of the emission that is constrained by the frequencies associated with the two outermost amplitude points (upper and lower frequencies) that are attenuated by 20 dB relative to the maximum level measured in the fundamental emission.

9.3 EUT Operation Conditions

The EUT tested system was configured as the statements of 4.2 Unless otherwise a special operating condition is specified in the follows during the testing.

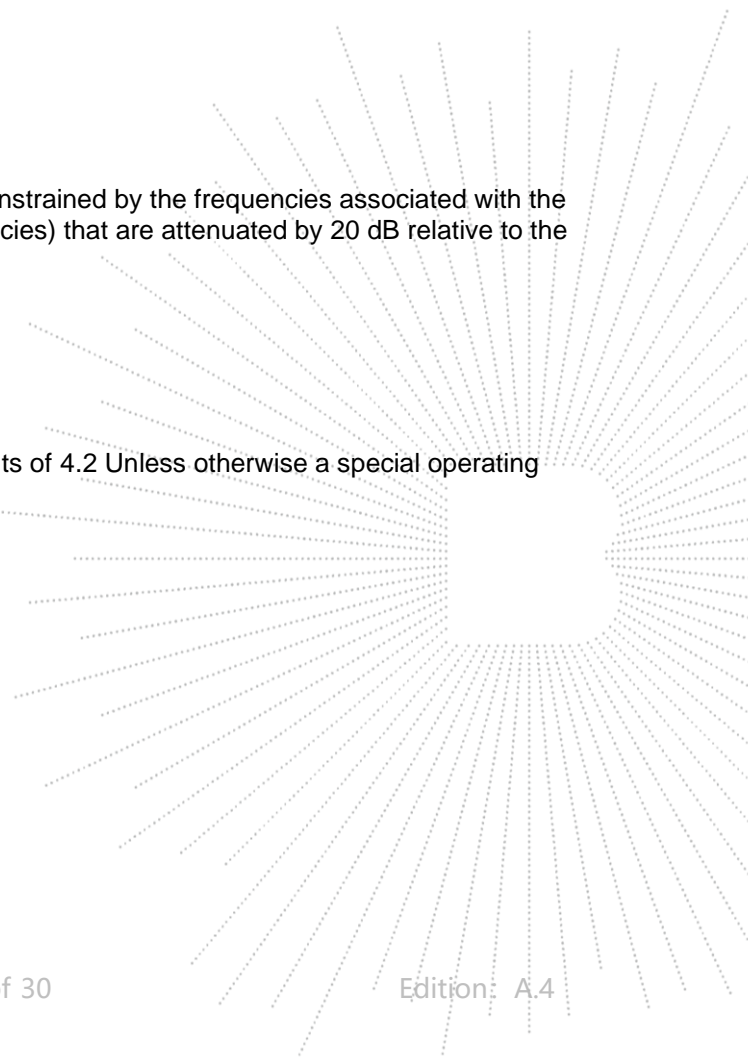

9.4 Test Result

Temperature :	26°C	Relative Humidity :	54%
Test Mode :	ASK	Test Voltage :	DC 12V

Frequency (MHz)	20dB bandwidth (kHz)
13.56	0.849

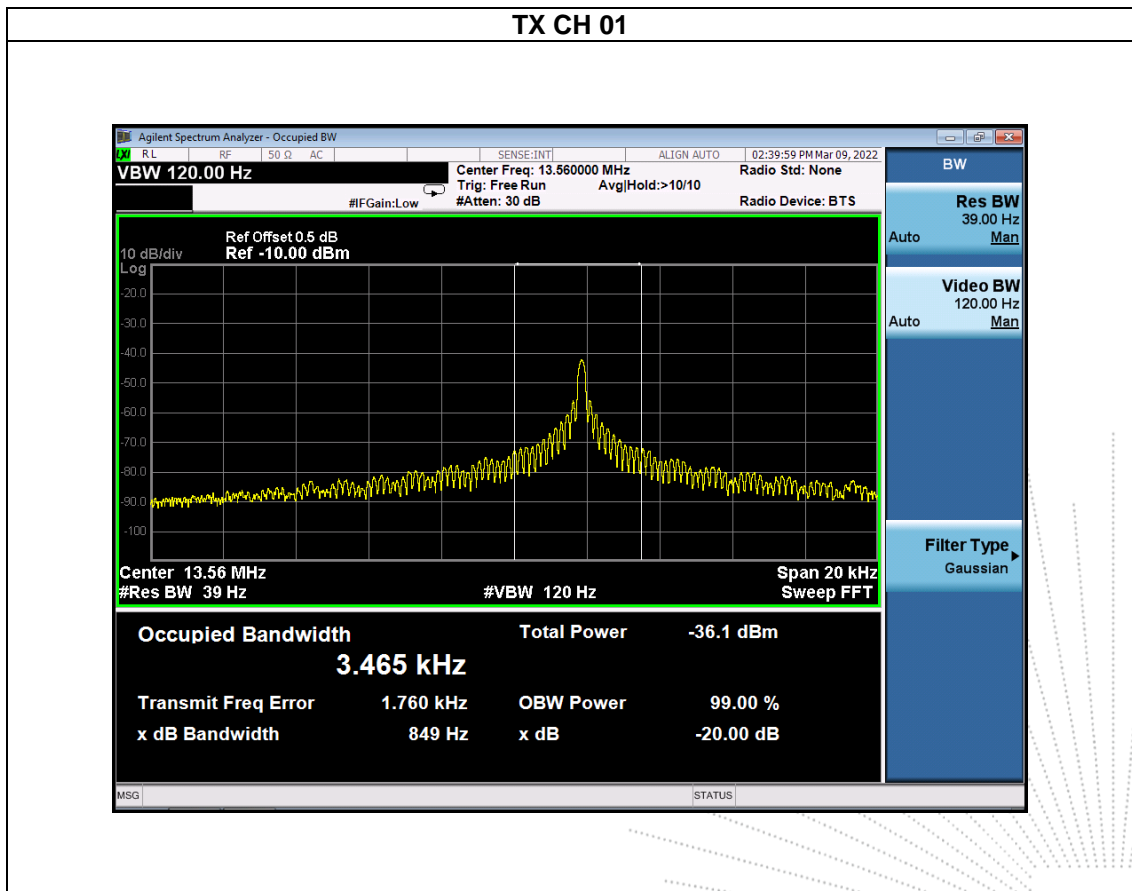

10. Transmitter Frequency Stability

10.1 Block Diagram Of Test Setup



10.2 Limit

The frequency tolerance of the carrier signal shall be maintained within $\pm 0.01\%$ of the operating frequency over a temperature variation of -20 degrees to $+50$ degrees C at normal supply voltage, and for a variation in the primary supply voltage from 85% to 115% of the rated supply voltage at a temperature of 20 degrees C. For battery operated equipment, the equipment tests shall be performed using a new battery.

Limit: $\pm 0.01\%$ of $13.56\text{MHz} = 1356\text{Hz}$

10.3 Test Procedure

1. Set RBW = 10 kHz.
2. Set the video bandwidth (VBW) \geq RBW.
3. Detector = Peak.
4. Trace mode = max hold.
5. Sweep = auto couple.
6. Allow the trace to stabilize.
7. The transmitter output (antenna port) was connected to the spectrum analyzer.

10.4 EUT Operating Conditions

The EUT tested system was configured as the statements of 4.5 Unless otherwise a special operating condition is specified in the follows during the testing.

10.5 Test Result

Temperature :	26°C	Relative Humidity :	54%
Pressure :	101kPa	Test Voltage :	DC 12V
Test Mode :	TX Mode		

Test Conditions			Frequency Deviation		Limit(Hz)	Result
Frequency MHz	Power(Vdc)	Temperature (°C)	Measured Freq.	Frequency Error(Hz)		
13.56	12	-20	13.56002	20	1356	PASS
	12	-10	13.56003	30	1356	
	12	0	13.56007	70	1356	
	12	10	13.56009	90	1356	
	12	20	13.56014	140	1356	
	12	30	13.56005	50	1356	
	12	40	13.56001	10	1356	
	12	50	13.56008	80	1356	
	10.2	20	13.56004	40	1356	
	13.8	20	13.56007	70	1356	

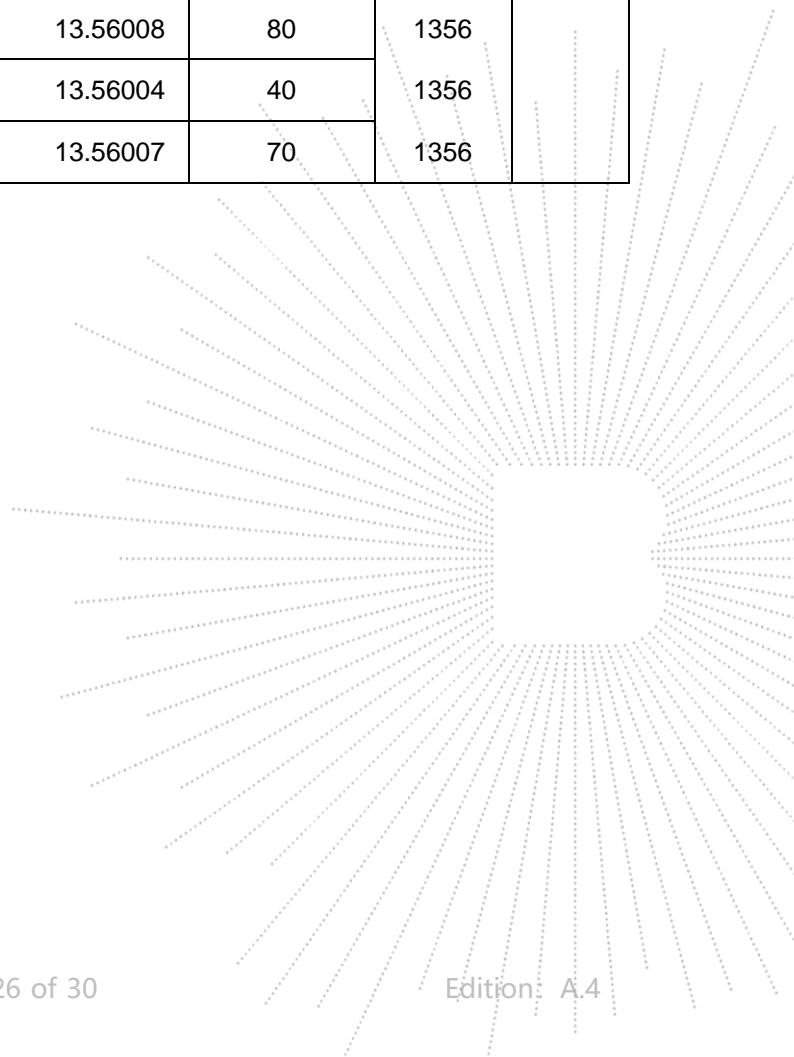

11. Antenna Requirement

11.1 Standard Requirement

15.203 requirement: For intentional device, according to 15.203: an intentional radiator shall be designed to ensure that no antenna other than that furnished by the responsible party shall be used with the device.

11.2 EUT Antenna

The EUT antenna is Coil Antenna, It comply with the standard requirement.

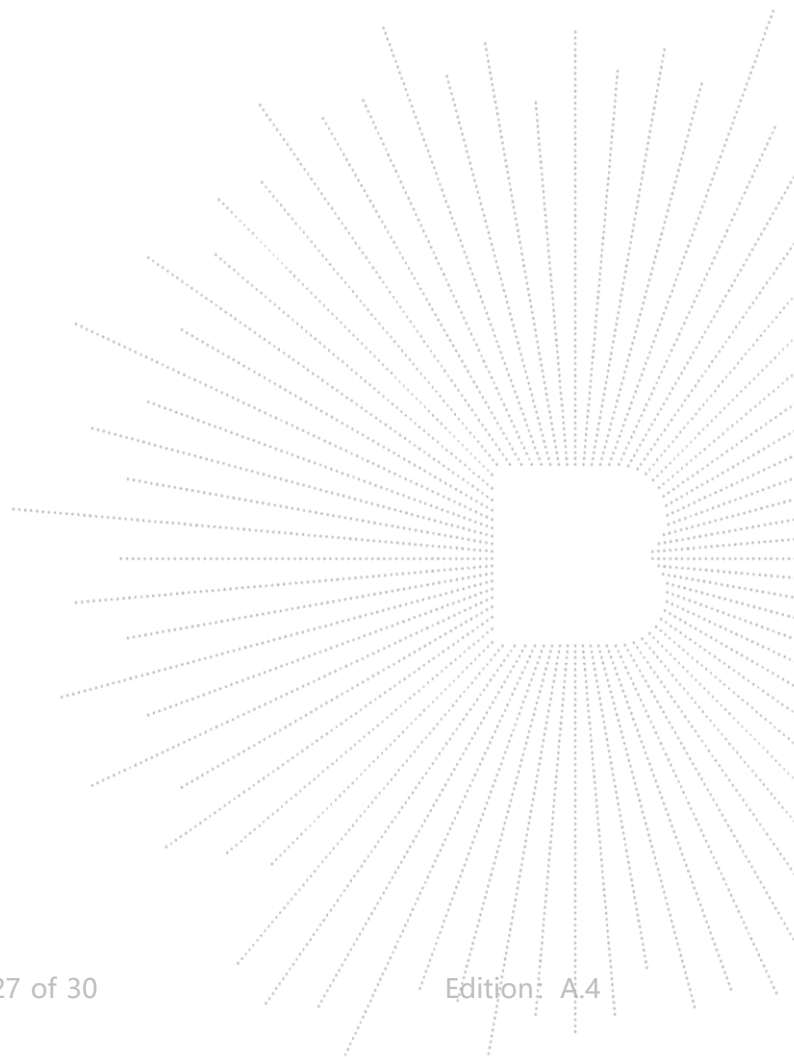

12. EUT Photographs

EUT Photo 1



EUT Photo 2

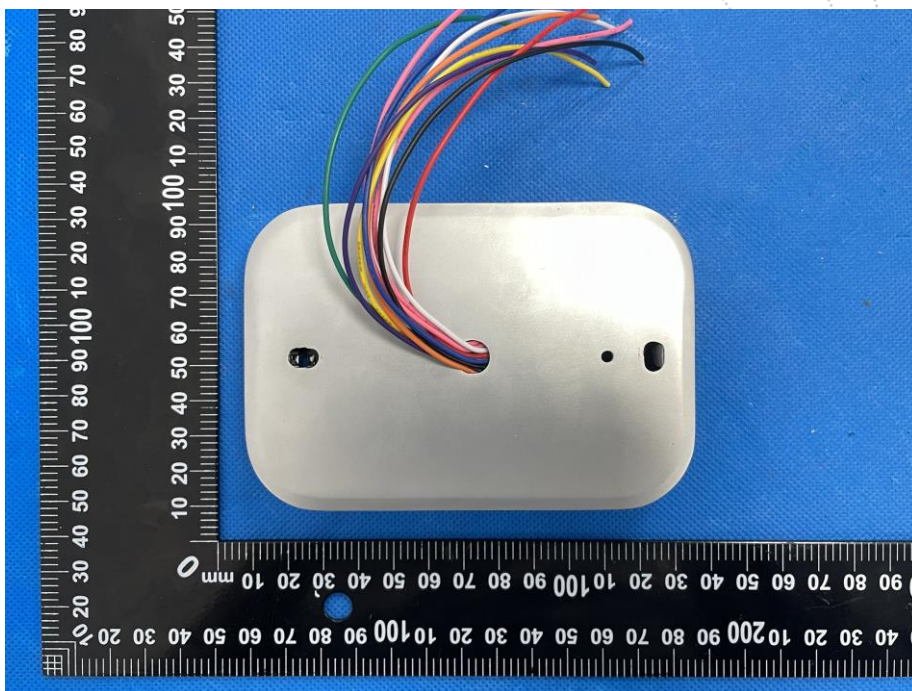

13. EUT Test Setup Photographs

Radiated Measurement Photos

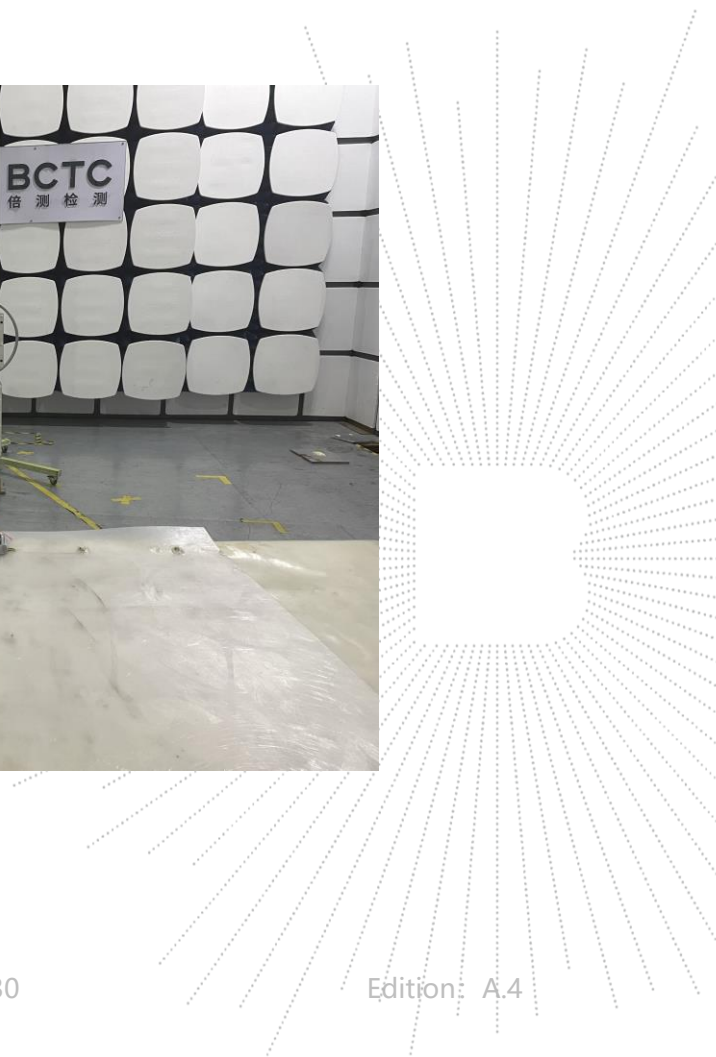
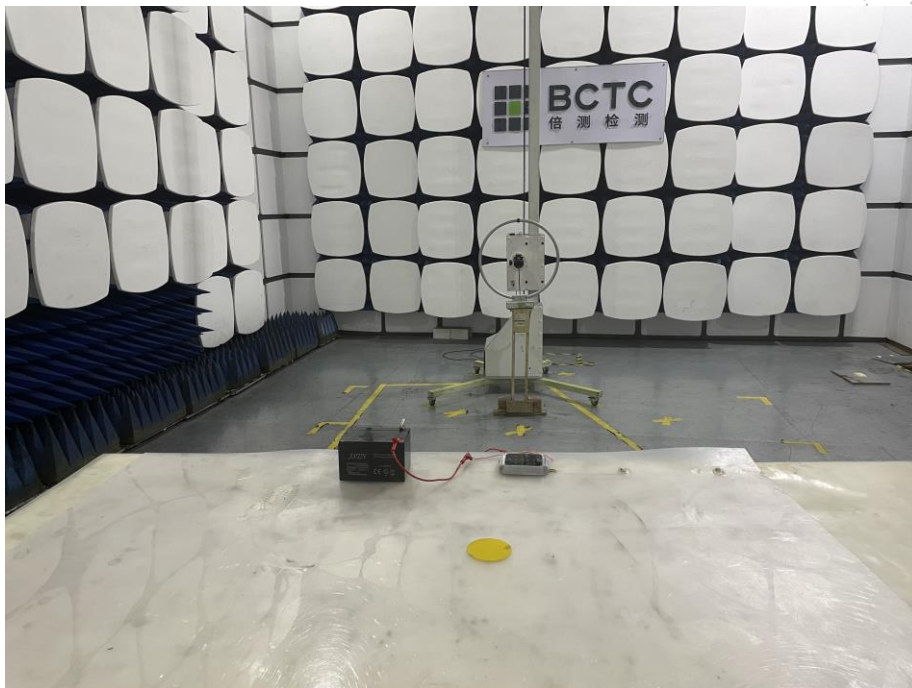
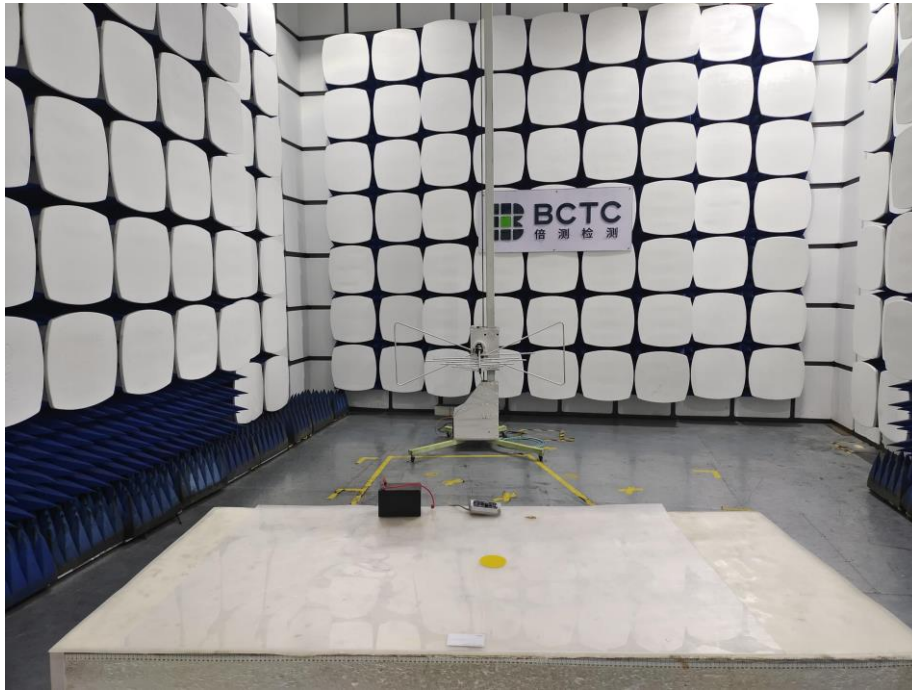

STATEMENT

- 1.The equipment lists are traceable to the national reference standards.
- 2.The test report can not be partially copied unless prior written approval is issued from our lab.
- 3.The test report is invalid without stamp of laboratory.
- 4.The test report is invalid without signature of person(s) testing and authorizing.
- 5.The test process and test result is only related to the Unit Under Test.
- 6.The quality system of our laboratory is in accordance with ISO/IEC17025.
- 7.If there is any objection to report, the client should inform issuing laboratory within 15 days from the date of receiving test report.

Address:

1-2/F., Building B, Pengzhou Industrial Park, No.158, Fuyuan 1st Road, Tangwei, Fuhai Subdistrict, Bao'an District, Shenzhen, Guangdong, China

TEL: 400-788-9558

P.C.: 518103

FAX: 0755-33229357

Website: <http://www.chnbctc.com>

E-Mail: bctc@bctc-lab.com.cn

***** END *****

