



TESTING LABORATORY
CERTIFICATE#4323.01



FCC PART 15.247

TEST REPORT

For

Changxing Potek Electronics & Technology Co., Ltd.

No. 289 Nanzhuang Road, Economic Development Zone, ChangXing County, HuZhou City, ZheJiang, China

FCC ID: 2AMV5-SK509-W-1

Report Type: Original Report	Product Type: 2-Outlet Outdoor WIFI Outlets
Test Engineer: Winnie Yang	<i>Winnie Yang</i>
Report Number: RKSA190523003-00A	
Report Date: 2019-07-03 Oscar Ye	
Reviewed By: RF Leader	<i>Oscar Ye</i>
Prepared By: Bay Area Compliance Laboratories Corp. (Kunshan) No.248 Chenghu Road, Kunshan, Jiangsu province, China Tel: +86-0512-86175000 Fax: +86-0512-88934268 www.baclcorp.com.cn	

Note: This test report is prepared for the customer shown above and for the device described herein. It may not be duplicated or used in part without prior written consent from Bay Area Compliance Laboratories Corp. This report is valid only with a valid digital signature. The digital signature may be available only under the Adobe software above version 7.0.

TABLE OF CONTENTS

GENERAL INFORMATION.....4

 PRODUCT DESCRIPTION FOR EQUIPMENT UNDER TEST (EUT)4

 OBJECTIVE4

 RELATED SUBMITTAL(S)/GRANT(S).....4

 TEST METHODOLOGY4

 MEASUREMENT UNCERTAINTY5

 TEST FACILITY5

SYSTEM TEST CONFIGURATION.....6

 DESCRIPTION OF TEST CONFIGURATION6

 EQUIPMENT MODIFICATIONS6

 EUT EXERCISE SOFTWARE6

 SUPPORT EQUIPMENT LIST AND DETAILS9

 EXTERNAL I/O CABLE.....9

 BLOCK DIAGRAM OF TEST SETUP9

SUMMARY OF TEST RESULTS11

TEST EQUIPMENT LIST12

FCC §1.1310 & §2.1091 –MAXIMUM PERMISSIBLE EXPOSURE (MPE)13

FCC §15.203 - ANTENNA REQUIREMENT.....14

 APPLICABLE STANDARD14

 ANTENNA CONNECTOR CONSTRUCTION14

FCC §15.207 (a) - AC LINE CONDUCTED EMISSIONS.....15

 APPLICABLE STANDARD15

 EUT SETUP15

 EMI TEST RECEIVER SETUP.....15

 TEST PROCEDURE15

 CORRECTED FACTOR & OVER LIMIT CALCULATION.....16

 TEST RESULTS SUMMARY16

 TEST DATA16

FCC §15.209, §15.205 & §15.247(d) - SPURIOUS EMISSIONS.....19

 APPLICABLE STANDARD19

 EUT SETUP19

 EMI TEST RECEIVER SETUP.....20

 TEST PROCEDURE20

 CORRECTED AMPLITUDE & MARGIN CALCULATION20

 TEST RESULTS SUMMARY20

 TEST DATA21

FCC §15.247(a) (2) - 6 dB EMISSION BANDWIDTH38

 APPLICABLE STANDARD38

 TEST PROCEDURE38

 TEST DATA38

FCC §15.247(b) (3) - MAXIMUM CONDUCTED OUTPUT POWER.....45

 APPLICABLE STANDARD45

 TEST PROCEDURE45

 TEST DATA45

FCC §15.247(d) – 100 kHz BANDWIDTH OF FREQUENCY BAND EDGE.....47

 APPLICABLE STANDARD47

TEST PROCEDURE	47
TEST DATA	47
FCC §15.247(e) - POWER SPECTRAL DENSITY	51
APPLICABLE STANDARD	51
TEST PROCEDURE	51
TEST DATA	51

GENERAL INFORMATION

Product Description for Equipment under Test (EUT)

Applicant:	Changxing Potek Electronics & Technology Co., Ltd.
Tested Model:	SK509-W
Series Model	CCRCWFIO2PK, CURCWFIO2PK, RCWFIO2PK, RCWFIO, LRCWFIO, WMRCWFIO, WCRCWFIO, ORRCWFIO, OSRCWFIO, OSJRCWFIO, HDRCWFIO, MERCWFIO, SK509-W-WP
Model Difference	Model name
Product Type:	2-Outlet Outdoor WIFI Outlets
Dimension:	280mm (L)*70mm (W)*40mm(H)
Power Supply:	AC120V from AC mains

**All measurement and test data in this report was gathered from production sample serial number: 20190523003. (Assigned by the BACL. The EUT supplied by the applicant was received on 2019-05-23.*

Objective

This report is prepared on behalf of *Changxing Potek Electronics & Technology Co., Ltd.* in accordance with Part 2-Subpart J, Part 15-Subparts A and C of the Federal Communication Commissions' rules.

The tests were performed in order to determine Compliant with FCC Part 15, Subpart C, and section 15.203, 15.205, 15.207, 15.209 and 15.247 rules.

Related Submittal(s)/Grant(s)

No related submittal/grant.

Test Methodology

All measurements contained in this report were conducted with ANSI C63.10-2013, American National Standard of Procedures for Compliant Testing of Unlicensed Wireless Devices and FCC 558074 D01 15.247 Meas Guidance v05r02.

All emissions measurement was performed at Bay Area Compliant Laboratories Corp. (Kunshan). The radiated testing was performed at an antenna-to-EUT distance of 3 meters.

Measurement Uncertainty

Item		Uncertainty
AC Power Lines Conducted Emissions		3.19dB
RF conducted test with spectrum		0.9dB
RF Output Power with Power meter		0.5dB
Radiated emission	30MHz~1GHz	6.11dB
	1GHz~6GHz	4.45dB
	6GHz~18GHz	5.23dB
	18GHz~40GHz	5.65dB
Occupied Bandwidth		0.5kHz
Temperature		1.0°C
Humidity		6%

Otherwise required by the applicant or Product Regulations, Decision Rule in this report did not consider the uncertainty.

Test Facility

The test site used by Bay Area Compliance Laboratories Corp. (Kunshan) to collect test data is located on the No.248 Chenghu Road, Kunshan, Jiangsu province, China.

Bay Area Compliance Laboratories Corp. (Kunshan) Lab is accredited to ISO/IEC 17025 by A2LA (Lab code: 4323.01) and the FCC designation No. CN1185 under the FCC KDB 974614 D01 and CAB identifier CN0004 under the ISED requirement. The facility also complies with the radiated and AC line conducted test site criteria set forth in ANSI C63.4-2014.

SYSTEM TEST CONFIGURATION

Description of Test Configuration

Test channel list is as below:

For 802.11b, 802.11g and 802.11n-HT20 mode, EUT was tested with Channel 1, 6 and 11;

Channel	Frequency (MHz)	Channel	Frequency (MHz)
1	2412	7	2442
2	2417	8	2447
3	2422	9	2452
4	2427	10	2457
5	2432	11	2462
6	2437	/	/

Equipment Modifications

No modification was made to the EUT tested.

EUT Exercise Software

RF test tool: ESP32.

Pre-scan with all the data rates, and the worst case was performed as below:

Mode	Data Rate	Power Level
802.11b	1 Mbps	24
802.11g	6 Mbps	28
802.11n-HT20	MCS0	28

Duty Cycle:

802.11b Mode Middle Channel

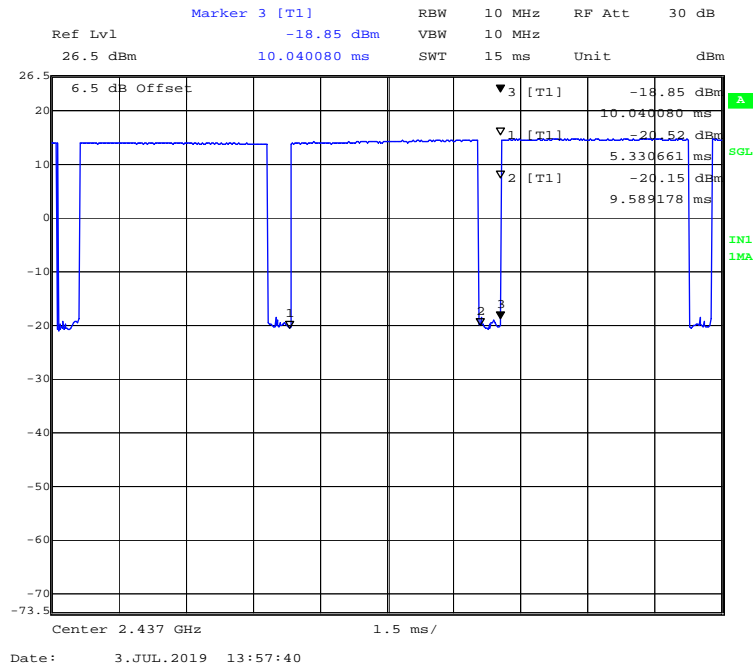

802.11g Mode Middle Channel

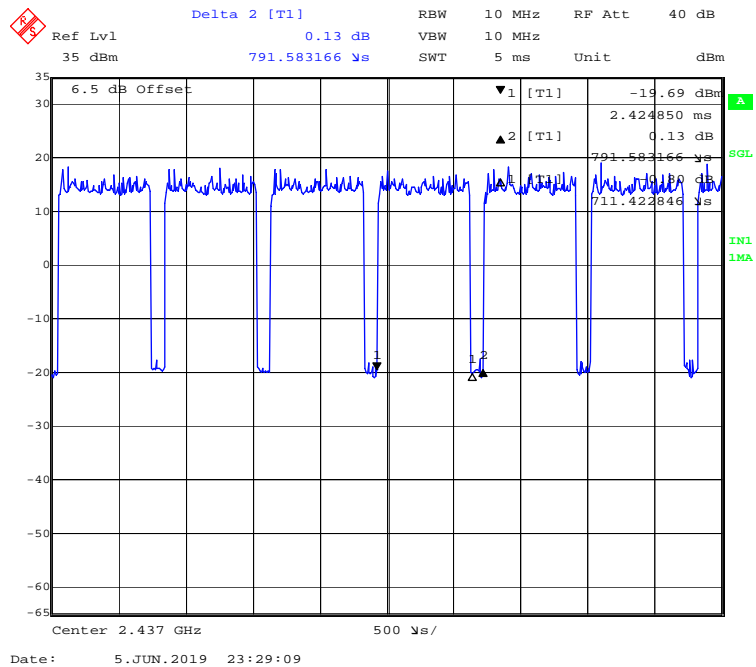

802.11n-HT20 Mode Middle Channel

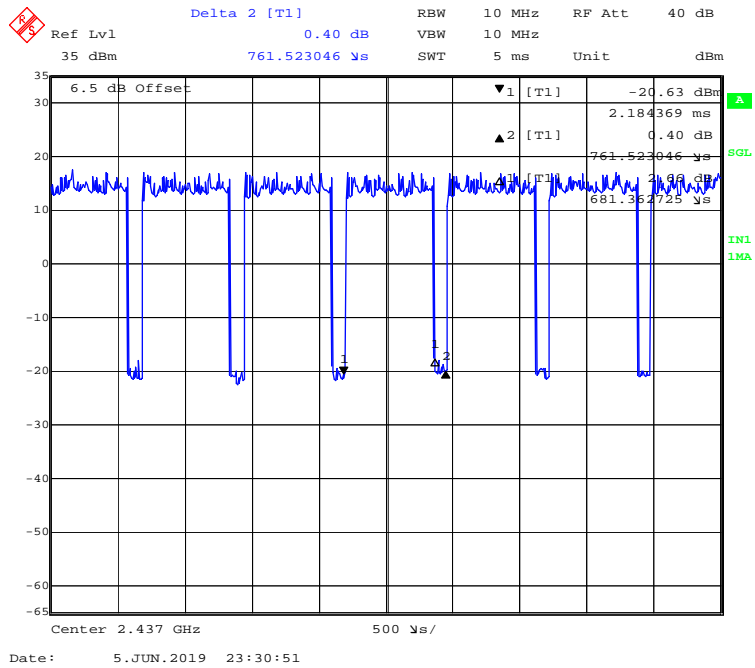

Mode	Duty Cycle (%)	T(ms)	1/T(kHz)	10log(1/x)
802.11b	95.51%	9.589	0.10	0.20
802.11g	89.87%	0.711	1.41	0.46
802.11n-HT20	89.47%	0.681	1.47	0.48

Note: “x” means the Duty Cycle.

Support Equipment List and Details

Manufacturer	Description	Model	Serial Number
/	Converter	/	/
/	Lamp*2	110V-100W	/

External I/O Cable

Cable Description	Length (m)	From Port	To
Power Cable1	0.8	EUT	Lamp
Power Cable2	1.0	EUT	Lamp
Power Cable	1.0	Socket	AC Source

Block Diagram of Test Setup

For Conducted Emissions:

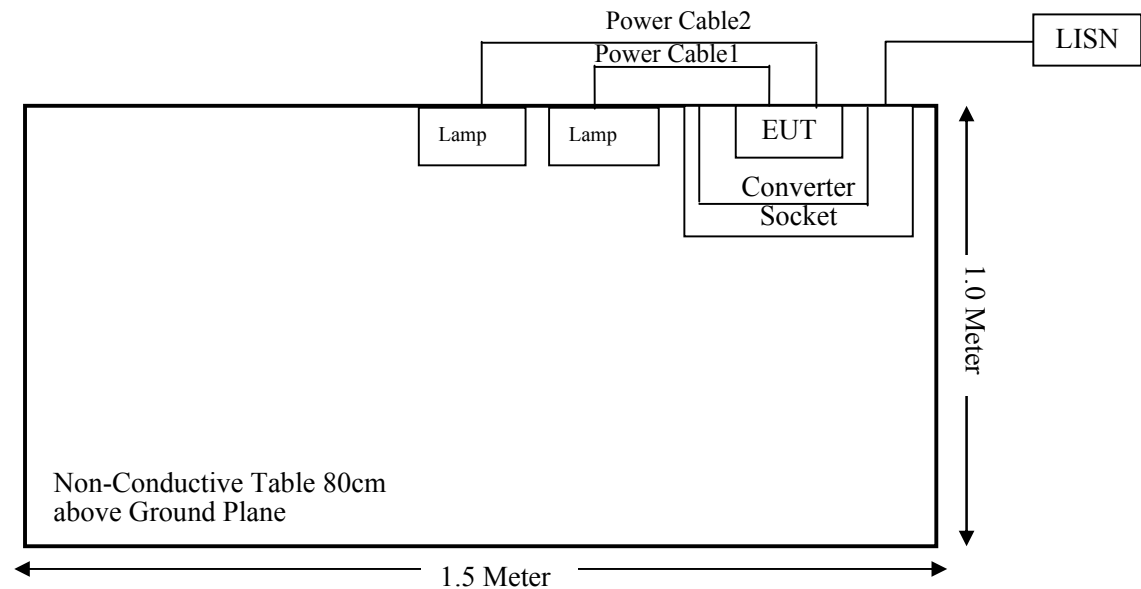

For Radiated Emissions(Below 1GHz):

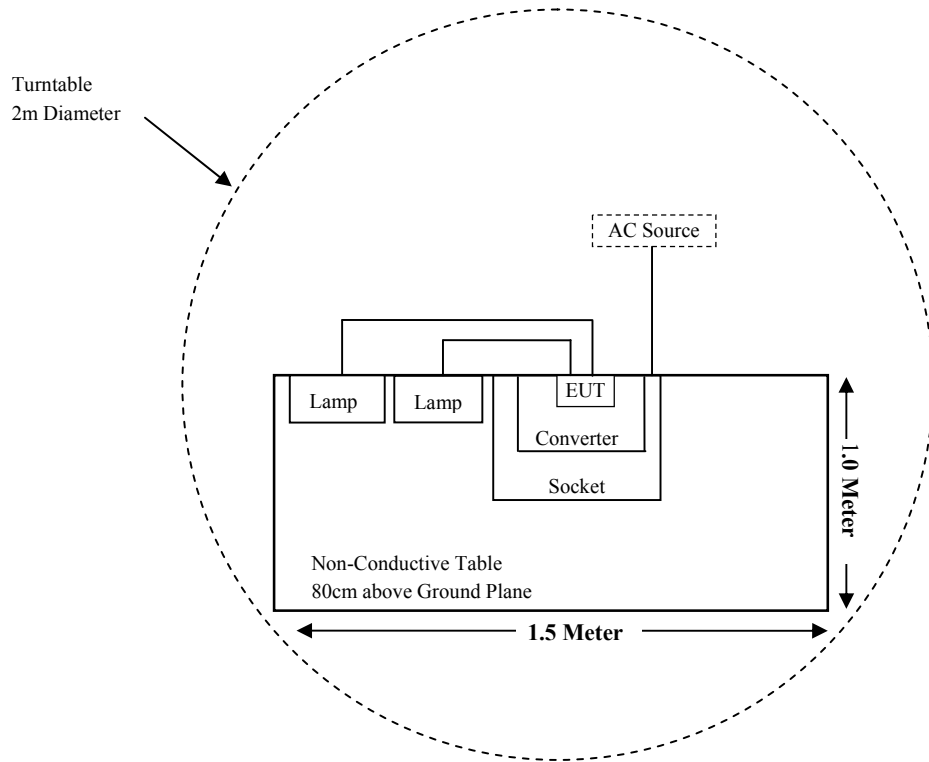

For Radiated Emissions(Above 1GHz):

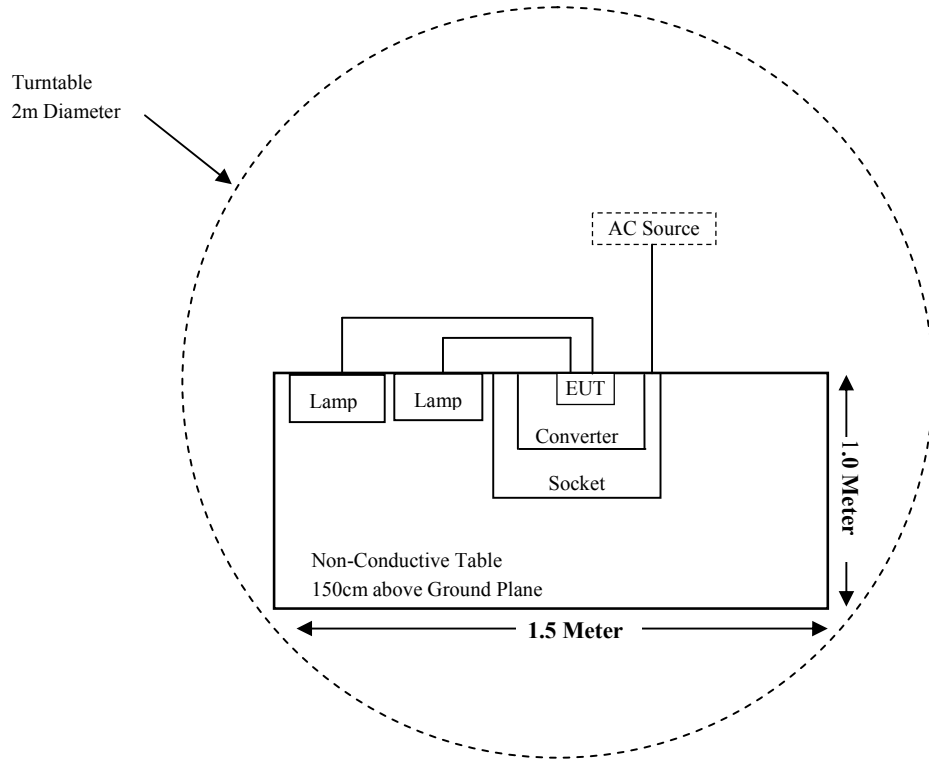

SUMMARY OF TEST RESULTS

FCC Rules	Description of Test	Result
§1.1310 & §2.1091	MAXIMUM PERMISSIBLE EXPOSURE (MPE)	Compliant
§15.203	Antenna Requirement	Compliant
§15.207 (a)	AC Line Conducted Emissions	Compliant
§15.247(d)	Spurious Emissions at Antenna Port	Compliant
§15.205, §15.209, §15.247(d)	Spurious Emissions	Compliant
§15.247 (a)(2)	6 dB Emission Bandwidth	Compliant
§15.247(b)(3)	Maximum Conducted Output Power	Compliant
§15.247(d)	100 kHz Bandwidth of Frequency Band Edge	Compliant
§15.247(e)	Power Spectral Density	Compliant

TEST EQUIPMENT LIST

Manufacturer	Description	Model	Serial Number	Calibration Date	Calibration Due Date
Radiated Emission Test (Chamber 1#)					
Rohde & Schwarz	EMI Test Receiver	ESCI	100195	2018-11-30	2019-11-29
Sunol Sciences	Broadband Antenna	JB3	A090413-1	2016-12-26	2019-12-25
Sonoma Instrument	Pre-amplifier	310N	171205	2018-08-14	2019-08-13
Rohde & Schwarz	Auto test Software	EMC32	100361	N/A	N/A
MICRO-COAX	Coaxial Cable	Cable-8	008	2018-08-15	2019-08-14
MICRO-COAX	Coaxial Cable	Cable-9	009	2018-08-15	2019-08-14
MICRO-COAX	Coaxial Cable	Cable-10	010	2018-08-15	2019-08-14
Radiated Emission Test (Chamber 2#)					
Rohde & Schwarz	Signal Analyzer	FSV40	101116	2018-07-23	2019-07-22
ETS-LINDGREN	Horn Antenna	3115	9207-3900	2017-07-15	2020-07-14
ETS-LINDGREN	Horn Antenna	3116	00084159	2016-12-12	2019-12-11
A.H.Systems, inc	Amplifier	2641-1	491	2019-02-20	2020-02-19
SELECTOR	Amplifier	EM18G40G	060726	2019-03-22	2020-03-21
MICRO-TRONICS	Band Reject Filter	BRM50702	G024	2018-08-05	2019-08-04
Narda	Attenuator	10dB	010	2018-08-15	2019-08-14
Rohde & Schwarz	Auto test Software	EMC32	100361	N/A	N/A
MICRO-COAX	Coaxial Cable	Cable-6	006	2018-08-15	2019-08-14
MICRO-COAX	Coaxial Cable	Cable-11	011	2018-08-15	2019-08-14
MICRO-COAX	Coaxial Cable	Cable-12	012	2018-08-15	2019-08-14
MICRO-COAX	Coaxial Cable	Cable-13	013	2018-08-15	2019-08-14
RF Conducted Test					
Rohde & Schwarz	Signal Analyzer	FSIQ26	836131/009	2018-11-30	2019-11-29
Agilent	Power Meter	N1912A	MY5000492	2018-11-18	2019-11-17
Agilent	Power Sensor	N1921A	MY54210024	2018-11-18	2019-11-17
Narda	Attenuator/6dB	6dB	006	2019-01-10	2020-01-09
Changxing Potek	RF Cable	Potek C01	C01	Each Time	N/A
Conducted Emission Test					
Rohde & Schwarz	EMI Test Receiver	ESR	1316.3003K03-102454-Qd	2018-06-25	2019-06-24
Rohde & Schwarz	LISN	ENV216	3560655016	2018-11-30	2019-11-29
Audix	Test Software	e3	V9	N/A	N/A
Narda	Attenuator/6dB	10690812-2	26850-6	2019-01-10	2020-01-09
MICRO-COAX	Coaxial Cable	Cable-15	015	2018-08-15	2019-08-14

* **Statement of Traceability:** Bay Area Compliance Laboratories Corp. (Kunshan) attests that all calibrations have been performed in accordance to requirements that traceable to National Primary Standards and International System of Units (SI).

FCC §1.1310 & §2.1091 –MAXIMUM PERMISSIBLE EXPOSURE (MPE)

Applicable Standard

According to subpart §2.1091 and subpart §1.1310, systems operating under the provisions of this section shall be operated in a manner that ensures that the public is not exposed to radio frequency energy level in excess of the Commission’s guidelines.

Limits for Maximum Permissible Exposure (MPE) (§1.1310, §2.1091)

(B) Limits for General Population/Uncontrolled Exposure				
Frequency Range (MHz)	Electric Field Strength (V/m)	Magnetic Field Strength (A/m)	Power Density (mW/cm²)	Averaging Time (minutes)
0.3-1.34	614	1.63	*(100)	30
1.34-30	824/f	2.19/f	*(180/f ²)	30
30-300	27.5	0.073	0.2	30
300-1500	/	/	f/1500	30
1500-100,000	/	/	1.0	30

f = frequency in MHz; * = Plane-wave equivalent power density;

According to §1.1310 and §2.1091 RF exposure is calculated.

Calculated Formulary:

Predication of MPE limit at a given distance

$S = PG/4\pi R^2$ = power density (in appropriate units, e.g. mW/cm²);

P = power input to the antenna (in appropriate units, e.g., mW);

G = power gain of the antenna in the direction of interest relative to an isotropic radiator, the power gain factor, is normally numeric gain;

R = distance to the center of radiation of the antenna (appropriate units, e.g., cm);

Calculated Data:

Mode	Frequency Range (MHz)	Antenna Gain		Tune-up Conducted Power		Evaluation Distance (cm)	Power Density (mW/cm²)	MPE Limit (mW/cm²)
		(dBi)	(numeric)	(dBm)	(mW)			
802.11b	2412~2462	3.0	2.00	14.00	25.12	20	0.0100	1.0
802.11g		3.0	2.00	18.00	63.10	20	0.0251	1.0
802.11n-HT20		3.0	2.00	18.00	63.10	20	0.0251	1.0

Note: The tune-up conducted power was declared by the manufacturer.

Conclusion: The device meets MPE at distance 20cm.

FCC §15.203 - ANTENNA REQUIREMENT

Applicable Standard

According to § 15.203, an intentional radiator shall be designed to ensure that no antenna other than that furnished by the responsible party shall be used with the device. The use of a permanently attached antenna or of an antenna that uses a unique coupling to the intentional radiator shall be considered sufficient to comply with the provisions of this section. The manufacturer may design the unit so that a broken antenna can be replaced by the user, but the user of a standard antenna jack or electrical connector is prohibited. The structure and application of the EUT were analyzed to determine Compliant with section §15.203 of the rules. §15.203 state that the subject device must meet the following criteria:

- a. Antenna must be permanently attached to the unit.
 - b. Antenna must use a unique type of connector to attach to the EUT.
- Unit must be professionally installed, and installer shall be responsible for verifying that the correct antenna is employed with the unit.

And according to FCC 47 CFR section 15.247 (b), if the transmitting antennas of directional gain greater than 6dBi are used, the power shall be reduced by the amount in dB that the directional gain of the antenna exceeds 6 dBi.

Antenna Connector Construction

The EUT has a PCB antenna for Wi-Fi and the antenna gain is 3.0 dBi, which was permanently attached, fulfill the requirement of this section. Please refer to the EUT photos.

Result: Compliant.

FCC §15.207 (a) - AC LINE CONDUCTED EMISSIONS

Applicable Standard

FCC §15.207(a)

EUT Setup

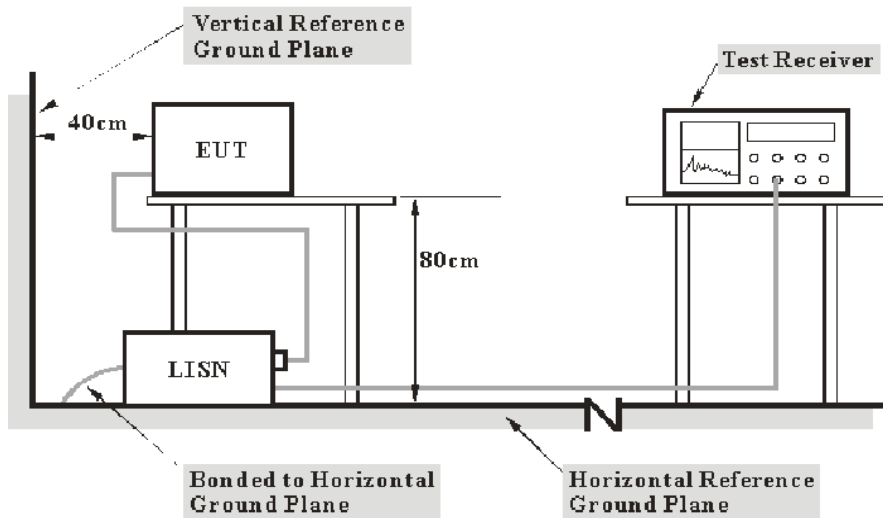

- Note: 1. Support units were connected to second LISN.
 2. Both of LISNs (AMN) 80 cm from EUT and at the least 80 cm from other units and other metal planes support units.

The measurement procedure of EUT setup is according with ANSI C63.10-2013. The related limit was specified in FCC Part 15.207.

The spacing between the peripherals was 10 cm.

EMI Test Receiver Setup

The EMI test receiver was set to investigate the spectrum from 150 kHz to 30 MHz.

During the conducted emission test, the EMI test receiver was set with the following configurations:

Frequency Range	IF B/W
150 kHz – 30 MHz	9 kHz

Test Procedure

ANSI C63.10-2013 clause 6.2

During the conducted emission test, the socket was connected to the outlet of the LISN.

Maximizing procedure was performed on the six (6) highest emissions of the EUT.

All final data was recorded in the Quasi-peak and average detection mode.

Corrected Factor & Over Limit Calculation

The Corrected factor is calculated by adding LISN VDF (Voltage Division Factor), Cable Loss and Transient Limiter Attenuation. The basic equation is as follows:

$$\text{Corrected Factor (dB)} = \text{LISN VDF (dB)} + \text{Cable Loss (dB)} + \text{Transient Limiter Attenuation (dB)}$$

The “**Over Limit**” column of the following data tables indicates the degree of compliance with the applicable limit. For example, an Over Limit of 7 dB means the emission is 7 dB below the limit. The equation for Over Limit calculation is as follows:

$$\text{Over Limit (dB)} = \text{Read level (dB}\mu\text{V)} + \text{Factor (dB)} - \text{Limit (dB}\mu\text{V)}$$

Test Results Summary

According to the recorded data in following table, the EUT complied with the FCC Part 15.207.

Test Data

Environmental Conditions

Temperature:	20.2~24.1 °C
Relative Humidity:	49~51 %
ATM Pressure:	101.1~101.3 kPa

The testing was performed by Winnie Yang from 2019-06-16 to 2019-06-20.

EUT operation mode: Transmitting in 802.11b mode high channel (worst case)

AC 120V/60 Hz, Line

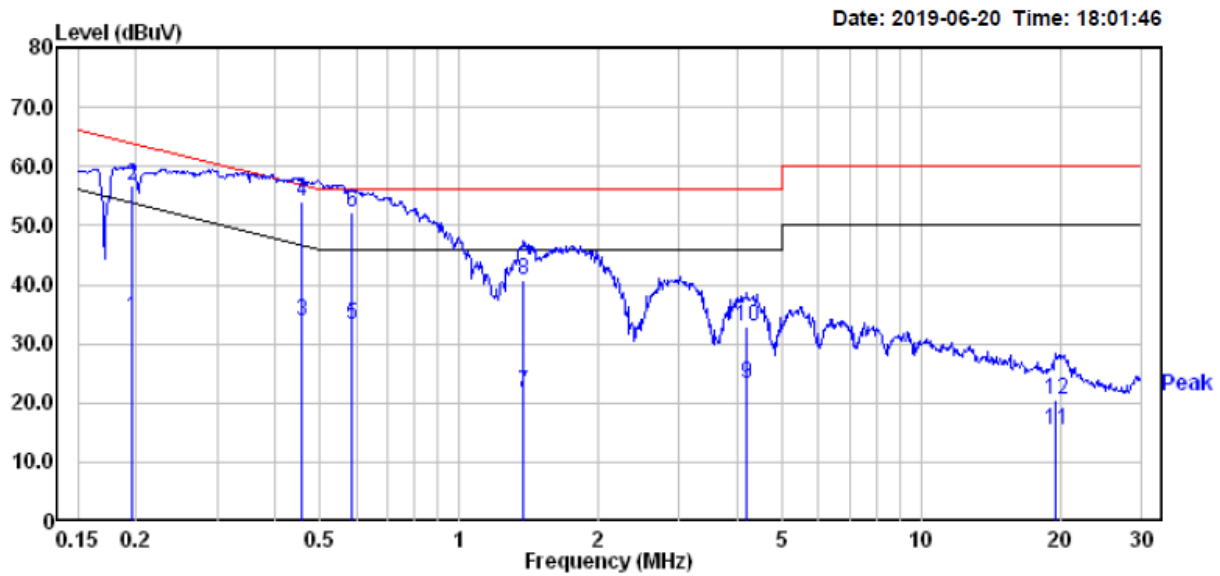

	Read Freq	Read Level	Read Factor	Limit Level	Limit Line	Over Limit	Remark
	MHz	dBuV	dB	dBuV	dBuV	dB	
1	0.197	18.30	16.09	34.39	53.76	-19.37	Average
2	0.197	40.60	16.09	56.69	63.76	-7.07	QP
3	0.459	17.80	16.01	33.81	46.71	-12.90	Average
4	0.459	37.90	16.01	53.91	56.71	-2.80	QP
5	0.589	17.30	16.00	33.30	46.00	-12.70	Average
6	0.589	36.10	16.00	52.10	56.00	-3.90	QP
7	1.381	5.80	16.08	21.88	46.00	-24.12	Average
8	1.381	24.70	16.08	40.78	56.00	-15.22	QP
9	4.202	7.51	15.70	23.21	46.00	-22.79	Average
10	4.202	17.31	15.70	33.01	56.00	-22.99	QP
11	19.635	-0.70	16.11	15.41	50.00	-34.59	Average
12	19.635	4.50	16.11	20.61	60.00	-39.39	QP

AC 120V/60 Hz, Neutral

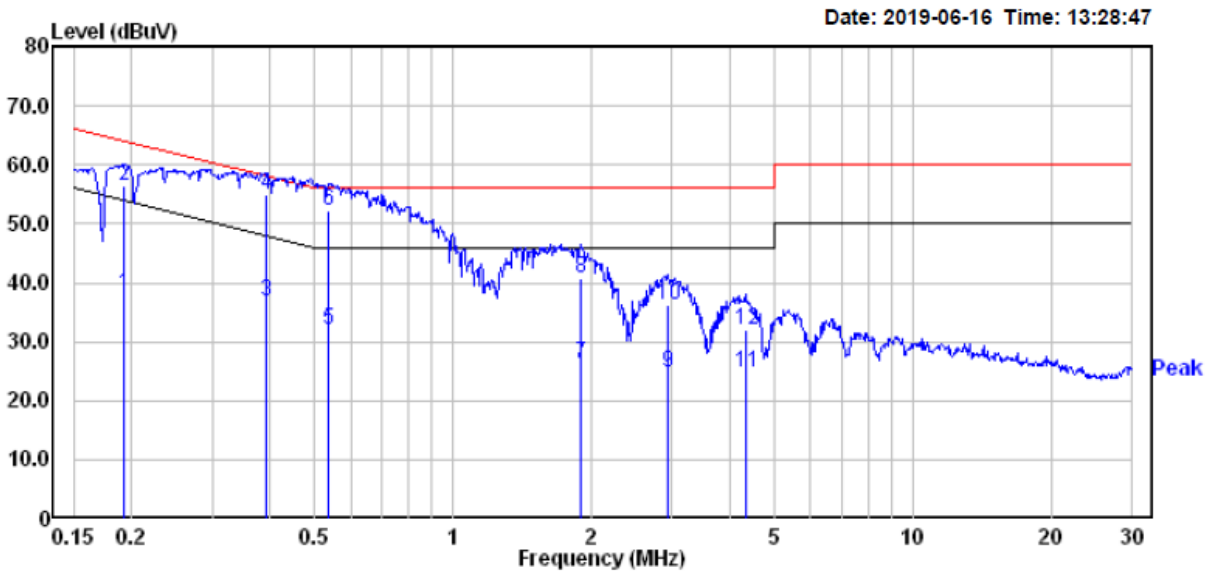

	Read Freq	Read Level	Factor	Level	Limit Line	Over Limit	Remark
	MHz	dBuV	dB	dBuV	dBuV	dB	
1	0.192	21.90	16.09	37.99	53.93	-15.94	Average
2	0.192	40.40	16.09	56.49	63.93	-7.44	QP
3	0.391	20.80	16.01	36.81	48.03	-11.22	Average
4	0.391	38.80	16.01	54.81	58.03	-3.22	QP
5	0.538	16.00	16.01	32.01	46.00	-13.99	Average
6	0.538	36.30	16.01	52.31	56.00	-3.69	QP
7	1.898	10.30	16.07	26.37	46.00	-19.63	Average
8	1.898	24.70	16.07	40.77	56.00	-15.23	QP
9	2.946	9.10	15.70	24.80	46.00	-21.20	Average
10	2.946	20.40	15.70	36.10	56.00	-19.90	QP
11	4.338	9.01	15.70	24.71	46.00	-21.29	Average
12	4.338	16.21	15.70	31.91	56.00	-24.09	QP

Note:

- 1) Factor (dB) = LISN VDF (dB) + Cable Loss (dB) + Transient Limiter Attenuation (dB)
- 2) Over Limit (dB) = Read level (dBuV) + Factor (dB) - Limit (dBuV)

FCC §15.209, §15.205 & §15.247(d) - SPURIOUS EMISSIONS

Applicable Standard

FCC §15.247 (d); §15.209; §15.205;

EUT Setup

Below 1 GHz:

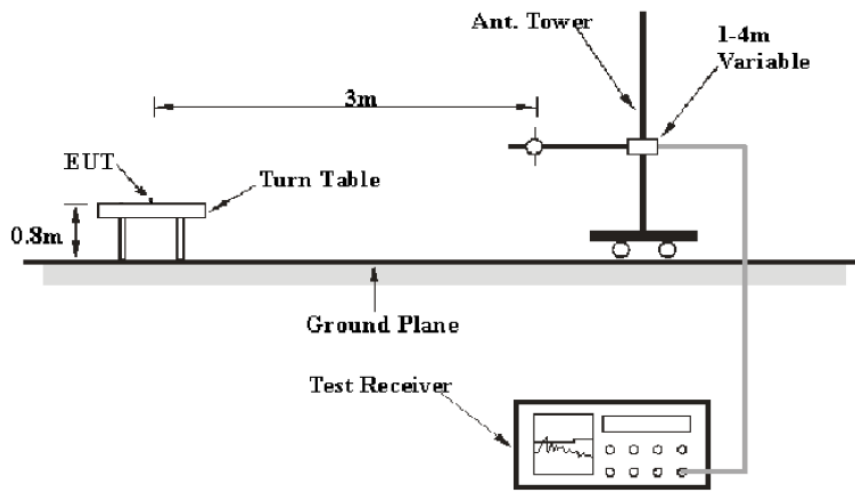

Above 1GHz:

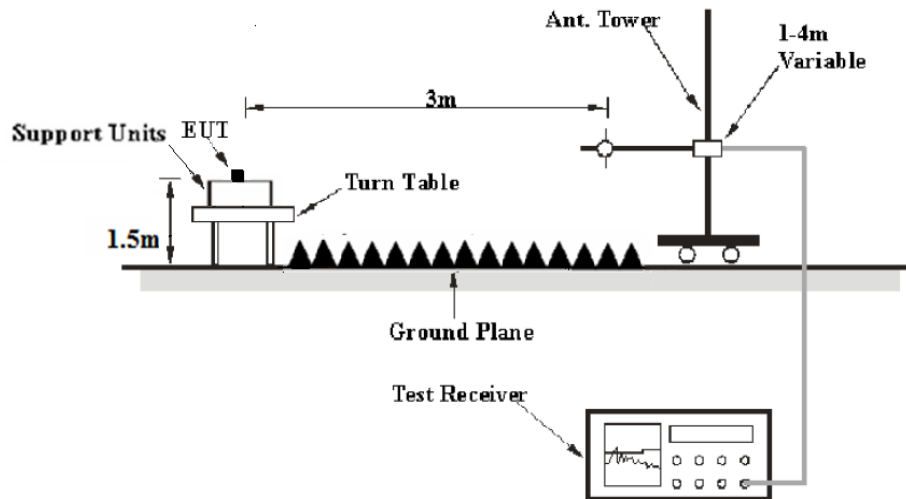

The radiated emission tests were performed in the 3 meters test site, using the setup accordance with the ANSI C63.10-2013. The specification used was the FCC 15.209, and FCC 15.247 limits.

EMI Test Receiver Setup

The system was investigated from 30 MHz to 25 GHz.

During the radiated emission test, the EMI test receiver setup was set with the following configurations:

Frequency Range	RBW	Video B/W	IF B/W	Detector
30 MHz – 1000 MHz	120 kHz	300 kHz	120 kHz	QP
Above 1GHz	1MHz	3 MHz	/	PK
	1MHz	3 MHz	/	Ave.

Test Procedure

According to ANSI C63.10-2013 clause 6.5, 6.6 and 6.7.

Maximizing procedure was performed on the highest emissions to ensure that the EUT complied with all installation combinations.

Data was recorded in Quasi-peak detection mode for frequency range of 30MHz - 1GHz, peak and Average detection mode for frequencies above 1 GHz.

Corrected Amplitude & Margin Calculation

The Corrected Amplitude is calculated by adding the Antenna Factor and Cable Loss, and subtracting the Amplifier Gain from the Meter Reading. The basic equation is as follows:

Corrected Amplitude (dB μ V /m) = Meter Reading (dB μ V) + Antenna Factor (dB/m) + Cable Loss (dB) - Amplifier Gain (dB)

The “**Margin**” column of the following data tables indicates the degree of Compliant with the applicable limit. For example, a margin of 7dB means the emission is 7dB below the limit. The equation for margin calculation is as follows:

Margin (dB) = Limit (dB μ V/m) – Corrected Amplitude (dB μ V /m)

Test Results Summary

According to the recorded data in following table, the EUT complied with the FCC Title 47, Part 15, Subpart C, section 15.205, 15.209 and 15.247.

Test Data

Environmental Conditions

Temperature:	21.6~24.3 °C
Relative Humidity:	48~50 %
ATM Pressure:	101.1~101.3kPa

The testing was performed by Winnie Yang from 2019-06-05 to 2019-07-03.

EUT operation mode: Transmitting

Spurious Emission Test:

30MHz-1GHz:

Pre-scan with 802.11b, 802.11g and 802.11n-HT20 modes of operation in the X,Y and Z axes of orientation, the worst case **high channel of 802.11b mode in Z-axis of orientation** was recorded

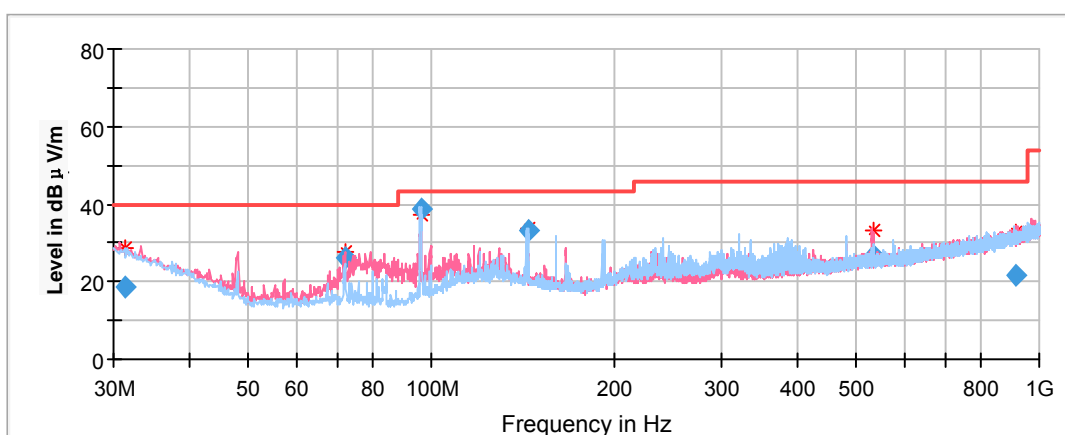

Frequency (MHz)	Corrected Amplitude	Rx Antenna		Turntable Degree	Corrected Factor (dB/m)	Limit (dBµV/m)	Margin (dB)
	QuasiPeak (dBµV/m)	Height (cm)	Polar (H/V)				
31.301062	28.77	200.0	V	165.0	-4.4	40.00	11.23
72.006500	27.68	100.0	V	242.0	-17.4	40.00	12.32
96.248900	37.43	200.0	H	170.0	-15.9	43.50	6.07
144.072550	33.81	200.0	H	190.0	-12.1	43.50	9.69
532.002050	32.98	100.0	V	268.0	-5.8	46.00	13.02
917.257950	32.82	200.0	V	259.0	0.4	46.00	13.18

1GHz-18GHz:

802.11b Mode:

(Pre-scan in the X,Y and Z axes of orientation, the worst case **Z-axis of orientation** was recorded)

Note:

1. This test was performed with the 2.4-2.5GHz notch filter.
2. Corrected Factor (dB/m) = Antenna factor (RX) (dB/m) + Cable Loss (dB) – Amplifier Factor (dB)
 Corrected Amplitude (dBµV /m) = Corrected Factor (dB/m) + Reading (dBµV)
 Margin (dB) = Limit (dBµV/m) – Corrected Amplitude (dBµV /m)

Low Channel: 2412MHz

Full Spectrum

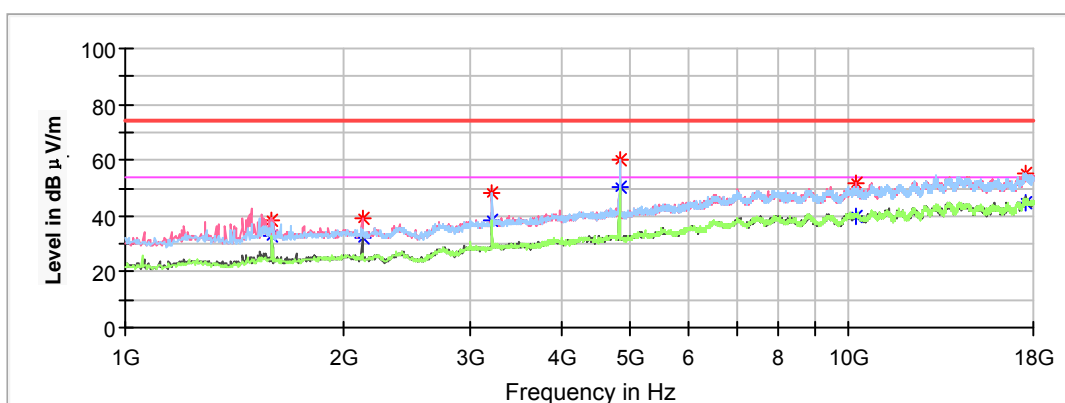

Frequency (MHz)	Corrected Amplitude		Rx Antenna		Turntable Degree	Corrected Factor (dB/m)	Limit (dBµV/m)	Margin (dB)
	MaxPeak (dBµV /m)	Average (dBµV /m)	Height (cm)	Polar (H/V)				
1595.000000	---	28.10	150.0	V	114.0	-9.6	54.00	25.90
1595.000000	36.90	---	150.0	V	114.0	-9.6	74.00	37.10
3213.400000	---	38.22	250.0	V	25.0	-4.0	54.00	15.78
3213.400000	48.50	---	250.0	V	25.0	-4.0	74.00	25.50
4824.000000	---	46.99	150.0	V	33.0	-0.5	54.00	7.01
4824.000000	57.16	---	150.0	V	33.0	-0.5	74.00	16.84
7052.000000	---	38.19	100.0	H	116.0	5.4	54.00	15.81
7052.000000	47.94	---	100.0	H	116.0	5.4	74.00	26.06
9384.400000	---	40.71	250.0	H	234.0	7.7	54.00	13.29
9384.400000	49.57	---	250.0	H	234.0	7.7	74.00	24.43
17833.400000	---	44.58	150.0	H	145.0	13.7	54.00	9.42
17833.400000	54.52	---	150.0	H	145.0	13.7	74.00	19.48

Middle Channel: 2437MHz

Full Spectrum

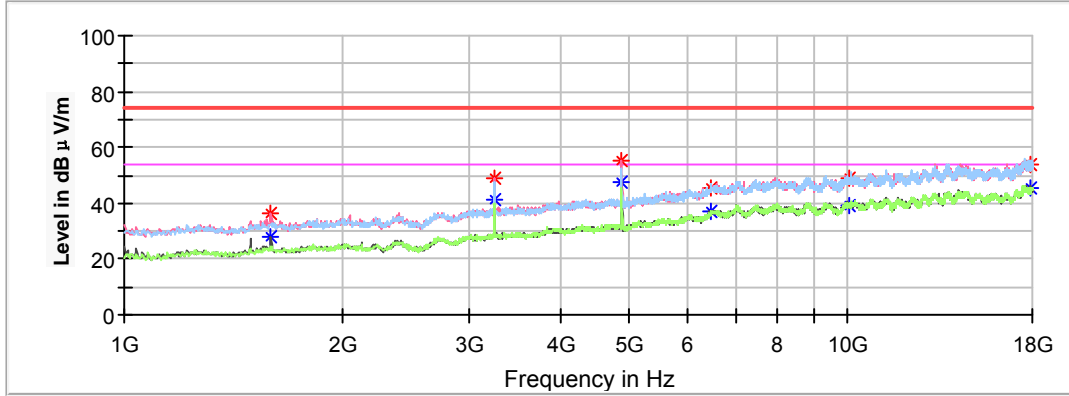

Frequency (MHz)	Corrected Amplitude		Rx Antenna		Turntable Degree	Corrected Factor (dB/m)	Limit (dBμV/m)	Margin (dB)
	MaxPeak (dBμV /m)	Average (dBμV /m)	Height (cm)	Polar (H/V)				
1595.000000	---	28.32	100.0	V	106.0	-9.6	54.00	25.68
1595.000000	36.29	---	100.0	V	106.0	-9.6	74.00	37.71
3247.400000	---	41.56	250.0	V	25.0	-4.0	54.00	12.44
3247.400000	49.25	---	250.0	V	25.0	-4.0	74.00	24.75
4872.600000	---	47.60	150.0	V	44.0	-0.5	54.00	6.40
4872.600000	55.14	---	150.0	V	44.0	-0.5	74.00	18.86
6487.600000	---	36.91	200.0	H	226.0	4.4	54.00	17.09
6487.600000	45.62	---	200.0	H	226.0	4.4	74.00	28.38
10074.600000	---	38.94	150.0	H	244.0	8.3	54.00	15.06
10074.600000	48.64	---	150.0	H	244.0	8.3	74.00	25.36
17887.800000	---	45.60	150.0	H	60.0	13.7	54.00	8.40
17887.800000	54.03	---	150.0	H	60.0	13.7	74.00	19.97

High Channel: 2462MHz

Full Spectrum

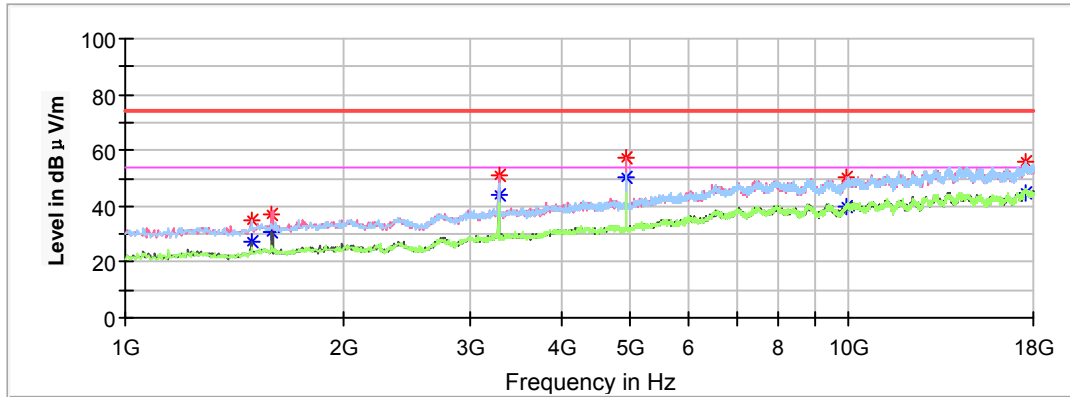

Frequency (MHz)	Corrected Amplitude		Rx Antenna		Turntable Degree	Corrected Factor (dB/m)	Limit (dBμV/m)	Margin (dB)
	MaxPeak (dBμV /m)	Average (dBμV /m)	Height (cm)	Polar (H/V)				
1493.000000	---	27.32	150.0	V	260.0	-10.0	54.00	26.68
1493.000000	35.16	---	150.0	V	260.0	-10.0	74.00	38.84
1591.600000	---	30.92	100.0	V	338.0	-9.6	54.00	23.08
1591.600000	36.95	---	100.0	V	338.0	-9.6	74.00	37.05
3281.400000	---	44.31	150.0	V	213.0	-3.9	54.00	9.69
3281.400000	51.33	---	150.0	V	213.0	-3.9	74.00	22.67
4924.000000	---	50.38	150.0	V	254.0	-0.4	54.00	3.62
4924.000000	57.54	---	150.0	V	254.0	-0.4	74.00	16.46
9948.800000	---	39.97	100.0	V	284.0	8.2	54.00	14.03
9948.800000	50.34	---	100.0	V	284.0	8.2	74.00	23.66
17595.400000	---	44.73	100.0	H	124.0	14.1	54.00	9.27
17595.400000	55.61	---	100.0	H	124.0	14.1	74.00	18.39

802.11g Mode:

(Pre-scan in the X,Y and Z axes of orientation, the worst case Z-axis of orientation was recorded)

Note:

1. This test was performed with the 2.4-2.5GHz notch filter.
2. Corrected Factor (dB/m) = Antenna factor (RX) (dB/m) + Cable Loss (dB) – Amplifier Factor (dB)
 Corrected Amplitude (dBµV /m) = Corrected Factor (dB/m) + Reading (dBµV)
 Margin (dB) = Limit (dBµV/m) – Corrected Amplitude (dBµV /m)

Low Channel: 2412MHz

Full Spectrum

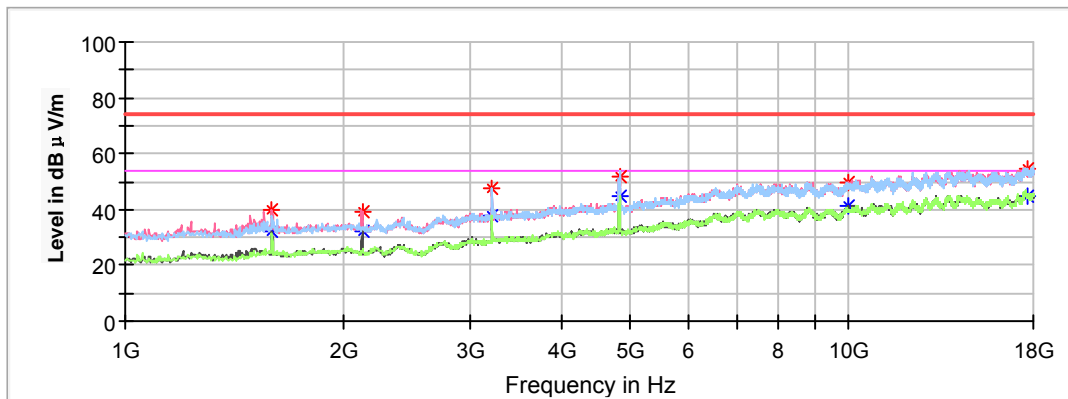

Frequency (MHz)	Corrected Amplitude		Rx Antenna		Turntable Degree	Corrected Factor (dB/m)	Limit (dBµV/m)	Margin (dB)
	MaxPeak (dBµV /m)	Average (dBµV /m)	Height (cm)	Polar (H/V)				
1595.000000	---	32.26	150.0	V	85.0	-9.6	54.00	21.74
1595.000000	40.20	---	150.0	V	85.0	-9.6	74.00	33.80
2128.800000	---	32.32	100.0	V	260.0	-7.9	54.00	21.68
2128.800000	39.20	---	100.0	V	260.0	-7.9	74.00	34.80
3213.400000	---	37.58	150.0	H	216.0	-4.0	54.00	16.42
3213.400000	47.58	---	150.0	H	216.0	-4.0	74.00	26.42
4824.000000	---	44.66	200.0	H	218.0	-0.5	54.00	9.34
4824.000000	52.05	---	200.0	H	218.0	-0.5	74.00	21.95
9996.400000	---	41.07	200.0	V	342.0	8.2	54.00	12.93
9996.400000	49.66	---	200.0	V	342.0	8.2	74.00	24.34
17697.400000	---	45.05	100.0	V	322.0	14.0	54.00	8.95
17697.400000	54.83	---	100.0	V	322.0	14.0	74.00	19.17

Middle Channel: 2437MHz

Full Spectrum

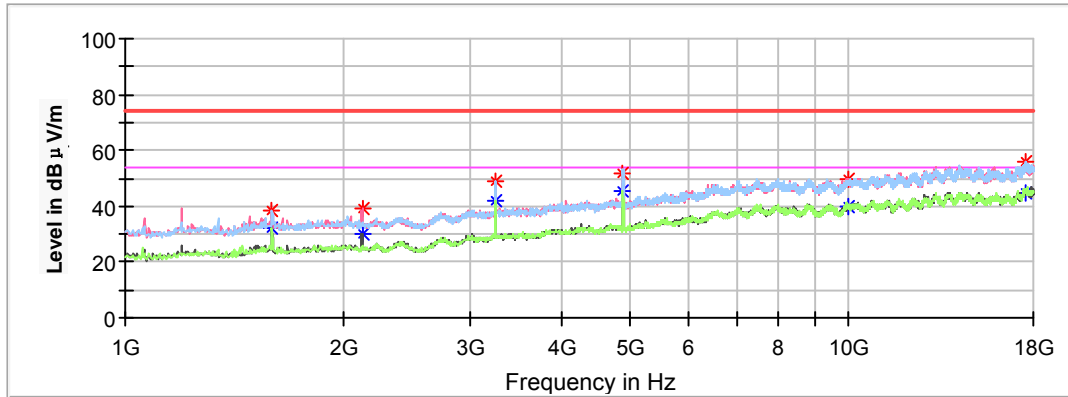

Frequency (MHz)	Corrected Amplitude		Rx Antenna		Turntable Degree	Corrected Factor (dB/m)	Limit (dBµV/m)	Margin (dB)
	MaxPeak (dBµV/m)	Average (dBµV/m)	Height (cm)	Polar (H/V)				
1595.000000	---	32.43	200.0	V	238.0	-9.6	54.00	21.57
1595.000000	38.50	---	200.0	V	238.0	-9.6	74.00	35.50
2128.800000	---	30.25	150.0	V	260.0	-7.9	54.00	23.75
2128.800000	38.97	---	150.0	V	260.0	-7.9	74.00	35.03
3247.400000	---	41.79	200.0	V	169.0	-4.0	54.00	12.21
3247.400000	49.15	---	200.0	V	169.0	-4.0	74.00	24.85
4874.000000	---	45.29	100.0	H	251.0	-0.5	54.00	8.71
4874.000000	52.01	---	100.0	H	251.0	-0.5	74.00	21.99
9999.800000	---	40.05	150.0	V	337.0	8.2	54.00	13.95
9999.800000	49.61	---	150.0	V	337.0	8.2	74.00	24.39
17534.200000	---	45.08	100.0	V	175.0	14.2	54.00	8.92
17534.200000	55.67	---	100.0	V	175.0	14.2	74.00	18.33

High Channel: 2462MHz

Full Spectrum

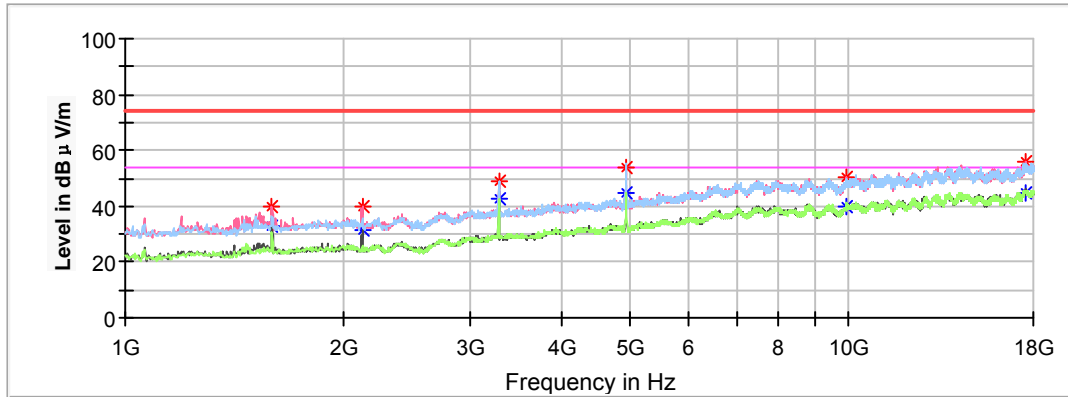

Frequency (MHz)	Corrected Amplitude		Rx Antenna		Turntable Degree	Corrected Factor (dB/m)	Limit (dBμV/m)	Margin (dB)
	MaxPeak (dBμV /m)	Average (dBμV /m)	Height (cm)	Polar (H/V)				
1595.000000	---	32.99	150.0	V	100.0	-9.6	54.00	21.01
1595.000000	39.53	---	150.0	V	100.0	-9.6	74.00	34.47
2128.800000	---	31.80	200.0	V	266.0	-7.9	54.00	22.20
2128.800000	39.84	---	200.0	V	266.0	-7.9	74.00	34.16
3281.400000	---	42.46	200.0	H	309.0	-3.9	54.00	11.54
3281.400000	49.22	---	200.0	H	309.0	-3.9	74.00	24.78
4924.000000	---	44.57	100.0	H	252.0	-0.4	54.00	9.43
4924.000000	54.17	---	100.0	H	252.0	-0.4	74.00	19.83
9938.600000	---	39.75	200.0	V	182.0	8.1	54.00	14.25
9938.600000	50.40	---	200.0	V	182.0	8.1	74.00	23.60
17551.200000	---	44.83	100.0	V	66.0	14.2	54.00	9.17
17551.200000	55.73	---	100.0	V	66.0	14.2	74.00	18.27

802.11n-HT20 Mode:

(Pre-scan in the X,Y and Z axes of orientation, the worst case Z-axis of orientation was recorded)

Note:

1. This test was performed with the 2.4-2.5GHz notch filter.
2. Corrected Factor (dB/m) = Antenna factor (RX) (dB/m) + Cable Loss (dB) – Amplifier Factor (dB)
 Corrected Amplitude (dBµV /m) = Corrected Factor (dB/m) + Reading (dBµV)
 Margin (dB) = Limit (dBµV/m) – Corrected Amplitude (dBµV /m)

Low Channel : 2412MHz

Full Spectrum

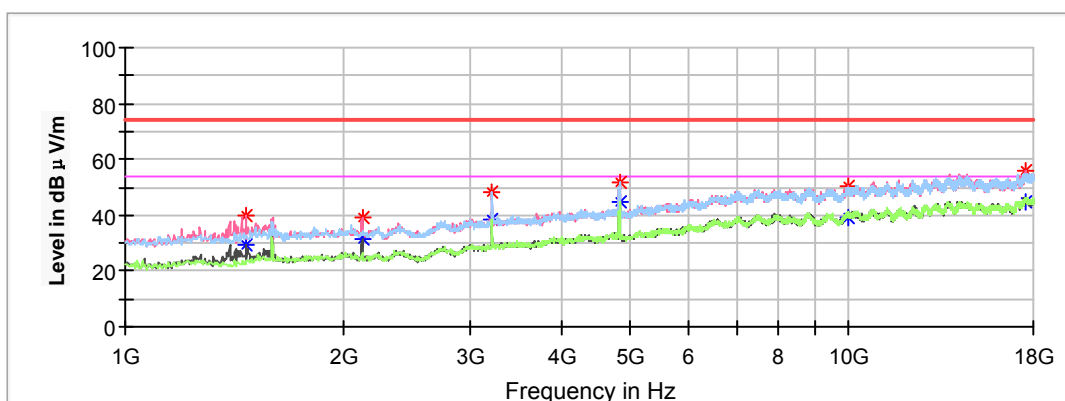

Frequency (MHz)	Corrected Amplitude		Rx Antenna		Turntable Degree	Corrected Factor (dB/m)	Limit (dBµV/m)	Margin (dB)
	MaxPeak (dBµV /m)	Average (dBµV /m)	Height (cm)	Polar (H/V)				
1469.200000	---	29.28	100.0	V	65.0	-10.1	54.00	24.72
1469.200000	39.77	---	100.0	V	65.0	-10.1	74.00	34.23
2125.400000	---	31.16	200.0	V	256.0	-7.9	54.00	22.84
2125.400000	38.83	---	200.0	V	256.0	-7.9	74.00	35.17
3213.400000	---	38.33	100.0	H	267.0	-4.0	54.00	15.67
3213.400000	48.42	---	100.0	H	267.0	-4.0	74.00	25.58
4824.000000	---	44.71	150.0	H	218.0	-0.5	54.00	9.29
4824.000000	51.54	---	150.0	H	218.0	-0.5	74.00	22.46
10010.000000	---	39.35	100.0	V	251.0	8.2	54.00	14.65
10010.000000	50.05	---	100.0	V	251.0	8.2	74.00	23.95
17520.600000	---	44.93	100.0	V	181.0	14.2	54.00	9.07
17520.600000	55.71	---	100.0	V	181.0	14.2	74.00	18.29

Middle Channel: 2437MHz

Full Spectrum

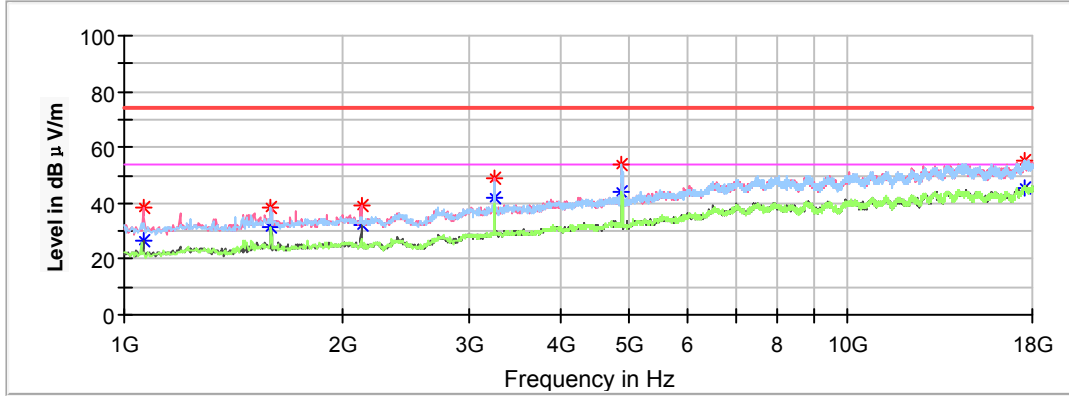

Frequency (MHz)	Corrected Amplitude		Rx Antenna		Turntable Degree	Corrected Factor (dB/m)	Limit (dBμV/m)	Margin (dB)
	MaxPeak (dBμV /m)	Average (dBμV /m)	Height (cm)	Polar (H/V)				
1061.200000	---	26.50	200.0	V	7.0	-12.3	54.00	27.50
1061.200000	38.45	---	200.0	V	7.0	-12.3	74.00	35.55
1595.000000	---	31.64	100.0	V	22.0	-9.6	54.00	22.36
1595.000000	38.77	---	100.0	V	22.0	-9.6	74.00	35.23
2128.800000	---	32.24	150.0	V	296.0	-7.9	54.00	21.76
2128.800000	39.03	---	150.0	V	296.0	-7.9	74.00	34.97
3247.400000	---	41.61	200.0	V	167.0	-4.0	54.00	12.39
3247.400000	48.93	---	200.0	V	167.0	-4.0	74.00	25.07
4874.000000	---	43.93	100.0	H	256.0	-0.5	54.00	10.07
4874.000000	53.61	---	100.0	H	256.0	-0.5	74.00	20.39
17551.200000	---	45.19	200.0	V	187.0	14.2	54.00	8.81
17551.200000	55.40	---	200.0	V	187.0	14.2	74.00	18.60

High Channel : 2462MHz

Full Spectrum

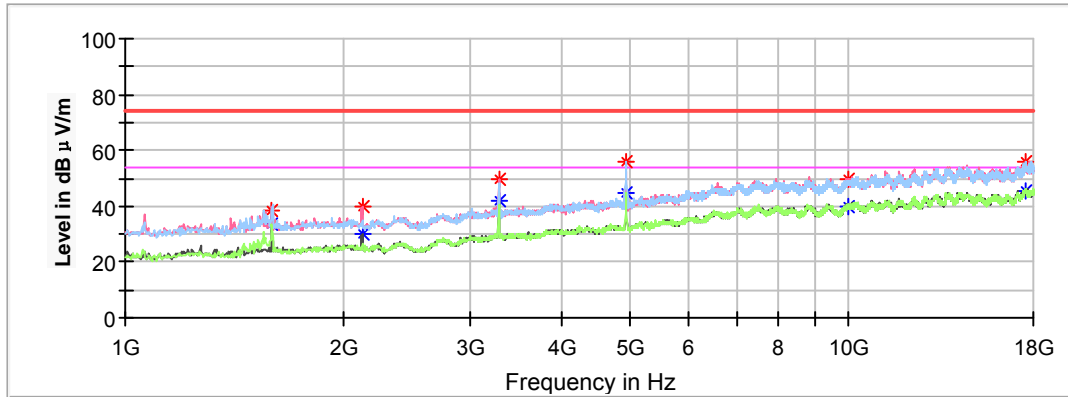

Frequency (MHz)	Corrected Amplitude		Rx Antenna		Turntable Degree	Corrected Factor (dB/m)	Limit (dBμV/m)	Margin (dB)
	MaxPeak (dBμV /m)	Average (dBμV /m)	Height (cm)	Polar (H/V)				
1595.000000	---	33.68	200.0	H	155.0	-9.6	54.00	20.32
1595.000000	38.21	---	200.0	H	155.0	-9.6	74.00	35.79
2128.800000	---	29.79	150.0	V	257.0	-7.9	54.00	24.21
2128.800000	39.90	---	150.0	V	257.0	-7.9	74.00	34.10
3281.400000	---	42.05	200.0	V	176.0	-3.9	54.00	11.95
3281.400000	49.56	---	200.0	V	176.0	-3.9	74.00	24.44
4920.200000	---	45.10	100.0	H	258.0	-0.4	54.00	8.90
4920.200000	55.87	---	100.0	H	258.0	-0.4	74.00	18.13
9993.000000	---	39.77	200.0	V	215.0	8.2	54.00	14.23
9993.000000	49.83	---	200.0	V	215.0	8.2	74.00	24.17
17551.200000	---	45.26	150.0	H	8.0	14.2	54.00	8.74
17551.200000	55.62	---	150.0	H	8.0	14.2	74.00	18.38

18GHz-25GHz:

Pre-scan with 802.11b, 802.11g, 802.11n-HT20 and 802.11n-HT40 modes of operation in the X,Y and Z axes of orientation, the worst case **high channel of 802.11b mode in Z-axis of orientation** was recorded

Vertical

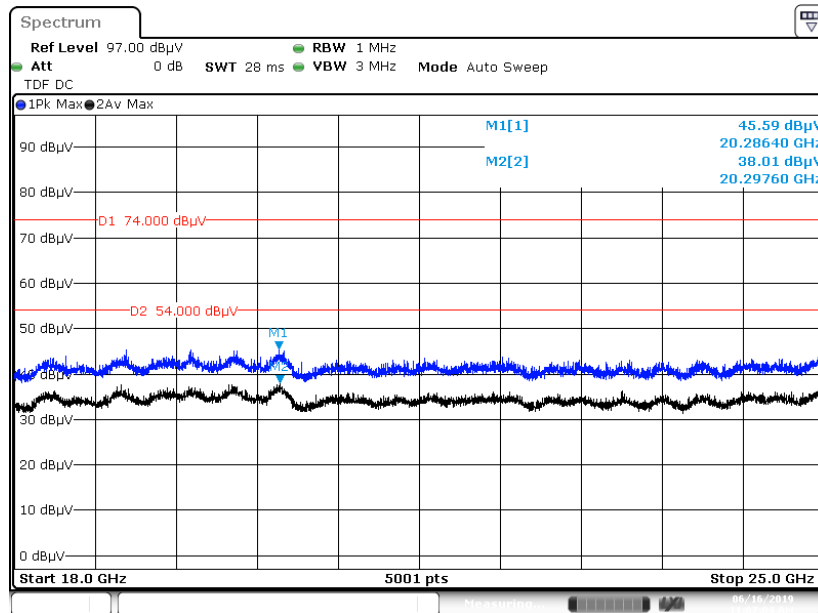

Date:16 JUN 2019 11:07:04

Horizontal

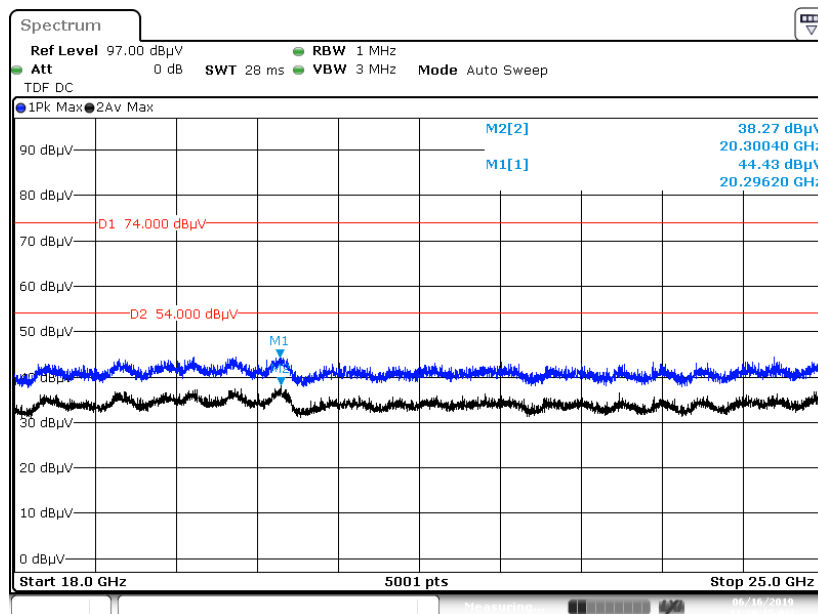

Date:16 JUN 2019 11:29:15

Fundamental Test & Restricted Bands Emissions Test:

Note:

1. Corrected Factor (dB/m) = Antenna factor (RX) (dB/m) + Cable Loss (dB) – Amplifier Factor (dB)

Corrected Amplitude (dBµV /m) = Corrected Factor (dB/m) + Reading (dBµV)

Margin (dB) = Limit (dBµV/m) – Corrected Amplitude (dBµV /m)

802.11b Mode: (Pre-scan in the X, Y and Z axes of orientation, the worst case Z-axis of orientation was recorded)

Frequency (MHz)	Corrected Amplitude		Rx Antenna		Turntable Degree	Corrected Factor (dB/m)	Limit (dBµV/m)	Margin (dB)
	MaxPeak (dBµV /m)	Average (dBµV /m)	Height (cm)	Polar (H/V)				
Low Channel: 2412MHz								
2390.000000	---	36.27	150.0	H	14.0	2.8	54.00	17.73
2390.000000	46.19	---	150.0	H	14.0	2.8	74.00	27.81
High Channel: 2462MHz								
2483.500000	---	38.02	100.0	H	255.0	3.0	54.00	15.98
2483.500000	47.25	---	100.0	H	255.0	3.0	74.00	26.75

802.11g Mode: (Pre-scan in the X, Y and Z axes of orientation, the worst case Z-axis of orientation was recorded)

Frequency (MHz)	Corrected Amplitude		Rx Antenna		Turntable Degree	Corrected Factor (dB/m)	Limit (dBµV/m)	Margin (dB)
	MaxPeak (dBµV /m)	Average (dBµV /m)	Height (cm)	Polar (H/V)				
Low Channel: 2412MHz								
2390.000000	---	39.03	250.0	H	81.0	2.8	54.00	14.97
2390.000000	49.22	---	250.0	H	81.0	2.8	74.00	24.78
High Channel: 2462MHz								
2483.500000	---	48.26	100.0	H	143.0	3.0	54.00	5.74
2483.500000	50.36	---	100.0	H	143.0	3.0	74.00	23.64

802.11n-HT20 Mode: (Pre-scan in the X, Y and Z axes of orientation, the worst case Z-axis of orientation was recorded)

Frequency (MHz)	Corrected Amplitude		Rx Antenna		Turntable Degree	Corrected Factor (dB/m)	Limit (dBµV/m)	Margin (dB)
	MaxPeak (dBµV /m)	Average (dBµV /m)	Height (cm)	Polar (H/V)				
Low Channel: 2412MHz								
2390.000000	---	37.25	150.0	H	125.0	2.8	54.00	16.75
2390.000000	47.16	---	150.0	H	125.0	2.8	74.00	26.84
High Channel: 2462MHz								
2483.500000	---	38.58	150.0	H	354.0	3.0	54.00	15.42
2483.500000	48.02	---	150.0	H	354.0	3.0	74.00	25.98

Conducted Spurious Emissions at Antenna Port

802.11b Mode Low Channel

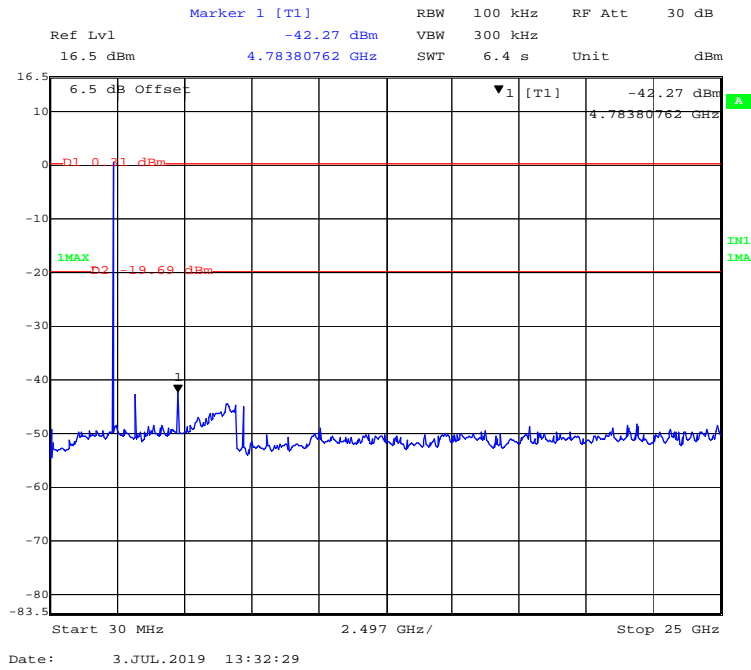

802.11b Mode Middle Channel

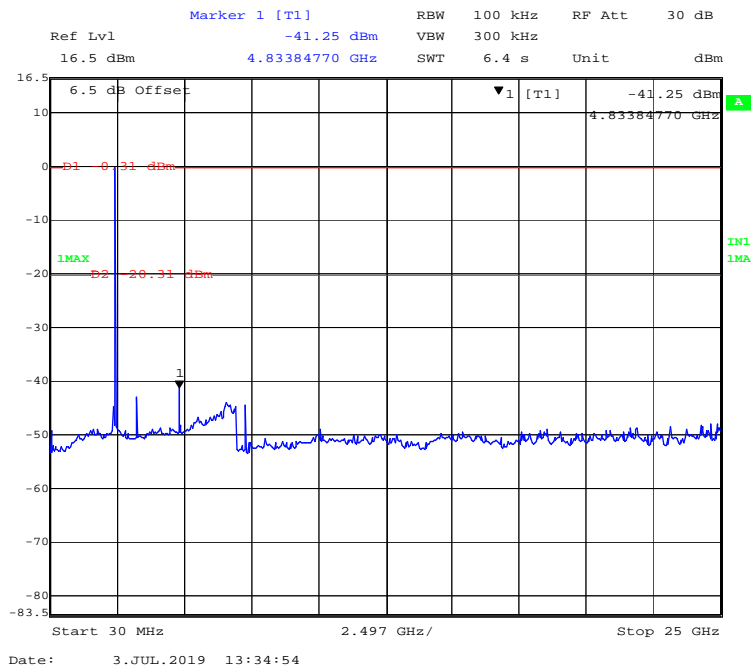

802.11b Mode High Channel

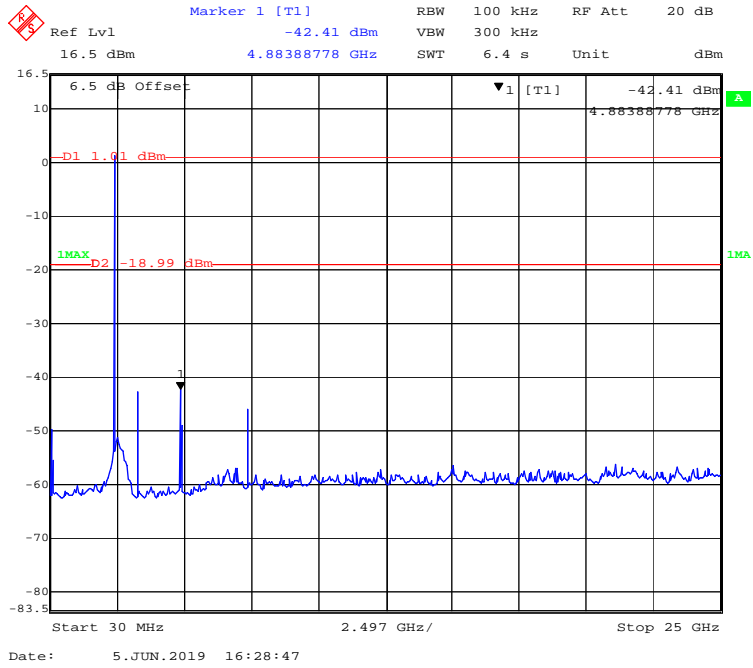

802.11g Mode Low Channel

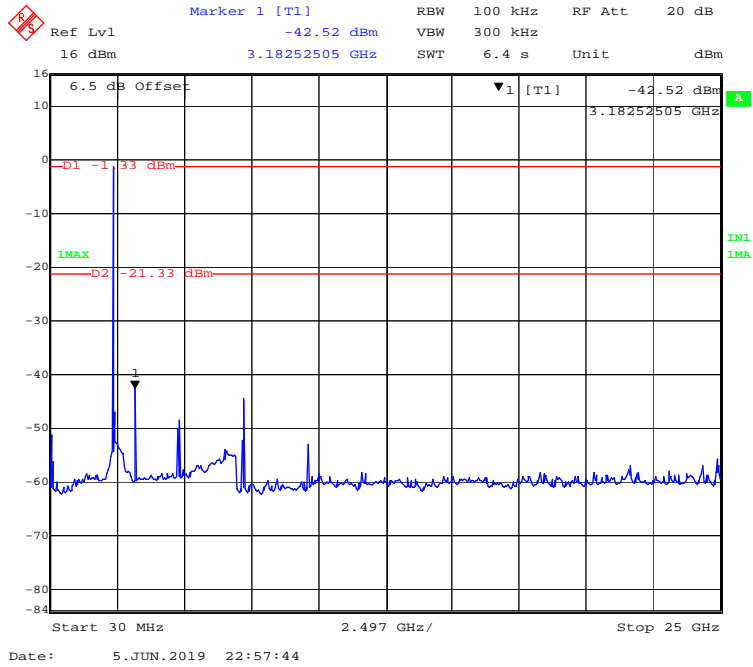

802.11g Mode Middle Channel

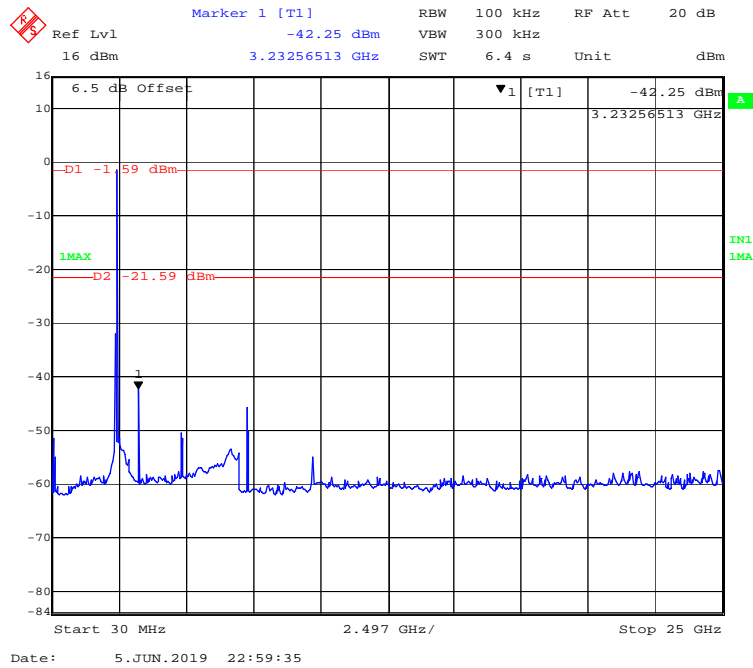

802.11g Mode High Channel

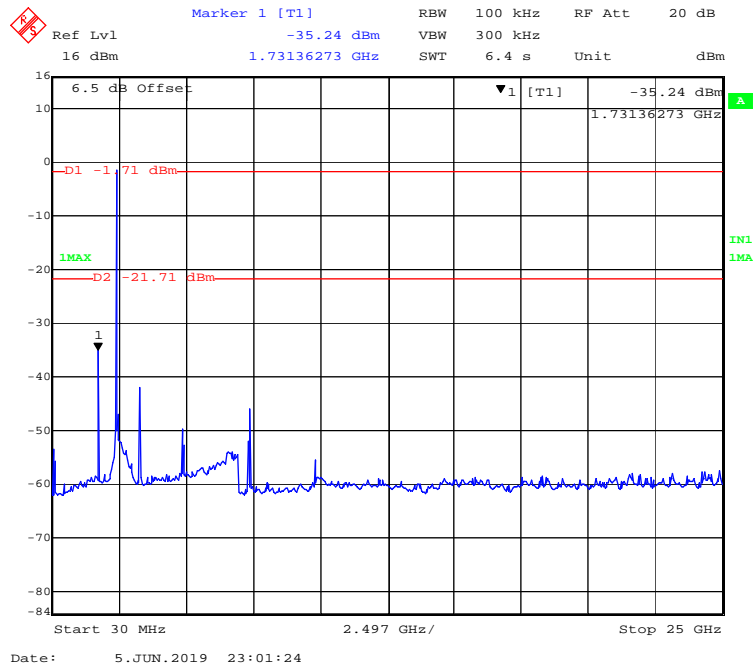

802.11n-HT20 Mode Low Channel

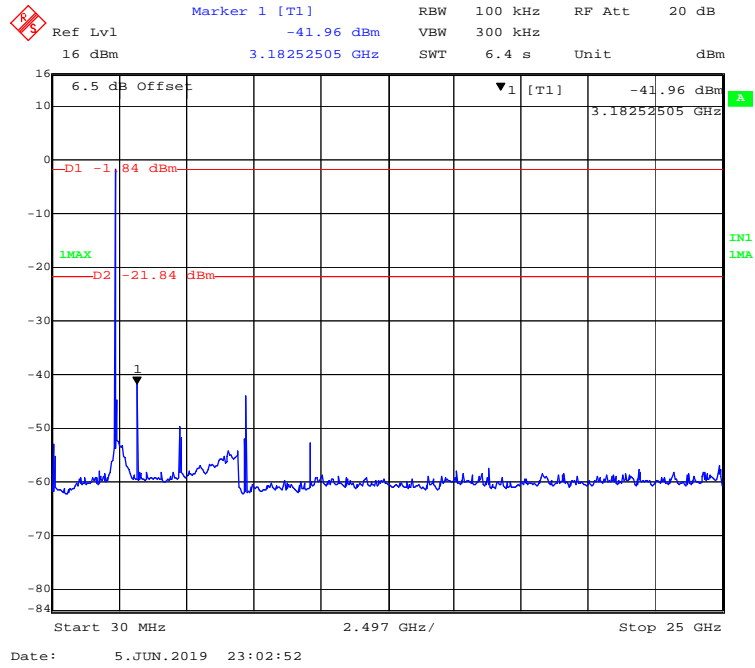

802.11n-HT20 Mode Middle Channel

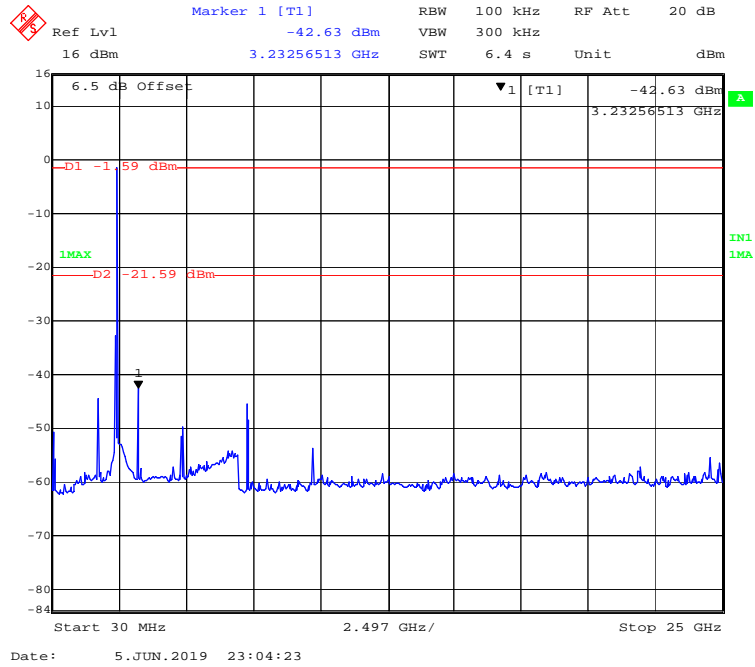

802.11n-HT20 Mode High Channel

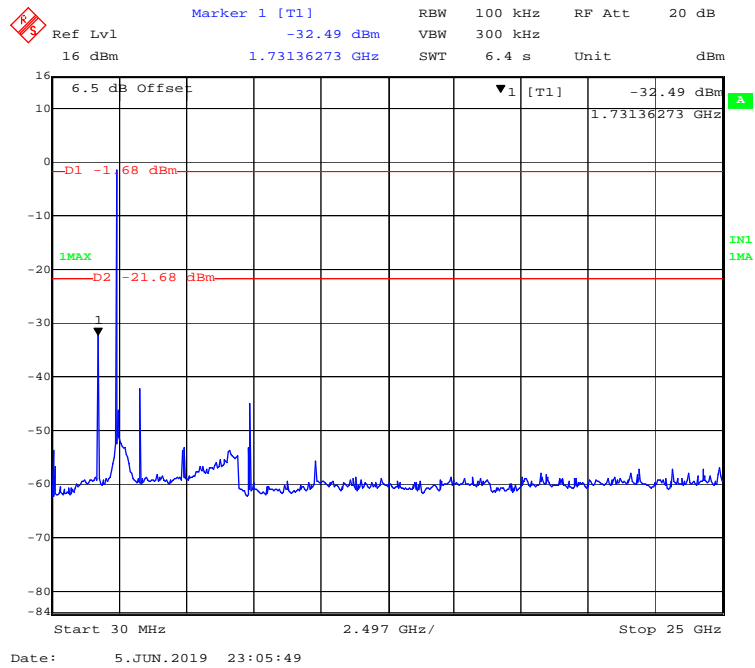

FCC §15.247(a) (2) - 6 dB EMISSION BANDWIDTH

Applicable Standard

Systems using digital modulation techniques may operate in the 902–928 MHz, 2400–2483.5 MHz, and 5725–5850 MHz bands. The minimum 6 dB bandwidth shall be at least 500 kHz.

Test Procedure

According to ANSI C63.10-2013 sub-clause 11.8.1

1. Set RBW = 100 kHz.
2. Set the video bandwidth (VBW) $\geq 3 * RBW$.
3. Detector = Peak.
4. Trace mode = max hold.
5. Sweep = auto couple.
6. Allow the trace to stabilize.
7. Measure the maximum width of the emission that is constrained by the frequencies associated with the two outermost amplitude points (upper and lower frequencies) that are attenuated by 6 dB relative to the maximum level measured in the fundamental emission.

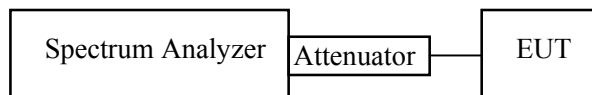

Test Data

Environmental Conditions

Temperature:	24~26 °C
Relative Humidity:	48~51 %
ATM Pressure:	101.1~101.3 kPa

The testing was performed by Winnie Yang from 2019-06-05 to 2019-07-03.

EUT operation mode: Transmitting

Test Result: Pass

Channel	Frequency (MHz)	6 dB Emission Bandwidth (MHz)	Limit (MHz)
802.11b Mode			
Low	2412	9.078	≥ 0.5
Middle	2437	9.507	≥ 0.5
High	2462	9.078	≥ 0.5
802.11g Mode			
Low	2412	16.413	≥ 0.5
Middle	2437	16.413	≥ 0.5
High	2462	16.413	≥ 0.5
802.11n-HT20 Mode			
Low	2412	17.074	≥ 0.5
Middle	2437	17.014	≥ 0.5
High	2462	16.954	≥ 0.5

802.11b Mode Low Channel

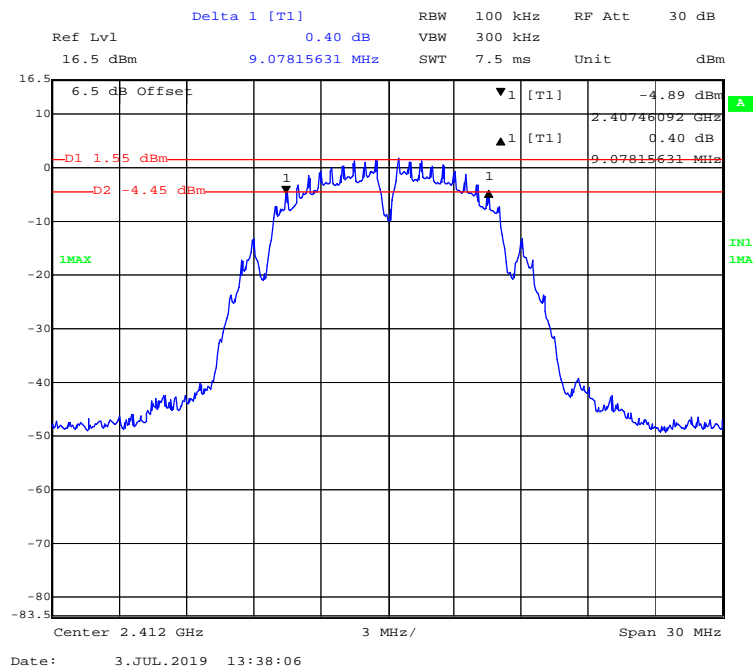

802.11b Mode Middle Channel



802.11b Mode High Channel



802.11g Mode Low Channel

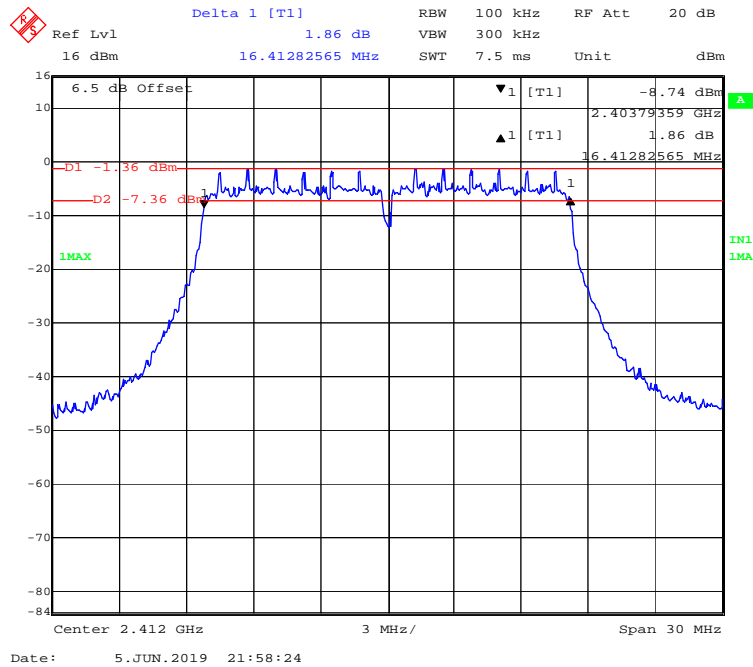

802.11g Mode Middle Channel

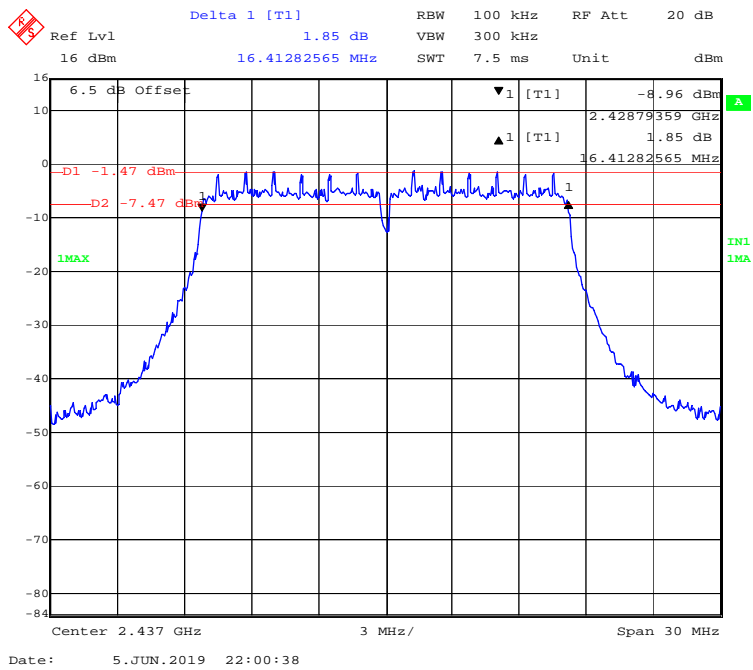

802.11g Mode High Channel

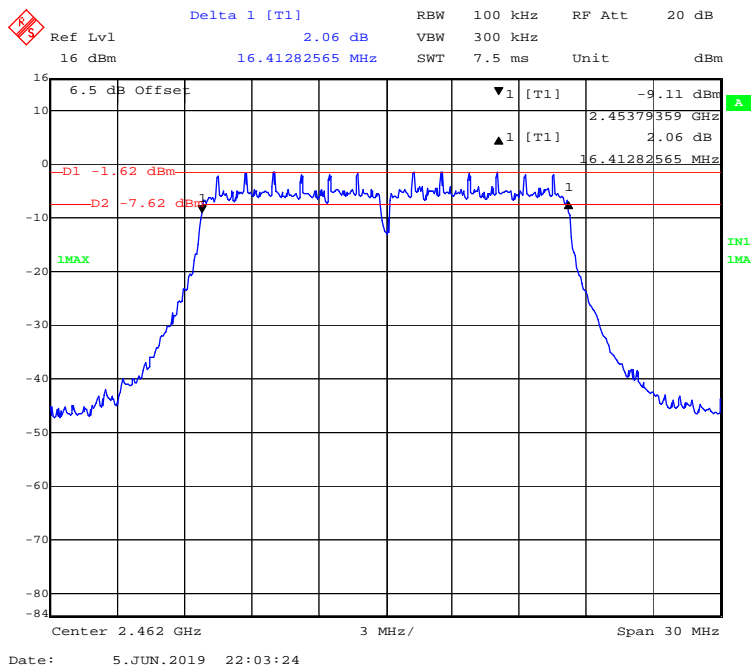

802.11n-HT20 Mode Low Channel

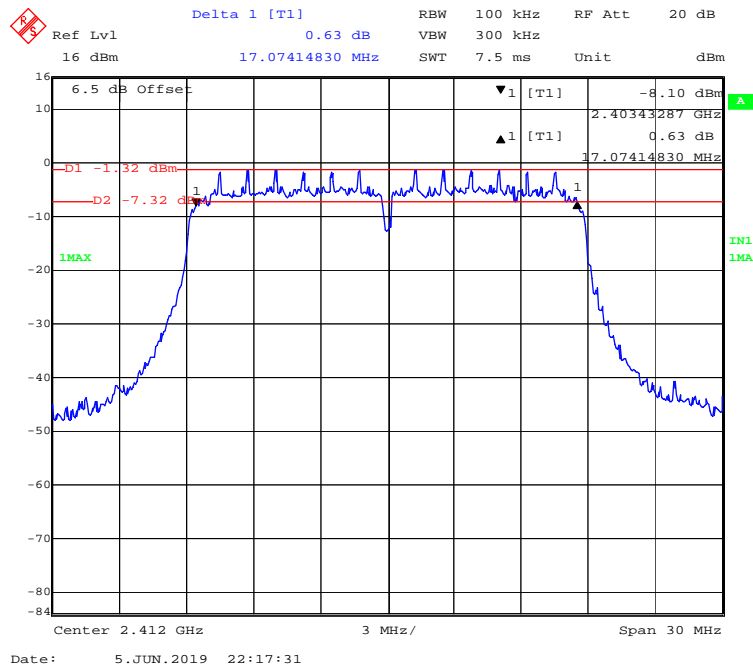

802.11n-HT20 Mode Middle Channel

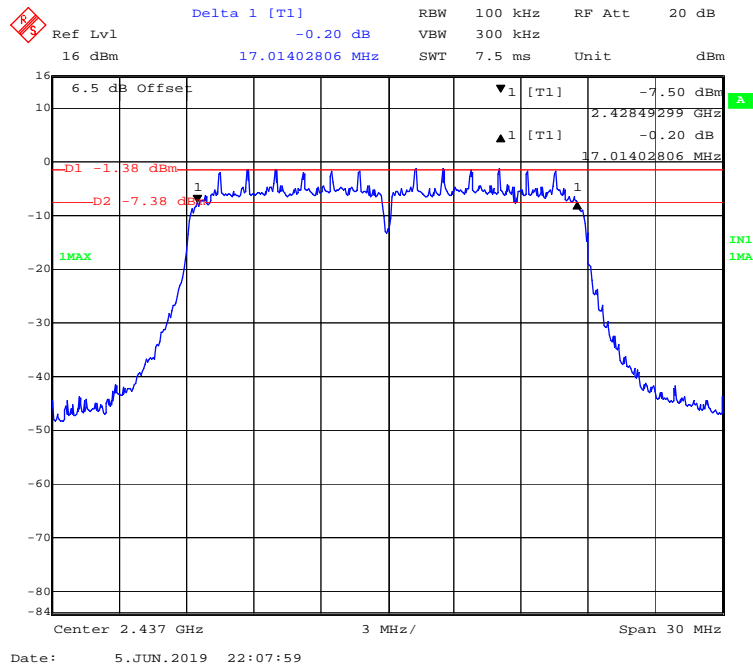

802.11n-HT20 Mode High Channel

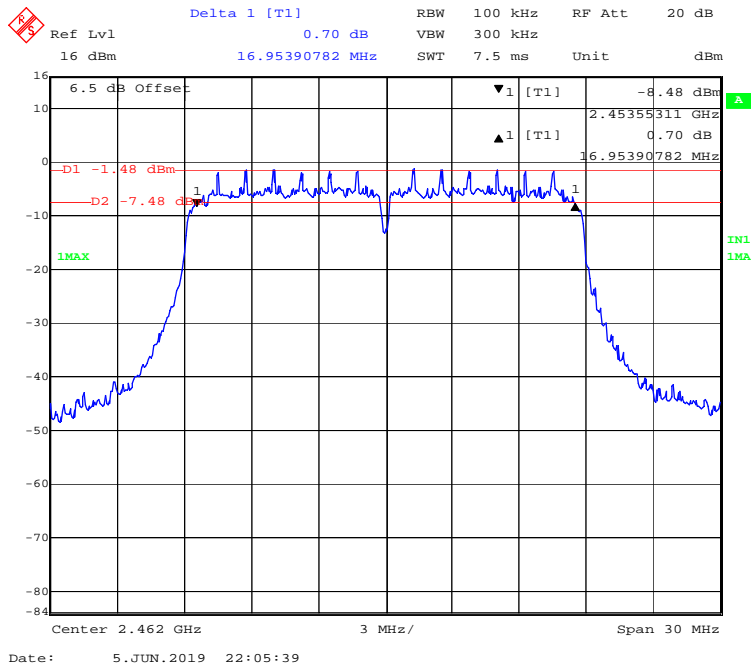

FCC §15.247(b) (3) - MAXIMUM CONDUCTED OUTPUT POWER

Applicable Standard

According to FCC §15.247(b) (3), for systems using digital modulation in the 902-928 MHz, 2400-2483.5 MHz, and 5725-5850 MHz bands: 1 Watt. As an alternative to a peak power measurement, Compliant with the one Watt limit can be based on a measurement of the maximum conducted output power. Maximum Conducted Output Power is defined as the total transmit power delivered to all antennas and antenna elements averaged across all symbols in the signaling alphabet when the transmitter is operating at its maximum power control level. Power must be summed across all antennas and antenna elements. The average must not include any time intervals during which the transmitter is off or is transmitting at a reduced power level. If multiple modes of operation are possible (e.g., alternative modulation methods), the maximum conducted output power is the highest total transmit power occurring in any mode.

Test Procedure

According to ANSI C63.10-2013 sub-clause 11.9.1.3

The maximum peak conducted output power may be measured using a broadband peak RF power meter. The power meter shall have a video bandwidth that is greater than or equal to the DTS bandwidth and shall use a fast-responding diode detector.

1. Place the EUT on a bench and set it in transmitting mode.
2. Remove the antenna from the EUT and then connect a low loss RF cable from the antenna port to one test equipment.
3. Add a correction factor to the display.

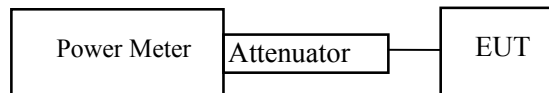

Test Data

Environmental Conditions

Temperature:	23.8~26°C
Relative Humidity:	51~54 %
ATM Pressure:	101.1~101.2kPa

The testing was performed by Winnie Yang from 2019-06-05 to 2019-07-03.

EUT operation mode: Transmitting

Channel	Frequency (MHz)	Max Conducted Peak Output Power (dBm)	Limit (dBm)	Result
802.11b Mode				
Low	2412	13.13	30	Pass
Middle	2437	12.69	30	Pass
High	2462	13.89	30	Pass
802.11g Mode				
Low	2412	17.81	30	Pass
Middle	2437	17.81	30	Pass
High	2462	17.57	30	Pass
802.11n-HT20 Mode				
Low	2412	17.94	30	Pass
Middle	2437	17.72	30	Pass
High	2462	17.61	30	Pass

FCC §15.247(d) – 100 kHz BANDWIDTH OF FREQUENCY BAND EDGE

Applicable Standard

In any 100 kHz bandwidth outside the frequency band in which the spread spectrum or digitally modulated intentional radiator is operating, the radio frequency power that is produced by the intentional radiator shall be at least 20 dB below that in the 100 kHz bandwidth within the band that contains the highest level of the desired power, based on either an RF conducted or a radiated measurement, provided the transmitter demonstrates Compliant with the peak conducted power limits. If the transmitter complies with the conducted power limits based on the use of RMS averaging over a time interval, as permitted under paragraph (b)(3) of this section, the attenuation required under this paragraph shall be 30 dB instead of 20 dB. Attenuation below the general limits specified in §15.209(a) is not required. In addition, radiated emissions which fall in the restricted bands, as defined in §15.205(a), must also comply with the radiated emission limits specified in §15.209(a) (see §15.205(c)).

Test Procedure

According to ANSI C63.10-2013 sub-clause 6.10.

1. Check the calibration of the measuring instrument using either an internal calibrator or a known signal from an external generator.
2. Position the EUT without connection to measurement instrument. Turn on the EUT and connect its antenna terminal to measurement instrument via a low loss cable. Then set it to any one measured frequency within its operating range, and make sure the instrument is operated in its linear range.
3. Set RBW to 100 kHz and VBW of spectrum analyzer to 300 kHz with a convenient frequency span including 100 kHz bandwidth from band edge.
4. Measure the highest amplitude appearing on spectral display and set it as a reference level. Plot the graph with marking the highest point and edge frequency.
5. Repeat above procedures until all measured frequencies were complete.

Test Data

Environmental Conditions

Temperature:	24.3~25.0 °C
Relative Humidity:	48~50 %
ATM Pressure:	101.1~101.3 kPa

The testing was performed by Winnie Yang from 2019-06-05 to 2019-07-03.

EUT operation mode: Transmitting

Test Result: Compliant

802.11b Mode Left Side

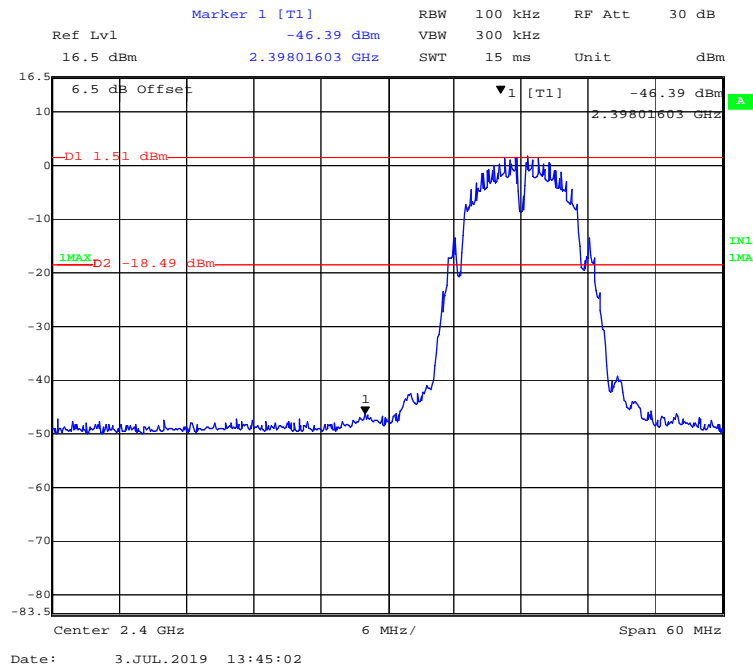

802.11b Mode Right Side

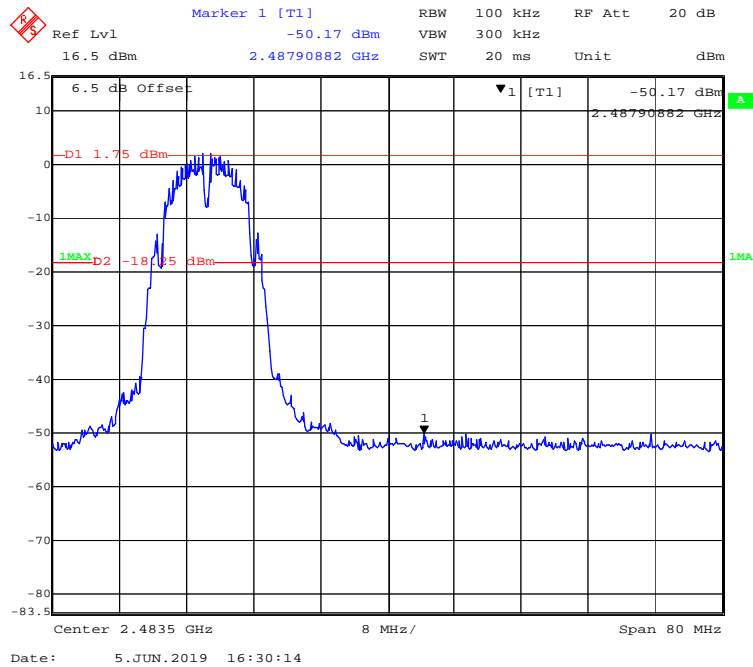

802.11g Mode Left Side

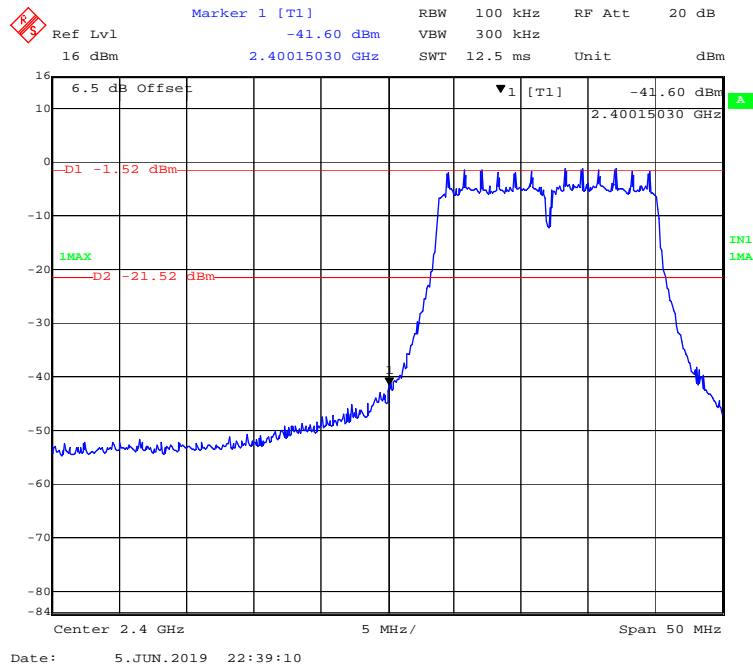

802.11g Mode Right Side

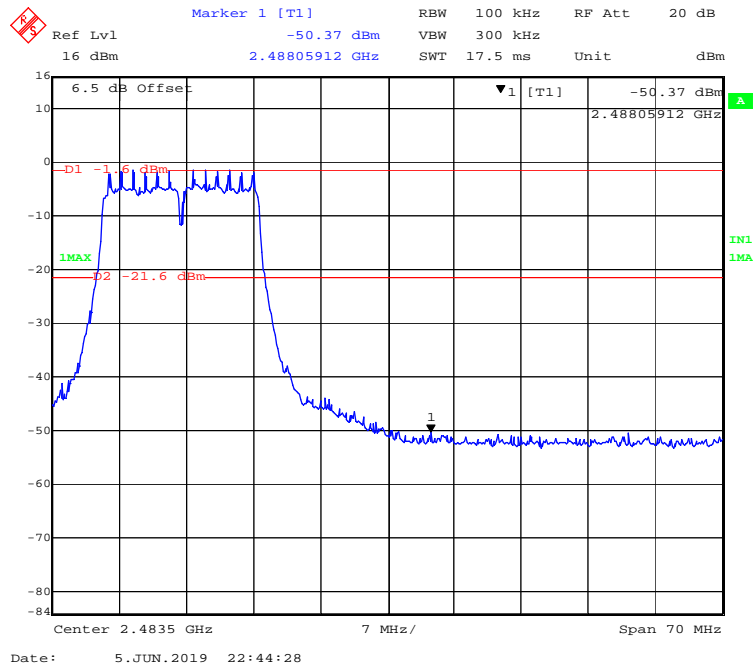

802.11n-HT20 Mode Left Side

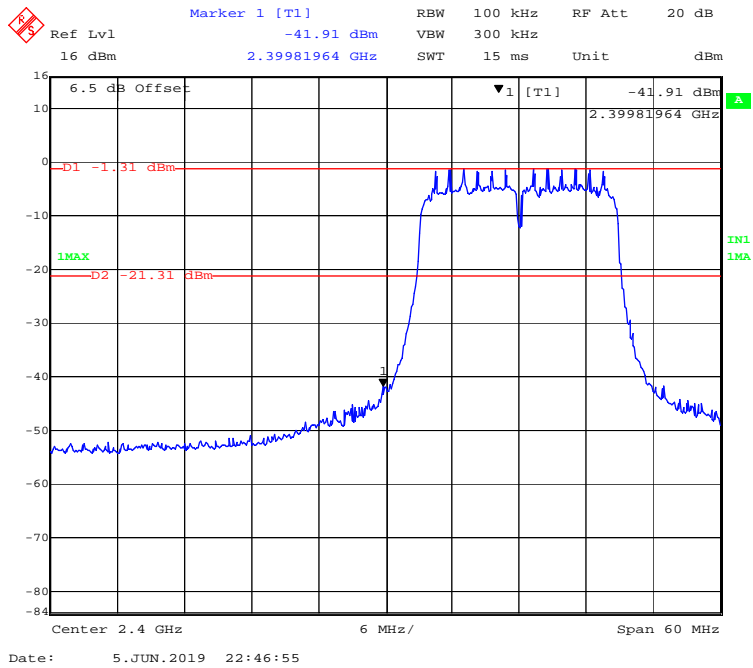

802.11n-HT20 Mode Right Side

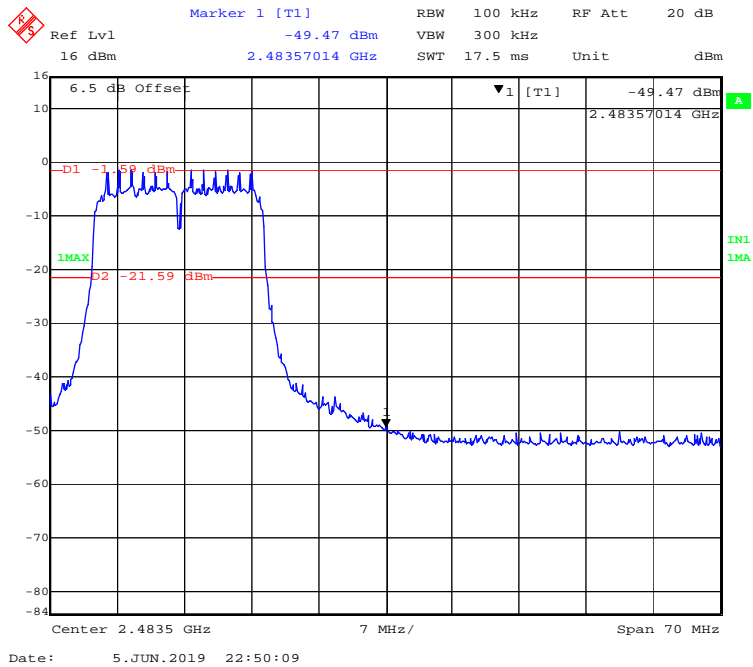

FCC §15.247(e) - POWER SPECTRAL DENSITY

Applicable Standard

For digitally modulated systems, the power spectral density conducted from the intentional radiator to the antenna shall not be greater than 8 dBm in any 3 kHz band during any time interval of continuous transmission. This power spectral density shall be determined in accordance with the provisions of paragraph (b) of this section. The same method of determining the conducted output power shall be used to determine the power spectral density.

Test Procedure

According to ANSI C63.10-2013 sub-clause 11.10.2

The following procedure shall be used if maximum peak conducted output power was used to determine Compliant, and it is optional if the maximum conducted (average) output power was used to determine Compliant:

1. Set the RBW to: $3\text{kHz} \leq \text{RBW} \leq 100\text{ kHz}$.
2. Set the VBW $\geq 3 \times \text{RBW}$.
3. Set the span to 1.5 times the DTS bandwidth.
4. Detector = peak.
5. Sweep time = auto couple.
6. Trace mode = max hold.
7. Allow trace to fully stabilize.
8. Use the peak marker function to determine the maximum amplitude level within the RBW.
9. If measured value exceeds limit, reduce RBW (no less than 3 kHz) and repeat.

Test Data

Environmental Conditions

Temperature:	24.1~25.2°C
Relative Humidity:	48~50%
ATM Pressure:	101.0~101.3kPa

The testing was performed by Winnie Yang from 2019-06-05 to 2019-07-03.

EUT operation mode: Transmitting

Test Result: Pass

Channel	Frequency (MHz)	PSD (dBm/3kHz)	Limit (dBm/3kHz)
802.11b Mode			
Low	2412	-14.30	≤ 8
Middle	2437	-13.74	≤ 8
High	2462	-14.05	≤ 8
802.11g Mode			
Low	2412	-15.23	≤ 8
Middle	2437	-15.56	≤ 8
High	2462	-15.39	≤ 8
802.11n-HT20 mode			
Low	2412	-15.56	≤ 8
Middle	2437	-16.02	≤ 8
High	2462	-15.92	≤ 8

802.11b Mode Low Channel

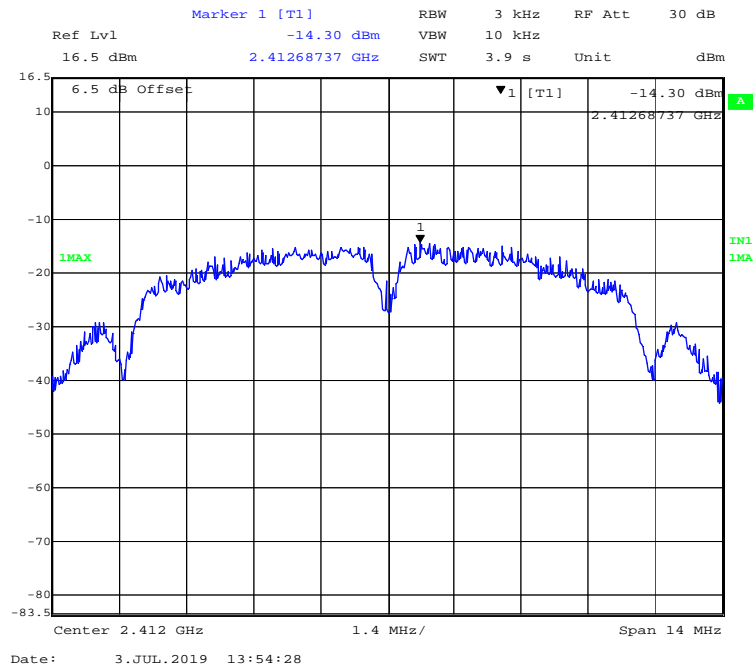

802.11b Mode Middle Channel

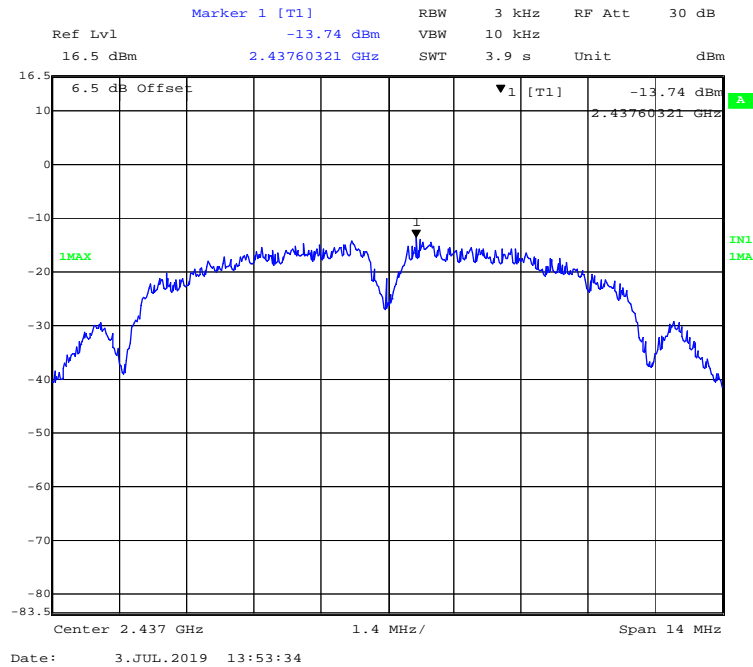

802.11b Mode High Channel

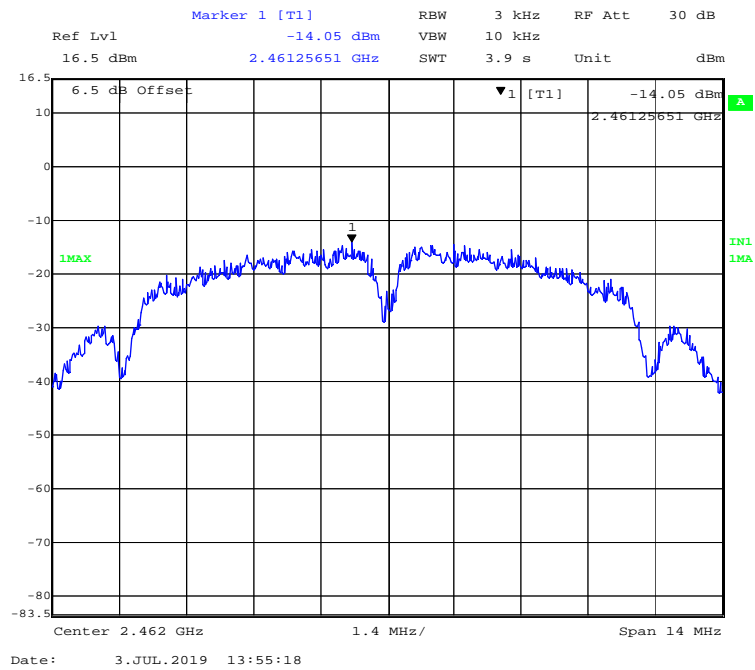

802.11g Mode Low Channel

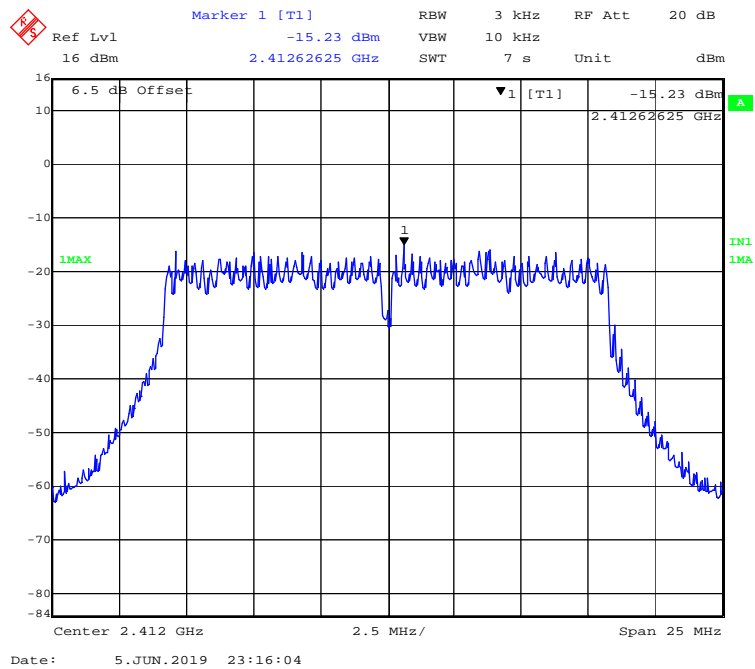

802.11g Mode Middle Channel

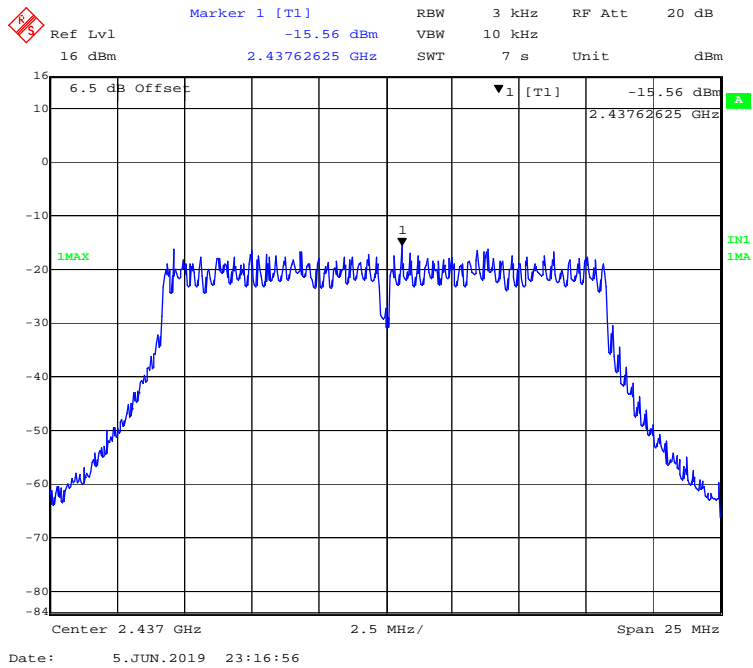

802.11g Mode High Channel

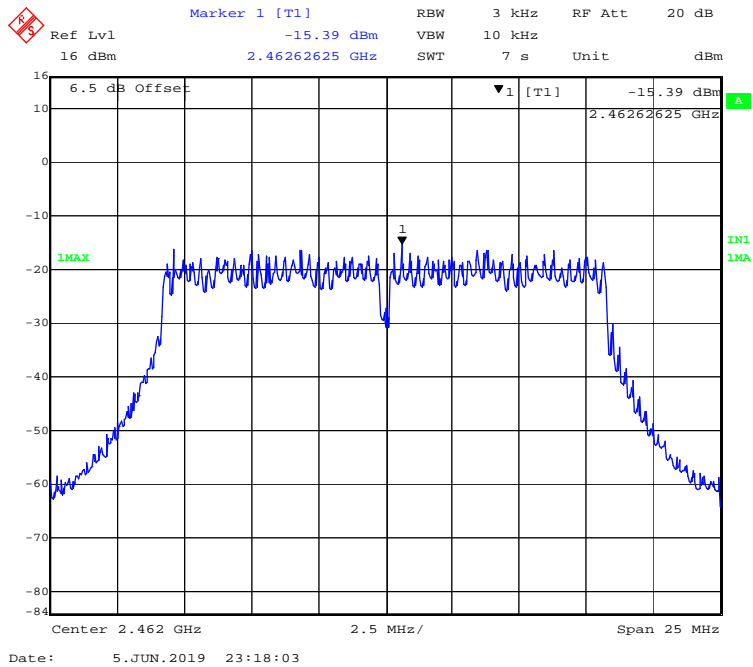

802.11n-HT20 Mode Low Channel

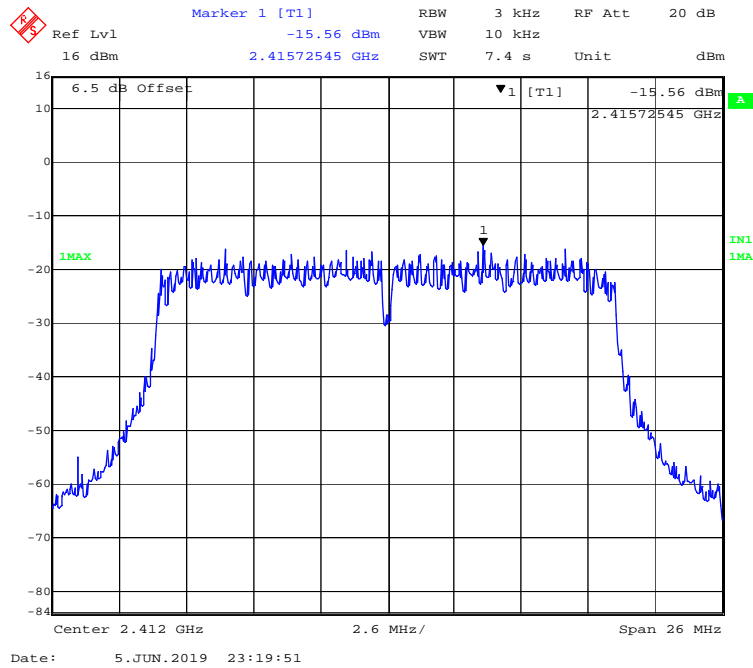

802.11n-HT20 Mode Middle Channel

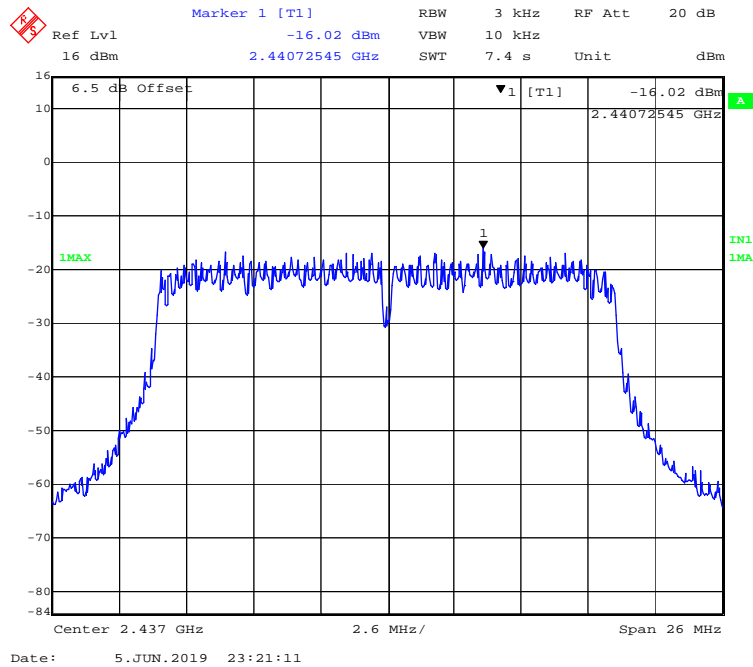

802.11n-HT20 Mode High Channel

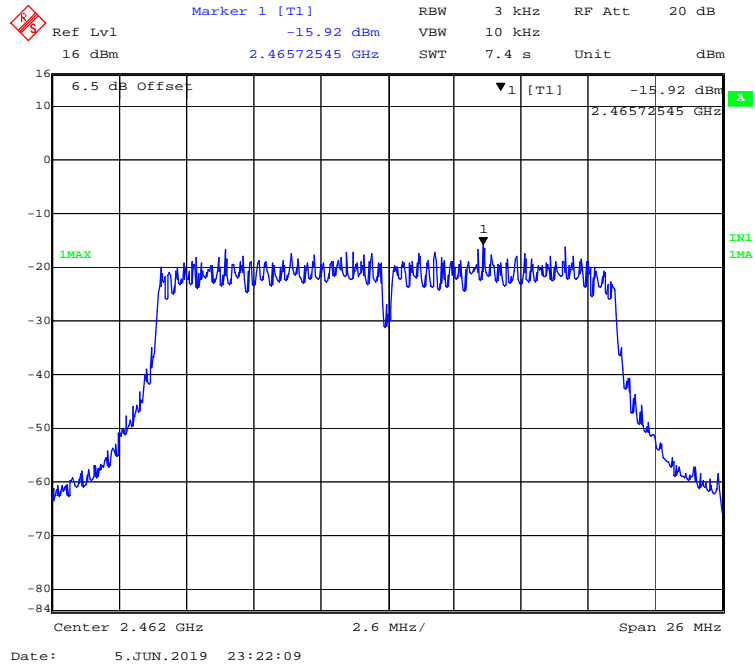

***** END OF REPORT *****