

meross

User Manual

Warning

RISK OF ELECTRIC SHOCK OR FIRE.

- Make sure the power is OFF at the circuit breaker for the wall switch you are replacing.
- The wall switch must be installed and used in accordance with the National Electric Code (NEC) or your local electrical code. If you are unfamiliar with these codes, or are uncomfortable performing the installation, please call a qualified electrician.
- Do not install the wall switch with wet hands or when standing on wet or damp surfaces.
- The wall switch is for North America only. Max 400W INC bulb, 150W CFL or LED bulb.
- For your safety, do NOT use metal faceplate with this switch.

Installation Guide

Before We Get Started

- Replace single pole switch. Not compatible with 3 way or 4 way switch.*
- **Neutral wire (white wire) is required.**
- Only supports 2.4GHz WiFi networks.

* A 3 or 4 way switch is a light that is controlled by more than one switch.

1. Download the Meross app.



2. Hardware installation.

Note: You can also refer to the instructions in Meross app and follow it step by step.

- a) Make sure your traditional switch is single pole switch. This smart switch is not for 3 way or 4 way switches.
- b) Place your smartphone near the traditional switch to make sure the location is covered by strong Wi-Fi signal.
- c) Get you tools ready and turn off the power at the circuit breaker that controls the switch. Double check the power using a voltage detector.

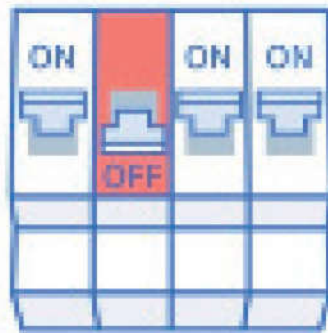

- d) Remove the faceplate and pull out the traditional switch. Finding the neutral wire (usually white) in your electrical box. This smart switch requires a neutral wire to work. Otherwise it won't work.

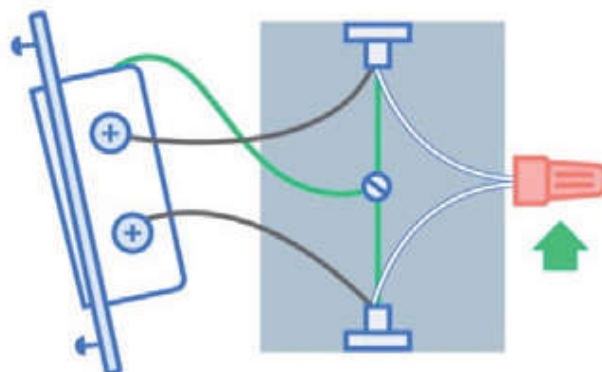

e) Unscrew the wires and connect them according to picture below.

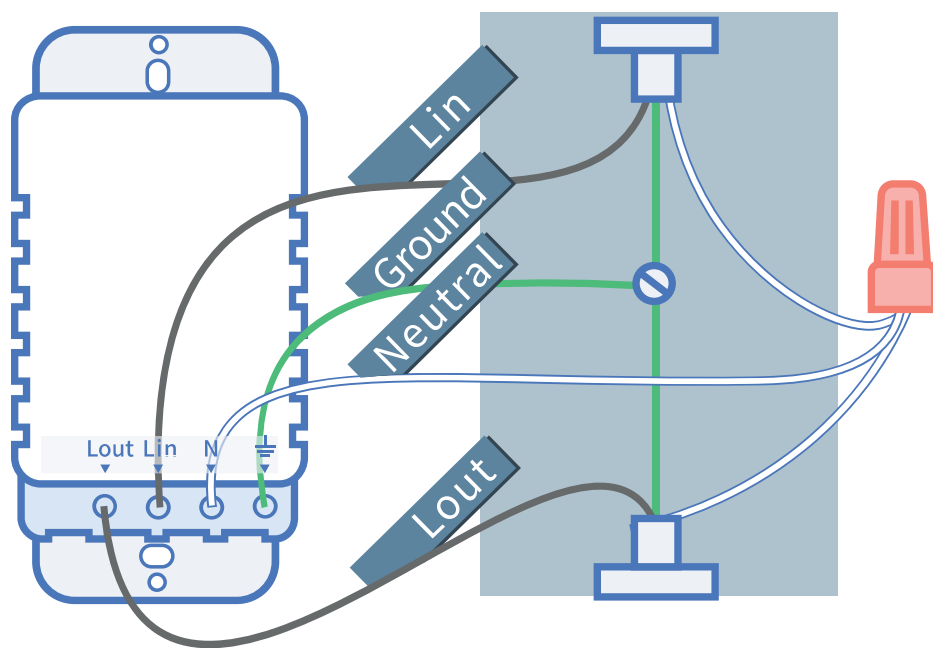

f) Push the smart switch back into the box and turn the power on at the circuit breaker. If the switch works manually and the LED is flashing amber and green, then you are good to go for setting up. If not, please turn off the power at the circuit breaker and check the wiring.

For more detailed information, please refer to the Meross app.

3. Set up the device.

(1) For Android user. Open Meross app and tap + on the top right. Just follow the instructions in Meross app and you will set it up in minutes. If you want to use HomeKit with an iOS device after setup on Android. Just launch your Home app and scan or input the code printed on the device or user manual. No reset or extra configuration needed.

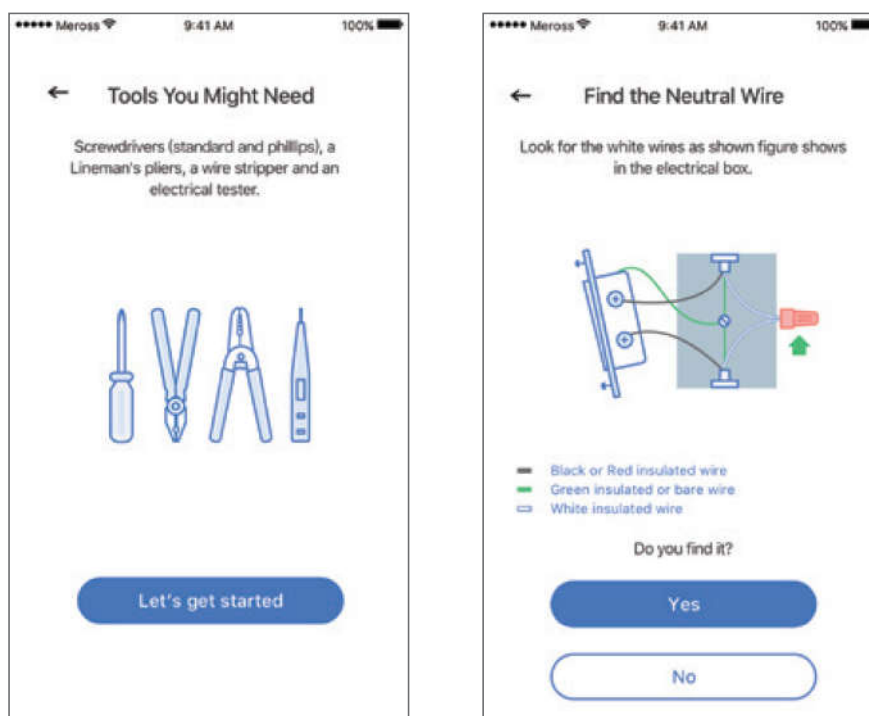

2) For iOS user. Please follow instructions below.

- a. Please ensure that your iPhone or iPad is connecting to a 2.4GHz Wi-Fi. Or you may not be able to set it up.
- b. Please make sure you are having iOS 13 or above. We recommend you to upgrade to iOS 14 to have better HomeKit user experience.

c. Use Apple Home app instead of Meross app to set it up. Just launch your Home app and tap “Add Accessory” or + on the top right and follow the instructions. It may take a few minutes and then you’ll be all set. The setup code is printed on the device and the user manual. Input the code on the label and wait. You should be able to set it up in a minute.

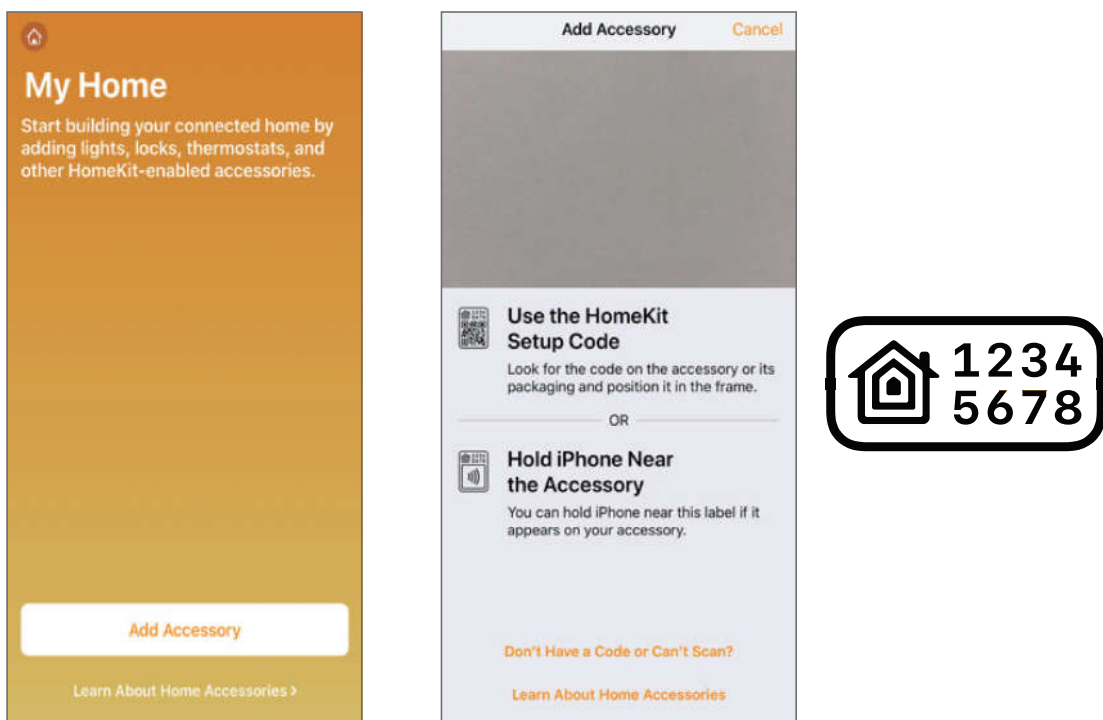

d. After that, if you’d like to manage your MSS560 in Meross app, please connect to your home Wi-Fi and launch your Meross app and tap + on the top right. It will help you find devices in the same Wi-Fi network. Just tap add and you’ll be able to manage MSS560 in Meross app. For example, upgrading firmware and binding to Amazon or Google voice assistants.

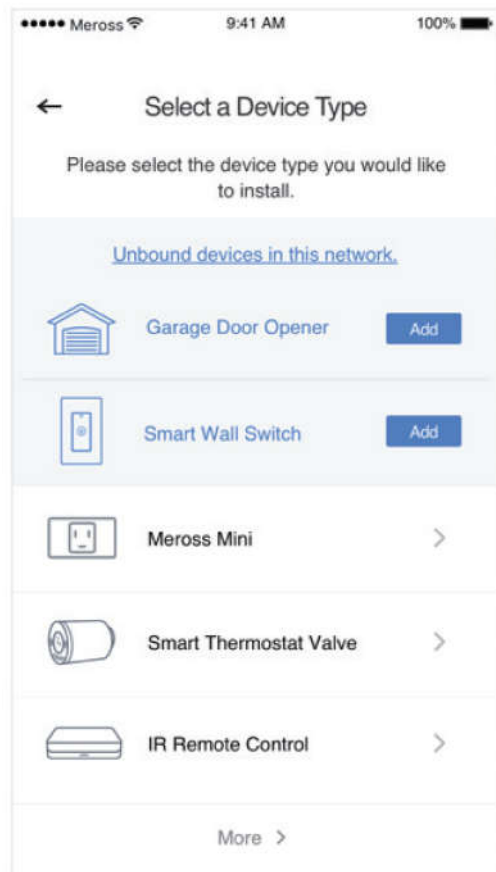

- Note: 1. According to Apple HomeKit, the only way to set up HomeKit accessory with iOS is Home app. If you don't want to set up with Home app, you will have to use an Android device.
2. If you can't setup the device with Home app. It might be that the iOS is having cache issue with Homekit device. Please try to
- Reset the smart device and kill the Home app and retry.
 - Restart your iOS and retry. (This is important.)
 - Ensure that your iOS is connecting to 2.4G of your home Wi-Fi.
 - Have your iOS forget all other Wi-Fi in your home.

You can also contact us at support@meross.com. We are always happy to help.

LED and Button Rules

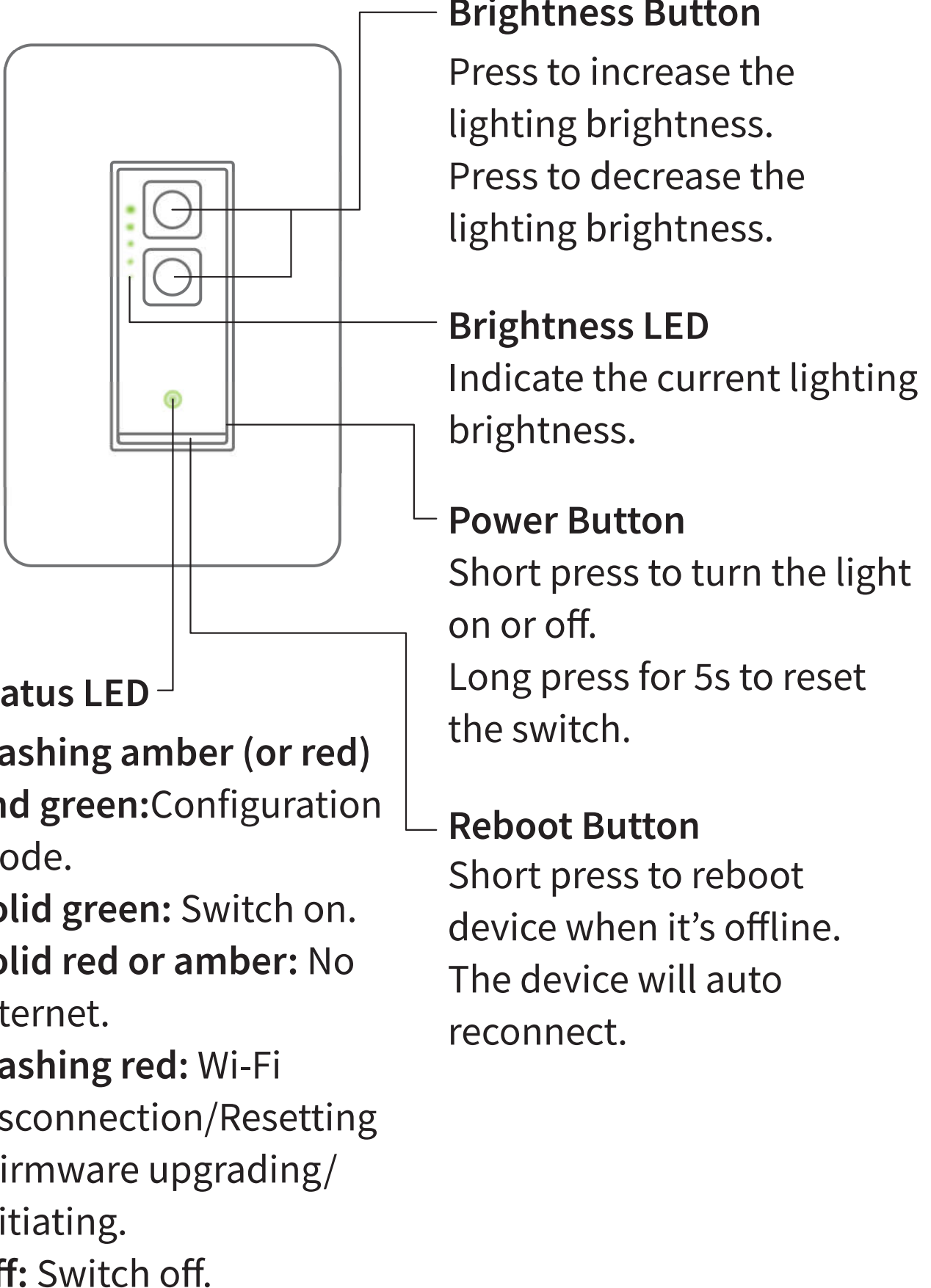

FAQ

At Meross, we strive to assure your satisfaction. We are always happy to help at support@meross.com.

1. What should I do when I can't turn the wall switch on/off manually?

Please check the Status LED. If it is off:

- Make sure that you restore power to the wall switch at the circuit breaker.
- Make sure the wall switch is wired correctly. Please consult with a qualified electrician.

2. What should I do when my Meross app is unable to control the added Wall Switch?

Please check the following:

- Check your home WiFi's Internet connection.
- Make sure your home WiFi's password hasn't been changed.
- Do not use a metal faceplate with the wall switch as that will decrease the WiFi signal.
- Short press the reboot button to reboot device.
Device will reconnect automatically, no extra configuration needed.

If all above do not work, please factory reset MSS560 and try to add it again.

3. How do I pair my Meross devices with Amazon Alexa or Google Assistant?

Visit Account->Amazon Alexa or Google Assistant page within Meross app for pairing instructions.

4. Why my iOS will require me to use Home app when setting it up?

This is required by Apple iOS. If you want manage your device in Meross app, please launch your Meross app after the setup and tap + on the top right. Meross app will find devices in the same Wi-Fi network.

5. I can't pair my device with HomeKit anyhow.

Please make sure your iOS is connecting to the 2.4GHz of your home Wi-Fi and you are having iOS 13 or above. Restart your iOS will help due to some system cache issue.

Warranty

Meross products are covered by a 12 months limited warranty from the date of its original purchase. If any problems occur, please contact support@meross.com for help.

We can only provide aftersales service for products that are sold by Meross or Meross authorized retailers and distributors.

Disclaimer

1. The function of this smart wall switch is tested under a typical circumstance described in our specification. Meross does NOT guarantee that under all circumstances will the smart switch perform the same way as described.

2. By using any third-party services such as Amazon Alexa, Google Assistant, Apple HomeKit. Consumer acknowledge that all data and privacy collected by such third parties are not covered by Meross, nor Meross would take any legal responsibility. Meross only take responsibility for what's covered by Meross Privacy Policy. Consumer acknowledge understanding this clearly by reading this document.

FCC Compliance Information Statement

Changes or modifications not expressly approved by the party responsible for compliance could void the user's authority to operate the equipment.

This device complies with Part 15 of the FCC Rules.

Operation is subject to the following two conditions:

(1) this device may not cause harmful interference, and
(2) this device must accept any interference received, including interference that may cause undesired operation.

Note: This equipment has been tested and found to comply with the limits for a Class B digital device, pursuant to Part 15 of the FCC Rules. These limits are designed to provide reasonable protection against harmful interference in a residential installation. This equipment generates, uses, and can radiate radio frequency energy, and if not installed and used in accordance with the instructions, may cause harmful interference to radio communications. However, there is no guarantee that interference will not occur in

a particular installation. If this equipment does cause harmful interference to radio or television reception, which can be determined by turning the equipment off and on, the user is encouraged to try to correct the interference by one or more of the following measures:

- Reorient or relocate the receiving antenna.
- Increase the separation between the equipment and receiver.
- Connect the equipment into an outlet on a circuit different from that to which the receiver is connected.
- Consult the dealer or an experienced radio/TV technician for help.

This equipment complies with FCC radiation exposure limits set forth for an uncontrolled environment. This equipment should be installed and operated with minimum distance 20cm between the radiator & your body.

Canadian Compliance Statement —

This device contains licence-exempt transmitter(s)/receiver(s) that comply with Innovation, Science and Economic Development Canada's licence-exempt RSS(s).

Operation is subject to the following two conditions:

- (1) This device may not cause interference.
- (2) This device must accept any interference, including interference that may cause undesired operation of the device.

L'émetteur/récepteur exempt de licence contenu dans le présent appareil est conforme aux CNR d'Innovation, Sciences et Développement économique Canada applicables aux appareils radio exempts de licence.

L'exploitation est autorisée aux deux conditions suivantes :

- 1) L'appareil ne doit pas produire de brouillage;
- 2) L'appareil doit accepter tout brouillage radioélectrique subi, même si le brouillage est susceptible d'en compromettre le fonctionnement.

The device meets the exemption from the routine evaluation limits in section 2.5 of RSS 102 and compliance with RSS-102 RF exposure, users can obtain Canadian information on RF exposure and compliance.

Le dispositif rencontre l'exemption des limites courantes d'évaluation dans la section 2.5 de RSS 102 et la conformité à l'exposition de RSS-102 rf, utilisateurs peut obtenir l'information canadienne sur l'exposition et la conformité de rf.

This transmitter must not be co-located or operating in conjunction with any other antenna or transmitter. This equipment should be installed and operated with a minimum distance of 20 centimeters between the radiator and your body. Cet émetteur ne doit pas être Co-placé ou ne fonctionnant en même temps qu'aucune autre antenne ou émetteur. Cet équipement devrait être installé et actionné avec une distance minimum de 20 centimètres entre le radiateur et votre corps.

SIMPLE DEVICE SIMPLIFY YOUR LIFE

Email: support@meross.com

Website: www.meross.com

Designed in California. Made in China

Supervisor: MRTECH USA Limited

Address: 8825 53 Ave, Elmhurst, NY 11373, USA

Manufacturer: Chengdu Meross Technology Co., Ltd.

Address: Room 1312, Floor 13, Building 6-1, Zone E, Tianfu

Software Park, Gaoxin District, Chengdu, Sichuan, China



Made in China



Intertek

Warning

RISK OF ELECTRIC SHOCK OR FIRE.

- Make sure the power is OFF at the circuit breaker for the wall switch you are replacing.
The wall switch must be installed and used in accordance with the National Electric Code (NEC) or your local electrical code.

Installation Guide

Before We Get Started

- Replace single pole switch. Not compatible with 3 way or 4 way switch.
Neutral wire (white wire) is required. Only supports 2.4GHz WiFi networks.

1. Download the Meross app.



2. Hardware installation.

Note: You can also refer to the instructions in Meross app and follow it step by step.

- Make sure your traditional switch is single pole switch. This smart switch is not for 3 way or 4 way switches.
Place your smartphone near the traditional switch to make sure the location is covered by strong Wi-Fi signal.



- Remove the faceplate and pull out the traditional switch. Finding the neutral wire (usually white) in your electrical box. This smart switch requires a neutral wire to work.

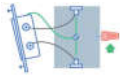

- Unscrew the wires and connect them according to picture below.

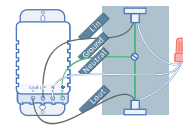

- Push the smart switch back into the box and turn the power on at the circuit breaker.

For more detailed information, please refer to the Meross app.

3. Set up the device.

- For Android user. Open Meross app and tap + on the top right. Just follow the instructions in Meross app and you will set it up in minutes.



- For iOS user. Please follow instructions below.
Please ensure that your iPhone or iPad is connecting to a 2.4GHz Wi-Fi. Or you may not be able to set it up.

- Use Apple Home app instead of Meross app to set it up. Just launch your Home app and tap "Add Accessory" or + on the top right and follow the instructions.



- After that, if you'd like to manage your MSS560 in Meross app, please connect to your home Wi-Fi and launch your Meross app and tap + on the top right.



- Note: 1. According to Apple HomeKit, the only way to set up HomeKit accessory with iOS is Home app.
2. If you can't setup the device with Home app, it might be that the iOS is having cache issue with HomeKit device.

You can also contact us at support@meross.com. We are always happy to help.

LED and Button Rules

Diagram of the device with labels for Brightness Button, Brightness LED, Power Button, Status LED, and Reboot Button. Includes instructions for each function.

MSS560XHk(US)

*本页针对专用, 不会印刷

Technical specifications table for MSS560XHk(US) including model, power, and manufacturer information.

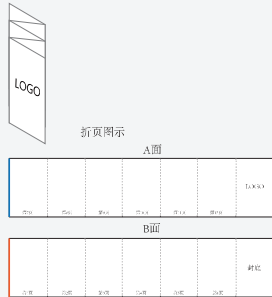

FAQ

- At Meross, we strive to assure your satisfaction. We are always happy to help at support@meross.com.
1. What should I do when I can't turn the wall switch on/off manually?
2. What should I do when my Meross app is unable to control the added Wall Switch?

- 4. Why my iOS will require me to use Home app when setting it up?
5. I can't pair my device with HomeKit anyhow.
Warranty
Disclaimer

- 2. By using any third-party services such as Amazon Alexa, Google Assistant, Apple HomeKit.
FCC Compliance Information Statement

- a particular installation, if this equipment does cause harmful interference to radio or television reception.
Canadian Compliance Statement

L'émetteur/récepteur exempt de licence contenu dans le présent appareil est conforme aux CNR d'Innovation, Sciences et Développement économique Canada applicables aux appareils radio exempts de licence.

SIMPLE DEVICE SIMPLIFY YOUR LIFE. Includes contact information for Meross support and website.

