

FCC RADIO TEST REPORT

Applicant..... : Summit Electronics LLC
Address..... : 1 Rewe Street, Brooklyn,New York,11211 United States
Manufacturer..... : Summit Electronics LLC
Address..... : 1 Rewe Street, Brooklyn,New York,11211 United States
Factory..... : Jenstar Industry Limited
Address..... : Room 402, No.8 Sixth Street Hekang New District, Changping, Dongguan
Product Name..... : True Wireless Speaker
Brand Name..... : COBY
Model No. : CSTW52FD, CSTW525A, CSTW525BK, CSTW525
(For model difference refer to section 2)
FCC ID..... : 2AMSOCSTW52FD1
Measurement Standard..... : 47 CFR FCC Part 15, Subpart C (Section 15.247)
Receipt Date of Samples..... : August 02, 2023
Date of Tested..... : August 02, 2023 to August 07, 2023
Date of Report..... : August 11, 2023

This report shows that above equipment is technically compliant with the requirements of the standards above. All test results in this report apply only to the tested sample(s). Without prior written approval of Dongguan Nore Testing Center Co., Ltd, this report shall not be reproduced except in full.



Prepared by

Rose Hu / Project Engineer



Approved by

Iori Fan / Authorized Signatory

Table of Contents

1. Summary of Test Result	4
2. General Description of EUT	5
3. Test Channels and Modes Detail	8
4. Configuration of EUT	8
5. Modification of EUT.....	8
6. Description of Support Device.....	9
7. Test Facility and Location	10
8. Applicable Standards and References	11
9. Deviations and Abnormalities from Standard Conditions.....	11
10. Test Conditions.....	12
11. Measurement Uncertainty	13
12. Sample Calculations	14
13. Test Items and Results	15
13.1 Conducted Emissions Measurement.....	15
13.2 Radiated Spurious Emissions and Restricted Bands Measurement	19
13.3 Channel Separation test.....	26
13.4 20dB Bandwidth.....	29
13.5 Hopping Channel Number.....	32
13.6 Time of Occupancy (Dwell Time)	34
13.7 Maximum Peak Output Power.....	37
13.8 Band Edge Conducted Spurious Emission Measurement	40
13.9 Antenna Requirement	44
14. Test Equipment List	45

Revision History

Report Number	Description	Issued Date
NTC2308011FV00	Initial Issue	2023-08-11

1. Summary of Test Result

FCC Rules	Description of Test	Result	Remarks
§15.247(a)(1)	Channel Separation test	PASS	---
§15.247(a)(1)	20dB Bandwidth	PASS	---
§15.247(a)(1)(iii)	Hopping Channel Number	PASS	---
§15.247(a)(1)(iii)	Time of Occupancy (Dwell Time)	PASS	---
§15.247(b)	Max Peak output Power test	PASS	---
§15.247(d)	Band edge test	PASS	---
§15.207 (a)	AC Power Conducted Emission	PASS	---
§15.247(d), §15.209, §15.205	Radiated Emission	PASS	---
§15.203	Antenna Requirement	PASS	---
§15.247(d)	Conducted Spurious Emission	PASS	---

2. General Description of EUT

Product Information	
Product name:	True Wireless Speaker
Main Model Name:	CSTW52FD
Additional Model Name:	CSTW525A, CSTW525BK, CSTW525
Model Difference:	These models have the same circuitry, electrical mechanical, PCB Layout and physical construction. The difference is model name due to marketing purpose.
S/N:	2308-3793
Brand Name	COBY
Hardware version:	Not Stated
Software version:	Not Stated
Rating:	DC 5V from USB Port or DC 3.7V from internal battery
Classification:	Class B
Typical arrangement:	Tabletop
I/O Port:	Refer to the user manual.
Accessories Information	
Adapter:	N/A
Cable:	USB Line: 0.45m, unshielded, detachable
Other:	N/A
Additional Information	
Note:	According to the model difference, all tests were performed on model CSTW52FD.
Remark:	All the information above are provided by the manufacturer. More detailed feature of the EUT please refers to the user manual.

Technical Specification	
Bluetooth Version:	V5.3
Frequency Range:	2402-2480MHz
Modulation Type:	GFSK, $\pi/4$ -DQPSK
Number of Channel:	79 (refer to following channel list for details)
Channel Space:	1MHz
Antenna Type:	PCB antenna
Antenna Gain:	-0.58 dBi (Declared by manufacturer)
Note:	The EUT does not support Bluetooth Low Energy feature in accordance with the manufacturer declaration.

Channel List							
Channel	Frequency (MHz)	Channel	Frequency (MHz)	Channel	Frequency (MHz)	Channel	Frequency (MHz)
1	2402	21	2422	41	2442	61	2462
2	2403	22	2423	42	2443	62	2463
3	2404	23	2424	43	2444	63	2464
4	2405	24	2425	44	2445	64	2465
5	2406	25	2426	45	2446	65	2466
6	2407	26	2427	46	2447	66	2467
7	2408	27	2428	47	2448	67	2468
8	2409	28	2429	48	2449	68	2469
9	2410	29	2430	49	2450	69	2470
10	2411	30	2431	50	2451	70	2471
11	2412	31	2432	51	2452	71	2472
12	2413	32	2433	52	2453	72	2473
13	2414	33	2434	53	2454	73	2474
14	2415	34	2435	54	2455	74	2475
15	2416	35	2436	55	2456	75	2476
16	2417	36	2437	56	2457	76	2477
17	2418	37	2438	57	2458	77	2478
18	2419	38	2439	58	2459	78	2479
19	2420	39	2440	59	2460	79	2480
20	2421	40	2441	60	2461	---	---

3. Test Channels and Modes Detail

No.	Mode	Channel	Frequency (MHz)	Modulation
1	TX	Hopping	2402~2480	GFSK/π/4-DQPSK
2	TX	Low	2402	GFSK/π/4-DQPSK
3	TX	Mid	2441	GFSK/π/4-DQPSK
4	TX	High	2480	GFSK/π/4-DQPSK
5.	BT Link	---	---	---

Note: TX mode means that the EUT was programmed to be in continuously transmitting mode.

4. Configuration of EUT

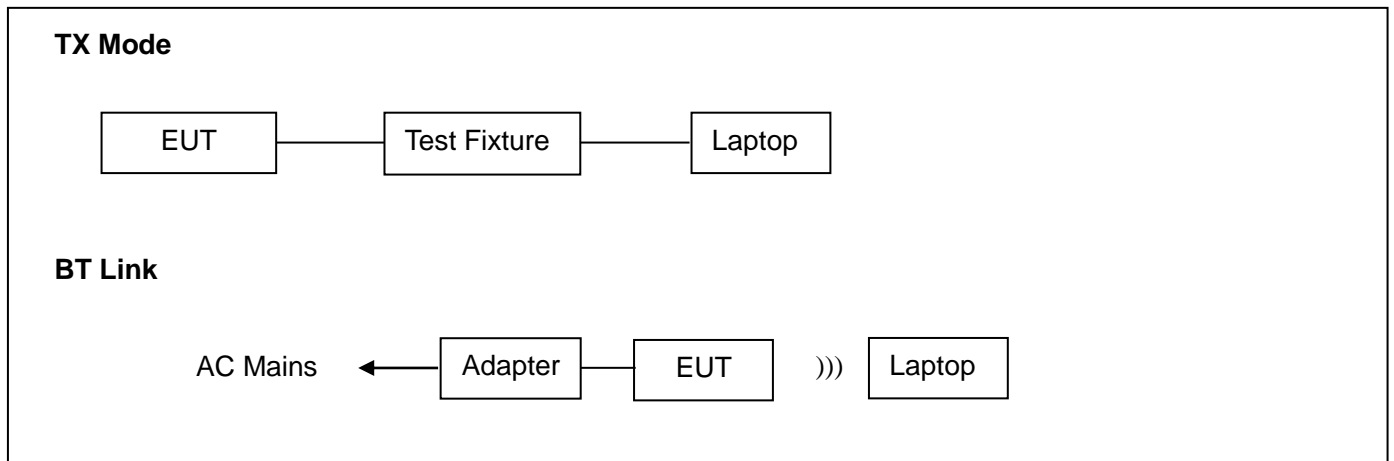

5. Modification of EUT

No modifications are made to the EUT during all test items.

6. Description of Support Device

The EUT has been tested as an independent unit together with other necessary accessories or support units. The following support units or accessories were used to form a representative test configuration during the tests.

No.	Equipment	Brand	M/N	S/N	Cable Specification	Remarks
1.	Laptop	Lenovo	R720-151KBN	PF0Z35FH	Power cord, 1.8m, unshielded	Provided by the lab
2.	Power supply (Laptop)	Delta	ADL135NDC3A	---		Provided by the lab
3.	Test fixture	---	---	---	----	Provided by manufacturer
4.	Adapter	HUAWEI	HW-050200C01	---	Input: AC100-240V 50/60Hz, 0.5A Output: DC 5V 2A	Provided by the lab

No.	Test Software	Modulation	Power Setting
1.	FCC_assist_1.0.2.2	GFSK	10
2.		$\pi/4$ -DQPSK	10

7. Test Facility and Location

Test Site	:	Dongguan Nore Testing Center Co., Ltd. (Dongguan NTC Co., Ltd.)
Accreditations and Authorizations	:	<p>The Laboratory has been assessed and proved to be in compliance with CNAS/CL01 Listed by CNAS, August 13, 2018 The Certificate Registration Number is L5795. The Certificate is valid until August 13, 2024</p> <p>The Laboratory has been assessed and proved to be in compliance with ISO17025 Listed by A2LA, November 01, 2017 The Certificate Registration Number is 4429.01</p> <p>Listed by FCC, November 06, 2017 Test Firm Registration Number: 907417</p> <p>Listed by Industry Canada, June 08, 2017 The Certificate Registration Number. Is 46405-9743A</p>
Test Site Location	:	Building D, Gaosheng Science and Technology Park, Hongtu Road, Nancheng District, Dongguan City, Guangdong Province, China

8. Applicable Standards and References

According to the specifications of the manufacturer, the EUT must comply with the requirements of the following standards:

Test Standards:

47 CFR Part 15, Subpart C, 15.247

ANSI C63.10-2013

References Test Guidance:

DTS KDB 558074 D01 15.247 Meas Guidance v05r02

Remark:

The EUT has also been tested and complied with the requirements of FCC Part 15, Subpart B, recorded in a separate test report.

9. Deviations and Abnormalities from Standard Conditions

No additions, deviations and exclusions from the standard.

10. Test Conditions

No.	Test Item	Test Mode	Test Voltage	Tested by	Remarks
1.	Channel Separation test	1	DC 3.7V	Sean	See note ¹
2.	20dB Bandwidth	2-4	DC 3.7V	Sean	See note ¹
3.	Hopping Channel Number	1	DC 3.7V	Sean	See note ¹
4.	Time of Occupancy (Dwell Time)	1	DC 3.7V	Sean	See note ¹
5.	Max Peak output Power test	2-4	DC 3.7V	Sean	See note ¹
6.	Band edge test	1-4	DC 3.7V	Sean	See note ¹
7.	AC Power Conducted Emission	5	AC 120V 60Hz	Sean	See note ¹
8.	Radiated Emission	1-5	AC 120V 60Hz DC 3.7V	Sean	See note ¹
9.	Antenna Requirement	---	---	---	---
10.	Conducted Spurious Emission	1-4	DC 3.7V	Sean	See note ¹

Note:

1. The testing climatic conditions for temperature, humidity, and atmospheric pressure are within: 15~35°C, 30~70%, 86~106kPa
2. For test voltage, only the worst case was recorded in this report.
3. For test voltage AC 120V 60Hz was come from the Adapter.

11. Measurement Uncertainty

No.	Test Item	Frequency	Uncertainty	Remarks
1.	Conducted Emission	150KHz ~ 30MHz	±2.52 dB	---
2.	Radiated Emission Test	9kHz ~ 30MHz	±5.66 dB	
		30MHz ~ 1GHz	±5.66 dB	---
		1GHz ~ 18GHz	±5.19 dB	---
		18GHz ~ 40GHz	±5.19 dB	---
3.	RF Conducted Test	10Hz ~ 40GHz	±1.18 dB	---

Note:

1. This uncertainty represents an expanded uncertainty expressed at approximately the 95% confidence level using a coverage factor of k=2.
2. The measurement uncertainty levels above are estimated and calculated according to CISPR 16-4-2.
3. The conformity assessment statement in this report is based solely on the test results, measurement uncertainty is excluded.

12. Sample Calculations

Conducted Emission						
Freq. (MHz)	Reading Level (dBuV)	Correct Factor (dB)	Measurement (dBuV)	Limit (dBuV)	Over (dB)	Detector
0.1500	28.51	10.59	39.10	66.00	-26.90	QP

Where,

Freq. = Emission frequency in MHz
 Reading Level = Spectrum Analyzer/Receiver Reading
 Corrector Factor = Insertion loss of LISN + Cable Loss + RF Switching Unit attenuation
 Measurement = Reading + Corrector Factor
 Limit = Limit stated in standard
 Margin = Measurement - Limit
 Detector = Reading for Quasi-Peak / Average / Peak

Radiated Spurious Emissions and Restricted Bands						
Freq. (MHz)	Reading Level (dBuV)	Correct Factor (dB/m)	Measurement (dBuV/m)	Limit (dBuV/m)	Over (dB)	Detector
30.0000	34.19	-10.69	23.50	40.00	-16.50	QP

Where,

Freq. = Emission frequency in MHz
 Reading Level = Spectrum Analyzer/Receiver Reading
 Corrector Factor = Antenna Factor + Cable Loss - Pre-amplifier
 Measurement = Reading + Corrector Factor
 Limit = Limit stated in standard
 Over = Margin, which calculated by Measurement - Limit
 Detector = Reading for Quasi-Peak / Average / Peak

Note: For all conducted test items, the spectrum analyzer offset or transducer is derived from RF cable loss and attenuator factor. The offset or transducer is equal to the RF cable loss plus attenuator factor.

13. Test Items and Results

13.1 Conducted Emissions Measurement

LIMIT

According to the requirements of FCC PART 15.207, the limits are as follows:

Frequency (MHz)	Quasi-peak	Average
0.15 to 0.5	66 to 56	56 to 46
0.5 to 5	56	46
5 to 30	60	50

- Note:
1. If the limits for the average detector are met when using the quasi-peak detector, then the limits for the measurements with the average detector are considered to be met.
 2. The lower limit shall apply at the transition frequencies.
 3. The limit decreases linearly with the logarithm of the frequency in the range 0.15 MHz to 0.5MHz.

BLOCK DIAGRAM OF TEST SETUP

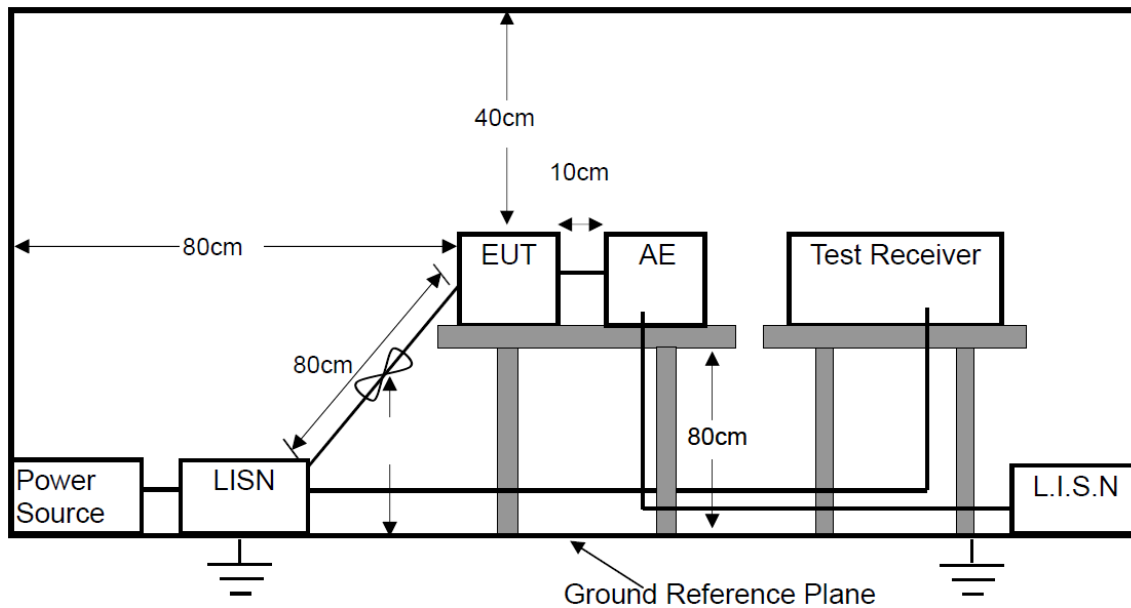

TEST PROCEDURES

- a. The EUT was placed on a wooden table 0.8m height from the metal ground plan and 0.4m from the conducting wall of the shielding room and it was kept at 0.8m from any other grounded conducting surface.
- b. All I/O cables and support devices were positioned as per ANSI C63.10.
- c. Connect mains power port of the EUT to a line impedance stabilization network (LISN).
- d. Connect all support devices to the other LISN and AAN, if needed.
- e. Scan the frequency range from 150KHz to 30MHz at both sides of AC line for maximum conducted interference checking and record the test data.

TEST RESULTS

PASS

Please refer to the following pages.

M/N: CSTW52FD	Testing Voltage: AC 120V/60Hz
Phase: L1	Detector: QP & AVG
Test Mode: 5	

Conducted Emission Measurement

Date: 2023/8/3

Time: 14:03:33

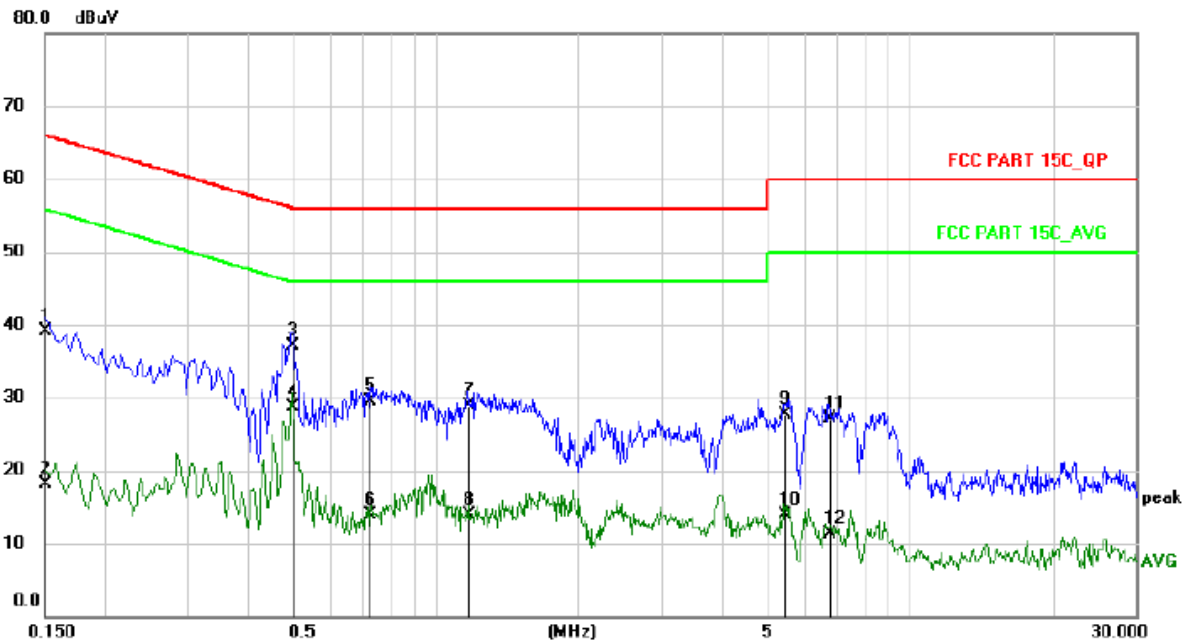

No. Mk.	Freq.	Reading Level	Correct Factor	Measurement	Limit	Over	Detector	Comment
	MHz	dBuV	dB	dBuV	dBuV	dB		
1	0.1500	28.51	10.59	39.10	66.00	-26.90	QP	
2	0.1500	7.61	10.59	18.20	56.00	-37.80	AVG	
3	0.4980	26.49	10.61	37.10	56.03	-18.93	QP	
4 *	0.4980	18.18	10.61	28.79	46.03	-17.24	AVG	
5	0.7259	18.81	10.61	29.42	56.00	-26.58	QP	
6	0.7259	3.21	10.61	13.82	46.00	-32.18	AVG	
7	1.1659	18.37	10.61	28.98	56.00	-27.02	QP	
8	1.1659	3.27	10.61	13.88	46.00	-32.12	AVG	
9	5.4419	17.10	10.65	27.75	60.00	-32.25	QP	
10	5.4419	3.30	10.65	13.95	50.00	-36.05	AVG	
11	6.7419	16.49	10.66	27.15	60.00	-32.85	QP	
12	6.7419	0.56	10.66	11.22	50.00	-38.78	AVG	

M/N: CSTW52FD	Testing Voltage: AC 120V/60Hz
Phase: N	Detector: QP & AVG
Test Mode: 5	

Conducted Emission Measurement

Date: 2023/8/3

Time: 14:10:02

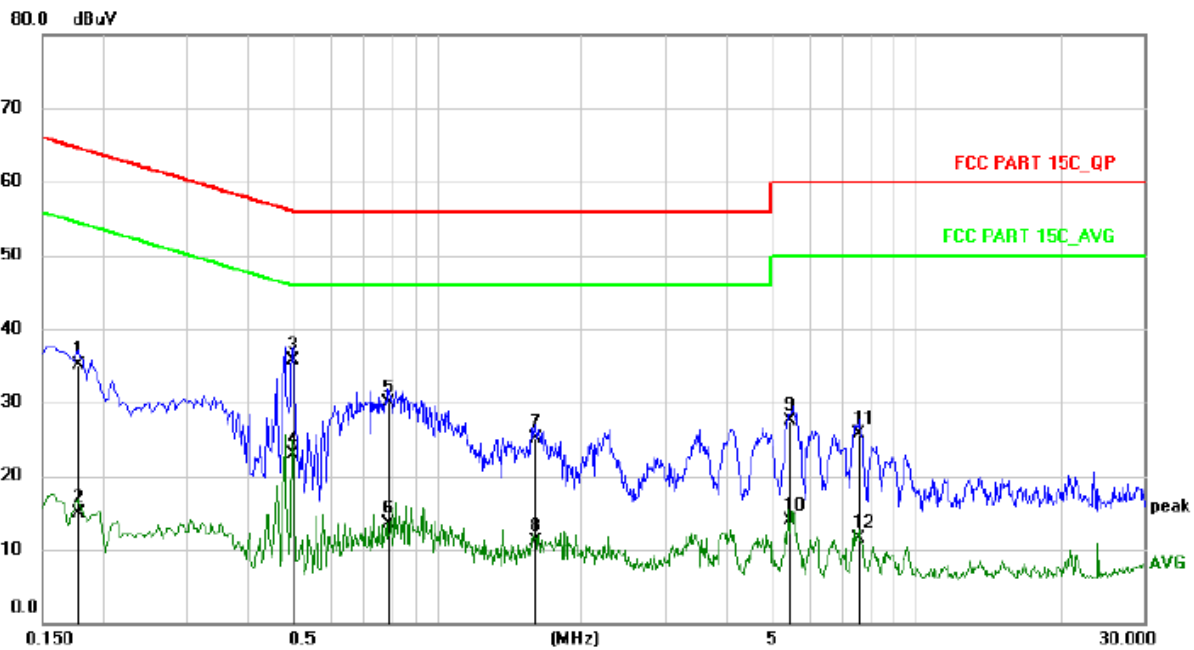

No. Mk.	Freq. MHz	Reading Level dBuV	Correct Factor dB	Measure- ment dBuV	Limit dBuV	Over dB	Detector	Comment
1	0.1779	24.56	10.56	35.12	64.58	-29.46	QP	
2	0.1779	4.44	10.56	15.00	54.58	-39.58	AVG	
3 *	0.4979	25.21	10.57	35.78	56.03	-20.25	QP	
4	0.4979	12.36	10.57	22.93	46.03	-23.10	AVG	
5	0.7900	19.26	10.57	29.83	56.00	-26.17	QP	
6	0.7900	2.88	10.57	13.45	46.00	-32.55	AVG	
7	1.6019	14.63	10.57	25.20	56.00	-30.80	QP	
8	1.6019	0.45	10.57	11.02	46.00	-34.98	AVG	
9	5.4459	16.82	10.61	27.43	60.00	-32.57	QP	
10	5.4459	3.21	10.61	13.82	50.00	-36.18	AVG	
11	7.5700	14.99	10.62	25.61	60.00	-34.39	QP	
12	7.5700	0.86	10.62	11.48	50.00	-38.52	AVG	

13.2 Radiated Spurious Emissions and Restricted Bands Measurement

LIMIT

Frequency range MHz	Distance Meters	Field Strengths Limit (15.209)
		$\mu\text{V/m}$
0.009 ~ 0.490	300	2400/F(kHz)
0.490 ~ 1.705	30	24000/F(kHz)
1.705 ~ 30	30	30
30 ~ 88	3	100
88 ~ 216	3	150
216 ~ 960	3	200
Above 960	3	500

- Remark:
- (1) Emission level (dB) μV = 20 log Emission level $\mu\text{V/m}$
 - (2) The smaller limit shall apply at the cross point between two frequency bands.
 - (3) As shown in 15.35(b), for frequencies above 1000MHz, the field strength limits are based on average detector, however, the peak field strength of any emission shall not exceed the maximum permitted average limits, specified above by more than 20dB under any condition of modulation.
 - (4) The frequency range scanned is from the lowest radio frequency signal generated in the device which is greater than 9 kHz to the tenth harmonic of the highest fundamental frequency or 40 GHz, whichever is lower.
 - (5) §15.247(d) specifies that emissions which fall in the restricted bands, as defined in §15.205 comply with radiated emission limits specified in §15.209.

BLOCK DIAGRAM OF TEST SETUP

For Radiated Emission below 30MHz

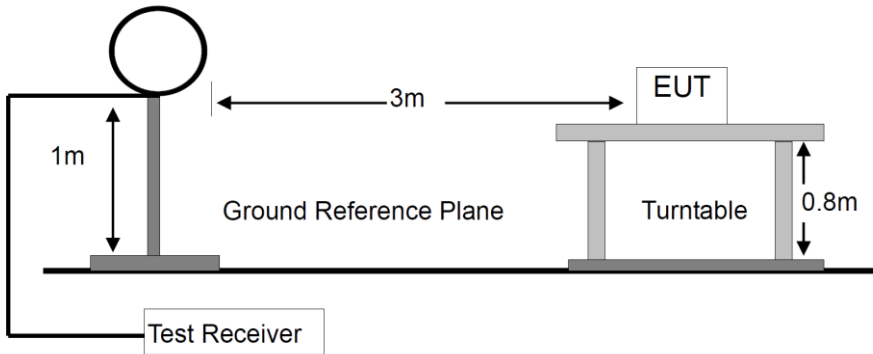

For Radiated Emission 30-1000MHz

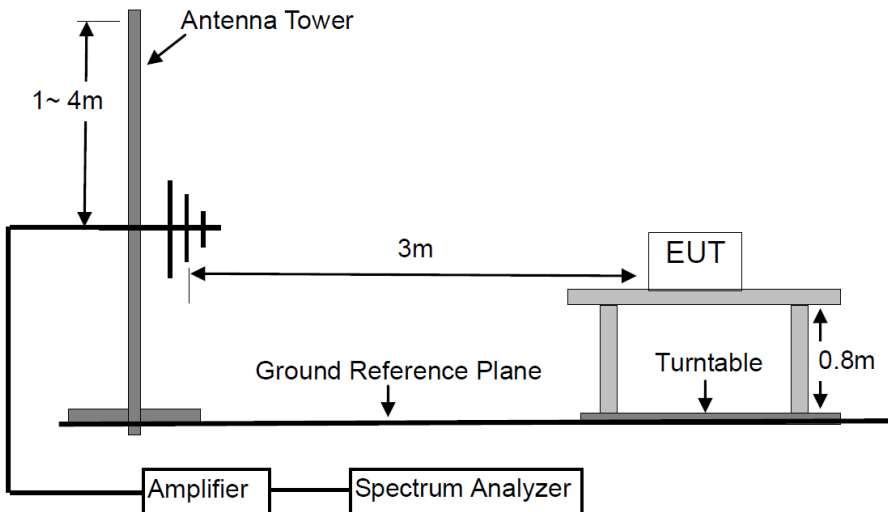

For Radiated Emission Above 1000MHz.

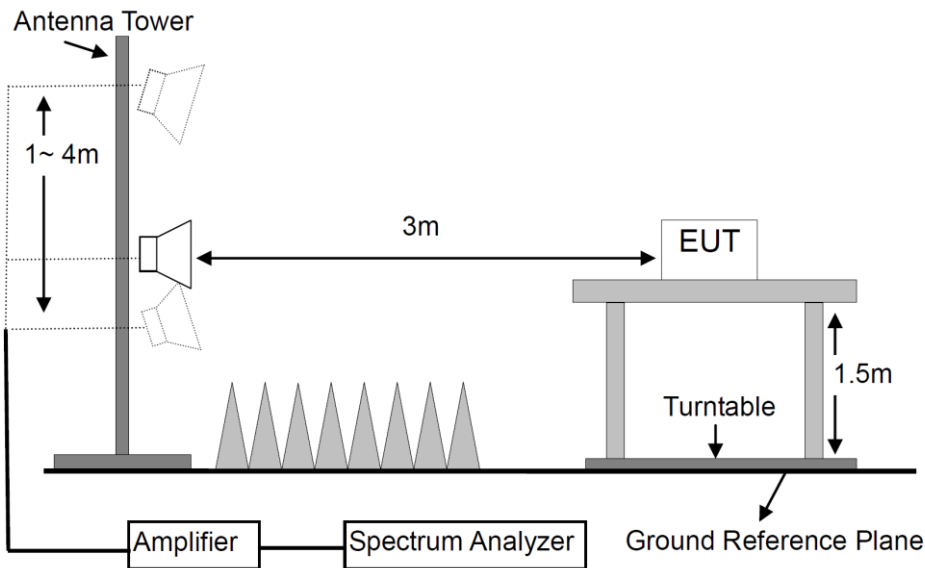

TEST PROCEDURES

- a. Below 1GHz, the EUT was placed on the top of a rotating table 0.8 meters above the ground at a 3 meters semi- anechoic chamber room.
- b. For the radiated emission test above 1GHz:

The EUT was placed on the top of a rotating table 1.5 meters above the ground at a 3 meters full anechoic chamber room. The table was rotated 360 degrees to determine the position of the highest radiation. Place the measurement antenna away from each area of the EUT determined to be a source of emissions at the specified measurement distance, while keeping the measurement antenna aimed at the source of emissions at each frequency of significant emissions, with polarization oriented for maximum response. The measurement antenna may have to be higher or lower than the EUT, depending on the radiation pattern of the emission and staying aimed at the emission source for receiving the maximum signal. The final measurement antenna elevation shall be that which maximizes the emissions. The measurement antenna elevation for maximum emissions shall be restricted to a range of heights of from 1 m to 4 m above the ground or reference ground plane.
- c. The EUT was set 3 meters away from the interference-receiving antenna, which was mounted on the top of a variable-height antenna tower.

- d. The height of antenna is varied from one meter to four meters above the ground to determine the maximum value of the field strength. Both horizontal and vertical polarizations of the antenna are set to make the measurement.
- e. For each suspected emission, the EUT was arranged to its worst case and then the antenna was tuned to heights from 1 meter to 4 meters and the rotatable table was turned from 0 degrees to 360 degrees to find the maximum reading. The test-receiver system was set to peak detect function and specified bandwidth with maximum hold mode.
- f. A Quasi-peak measurement was then made for that frequency point for below 1GHz test. PK and AV for above 1GHz emission test.

During the radiated emission test, the spectrum analyzer was set with the following configurations:

Frequency Band (MHz)	Detector	Resolution Bandwidth	Video Bandwidth
30 to 1000	QP	120 kHz	300 kHz
Above 1000	Peak	1 MHz	3 MHz
	Average	1 MHz	10 Hz

TEST RESULTS

PASS

Please refer to the following pages.

M/N: CSTW52FD	Testing Voltage: AC 120V 60Hz
Polarization: Horizontal	Detector: QP
Test Mode: 5	Distance: 3m

Radiated Emission Measurement

Date: 2023/8/2

Time: 21:37:08

80.0 dBuV/m

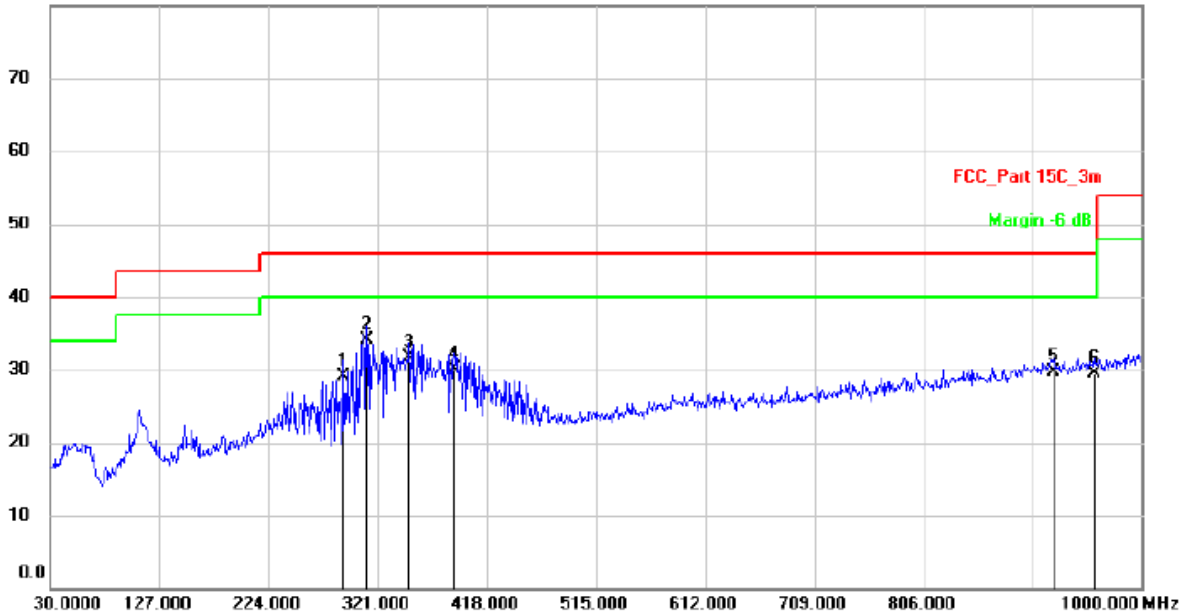

No.	Mk.	Freq. MHz	Reading Level dBuV	Correct Factor dB/m	Measure- ment dBuV/m	Limit dBuV/m	Over dB	Detector	Comment
1		290.9300	34.91	-5.71	29.20	46.00	-16.80	QP	
2	*	311.3000	39.32	-5.22	34.10	46.00	-11.90	QP	
3		349.1300	35.87	-4.17	31.70	46.00	-14.30	QP	
4		388.9000	33.76	-3.56	30.20	46.00	-15.80	QP	
5		921.4300	23.46	6.24	29.70	46.00	-16.30	QP	
6		957.3200	23.30	6.30	29.60	46.00	-16.40	QP	

Note: Below 30MHz, the emissions are lower than 20dB below the allowable limit.

M/N: CSTW52FD	Testing Voltage: AC 120V 60Hz
Polarization: Vertical	Detector: QP
Test Mode: 5	Distance: 3m

Radiated Emission Measurement

Date: 2023/8/2

Time: 21:31:39

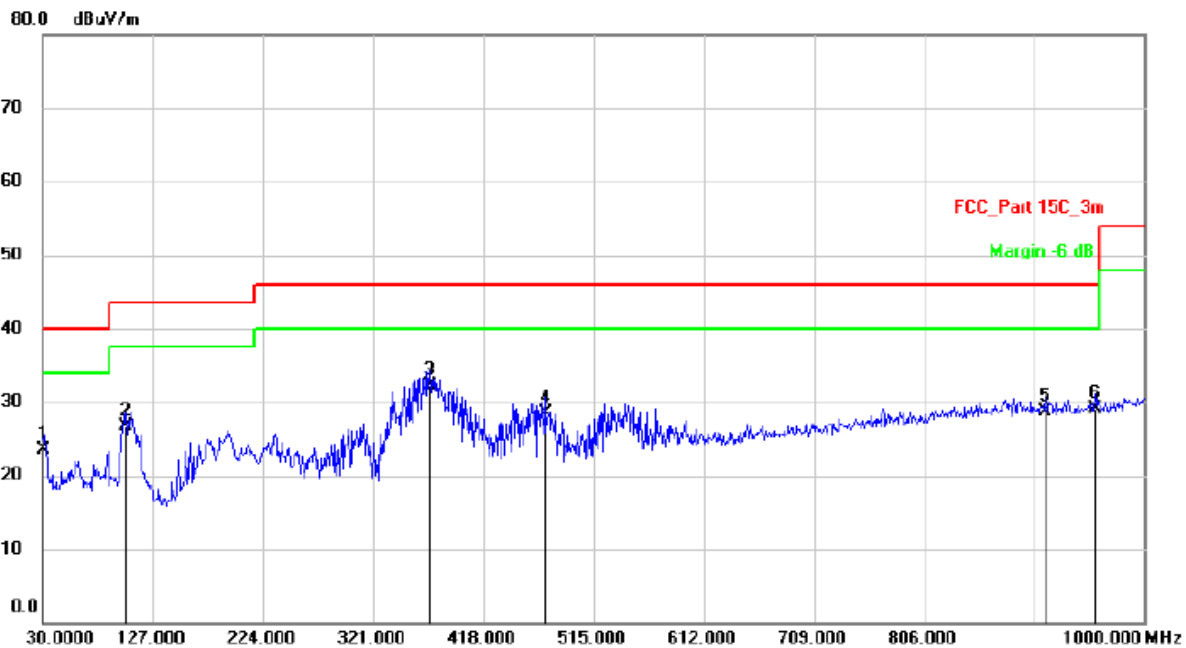

No.	Mk.	Freq. MHz	Reading Level dBuV	Correct Factor dB/m	Measure- ment dBuV/m	Limit dBuV/m	Over dB	Detector	Comment
1		30.0000	34.19	-10.69	23.50	40.00	-16.50	QP	
2		102.7500	35.61	-8.91	26.70	43.50	-16.80	QP	
3	*	370.4700	37.17	-4.87	32.30	46.00	-13.70	QP	
4		472.3200	31.79	-3.19	28.60	46.00	-17.40	QP	
5		912.7000	23.73	4.97	28.70	46.00	-17.30	QP	
6		956.3500	23.99	5.11	29.10	46.00	-16.90	QP	

Note: Below 30MHz, the emissions are lower than 20dB below the allowable limit.

Modulation: $\pi/4$ -DQPSK (the worst case)				Test Result: PASS			Test frequency range: 1-25GHz			
Freq. (MHz)	Ant. Pol. (H/V)	Reading Level(dBuV)		Factor (dB/m)	Emission Level (dBuV/m)		Limit 3m (dBuV/m)		Margin (dB)	
		PK	AV		PK	AV	PK	AV	PK	AV
Operation Mode: TX Mode (Low)										
4804	V	46.68	35.75	6.30	52.98	42.05	74.00	54.00	-21.02	-11.95
7206	V	45.78	31.44	10.44	56.22	41.88	74.00	54.00	-17.78	-12.12

4804	H	53.21	42.12	6.30	59.51	48.42	74.00	54.00	-14.49	-5.58
7206	H	46.08	31.92	10.44	56.52	42.36	74.00	54.00	-17.48	-11.64

Operation Mode: TX Mode (Mid)										
4882	V	46.29	32.06	6.60	52.89	38.66	74.00	54.00	-21.11	-15.34
7323	V	45.45	31.36	10.55	56.00	41.91	74.00	54.00	-18.00	-12.09

4882	H	53.59	41.92	6.60	60.19	48.52	74.00	54.00	-13.81	-5.48
7323	H	45.75	31.50	10.55	56.30	42.05	74.00	54.00	-17.70	-11.95

Operation Mode: TX Mode (High)										
4960	V	45.68	34.35	6.89	52.57	41.24	74.00	54.00	-21.43	-12.76
7440	V	44.62	30.71	10.60	55.22	41.31	74.00	54.00	-18.78	-12.69

4960	H	51.54	40.86	6.89	58.43	47.75	74.00	54.00	-15.57	-6.25
7440	H	44.89	30.92	10.60	55.49	41.52	74.00	54.00	-18.51	-12.48

Spurious Emission in restricted band:										
2390.000	V	51.67	34.62	0.09	51.76	34.71	74.00	54.00	-22.24	-19.29
2390.000	H	48.86	34.03	0.09	48.95	34.12	74.00	54.00	-25.05	-19.88
2483.500	V	52.02	34.75	0.34	52.36	35.09	74.00	54.00	-21.64	-18.91
2483.500	H	58.50	34.80	0.34	58.84	35.14	74.00	54.00	-15.16	-18.86
Remark: Data of measurement within this frequency range shown "---" in the table above means the reading of emissions are attenuated more than 20dB below the permissible limits.										

13.3 Channel Separation test

LIMIT

Frequency hopping systems operating in the 2400-2483.5 MHz band may have hopping channel carrier frequencies that are separated by 25 kHz or two-thirds of the 20 dB bandwidth of the hopping channel, whichever is greater.

BLOCK DIAGRAM OF TEST SETUP

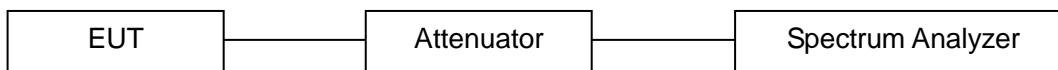

TEST PROCEDURES

- a. The RF output of EUT was connected to the spectrum analyzer by RF cable and attenuator. The path loss was compensated to the results for each measurement.
- b. Set to the maximum power setting and enable the EUT transmit continuously.
- c. Enable the EUT hopping function.
- d. Set spectrum analyzer and perform testing according to ANSI C63.10-2013 clause 7.8.2.

TEST RESULTS

PASS

Please refer to the following table.

Modulation	Channel	Frequency (MHz)	Hopping Separation Measurement (MHz)	Hopping Separation Limit (MHz)	Test Result
GFSK	Low	2402	0.999	>0.6927	Pass
	Mid	2441	1.002	>0.6967	Pass
	High	2480	1.002	>0.7007	Pass
π/4-DQPSK	Low	2402	1.002	>0.8833	Pass
	Mid	2441	1.002	>0.8867	Pass
	High	2480	1.002	>0.8893	Pass

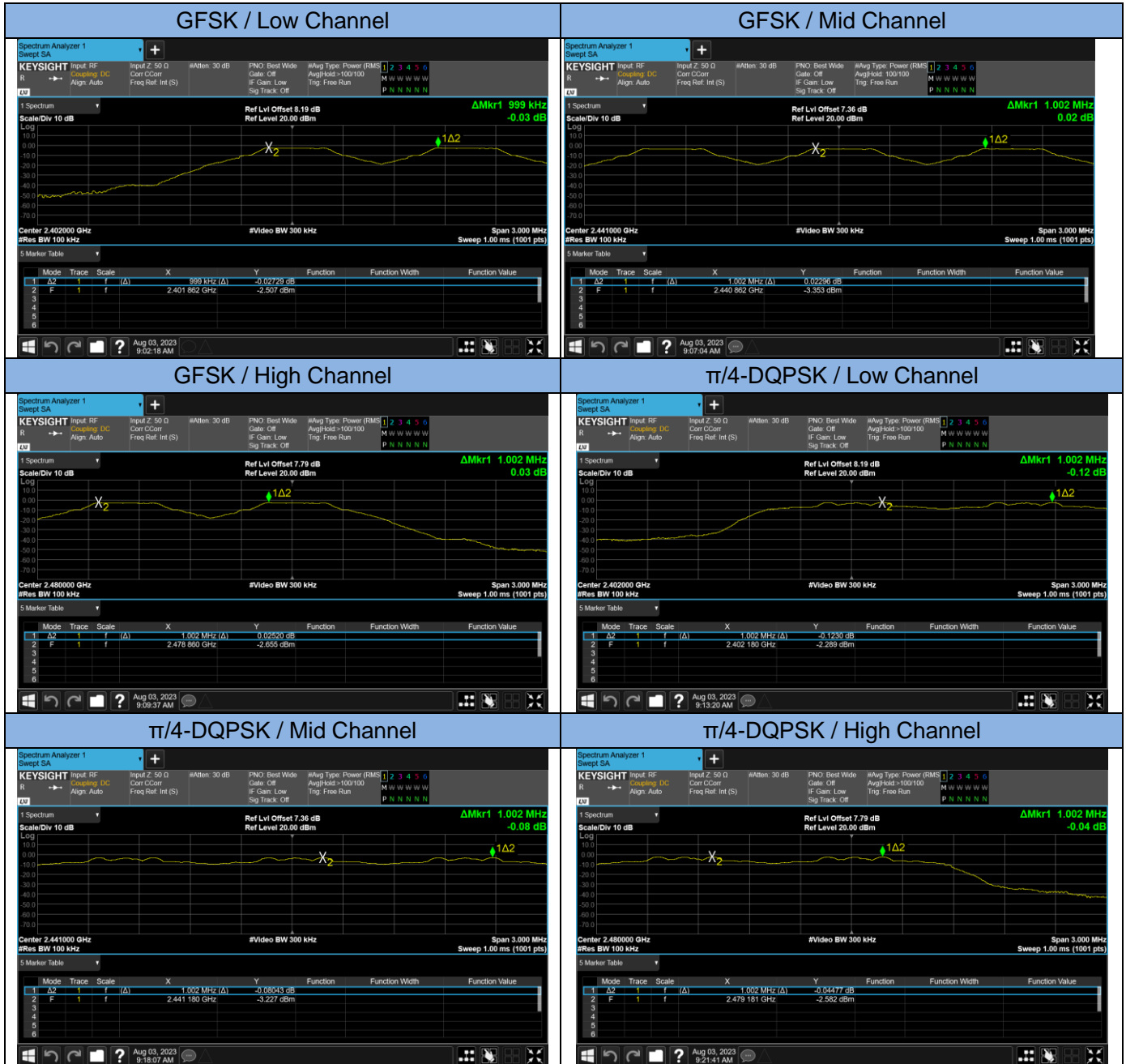

13.4 20dB Bandwidth

LIMIT

N/A

BLOCK DIAGRAM OF TEST SETUP

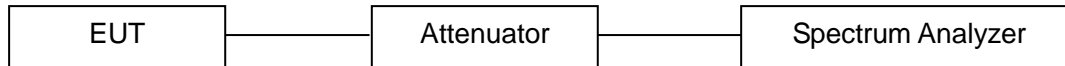

TEST PROCEDURES

- a. The RF output of EUT was connected to the spectrum analyzer by RF cable and attenuator. The path loss was compensated to the results for each measurement.
- b. Set to the maximum power setting and enable the EUT transmit continuously.
- c. Set spectrum analyzer and perform testing according to ANSI C63.10-2013 clause 6.9.2.

TEST RESULTS

PASS

Please refer to the following table.

Modulation	Channel	Frequency (MHz)	20dB Measurement (MHz)	Limit (MHz)	Remark
GFSK	Low	2402	1.039	---	Reporting only
	Mid	2441	1.045	---	
	High	2480	1.051	---	
$\pi/4$ -DQPSK	Low	2402	1.325	---	
	Mid	2441	1.330	---	
	High	2480	1.334	---	

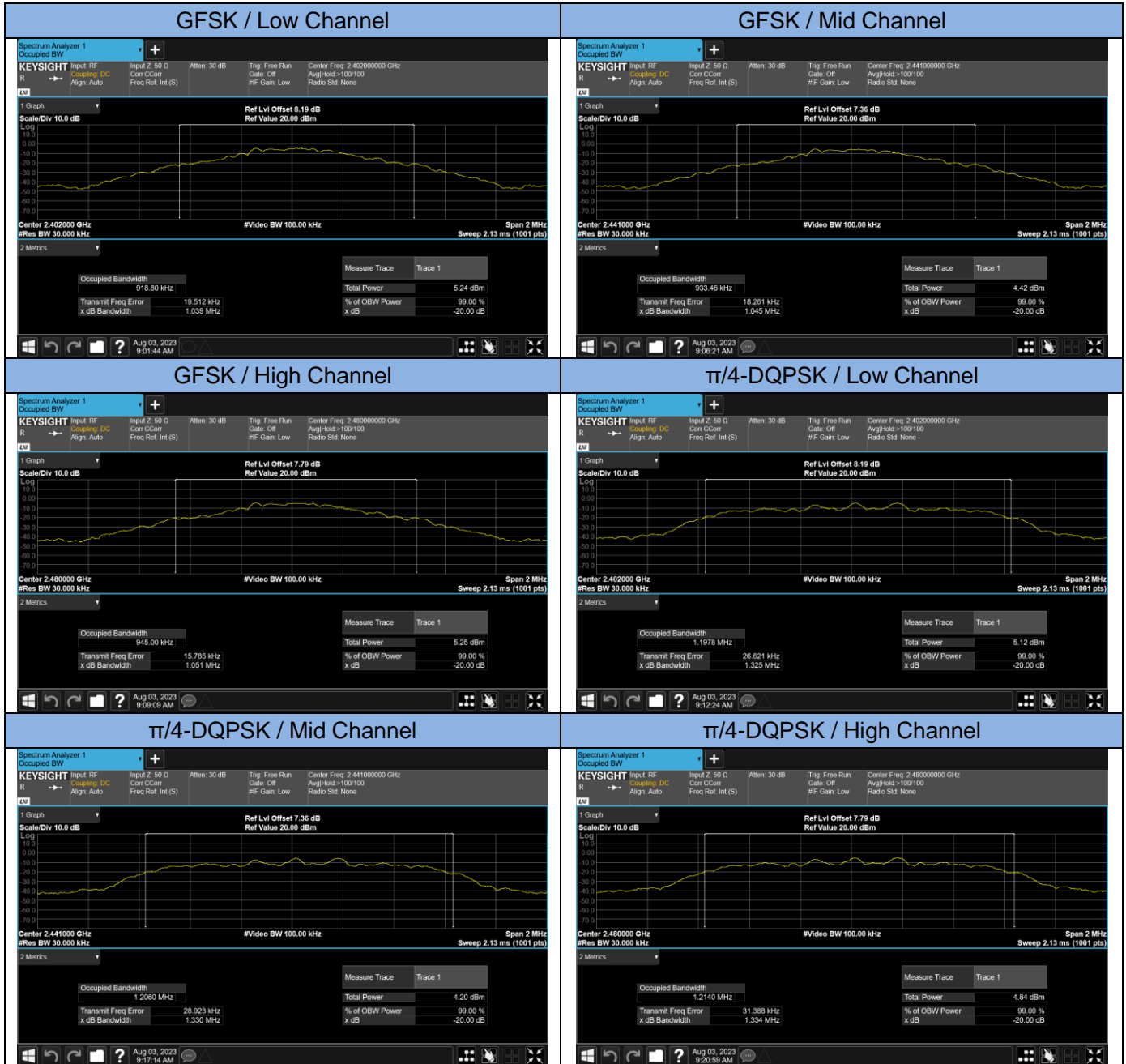

13.5 Hopping Channel Number

LIMIT

Frequency hopping systems in the 2400-2483.5MHz band shall use at least 15 channels.

BLOCK DIAGRAM OF TEST SETUP

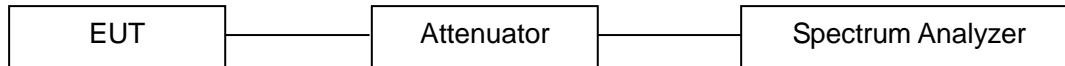

TEST PROCEDURES

- a. The RF output of EUT was connected to the spectrum analyzer by RF cable and attenuator. The path loss was compensated to the results for each measurement.
- b. Set to the maximum power setting and enable the EUT transmit continuously.
- c. Enable the EUT hopping function.
- d. Set spectrum analyzer and perform testing according to ANSI C63.10-2013 clause 7.8.3.

TEST RESULTS

PASS

Please refer to the following table.

Modulation	Number of Hopping Channels Measurement	Limit	Test Result
GFSK	79	≥15	PASS
π/4-DQPSK	79	≥15	PASS

The worst case: π/4-DQPSK

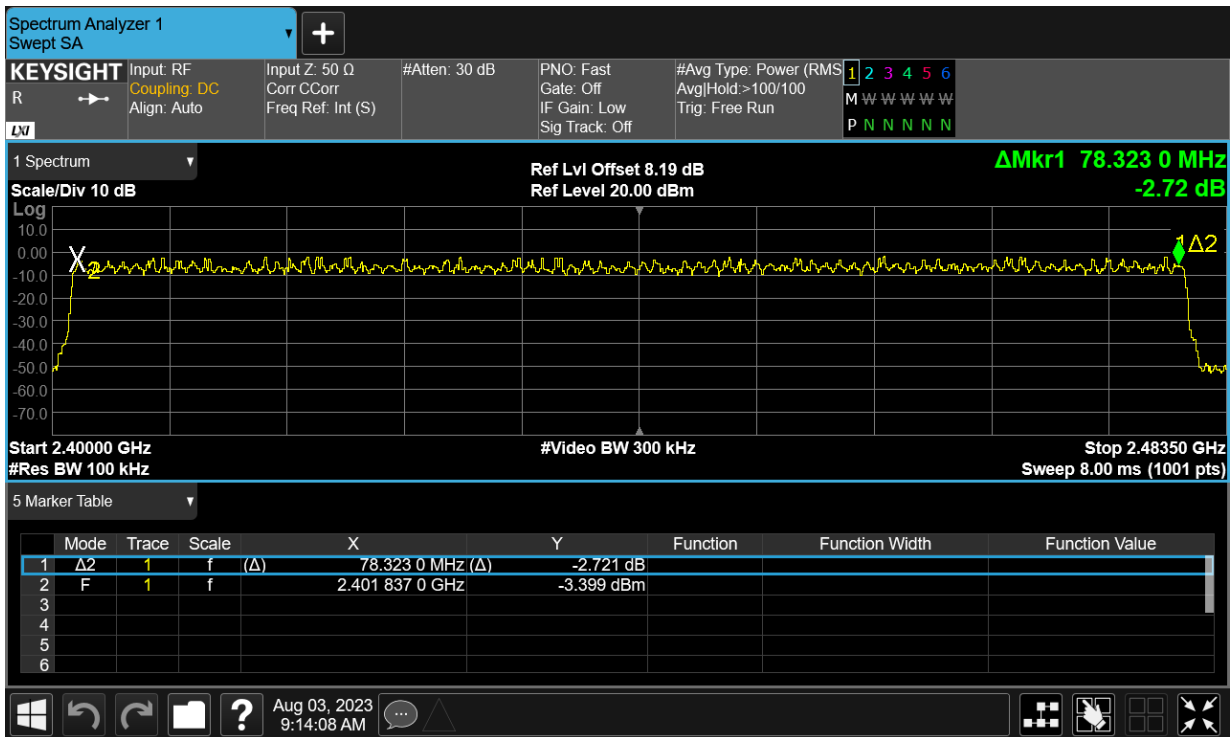

13.6 Time of Occupancy (Dwell Time)

LIMIT

The average time of occupancy on any channel shall not be greater than 0.4 seconds within a period of 0.4 seconds multiplied by the number of hopping channels employed.

BLOCK DIAGRAM OF TEST SETUP

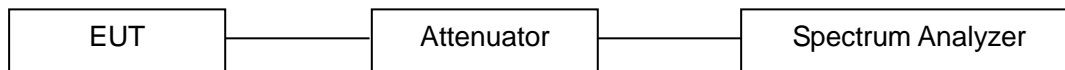

TEST PROCEDURES

- a. The RF output of EUT was connected to the spectrum analyzer by RF cable and attenuator. The path loss was compensated to the results for each measurement.
- b. Set to the maximum power setting and enable the EUT transmit continuously.
- c. Enable the EUT hopping function.
- d. Set spectrum analyzer and perform testing according to ANSI C63.10-2013 clause 7.8.4.

TEST RESULTS

PASS

Please refer to the following table.

Modulation	Packet	Frequency (MHz)	Dwell Time Measurement (msec)	Limit (msec)	Test Result
GFSK	DH1	2441	0.377 (ms)*(1600/(2*79))*31.6= 120.64	400	Pass
	DH3	2441	1.630 (ms)*(1600/(4*79))*31.6= 260.80	400	Pass
	DH5	2441	2.878 (ms)*(1600/(6*79))*31.6= 306.99	400	Pass
π/4-DQPSK	2-DH1	2441	0.388 (ms)*(1600/(2*79))*31.6= 124.16	400	Pass
	2-DH3	2441	1.635 (ms)*(1600/(4*79))*31.6= 261.60	400	Pass
	2-DH5	2441	2.885 (ms)*(1600/(6*79))*31.6= 307.73	400	Pass



13.7 Maximum Peak Output Power

LIMIT

The maximum peak conducted output power of the intentional radiator shall not exceed the following: For frequency hopping systems operating in the 2400-2483.5 MHz band employing at least 75 non-overlapping hopping channels, and all frequency hopping systems in the 5725-5850 MHz band: 1 watt. For all other frequency hopping systems in the 2400-2483.5 MHz band 0.125 watts.

BLOCK DIAGRAM OF TEST SETUP

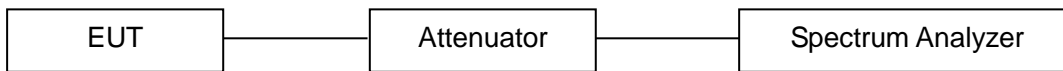

TEST PROCEDURES

- a. The RF output of EUT was connected to the spectrum analyzer by RF cable and attenuator. The path loss was compensated to the results for each measurement.
- b. Set to the maximum power setting and enable the EUT transmit continuously.
- c. Set spectrum analyzer and perform testing according to ANSI C63.10-2013 clause 7.8.5.

TEST RESULTS

PASS

Please refer to the following table.

Modulation	Frequency (MHz)	Peak Power output Measurement (dBm)	Peak Power output Measurement (mW)	Peak Power Limit (dBm)	Test Result
GFSK	2402.00	-2.32	0.59	21	Pass
	2441.00	-3.10	0.49	21	Pass
	2480.00	-2.31	0.59	21	Pass
$\pi/4$ -DQPSK	2402.00	-1.39	0.73	21	Pass
	2441.00	-2.06	0.62	21	Pass
	2480.00	-1.38	0.73	21	Pass

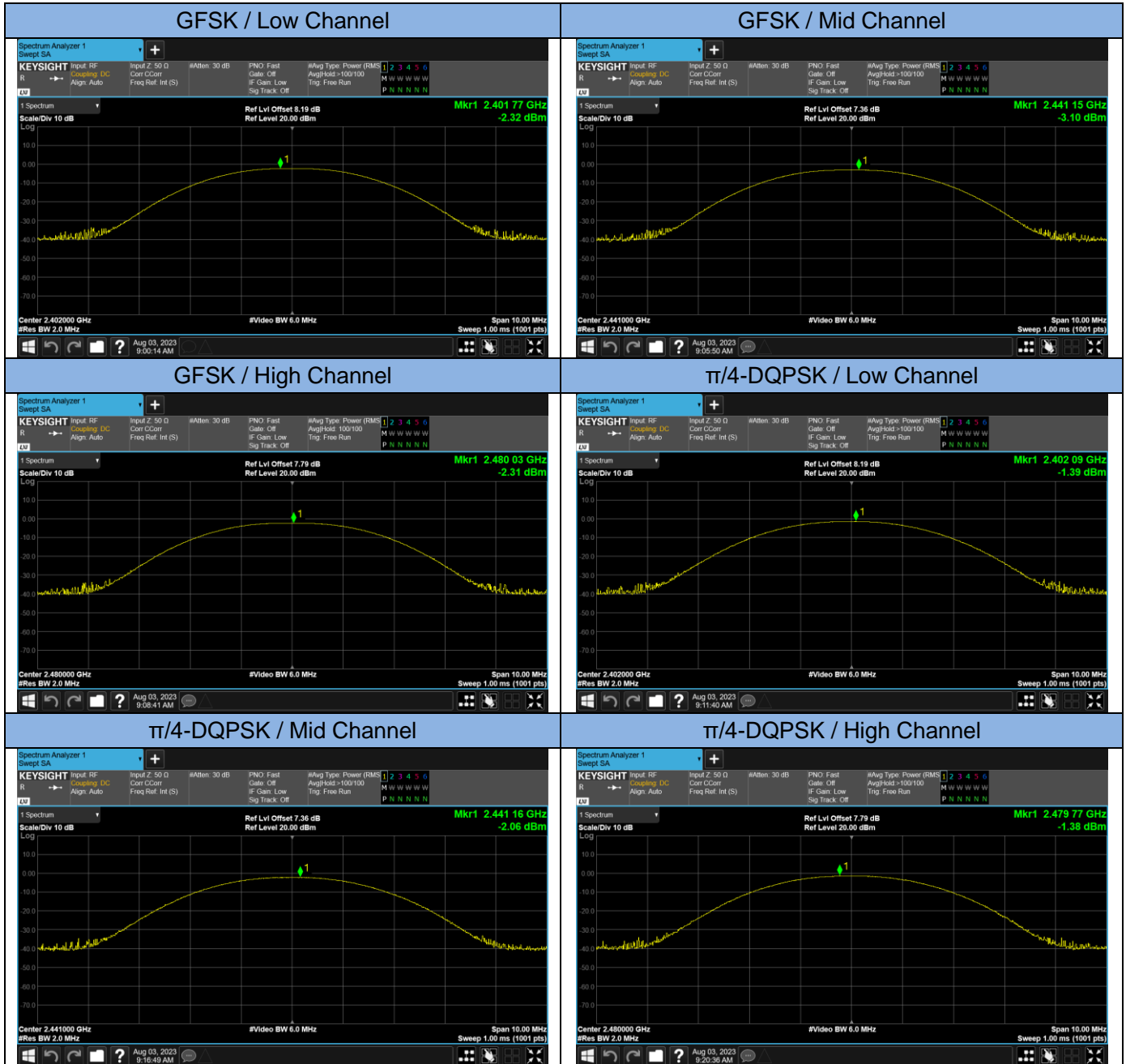

13.8 Band Edge Conducted Spurious Emission Measurement

LIMIT

In any 100KHz bandwidth outside the frequency band in which the spread spectrum intentional radiator is operating, the radio frequency power that is produced by the intentional radiator shall be at least 20dB below that in the 100KHz bandwidth within the band that contains the highest level of the desired power, based on either an RF conducted or a radiated measurement.

BLOCK DIAGRAM OF TEST SETUP

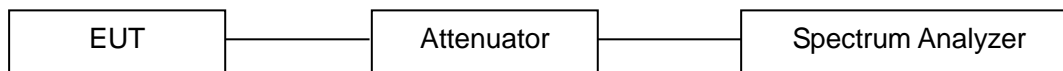

TEST PROCEDURES

- a. The RF output of EUT was connected to the spectrum analyzer by RF cable and attenuator. The path loss was compensated to the results for each measurement.
- b. Set to the maximum power setting and enable the EUT transmit continuously.
- c. Set spectrum analyzer and perform testing according to ANSI C63.10-2013 clause 7.8.6 and 6.10.
- d. Enable hopping function of the EUT and then repeat steps above.

TEST RESULTS

PASS

Please refer to the following test plots.

Band Edge



Band Edge

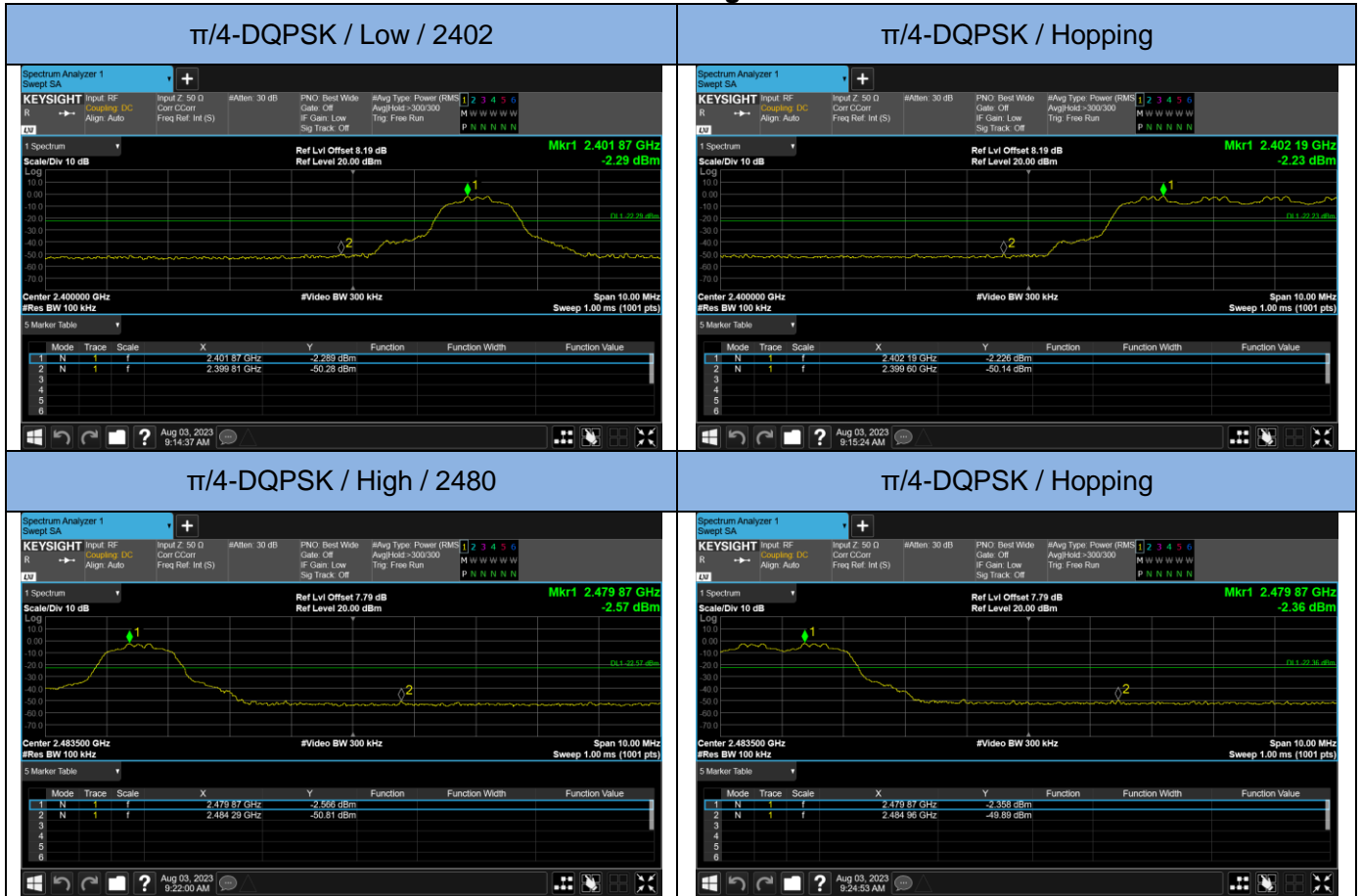

Conducted Spurious Emission (the worst case)

$\pi/4$ -DQPSK / Low Channel / 30MHz~25GHz

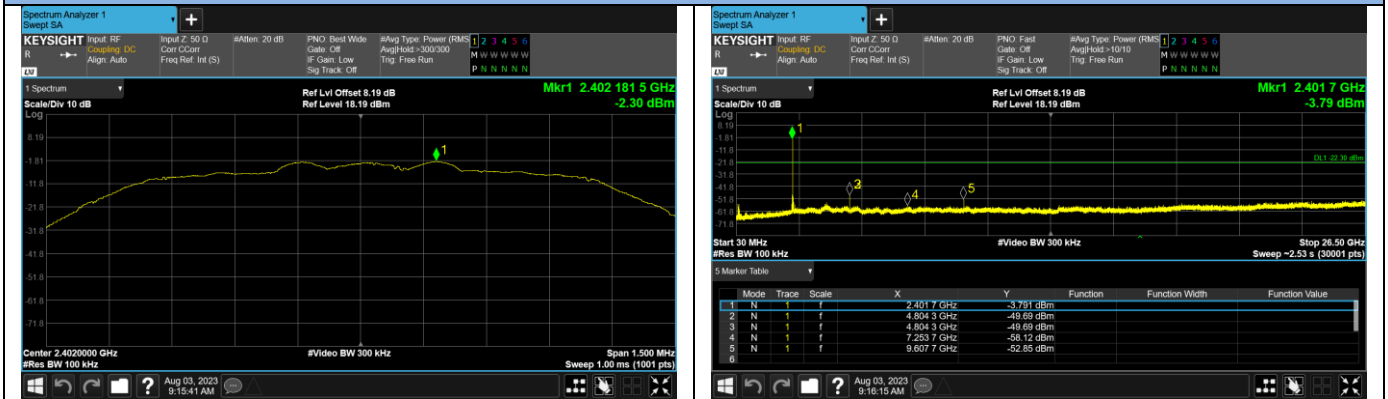

$\pi/4$ -DQPSK / Mid Channel / 30MHz~25GHz

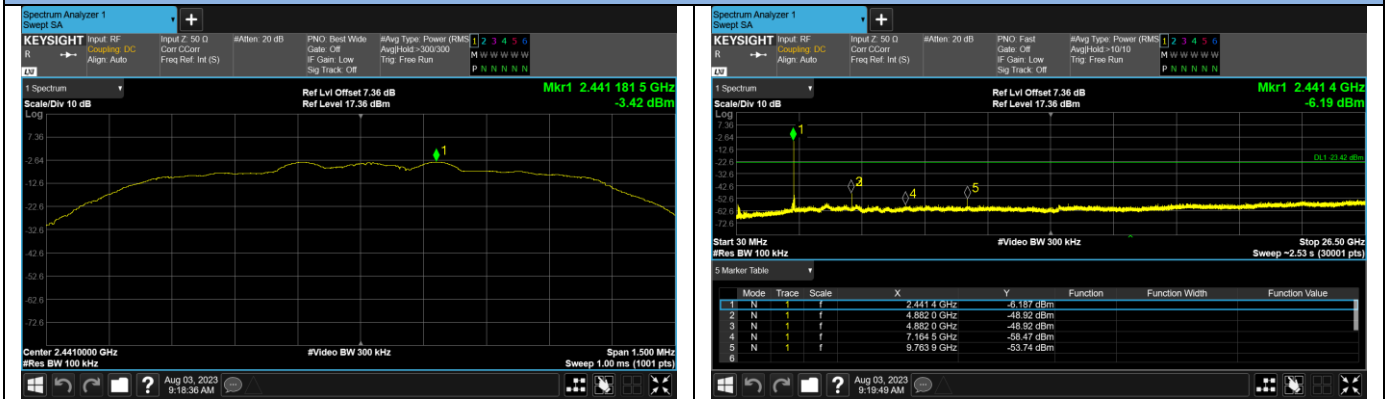

$\pi/4$ -DQPSK / High Channel / 30MHz~25GHz

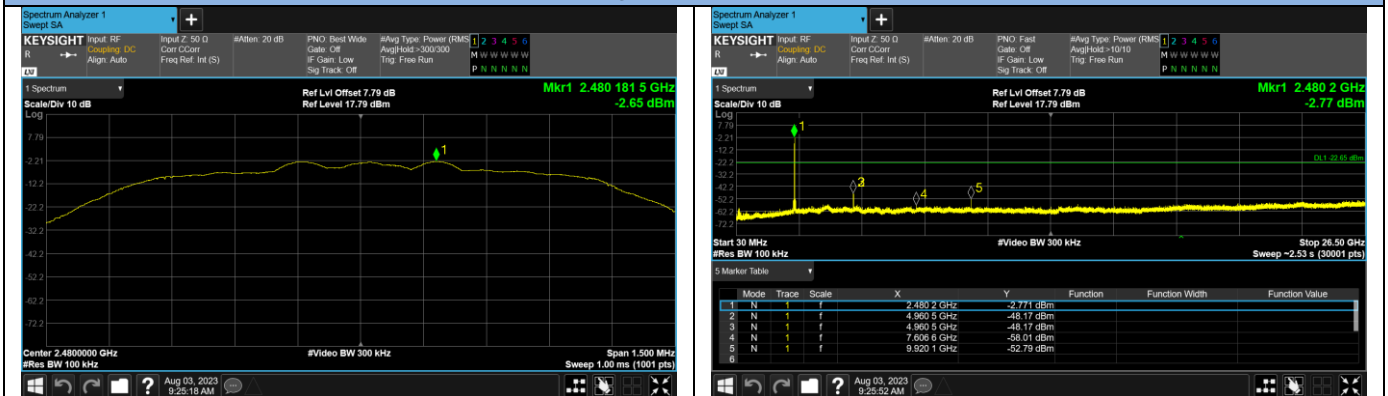

13.9 Antenna Requirement

STANDARD APPLICABLE

According to of FCC part 15C section 15.203 and 15.247:

An intentional radiator shall be designed to ensure that no antenna other than that furnished by the responsible party shall be used with the device. The use of a permanently attached antenna or of an antenna that uses a unique coupling to the intentional radiator, the manufacturer may design the unit so that a broken antenna can be replaced by the user, but the use of a standard antenna jack or electrical connector is prohibited.

ANTENNA CONNECTED CONSTRUCTION

The antenna is PCB antenna that no antenna other than furnished by the responsible party shall be used with the device, and the best case gain of the antenna is -0.58 dBi, Therefore, the antenna is considered to meet the requirement.

14. Test Equipment List

Item	Equipment	Manufacturer	Model No.	Serial No.	Last Cal.	Cal. Interval
1.	Test Receiver	Rohde & Schwarz	ESCI7	100837	Mar. 13, 2023	1 Year
2.	Antenna	Schwarzbeck	VULB9162	9162-010	Mar. 23, 2023	1 Year
3.	Spectrum Analyzer	Rohde & Schwarz	FSU26	200409/026	Mar. 13, 2023	1 Year
4.	Spectrum Analyzer	Keysight	N9020A	MY54200831	Mar. 13, 2023	1 Year
5.	Spectrum Analyzer	Rohde & Schwarz	FSV40	101094	Mar. 13, 2023	1 Year
6.	Horn Antenna	Schwarzbeck	BBHA9170	9170-172	Mar. 23, 2022	2 Year
7.	Power Sensor	DARE	RPR3006W	15I00041SNO 64	Mar. 13, 2023	1 Year
8.	Horn Antenna	COM-Power	AH-118	071078	Mar. 23, 2023	1 Year
9.	Pre-Amplifier	HP	HP 8449B	3008A00964	Mar. 13, 2023	1 Year
10.	Pre-Amplifier	HP	HP 8447D	1145A00203	Mar. 13, 2023	1 Year
11.	Loop Antenna	Schwarzbeck	FMZB 1513	1513-272	Mar. 23, 2023	1 Year
12.	Test Receiver	Rohde & Schwarz	ESCI	101152	Mar. 13, 2023	1 Year
13.	L.I.S.N	Rohde & Schwarz	ENV 216	101317	Mar. 13, 2023	1 Year
14.	RF Switching Unit	Compliance Direction Systems Inc.	RSU-M2	38311	Mar. 13, 2023	1 Year
15.	Temporary antenna connector	TESCOM	SS402	N/A	N/A	N/A
16.	Test Software	EZ	EZ_EMCC	N/A	N/A	N/A

Note: For photographs of EUT and measurement, please refer to appendix in separate documents.

---End---