

iOttie

HLCRIO201 , HLCRIO202 , HLCRIO203

Easy One Touch Connect

with Alexa Built-In

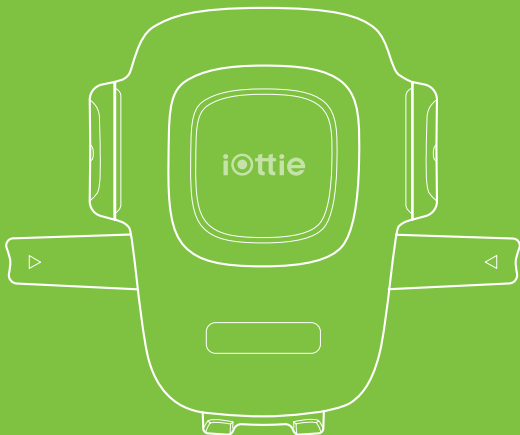

Dash & Windshield Mount
Manual

Explore New Roads with Alexa.

You can talk to Alexa on your Easy One Touch Connect. With Alexa, you can ask to get directions, play music, place calls, listen to audiobooks, hear the news, check the weather, control smart home devices, and more—all while you keep your hands on the wheel and eyes on the road.

The Easy One Touch Connect supports access to tens of thousands of Alexa skills right from your vehicle. For most up to date manual please visit: www.iottie.com

For an optimal experience, please follow the detailed instructions within this manual. For mounting instructions, please refer to the "Mounting Guide".

- ! The Easy One Touch Connect with Built-In Alexa uses your cellular data. A clear network connection is needed for Alexa to work, otherwise there may be delays or interruptions.
- ! Alexa streams from the cloud. Please note that this may use data. Data charges may apply.
- ! Some Alexa Skills may require an Amazon Prime membership.
- ! To use your car stereo, make sure your phone's Bluetooth is on and connected to your car's Bluetooth or connect AUX cable to car stereo.

Welcome to Alexa.

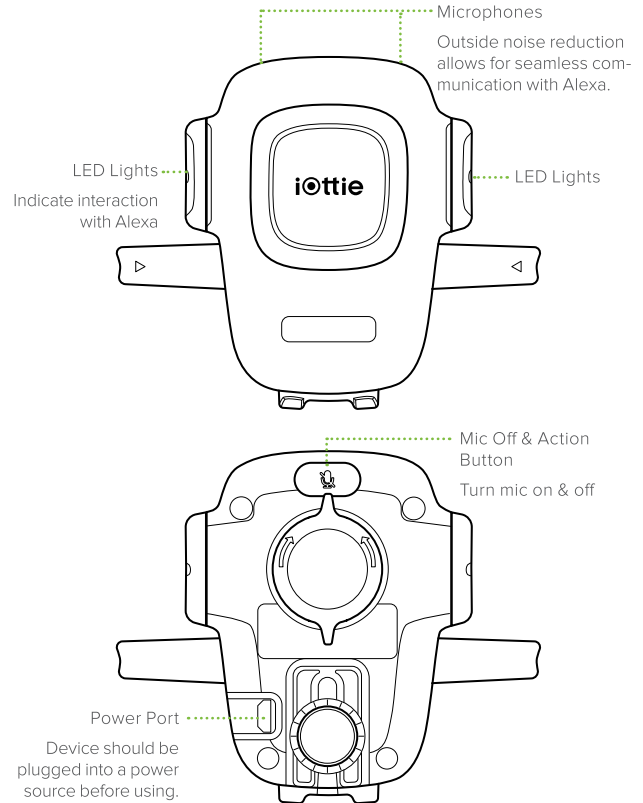

Getting Started with Alexa.



1. Download the iOttie Connect app to make sure your Easy One Touch Connect has the most up-to-date firmware installed. The iOttie Connect app is available from the Apple App Store® or the Google Play™ Store.
2. Follow the In App Instructions to get started.



3. Download the Alexa app on your smartphone. The Alexa app is available from the Apple App Store® or the Google Play™ Store.
4. Add Easy One Touch Connect device to the Alexa App with your Amazon Account.

Using Alexa on the Easy One Touch Connect.

Simply use the wake word, “Alexa,” to enjoy tens of thousands of skills. You can also press the “Mic Off & Action Button” instead of saying the wake word to turn Alexa on.

- 1. **Make sure to re-launch the Amazon Alexa app if Alexa stops responding to you. The Alexa app needs to be running in the background for your device to work.**

Tap to Mute.

Press and hold the “Mic Off & Action Button” for 3 seconds to turn the microphones off.

Just press the mute button again (don’t hold) to turn back on.

Alexa LED Indicators.

| | | |
|------------------------------|--|--|
| Solid White | | Powering On |
| Flashing Orange | | Searching Device |
| Solid Orange | | Device not connected |
| Flashing Cyan | | Will flash 3x and turn off. This means that it is connected. |
| Solid Cyan | | Will turn on for a few seconds after saying the Wake Word. |
| Alternating Dark Blue & Cyan | | Thinking |
| Solid Red | | Mute / Turned Off |
| No Light | | No interaction in progress |

Alexa Tips and Troubleshooting.

Navigation

Alexa will use your default maps app. To use a specific map (i.e. Waze or Google Maps) the default must be changed within the Alexa app.

1. Go to the menu and select “Settings”
2. Select “Traffic”
3. Select “Default Navigation App”

Music

When playing music, Alexa will default to Amazon Music. If using another service, the default must be changed within the Alexa app.

1. Go to the menu and select “Settings”
2. Select “Music”
3. Select “Choose default music services” **“Spotify is not compatible with this device.”**

Call and Text Messaging

For Voice messaging and Calling, please allow permission settings by going to: Contacts > Profile and Settings > Permission

Easy One Touch Connect

Mounting Guide

At a Glance

What's in the Box:

Mounting Head, Base, and Dual Car Charger with Micro USB Cable

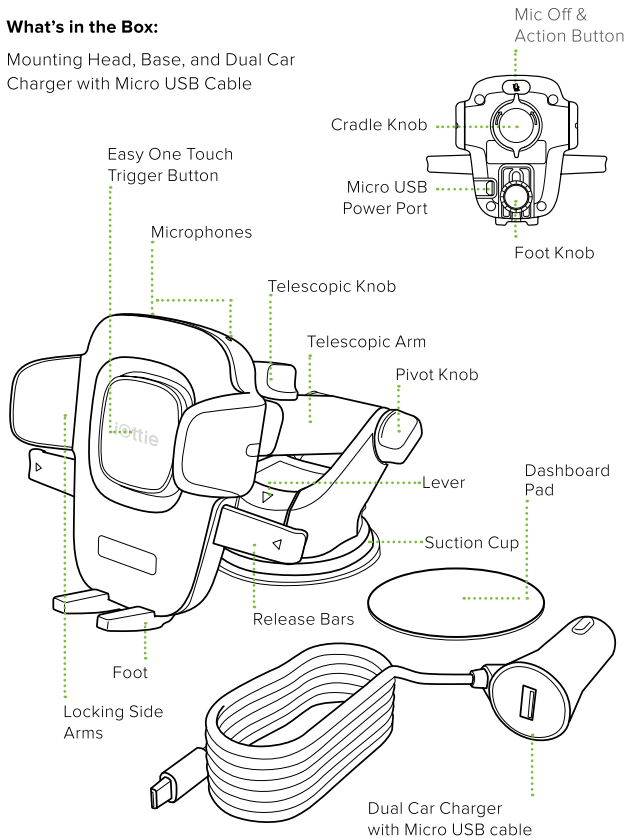

Alexa Mount Specifications

| ITEM | SPECIFICATIONS |
|---------------|----------------|
| INPUT | 5V - 1A |
| CHARGING PORT | Micro USB |
| DEPTH | 2.25" |
| WIDTH | 4.25" |
| HEIGHT | 3.6" |
| WEIGHT | 3.345 oz |

Car Charger Specifications

| INPUT | OUTPUT |
|---------|--------------------------------------|
| 12V~24V | USB A 5V - 2.1A MICRO USB 5V - 1A |

Safety Information

- ⚠ Always be safe, do not set up this device while driving.
- ⚠ Android: Setup smart unlock on your device. Please add a trusted device in settings. Certain features only work when smart unlock is enabled.
- ⚠ iPhone iOS & other Face ID Users: Do not use while driving!

Installation

1. Assembling the Mount

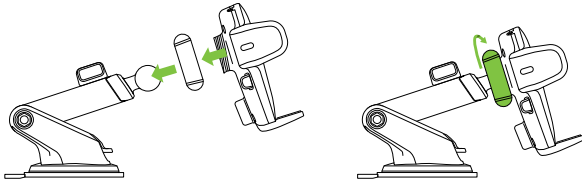

A. Connect the Mount Cradle with the Ball Joint.

B. Then, tighten the Cradle Knob.

2. Selecting a Location

- ! The Adhesive Tape on the underside of the Dashboard Pad is not reusable. Make sure to test the position of your mount before you remove the protective cover & stick mount to your dash. iOttie is not liable for any damages related to product misuse.
- ! Prior to mounting product we recommend surface & product be above 40°F.
- ! This device relies on microphones, please mount away from speakers, air vents and open windows.

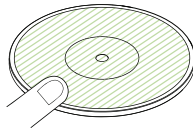
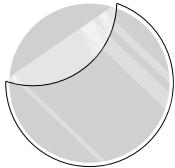

1. A: Wipe desired area on dash or windshield clean.
2. B: For dashboard application, peel the Protective Film off of the Dashboard pad

2. Place pad in desired area, sticky side down, and rub around the edges to ensure firm grip
Dashboard Pad not necessary for windshield installation. Wait 15-30 minutes for adhesive to set before moving onto next step.

Selecting a Location Cont.

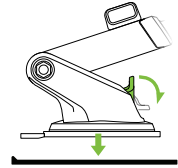

3. Remove plastic cover from Suction Cup.

4. A: Place Mount on Dashboard Pad or directly on desired area on your windshield.

5. B: Pull Down the lever to secure mount.

Connecting Power

- ! The Easy One Touch Connect is powered via a micro-USB cable. There is no off/on switch on the device. Once it is plugged in, the device will remain on unless the vehicle shuts off power when in parking mode.

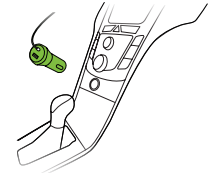
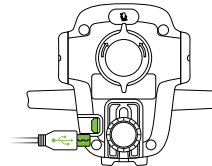

1. Plug the micro-USB cable into the USB port on the back of the Mounting Head.

2. Insert Car Charger into your vehicle's power port.

Additional Information

- ! To reuse Suction Cup, simply rinse under warm water and let air dry to restore tack suction.

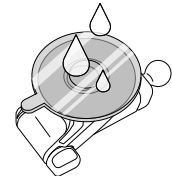

Using the Easy One Touch Mechanism

The Easy One Touch lock and release mechanism makes it simple to mount & retrieve smartphones in seconds.

Mounting

1. Press the locking side arms in.

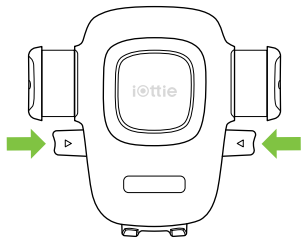

2. Press your device against the Easy One Touch trigger button. The mount's arms will automatically close.

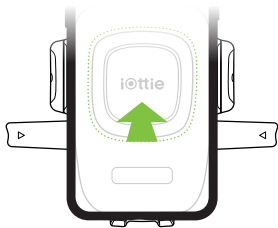

Releasing

Press the locking side arms with one hand and retrieve the device.

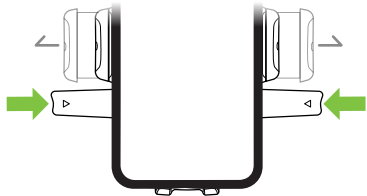

Adjusting the Mount

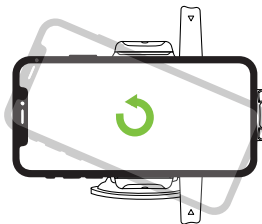

1. Cradle Knob

For landscape mode, loosen to rotate the Cradle. Tighten to lock.

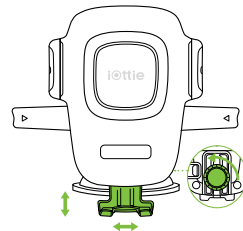

2. Foot Knob

Located on the lower back of Cradle. Loosen to re-position mount's foot up & down.

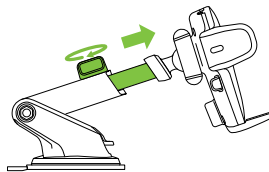

3. Telescopic Knob

Located on top of Telescopic Arm, loosen to extend the arm, and tighten to secure distance.

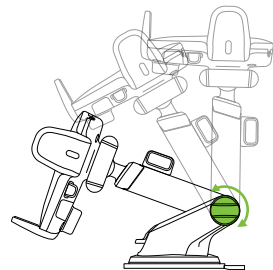

4. Pivot Knob

Located on the side of the Mount Base, turning allows you to pivot telescopic arm. Tighten to secure position.



The iOttie Easy One Touch Connect is backed by a 1 year warranty.



Details and app updates on Amazon page:

<https://www.amazon.com/gp/help/customer/contact-us>



If you love your iOttie product, let us know by leaving a review online, or connect with us on our social platforms.

iOttie



 www.iottie.com  cs@iottie.com



EN If you love your iOttie product, let us know by leaving a review online, or connect with us on our social platforms.

FR Si vous aimez votre produit iOttie, merci de nous le faire savoir en laissant un commentaire en ligne ou nous rejoindre sur nos réseaux sociaux.

ES Si le gusta su producto iOttie, háganos saber dejando una reseña en línea, o conéctese con nosotros en nuestras plataformas sociales.

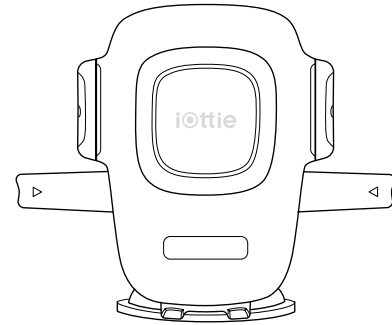

Easy One Touch Connect

Alexa Built-in Dashboard & Windshield Mount

FRENCH Alexa Built-in Dashboard & Windshield Mount

SPANISH Alexa Built-in Dashboard & Windshield Mount



www.iottie.com cs@iottie.com

1 installation/installation/installation

2 software/software/software

3 skills/skills/skills

Getting Started

For optimal mounting, please follow the detailed instructions within this manual when using the Easy One Touch Connect. For software installation, please see the "Software Manual." iOttie is not liable for possible damages due to product misuse.

Critical Information

- The Easy One Touch Connect is mounted with a semi-permanent adhesive tape. Each base is one-time use only. Once removed, it cannot be re-mounted.
- When mounting, it is recommended that the surface & product be above 40° F.
- Manuals should be followed in order: 1. Installation 2. Software 3. Skills.

Specifications

| ITEM | SPECIFICATIONS |
|---------------|----------------|
| INPUT | 5V - 1A |
| CHARGING PORT | Micro USB |
| DEPTH | 2.25" |
| WIDTH | 4.25" |
| HEIGHT | 3.6" |
| WEIGHT | 3.345 oz |

Car Charger Specifications

| INPUT | OUTPUT |
|---------|--------------------------------------|
| 12V~24V | USB A 5V - 2.1A MICRO USB 5V - 1A |

At a Glance

What's in the Box:

Mounting Head, Base, and Dual Car Charger with Micro USB Cable

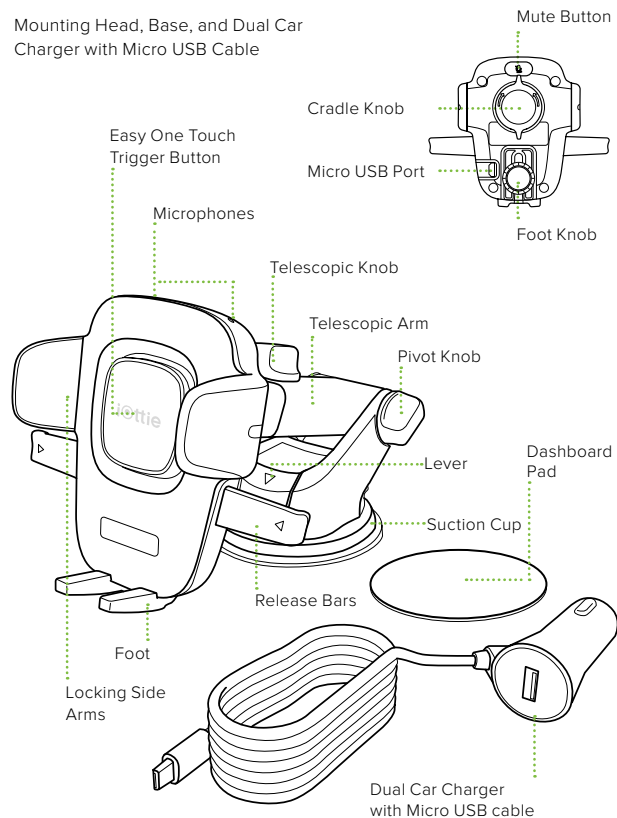

Installation

1. Assembling the Mount

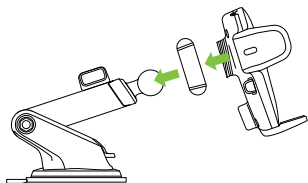

A. Connect the Mount Cradle with the Ball Joint.

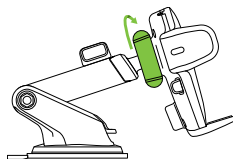

B. Then, tighten the Cradle Knob.

2. Selecting a Location

Choose an installation method: Dashboard/Flat Surface (A) or Windshield/Curved Glass (B)

Option A

Dashboard or Flat Surface Installation

Choose an area on a flat surface on the vehicle's dashboard and wipe any dust or debris from the surface.

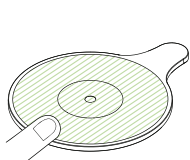

1. Peel off the film on the dashboard pad & stick on the desired installation location.



2. Peel off the protective film on the Suction Cup and press mount firmly onto the dashboard pad.

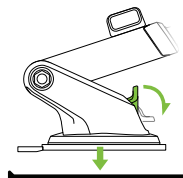

3. Push Locking Lever down to engage suction.

Option B

Windshield Installation or Curved Glass Installation

Choose a location on the windshield and wipe any dust or debris from the surface.



1. Peel off the protective film on the Suction Cup and press firmly onto the windshield.

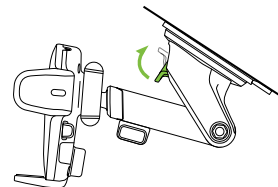

2. Push Locking Lever down to engage suction.

Connecting Power

! The Easy One Touch Connect is powered via a micro-USB cable. There is no off/on switch on the device. Once it is plugged in, the device will remain on unless the vehicle shuts off power when in parking mode.

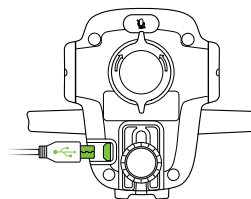

1. Plug the micro-USB cable into the USB port on the back of the Mounting Head.

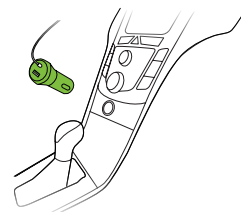

2. Insert Car Charger into your vehicle's power port.

Using the Easy One Touch Mechanism

The Easy One Touch lock and release mechanism makes it simple to mount & retrieve smartphones in seconds.

Mounting

Step 1: Press the locking side arms in.

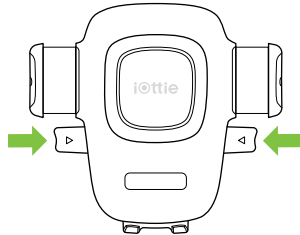

Step 2: Press your device against the Easy One Touch trigger button. The mount's arms will automatically close on contact and hold the device during the driving journey.

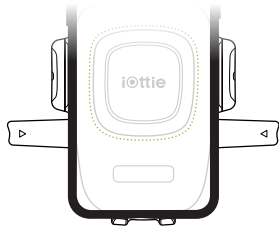

Releasing

Press the locking side arms with one hand and retrieve the device.

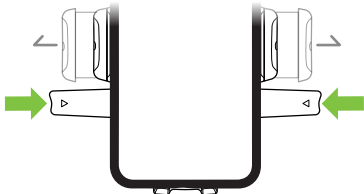

Adjusting the Mount

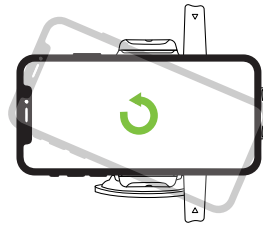

1. Cradle Knob

When mounting in landscape mode, loosen to rotate the Cradle. Tighten to lock in desired position.

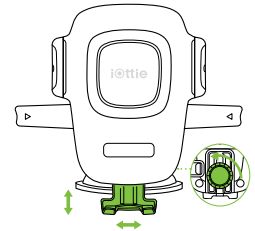

2. Foot Knob

Located on the lower back of Cradle. Loosen to re-position mount's foot. The Foot can be adjusted up & down or side-to-side.

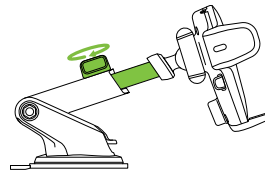

3. Telescopic Knob

Located on top of Telescopic Arm, loosen to extend the arm, and tighten to secure distance.

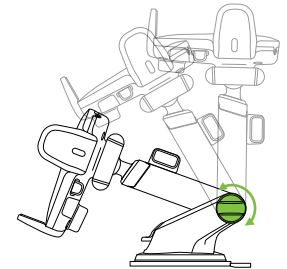

4. Pivot Knob

Located on the side of the Mount Base, turning allows you to pivot telescopic arm. Tighten to secure position.

Operating temperature: -10-55°C

Operating frequency range: 2402-2480MHz

Rated Power: For Classic: 9.1dBm, BLE: 8.1dBm

Declaration of Conformity

Hereby, iOttie, Inc. declares that the radio equipment type Easy onetouch connect of HLCRIO201 is in compliance with Directive 2014/53/EU.

The full text of the EU declaration of conformity is available at the following internet address:

www.iottie.com

This device may be used in each EU member state.

This device complies with part 15 of the FCC rules. Operation is subject to the following two conditions: (1) this device may not cause harmful interference, and (2) this device must accept any interference received, including interference that may cause undesired operation.

NOTE: The manufacturer is not responsible for any radio or TV interference caused by unauthorized modifications to this equipment. Such modifications could void the user's authority to operate the equipment.

NOTE: This equipment has been tested and found to comply with the limits for a Class B digital device, pursuant to part 15 of the FCC Rules. These limits are designed to provide reasonable protection against harmful interference in a residential installation. This equipment generates uses and can radiate radio frequency energy and, if not installed and used in accordance with the instructions, may cause harmful interference to radio communications. However, there is no guarantee that interference will not occur in a particular installation. If this equipment does cause harmful interference to radio or television reception, which can be determined by turning the equipment off and on, the user is encouraged to try to correct the interference by one or more of the following measures:

- Reorient or relocate the receiving antenna.
- Increase the separation between the equipment and receiver.
- Connect the equipment into an outlet on a circuit different from that to which the receiver is connected.
- Consult the dealer or an experienced radio/TV technician for help
- This device and its antenna(s) must not be co-located or operating in conjunction with any other antenna or transmitter.

This equipment complies with FCC radiation exposure limits set forth for an uncontrolled environment. This equipment should be installed and operated with minimum distance of 20 cm between the radiator and your body. This transmitter must not be co-located or operating in conjunction with any other antenna or transmitter