

## FCC Test Report

**Report No.:** RF181109E05-1

**FCC ID:** 2AMRICR48NA

**Test Model:** CR48NA

**Series Model:** CXD2800

**Received Date:** Nov. 13, 2018

**Test Date:** Nov. 30 to Dec. 12, 2018

**Issued Date:** Feb. 20, 2019

**Applicant:** Connected IO

**Address:** 8304 Esters Boulevard, Suite 850, Irving, Texas United States 75063

**Issued By:** Bureau Veritas Consumer Products Services (H.K.) Ltd., Taoyuan Branch  
Hsin Chu Laboratory

**Lab Address:** E-2, No.1, Li Hsin 1st Road, Hsinchu Science Park, Hsinchu City 300,  
Taiwan R.O.C.

**Test Location:** E-2, No.1, Li Hsin 1st Road, Hsinchu Science Park, Hsinchu City 300,  
Taiwan R.O.C.

**FCC Registration /  
Designation Number:** 723255 / TW2022



This report is for your exclusive use. Any copying or replication of this report to or for any other person or entity, or use of our name or trademark, is permitted only with our prior written permission. This report sets forth our findings solely with respect to the test samples identified herein. The results set forth in this report are not indicative or representative of the quality or characteristics of the lot from which a test sample was taken or any similar or identical product unless specifically and expressly noted. Our report includes all of the tests requested by you and the results thereof based upon the information that you provided to us. You have 60 days from date of issuance of this report to notify us of any material error or omission caused by our negligence, provided, however, that such notice shall be in writing and shall specifically address the issue you wish to raise. A failure to raise such issue within the prescribed time shall constitute your unqualified acceptance of the completeness of this report, the tests conducted and the correctness of the report contents. Unless specific mention, the uncertainty of measurement has been explicitly taken into account to declare the compliance or non-compliance to the specification. The report must not be used by the client to claim product certification, approval, or endorsement by TAF or any government agencies.

## Table of Contents

<b>Release Control Record</b> .....	<b>4</b>
<b>1 Certificate of Conformity</b> .....	<b>5</b>
<b>2 Summary of Test Results</b> .....	<b>6</b>
2.1 Measurement Uncertainty .....	6
2.2 Modification Record .....	6
<b>3 General Information</b> .....	<b>7</b>
3.1 General Description of EUT .....	7
3.2 Description of Test Modes .....	10
3.2.1 Test Mode Applicability and Tested Channel Detail .....	11
3.3 Duty Cycle of Test Signal .....	13
3.4 Description of Support Units .....	14
3.4.1 Configuration of System under Test .....	15
3.5 General Description of Applied Standard .....	16
<b>4 Test Types and Results</b> .....	<b>17</b>
4.1 Radiated Emission and Bandedge Measurement .....	17
4.1.1 Limits of Radiated Emission and Bandedge Measurement .....	17
4.1.2 Test Instruments .....	18
4.1.3 Test Procedure .....	20
4.1.4 Deviation from Test Standard .....	21
4.1.5 Test Setup .....	21
4.1.6 EUT Operating Condition .....	22
4.1.7 Test Results .....	23
4.2 Conducted Emission Measurement .....	43
4.2.1 Limits of Conducted Emission Measurement .....	43
4.2.2 Test Instruments .....	43
4.2.3 Test Procedure .....	44
4.2.4 Deviation from Test Standard .....	44
4.2.5 Test Setup .....	44
4.2.6 EUT Operating Condition .....	44
4.2.7 Test Results .....	45
4.3 Transmit Power Measurement .....	47
4.3.1 Limits of Transmit Power Measurement .....	47
4.3.2 Test Setup .....	47
4.3.3 Test Instruments .....	47
4.3.4 Test Procedure .....	47
4.3.5 Deviation from Test Standard .....	47
4.3.6 EUT Operating Condition .....	47
4.3.7 Test Result .....	48
4.4 Occupied Bandwidth Measurement .....	50
4.4.1 Test Setup .....	50
4.4.2 Test Instruments .....	50
4.4.3 Test Procedure .....	50
4.4.4 Test Results .....	51
4.5 Peak Power Spectral Density Measurement .....	55
4.5.1 Limits of Peak Power Spectral Density Measurement .....	55
4.5.2 Test Setup .....	55
4.5.3 Test Instruments .....	55
4.5.4 Test Procedure .....	56
4.5.5 Deviation from Test Standard .....	56
4.5.6 EUT Operating Condition .....	56
4.5.7 Test Results .....	57
4.6 Frequency Stability Measurement .....	63
4.6.1 Limits of Frequency Stability Measurement .....	63

4.6.2	Test Setup.....	63
4.6.3	Test Instruments .....	63
4.6.4	Test Procedure .....	63
4.6.5	Deviation from Test Standard .....	63
4.6.6	EUT Operating Condition .....	63
4.6.7	Test Results .....	64
4.7	6dB Bandwidth Measurement .....	65
4.7.1	Limits of 6dB Bandwidth Measurement.....	65
4.7.2	Test Setup.....	65
4.7.3	Test Instruments .....	65
4.7.4	Test Procedure .....	65
4.7.5	Deviation from Test Standard .....	65
4.7.6	EUT Operating Condition .....	65
4.7.7	Test Results .....	66
<b>5</b>	<b>Pictures of Test Arrangements.....</b>	<b>68</b>
	<b>Annex A- Radiated Out of Band Emission (OOBE) Measurement (For U-NII-3 band) .....</b>	<b>69</b>
	<b>Appendix – Information on the Testing Laboratories .....</b>	<b>72</b>

### Release Control Record

Issue No.	Description	Date Issued
RF181109E05-1	Original release.	Feb. 20, 2019

## 1 Certificate of Conformity

**Product:** Router

**Brand:** Connected IO, Netsurion

**Test Model:** CR48NA

**Series Model:** CXD2800

**Sample Status:** ENGINEERING SAMPLE

**Applicant:** Connected IO

**Test Date:** Nov. 30 to Dec. 12, 2018

**Standard:** 47 CFR FCC Part 15, Subpart E (Section 15.407)  
ANSI C63.10: 2013

The above equipment has been tested by **Bureau Veritas Consumer Products Services (H.K.) Ltd., Taoyuan Branch**, and found compliance with the requirement of the above standards. The test record, data evaluation & Equipment Under Test (EUT) configurations represented herein are true and accurate accounts of the measurements of the sample's EMC characteristics under the conditions specified in this report.

**Prepared by :** Wendy Wu , **Date:** Feb. 20, 2019  
Wendy Wu / Specialist

**Approved by :** May Chen , **Date:** Feb. 20, 2019  
May Chen / Manager

## 2 Summary of Test Results

47 CFR FCC Part 15, Subpart E (Section 15.407)			
FCC Clause	Test Item	Result	Remarks
15.407(b)(6)	AC Power Conducted Emissions	Pass	Meet the requirement of limit. Minimum passing margin is -9.94dB at 0.36875MHz.
15.407(b) (1/2/3/4(i/ii)/6)	Radiated Emissions & Band Edge Measurement*	Pass	Meet the requirement of limit. Minimum passing margin is -0.1dB at 5639.79MHz.
15.407(a)(1/2/3)	Max Average Transmit Power	Pass	Meet the requirement of limit.
---	Occupied Bandwidth Measurement	-	Reference only.
15.407(a)(1/2/3)	Peak Power Spectral Density	Pass	Meet the requirement of limit.
15.407(e)	6dB bandwidth	Pass	Meet the requirement of limit. (U-NII-3 Band only)
15.407(g)	Frequency Stability	Pass	Meet the requirement of limit.
15.203	Antenna Requirement	Pass	Antenna connector is R-SMA not a standard connector.

\*For U-NII-3 band compliance with rule part 15.407(b)(4)(i), the OOB test plots were recorded in Annex A.

### 2.1 Measurement Uncertainty

Where relevant, the following measurement uncertainty levels have been estimated for tests performed on the EUT as specified in CISPR 16-4-2:

Measurement	Frequency	Expanded Uncertainty (k=2) (±)
Conducted Emissions at mains ports	150kHz ~ 30MHz	1.84 dB
Radiated Emissions up to 1 GHz	30MHz ~ 1GHz	5.33 dB
Radiated Emissions above 1 GHz	1GHz ~ 6GHz	5.10 dB
	6GHz ~ 18GHz	4.85 dB
	18GHz ~ 40GHz	5.24 dB

### 2.2 Modification Record

There were no modifications required for compliance.

### 3 General Information

#### 3.1 General Description of EUT

Product	Router
Brand	Connected IO, Netsurion
Test Model	CR48NA
Series Model	CXD2800
Status of EUT	ENGINEERING SAMPLE
Power Supply Rating	DC 12V from power adapter
Modulation Type	CCK, DQPSK, DBPSK for DSSS 64QAM, 16QAM, QPSK, BPSK for OFDM 256QAM for OFDM in 11ac mode and VHT20/40 in 2.4GHz band
Modulation Technology	DSSS, OFDM
Transfer Rate	802.11b: up to 11Mbps 802.11a/g: up to 54Mbps 802.11n: up to 300Mbps 802.11ac: up to 866.7Mbps
Operating Frequency	<b>2.4GHz:</b> 2.412 ~ 2.462GHz <b>5GHz:</b> 5.18 ~ 5.24GHz, 5.745 ~ 5.825GHz
Number of Channel	<b>2.4GHz:</b> 802.11b, 802.11g, 802.11n (HT20), VHT20: 11 802.11n (HT40), VHT40: 7 <b>5GHz:</b> 802.11a, 802.11n (HT20), 802.11ac (VHT20): 9 802.11n (HT40), 802.11ac (VHT40): 4 802.11ac (VHT80): 2
Output Power	<b>2.4GHz:</b> <b>CDD Mode:</b> 683.343mW <b>Beamforming Mode:</b> 595.78mW <b>5GHz:</b> <b>CDD Mode:</b> <b>5.18 ~ 5.24GHz:</b> 59.941mW <b>5.745 ~ 5.825GHz:</b> 139.597mW <b>Beamforming Mode:</b> <b>5.18 ~ 5.24GHz:</b> 30.784mW <b>5.745 ~ 5.825GHz:</b> 138.587mW
Antenna Type	Refer to Note
Antenna Connector	Refer to Note
Accessory Device	Adapter x1
Data Cable Supplied	RJ 45 cable x 1 (Unshielded, 1.5m)

Note:

1. There are WLAN, WWAN and LTE technology used for the EUT.
2. The EUT contains certified 3G/LTE modular which FCC ID: RI7LE910NAV2.
3. The EUT has below model names, which are identical to each other in all aspects except for the following:

Brand	Model No.	Difference
Connected IO	CR48NA	Different Housing colors
Netsurion	CXD2800	

From the above models, model: **CR48NA** was selected as representative model for the test and its data was recorded in this report.

4. Simultaneously transmission condition.

Condition	Technology		
1	WLAN 2.4GHz	WLAN 5GHz	WWAN (3G/LTE)

**Note:** The emission of the simultaneous operation has been evaluated and no non-compliance was found.

5. The EUT must be supplied with a power adapter and following two different model names could be chosen:

No.	Brand	Model No.	Spec.
1	UMEC	UP0251M-12PA	Input: 100-240Vac, 0.6A, 50/60Hz Output: 12Vdc, 2A DC output cable (Unshielded, 1.5m)
2	AMIGO	AMS115-1202000FU	Input: 100-240Vac, 0.8A, 50/60Hz Output: 12Vdc, 2.0A DC output cable (Unshielded, 1.5m)

Note: From the above models, the worst radiated emission and AC power conducted emission test was found in **Adapter 1**. Therefore only the test data of the modes were recorded in this report.

6. The antennas provided to the EUT, please refer to the following table:

WLAN							
Ant Set.	Chain No.	Brand	Model	Antenna Gain (dBi)	Frequency Range (GHz)	Antenna Type	Connector Type
1	Chain 0	JOYMAX	TWX-1513RSXX-711	5	2.4~2.4835	Collinear	R-SMA
				5	5.15~5.85		
	Chain 1	JOYMAX	TWX-1513RSXX-711	5	2.4~2.4835	Collinear	R-SMA
				5	5.15~5.85		
2	Chain 0	JOYMAX	TWX-6141RSXX-711	3	2.4~2.4835	Microstrip	R-SMA
				5	5.15~5.85		
	Chain 1	JOYMAX	TWX-6141RSXX-711	3	2.4~2.4835	Microstrip	R-SMA
				5	5.15~5.85		
WWAN – 3G / LTE							
Ant Set	Transmitter Circuit	Brand	Model	Antenna Gain (dBi)	Frequency Range (MHz)	Antenna Type	Connector Type
1	Main	JOYMAX	YWX-6252SAXX-711	3	698~960	Microstrip	SMA
					1710~2710		
					2300~2700		
	Aux	JOYMAX	YWX-6252SAXX-711	3	698~960	Microstrip	SMA
					1710~2710		
					2300~2700		

Note:

1. For WLAN: Ant set 1 was selected for the final test.



7. The EUT incorporates a MIMO function:

<b>2.4GHz Band</b>		
<b>MODULATION MODE</b>	<b>TX &amp; RX CONFIGURATION</b>	
<b>802.11b</b>	2TX	2RX
<b>802.11g</b>	2TX	2RX
<b>802.11n (HT20)</b>	2TX	2RX
<b>802.11n (HT40)</b>	2TX	2RX
<b>VHT20</b>	2TX	2RX
<b>VHT40</b>	2TX	2RX
<b>5GHz Band</b>		
<b>MODULATION MODE</b>	<b>TX &amp; RX CONFIGURATION</b>	
<b>802.11a</b>	2TX	2RX
<b>802.11n (HT20)</b>	2TX	2RX
<b>802.11n (HT40)</b>	2TX	2RX
<b>802.11ac (VHT20)</b>	2TX	2RX
<b>802.11ac (VHT40)</b>	2TX	2RX
<b>802.11ac (VHT80)</b>	2TX	2RX

Note:

1. All of modulation mode support beamforming function except 802.11a/b/g modulation mode.
2. The EUT support Beamforming and CDD mode, therefore both mode were investigated and the worst case scenario was identified. The worst case data were presented in test report.
3. The modulation and bandwidth are similar for 802.11n mode for 20MHz (40MHz) and 802.11ac mode for 20MHz (40MHz), therefore investigated worst case to representative mode in test report. (Final test mode refer section 3.2.1)

8. The above EUT information is declared by manufacturer and for more detailed features description, please refer to the manufacturer's specifications or user's manual.

### 3.2 Description of Test Modes

#### FOR 5180 ~ 5240MHz

4 channels are provided for 802.11a, 802.11n (HT20), 802.11ac (VHT20):

Channel	Frequency	Channel	Frequency
36	5180MHz	44	5220MHz
40	5200MHz	48	5240MHz

2 channels are provided for 802.11n (HT40), 802.11ac (VHT40):

Channel	Frequency	Channel	Frequency
38	5190MHz	46	5230MHz

1 channel is provided for 802.11ac (VHT80):

Channel	Frequency
42	5210MHz

#### FOR 5745 ~ 5825MHz:

5 channels are provided for 802.11a, 802.11n (HT20), 802.11ac (VHT20):

Channel	Frequency	Channel	Frequency
149	5745MHz	161	5805MHz
153	5765MHz	165	5825MHz
157	5785MHz		

2 channels are provided for 802.11n (HT40), 802.11ac (VHT40):

Channel	Frequency	Channel	Frequency
151	5755MHz	159	5795MHz

1 channel is provided for 802.11ac (VHT80):

Channel	Frequency
155	5775MHz

### 3.2.1 Test Mode Applicability and Tested Channel Detail

EUT Configure Mode	Applicable To				Description
	RE $\geq$ 1G	RE $<$ 1G	PLC	APCM	
-	√	√	√	√	-

Where **RE $\geq$ 1G**: Radiated Emission above 1GHz      **RE $<$ 1G**: Radiated Emission below 1GHz  
**PLC**: Power Line Conducted Emission      **APCM**: Antenna Port Conducted Measurement

**NOTE:**

- The EUT had been pre-tested on the positioned of each 2 axis. The worst case was found when positioned on **X-plane**.

#### **Radiated Emission Test (Above 1GHz):**

- Pre-Scan has been conducted to determine the worst-case mode from all possible combinations between available modulations, data rates and antenna ports (if EUT with antenna diversity architecture).
- Following channel(s) was (were) selected for the final test as listed below.

CDD Mode						
Mode	FREQ. Band (MHz)	Available Channel	Tested Channel	Modulation Technology	Modulation Type	Data Rate (Mbps)
802.11a	5180-5240	36 to 48	36, 40, 48	OFDM	BPSK	6
802.11ac (VHT20)		36 to 48	36, 40, 48	OFDM	BPSK	6.5
802.11ac (VHT40)		38 to 46	38, 46	OFDM	BPSK	13.5
802.11ac (VHT80)		42	42	OFDM	BPSK	29.3
802.11a	5745-5825	149 to 165	149, 157, 165	OFDM	BPSK	6
802.11ac (VHT20)		149 to 165	149, 157, 165	OFDM	BPSK	6.5
802.11ac (VHT40)		151 to 159	151, 159	OFDM	BPSK	13.5
802.11ac (VHT80)		155	155	OFDM	BPSK	29.3

#### **Radiated Emission Test (Below 1GHz):**

- Pre-Scan has been conducted to determine the worst-case mode from all possible combinations between available modulations, data rates and antenna ports (if EUT with antenna diversity architecture).
- Following channel(s) was (were) selected for the final test as listed below.

CDD Mode						
Mode	FREQ. Band (MHz)	Available Channel	Tested Channel	Modulation Technology	Modulation Type	Data Rate (Mbps)
802.11a	5180-5240 5745-5825	36 to 48 149 to 165	149	OFDM	BPSK	6

### Power Line Conducted Emission Test:

- Pre-Scan has been conducted to determine the worst-case mode from all possible combinations between available modulations, data rates and antenna ports (if EUT with antenna diversity architecture).
- Following channel(s) was (were) selected for the final test as listed below.

CDD Mode						
Mode	FREQ. Band (MHz)	Available Channel	Tested Channel	Modulation Technology	Modulation Type	Data Rate (Mbps)
802.11a	5180-5240 5745-5825	36 to 48 149 to 165	149	OFDM	BPSK	6

### Antenna Port Conducted Measurement:

- This item includes all test value of each mode, but only includes spectrum plot of worst value of each mode.
- Pre-Scan has been conducted to determine the worst-case mode from all possible combinations between available modulations, data rates and antenna ports (if EUT with antenna diversity architecture).
- Following channel(s) was (were) selected for the final test as listed below.

CDD Mode						
Mode	FREQ. Band (MHz)	Available Channel	Tested Channel	Modulation Technology	Modulation Type	Data Rate (Mbps)
802.11a	5180-5240	36 to 48	36, 40, 48	OFDM	BPSK	6
802.11ac (VHT20)		36 to 48	36, 40, 48	OFDM	BPSK	6.5
802.11ac (VHT40)		38 to 46	38, 46	OFDM	BPSK	13.5
802.11ac (VHT80)		42	42	OFDM	BPSK	29.3
802.11a	5745-5825	149 to 165	149, 157, 165	OFDM	BPSK	6
802.11ac (VHT20)		149 to 165	149, 157, 165	OFDM	BPSK	6.5
802.11ac (VHT40)		151 to 159	151, 159	OFDM	BPSK	13.5
802.11ac (VHT80)		155	155	OFDM	BPSK	29.3
Beamforming Mode (Output power only)						
Mode	FREQ. Band (MHz)	Available Channel	Tested Channel	Modulation Technology	Modulation Type	Data Rate (Mbps)
802.11ac (VHT20)	5180-5240	36 to 48	36, 40, 48	OFDM	BPSK	6.5
802.11ac (VHT40)		38 to 46	38, 46	OFDM	BPSK	13.5
802.11ac (VHT80)		42	42	OFDM	BPSK	29.3
802.11ac (VHT20)	5745-5825	149 to 165	149, 157, 165	OFDM	BPSK	6.5
802.11ac (VHT40)		151 to 159	151, 159	OFDM	BPSK	13.5
802.11ac (VHT80)		155	155	OFDM	BPSK	29.3

### Test Condition:

APPLICABLE TO	ENVIRONMENTAL CONDITIONS	INPUT POWER	TESTED BY
RE $\geq$ 1G	22deg. C, 64%RH	120Vac, 60Hz	Steven Chiang
RE $<$ 1G	21deg. C, 67%RH	120Vac, 60Hz	Steven Chiang
PLC	25deg. C, 75%RH	120Vac, 60Hz	Andy Ho
APCM	25deg. C, 60%RH	120Vac, 60Hz	Anderson Chen

### 3.3 Duty Cycle of Test Signal

If duty cycle of test signal is  $\geq 98\%$ , duty factor is not required.

If duty cycle of test signal is  $< 98\%$ , duty factor shall be considered.

**802.11a:** Duty cycle =  $2.027/2.109 = 0.961$ , Duty factor =  $10 * \log(1/0.961) = 0.17$

**802.11ac (VHT20):** Duty cycle =  $4.965/5.055 = 0.982$

**802.11ac (VHT40):** Duty cycle =  $2.414/2.504 = 0.964$ , Duty factor =  $10 * \log(1/0.964) = 0.16$

**802.11ac (VHT80):** Duty cycle =  $1.135/1.212 = 0.936$ , Duty factor =  $10 * \log(1/0.936) = 0.29$

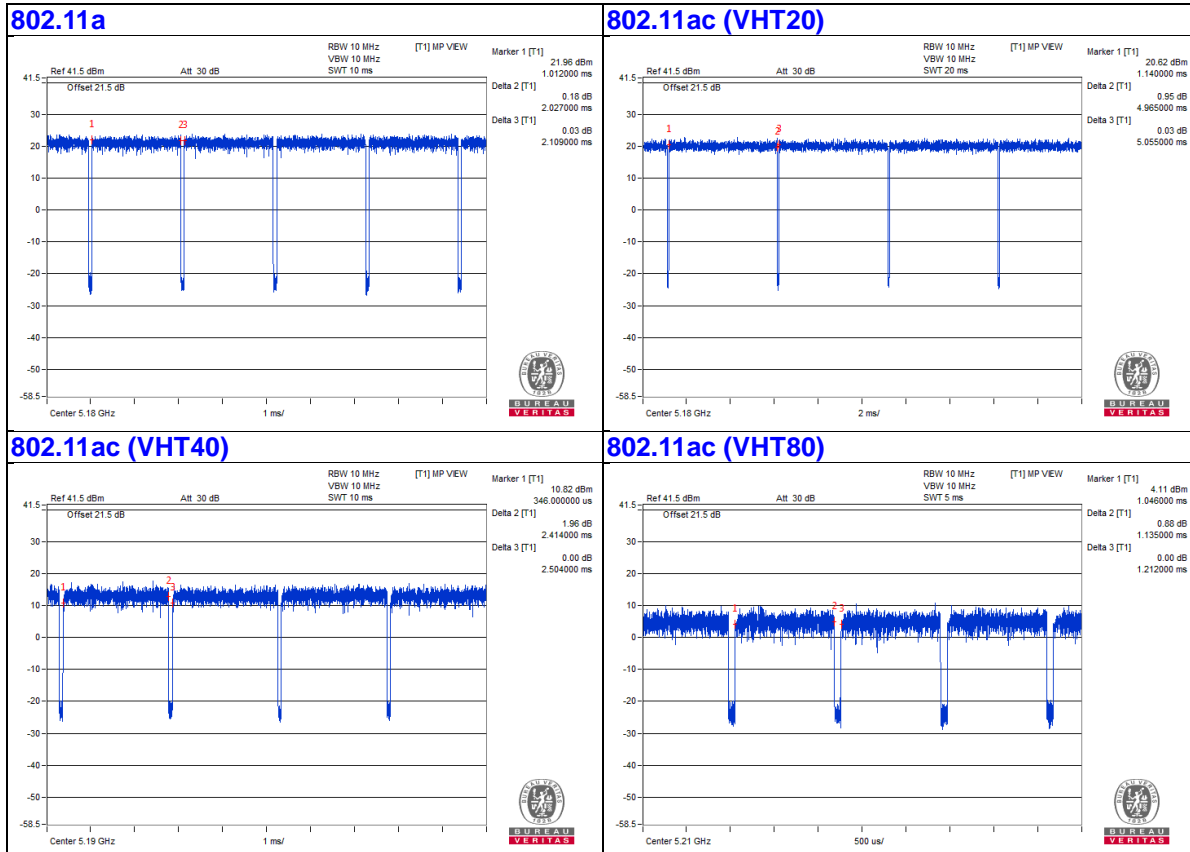

### 3.4 Description of Support Units

The EUT has been tested as an independent unit together with other necessary accessories or support units. The following support units or accessories were used to form a representative test configuration during the tests.

ID	Product	Brand	Model No.	Serial No.	FCC ID	Remarks
A.	iPod	Apple	MD778TA/A	CC4JMFL0F4T1	NA	Provided by Lab
B.	Laptop	DELL	E5430	HYV4VY1	FCC DoC	Provided by Lab
C.	Laptop	DELL	E6420	B92T3R1	FCC DoC	Provided by Lab
D.	SIM Card	R&S	CRT-Z3	NA	NA	Provided by Lab

Note:

1. All power cords of the above support units are non-shielded (1.8m).

ID	Descriptions	Qty.	Length (m)	Shielding (Yes/No)	Cores (Qty.)	Remarks
1.	DC Cable	1	1.5	No	0	Supplied by client
2.	USB Cable	1	0.1	Yes	0	Provided by Lab
3.	RJ-45 Cable	1	10	No	0	Provided by Lab
4.	RJ-45 Cable	1	10	No	0	Provided by Lab
5.	Console Cable	1	1.5	No	0	Provided by Lab

### 3.4.1 Configuration of System under Test

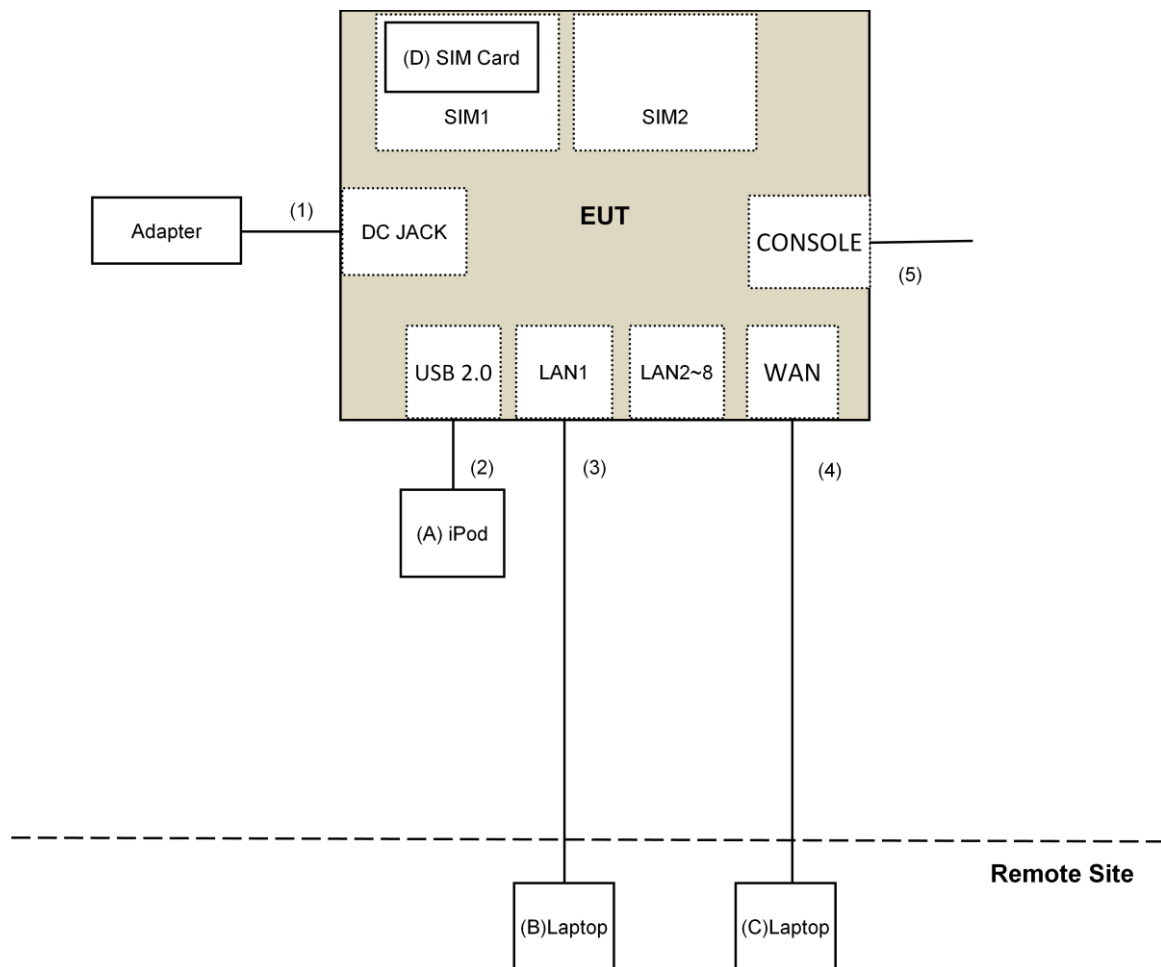

### 3.5 General Description of Applied Standard

The EUT is a RF Product. According to the specifications of the manufacturer, it must comply with the requirements of the following standards:

**FCC Part 15, Subpart E (15.407)**  
**KDB 789033 D02 General UNII Test Procedure New Rules v02r01**  
**KDB 662911 D01 Multiple Transmitter Output v02r01**  
**ANSI C63.10-2013**

All test items have been performed and recorded as per the above standards.



## 4 Test Types and Results

### 4.1 Radiated Emission and Bandedge Measurement

#### 4.1.1 Limits of Radiated Emission and Bandedge Measurement

Radiated emissions which fall in the restricted bands must comply with the radiated emission limits specified as below table.

Frequencies (MHz)	Field Strength (microvolts/meter)	Measurement Distance (meters)
0.009 ~ 0.490	2400/F(kHz)	300
0.490 ~ 1.705	24000/F(kHz)	30
1.705 ~ 30.0	30	30
30 ~ 88	100	3
88 ~ 216	150	3
216 ~ 960	200	3
Above 960	500	3

#### NOTE:

1. The lower limit shall apply at the transition frequencies.
2. Emission level (dBuV/m) = 20 log Emission level (uV/m).
3. For frequencies above 1000MHz, the field strength limits are based on average detector, however, the peak field strength of any emission shall not exceed the maximum permitted average limits, specified above by more than 20dB under any condition of modulation.

Limits of unwanted emission out of the restricted bands

Applicable To		Limit	
789033 D02 General UNII Test Procedure New Rules v02r01		Field Strength at 3m	
		PK:74 (dBuV/m)	AV:54 (dBuV/m)
Frequency Band	Applicable To	EIRP Limit	Equivalent Field Strength at 3m
5150~5250 MHz	15.407(b)(1)	PK:-27 (dBm/MHz)	PK:68.2(dBuV/m)
5250~5350 MHz	15.407(b)(2)		
5470~5725 MHz	15.407(b)(3)		
5725~5850 MHz	<input checked="" type="checkbox"/> 15.407(b)(4)(i)	PK:-27 (dBm/MHz) <sup>*1</sup> PK:10 (dBm/MHz) <sup>*2</sup> PK:15.6 (dBm/MHz) <sup>*3</sup> PK:27 (dBm/MHz) <sup>*4</sup>	PK: 68.2(dBuV/m) <sup>*1</sup> PK:105.2 (dBuV/m) <sup>*2</sup> PK: 110.8(dBuV/m) <sup>*3</sup> PK:122.2 (dBuV/m) <sup>*4</sup>
	<input type="checkbox"/> 15.407(b)(4)(ii)	Emission limits in section 15.247(d)	
<sup>*1</sup> beyond 75 MHz or more above of the band edge.		<sup>*2</sup> below the band edge increasing linearly to 10 dBm/MHz at 25 MHz above.	
<sup>*3</sup> below the band edge increasing linearly to a level of 15.6 dBm/MHz at 5 MHz above.		<sup>*4</sup> from 5 MHz above or below the band edge increasing linearly to a level of 27 dBm/MHz at the band edge.	

#### Note:

The following formula is used to convert the equipment isotropic radiated power (eirp) to field strength:

$$E = \frac{1000000\sqrt{30P}}{3} \mu\text{V/m, where P is the eirp (Watts).}$$

## 4.1.2 Test Instruments

DESCRIPTION & MANUFACTURER	MODEL NO.	SERIAL NO.	CALIBRATED DATE	CALIBRATED UNTIL
Test Receiver Keysight	N9038A	MY54450088	July 05, 2018	July 04, 2019
Pre-Amplifier EMCI	EMC001340	980142	Feb. 09, 2018	Feb. 08, 2019
Loop Antenna <sup>(*)</sup> Electro-Metrics	EM-6879	264	Dec. 16, 2016	Dec. 15, 2018
RF Cable	NA	LOOPCAB-001	Jan. 15, 2018	Jan. 14, 2019
RF Cable	NA	LOOPCAB-002	Jan. 15, 2018	Jan. 14, 2019
Pre-Amplifier Mini-Circuits	ZFL-1000VH2B	AMP-ZFL-01	Oct. 30, 2018	Oct. 29, 2019
Trilog Broadband Antenna SCHWARZBECK	VULB 9168	9168-406	Nov. 22, 2018	Nov. 21, 2019
RF Cable	8D	966-4-1	Mar. 21, 2018	Mar. 20, 2019
RF Cable	8D	966-4-2	Mar. 21, 2018	Mar. 20, 2019
RF Cable	8D	966-4-3	Mar. 21, 2018	Mar. 20, 2019
Fixed attenuator Mini-Circuits	UNAT-5+	PAD-3m-4-01	Sep. 27, 2018	Sep. 26, 2019
Horn_Antenna SCHWARZBECK	BBHA 9120D	9120D-783	Nov. 25, 2018	Nov. 24, 2019
Pre-Amplifier Mini-Circuits	ZVA-183-S+	AMP-ZVA-03	May 10, 2018	May 09, 2019
RF Cable	EMC104-SM-SM-1200	160923	Jan. 29, 2018	Jan. 28, 2019
RF Cable	EMC104-SM-SM-2000	150318	Jan. 29, 2018	Jan. 28, 2019
RF Cable	EMC104-SM-SM-5000	150321	Jan. 29, 2018	Jan. 28, 2019
Pre-Amplifier EMCI	EMC184045SE	980387	Jan. 29, 2018	Jan. 28, 2019
Horn_Antenna SCHWARZBECK	BBHA 9170	BBHA9170608	Nov. 25, 2018	Nov. 24, 2019
RF Cable	EMC102-KM-KM-1200	160925	Jan. 29, 2018	Jan. 28, 2019
Software	ADT_Radiated_V8.7.08	NA	NA	NA
Boresight Antenna Tower & Turn Table Max-Full	MF-7802BS	MF780208530	NA	NA
Spectrum Analyzer R&S	FSV40	100964	June 20, 2018	June 19, 2019
Power meter Anritsu	ML2495A	1014008	May 09, 2018	May 08, 2019
Power sensor Anritsu	MA2411B	0917122	May 09, 2018	May 08, 2019
AC Power Source Extech Electronics	6205	1440452	NA	NA
Temperature & Humidity Chamber Giant Force	GTH-150-40-SP-AR	MAA0812-008	Jan. 10, 2018	Jan. 09, 2019
True RMS Clamp Meter FLUKE	325	31130711WS	May 22, 2018	May 21, 2019

**Note:**

1. The calibration interval of the above test instruments is 12 months and the calibrations are traceable to NML/ROC and NIST/USA.
2. \*The calibration interval of the above test instruments is 24 months and the calibrations are traceable to NML/ROC and NIST/USA.
3. The test was performed in 966 Chamber No. 4.
4. The CANADA Site Registration No. is 20331-2
5. Loop antenna was used for all emissions below 30 MHz.
6. Tested Date: Nov. 30 to Dec. 11, 2018

#### 4.1.3 Test Procedure

##### **For Radiated emission below 30MHz**

- a. The EUT was placed on the top of a rotating table 0.8 meters above the ground at a 3 meter chamber room. The table was rotated 360 degrees to determine the position of the highest radiation.
- b. The EUT was set 3 meters away from the interference-receiving antenna, which was mounted on the top of a variable-height antenna tower.
- c. Parallel, perpendicular, and ground-parallel orientations of the antenna are set to make the measurement.
- d. For each suspected emission, the EUT was arranged to its worst case and the rotatable table was turned from 0 degrees to 360 degrees to find the maximum reading.
- e. The test-receiver system was set to Quasi-Peak Detect Function and Specified Bandwidth with Maximum Hold Mode.

##### **NOTE:**

1. The resolution bandwidth and video bandwidth of test receiver/spectrum analyzer is 9kHz at frequency below 30MHz.

##### **For Radiated emission above 30MHz**

- a. The EUT was placed on the top of a rotating table 0.8 meters (for 30MHz ~ 1GHz) / 1.5 meters (for above 1GHz) above the ground at 3 meter chamber room for test. The table was rotated 360 degrees to determine the position of the highest radiation.
- b. The EUT was set 3 meters away from the interference-receiving antenna, which was mounted on the top of a variable-height antenna tower.
- c. The height of antenna is varied from one meter to four meters above the ground to determine the maximum value of the field strength. Both horizontal and vertical polarizations of the antenna are set to make the measurement.
- d. For each suspected emission, the EUT was arranged to its worst case and then the antenna was tuned to heights from 1 meter to 4 meters and the rotatable table was turned from 0 degrees to 360 degrees to find the maximum reading.
- e. The test-receiver system was set to quasi-peak detect function and specified bandwidth with maximum hold mode when the test frequency is below 1 GHz.
- f. The test-receiver system was set to peak and average detects function and specified bandwidth with maximum hold mode when the test frequency is above 1 GHz. If the peak reading value also meets average limit, measurement with the average detector is unnecessary.

##### **Note:**

1. The resolution bandwidth and video bandwidth of test receiver/spectrum analyzer is 120kHz for Quasi-peak detection (QP) at frequency below 1GHz.
2. The resolution bandwidth of test receiver/spectrum analyzer is 1 MHz and the video bandwidth is 3 MHz for Peak detection (PK) at frequency above 1GHz.
3. The resolution bandwidth of test receiver/spectrum analyzer is 1MHz and the video bandwidth is  $\geq 1/T$  (Duty cycle < 98%) or 10Hz (Duty cycle  $\geq 98\%$ ) for Average detection (AV) at frequency above 1GHz.
4. All modes of operation were investigated and the worst-case emissions are reported.

4.1.4 Deviation from Test Standard

No deviation.

4.1.5 Test Setup

**For Radiated emission below 30MHz**

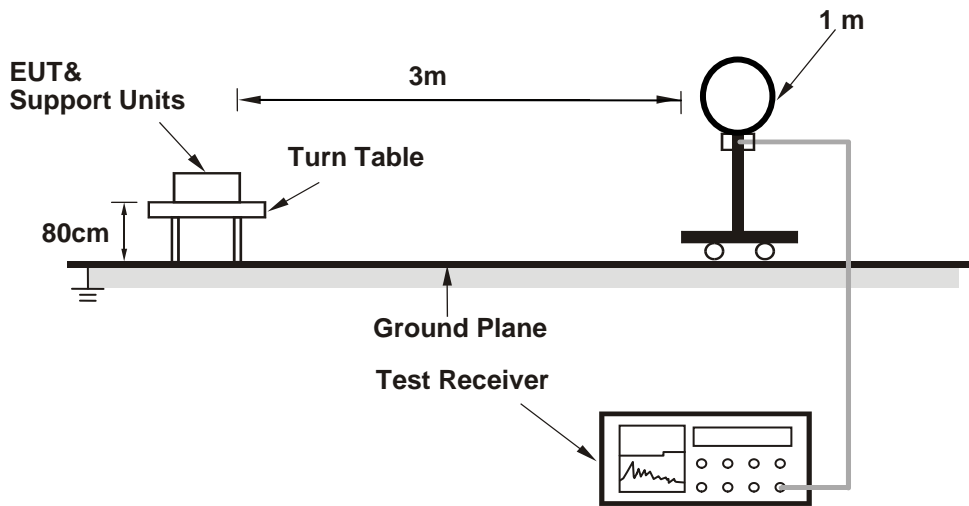

**For Radiated emission 30MHz to 1GHz**

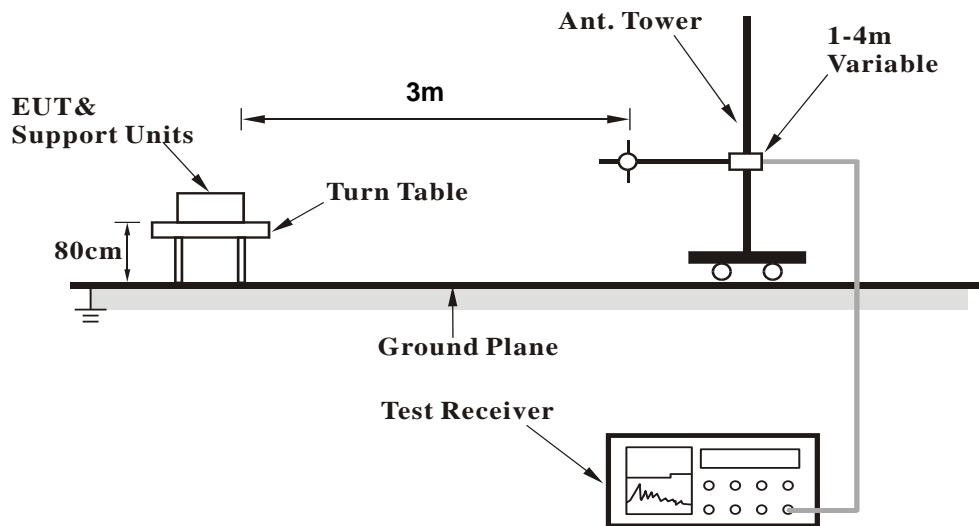

### For Radiated emission above 1GHz

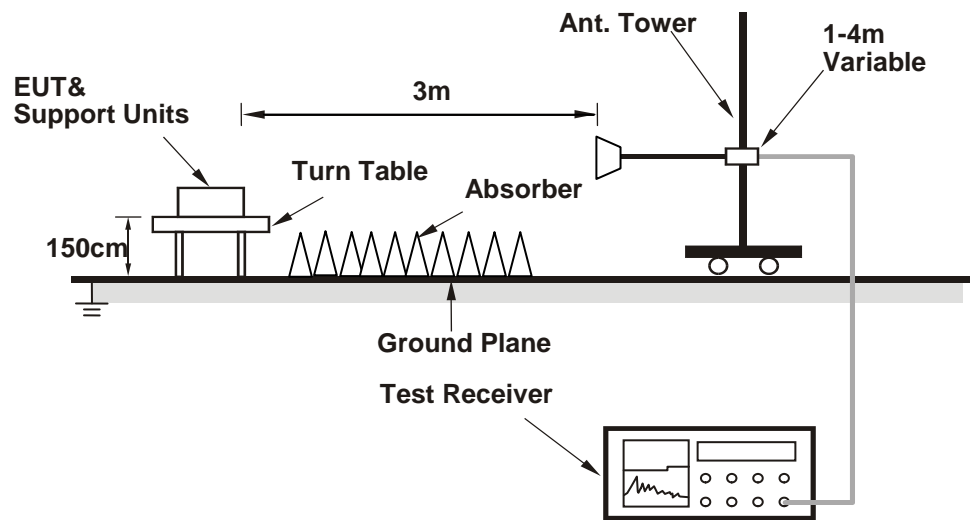

For the actual test configuration, please refer to the attached file (Test Setup Photo).

#### 4.1.6 EUT Operating Condition

- Connected the EUT with the Laptop is placed on remote site.
- Controlling software (QDART\_1.0.44) has been activated to set the EUT on specific status.

## 4.1.7 Test Results

## Above 1GHz Data:

## 802.11a

<b>CHANNEL</b>	TX Channel 36	<b>DETECTOR FUNCTION</b>	Peak (PK)
<b>FREQUENCY RANGE</b>	1GHz ~ 40GHz		Average (AV)

**ANTENNA POLARITY & TEST DISTANCE: HORIZONTAL AT 3 M**

NO.	FREQ. (MHz)	EMISSION LEVEL (dBuV/m)	LIMIT (dBuV/m)	MARGIN (dB)	ANTENNA HEIGHT (m)	TABLE ANGLE (Degree)	RAW VALUE (dBuV)	CORRECTION FACTOR (dB/m)
1	5150.00	55.3 PK	74.0	-18.7	1.46 H	150	52.3	3.0
2	5150.00	43.6 AV	54.0	-10.4	1.46 H	150	40.6	3.0
3	*5180.00	107.5 PK			1.46 H	150	104.6	2.9
4	*5180.00	98.4 AV			1.46 H	150	95.5	2.9
5	#10360.00	57.6 PK	68.2	-10.6	1.08 H	173	44.6	13.0
6	15540.00	51.2 PK	74.0	-22.8	1.32 H	176	38.1	13.1
7	15540.00	40.0 AV	54.0	-14.0	1.32 H	176	26.9	13.1

**ANTENNA POLARITY & TEST DISTANCE: VERTICAL AT 3 M**

NO.	FREQ. (MHz)	EMISSION LEVEL (dBuV/m)	LIMIT (dBuV/m)	MARGIN (dB)	ANTENNA HEIGHT (m)	TABLE ANGLE (Degree)	RAW VALUE (dBuV)	CORRECTION FACTOR (dB/m)
1	5150.00	62.3 PK	74.0	-11.7	2.77 V	179	59.3	3.0
2	5150.00	50.2 AV	54.0	-3.8	2.77 V	179	47.2	3.0
3	*5180.00	113.2 PK			2.77 V	179	110.3	2.9
4	*5180.00	104.1 AV			2.77 V	179	101.2	2.9
5	#10360.00	62.5 PK	68.2	-5.7	1.56 V	288	49.5	13.0
6	15540.00	52.4 PK	74.0	-21.6	1.54 V	212	39.3	13.1
7	15540.00	40.9 AV	54.0	-13.1	1.54 V	212	27.8	13.1

**REMARKS:**

1. Emission Level(dBuV/m) = Raw Value(dBuV) + Correction Factor(dB/m)
2. Correction Factor(dB/m) = Antenna Factor(dB/m) + Cable Factor(dB) – Pre-Amplifier Factor(dB)
3. The other emission levels were very low against the limit.
4. Margin value = Emission Level – Limit value
5. " \* ": Fundamental frequency.
6. " # ": The radiated frequency is out of the restricted band.

<b>CHANNEL</b>	TX Channel 40	<b>DETECTOR FUNCTION</b>	Peak (PK)
<b>FREQUENCY RANGE</b>	1GHz ~ 40GHz		Average (AV)

**ANTENNA POLARITY & TEST DISTANCE: HORIZONTAL AT 3 M**

NO.	FREQ. (MHz)	EMISSION LEVEL (dBuV/m)	LIMIT (dBuV/m)	MARGIN (dB)	ANTENNA HEIGHT (m)	TABLE ANGLE (Degree)	RAW VALUE (dBuV)	CORRECTION FACTOR (dB/m)
1	*5200.00	107.8 PK			1.51 H	163	104.9	2.9
2	*5200.00	98.6 AV			1.51 H	163	95.7	2.9
3	#10400.00	56.9 PK	68.2	-11.3	1.08 H	161	43.8	13.1
4	15600.00	51.8 PK	74.0	-22.2	1.28 H	166	38.8	13.0
5	15600.00	40.4 AV	54.0	-13.6	1.28 H	166	27.4	13.0

**ANTENNA POLARITY & TEST DISTANCE: VERTICAL AT 3 M**

NO.	FREQ. (MHz)	EMISSION LEVEL (dBuV/m)	LIMIT (dBuV/m)	MARGIN (dB)	ANTENNA HEIGHT (m)	TABLE ANGLE (Degree)	RAW VALUE (dBuV)	CORRECTION FACTOR (dB/m)
1	*5200.00	113.1 PK			2.71 V	185	110.2	2.9
2	*5200.00	104.0 AV			2.71 V	185	101.1	2.9
3	#10400.00	62.2 PK	68.2	-6.0	1.58 V	281	49.1	13.1
4	15600.00	51.9 PK	74.0	-22.1	1.58 V	221	38.9	13.0
5	15600.00	40.6 AV	54.0	-13.4	1.58 V	221	27.6	13.0

**REMARKS:**

1. Emission Level(dBuV/m) = Raw Value(dBuV) + Correction Factor(dB/m)
2. Correction Factor(dB/m) = Antenna Factor(dB/m) + Cable Factor(dB) – Pre-Amplifier Factor(dB)
3. The other emission levels were very low against the limit.
4. Margin value = Emission Level – Limit value
5. " \* ": Fundamental frequency.
6. " # ": The radiated frequency is out of the restricted band.



<b>CHANNEL</b>	TX Channel 48	<b>DETECTOR FUNCTION</b>	Peak (PK)
<b>FREQUENCY RANGE</b>	1GHz ~ 40GHz		Average (AV)

**ANTENNA POLARITY & TEST DISTANCE: HORIZONTAL AT 3 M**

NO.	FREQ. (MHz)	EMISSION LEVEL (dBuV/m)	LIMIT (dBuV/m)	MARGIN (dB)	ANTENNA HEIGHT (m)	TABLE ANGLE (Degree)	RAW VALUE (dBuV)	CORRECTION FACTOR (dB/m)
1	*5240.00	107.0 PK			1.47 H	163	104.5	2.5
2	*5240.00	98.0 AV			1.47 H	163	95.5	2.5
3	5350.00	47.6 PK	74.0	-26.4	1.47 H	163	44.8	2.8
4	5350.00	35.4 AV	54.0	-18.6	1.47 H	163	32.6	2.8
5	#10480.00	55.0 PK	68.2	-13.2	1.06 H	176	41.8	13.2
6	15720.00	49.9 PK	74.0	-24.1	1.28 H	162	37.5	12.4
7	15720.00	38.5 AV	54.0	-15.5	1.28 H	162	26.1	12.4

**ANTENNA POLARITY & TEST DISTANCE: VERTICAL AT 3 M**

NO.	FREQ. (MHz)	EMISSION LEVEL (dBuV/m)	LIMIT (dBuV/m)	MARGIN (dB)	ANTENNA HEIGHT (m)	TABLE ANGLE (Degree)	RAW VALUE (dBuV)	CORRECTION FACTOR (dB/m)
1	*5240.00	112.6 PK			2.78 V	178	110.1	2.5
2	*5240.00	103.5 AV			2.78 V	178	101.0	2.5
3	5350.00	48.7 PK	74.0	-25.3	2.78 V	178	45.9	2.8
4	5350.00	36.3 AV	54.0	-17.7	2.78 V	178	33.5	2.8
5	#10480.00	59.8 PK	68.2	-8.4	1.58 V	296	46.6	13.2
6	15720.00	50.7 PK	74.0	-23.3	1.49 V	209	38.3	12.4
7	15720.00	39.2 AV	54.0	-14.8	1.49 V	209	26.8	12.4

**REMARKS:**

1. Emission Level(dBuV/m) = Raw Value(dBuV) + Correction Factor(dB/m)
2. Correction Factor(dB/m) = Antenna Factor(dB/m) + Cable Factor(dB) – Pre-Amplifier Factor(dB)
3. The other emission levels were very low against the limit.
4. Margin value = Emission Level – Limit value
5. " \* ": Fundamental frequency.
6. " # ": The radiated frequency is out of the restricted band.

<b>CHANNEL</b>	TX Channel 149	<b>DETECTOR FUNCTION</b>	Peak (PK)
<b>FREQUENCY RANGE</b>	1GHz ~ 40GHz		Average (AV)

**ANTENNA POLARITY & TEST DISTANCE: HORIZONTAL AT 3 M**

NO.	FREQ. (MHz)	EMISSION LEVEL (dBuV/m)	LIMIT (dBuV/m)	MARGIN (dB)	ANTENNA HEIGHT (m)	TABLE ANGLE (Degree)	RAW VALUE (dBuV)	CORRECTION FACTOR (dB/m)
1	#5630.12	50.2 PK	68.2	-18.0	1.45 H	168	46.9	3.3
2	*5745.00	107.2 PK			1.45 H	168	103.6	3.6
3	*5745.00	97.7 AV			1.45 H	168	94.1	3.6
4	#5974.71	50.1 PK	68.2	-18.1	1.45 H	168	46.5	3.6
5	#6250.00	44.7 PK	68.2	-23.5	1.02 H	102	40.0	4.7
6	11490.00	56.2 PK	74.0	-17.8	1.03 H	167	42.4	13.8
7	11490.00	44.8 AV	54.0	-9.2	1.03 H	167	31.0	13.8
8	#17235.00	51.2 PK	68.2	-17.0	1.24 H	179	34.1	17.1

**ANTENNA POLARITY & TEST DISTANCE: VERTICAL AT 3 M**

NO.	FREQ. (MHz)	EMISSION LEVEL (dBuV/m)	LIMIT (dBuV/m)	MARGIN (dB)	ANTENNA HEIGHT (m)	TABLE ANGLE (Degree)	RAW VALUE (dBuV)	CORRECTION FACTOR (dB/m)
1	#5610.14	50.2 PK	68.2	-18.0	1.51 V	270	46.9	3.3
2	*5745.00	113.3 PK			1.51 V	270	109.7	3.6
3	*5745.00	103.4 AV			1.51 V	270	99.8	3.6
4	#5973.84	50.1 PK	68.2	-18.1	1.51 V	270	46.5	3.6
5	#6250.00	46.0 PK	68.2	-22.2	1.42 V	170	41.3	4.7
6	11490.00	61.7 PK	74.0	-12.3	1.51 V	270	47.9	13.8
7	11490.00	49.6 AV	54.0	-4.4	1.51 V	270	35.8	13.8
8	#17235.00	51.3 PK	68.2	-16.9	1.56 V	233	34.2	17.1

**REMARKS:**

1. Emission Level(dBuV/m) = Raw Value(dBuV) + Correction Factor(dB/m)
2. Correction Factor(dB/m) = Antenna Factor(dB/m) + Cable Factor(dB) – Pre-Amplifier Factor(dB)
3. The other emission levels were very low against the limit.
4. Margin value = Emission Level – Limit value
5. " \* ": Fundamental frequency.
6. " # ": The radiated frequency is out of the restricted band.

<b>CHANNEL</b>	TX Channel 157	<b>DETECTOR FUNCTION</b>	Peak (PK)
<b>FREQUENCY RANGE</b>	1GHz ~ 40GHz		Average (AV)

**ANTENNA POLARITY & TEST DISTANCE: HORIZONTAL AT 3 M**

NO.	FREQ. (MHz)	EMISSION LEVEL (dBuV/m)	LIMIT (dBuV/m)	MARGIN (dB)	ANTENNA HEIGHT (m)	TABLE ANGLE (Degree)	RAW VALUE (dBuV)	CORRECTION FACTOR (dB/m)
1	#5643.94	49.4 PK	68.2	-18.8	1.42 H	155	46.2	3.2
2	*5785.00	107.4 PK			1.42 H	155	103.8	3.6
3	*5785.00	97.5 AV			1.42 H	155	93.9	3.6
4	#6009.50	50.6 PK	68.2	-17.6	1.42 H	155	46.9	3.7
5	11570.00	56.3 PK	74.0	-17.7	1.03 H	157	42.6	13.7
6	11570.00	44.9 AV	54.0	-9.1	1.03 H	157	31.2	13.7
7	#17355.00	51.3 PK	68.2	-16.9	1.25 H	187	33.7	17.6

**ANTENNA POLARITY & TEST DISTANCE: VERTICAL AT 3 M**

NO.	FREQ. (MHz)	EMISSION LEVEL (dBuV/m)	LIMIT (dBuV/m)	MARGIN (dB)	ANTENNA HEIGHT (m)	TABLE ANGLE (Degree)	RAW VALUE (dBuV)	CORRECTION FACTOR (dB/m)
1	#5638.61	49.7 PK	68.2	-18.5	1.49 V	268	46.5	3.2
2	*5785.00	113.4 PK			1.49 V	268	109.8	3.6
3	*5785.00	103.1 AV			1.49 V	268	99.5	3.6
4	#6016.45	49.8 PK	68.2	-18.4	1.49 V	268	46.0	3.8
5	11570.00	61.4 PK	74.0	-12.6	1.49 V	269	47.7	13.7
6	11570.00	49.1 AV	54.0	-4.9	1.49 V	269	35.4	13.7
7	#17355.00	51.4 PK	68.2	-16.8	1.55 V	231	33.8	17.6

**REMARKS:**

1. Emission Level(dBuV/m) = Raw Value(dBuV) + Correction Factor(dB/m)
2. Correction Factor(dB/m) = Antenna Factor(dB/m) + Cable Factor(dB) – Pre-Amplifier Factor(dB)
3. The other emission levels were very low against the limit.
4. Margin value = Emission Level – Limit value
5. " \* ": Fundamental frequency.
6. " # ": The radiated frequency is out of the restricted band.

<b>CHANNEL</b>	TX Channel 165	<b>DETECTOR FUNCTION</b>	Peak (PK)
<b>FREQUENCY RANGE</b>	1GHz ~ 40GHz		Average (AV)

**ANTENNA POLARITY & TEST DISTANCE: HORIZONTAL AT 3 M**

NO.	FREQ. (MHz)	EMISSION LEVEL (dBuV/m)	LIMIT (dBuV/m)	MARGIN (dB)	ANTENNA HEIGHT (m)	TABLE ANGLE (Degree)	RAW VALUE (dBuV)	CORRECTION FACTOR (dB/m)
1	#5647.04	50.0 PK	68.2	-18.2	1.40 H	158	46.8	3.2
2	*5825.00	107.3 PK			1.40 H	158	103.5	3.8
3	*5825.00	97.6 AV			1.40 H	158	93.8	3.8
4	#6013.71	49.6 PK	68.2	-18.6	1.40 H	158	45.8	3.8
5	11650.00	56.6 PK	74.0	-17.4	1.00 H	163	43.0	13.6
6	11650.00	44.9 AV	54.0	-9.1	1.00 H	163	31.3	13.6
7	#17475.00	51.3 PK	68.2	-16.9	1.20 H	189	32.7	18.6

**ANTENNA POLARITY & TEST DISTANCE: VERTICAL AT 3 M**

NO.	FREQ. (MHz)	EMISSION LEVEL (dBuV/m)	LIMIT (dBuV/m)	MARGIN (dB)	ANTENNA HEIGHT (m)	TABLE ANGLE (Degree)	RAW VALUE (dBuV)	CORRECTION FACTOR (dB/m)
1	#5638.01	49.8 PK	68.2	-18.4	1.58 V	272	46.6	3.2
2	*5825.00	113.2 PK			1.58 V	272	109.4	3.8
3	*5825.00	103.2 AV			1.58 V	272	99.4	3.8
4	#5964.53	51.2 PK	68.2	-17.0	1.58 V	272	47.7	3.5
5	11650.00	62.4 PK	74.0	-11.6	1.47 V	263	48.8	13.6
6	11650.00	50.1 AV	54.0	-3.9	1.47 V	263	36.5	13.6
7	#17475.00	51.1 PK	68.2	-17.1	1.56 V	236	32.5	18.6

**REMARKS:**

1. Emission Level(dBuV/m) = Raw Value(dBuV) + Correction Factor(dB/m)
2. Correction Factor(dB/m) = Antenna Factor(dB/m) + Cable Factor(dB) – Pre-Amplifier Factor(dB)
3. The other emission levels were very low against the limit.
4. Margin value = Emission Level – Limit value
5. " \* ": Fundamental frequency.
6. " # ": The radiated frequency is out of the restricted band.

**802.11ac (VHT20)**

<b>CHANNEL</b>	TX Channel 36	<b>DETECTOR FUNCTION</b>	Peak (PK)
<b>FREQUENCY RANGE</b>	1GHz ~ 40GHz		Average (AV)

**ANTENNA POLARITY & TEST DISTANCE: HORIZONTAL AT 3 M**

NO.	FREQ. (MHz)	EMISSION LEVEL (dBuV/m)	LIMIT (dBuV/m)	MARGIN (dB)	ANTENNA HEIGHT (m)	TABLE ANGLE (Degree)	RAW VALUE (dBuV)	CORRECTION FACTOR (dB/m)
1	5150.00	53.3 PK	74.0	-20.7	1.50 H	152	50.3	3.0
2	5150.00	42.3 AV	54.0	-11.7	1.50 H	152	39.3	3.0
3	*5180.00	107.4 PK			1.50 H	152	104.5	2.9
4	*5180.00	97.7 AV			1.50 H	152	94.8	2.9
5	#10360.00	57.0 PK	68.2	-11.2	1.06 H	157	44.0	13.0
6	15540.00	51.9 PK	74.0	-22.1	1.32 H	158	38.8	13.1
7	15540.00	40.3 AV	54.0	-13.7	1.32 H	158	27.2	13.1

**ANTENNA POLARITY & TEST DISTANCE: VERTICAL AT 3 M**

NO.	FREQ. (MHz)	EMISSION LEVEL (dBuV/m)	LIMIT (dBuV/m)	MARGIN (dB)	ANTENNA HEIGHT (m)	TABLE ANGLE (Degree)	RAW VALUE (dBuV)	CORRECTION FACTOR (dB/m)
1	5150.00	57.3 PK	74.0	-16.7	2.70 V	159	54.3	3.0
2	5150.00	46.5 AV	54.0	-7.5	2.70 V	159	43.5	3.0
3	*5180.00	113.1 PK			2.70 V	159	110.2	2.9
4	*5180.00	103.4 AV			2.70 V	159	100.5	2.9
5	#10360.00	61.7 PK	68.2	-6.5	1.53 V	270	48.7	13.0
6	15540.00	51.9 PK	74.0	-22.1	1.53 V	228	38.8	13.1
7	15540.00	40.4 AV	54.0	-13.6	1.53 V	228	27.3	13.1

**REMARKS:**

1. Emission Level(dBuV/m) = Raw Value(dBuV) + Correction Factor(dB/m)
2. Correction Factor(dB/m) = Antenna Factor(dB/m) + Cable Factor(dB) – Pre-Amplifier Factor(dB)
3. The other emission levels were very low against the limit.
4. Margin value = Emission Level – Limit value
5. " \* ": Fundamental frequency.
6. " # ": The radiated frequency is out of the restricted band.

<b>CHANNEL</b>	TX Channel 40	<b>DETECTOR FUNCTION</b>	Peak (PK)
<b>FREQUENCY RANGE</b>	1GHz ~ 40GHz		Average (AV)

**ANTENNA POLARITY & TEST DISTANCE: HORIZONTAL AT 3 M**

NO.	FREQ. (MHz)	EMISSION LEVEL (dBuV/m)	LIMIT (dBuV/m)	MARGIN (dB)	ANTENNA HEIGHT (m)	TABLE ANGLE (Degree)	RAW VALUE (dBuV)	CORRECTION FACTOR (dB/m)
1	*5200.00	107.1 PK			1.50 H	156	104.2	2.9
2	*5200.00	97.5 AV			1.50 H	156	94.6	2.9
3	#10400.00	56.9 PK	68.2	-11.3	1.07 H	163	43.8	13.1
4	15600.00	51.8 PK	74.0	-22.2	1.27 H	174	38.8	13.0
5	15600.00	40.1 AV	54.0	-13.9	1.27 H	174	27.1	13.0

**ANTENNA POLARITY & TEST DISTANCE: VERTICAL AT 3 M**

NO.	FREQ. (MHz)	EMISSION LEVEL (dBuV/m)	LIMIT (dBuV/m)	MARGIN (dB)	ANTENNA HEIGHT (m)	TABLE ANGLE (Degree)	RAW VALUE (dBuV)	CORRECTION FACTOR (dB/m)
1	*5200.00	113.3 PK			2.68 V	162	110.4	2.9
2	*5200.00	103.1 AV			2.68 V	162	100.2	2.9
3	#10400.00	61.7 PK	68.2	-6.5	1.52 V	287	48.6	13.1
4	15600.00	52.6 PK	74.0	-21.4	1.54 V	209	39.6	13.0
5	15600.00	41.1 AV	54.0	-12.9	1.54 V	209	28.1	13.0

**REMARKS:**

1. Emission Level(dBuV/m) = Raw Value(dBuV) + Correction Factor(dB/m)
2. Correction Factor(dB/m) = Antenna Factor(dB/m) + Cable Factor(dB) – Pre-Amplifier Factor(dB)
3. The other emission levels were very low against the limit.
4. Margin value = Emission Level – Limit value
5. " \* ": Fundamental frequency.
6. " # ": The radiated frequency is out of the restricted band.

<b>CHANNEL</b>	TX Channel 48	<b>DETECTOR FUNCTION</b>	Peak (PK)
<b>FREQUENCY RANGE</b>	1GHz ~ 40GHz		Average (AV)

**ANTENNA POLARITY & TEST DISTANCE: HORIZONTAL AT 3 M**

NO.	FREQ. (MHz)	EMISSION LEVEL (dBuV/m)	LIMIT (dBuV/m)	MARGIN (dB)	ANTENNA HEIGHT (m)	TABLE ANGLE (Degree)	RAW VALUE (dBuV)	CORRECTION FACTOR (dB/m)
1	*5240.00	106.7 PK			1.49 H	145	104.2	2.5
2	*5240.00	96.8 AV			1.49 H	145	94.3	2.5
3	5350.00	48.7 PK	74.0	-25.3	1.49 H	145	45.9	2.8
4	5350.00	35.8 AV	54.0	-18.2	1.49 H	145	33.0	2.8
5	#10480.00	55.1 PK	68.2	-13.1	1.09 H	160	41.9	13.2
6	15720.00	50.2 PK	74.0	-23.8	1.31 H	162	37.8	12.4
7	15720.00	38.5 AV	54.0	-15.5	1.31 H	162	26.1	12.4

**ANTENNA POLARITY & TEST DISTANCE: VERTICAL AT 3 M**

NO.	FREQ. (MHz)	EMISSION LEVEL (dBuV/m)	LIMIT (dBuV/m)	MARGIN (dB)	ANTENNA HEIGHT (m)	TABLE ANGLE (Degree)	RAW VALUE (dBuV)	CORRECTION FACTOR (dB/m)
1	*5240.00	112.7 PK			2.71 V	163	110.2	2.5
2	*5240.00	102.5 AV			2.71 V	163	100.0	2.5
3	5350.00	48.9 PK	74.0	-25.1	2.71 V	163	46.1	2.8
4	5350.00	36.3 AV	54.0	-17.7	2.71 V	163	33.5	2.8
5	#10480.00	60.1 PK	68.2	-8.1	1.59 V	293	46.9	13.2
6	15720.00	50.9 PK	74.0	-23.1	1.51 V	214	38.5	12.4
7	15720.00	39.2 AV	54.0	-14.8	1.51 V	214	26.8	12.4

**REMARKS:**

1. Emission Level(dBuV/m) = Raw Value(dBuV) + Correction Factor(dB/m)
2. Correction Factor(dB/m) = Antenna Factor(dB/m) + Cable Factor(dB) – Pre-Amplifier Factor(dB)
3. The other emission levels were very low against the limit.
4. Margin value = Emission Level – Limit value
5. " \* ": Fundamental frequency.
6. " # ": The radiated frequency is out of the restricted band.

<b>CHANNEL</b>	TX Channel 149	<b>DETECTOR FUNCTION</b>	Peak (PK)
<b>FREQUENCY RANGE</b>	1GHz ~ 40GHz		Average (AV)

**ANTENNA POLARITY & TEST DISTANCE: HORIZONTAL AT 3 M**

NO.	FREQ. (MHz)	EMISSION LEVEL (dBuV/m)	LIMIT (dBuV/m)	MARGIN (dB)	ANTENNA HEIGHT (m)	TABLE ANGLE (Degree)	RAW VALUE (dBuV)	CORRECTION FACTOR (dB/m)
1	#5636.62	50.2 PK	68.2	-18.0	1.51 H	156	47.0	3.2
2	*5745.00	107.6 PK			1.51 H	156	104.0	3.6
3	*5745.00	96.7 AV			1.51 H	156	93.1	3.6
4	#6013.08	50.0 PK	68.2	-18.2	1.51 H	156	46.3	3.7
5	11490.00	56.4 PK	74.0	-17.6	1.07 H	170	42.6	13.8
6	11490.00	45.3 AV	54.0	-8.7	1.07 H	170	31.5	13.8
7	#17235.00	51.0 PK	68.2	-17.2	1.20 H	180	33.9	17.1

**ANTENNA POLARITY & TEST DISTANCE: VERTICAL AT 3 M**

NO.	FREQ. (MHz)	EMISSION LEVEL (dBuV/m)	LIMIT (dBuV/m)	MARGIN (dB)	ANTENNA HEIGHT (m)	TABLE ANGLE (Degree)	RAW VALUE (dBuV)	CORRECTION FACTOR (dB/m)
1	#5633.48	50.3 PK	68.2	-17.9	2.71 V	106	47.1	3.2
2	*5745.00	116.8 PK			2.71 V	106	113.2	3.6
3	*5745.00	106.2 AV			2.71 V	106	102.6	3.6
4	#5941.86	51.5 PK	68.2	-16.7	2.71 V	106	48.0	3.5
5	11490.00	61.5 PK	74.0	-12.5	1.51 V	282	47.7	13.8
6	11490.00	49.6 AV	54.0	-4.4	1.51 V	282	35.8	13.8
7	#17235.00	51.6 PK	68.2	-16.6	1.52 V	236	34.5	17.1

**REMARKS:**

1. Emission Level(dBuV/m) = Raw Value(dBuV) + Correction Factor(dB/m)
2. Correction Factor(dB/m) = Antenna Factor(dB/m) + Cable Factor(dB) – Pre-Amplifier Factor(dB)
3. The other emission levels were very low against the limit.
4. Margin value = Emission Level – Limit value
5. " \* ": Fundamental frequency.
6. " # ": The radiated frequency is out of the restricted band.



<b>CHANNEL</b>	TX Channel 157	<b>DETECTOR FUNCTION</b>	Peak (PK)
<b>FREQUENCY RANGE</b>	1GHz ~ 40GHz		Average (AV)

**ANTENNA POLARITY & TEST DISTANCE: HORIZONTAL AT 3 M**

NO.	FREQ. (MHz)	EMISSION LEVEL (dBuV/m)	LIMIT (dBuV/m)	MARGIN (dB)	ANTENNA HEIGHT (m)	TABLE ANGLE (Degree)	RAW VALUE (dBuV)	CORRECTION FACTOR (dB/m)
1	#5585.13	50.1 PK	68.2	-18.1	1.58 H	159	46.9	3.2
2	*5785.00	107.5 PK			1.58 H	159	103.9	3.6
3	*5785.00	96.5 AV			1.58 H	159	92.9	3.6
4	#6005.36	50.0 PK	68.2	-18.2	1.58 H	159	46.3	3.7
5	11570.00	56.5 PK	74.0	-17.5	1.00 H	155	42.8	13.7
6	11570.00	44.8 AV	54.0	-9.2	1.00 H	155	31.1	13.7
7	#17355.00	51.7 PK	68.2	-16.5	1.26 H	176	34.1	17.6

**ANTENNA POLARITY & TEST DISTANCE: VERTICAL AT 3 M**

NO.	FREQ. (MHz)	EMISSION LEVEL (dBuV/m)	LIMIT (dBuV/m)	MARGIN (dB)	ANTENNA HEIGHT (m)	TABLE ANGLE (Degree)	RAW VALUE (dBuV)	CORRECTION FACTOR (dB/m)
1	#5647.43	54.4 PK	68.2	-13.8	2.69 V	101	51.2	3.2
2	*5785.00	116.9 PK			2.69 V	101	113.3	3.6
3	*5785.00	106.3 AV			2.69 V	101	102.7	3.6
4	#5926.12	54.5 PK	68.2	-13.7	2.69 V	101	50.9	3.6
5	11570.00	61.7 PK	74.0	-12.3	1.48 V	271	48.0	13.7
6	11570.00	49.6 AV	54.0	-4.4	1.48 V	271	35.9	13.7
7	#17355.00	51.3 PK	68.2	-16.9	1.54 V	229	33.7	17.6

**REMARKS:**

1. Emission Level(dBuV/m) = Raw Value(dBuV) + Correction Factor(dB/m)
2. Correction Factor(dB/m) = Antenna Factor(dB/m) + Cable Factor(dB) – Pre-Amplifier Factor(dB)
3. The other emission levels were very low against the limit.
4. Margin value = Emission Level – Limit value
5. " \* ": Fundamental frequency.
6. " # ": The radiated frequency is out of the restricted band.

<b>CHANNEL</b>	TX Channel 165	<b>DETECTOR FUNCTION</b>	Peak (PK)
<b>FREQUENCY RANGE</b>	1GHz ~ 40GHz		Average (AV)

**ANTENNA POLARITY & TEST DISTANCE: HORIZONTAL AT 3 M**

NO.	FREQ. (MHz)	EMISSION LEVEL (dBuV/m)	LIMIT (dBuV/m)	MARGIN (dB)	ANTENNA HEIGHT (m)	TABLE ANGLE (Degree)	RAW VALUE (dBuV)	CORRECTION FACTOR (dB/m)
1	#5555.43	50.0 PK	68.2	-18.2	1.50 H	154	47.0	3.0
2	*5825.00	107.7 PK			1.50 H	154	103.9	3.8
3	*5825.00	96.8 AV			1.50 H	154	93.0	3.8
4	#5967.15	50.4 PK	68.2	-17.8	1.50 H	154	46.8	3.6
5	11650.00	56.6 PK	74.0	-17.4	1.07 H	162	43.0	13.6
6	11650.00	45.3 AV	54.0	-8.7	1.07 H	162	31.7	13.6
7	#17475.00	51.2 PK	68.2	-17.0	1.20 H	172	32.6	18.6

**ANTENNA POLARITY & TEST DISTANCE: VERTICAL AT 3 M**

NO.	FREQ. (MHz)	EMISSION LEVEL (dBuV/m)	LIMIT (dBuV/m)	MARGIN (dB)	ANTENNA HEIGHT (m)	TABLE ANGLE (Degree)	RAW VALUE (dBuV)	CORRECTION FACTOR (dB/m)
1	#5638.59	54.2 PK	68.2	-14.0	2.74 V	107	51.0	3.2
2	*5825.00	116.8 PK			2.74 V	107	113.0	3.8
3	*5825.00	106.1 AV			2.74 V	107	102.3	3.8
4	#5974.41	54.0 PK	68.2	-14.2	2.74 V	107	50.4	3.6
5	11650.00	61.3 PK	74.0	-12.7	1.55 V	275	47.7	13.6
6	11650.00	49.2 AV	54.0	-4.8	1.55 V	275	35.6	13.6
7	#17475.00	51.5 PK	68.2	-16.7	1.59 V	242	32.9	18.6

**REMARKS:**

1. Emission Level(dBuV/m) = Raw Value(dBuV) + Correction Factor(dB/m)
2. Correction Factor(dB/m) = Antenna Factor(dB/m) + Cable Factor(dB) – Pre-Amplifier Factor(dB)
3. The other emission levels were very low against the limit.
4. Margin value = Emission Level – Limit value
5. " \* ": Fundamental frequency.
6. " # ": The radiated frequency is out of the restricted band.

**802.11ac (VHT40)**

<b>CHANNEL</b>	TX Channel 38	<b>DETECTOR FUNCTION</b>	Peak (PK)
<b>FREQUENCY RANGE</b>	1GHz ~ 40GHz		Average (AV)

**ANTENNA POLARITY & TEST DISTANCE: HORIZONTAL AT 3 M**

NO.	FREQ. (MHz)	EMISSION LEVEL (dBuV/m)	LIMIT (dBuV/m)	MARGIN (dB)	ANTENNA HEIGHT (m)	TABLE ANGLE (Degree)	RAW VALUE (dBuV)	CORRECTION FACTOR (dB/m)
1	5150.00	57.2 PK	74.0	-16.8	1.49 H	170	54.2	3.0
2	5150.00	46.5 AV	54.0	-7.5	1.49 H	170	43.5	3.0
3	*5190.00	97.0 PK			1.49 H	170	94.1	2.9
4	*5190.00	88.5 AV			1.49 H	170	85.6	2.9
5	5350.00	49.0 PK	74.0	-25.0	1.49 H	170	46.2	2.8
6	5350.00	36.0 AV	54.0	-18.0	1.49 H	170	33.2	2.8
7	#10380.00	54.3 PK	68.2	-13.9	1.02 H	176	41.3	13.0
8	15570.00	49.7 PK	74.0	-24.3	1.28 H	152	36.7	13.0
9	15570.00	38.5 AV	54.0	-15.5	1.28 H	152	25.5	13.0

**ANTENNA POLARITY & TEST DISTANCE: VERTICAL AT 3 M**

NO.	FREQ. (MHz)	EMISSION LEVEL (dBuV/m)	LIMIT (dBuV/m)	MARGIN (dB)	ANTENNA HEIGHT (m)	TABLE ANGLE (Degree)	RAW VALUE (dBuV)	CORRECTION FACTOR (dB/m)
1	5150.00	64.9 PK	74.0	-9.1	1.11 V	113	61.9	3.0
2	5150.00	53.8 AV	54.0	-0.2	1.11 V	113	50.8	3.0
3	*5190.00	107.2 PK			1.11 V	113	104.3	2.9
4	*5190.00	98.7 AV			1.11 V	113	95.8	2.9
5	5350.00	49.2 PK	74.0	-24.8	1.11 V	113	46.4	2.8
6	5350.00	36.3 AV	54.0	-17.7	1.11 V	113	33.5	2.8
7	#10380.00	60.4 PK	68.2	-7.8	1.52 V	276	47.4	13.0
8	15570.00	51.0 PK	74.0	-23.0	1.57 V	212	38.0	13.0
9	15570.00	39.4 AV	54.0	-14.6	1.57 V	212	26.4	13.0

**REMARKS:**

- Emission Level(dBuV/m) = Raw Value(dBuV) + Correction Factor(dB/m)
- Correction Factor(dB/m) = Antenna Factor(dB/m) + Cable Factor(dB) – Pre-Amplifier Factor(dB)
- The other emission levels were very low against the limit.
- Margin value = Emission Level – Limit value
- " \* ": Fundamental frequency.
- " # ": The radiated frequency is out of the restricted band.

<b>CHANNEL</b>	TX Channel 46	<b>DETECTOR FUNCTION</b>	Peak (PK)
<b>FREQUENCY RANGE</b>	1GHz ~ 40GHz		Average (AV)

**ANTENNA POLARITY & TEST DISTANCE: HORIZONTAL AT 3 M**

NO.	FREQ. (MHz)	EMISSION LEVEL (dBuV/m)	LIMIT (dBuV/m)	MARGIN (dB)	ANTENNA HEIGHT (m)	TABLE ANGLE (Degree)	RAW VALUE (dBuV)	CORRECTION FACTOR (dB/m)
1	5150.00	50.3 PK	74.0	-23.7	1.47 H	152	47.3	3.0
2	5150.00	37.2 AV	54.0	-16.8	1.47 H	152	34.2	3.0
3	*5230.00	101.2 PK			1.47 H	152	98.6	2.6
4	*5230.00	91.4 AV			1.47 H	152	88.8	2.6
5	5350.00	48.4 PK	74.0	-25.6	1.47 H	152	45.6	2.8
6	5350.00	36.5 AV	54.0	-17.5	1.47 H	152	33.7	2.8
7	#10460.00	56.6 PK	68.2	-11.6	1.12 H	167	43.4	13.2
8	15690.00	51.7 PK	74.0	-22.3	1.30 H	154	39.4	12.3
9	15690.00	40.4 AV	54.0	-13.6	1.30 H	154	28.1	12.3

**ANTENNA POLARITY & TEST DISTANCE: VERTICAL AT 3 M**

NO.	FREQ. (MHz)	EMISSION LEVEL (dBuV/m)	LIMIT (dBuV/m)	MARGIN (dB)	ANTENNA HEIGHT (m)	TABLE ANGLE (Degree)	RAW VALUE (dBuV)	CORRECTION FACTOR (dB/m)
1	5150.00	53.1 PK	74.0	-20.9	1.16 V	109	50.1	3.0
2	5150.00	42.7 AV	54.0	-11.3	1.16 V	109	39.7	3.0
3	*5230.00	111.4 PK			1.16 V	109	108.8	2.6
4	*5230.00	101.5 AV			1.16 V	109	98.9	2.6
5	5350.00	48.7 PK	74.0	-25.3	1.16 V	109	45.9	2.8
6	5350.00	36.8 AV	54.0	-17.2	1.16 V	109	34.0	2.8
7	#10460.00	62.5 PK	68.2	-5.7	1.64 V	289	49.3	13.2
8	15690.00	52.4 PK	74.0	-21.6	1.55 V	233	40.1	12.3
9	15690.00	40.8 AV	54.0	-13.2	1.55 V	233	28.5	12.3

**REMARKS:**

1. Emission Level(dBuV/m) = Raw Value(dBuV) + Correction Factor(dB/m)
2. Correction Factor(dB/m) = Antenna Factor(dB/m) + Cable Factor(dB) – Pre-Amplifier Factor(dB)
3. The other emission levels were very low against the limit.
4. Margin value = Emission Level – Limit value
5. " \* ": Fundamental frequency.
6. " # ": The radiated frequency is out of the restricted band.

<b>CHANNEL</b>	TX Channel 151	<b>DETECTOR FUNCTION</b>	Peak (PK)
<b>FREQUENCY RANGE</b>	1GHz ~ 40GHz		Average (AV)

**ANTENNA POLARITY & TEST DISTANCE: HORIZONTAL AT 3 M**

NO.	FREQ. (MHz)	EMISSION LEVEL (dBuV/m)	LIMIT (dBuV/m)	MARGIN (dB)	ANTENNA HEIGHT (m)	TABLE ANGLE (Degree)	RAW VALUE (dBuV)	CORRECTION FACTOR (dB/m)
1	#5555.46	50.2 PK	68.2	-18.0	1.46 H	156	47.2	3.0
2	*5755.00	103.6 PK			1.46 H	156	100.0	3.6
3	*5755.00	94.0 AV			1.46 H	156	90.4	3.6
4	#5935.66	50.4 PK	68.2	-17.8	1.46 H	156	46.8	3.6
5	11510.00	56.7 PK	74.0	-17.3	1.00 H	178	42.9	13.8
6	11510.00	45.2 AV	54.0	-8.8	1.00 H	178	31.4	13.8
7	#17265.00	51.4 PK	68.2	-16.8	1.25 H	189	34.3	17.1

**ANTENNA POLARITY & TEST DISTANCE: VERTICAL AT 3 M**

NO.	FREQ. (MHz)	EMISSION LEVEL (dBuV/m)	LIMIT (dBuV/m)	MARGIN (dB)	ANTENNA HEIGHT (m)	TABLE ANGLE (Degree)	RAW VALUE (dBuV)	CORRECTION FACTOR (dB/m)
1	#5639.43	52.6 PK	68.2	-15.6	2.73 V	106	49.4	3.2
2	*5755.00	114.1 PK			2.73 V	106	110.5	3.6
3	*5755.00	104.1 AV			2.73 V	106	100.5	3.6
4	#6000.23	50.0 PK	68.2	-18.2	2.73 V	106	46.3	3.7
5	11510.00	62.0 PK	74.0	-12.0	1.48 V	269	48.2	13.8
6	11510.00	49.6 AV	54.0	-4.4	1.48 V	269	35.8	13.8
7	#17265.00	50.6 PK	68.2	-17.6	1.52 V	227	33.5	17.1

**REMARKS:**

1. Emission Level(dBuV/m) = Raw Value(dBuV) + Correction Factor(dB/m)
2. Correction Factor(dB/m) = Antenna Factor(dB/m) + Cable Factor(dB) – Pre-Amplifier Factor(dB)
3. The other emission levels were very low against the limit.
4. Margin value = Emission Level – Limit value
5. " \* ": Fundamental frequency.
6. " # ": The radiated frequency is out of the restricted band.

<b>CHANNEL</b>	TX Channel 159	<b>DETECTOR FUNCTION</b>	Peak (PK)
<b>FREQUENCY RANGE</b>	1GHz ~ 40GHz		Average (AV)

**ANTENNA POLARITY & TEST DISTANCE: HORIZONTAL AT 3 M**

NO.	FREQ. (MHz)	EMISSION LEVEL (dBuV/m)	LIMIT (dBuV/m)	MARGIN (dB)	ANTENNA HEIGHT (m)	TABLE ANGLE (Degree)	RAW VALUE (dBuV)	CORRECTION FACTOR (dB/m)
1	#5646.72	50.4 PK	68.2	-17.8	1.49 H	151	47.2	3.2
2	*5795.00	103.8 PK			1.49 H	151	100.2	3.6
3	*5795.00	94.2 AV			1.49 H	151	90.6	3.6
4	#5970.41	49.7 PK	68.2	-18.5	1.49 H	151	46.1	3.6
5	11590.00	56.7 PK	74.0	-17.3	1.08 H	158	43.1	13.6
6	11590.00	45.2 AV	54.0	-8.8	1.08 H	158	31.6	13.6
7	#17385.00	51.0 PK	68.2	-17.2	1.23 H	180	33.1	17.9

**ANTENNA POLARITY & TEST DISTANCE: VERTICAL AT 3 M**

NO.	FREQ. (MHz)	EMISSION LEVEL (dBuV/m)	LIMIT (dBuV/m)	MARGIN (dB)	ANTENNA HEIGHT (m)	TABLE ANGLE (Degree)	RAW VALUE (dBuV)	CORRECTION FACTOR (dB/m)
1	#5567.74	55.3 PK	68.2	-12.9	2.69 V	109	52.1	3.2
2	*5795.00	113.9 PK			2.69 V	109	110.3	3.6
3	*5795.00	103.8 AV			2.69 V	109	100.2	3.6
4	#5980.09	54.7 PK	68.2	-13.5	2.69 V	109	51.0	3.7
5	11590.00	62.3 PK	74.0	-11.7	1.48 V	275	48.7	13.6
6	11590.00	50.0 AV	54.0	-4.0	1.48 V	275	36.4	13.6
7	#17385.00	51.3 PK	68.2	-16.9	1.62 V	242	33.4	17.9

**REMARKS:**

1. Emission Level(dBuV/m) = Raw Value(dBuV) + Correction Factor(dB/m)
2. Correction Factor(dB/m) = Antenna Factor(dB/m) + Cable Factor(dB) – Pre-Amplifier Factor(dB)
3. The other emission levels were very low against the limit.
4. Margin value = Emission Level – Limit value
5. " \* ": Fundamental frequency.
6. " # ": The radiated frequency is out of the restricted band.

**802.11ac (VHT80)**

<b>CHANNEL</b>	TX Channel 42	<b>DETECTOR FUNCTION</b>	Peak (PK)
<b>FREQUENCY RANGE</b>	1GHz ~ 40GHz		Average (AV)

**ANTENNA POLARITY & TEST DISTANCE: HORIZONTAL AT 3 M**

NO.	FREQ. (MHz)	EMISSION LEVEL (dBuV/m)	LIMIT (dBuV/m)	MARGIN (dB)	ANTENNA HEIGHT (m)	TABLE ANGLE (Degree)	RAW VALUE (dBuV)	CORRECTION FACTOR (dB/m)
1	5150.00	57.0 PK	74.0	-17.0	1.51 H	141	54.0	3.0
2	5150.00	45.8 AV	54.0	-8.2	1.51 H	141	42.8	3.0
3	*5210.00	91.5 PK			1.51 H	141	88.7	2.8
4	*5210.00	82.4 AV			1.51 H	141	79.6	2.8
5	5350.00	47.5 PK	74.0	-26.5	1.51 H	141	44.7	2.8
6	5350.00	35.3 AV	54.0	-18.7	1.51 H	141	32.5	2.8
7	#10420.00	54.5 PK	68.2	-13.7	1.07 H	166	41.4	13.1
8	15630.00	49.6 PK	74.0	-24.4	1.30 H	148	36.8	12.8
9	15630.00	38.4 AV	54.0	-15.6	1.30 H	148	25.6	12.8

**ANTENNA POLARITY & TEST DISTANCE: VERTICAL AT 3 M**

NO.	FREQ. (MHz)	EMISSION LEVEL (dBuV/m)	LIMIT (dBuV/m)	MARGIN (dB)	ANTENNA HEIGHT (m)	TABLE ANGLE (Degree)	RAW VALUE (dBuV)	CORRECTION FACTOR (dB/m)
1	5150.00	64.6 PK	74.0	-9.4	2.70 V	165	61.6	3.0
2	5150.00	53.8 AV	54.0	-0.2	2.70 V	165	50.8	3.0
3	*5210.00	100.3 PK			2.70 V	165	97.5	2.8
4	*5210.00	91.7 AV			2.70 V	165	88.9	2.8
5	5350.00	50.2 PK	74.0	-23.8	2.70 V	165	47.4	2.8
6	5350.00	38.8 AV	54.0	-15.2	2.70 V	165	36.0	2.8
7	#10420.00	60.0 PK	68.2	-8.2	1.56 V	281	46.9	13.1
8	15630.00	50.6 PK	74.0	-23.4	1.53 V	211	37.8	12.8
9	15630.00	39.1 AV	54.0	-14.9	1.53 V	211	26.3	12.8

**REMARKS:**

- Emission Level(dBuV/m) = Raw Value(dBuV) + Correction Factor(dB/m)
- Correction Factor(dB/m) = Antenna Factor(dB/m) + Cable Factor(dB) – Pre-Amplifier Factor(dB)
- The other emission levels were very low against the limit.
- Margin value = Emission Level – Limit value
- " \* ": Fundamental frequency.
- " # ": The radiated frequency is out of the restricted band.

<b>CHANNEL</b>	TX Channel 155	<b>DETECTOR FUNCTION</b>	Peak (PK)
<b>FREQUENCY RANGE</b>	1GHz ~ 40GHz		Average (AV)

**ANTENNA POLARITY & TEST DISTANCE: HORIZONTAL AT 3 M**

NO.	FREQ. (MHz)	EMISSION LEVEL (dBuV/m)	LIMIT (dBuV/m)	MARGIN (dB)	ANTENNA HEIGHT (m)	TABLE ANGLE (Degree)	RAW VALUE (dBuV)	CORRECTION FACTOR (dB/m)
1	#5648.74	56.1 PK	68.2	-12.1	1.61 H	156	52.9	3.2
2	*5775.00	100.0 PK			1.61 H	156	96.4	3.6
3	*5775.00	90.2 AV			1.61 H	156	86.6	3.6
4	#5940.41	50.3 PK	68.2	-17.9	1.61 H	156	46.8	3.5
5	11550.00	56.1 PK	74.0	-17.9	1.07 H	161	42.5	13.6
6	11550.00	45.0 AV	54.0	-9.0	1.07 H	161	31.4	13.6
7	#17325.00	50.6 PK	68.2	-17.6	1.24 H	186	33.2	17.4

**ANTENNA POLARITY & TEST DISTANCE: VERTICAL AT 3 M**

NO.	FREQ. (MHz)	EMISSION LEVEL (dBuV/m)	LIMIT (dBuV/m)	MARGIN (dB)	ANTENNA HEIGHT (m)	TABLE ANGLE (Degree)	RAW VALUE (dBuV)	CORRECTION FACTOR (dB/m)
1	#5639.79	68.1 PK	68.2	-0.1	2.71 V	107	64.9	3.2
2	*5775.00	110.3 PK			2.71 V	107	106.7	3.6
3	*5775.00	99.8 AV			2.71 V	107	96.2	3.6
4	#5924.64	55.2 PK	68.5	-13.3	2.71 V	107	51.6	3.6
5	11550.00	60.3 PK	74.0	-13.7	1.53 V	279	46.7	13.6
6	11550.00	48.1 AV	54.0	-5.9	1.53 V	279	34.5	13.6
7	#17325.00	49.9 PK	68.2	-18.3	1.53 V	219	32.5	17.4

**REMARKS:**

1. Emission Level(dBuV/m) = Raw Value(dBuV) + Correction Factor(dB/m)
2. Correction Factor(dB/m) = Antenna Factor(dB/m) + Cable Factor(dB) – Pre-Amplifier Factor(dB)
3. The other emission levels were very low against the limit.
4. Margin value = Emission Level – Limit value
5. " \* ": Fundamental frequency.
6. " # ": The radiated frequency is out of the restricted band.



Below 1GHz Data:

802.11a

<b>CHANNEL</b>	TX Channel 149	<b>DETECTOR FUNCTION</b>	Quasi-Peak (QP)
<b>FREQUENCY RANGE</b>	9kHz ~ 1GHz		

ANTENNA POLARITY & TEST DISTANCE: HORIZONTAL AT 3 M								
NO.	FREQ. (MHz)	EMISSION LEVEL (dBuV/m)	LIMIT (dBuV/m)	MARGIN (dB)	ANTENNA HEIGHT (m)	TABLE ANGLE (Degree)	RAW VALUE (dBuV)	CORRECTION FACTOR (dB/m)
1	31.99	24.6 QP	40.0	-15.4	1.00 H	42	34.2	-9.6
2	125.01	29.4 QP	43.5	-14.1	1.50 H	80	38.8	-9.4
3	250.02	30.3 QP	46.0	-15.7	1.00 H	348	39.0	-8.7
4	500.01	29.6 QP	46.0	-16.4	2.00 H	279	31.5	-1.9
5	670.76	32.2 QP	46.0	-13.8	2.00 H	201	30.8	1.4
6	875.02	36.1 QP	46.0	-9.9	1.50 H	3	30.8	5.3

REMARKS:

1. Emission Level(dBuV/m) = Raw Value(dBuV) + Correction Factor(dB/m)
2. Correction Factor(dB/m) = Antenna Factor(dB/m) + Cable Factor(dB) – Pre-Amplifier Factor(dB)
3. Margin value = Emission Level – Limit value
4. The emission levels were very low against the limit of frequency range 9kHz~30MHz: the amplitude of spurious emissions attenuated more than 20 dB below the permissible value to be report.

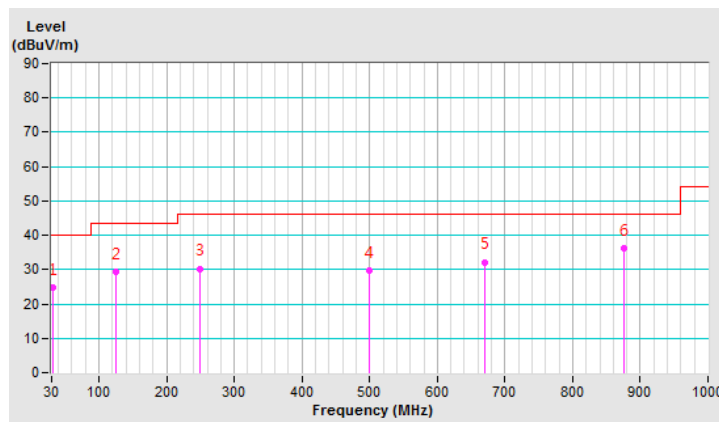

<b>CHANNEL</b>	TX Channel 149	<b>DETECTOR FUNCTION</b>	Quasi-Peak (QP)
<b>FREQUENCY RANGE</b>	9kHz ~ 1GHz		

**ANTENNA POLARITY & TEST DISTANCE: VERTICAL AT 3 M**

NO.	FREQ. (MHz)	EMISSION LEVEL (dBuV/m)	LIMIT (dBuV/m)	MARGIN (dB)	ANTENNA HEIGHT (m)	TABLE ANGLE (Degree)	RAW VALUE (dBuV)	CORRECTION FACTOR (dB/m)
1	33.27	32.3 QP	40.0	-7.7	1.00 V	159	41.8	-9.5
2	68.29	30.4 QP	40.0	-9.6	1.00 V	1	40.5	-10.1
3	250.00	27.2 QP	46.0	-18.8	1.00 V	175	35.9	-8.7
4	500.01	33.2 QP	46.0	-12.8	1.00 V	167	35.1	-1.9
5	771.25	32.9 QP	46.0	-13.1	1.00 V	360	29.2	3.7
6	875.02	35.7 QP	46.0	-10.3	1.00 V	1	30.4	5.3

**REMARKS:**

1. Emission Level(dBuV/m) = Raw Value(dBuV) + Correction Factor(dB/m)
2. Correction Factor(dB/m) = Antenna Factor(dB/m) + Cable Factor(dB) – Pre-Amplifier Factor(dB)
3. Margin value = Emission Level – Limit value
4. The emission levels were very low against the limit of frequency range 9kHz~30MHz: the amplitude of spurious emissions attenuated more than 20 dB below the permissible value to be report.

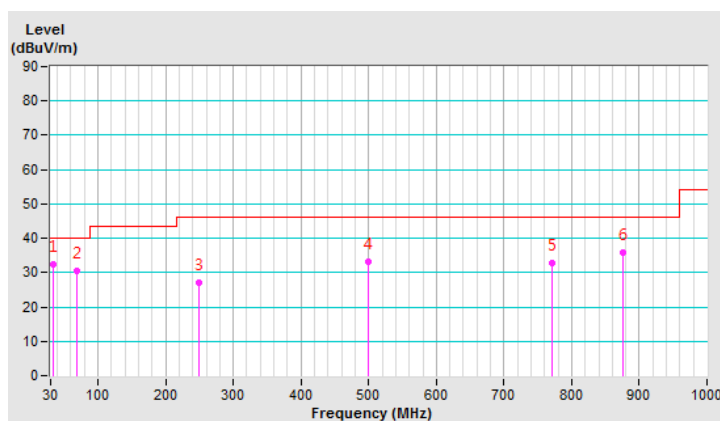

## 4.2 Conducted Emission Measurement

### 4.2.1 Limits of Conducted Emission Measurement

Frequency (MHz)	Conducted Limit (dBuV)	
	Quasi-peak	Average
0.15 - 0.5	66 - 56	56 - 46
0.50 - 5.0	56	46
5.0 - 30.0	60	50

Note: 1. The lower limit shall apply at the transition frequencies.

2. The limit decreases in line with the logarithm of the frequency in the range of 0.15 to 0.50MHz.

### 4.2.2 Test Instruments

DESCRIPTION & MANUFACTURER	MODEL NO.	SERIAL NO.	CALIBRATED DATE	CALIBRATED UNTIL
Test Receiver R&S	ESCS 30	847124/029	Oct. 24, 2018	Oct. 23, 2019
Line-Impedance Stabilization Network (for EUT) R&S	ESH3-Z5	848773/004	Oct. 22, 2018	Oct. 21, 2019
Line-Impedance Stabilization Network (for Peripheral) R&S	ENV216	100072	June 04, 2018	June 03, 2019
50 ohms Terminator	N/A	3	Oct. 22, 2018	Oct. 21, 2019
RF Cable	5D-FB	COCCAB-001	Sep. 28, 2018	Sep. 27, 2019
Fixed attenuator EMCI	STI02-2200-10	003	Mar. 16, 2018	Mar. 15, 2019
Software BVADT	BVADT_Cond_ V7.3.7.4	NA	NA	NA

**Note:**

1. The calibration interval of the above test instruments are 12 months and the calibrations are traceable to NML/ROC and NIST/USA.
2. The test was performed in Conduction 1.
- 3 Tested Date: Dec. 12, 2018

#### 4.2.3 Test Procedure

- The EUT was placed 0.4 meters from the conducting wall of the shielded room with EUT being connected to the power mains through a line impedance stabilization network (LISN). Other support units were connected to the power mains through another LISN. The two LISNs provide 50 ohm/ 50uH of coupling impedance for the measuring instrument.
- Both lines of the power mains connected to the EUT were checked for maximum conducted interference.
- The frequency range from 150kHz to 30MHz was searched. Emission levels under (Limit - 20dB) was not recorded.

**NOTE:** All modes of operation were investigated and the worst-case emissions are reported.

#### 4.2.4 Deviation from Test Standard

No deviation.

#### 4.2.5 Test Setup

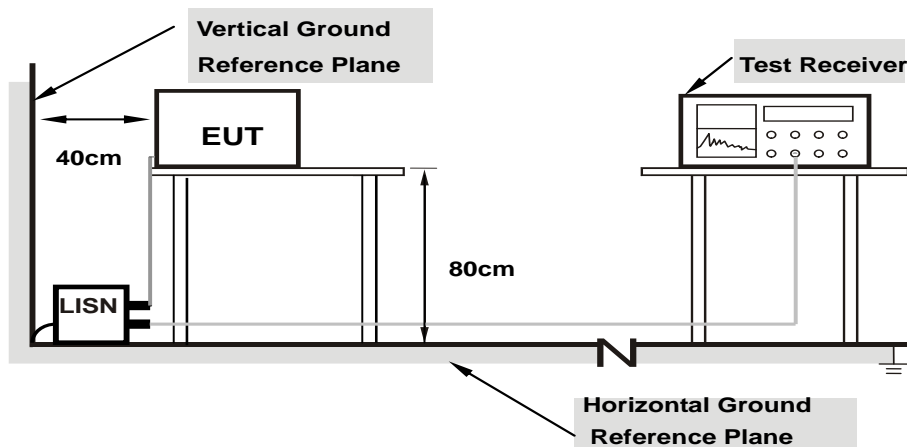

**Note: 1.Support units were connected to second LISN.**

For the actual test configuration, please refer to the attached file (Test Setup Photo).

#### 4.2.6 EUT Operating Condition

Same as 4.1.6.

#### 4.2.7 Test Results

Phase	Line (L)	Detector Function	Quasi-Peak (QP) / Average (AV)
-------	----------	-------------------	--------------------------------

No	Freq. [MHz]	Corr.	Reading Value		Emission Level		Limit		Margin	
		Factor (dB)	[dB (uV)]		[dB (uV)]		[dB (uV)]		(dB)	
		Q.P.	AV.	Q.P.	AV.	Q.P.	AV.	Q.P.	AV.	
1	0.15391	10.03	35.83	21.14	45.86	31.17	65.79	55.79	-19.93	-24.62
2	0.20859	10.05	29.40	12.80	39.45	22.85	63.26	53.26	-23.81	-30.41
3	0.38438	10.08	34.90	27.20	44.98	37.28	58.18	48.18	-13.20	-10.90
4	2.58984	10.23	27.46	18.21	37.69	28.44	56.00	46.00	-18.31	-17.56
5	11.32422	10.79	26.31	19.70	37.10	30.49	60.00	50.00	-22.90	-19.51
6	20.90625	11.38	33.85	26.10	45.23	37.48	60.00	50.00	-14.77	-12.52

#### REMARKS:

1. Q.P. and AV. are abbreviations of quasi-peak and average individually.
2. The emission levels of other frequencies were very low against the limit.
3. Margin value = Emission level - Limit value
4. Correction factor = Insertion loss + Cable loss
5. Emission Level = Correction Factor + Reading Value.

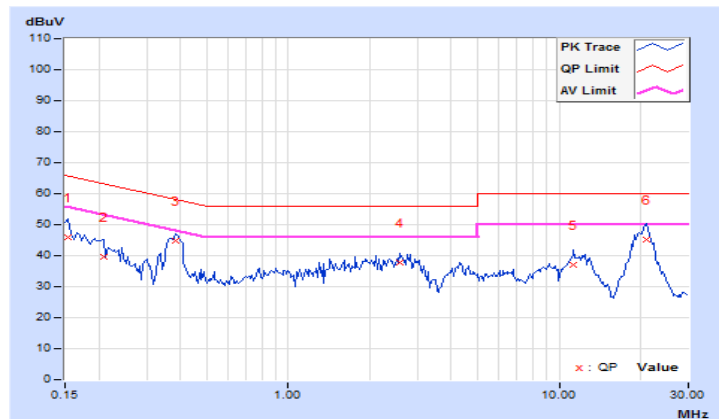

Phase	Neutral (N)	Detector Function	Quasi-Peak (QP) / Average (AV)
-------	-------------	-------------------	--------------------------------

No	Freq.	Corr.	Reading Value		Emission Level		Limit		Margin	
	[MHz]	Factor	[dB (uV)]		[dB (uV)]		[dB (uV)]		(dB)	
		(dB)	Q.P.	AV.	Q.P.	AV.	Q.P.	AV.	Q.P.	AV.
1	0.15000	9.94	37.81	20.49	47.75	30.43	66.00	56.00	-18.25	-25.57
2	0.22422	9.95	32.81	22.59	42.76	32.54	62.66	52.66	-19.90	-20.12
<b>3</b>	<b>0.36875</b>	<b>9.98</b>	<b>38.61</b>	<b>28.46</b>	<b>48.59</b>	<b>38.44</b>	<b>58.53</b>	<b>48.53</b>	<b>-9.94</b>	<b>-10.09</b>
4	2.75781	10.11	28.07	15.03	38.18	25.14	56.00	46.00	-17.82	-20.86
5	11.22266	10.60	24.66	17.10	35.26	27.70	60.00	50.00	-24.74	-22.30
6	21.10156	11.16	33.48	26.01	44.64	37.17	60.00	50.00	-15.36	-12.83

#### REMARKS:

1. Q.P. and AV. are abbreviations of quasi-peak and average individually.
2. The emission levels of other frequencies were very low against the limit.
3. Margin value = Emission level - Limit value
4. Correction factor = Insertion loss + Cable loss
5. Emission Level = Correction Factor + Reading Value.

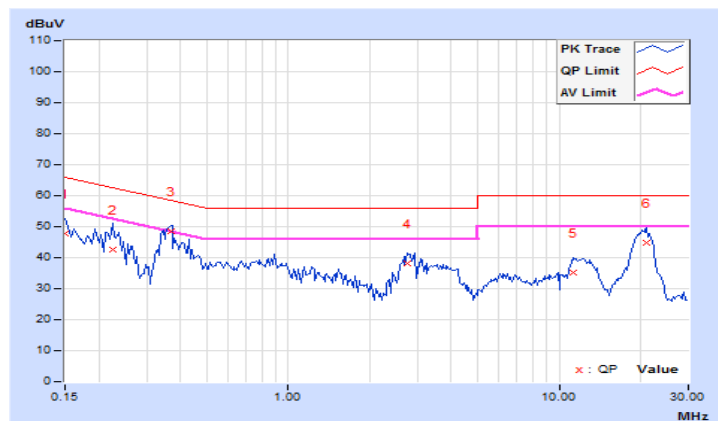

### 4.3 Transmit Power Measurement

#### 4.3.1 Limits of Transmit Power Measurement

Operation Band	EUT Category		Limit
U-NII-1		Outdoor Access Point	1 Watt (30 dBm) (Max. e.i.r.p $\leq$ 125mW(21 dBm) at any elevation angle above 30 degrees as measured from the horizon)
		Fixed point-to-point Access Point	1 Watt (30 dBm)
	√	Indoor Access Point	1 Watt (30 dBm)
		Client device	250mW (24 dBm)
U-NII-2A			250mW (24 dBm) or 11 dBm+10 log B*
U-NII-2C			250mW (24 dBm) or 11 dBm+10 log B*
U-NII-3		√	1 Watt (30 dBm)

\*B is the 26 dB emission bandwidth in megahertz

Per KDB 662911 Method of conducted output power measurement on IEEE 802.11 devices,

Array Gain = 0 dB (i.e., no array gain) for  $N_{ANT} \leq 4$ ;

Array Gain = 0 dB (i.e., no array gain) for channel widths  $\geq$  40 MHz for any  $N_{ANT}$ ;

Array Gain =  $5 \log(N_{ANT}/N_{SS})$  dB or 3 dB, whichever is less for 20-MHz channel widths with  $N_{ANT} \geq 5$ .

For power measurements on all other devices: Array Gain =  $10 \log(N_{ANT}/N_{SS})$  dB.

#### 4.3.2 Test Setup

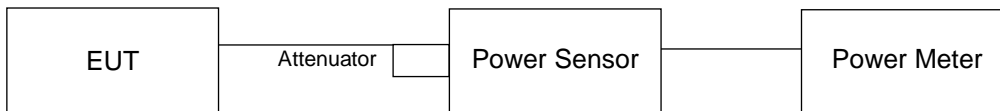

#### 4.3.3 Test Instruments

Refer to section 4.1.2 to get information of above instrument.

#### 4.3.4 Test Procedure

Method PM is used to perform output power measurement, trigger and gating function of wide band power meter is enabled to measure max output power of TX on burst. Duty factor is not added to measured value.

#### 4.3.5 Deviation from Test Standard

No deviation.

#### 4.3.6 EUT Operating Condition

The software provided by client to enable the EUT under transmission condition continuously at lowest, middle and highest channel frequencies individually.

#### 4.3.7 Test Result

#### CDD Mode

#### 802.11a

Chan.	Chan. Freq. (MHz)	Maximum Conducted Power (dBm)		Total Power (mW)	Total Power (dBm)	Limit (dBm)	Pass / Fail
		Chain 0	Chain 1				
36	5180	12.73	10.12	29.03	14.63	30.00	Pass
40	5200	12.71	10.35	29.503	14.70	30.00	Pass
48	5240	12.33	10.82	29.178	14.65	30.00	Pass
149	5745	17.74	19.04	139.597	21.45	30.00	Pass
157	5785	17.51	18.57	128.309	21.08	30.00	Pass
165	5825	17.53	19.13	138.47	21.41	30.00	Pass

#### 802.11ac (VHT20)

Chan.	Chan. Freq. (MHz)	Maximum Conducted Power (dBm)		Total Power (mW)	Total Power (dBm)	Limit (dBm)	Pass / Fail
		Chain 0	Chain 1				
36	5180	12.74	10.25	29.386	14.68	30.00	Pass
40	5200	12.63	10.51	29.569	14.71	30.00	Pass
48	5240	12.26	10.90	29.13	14.64	30.00	Pass
149	5745	17.76	18.92	137.687	21.39	30.00	Pass
157	5785	17.41	18.44	124.904	20.97	30.00	Pass
165	5825	17.54	19.02	136.553	21.35	30.00	Pass

#### 802.11ac (VHT40)

Chan.	Chan. Freq. (MHz)	Maximum Conducted Power (dBm)		Total Power (mW)	Total Power (dBm)	Limit (dBm)	Pass / Fail
		Chain 0	Chain 1				
38	5190	15.37	13.06	54.665	17.38	30.00	Pass
46	5230	15.51	13.87	59.941	17.78	30.00	Pass
151	5755	17.51	18.63	129.31	21.12	30.00	Pass
159	5795	17.61	19.08	138.587	21.42	30.00	Pass

#### 802.11ac (VHT80)

Chan.	Chan. Freq. (MHz)	Maximum Conducted Power (dBm)		Total Power (mW)	Total Power (dBm)	Limit (dBm)	Pass / Fail
		Chain 0	Chain 1				
42	5210	11.53	9.75	23.664	13.74	30.00	Pass
155	5775	15.76	16.37	81.021	19.09	30.00	Pass



## Beamforming Mode

### 802.11ac (VHT20)

Chan.	Chan. Freq. (MHz)	Maximum Conducted Power (dBm)		Total Power (mW)	Total Power (dBm)	Limit (dBm)	Pass / Fail
		Chain 0	Chain 1				
36	5180	12.06	9.80	25.619	14.09	27.99	Pass
40	5200	11.96	10.02	25.75	14.11	27.99	Pass
48	5240	11.67	10.42	25.704	14.10	27.99	Pass
149	5745	17.76	18.92	137.687	21.39	27.99	Pass
157	5785	17.41	18.44	124.904	20.97	27.99	Pass
165	5825	17.54	19.02	136.553	21.35	27.99	Pass

**Note:** 1. Directional gain =  $5\text{dBi} + 10\log(2) = 8.01\text{dBi} > 6\text{dBi}$ , so the power limit shall be reduced to  $30 - (8.01 - 6) = 27.99\text{dBm}$

### 802.11ac (VHT40)

Chan.	Chan. Freq. (MHz)	Maximum Conducted Power (dBm)		Total Power (mW)	Total Power (dBm)	Limit (dBm)	Pass / Fail
		Chain 0	Chain 1				
38	5190	12.88	10.42	30.424	14.83	27.99	Pass
46	5230	12.62	10.97	30.784	14.88	27.99	Pass
151	5755	17.51	18.63	129.31	21.12	27.99	Pass
159	5795	17.61	19.08	138.587	21.42	27.99	Pass

**Note:** 1. Directional gain =  $5\text{dBi} + 10\log(2) = 8.01\text{dBi} > 6\text{dBi}$ , so the power limit shall be reduced to  $30 - (8.01 - 6) = 27.99\text{dBm}$

### 802.11ac (VHT80)

Chan.	Chan. Freq. (MHz)	Maximum Conducted Power (dBm)		Total Power (mW)	Total Power (dBm)	Limit (dBm)	Pass / Fail
		Chain 0	Chain 1				
42	5210	11.53	9.75	23.664	13.74	27.99	Pass
155	5775	15.76	16.37	81.021	19.09	27.99	Pass

**Note:** 1. Directional gain =  $5\text{dBi} + 10\log(2) = 8.01\text{dBi} > 6\text{dBi}$ , so the power limit shall be reduced to  $30 - (8.01 - 6) = 27.99\text{dBm}$

## 4.4 Occupied Bandwidth Measurement

### 4.4.1 Test Setup

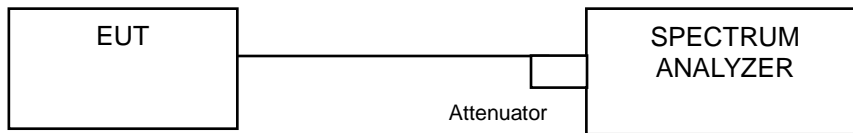

### 4.4.2 Test Instruments

Refer to section 4.1.2 to get information of above instrument.

### 4.4.3 Test Procedure

The transmitter output was connected to the spectrum analyzer through an attenuator. The bandwidth of the fundamental frequency was measured by spectrum analyzer with resolution bandwidth in the range of 1% to 5% of the anticipated emission bandwidth, and a video bandwidth at least 3x the resolution bandwidth and set the detector to SAMPLE. The width of a frequency band such that, below the lower and above the upper frequency limits, the mean powers emitted are each equal to a specified percentage 0.5 %of the total mean power of a given emission.

#### 4.4.4 Test Results

##### 802.11a

Channel	Channel Frequency (MHz)	Occupied Bandwidth (MHz)	
		Chain 0	Chain 1
36	5180	16.44	16.56
40	5200	16.56	16.44
48	5240	16.44	16.44
149	5745	21.24	18.00
157	5785	19.92	17.16
165	5825	22.44	19.20

##### 802.11ac (VHT20)

Channel	Channel Frequency (MHz)	Occupied Bandwidth (MHz)	
		Chain 0	Chain 1
36	5180	17.64	17.64
40	5200	17.64	17.64
48	5240	17.64	17.64
149	5745	22.32	18.48
157	5785	20.64	18.00
165	5825	22.80	19.80

##### 802.11ac (VHT40)

Channel	Channel Frequency (MHz)	Occupied Bandwidth (MHz)	
		Chain 0	Chain 1
38	5190	36.24	36.48
46	5230	36.24	36.48
151	5755	40.80	37.20
159	5795	42.96	37.20

##### 802.11ac (VHT80)

Channel	Channel Frequency (MHz)	Occupied Bandwidth (MHz)	
		Chain 0	Chain 1
42	5210	76.32	75.84
155	5775	75.84	76.32

### Spectrum Plot of Max Value

**802.11a / Chain 0 : CH165**

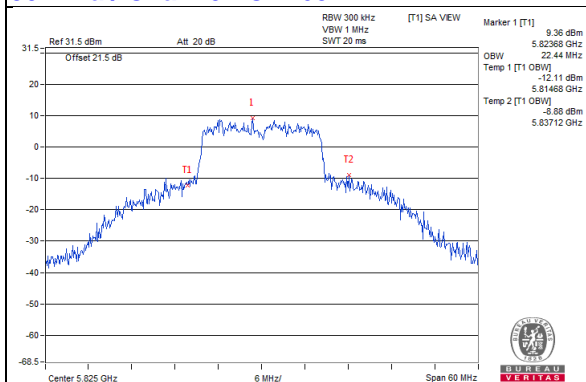

**802.11a (VHT20) / Chain 0: CH165**

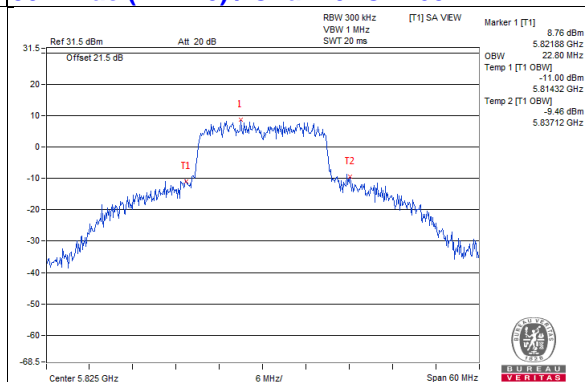

**802.11ac (VHT40) / Chain 0: CH159**

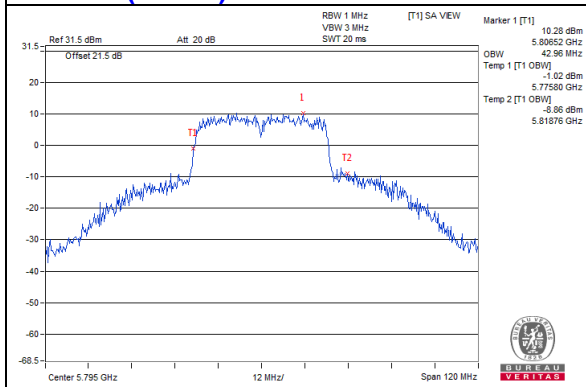

**802.11ac (VHT80) / Chain 0 : CH42**

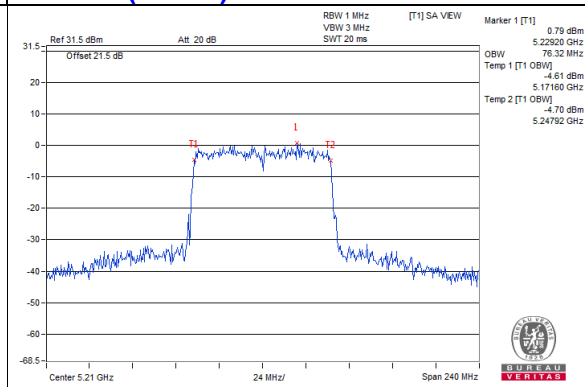

### Spectrum Plot for near by DFS band (DFS is required, if 99% OCP straddle into U-NII-2A band)

**802.11a\_Chain0 / CH48**

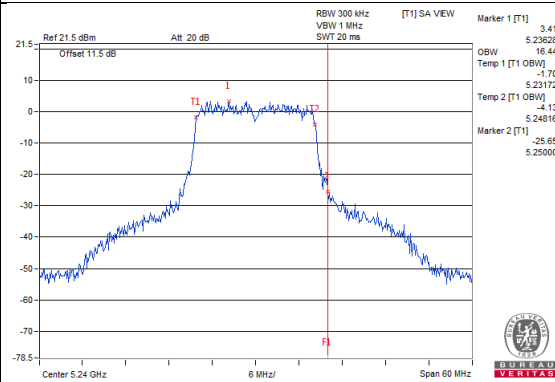

**802.11a\_Chain1 / CH48**

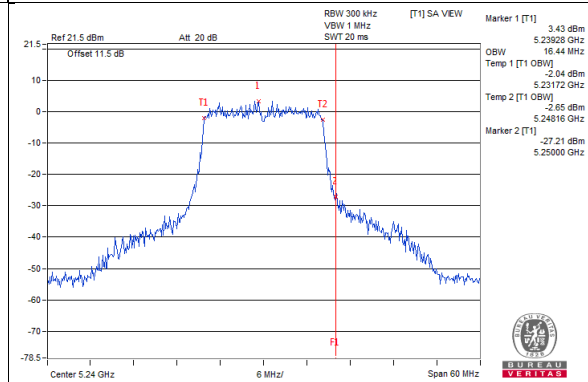

**802.11ac(VHT20)\_Chain0 / CH48**

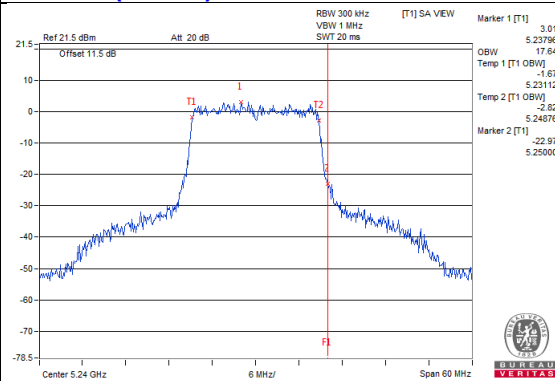

**802.11ac(VHT20)\_Chain1 / CH48**

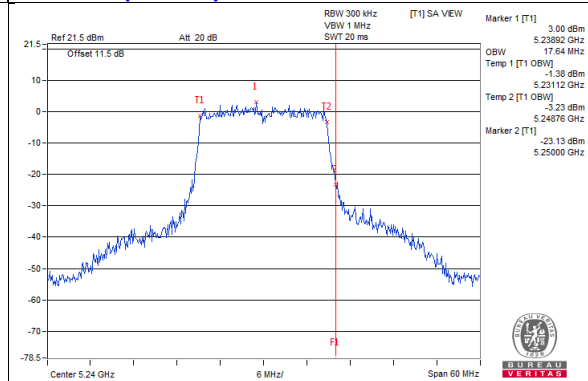

**802.11ac(VHT40)\_Chain0 / CH46**

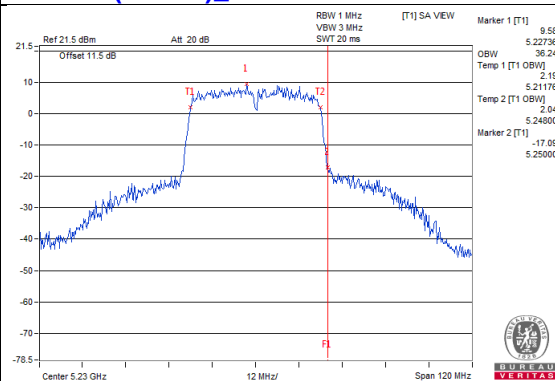

**802.11ac(VHT40)\_Chain1 / CH46**

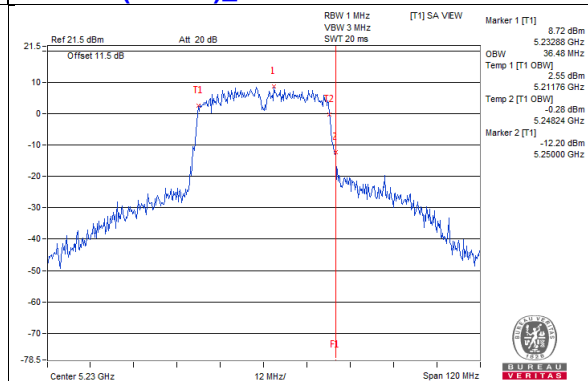

**802.11ac(VHT80)\_Chain0 / CH42**

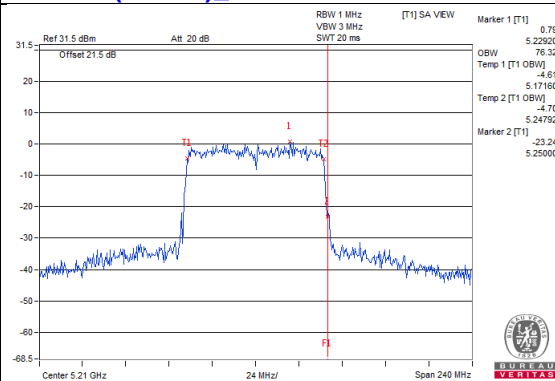

**802.11ac(VHT80)\_Chain1 / CH42**

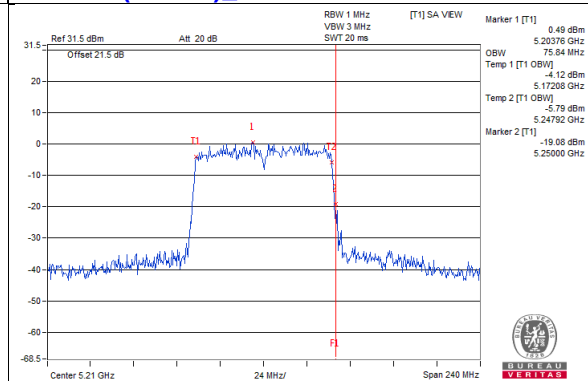

### Spectrum Plot for near by DFS band (DFS is required, if 99% OCP straddle into U-NII-2C band)

**802.11a\_Chain0 / CH149**

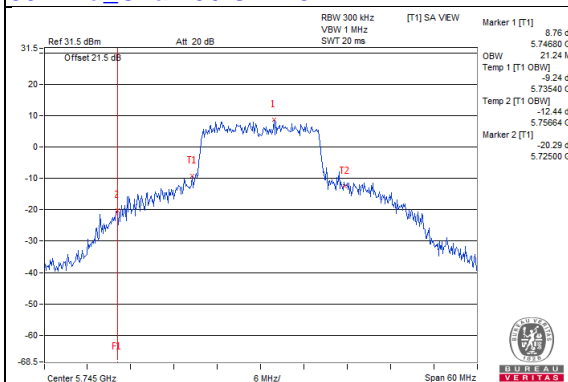

**802.11a\_Chain1 / CH149**

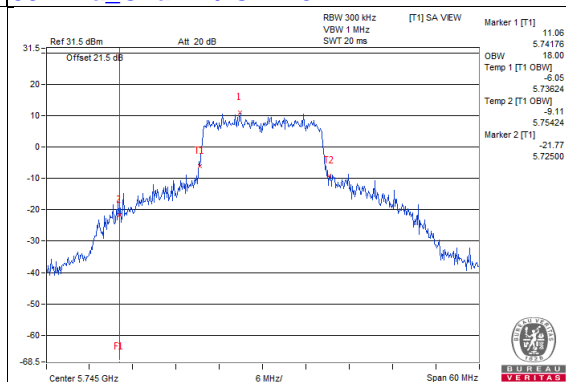

**802.11ac(VHT20)\_Chain0 / CH149**

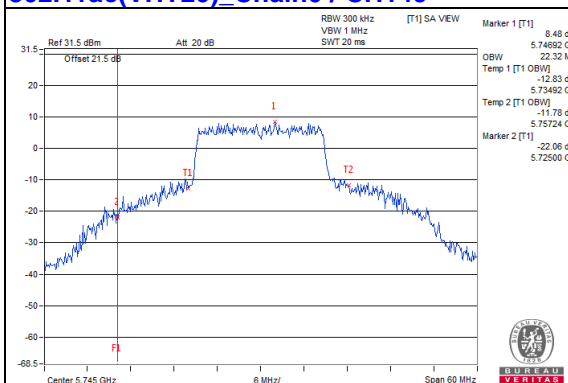

**802.11ac(VHT20)\_Chain1 / CH149**

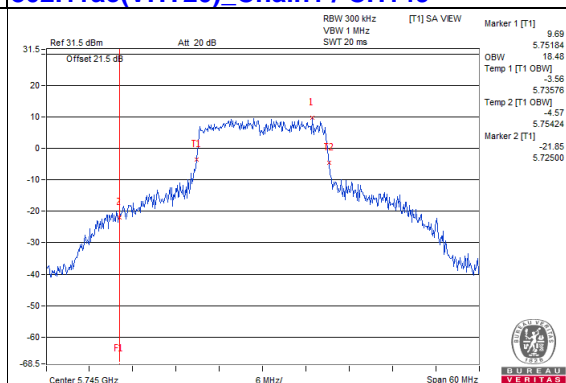

**802.11ac(VHT40)\_Chain0 / CH151**

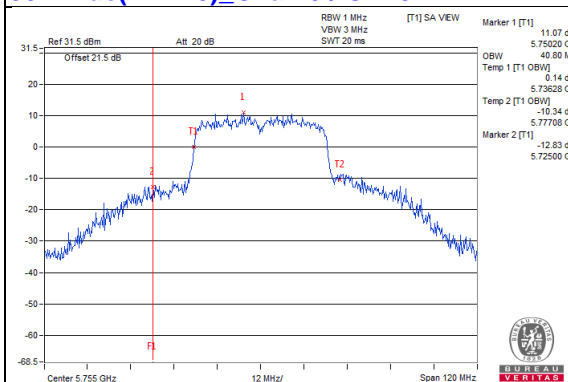

**802.11ac(VHT40)\_Chain1 / CH151**

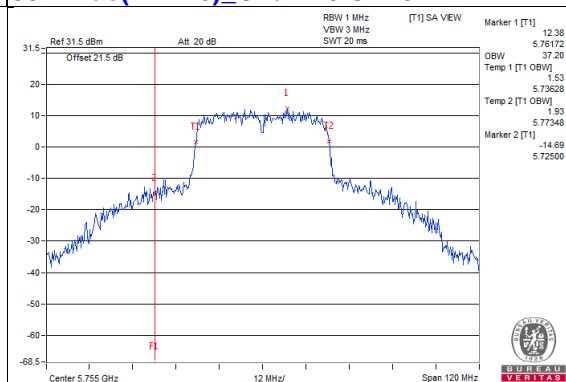

**802.11ac(VHT80)\_Chain0 / CH155**

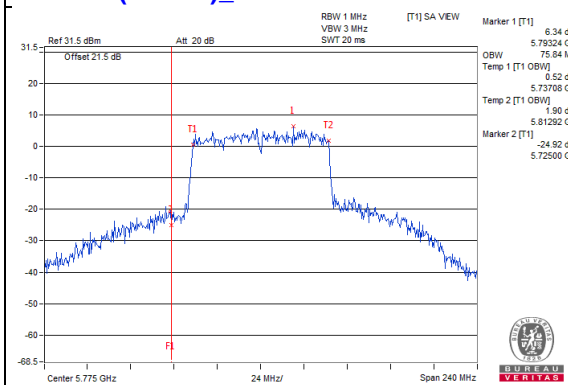

**802.11ac(VHT80)\_Chain1 / CH155**

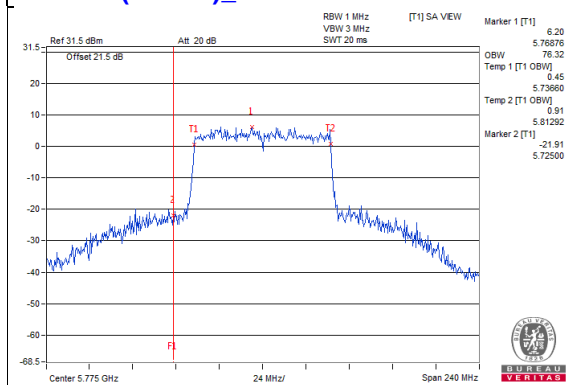

## 4.5 Peak Power Spectral Density Measurement

### 4.5.1 Limits of Peak Power Spectral Density Measurement

Operation Band	EUT Category		Limit
U-NII-1		Outdoor Access Point	17dBm/ MHz
		Fixed point-to-point Access Point	
	√	Indoor Access Point	
		Client device	11dBm/ MHz
U-NII-2A			11dBm/ MHz
U-NII-2C			11dBm/ MHz
U-NII-3	√		30dBm/ 500kHz

### 4.5.2 Test Setup

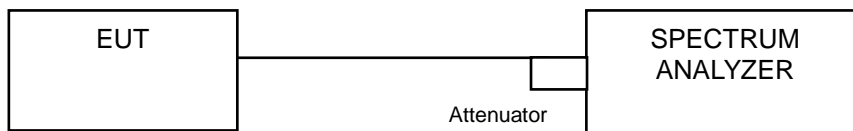

### 4.5.3 Test Instruments

Refer to section 4.1.2 to get information of above instrument.

#### 4.5.4 Test Procedure

##### **802.11ac (VHT20)**

###### **For U-NII-1:**

Using method SA-1

1. Set span to encompass the entire emission bandwidth (EBW) of the signal.
2. Set RBW = 1 MHz, Set VBW  $\geq$  3 MHz, Detector = RMS
3. Sweep time = auto, trigger set to "free run".
4. Trace average at least 100 traces in power averaging mode.
5. Record the max value

###### **For U-NII-3:**

1. Set span to encompass the entire emission bandwidth (EBW) of the signal.
2. Set RBW = 300 kHz, Set VBW  $\geq$  1 MHz, Detector = RMS
3. Use the peak marker function to determine the maximum power level in any 300 kHz band segment within the fundamental EBW.
4. Scale the observed power level to an equivalent value in 500 kHz by adjusting (reducing) the measured power by a bandwidth correction factor (BWCF) where  $BWCF = 10\log(500 \text{ kHz}/300\text{kHz})$
5. Sweep time = auto, trigger set to "free run".
6. Trace average at least 100 traces in power averaging mode.
7. Record the max value

##### **802.11a, 802.11ac (VHT40), 802.11ac (VHT80)**

###### **For U-NII-1:**

Using method SA-2

1. Set span to encompass the entire emission bandwidth (EBW) of the signal.
2. Set RBW = 1 MHz, Set VBW  $\geq$  3 MHz, Detector = RMS
3. Sweep time = auto, trigger set to "free run".
4. Trace average at least 100 traces in power averaging mode.
5. Record the max value and add  $10 \log (1/\text{duty cycle})$

###### **For U-NII-3:**

1. Set span to encompass the entire emission bandwidth (EBW) of the signal.
2. Set RBW = 300 kHz, Set VBW  $\geq$  1 MHz, Detector = RMS
3. Use the peak marker function to determine the maximum power level in any 300 kHz band segment within the fundamental EBW.
4. Scale the observed power level to an equivalent value in 500 kHz by adjusting (reducing) the measured power by a bandwidth correction factor (BWCF) where  $BWCF = 10\log(500 \text{ kHz}/300\text{kHz})$
5. Sweep time = auto, trigger set to "free run".
6. Trace average at least 100 traces in power averaging mode.
7. Record the max value and add  $10 \log (1/\text{duty cycle})$

#### 4.5.5 Deviation from Test Standard

No deviation.

#### 4.5.6 EUT Operating Condition

Same as Item 4.3.6.



#### 4.5.7 Test Results

##### For U-NII-1:

##### 802.11a

Chan.	Chan. Freq. (MHz)	PSD W/O Duty Factor (dBm)		Duty Factor (dB)	Total PSD With Duty Factor (dBm)	MAX. Limit (dBm)	Pass / Fail
		Chain 0	Chain 1				
36	5180	-1.11	-3.22	0.17	1.14	14.99	Pass
40	5200	-1.09	-2.77	0.17	1.33	14.99	Pass
48	5240	-1.20	-2.14	0.17	1.54	14.99	Pass

- Note:**
- Method a) of power density measurement of KDB 662911 is using for calculating total power density. Total power density is summing entire spectra across corresponding frequency bins on the various outputs by computer.
  - Directional gain =  $5\text{dBi} + 10\log(2) = 8.01\text{dBi} > 6\text{dBi}$  , so the power density limit shall be reduced to  $17-(8.01-6) = 14.99\text{dBm}$ .
  - Refer to section 3.3 for duty cycle spectrum plot.

##### 802.11ac (VHT20)

Chan.	Chan. Freq. (MHz)	PSD (dBm/MHz)		Total Power Density (dBm/MHz)	MAX. Limit (dBm/MHz)	Pass / Fail
		Chain 0	Chain 1			
36	5180	-1.45	-2.86	0.91	14.99	Pass
40	5200	-1.38	-2.52	1.10	14.99	Pass
48	5240	-1.31	-1.69	1.51	14.99	Pass

- Note:**
- Method a) of power density measurement of KDB 662911 is using for calculating total power density. Total power density is summing entire spectra across corresponding frequency bins on the various outputs by computer.
  - Directional gain =  $5\text{dBi} + 10\log(2) = 8.01\text{dBi} > 6\text{dBi}$  , so the power density limit shall be reduced to  $17-(8.01-6) = 14.99\text{dBm}$ .

### 802.11ac (VHT40)

Chan.	Chan. Freq. (MHz)	PSD W/O Duty Factor (dBm)		Duty Factor (dB)	Total PSD With Duty Factor (dBm)	MAX. Limit (dBm)	Pass / Fail
		Chain 0	Chain 1				
38	5190	-2.19	-2.75	0.16	0.71	14.99	Pass
46	5230	-0.75	-1.75	0.16	1.95	14.99	Pass

- Note:**
- Method a) of power density measurement of KDB 662911 is using for calculating total power density. Total power density is summing entire spectra across corresponding frequency bins on the various outputs by computer.
  - Directional gain =  $5\text{dBi} + 10\log(2) = 8.01\text{dBi} > 6\text{dBi}$ , so the power density limit shall be reduced to  $17 - (8.01 - 6) = 14.99\text{dBm}$ .
  - Refer to section 3.3 for duty cycle spectrum plot.

### 802.11ac (VHT80)

Chan.	Chan. Freq. (MHz)	PSD W/O Duty Factor (dBm)		Duty Factor (dB)	Total PSD With Duty Factor (dBm)	MAX. Limit (dBm)	Pass / Fail
		Chain 0	Chain 1				
42	5210	-9.57	-9.53	0.29	-6.25	14.99	Pass

- Note:**
- Method a) of power density measurement of KDB 662911 is using for calculating total power density. Total power density is summing entire spectra across corresponding frequency bins on the various outputs by computer.
  - Directional gain =  $5\text{dBi} + 10\log(2) = 8.01\text{dBi} > 6\text{dBi}$ , so the power density limit shall be reduced to  $17 - (8.01 - 6) = 14.99\text{dBm}$ .
  - Refer to section 3.3 for duty cycle spectrum plot.

Spectrum Plot of Worst Value

802.11a\_Chain 0 / CH40

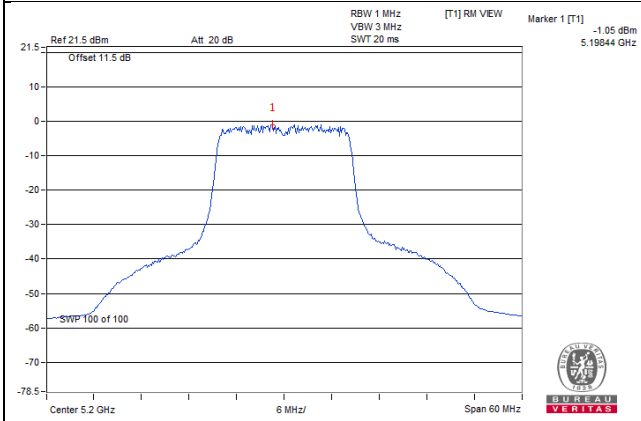

802.11ac (VHT20)\_Chain 0 / CH48

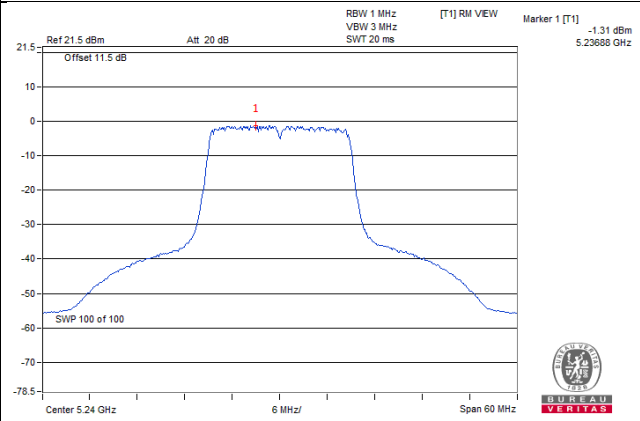

802.11ac (VHT40)\_Chain 0 / CH46

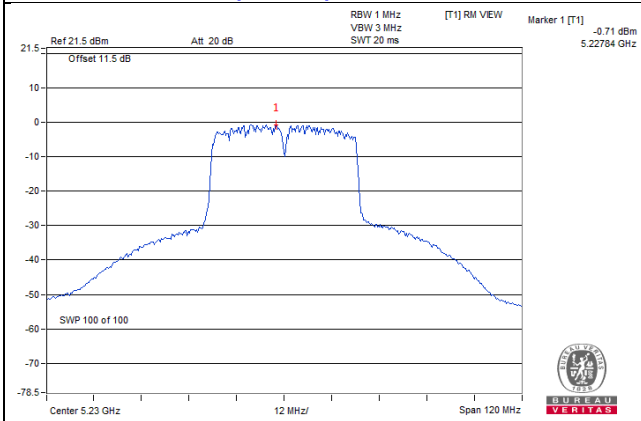

802.11ac (VHT80)\_Chain 1 / CH42

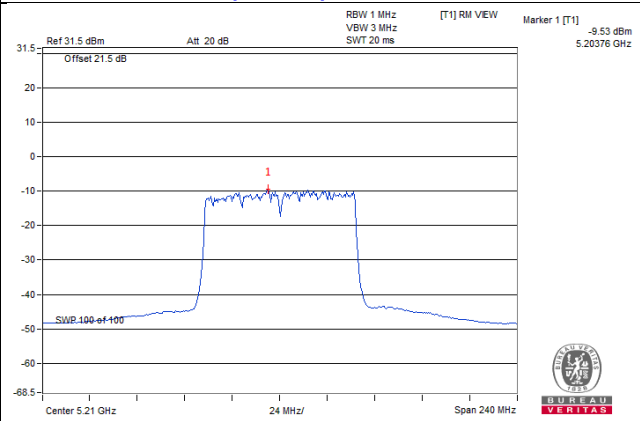

**For U-NII-3:**
**802.11a**

Chan.	Freq. (MHz)	PSD W/O Duty Factor (dBm/300kHz)		Duty Factor (dB)	Total PSD With Duty Factor		Total PSD With Duty Factor (dBm/500kHz)	Limit (dBm/500kHz)	Pass /Fail
		Chain 0	Chain 1		mW/300kHz	dBm/300kHz			
149	5745	-4.47	-2.70	0.17	0.9305	-0.31	1.91	27.99	Pass
157	5785	-4.86	-2.93	0.17	0.8697	-0.61	1.61	27.99	Pass
165	5825	-4.37	-2.53	0.17	0.9614	-0.17	2.05	27.99	Pass

- Note: 1. Method b) Measure and sum spectral maxima across the outputs of KDB 662911 is using for calculating total power density.  
 2. Directional gain =  $5\text{dBi} + 10\log(2) = 8.01\text{dBi} > 6\text{dBi}$ , so the power density limit shall be reduced to  $30 - (8.01 - 6) = 27.99\text{dBm}$ .  
 3. Refer to section 3.3 for duty cycle spectrum plot.

**802.11ac (VHT20)**

Chan.	Freq. (MHz)	PSD (dBm/300kHz)		Total PSD		Total PSD (dBm/500kHz)	Limit (dBm/500kHz)	Pass /Fail
		Chain 0	Chain 1	mW/300kHz	dBm/300kHz			
149	5745	-4.59	-3.00	0.8487	-0.71	1.51	27.99	Pass
157	5785	-4.74	-3.52	0.7804	-1.08	1.14	27.99	Pass
165	5825	-4.58	-2.76	0.878	-0.57	1.65	27.99	Pass

- Note: 1. Method b) Measure and sum spectral maxima across the outputs of KDB 662911 is using for calculating total power density.  
 2. Directional gain =  $5\text{dBi} + 10\log(2) = 8.01\text{dBi} > 6\text{dBi}$ , so the power density limit shall be reduced to  $30 - (8.01 - 6) = 27.99\text{dBm}$ .

**802.11ac (VHT40)**

Chan.	Freq. (MHz)	PSD W/O Duty Factor (dBm/300kHz)		Duty Factor (dB)	Total PSD With Duty Factor		Total PSD With Duty Factor (dBm/500kHz)	Limit (dBm/500kHz)	Pass /Fail
		Chain 0	Chain 1		mW/300kHz	dBm/300kHz			
151	5755	-7.98	-6.48	0.16	0.3984	-4.00	-1.78	27.99	Pass
159	5795	-7.44	-6.01	0.16	0.447	-3.50	-1.28	27.99	Pass

- Note: 1. Method b) Measure and sum spectral maxima across the outputs of KDB 662911 is using for calculating total power density.  
 2. Directional gain =  $5\text{dBi} + 10\log(2) = 8.01\text{dBi} > 6\text{dBi}$ , so the power density limit shall be reduced to  $30 - (8.01 - 6) = 27.99\text{dBm}$ .  
 3. Refer to section 3.3 for duty cycle spectrum plot.

### 802.11ac (VHT80)

Chan.	Freq. (MHz)	PSD W/O Duty Factor (dBm/300kHz)		Duty Factor (dB)	Total PSD With Duty Factor		Total PSD With Duty Factor (dBm/500kHz)	Limit (dBm/500kHz)	Pass /Fail
		Chain 0	Chain 1		mW/300kHz	dBm/300kHz			
155	5745	-12.76	-11.90	0.29	0.12551	-9.01	-6.79	27.99	Pass

- Note: 1. Method b) Measure and sum spectral maxima across the outputs of KDB 662911 is using for calculating total power density.
2. Directional gain =  $5\text{dBi} + 10\log(2) = 8.01\text{dBi} > 6\text{dBi}$ , so the power density limit shall be reduced to  $30 - (8.01 - 6) = 27.99\text{dBm}$ .
3. Refer to section 3.3 for duty cycle spectrum plot.

Spectrum Plot of Worst Value

802.11a – Chain 1: CH 165

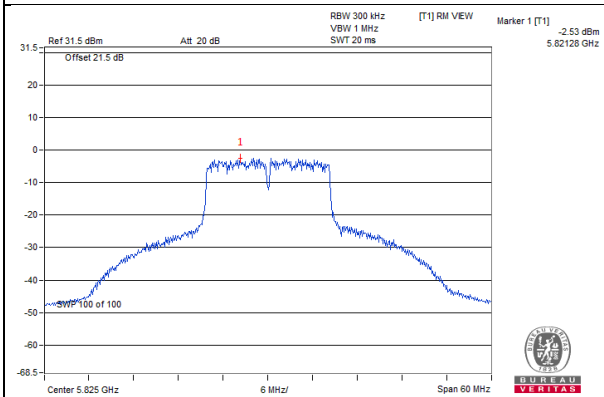

802.11ac (VHT20) – Chain 1: CH 165

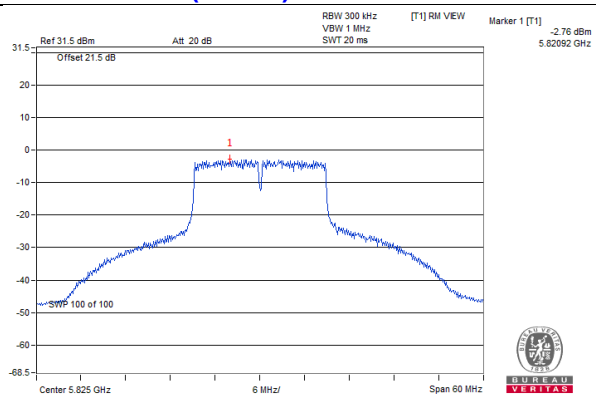

802.11ac (VHT40) – Chain 1: CH 159

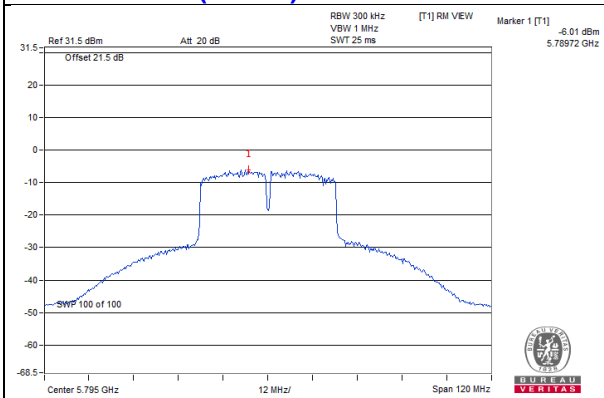

802.11ac (VHT80) – Chain 1: CH 155

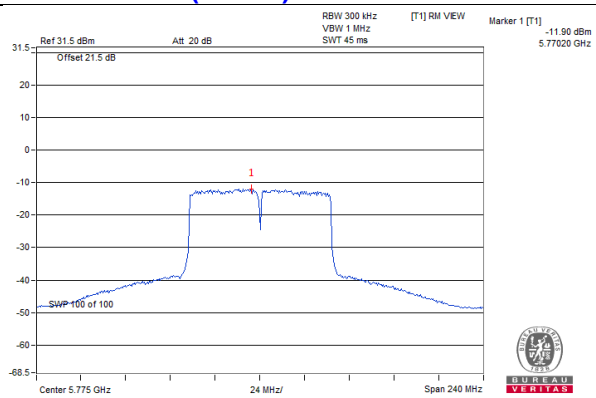

## 4.6 Frequency Stability Measurement

### 4.6.1 Limits of Frequency Stability Measurement

The frequency of the carrier signal shall be maintained within band of operation

### 4.6.2 Test Setup

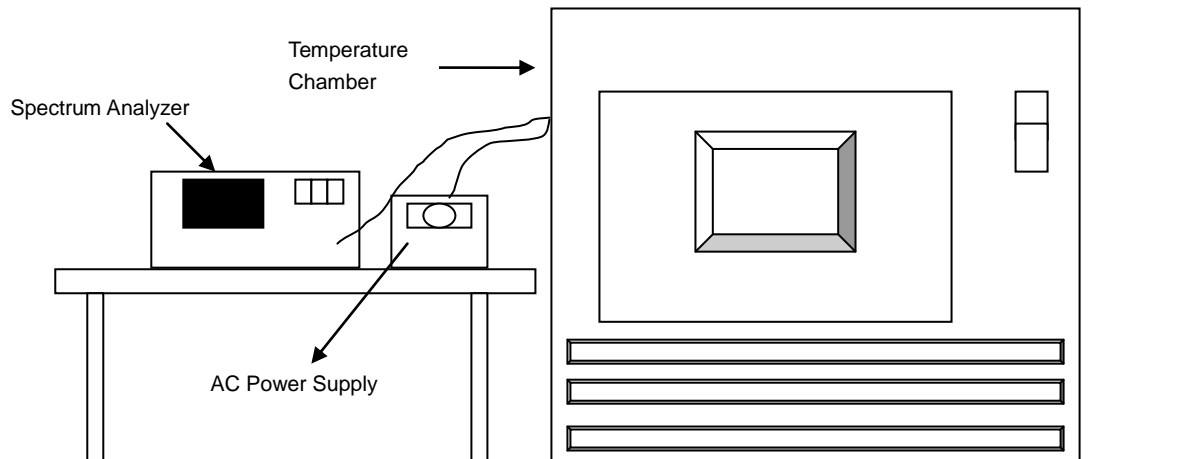

### 4.6.3 Test Instruments

Refer to section 4.1.2 to get information of above instrument.

### 4.6.4 Test Procedure

- The EUT was placed inside the environmental test chamber and powered by nominal AC voltage.
- Turn the EUT on and couple its output to a spectrum analyzer.
- Turn the EUT off and set the chamber to the highest temperature specified.
- Allow sufficient time (approximately 30 min) for the temperature of the chamber to stabilize, turn the EUT on and measure the operating frequency after 2, 5, and 10 Minutes.
- Repeat step (d) with the temperature chamber set to the next desired temperature until measurements down to the lowest specified temperature have been completed..
- The test chamber was allowed to stabilize at +20 degree C for a minimum of 30 Minutes. The supply voltage was then adjusted on the EUT from 85% to 115% and the frequency record.

### 4.6.5 Deviation from Test Standard

No deviation.

### 4.6.6 EUT Operating Condition

Set the EUT transmit at un-modulation mode to test frequency stability.

#### 4.6.7 Test Results

Frequency Stability Versus Temp.									
Operating Frequency: 5180 MHz									
TEMP. (°C)	Power Supply (Vac)	0 Minute		2 Minutes		5 Minutes		10 Minutes	
		Measured Frequency (MHz)	Pass/Fail	Measured Frequency (MHz)	Pass/Fail	Measured Frequency (MHz)	Pass/Fail	Measured Frequency (MHz)	Pass/Fail
50	120	5179.9843	PASS	5179.9806	PASS	5179.9846	PASS	5179.9815	PASS
40	120	5179.9776	PASS	5179.9781	PASS	5179.9758	PASS	5179.9744	PASS
30	120	5179.976	PASS	5179.9735	PASS	5179.9738	PASS	5179.9752	PASS
20	120	5180.0146	PASS	5180.0119	PASS	5180.0122	PASS	5180.0109	PASS
10	120	5180.0273	PASS	5180.0247	PASS	5180.0233	PASS	5180.0278	PASS
0	120	5179.9795	PASS	5179.9773	PASS	5179.9799	PASS	5179.9783	PASS
-10	120	5180.0195	PASS	5180.0207	PASS	5180.0172	PASS	5180.0184	PASS
-20	120	5180.0035	PASS	5180.0013	PASS	5179.9984	PASS	5180.0013	PASS
-30	120	5180.0225	PASS	5180.0202	PASS	5180.023	PASS	5180.0205	PASS

Frequency Stability Versus Voltage									
Operating Frequency: 5180 MHz									
TEMP. (°C)	Power Supply (Vac)	0 Minute		2 Minutes		5 Minutes		10 Minutes	
		Measured Frequency (MHz)	Pass/Fail	Measured Frequency (MHz)	Pass/Fail	Measured Frequency (MHz)	Pass/Fail	Measured Frequency (MHz)	Pass/Fail
20	138	5180.0145	PASS	5180.0123	PASS	5180.0123	PASS	5180.0104	PASS
	120	5180.0146	PASS	5180.0119	PASS	5180.0122	PASS	5180.0109	PASS
	102	5180.0138	PASS	5180.0109	PASS	5180.0123	PASS	5180.0117	PASS



## 4.7 6dB Bandwidth Measurement

### 4.7.1 Limits of 6dB Bandwidth Measurement

The minimum of 6dB Bandwidth Measurement is 0.5MHz.

### 4.7.2 Test Setup

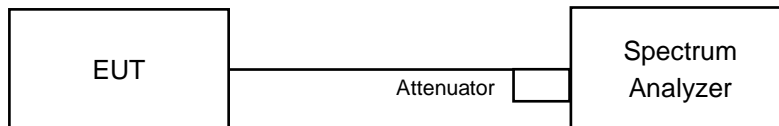

### 4.7.3 Test Instruments

Refer to section 4.1.2 to get information of above instrument.

### 4.7.4 Test Procedure

#### MEASUREMENT PROCEDURE REF

- Set resolution bandwidth (RBW) = 100kHz
- Set the video bandwidth (VBW)  $\geq 3 \times$  RBW, Detector = Peak.
- Trace mode = max hold.
- Sweep = auto couple.
- Measure the maximum width of the emission that is constrained by the frequencies associated with the two amplitude points (upper and lower) that are attenuated by 6 dB relative to the maximum level measured in the fundamental emission

### 4.7.5 Deviation from Test Standard

No deviation.

### 4.7.6 EUT Operating Condition

The software provided by client to enable the EUT under transmission condition continuously at lowest, middle and highest channel frequencies individually.

#### 4.7.7 Test Results

##### 802.11a

Channel	Frequency (MHz)	6dB Bandwidth (MHz)		Minimum Limit (MHz)	Pass / Fail
		Chain 0	Chain 1		
149	5745	16.37	16.39	0.5	PASS
157	5785	16.40	16.39	0.5	PASS
165	5825	16.37	16.38	0.5	PASS

##### 802.11ac (VHT20)

Channel	Frequency (MHz)	6dB Bandwidth (MHz)		Minimum Limit (MHz)	Pass / Fail
		Chain 0	Chain 1		
149	5745	17.63	17.64	0.5	PASS
157	5785	17.63	17.65	0.5	PASS
165	5825	17.63	17.60	0.5	PASS

##### 802.11ac (VHT40)

Channel	Frequency (MHz)	6dB Bandwidth (MHz)		Minimum Limit (MHz)	Pass / Fail
		Chain 0	Chain 1		
151	5755	35.19	35.24	0.5	PASS
159	5795	35.23	35.23	0.5	PASS

##### 802.11ac (VHT80)

Channel	Frequency (MHz)	6dB Bandwidth (MHz)		Minimum Limit (MHz)	Pass / Fail
		Chain 0	Chain 1		
155	5775	75.54	75.78	0.5	PASS

Spectrum Plot of Worst Value

802.11a\_Chain 0 / CH149

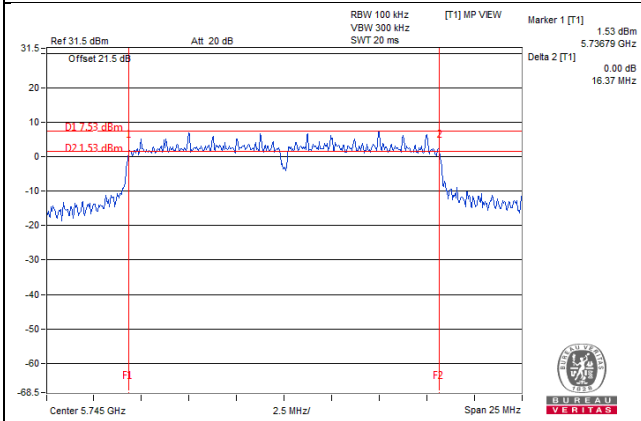

802.11ac (VHT20)\_Chain 1 / CH165

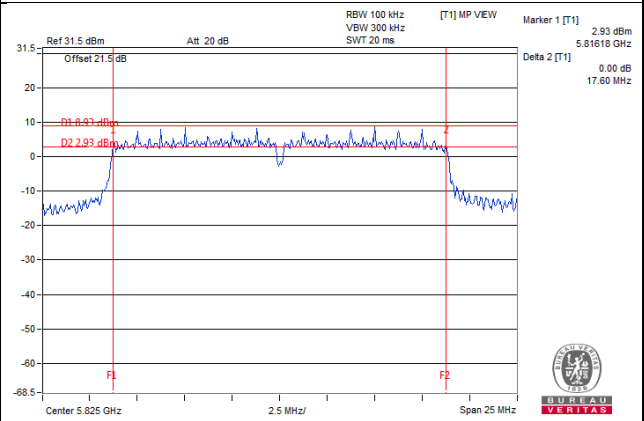

802.11ac (VHT40)\_Chain 0 / CH151

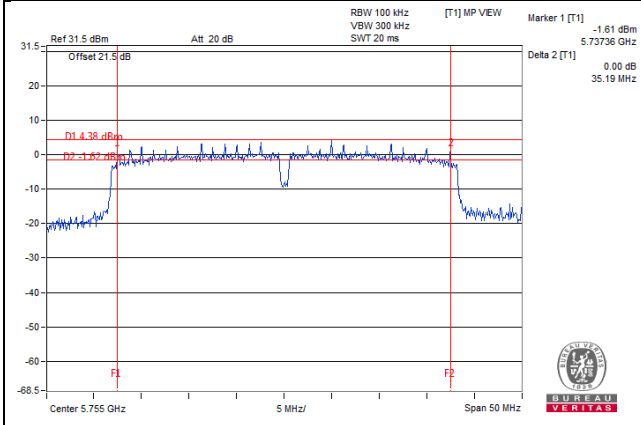

802.11ac (VHT80)\_Chain 0 / CH155

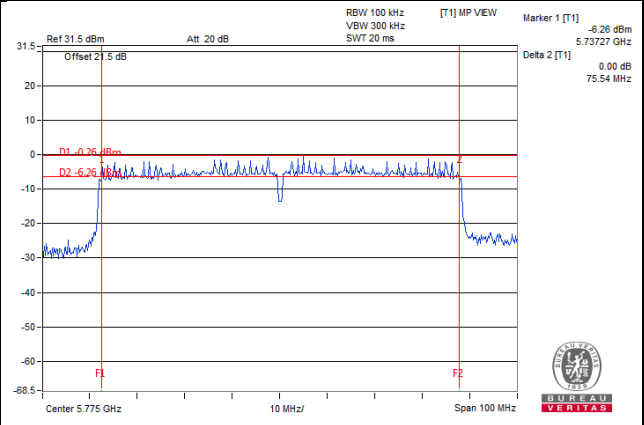

## 5 Pictures of Test Arrangements

Please refer to the attached file (Test Setup Photo).

### Annex A- Radiated Out of Band Emission (OOBE) Measurement (For U-NII-3 band)

802.11a

**CH 149 5745 MHz**

**Horizontal**

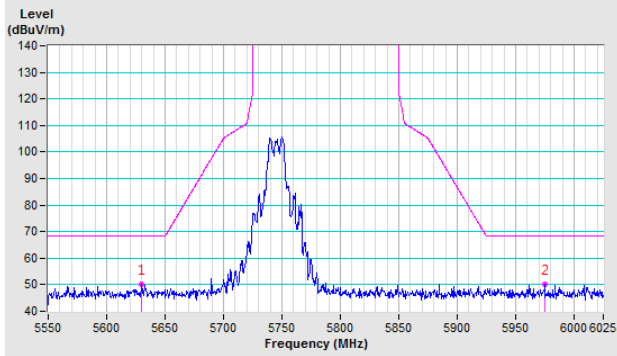

**Vertical**

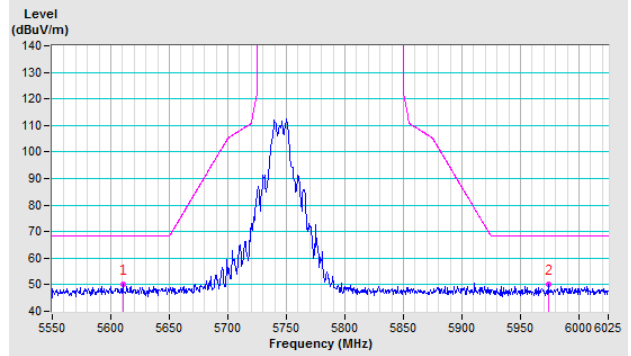

**CH 157 5785 MHz**

**Horizontal**

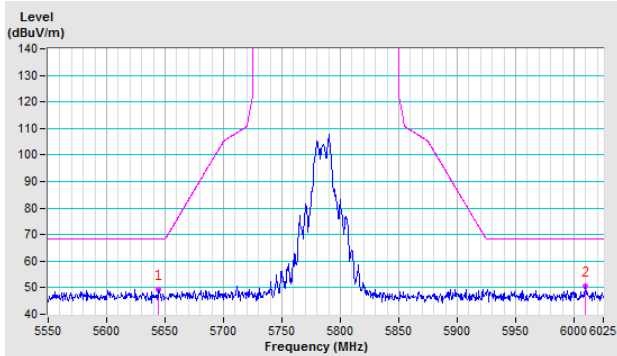

**Vertical**

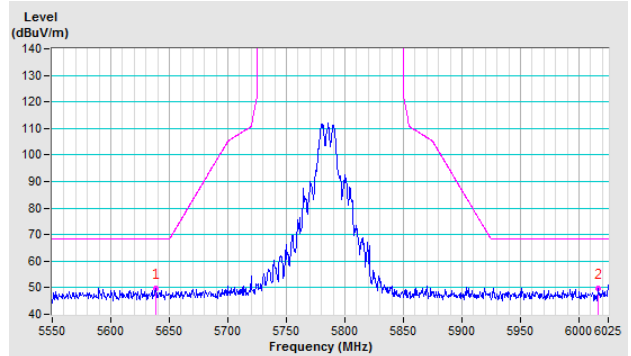

**CH 165 5825 MHz**

**Horizontal**

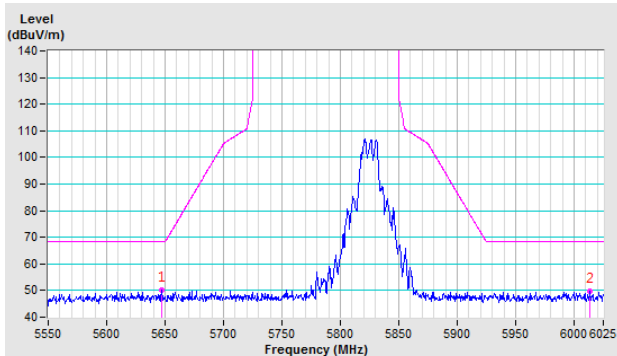

**Vertical**

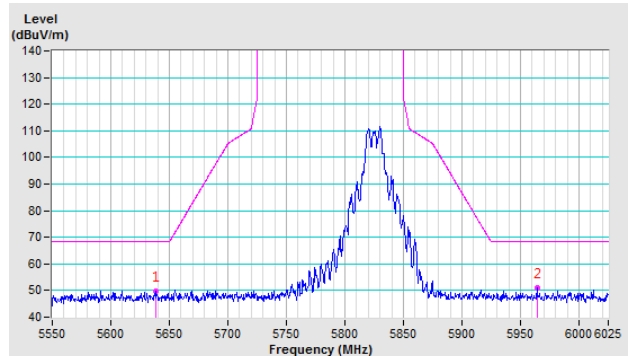

### 802.11ac (VHT20)

#### CH 149 5745 MHz

**Horizontal**

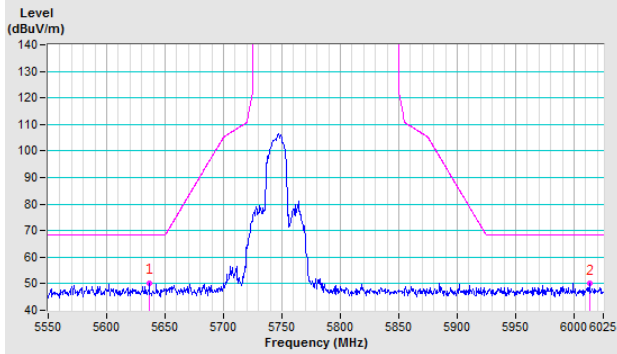

**Vertical**

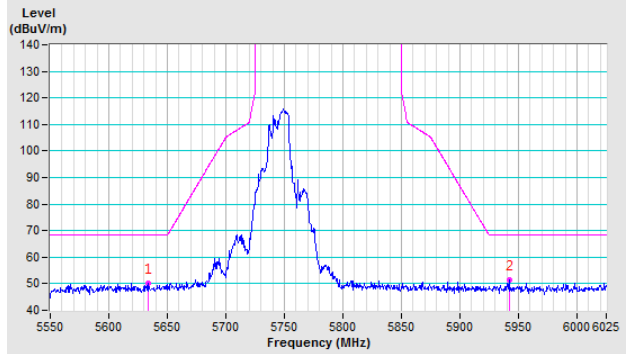

#### CH 157 5785 MHz

**Horizontal**

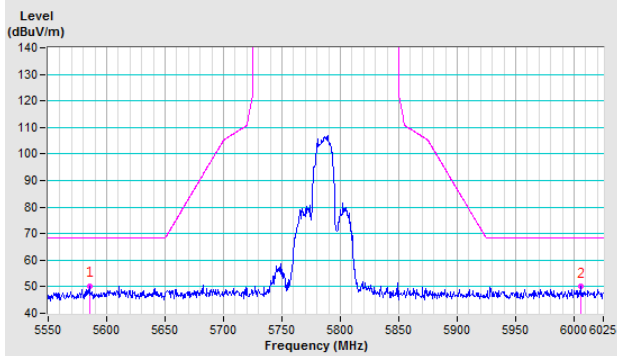

**Vertical**

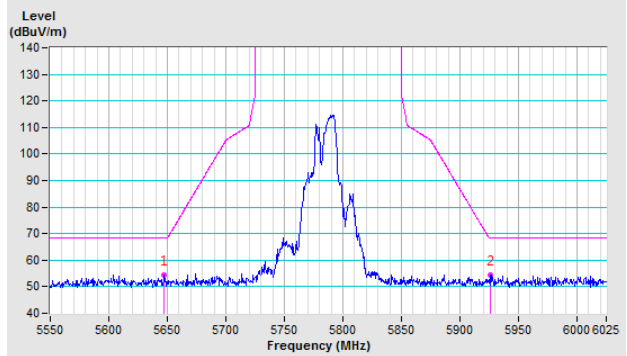

#### CH 165 5825 MHz

**Horizontal**

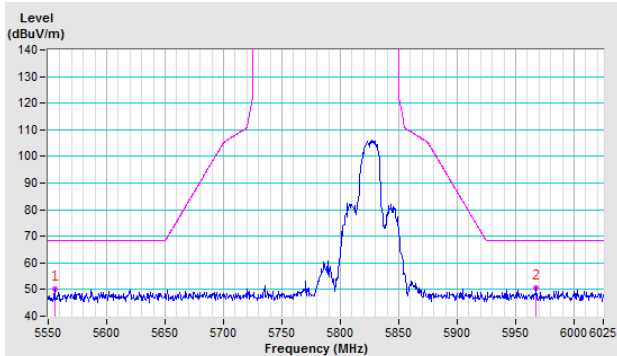

**Vertical**

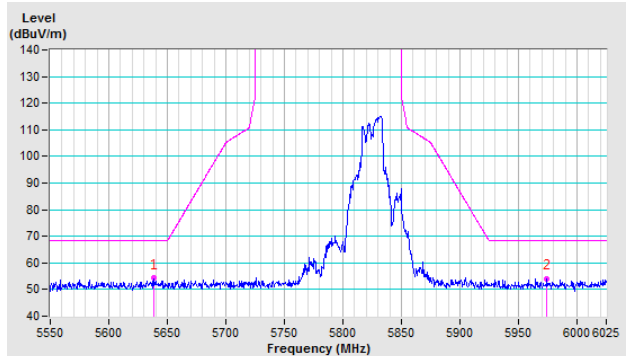

### 802.11ac (VHT40)

**CH 151 5755 MHz**

**Horizontal**

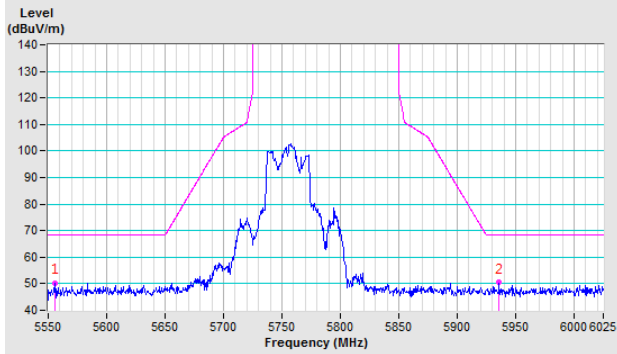

**Vertical**

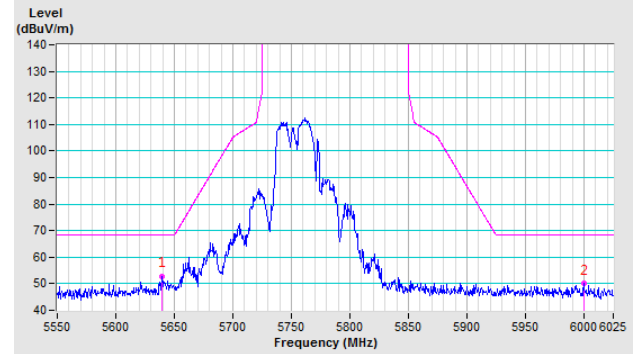

**CH 159 5795 MHz**

**Horizontal**

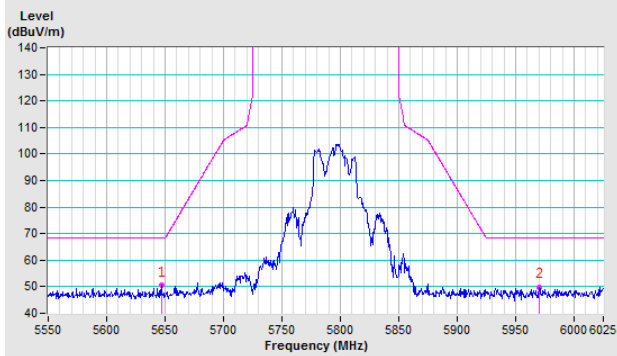

**Vertical**

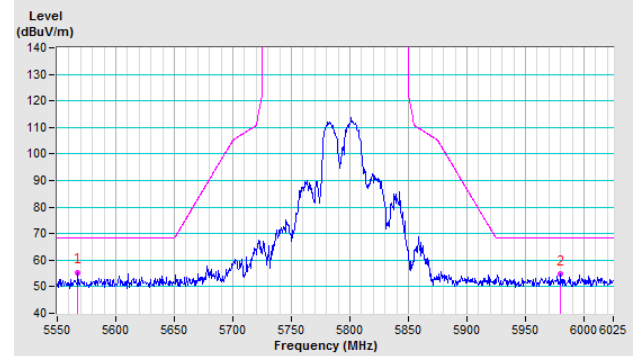

### 802.11ac (VHT80)

**CH 155 5775 MHz**

**Horizontal**

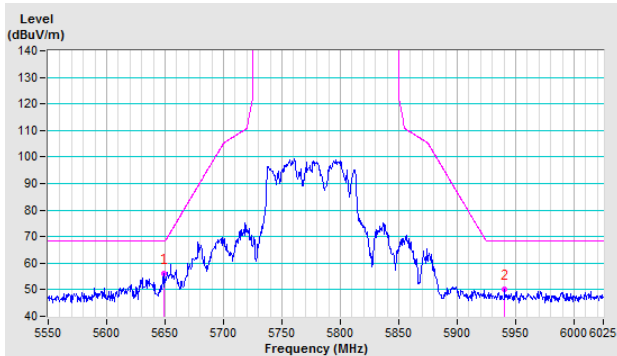

**Vertical**

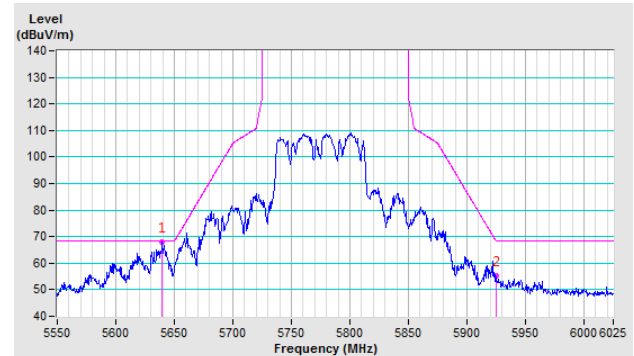

## Appendix – Information on the Testing Laboratories

We, Bureau Veritas Consumer Products Services (H.K.) Ltd., Taoyuan Branch, were founded in 1988 to provide our best service in EMC, Radio, Telecom and Safety consultation. Our laboratories are FCC recognized accredited test firms and accredited according to ISO/IEC 17025.

If you have any comments, please feel free to contact us at the following:

**Linkou EMC/RF Lab**

Tel: 886-2-26052180

Fax: 886-2-26051924

**Hsin Chu EMC/RF/Telecom Lab**

Tel: 886-3-6668565

Fax: 886-3-6668323

**Hwa Ya EMC/RF/Safety Lab**

Tel: 886-3-3183232

Fax: 886-3-3270892

**Email:** [service.adt@tw.bureauveritas.com](mailto:service.adt@tw.bureauveritas.com)

**Web Site:** [www.bureauveritas-adt.com](http://www.bureauveritas-adt.com)

The address and road map of all our labs can be found in our web site also.

--- END ---