



RADIO TEST REPORT

FCC ID : 2AMQU-QN-I-470
Equipment : Dual-Band Wi-Fi 6 indoor Access Point (802.11 ax 4X4)
Brand Name : Quantum Networks
Model Name : QN-I-470
Applicant : QUANTUM NETWORKS (SG) PTE.LTD.
8 UBI ROAD 2 #08-10 ZERVEX
SINGAPORE(408538), SINGAPORE, Singapore
Manufacturer : QUANTUM NETWORKS (SG) PTE.LTD.
8 UBI ROAD 2 #08-10 ZERVEX
SINGAPORE(408538), SINGAPORE, Singapore
Standard : 47 CFR FCC Part 15.247

The product was received on Dec. 01, 2020, and testing was started from Dec. 04, 2020 and completed on Sep. 13, 2021. We, Sporton International Inc. Hsinchu Laboratory, would like to declare that the tested sample has been evaluated in accordance with the procedures given in ANSI C63.10-2013 and shown compliance with the applicable technical standards.

The test results in this report apply exclusively to the tested model / sample. Without written approval of Sporton International Inc. Hsinchu Laboratory, the test report shall not be reproduced except in full.

Approved by: Cliff Chang

Sporton International Inc. Hsinchu Laboratory

No.8, Ln. 724, Bo'ai St., Zhubei City, Hsinchu County 302010, Taiwan (R.O.C.)



Table of Contents

History of this test report.....3

Summary of Test Result.....4

1 General Description5

1.1 Information.....5

1.2 Applicable Standards8

1.3 Testing Location Information.....8

1.4 Measurement Uncertainty8

2 Test Configuration of EUT.....9

2.1 Test Channel Mode9

2.2 The Worst Case Measurement Configuration.....10

2.3 EUT Operation during Test11

2.4 Accessories11

2.5 Support Equipment.....13

2.6 Test Setup Diagram14

3 Transmitter Test Result17

3.1 AC Power-line Conducted Emissions17

3.2 DTS Bandwidth19

3.3 Maximum Conducted Output Power20

3.4 Power Spectral Density23

3.5 Emissions in Non-restricted Frequency Bands25

3.6 Emissions in Restricted Frequency Bands.....26

4 Test Equipment and Calibration Data30

Appendix A. Test Results of AC Power-line Conducted Emissions

Appendix B. Test Results of DTS Bandwidth

Appendix C. Test Results of Maximum Conducted Output Power

Appendix D. Test Results of Power Spectral Density

Appendix E. Test Results of Emissions in Non-restricted Frequency Bands

Appendix F. Test Results of Emissions in Restricted Frequency Bands

Appendix G. Test Results of Radiated Emission Co-location

Appendix H. Test Photos

Photographs of EUT v01



History of this test report

Report No.	Version	Description	Issued Date
FR0N2725-07AC	01	Initial issue of report	Nov. 09, 2021



Summary of Test Result

Report Clause	Ref Std. Clause	Test Items	Result (PASS/FAIL)	Remark
1.1.2	15.203	Antenna Requirement	PASS	-
3.1	15.207	AC Power-line Conducted Emissions	PASS	-
3.2	15.247(a)	DTS Bandwidth	PASS	-
3.3	15.247(b)	Maximum Conducted Output Power	PASS	-
3.4	15.247(e)	Power Spectral Density	PASS	-
3.5	15.247(d)	Emissions in Non-restricted Frequency Bands	PASS	-
3.1	15.247(d)	Emissions in Restricted Frequency Bands	PASS	-

Note: From Sporton Project No.: 0N2725, 0N2725-06.

Declaration of Conformity:

The test results with all measurement uncertainty excluded are presented in accordance with the regulation limits or requirements declared by manufacturers.

Comments and Explanations:

1. The test configuration, test mode and test software were written in this test report are declared by the manufacturer.
2. The declared of product specification for EUT presented in the report are provided by the manufacturer, and the manufacturer takes all the responsibilities for the accuracy of product specification.

Reviewed by: Sam Chen
Report Producer: Wendy Pan



1 General Description

1.1 Information

1.1.1 RF General Information

Frequency Range (MHz)	Bluetooth Mode	Ch. Frequency (MHz)	Channel Number
2400-2483.5	LE	2402-2480	0-39 [40]

Band	Mode	BWch (MHz)	Nant
2.4-2.4835GHz	BT-LE(1Mbps)	1	1
2.4-2.4835GHz	BT-LE(2Mbps)	2	1

Note:

- ♦ Bluetooth LE uses a GFSK modulation.
- ♦ BWch is the nominal channel bandwidth.



1.1.2 Antenna Information

Set.	Ant.	2.4G Port	5G Port	Bluetooth Port	Brand	P/N	Antenna Type	Connector	Gain (dBi)
1	1	1	1	-	MAG. LAYERS	MSA-1313-25 GC4-A2-TN	PIFA Antenna	I-PEX	Note 1
	2	2	2	-			PIFA Antenna	I-PEX	
	3	3	3	-			PIFA Antenna	I-PEX	
	4	4	4	1			PIFA Antenna	I-PEX	

Note 1:

Set.	Ant.	Gain (dBi)		
		2.4GHz	5GHz	Bluetooth
1	1	5.43	7.54	-
	2	5.36	6.92	-
	3	5.24	6.80	-
	4	5.19	6.76	5.19

Note 2: The above information was declared by manufacturer.

Note 3: The EUT has one set of antenna.

For 2.4GHz function:

For IEEE 802.11b/g/n/VHT/ax mode (2TX/2RX)

The EUT supports all antennas with TX/RX diversity functions.

At once time there are only two antenna port can transmitting/receiving RF signal.

Port 1 and Port 2 generated the worst case than Port 3 and Port 4, so it is tested and recorded in the report.

For 5GHz function:

For IEEE 802.11a/n/ac/ax mode (4TX/4RX)

Port 1, Port 2, Port 3 and Port 4 can be used as transmitting/receiving antenna.

Port 1, Port 2, Port 3 and Port 4 could transmit/receive simultaneously.

For Bluetooth function:

Only Port 1 can be used as transmitting/receiving functions.



1.1.3 Mode Test Duty Cycle

Mode	DC	DCF(dB)	T(s)	VBW(Hz) ≥ 1/T
BT-LE(1Mbps)	0.63	2.01	393.75u	3k
BT-LE(2Mbps)	0.333	4.78	208.125u	10k

Note:

- ◆ DC is Duty Cycle.
- ◆ DCF is Duty Cycle Factor.

1.1.4 EUT Operational Condition

EUT Power Type	From Power Adapter or PoE		
Function	<input checked="" type="checkbox"/> Point-to-multipoint	<input type="checkbox"/> Point-to-point	
Test Software Version	AgXBT4_ATE A.06.02		
Support Mode	<input checked="" type="checkbox"/> LE 1M PHY: 1 Mb/s		
	<input type="checkbox"/> LE Coded PHY (S=2): 500 Kb/s		
	<input type="checkbox"/> LE Coded PHY (S=8): 125 Kb/s		
	<input checked="" type="checkbox"/> LE 2M PHY: 2 Mb/s		

Note: The above information was declared by manufacturer.



1.2 Applicable Standards

According to the specifications of the manufacturer, the EUT must comply with the requirements of the following standards:

- ♦ 47 CFR FCC Part 15
- ♦ ANSI C63.10-2013

The following reference test guidance is not within the scope of accreditation of TAF.

- ♦ FCC KDB 558074 D01 v05r02
- ♦ FCC KDB 414788 D01 v01r01

1.3 Testing Location Information

Testing Location Information	
Test Lab. : Sporton International Inc. Hsinchu Laboratory	
Hsinchu	ADD: No.8, Ln. 724, Bo'ai St., Zhubei City, Hsinchu County 302010, Taiwan (R.O.C.)
(TAF: 3787)	TEL: 886-3-656-9065 FAX: 886-3-656-9085
	Test site Designation No. TW3787 with FCC.
	Conformity Assessment Body Identifier (CABID) TW3787 with ISED.

Test Condition	Test Site No.	Test Engineer	Test Environment (°C / %)	Test Date
RF Conducted	TH03-CB	Nyle Chang	20.2~21.2 / 53~57	Dec. 21, 2020
Radiated below 1GHz	03CH03-CB	Ken Yeh	24.6-25.7 / 55-58	Sep. 13, 2021
Radiated above 1GHz (For other tests)	03CH04-CB	Lance Wu	23.4~24.2 / 56~58	Dec. 07, 2020~ Dec. 22, 2020
Radiated above 1GHz (For co-location test)	03CH05-CB	Lance Wu	24~24.7 / 57~59	Dec. 04, 2020
AC Conduction	CO01-CB	Peter Wu	23~24°C / 62~63%	Dec. 07, 2020~ Dec. 08, 2020

1.4 Measurement Uncertainty

ISO/IEC 17025 requires that an estimate of the measurement uncertainties associated with the emissions test results be included in the report. The measurement uncertainties given below are based on a 95% confidence level (based on a coverage factor (k=2))

Test Items	Uncertainty	Remark
Conducted Emission (150kHz ~ 30MHz)	2.0 dB	Confidence levels of 95%
Radiated Emission (9kHz ~ 30MHz)	4.2 dB	Confidence levels of 95%
Radiated Emission (30MHz ~ 1,000MHz)	5.5 dB	Confidence levels of 95%
Radiated Emission (1GHz ~ 18GHz)	5.0 dB	Confidence levels of 95%
Radiated Emission (18GHz ~ 40GHz)	4.9 dB	Confidence levels of 95%
Conducted Emission	2.8 dB	Confidence levels of 95%
Output Power Measurement	1.4 dB	Confidence levels of 95%
Power Density Measurement	2.8 dB	Confidence levels of 95%
Bandwidth Measurement	0.4%	Confidence levels of 95%



2 Test Configuration of EUT

2.1 Test Channel Mode

Mode	Power Setting
BT-LE(1Mbps)	-
2402MHz	Default
2440MHz	Default
2480MHz	Default
BT-LE(2Mbps)	-
2402MHz	Default
2440MHz	Default
2480MHz	Default



2.2 The Worst Case Measurement Configuration

The Worst Case Mode for Following Conformance Tests	
Tests Item	AC power-line conducted emissions
Condition	AC power-line conducted measurement for line and neutral Test Voltage: 120Vac / 60Hz
Operating Mode	Normal Link
1	Normal Link - EUT + Adapter + Uplink (PoE): 2.5Gbps + LAN: 2.5Gbps
2	Normal Link - EUT + PoE + Uplink (PoE): 2.5Gbps + LAN: 2.5Gbps
For operating mode 2 is the worst case and it was record in this test report.	

The Worst Case Mode for Following Conformance Tests	
Tests Item	DTS Bandwidth Maximum Conducted Output Power Power Spectral Density Emissions in Non-restricted Frequency Bands
Test Condition	Conducted measurement at transmit chains

The Worst Case Mode for Following Conformance Tests	
Tests Item	Emissions in Restricted Frequency Bands
Test Condition	Radiated measurement If EUT consist of multiple antenna assembly (multiple antenna are used in EUT regardless of spatial multiplexing MIMO configuration), the radiated test should be performed with highest antenna gain of each antenna type.
Operating Mode < 1GHz	1. The EUT was performed at Y axis and Z axis position, and the worst case was found at Z axis. So the measurement will follow this same test configuration. 2. The EUT has two power supplies, one is PoE and the other is adapter. The PoE has been evaluated to be the worst case and recorded in the test report.
	Normal Link
1	EUT in Z axis + PoE + Uplink (PoE): 2.5Gbps + LAN: 2.5Gbps
Operating Mode > 1GHz	CTX The EUT was performed at Y axis and Z axis position for Emissions in Restricted Frequency Bands above 1GHz test, and the worst case was found at Z axis. So the measurement will follow this same test configuration.
	1



The Worst Case Mode for Following Conformance Tests	
Tests Item	Simultaneous Transmission Analysis - Radiated Emission Co-location
Test Condition	Radiated measurement
Operating Mode	Normal Link
	The EUT was performed at Y axis and Z axis position for Emissions in Restricted Frequency Bands below 1GHz test, and the worst case was found at Z axis. So the measurement will follow this same test configuration.
1	EUT in Z axis - WLAN 2.4GHz + WLAN 5GHz + Bluetooth
Refer to Appendix G for Radiated Emission Co-location.	

The Worst Case Mode for Following Conformance Tests	
Tests Item	Simultaneous Transmission Analysis - Co-location RF Exposure Evaluation
Operating Mode	
1	WLAN 2.4GHz + WLAN 5GHz + Bluetooth
Refer to Sporton Test Report No.: FA0N2725-07 for Co-location RF Exposure Evaluation.	

Note1: The console port is professional usage by manufacturer declaration, and it was performed the test at the load.

Note2: The USB port was performed the test at the load by manufacturer requirement.

Note3: The PoE is for measurement only, would not be marketed.

PoE information as below:

Power	Brand	Model
PoE	GME	GME40B-480135FDA

2.3 EUT Operation during Test

For CTX Mode:

The EUT was programmed to be in continuously transmitting mode.

For Normal Link:

During the test, the EUT operation to normal function.

2.4 Accessories

Accessories			
Equipment Name	Brand Name	Model Name	Rating
Adapter	APD	WB-24J12R	Input: 100-240V~50-60Hz 0.7A Max. Output: 12.0V, 2.0A, 24.0W
Others			
Plug*1			
Console cable*1: Non-shielded, 1.5m			



Wall bracket*1



2.5 Support Equipment

For AC Conduction:

Support Equipment				
No.	Equipment	Brand Name	Model Name	FCC ID
A	2.5G LAN PC	DELL	T3400	N/A
B	2.5G PoE LAN PC	DELL	T3400	N/A
C	2.4G NB	DELL	E6430	N/A
D	5G NB	DELL	E6430	N/A
E	Smart phone	Samsung	Galaxy J2	A3LSMJ200F
F	Flash disk3.0	Transcend	JetFlash-700	N/A
G	Flash disk3.0	Transcend	JetFlash-700	N/A
H	PoE	GME	GME40B-480135FDA	N/A

For Radiated (below 1GHz):

Support Equipment				
No.	Equipment	Brand Name	Model Name	FCC ID
A	PoE	GME	GME40B-480135FDA	N/A
B	Notebook	DELL	E4300	N/A
C	Notebook	DELL	E4300	N/A
D	Notebook	DELL	E4300	N/A
E	Flash disk3.0	Silicon Power	B06	N/A
F	Flash disk3.0	Silicon Power	B06	N/A
G	Phone	SAMSUNG	Galaxy J2	N/A
H	Notebook	DELL	E4300	N/A

For Radiated (above 1GHz):

Support Equipment				
No.	Equipment	Brand Name	Model Name	FCC ID
A	Notebook	DELL	E4300	N/A
B	Test fixture	N/A	TJ-2	N/A

For RF Conducted:

Support Equipment				
No.	Equipment	Brand Name	Model Name	FCC ID
A	Notebook	DELL	E4300	N/A

2.6 Test Setup Diagram

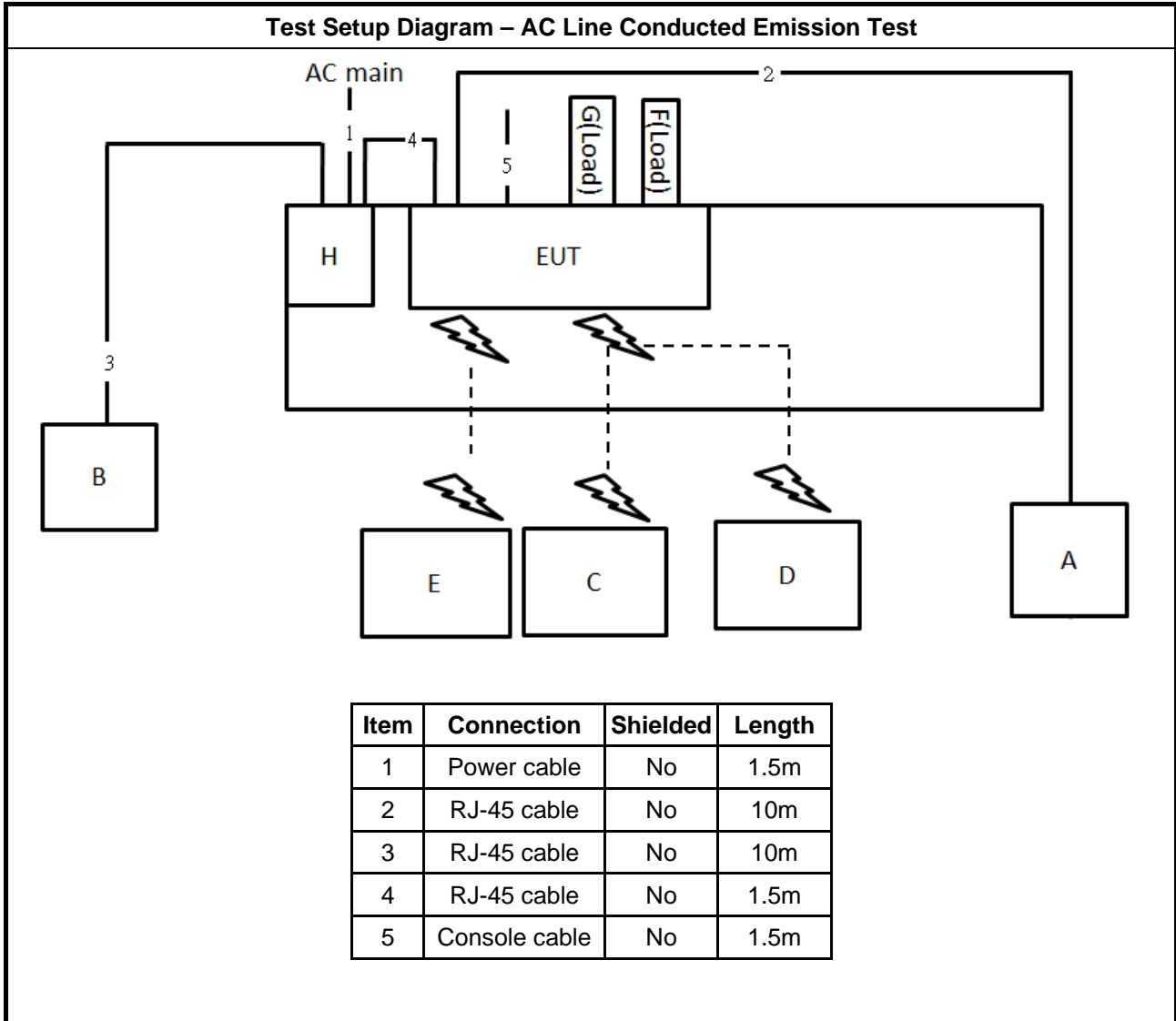

Test Setup Diagram - Radiated Test<1GHz

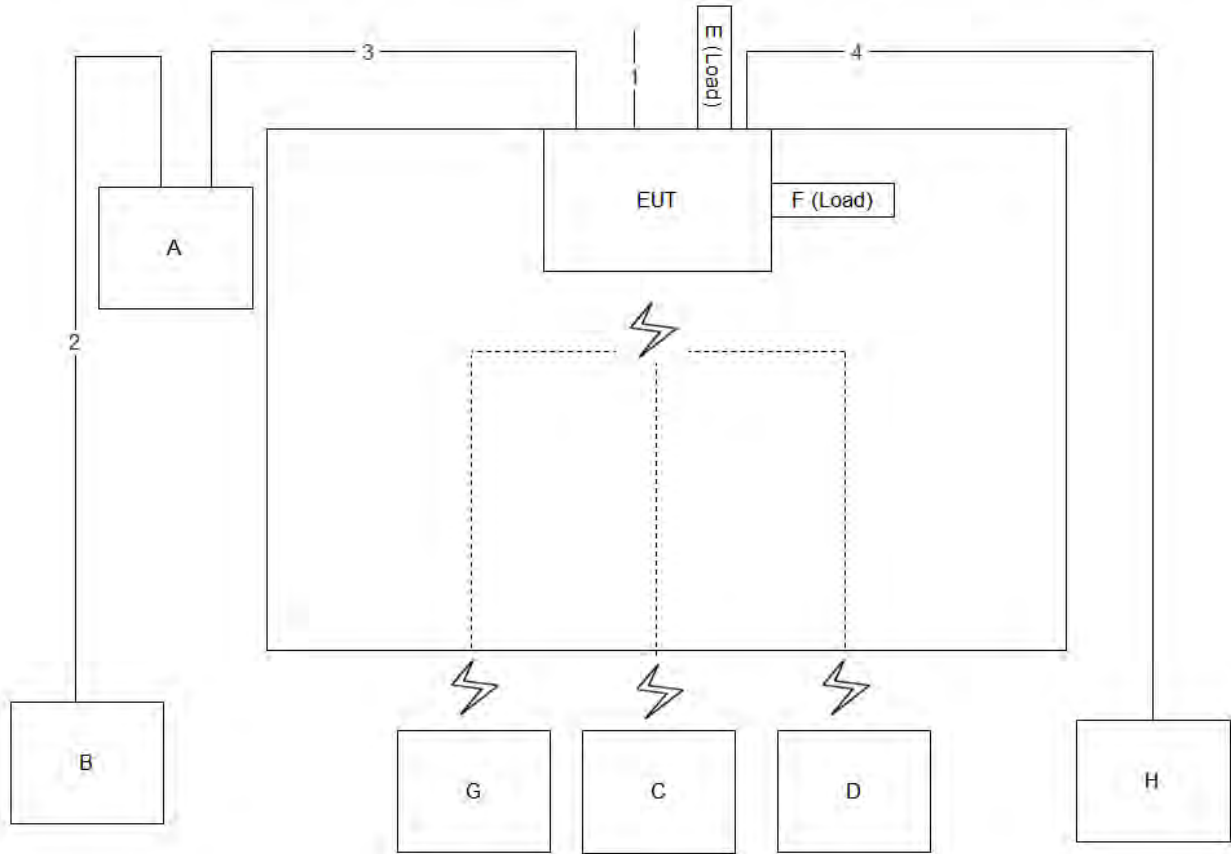

Item	Connection	Shielded	Length
1	Console cable	No	1.5m
2	RJ-45 cable	No	1.5m
3	RJ-45 cable	No	10m
4	RJ-45 cable	No	10m

Test Setup Diagram - Radiated Test > 1GHz

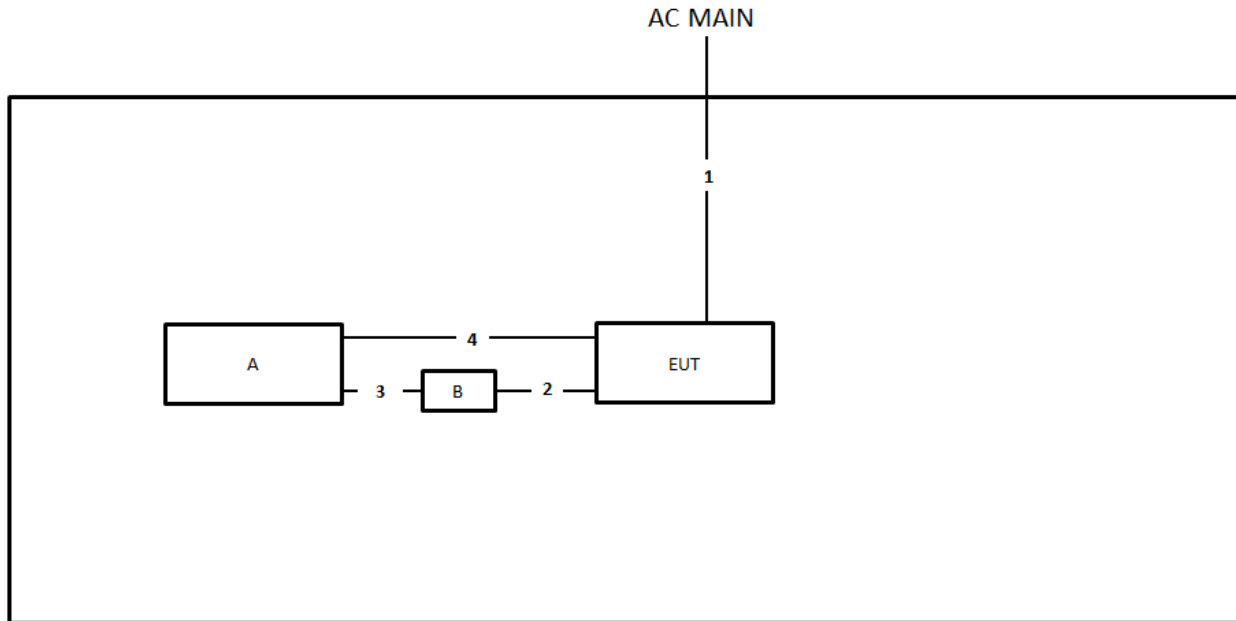

Item	Connection	Shielded	Length
1	Power cable	No	1.5m
2	Console cable	No	1.5m
3	Console cable	No	1m
4	RJ-45 cable	No	1.5m



3 Transmitter Test Result

3.1 AC Power-line Conducted Emissions

3.1.1 AC Power-line Conducted Emissions Limit

AC Power-line Conducted Emissions Limit		
Frequency Emission (MHz)	Quasi-Peak	Average
0.15-0.5	66 - 56 *	56 - 46 *
0.5-5	56	46
5-30	60	50

Note 1: * Decreases with the logarithm of the frequency.

3.1.2 Measuring Instruments

Refer a test equipment and calibration data table in this test report.

3.1.3 Test Procedures

Test Method
▪ Refer as ANSI C63.10-2013, clause 6.2 for AC power-line conducted emissions.

3.1.4 Test Setup

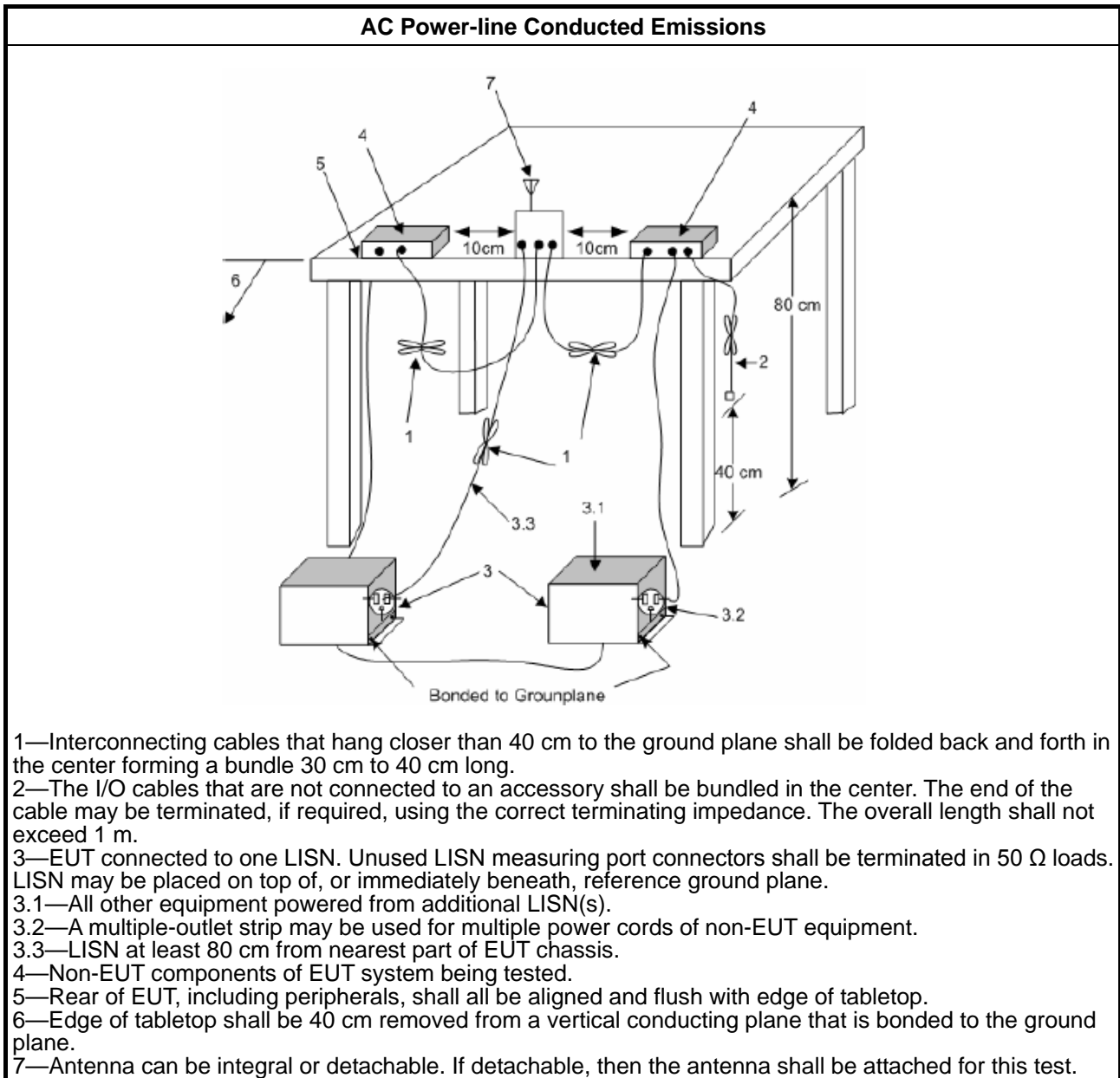

1.1.1. Measurement Results Calculation

The measured Level is calculated using:

- a. Corrected Reading: LISN Factor (LISN) + Attenuator (AT/AUX) + Cable Loss (CL) + Read Level (Raw) = Level
- b. Margin = -Limit + Level

3.1.5 Test Result of AC Power-line Conducted Emissions

Refer as Appendix A

3.2 DTS Bandwidth

3.2.1 6dB Bandwidth Limit

6dB Bandwidth Limit
Systems using digital modulation techniques:
<ul style="list-style-type: none"> ▪ 6 dB bandwidth \geq 500 kHz.

3.2.2 Measuring Instruments

Refer a test equipment and calibration data table in this test report.

3.2.3 Test Procedures

Test Method
<ul style="list-style-type: none"> ▪ For the emission bandwidth shall be measured using one of the options below:
<input checked="" type="checkbox"/> Refer as FCC KDB 558074, clause 8.2 & C63.10 clause 11.8.1 Option 1 for 6 dB bandwidth measurement.
<input type="checkbox"/> Refer as FCC KDB 558074, clause 8.2 & C63.10 clause 11.8.2 Option 2 for 6 dB bandwidth measurement.
<input type="checkbox"/> Refer as ANSI C63.10, clause 6.9.1 for occupied bandwidth testing.

3.2.4 Test Setup

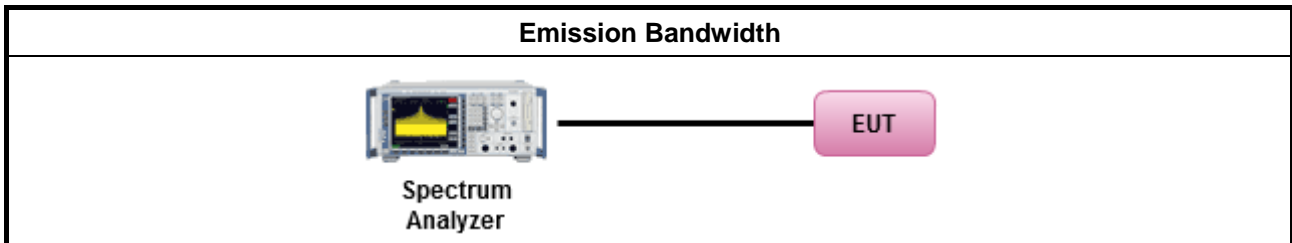

3.2.5 Test Result of Emission Bandwidth

Refer as Appendix B



3.3 Maximum Conducted Output Power

3.3.1 Maximum Conducted Output Power Limit

Maximum Conducted Output Power Limit	
	<ul style="list-style-type: none">▪ If $G_{TX} \leq 6$ dBi, then $P_{Out} \leq 30$ dBm (1 W)
	<ul style="list-style-type: none">▪ Point-to-multipoint systems (P2M): If $G_{TX} > 6$ dBi, then $P_{Out} = 30 - (G_{TX} - 6)$ dBm
	<ul style="list-style-type: none">▪ Point-to-point systems (P2P): If $G_{TX} > 6$ dBi, then $P_{Out} = 30 - (G_{TX} - 6)/3$ dBm
	<ul style="list-style-type: none">▪ Smart antenna system (SAS):
	<ul style="list-style-type: none">- Single beam: If $G_{TX} > 6$ dBi, then $P_{Out} = 30 - (G_{TX} - 6)/3$ dBm
	<ul style="list-style-type: none">- Overlap beam: If $G_{TX} > 6$ dBi, then $P_{Out} = 30 - (G_{TX} - 6)/3$ dBm
	<ul style="list-style-type: none">- Aggregate power on all beams: If $G_{TX} > 6$ dBi, then $P_{Out} = 30 - (G_{TX} - 6)/3 + 8$ dB dBm
P_{Out} = maximum peak conducted output power or maximum conducted output power in dBm, G_{TX} = the maximum transmitting antenna directional gain in dBi.	

3.3.2 Measuring Instruments

Refer a test equipment and calibration data table in this test report.



3.3.3 Test Procedures

Test Method	
<ul style="list-style-type: none"> ▪ Maximum Peak Conducted Output Power 	
	<input type="checkbox"/> Refer as FCC KDB 558074, clause 8.3.1.1 & C63.10 clause 11.9.1.1 (RBW ≥ EBW method).
	<input type="checkbox"/> Refer as FCC KDB 558074, clause 8.3.1.3 & C63.10 clause 11.9.1.3 (peak power meter).
<ul style="list-style-type: none"> ▪ Maximum Conducted Output Power 	
[duty cycle ≥ 98% or external video / power trigger]	
	<input type="checkbox"/> Refer as FCC KDB 558074, clause 8.3.2.2 & C63.10 clause 11.9.2.2.2 Method AVGSA-1.
	<input type="checkbox"/> Refer as FCC KDB 558074, clause 8.3.2.2 & C63.10 clause 11.9.2.2.3 Method AVGSA-1A. (alternative)
duty cycle < 98% and average over on/off periods with duty factor	
	<input type="checkbox"/> Refer as FCC KDB 558074, clause 8.3.2.2 & C63.10 clause 11.9.2.2.4 Method AVGSA-2.
	<input type="checkbox"/> Refer as FCC KDB 558074, clause 8.3.2.2 & C63.10 clause 11.9.2.2.5 Method AVGSA-2A (alternative)
	<input type="checkbox"/> Refer as FCC KDB 558074, clause 8.3.2.2 & C63.10 clause 11.9.2.2.6 Method AVGSA-3
	<input type="checkbox"/> Refer as FCC KDB 558074, clause 8.3.2.2 & C63.10 clause 11.9.2.2.7 Method AVGSA-3A (alternative)
Measurement using a power meter (PM)	
	<input type="checkbox"/> Refer as FCC KDB 558074, clause 8.3.2.3 & C63.10 clause 11.9.2.3.1 Method AVGPM (using an RF average power meter).
	<input checked="" type="checkbox"/> Refer as FCC KDB 558074, clause 8.3.2.3 & C63.10 clause 11.9.2.3.2 Method AVGPM-G (using an gate RF average power meter).
<ul style="list-style-type: none"> ▪ For conducted measurement. 	
	<ul style="list-style-type: none"> ▪ If the EUT supports multiple transmit chains using options given below: Refer as FCC KDB 662911, In-band power measurements. Using the measure-and-sum approach, measured all transmit ports individually. Sum the power (in linear power units e.g., mW) of all ports for each individual sample and save them.
	<ul style="list-style-type: none"> ▪ If multiple transmit chains, EIRP calculation could be following as methods: $P_{total} = P_1 + P_2 + \dots + P_n$ (calculated in linear unit [mW] and transfer to log unit [dBm]) $EIRP_{total} = P_{total} + DG$

3.3.4 Test Setup

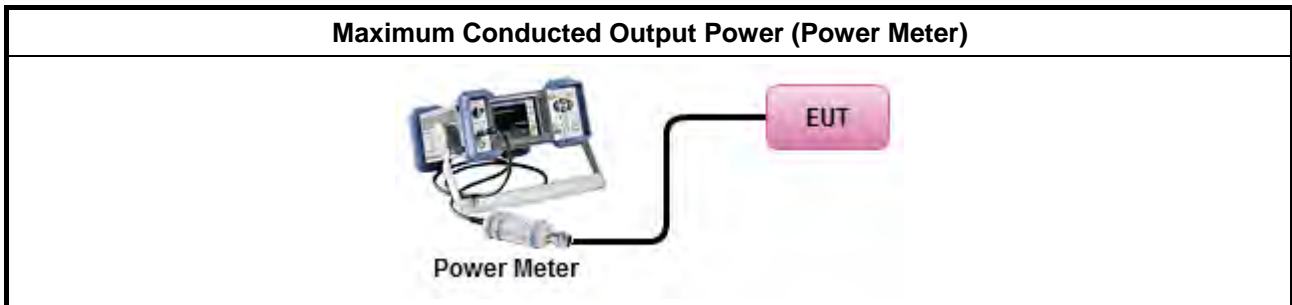

3.3.5 Test Result of Maximum Conducted Output Power

Refer as Appendix C



3.4 Power Spectral Density

3.4.1 Power Spectral Density Limit

Power Spectral Density Limit
<ul style="list-style-type: none"> Power Spectral Density (PSD) ≤ 8 dBm/3kHz

3.4.2 Measuring Instruments

Refer a test equipment and calibration data table in this test report.

3.4.3 Test Procedures

Test Method
<ul style="list-style-type: none"> Peak power spectral density procedures that the same method as used to determine the conducted output power. If maximum peak conducted output power was measured to demonstrate compliance to the output power limit, then the peak PSD procedure below (Method PKPSD) shall be used. If maximum conducted output power was measured to demonstrate compliance to the output power limit, then one of the average PSD procedures shall be used, as applicable based on the following criteria (the peak PSD procedure is also an acceptable option).
<input checked="" type="checkbox"/> Refer as FCC KDB 558074, clause 8.4 & C63.10 clause 11.10 Method Max. PSD. [duty cycle ≥ 98% or external video / power trigger]
<ul style="list-style-type: none"> For conducted measurement.
<ul style="list-style-type: none"> If The EUT supports multiple transmit chains using options given below: <ul style="list-style-type: none"> <input type="checkbox"/> Option 1: Measure and sum the spectra across the outputs. Refer as FCC KDB 662911, In-band power spectral density (PSD). Sample all transmit ports simultaneously using a spectrum analyzer for each transmit port. Where the trace bin-by-bin of each transmit port summing can be performed. (i.e., in the first spectral bin of output 1 is summed with that in the first spectral bin of output 2 and that from the first spectral bin of output 3, and so on up to the NTX output to obtain the value for the first frequency bin of the summed spectrum.). Add up the amplitude (power) values for the different transmit chains and use this as the new data trace. <input type="checkbox"/> Option 2: Measure and sum spectral maxima across the outputs. With this technique, spectra are measured at each output of the device at the required resolution bandwidth. The maximum value (peak) of each spectrum is determined. These maximum values are then summed mathematically in linear power units across the outputs. These operations shall be performed separately over frequency spans that have different out-of-band or spurious emission limits, <input type="checkbox"/> Option 3: Measure and add 10 log(N) dB, where N is the number of transmit chains. Refer as FCC KDB 662911, In-band power spectral density (PSD). Performed at each transmit chains and each transmit chains shall be compared with the limit have been reduced with 10 log(N). Or each transmit chains shall be add 10 log(N) to compared with the limit.

3.4.4 Test Setup

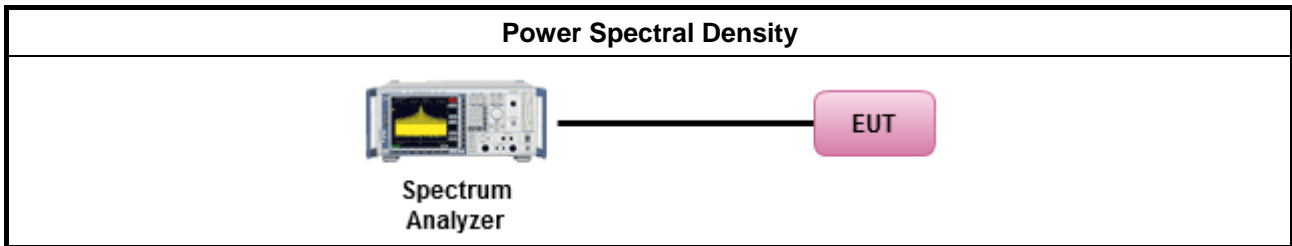

3.4.5 Test Result of Power Spectral Density

Refer as Appendix D

3.5 Emissions in Non-restricted Frequency Bands

3.5.1 Emissions in Non-restricted Frequency Bands Limit

Un-restricted Band Emissions Limit	
RF output power procedure	Limit (dBc)
Peak output power procedure	20
Average output power procedure	30

Note 1: If the peak output power procedure is used to measure the fundamental emission power to demonstrate compliance to requirements, then the peak conducted output power measured within any 100 kHz outside the authorized frequency band shall be attenuated by at least 20 dB relative to the maximum measured in-band peak PSD level.

Note 2: If the average output power procedure is used to measure the fundamental emission power to demonstrate compliance to requirements, then the power in any 100 kHz outside of the authorized frequency band shall be attenuated by at least 30 dB relative to the maximum measured in-band average PSD level.

3.5.2 Measuring Instruments

Refer a test equipment and calibration data table in this test report.

3.5.3 Test Procedures

Test Method
<ul style="list-style-type: none"> Refer as FCC KDB 558074, clause 8.5 for unwanted emissions into non-restricted bands.

3.5.4 Test Setup

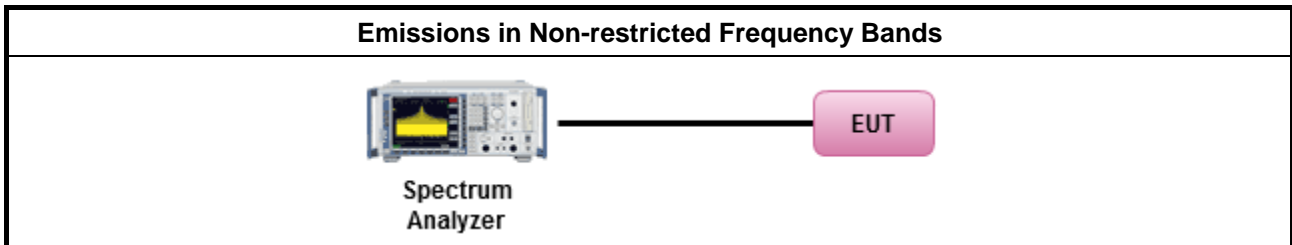

3.5.5 Test Result of Emissions in Non-restricted Frequency Bands

Refer as Appendix E



3.6 Emissions in Restricted Frequency Bands

3.6.1 Emissions in Restricted Frequency Bands Limit

Restricted Band Emissions Limit			
Frequency Range (MHz)	Field Strength (uV/m)	Field Strength (dBuV/m)	Measure Distance (m)
0.009~0.490	2400/F(kHz)	48.5 - 13.8	300
0.490~1.705	24000/F(kHz)	33.8 - 23	30
1.705~30.0	30	29	30
30~88	100	40	3
88~216	150	43.5	3
216~960	200	46	3
Above 960	500	54	3

Note 1: Test distance for frequencies at or above 30 MHz, measurements may be performed at a distance other than the limit distance provided they are not performed in the near field and the emissions to be measured can be detected by the measurement equipment. When performing measurements at a distance other than that specified, the results shall be extrapolated to the specified distance using an extrapolation factor of 20 dB/decade (inverse of linear distance for field-strength measurements, inverse of linear distance-squared for power-density measurements).

Note 2: Test distance for frequencies at below 30 MHz, measurements may be performed at a distance closer than the EUT limit distance; however, an attempt should be made to avoid making measurements in the near field. When performing measurements below 30 MHz at a closer distance than the limit distance, the results shall be extrapolated to the specified distance by either making measurements at a minimum of two or more distances on at least one radial to determine the proper extrapolation factor or by using the square of an inverse linear distance extrapolation factor (40 dB / decade). The test report shall specify the extrapolation method used to determine compliance of the EUT.

Note 3: Using the distance of 1m during the test for above 18 GHz, and the test value to correct for the distance factor at 3m.

3.6.2 Measuring Instruments

Refer a test equipment and calibration data table in this test report.



3.6.3 Test Procedures

Test Method	
<ul style="list-style-type: none"> ▪ The average emission levels shall be measured in [duty cycle ≥ 98 or duty factor]. 	
<ul style="list-style-type: none"> ▪ Refer as ANSI C63.10, clause 6.10.3 band-edge testing shall be performed at the lowest frequency channel and highest frequency channel within the allowed operating band. 	
<ul style="list-style-type: none"> ▪ For the transmitter unwanted emissions shall be measured using following options below: 	
	<ul style="list-style-type: none"> ▪ Refer as FCC KDB 558074, clause 8.6 for unwanted emissions into restricted bands.
	<input type="checkbox"/> Refer as FCC KDB 558074, clause 8.6 & C63.10 clause 11.12.2.5.1(trace averaging for duty cycle ≥98%).
	<input type="checkbox"/> Refer as FCC KDB 558074, clause 8.6 & C63.10 clause 11.12.2.5.2(trace averaging + duty factor).
	<input checked="" type="checkbox"/> Refer as FCC KDB 558074, clause 8.6 & C63.10 clause 11.12.2.5.3(Reduced VBW≥1/T).
	<input type="checkbox"/> Refer as ANSI C63.10, clause 11.12.2.5.3 (Reduced VBW). VBW ≥ 1/T, where T is pulse time.
	<input type="checkbox"/> Refer as ANSI C63.10, clause 7.5 average value of pulsed emissions.
	<input checked="" type="checkbox"/> Refer as FCC KDB 558074, clause 8.6 & C63.10 clause 11.12.2.4 measurement procedure peak limit.
<ul style="list-style-type: none"> ▪ For the transmitter band-edge emissions shall be measured using following options below: 	
	<ul style="list-style-type: none"> ▪ Refer as FCC KDB 558074 clause 8.7 & c63.10 clause 11.13.1, When the performing peak or average radiated measurements, emissions within 2 MHz of the authorized band edge may be measured using the marker-delta method described below.
	<ul style="list-style-type: none"> ▪ Refer as FCC KDB 558074, clause 8.7 (ANSI C63.10, clause 6.10.6) for marker-delta method for band-edge measurements.
	<ul style="list-style-type: none"> ▪ Refer as FCC KDB 558074, clause 8.7 for narrower resolution bandwidth (100kHz) using the band power and summing the spectral levels (i.e., 1 MHz).
	<ul style="list-style-type: none"> ▪ For conducted unwanted emissions into restricted bands (absolute emission limits). Devices with multiple transmit chains using options given below: (1) Measure and sum the spectra across the outputs or (2) Measure and add 10 log(N) dB
	<ul style="list-style-type: none"> ▪ For FCC KDB 662911 The methodology described here may overestimate array gain, thereby resulting in apparent failures to satisfy the out-of-band limits even if the device is actually compliant. In such cases, compliance may be demonstrated by performing radiated tests around the frequencies at which the apparent failures occurred.

3.6.4 Test Setup

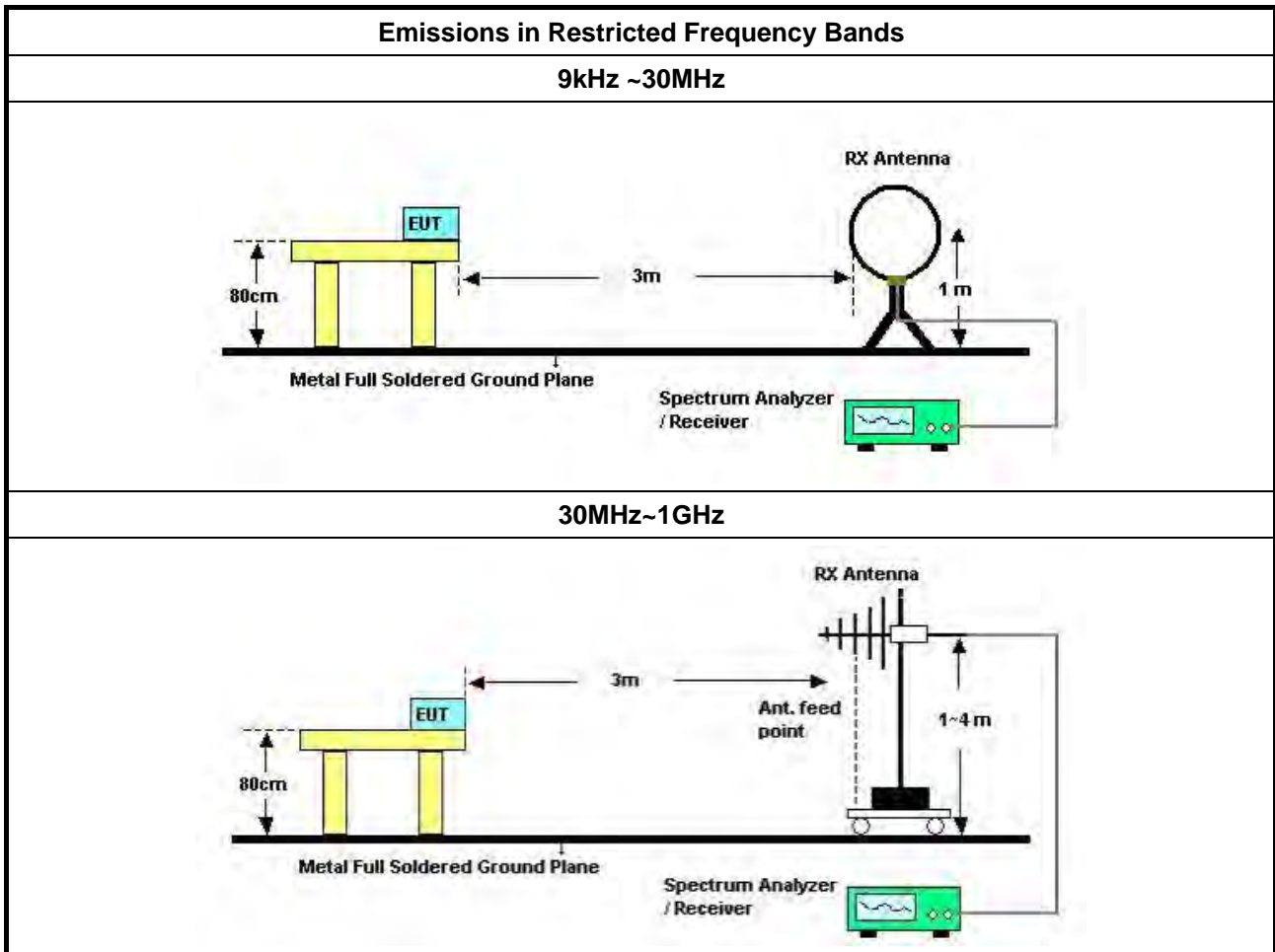

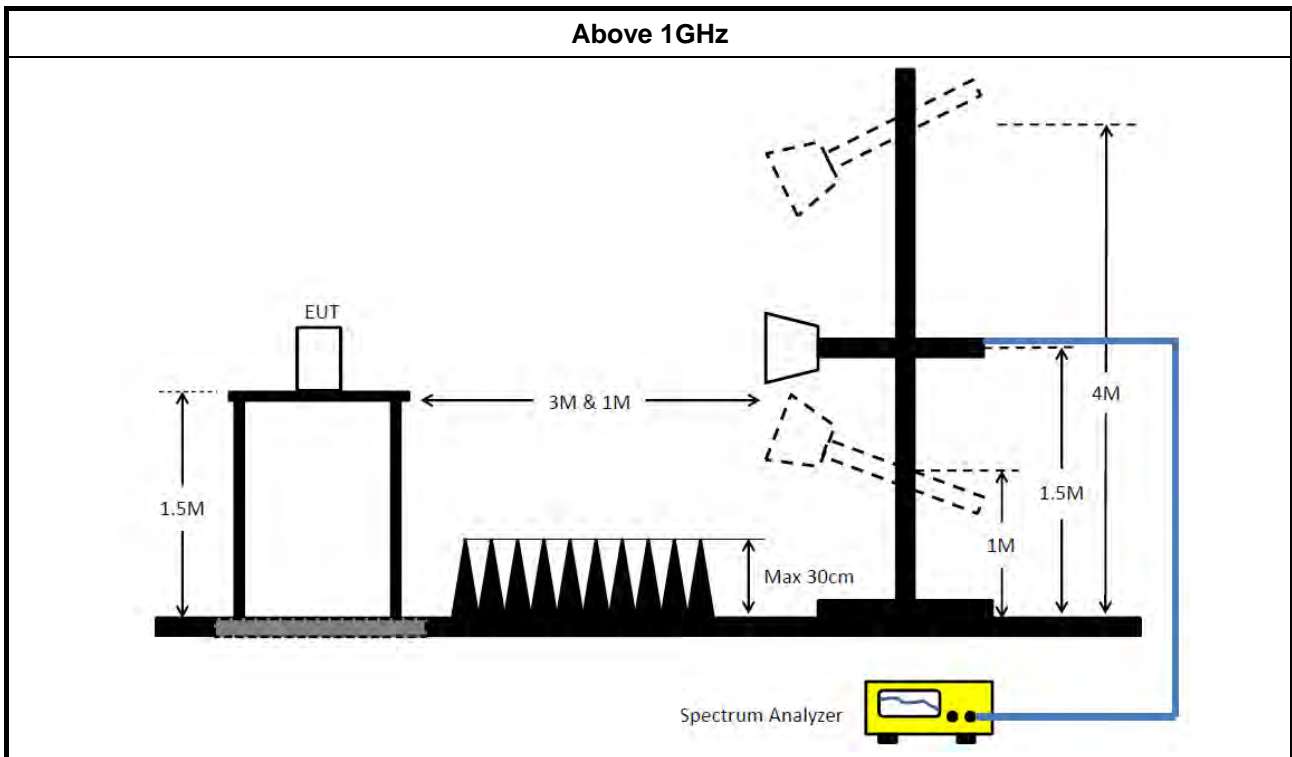

3.6.5 Measurement Results Calculation

The measured Level is calculated using:

Corrected Reading: Antenna factor (AF) + Cable loss (CL) + Read level (Raw) - Preamp factor (PA)(if applicable) = Level.

3.6.6 Emissions in Restricted Frequency Bands (Below 30MHz)

There is a comparison data of both open-field test site and alternative test site - semi-Anechoic chamber according to KDB414788 Radiated Test Site, and the result came out very similar.

All amplitude of spurious emissions that are attenuated by more than 20 dB below the permissible value has no need to be reported.

The radiated emissions were investigated from 9 kHz or the lowest frequency generated within the device, up to the 10th harmonic or 40 GHz, whichever is appropriate.

3.6.7 Test Result of Emissions in Restricted Frequency Bands

Refer as Appendix F



4 Test Equipment and Calibration Data

Instrument	Brand	Model No.	Serial No.	Characteristics	Calibration Date	Calibration Due Date	Remark
EMI Receiver	Agilent	N9038A	My52260123	9kHz ~ 8.4GHz	Feb. 26, 2020	Feb. 25, 2021	Conduction (CO01-CB)
LISN	F.C.C.	FCC-LISN-50-16-2	04083	150kHz ~ 100MHz	Dec. 25, 2019	Dec. 24, 2020	Conduction (CO01-CB)
LISN	Schwarzbeck	NSLK 8127	8127647	9kHz ~ 30MHz	Feb. 25, 2020	Feb. 24, 2021	Conduction (CO01-CB)
Pulse Limiter	Rohde&Schwarz	ESH3-Z2	100430	9kHz ~ 30MHz	Jan. 31, 2020	Jan. 30, 2021	Conduction (CO01-CB)
COND Cable	Woken	Cable	Low cable-CO01	9kHz ~ 30MHz	May 20, 2020	May 19, 2021	Conduction (CO01-CB)
Software	SPORTON	SENSE	V5.10	-	N.C.R.	N.C.R.	Conduction (CO01-CB)
Loop Antenna	Teseq	HLA 6120	24155	9kHz - 30 MHz	Apr. 14, 2021	Apr. 13, 2022	Radiation (03CH03-CB)
3m Semi Anechoic Chamber NSA	TDK	SAC-3M	03CH03-CB	30 MHz ~ 1 GHz	Jan. 27, 2021	Jan. 26, 2022	Radiation (03CH03-CB)
Bilog Antenna with 6 dB attenuator	Schaffner & EMC	CBL6112B & N-6-06	2928 & AT-N0608	20MHz ~ 2GHz	Feb. 22, 2021	Feb. 21, 2022	Radiation (03CH03-CB)
Pre-Amplifier	Agilent	8447D	2944A10259	9kHz ~ 1.3GHz	Jan. 11, 2021	Jan. 10, 2022	Radiation (03CH03-CB)
Spectrum Analyzer	R&S	FSP40	100019	9kHz ~ 40GHz	Jun. 04, 2021	Jun. 03, 2022	Radiation (03CH03-CB)
EMI Test Receiver	R&S	ESCS	826547/017	9kHz ~ 2.75GHz	Jun. 21, 2021	Jun. 20, 2022	Radiation (03CH03-CB)
RF Cable-low	Woken	RG402	Low Cable-02+29	30MHz ~ 1GHz	Aug. 20, 2021	Aug. 19, 2022	Radiation (03CH03-CB)
Test Software	SPORTON	SENSE	V5.10	-	N.C.R.	N.C.R.	Radiation (03CH03-CB)
3m Semi Anechoic Chamber VSWR	TDK	SAC-3M	03CH04-CB	1GHz ~18GHz 3m	Feb. 26, 2020	Feb. 25, 2021	Radiation (03CH04-CB)
Horn Antenna	ETS · Lindgren	3115	00143147	750MHz~18GHz	Oct. 23, 2020	Oct. 22, 2021	Radiation (03CH04-CB)
Horn Antenna	Schwarzbeck	BBHA 9170	BBHA9170252	15GHz ~ 40GHz	Jul. 21, 2020	Jul. 20, 2021	Radiation (03CH04-CB)
Pre-Amplifier	Agilent	83017A	MY53270063	0.5GHz~26.5GHz	Jul. 14, 2020	Jul. 13, 2021	Radiation (03CH04-CB)
Pre-Amplifier	MITEQ	TTA1840-35-HG	1864479	18GHz ~ 40GHz	Jul. 08, 2020	Jul. 07, 2021	Radiation (03CH04-CB)



Instrument	Brand	Model No.	Serial No.	Characteristics	Calibration Date	Calibration Due Date	Remark
Spectrum Analyzer	R&S	FSP40	100142	9kHz~40GHz	Dec. 18, 2019	Dec. 17, 2020	Radiation (03CH04-CB)
Signal Analyzer	R&S	FSV40	101904	9kHz ~ 40GHz	May 12, 2020	May 11, 2021	Radiation (03CH04-CB)
RF Cable-high	Woken	RG402	High Cable-21	1GHz - 18GHz	Oct. 05, 2020	Oct. 04, 2021	Radiation (03CH04-CB)
RF Cable-high	Woken	RG402	High Cable-21+67	1GHz - 18GHz	Nov. 05, 2020	Nov. 04, 2021	Radiation (03CH04-CB)
RF Cable-high	Woken	RG402	High Cable-40G#1	18GHz ~ 40 GHz	Jul. 16, 2020	Jul. 15, 2021	Radiation (03CH04-CB)
RF Cable-high	Woken	RG402	High Cable-40G#2	18GHz ~ 40 GHz	Jul. 16, 2020	Jul. 15, 2021	Radiation (03CH04-CB)
Test Software	SPORTON	SENSE	V5.10	-	N.C.R.	N.C.R.	Radiation (03CH04-CB)
Signal Analyzer	R&S	FSV40	101903	9kHz ~ 40GHz	May 14, 2020	May 13, 2021	Conducted (TH03-CB)
Power Sensor	Anritsu	MA2411B	1726195	300MHz~40GHz	Aug. 17, 2020	Aug. 16, 2021	Conducted (TH03-CB)
Power Meter	Anritsu	ML2495A	1035008	300MHz~40GHz	Aug. 17, 2020	Aug. 16, 2021	Conducted (TH03-CB)
RF Cable-high	Woken	RG402	High Cable-11	1 GHz ~18 GHz	Oct. 05, 2020	Oct. 04, 2021	Conducted (TH03-CB)
RF Cable-high	Woken	RG402	High Cable-12	1 GHz ~18 GHz	Oct. 05, 2020	Oct. 04, 2021	Conducted (TH03-CB)
RF Cable-high	Woken	RG402	High Cable-13	1 GHz ~18 GHz	Oct. 05, 2020	Oct. 04, 2021	Conducted (TH03-CB)
RF Cable-high	Woken	RG402	High Cable-14	1 GHz ~18 GHz	Oct. 05, 2020	Oct. 04, 2021	Conducted (TH03-CB)
RF Cable-high	Woken	RG402	High Cable-15	1 GHz ~18 GHz	Oct. 05, 2020	Oct. 04, 2021	Conducted (TH03-CB)
Test Software	SPORTON	SENSE	V5.10	-	N.C.R.	N.C.R.	Conducted (TH03-CB)

Note: Calibration Interval of instruments listed above is one year.

N.C.R. means Non-Calibration required.



Summary

Mode	Result	Type	Freq (Hz)	Level (dBuV)	Limit (dBuV)	Margin (dB)	Condition
Mode 2	Pass	AV	500k	38.80	46.00	-7.20	Line

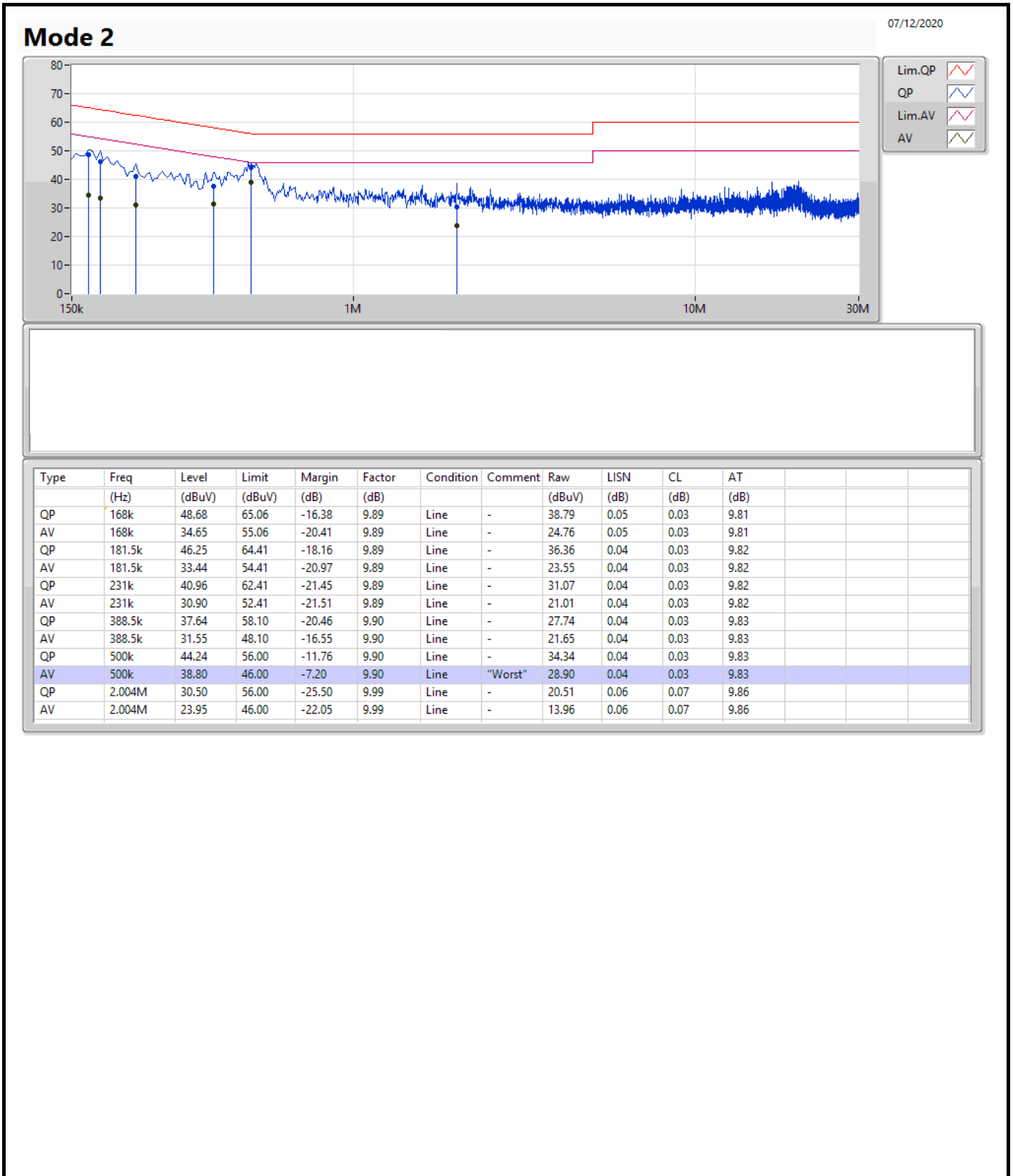

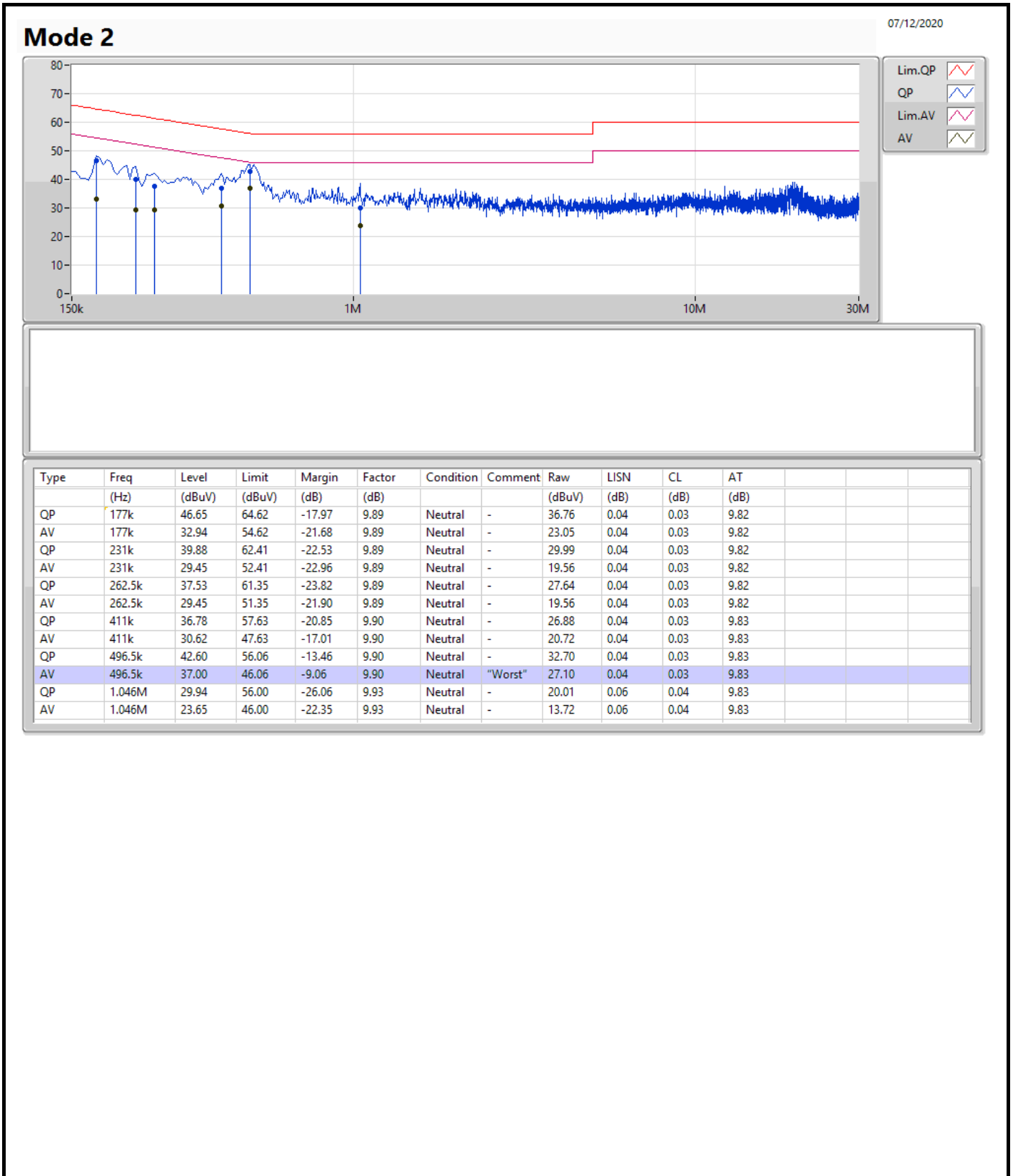

Summary

Mode	Max-N dB (Hz)	Max-OBW (Hz)	ITU-Code	Min-N dB (Hz)	Min-OBW (Hz)
2.4-2.4835GHz	-	-	-	-	-
BT-LE(1Mbps)	700k	1.052M	1M05F1D	692.5k	1.049M
BT-LE(2Mbps)	1.133M	2.051M	2M05F1D	1.13M	2.036M

Max-N dB = Maximum 6dB down bandwidth; **Max-OBW** = Maximum 99% occupied bandwidth;
Min-N dB = Minimum 6dB down bandwidth; **Min-OBW** = Minimum 99% occupied bandwidth;

Result

Mode	Result	Limit (Hz)	Port 1-N dB (Hz)	Port 1-OBW (Hz)
BT-LE(1Mbps)	-	-	-	-
2402MHz	Pass	500k	692.5k	1.049M
2440MHz	Pass	500k	698.75k	1.051M
2480MHz	Pass	500k	700k	1.052M
BT-LE(2Mbps)	-	-	-	-
2402MHz	Pass	500k	1.133M	2.036M
2440MHz	Pass	500k	1.133M	2.051M
2480MHz	Pass	500k	1.13M	2.036M

Port X-N dB = Port X 6dB down bandwidth; **Port X-OBW** = Port X 99% occupied bandwidth;

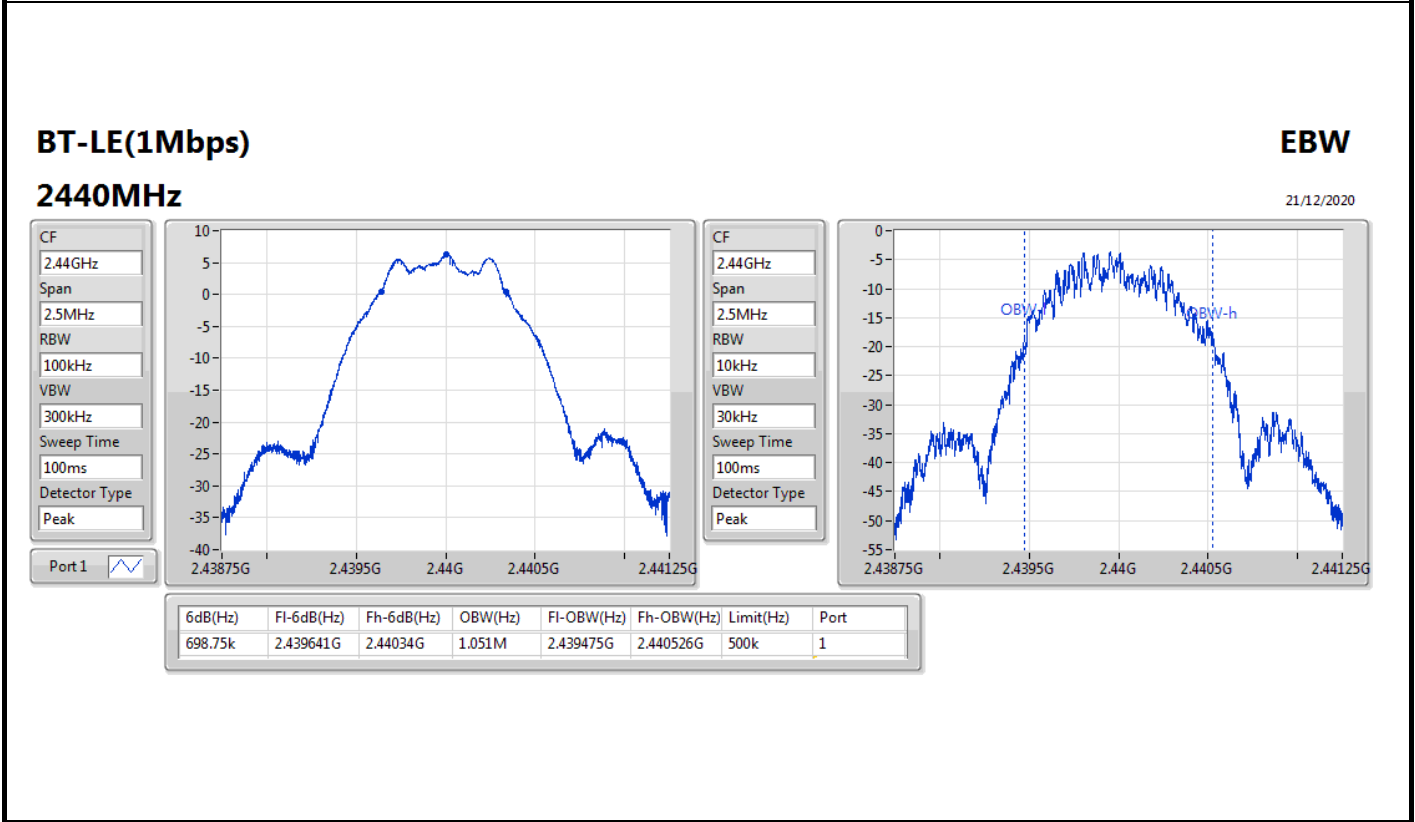
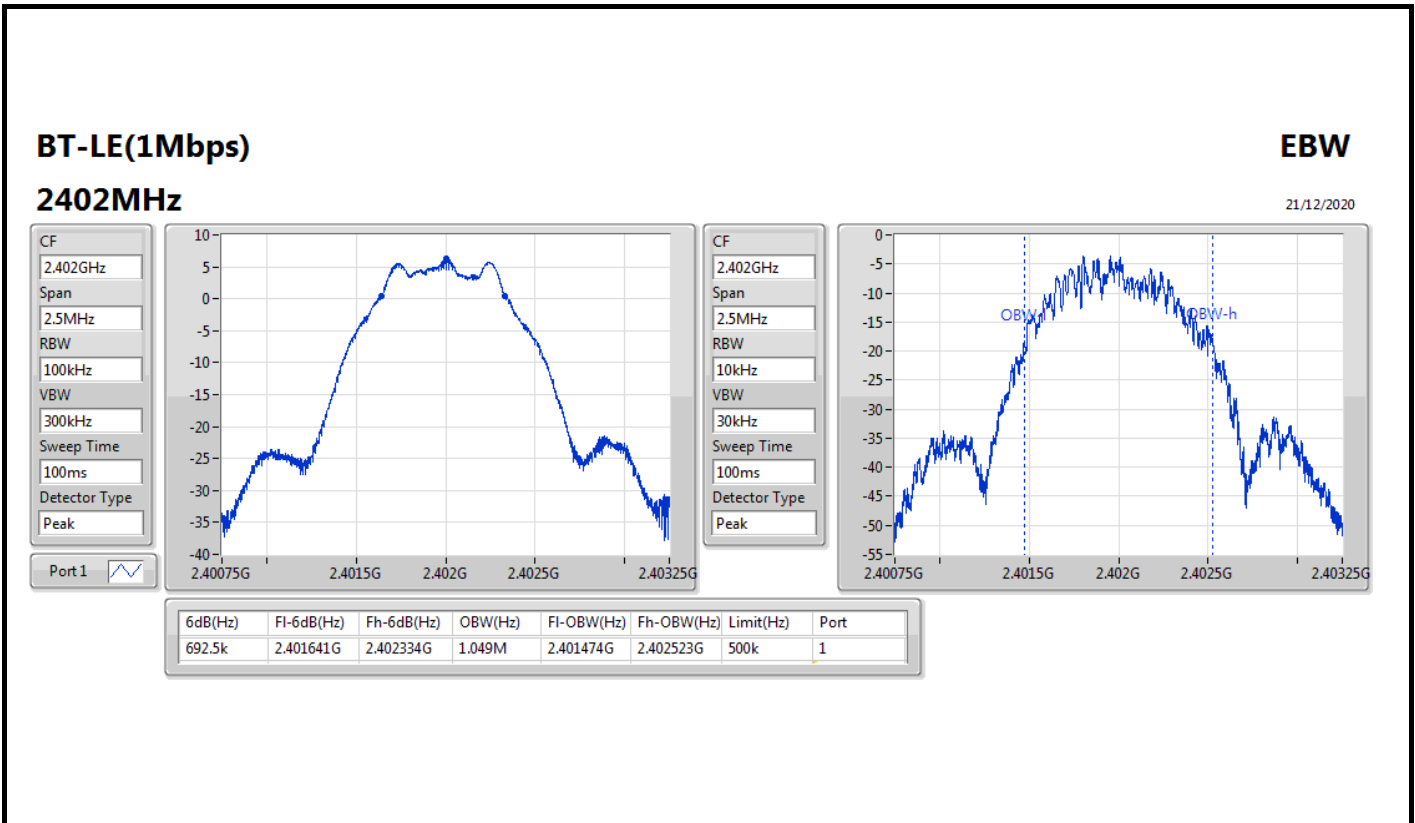

BT-LE(1Mbps)

EBW

2480MHz

21/12/2020

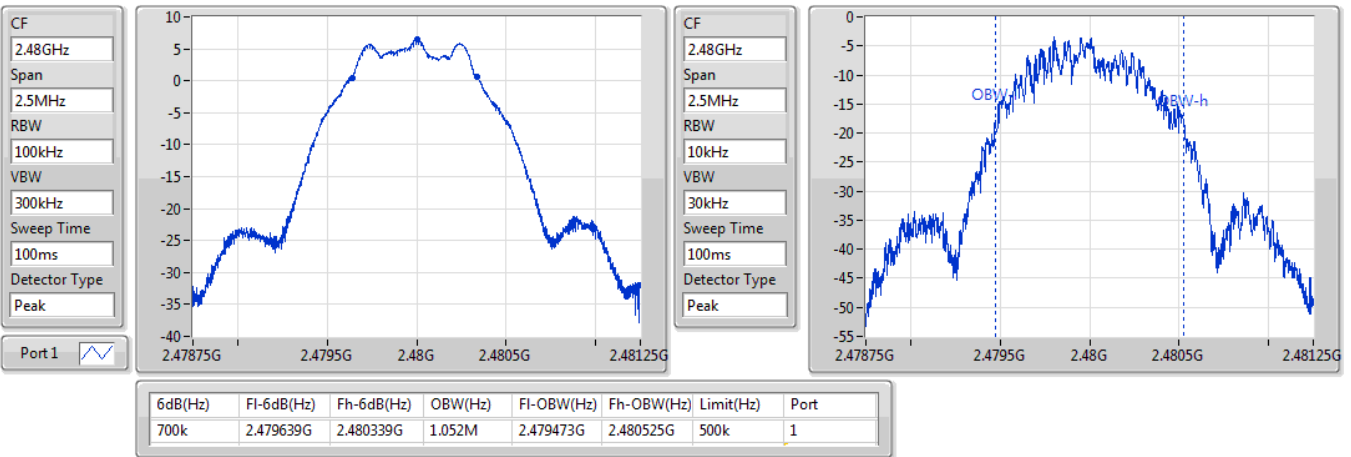

BT-LE(2Mbps)

EBW

2402MHz

21/12/2020

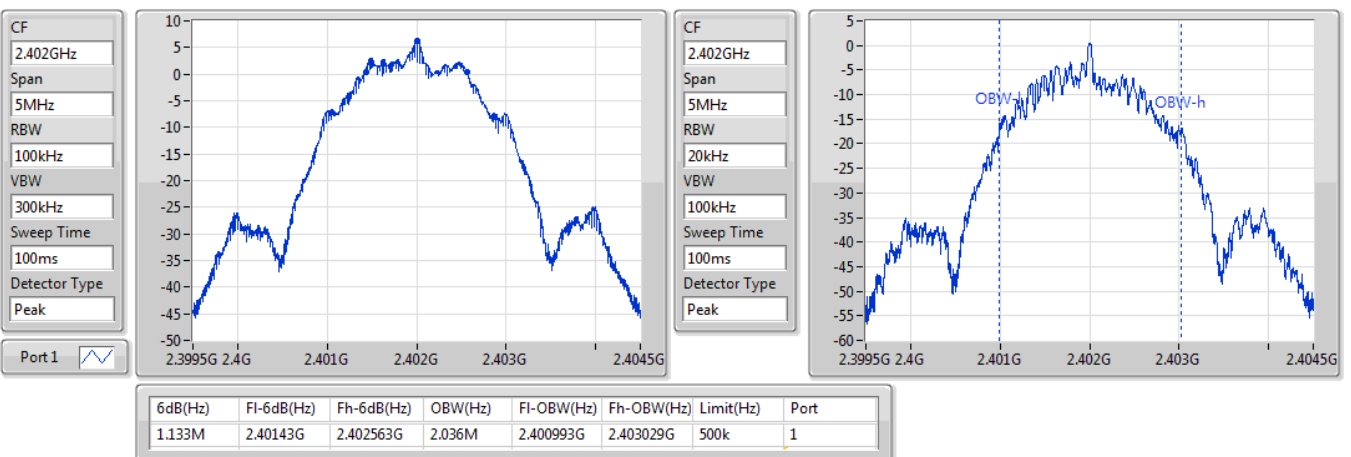

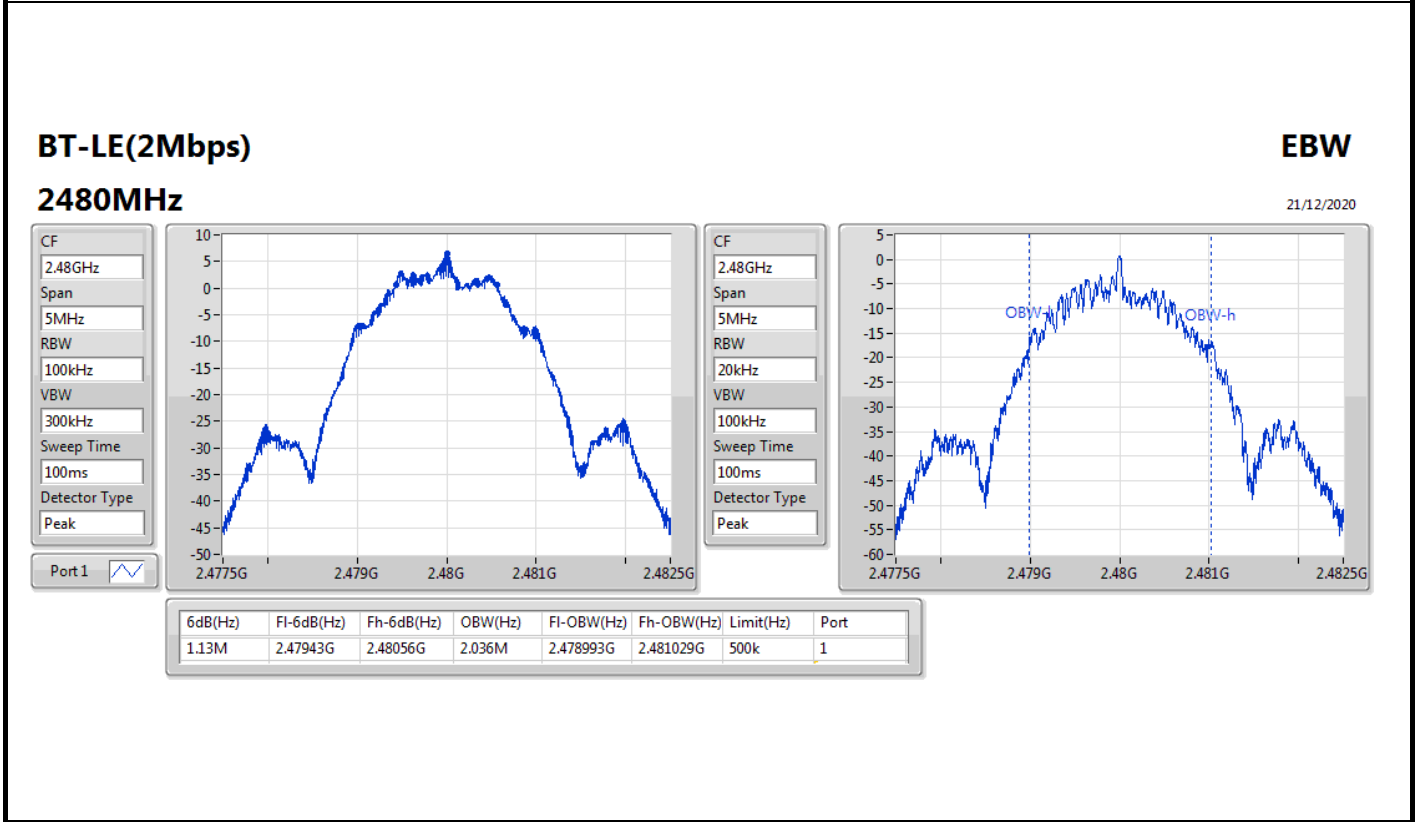
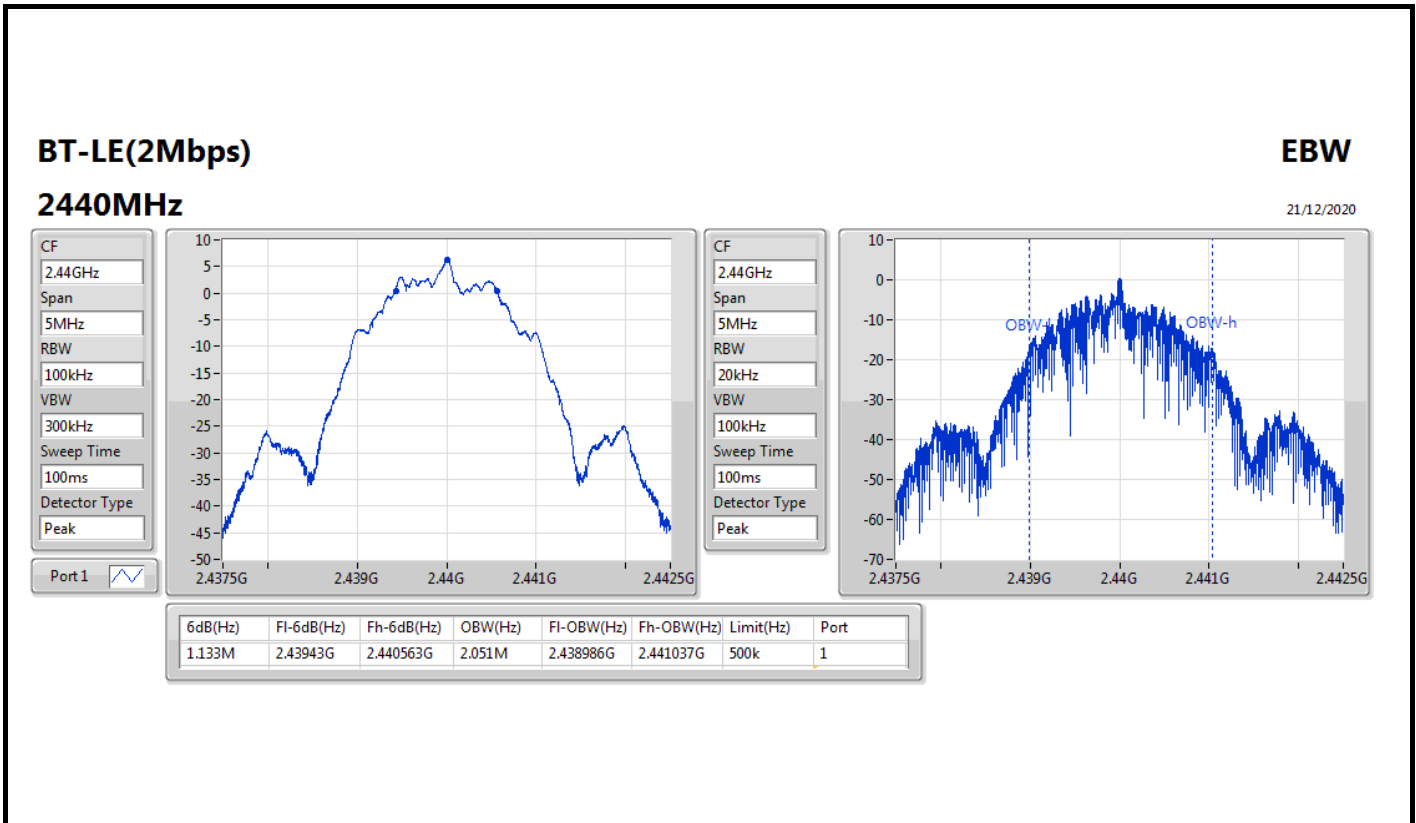



Summary

Mode	Power (dBm)	Power (W)
2.4-2.4835GHz	-	-
BT-LE(1Mbps)	6.44	0.00441
BT-LE(2Mbps)	6.22	0.00419



Result

Mode	Result	Gain (dBi)	Power (dBm)	Power Limit (dBm)
BT-LE(1Mbps)	-	-	-	-
2402MHz	Pass	5.19	6.35	30.00
2440MHz	Pass	5.19	6.44	30.00
2480MHz	Pass	5.19	6.35	30.00
BT-LE(2Mbps)	-	-	-	-
2402MHz	Pass	5.19	6.11	30.00
2440MHz	Pass	5.19	6.22	30.00
2480MHz	Pass	5.19	6.20	30.00

DG = Directional Gain; **Port X** = Port X output power



Summary

Mode	PD (dBm/RBW)
2.4-2.4835GHz	-
BT-LE(1Mbps)	-9.12
BT-LE(2Mbps)	-11.77

RBW=3 kHz.



Result

Mode	Result	Gain (dBi)	PD (dBm/RBW)	PD Limit (dBm/RBW)
BT-LE(1Mbps)	-	-	-	-
2402MHz	Pass	5.19	-9.38	8.00
2440MHz	Pass	5.19	-9.41	8.00
2480MHz	Pass	5.19	-9.12	8.00
BT-LE(2Mbps)	-	-	-	-
2402MHz	Pass	5.19	-11.86	8.00
2440MHz	Pass	5.19	-12.14	8.00
2480MHz	Pass	5.19	-11.77	8.00

DG = Directional Gain; RBW=3 kHz;

PD = trace bin-by-bin of each transmits port summing can be performed maximum power density; Port X = Port X power density;

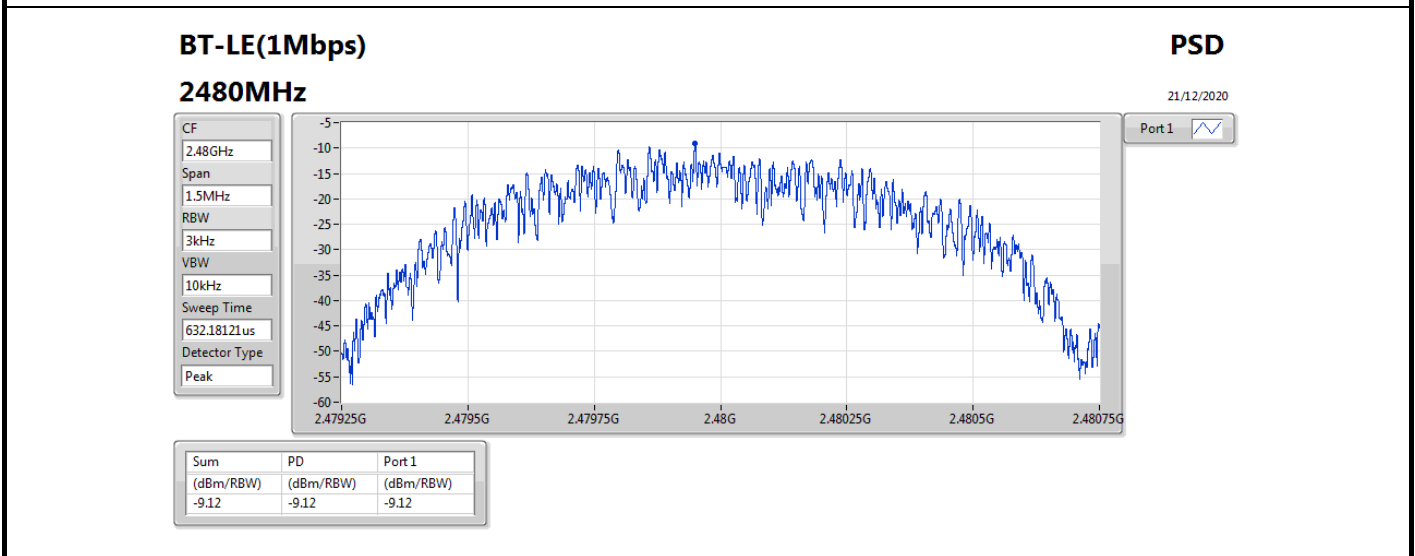
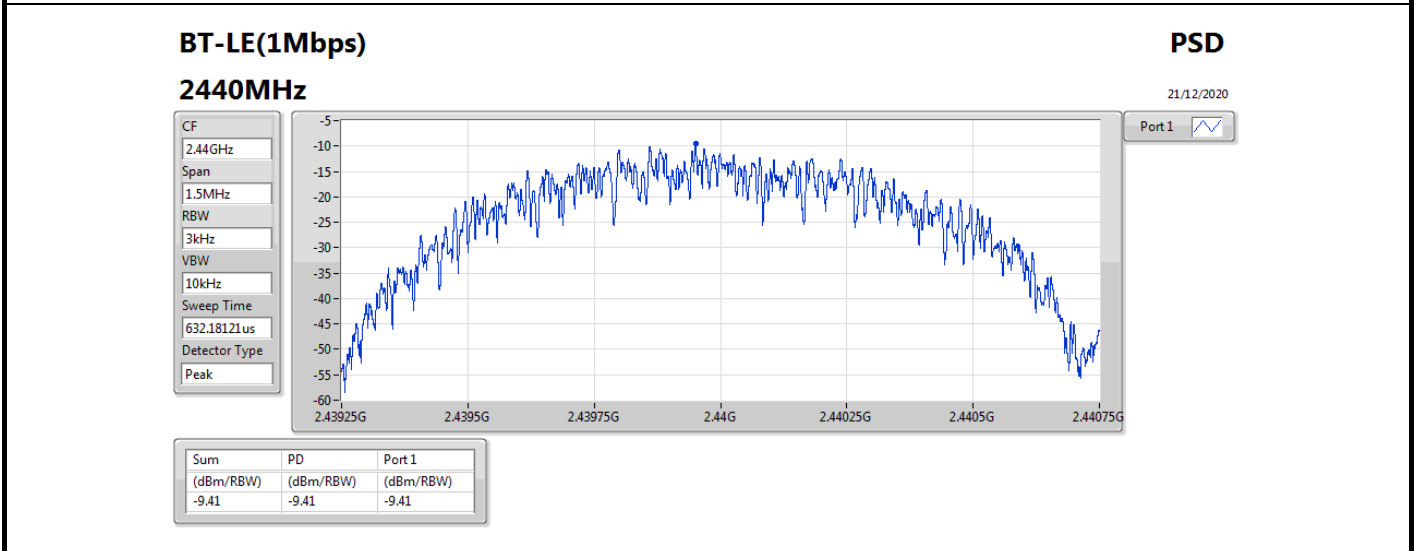
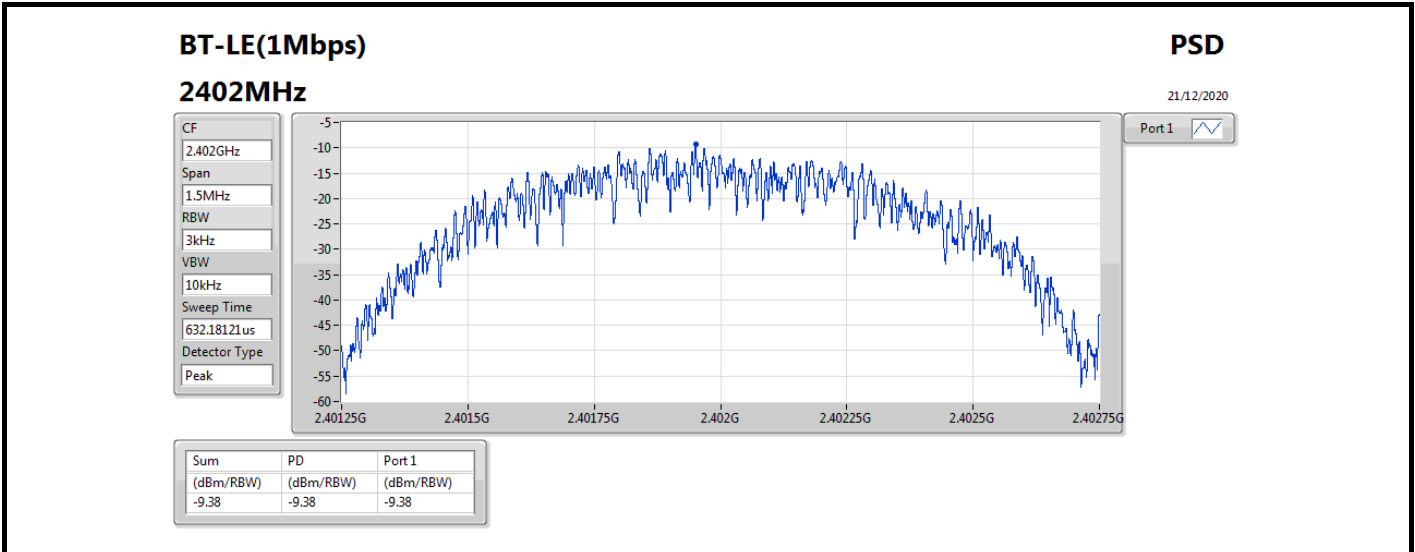

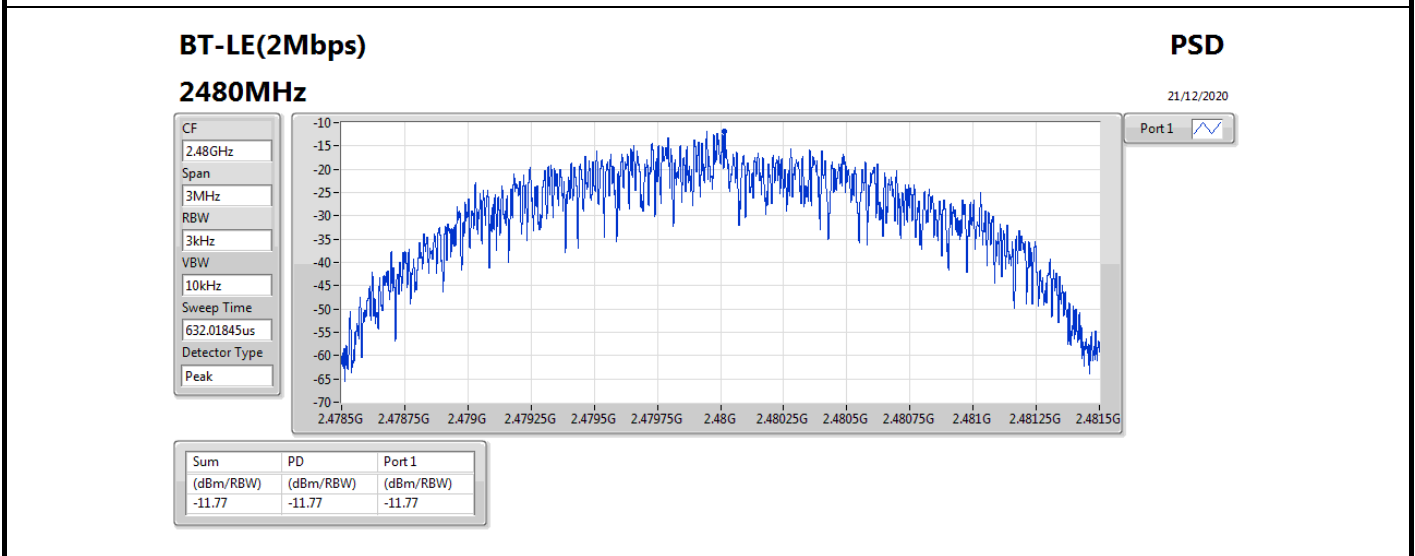
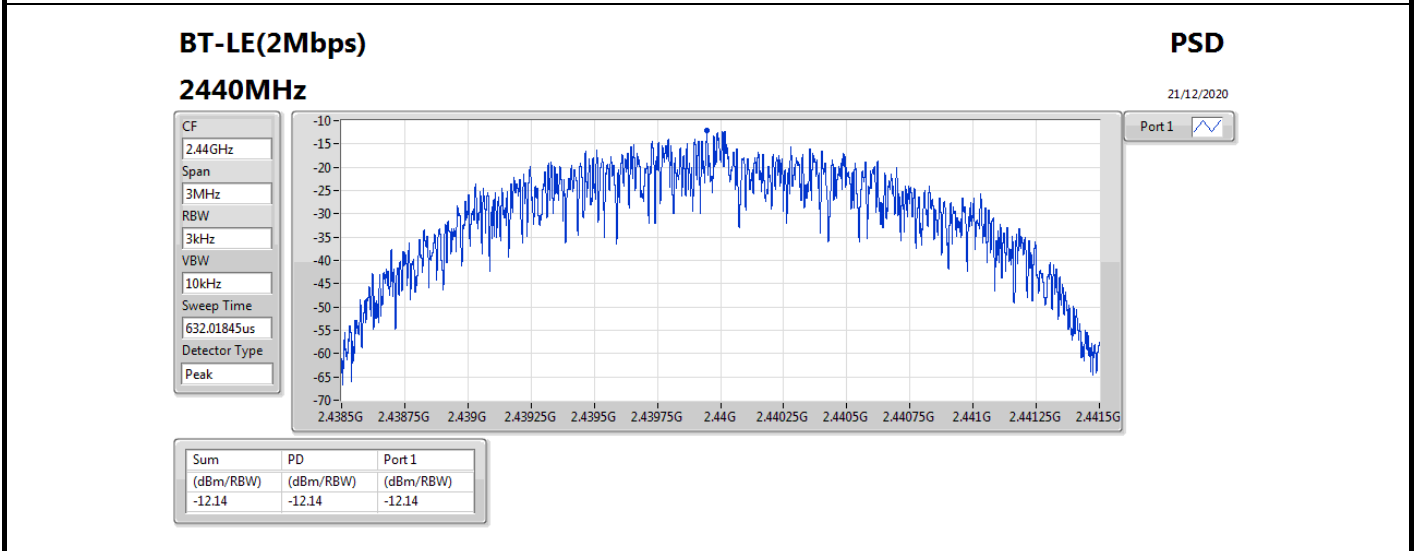
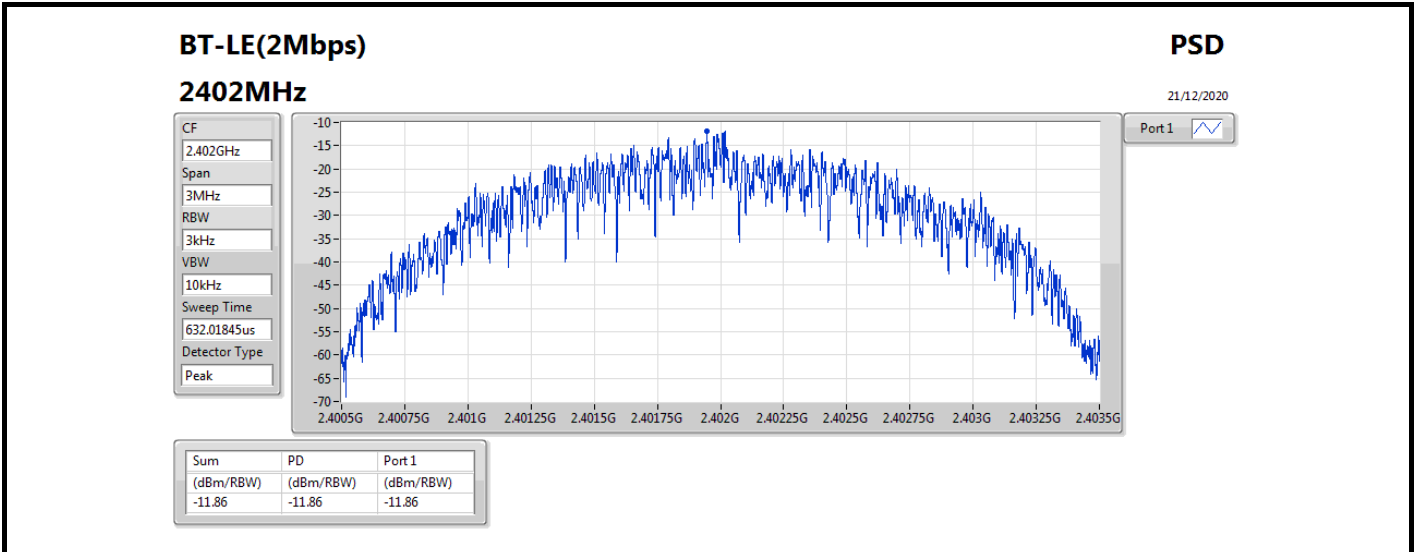



Summary

Mode	Result	Ref (Hz)	Ref (dBm)	Limit (dBm)	Freq (Hz)	Level (dBm)	Freq (Hz)	Level (dBm)	Freq (Hz)	Level (dBm)	Freq (Hz)	Level (dBm)	Freq (Hz)	Level (dBm)	Port
2.4-2.4835GHz	-	-	-	-	-	-	-	-	-	-	-	-	-	-	-
BT-LE(1Mbps)	Pass	2.44G	6.29	-23.71	1.74785G	-53.70	2.39999G	-43.88	2.4G	-47.25	2.49336G	-52.65	16.24605G	-47.60	1
BT-LE(2Mbps)	Pass	2.44G	6.28	-23.72	899.21M	-53.88	2.39999G	-26.25	2.4G	-28.21	2.4978G	-52.04	16.25449G	-46.55	1

Result

Mode	Result	Ref (Hz)	Ref (dBm)	Limit (dBm)	Freq (Hz)	Level (dBm)	Freq (Hz)	Level (dBm)	Freq (Hz)	Level (dBm)	Freq (Hz)	Level (dBm)	Freq (Hz)	Level (dBm)	Port
BT-LE(1Mbps)	-	-	-	-	-	-	-	-	-	-	-	-	-	-	-
2402MHz	Pass	2.44G	6.29	-23.71	1.74785G	-53.70	2.39999G	-43.88	2.4G	-47.25	2.49336G	-52.65	16.24605G	-47.60	1
2440MHz	Pass	2.44G	6.29	-23.71	857.2M	-54.49	2.39358G	-52.71	2.4G	-55.03	2.49744G	-52.22	16.45977G	-46.90	1
2480MHz	Pass	2.44G	6.29	-23.71	1.92146G	-54.58	2.39728G	-52.77	2.4835G	-52.17	2.48356G	-51.58	17.60428G	-46.80	1
BT-LE(2Mbps)	-	-	-	-	-	-	-	-	-	-	-	-	-	-	-
2402MHz	Pass	2.44G	6.28	-23.72	899.21M	-53.88	2.39999G	-26.25	2.4G	-28.21	2.4978G	-52.04	16.25449G	-46.55	1
2440MHz	Pass	2.44G	6.28	-23.72	2.15088G	-54.48	2.39204G	-52.52	2.4835G	-53.86	2.50238G	-52.63	17.62115G	-46.61	1
2480MHz	Pass	2.44G	6.28	-23.72	1.93585G	-53.40	2.39362G	-52.91	2.4835G	-49.62	2.48374G	-48.21	16.21512G	-45.73	1

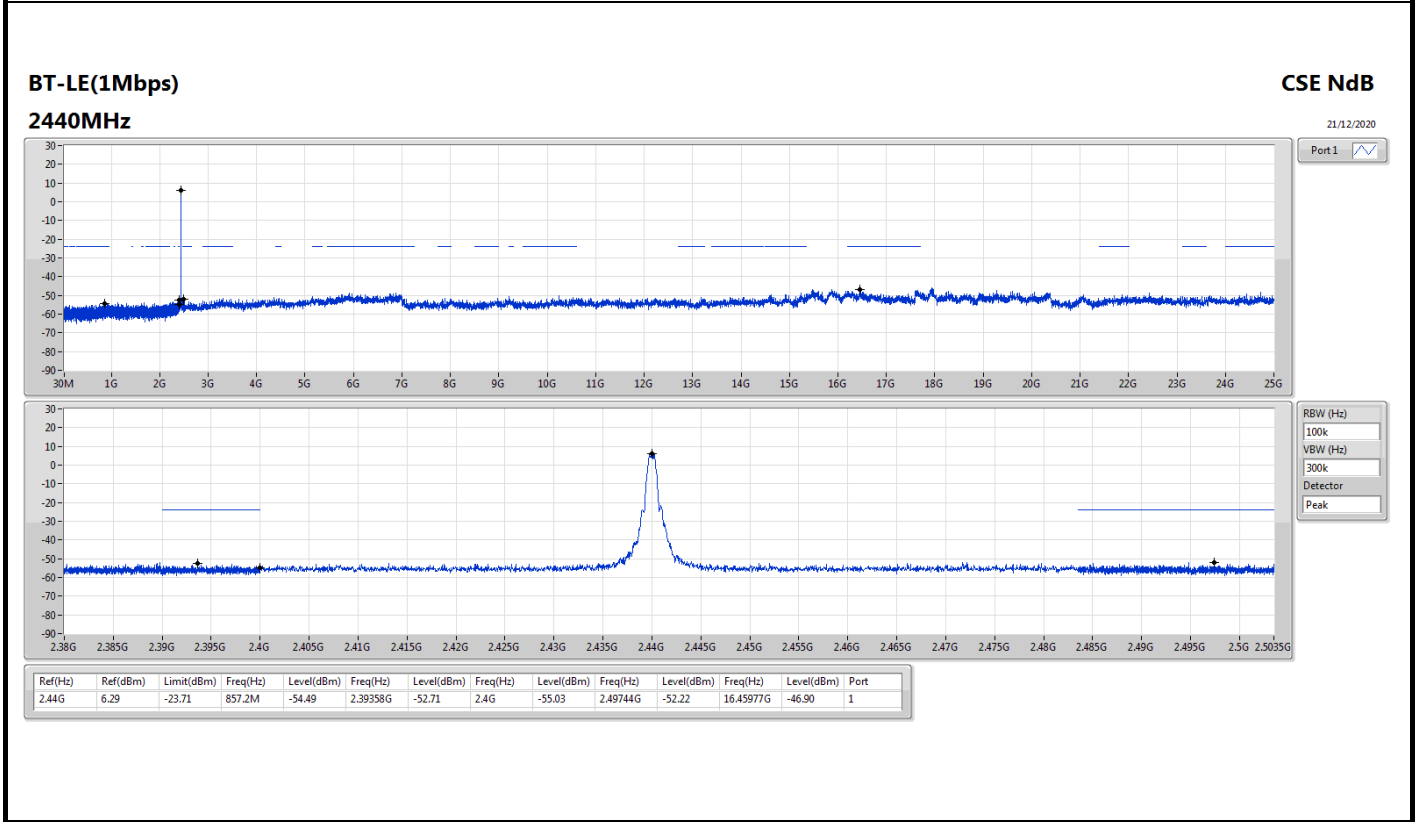
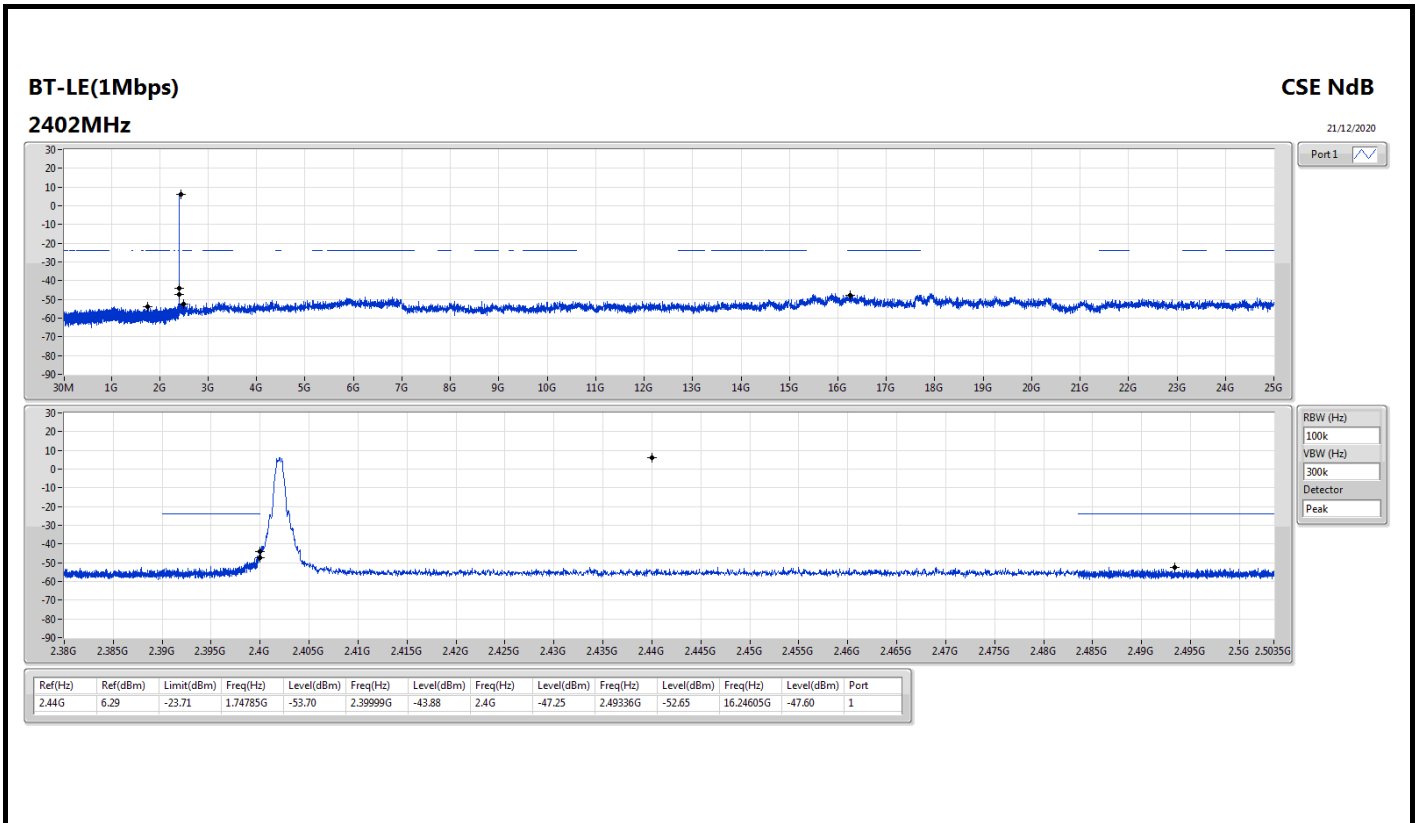

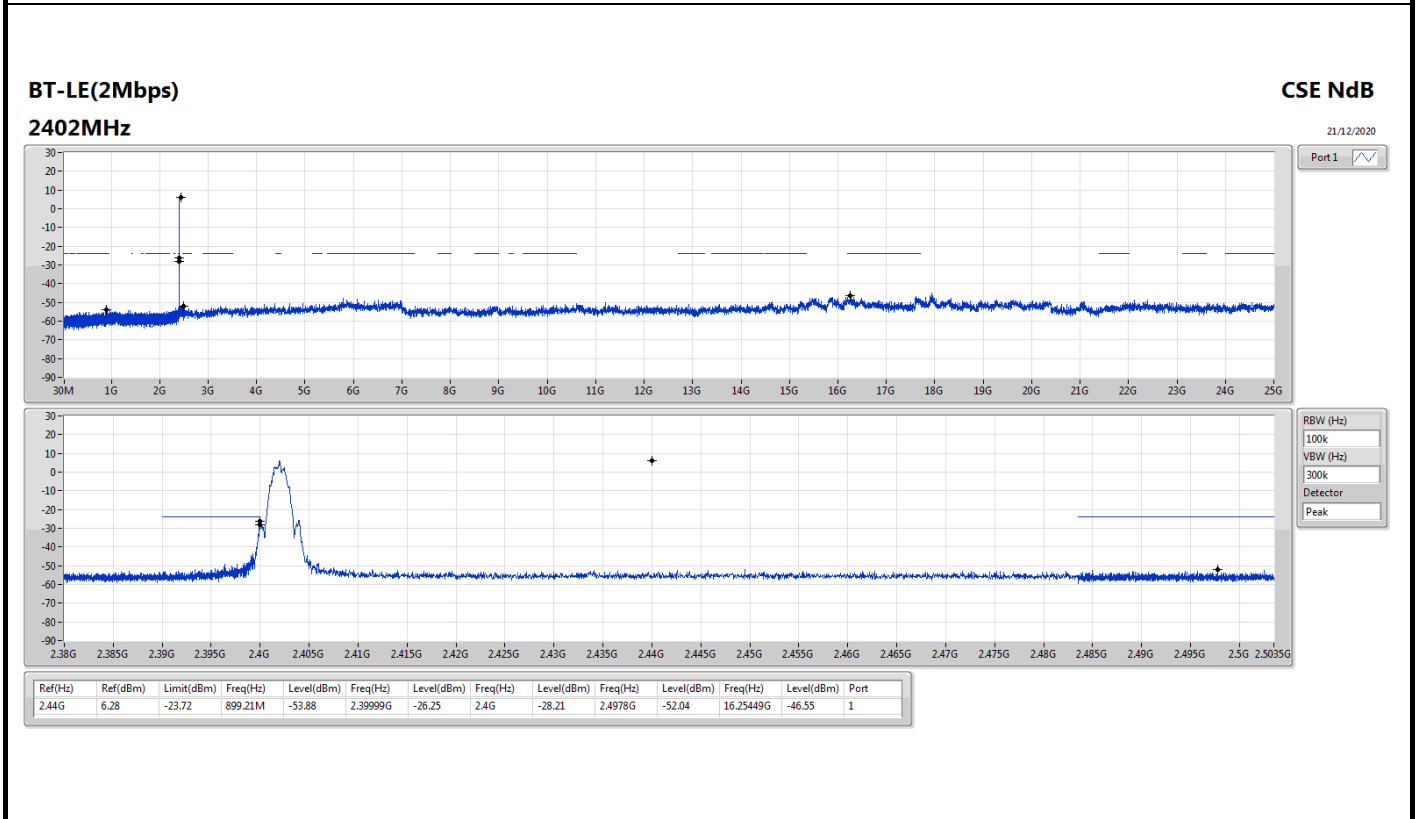
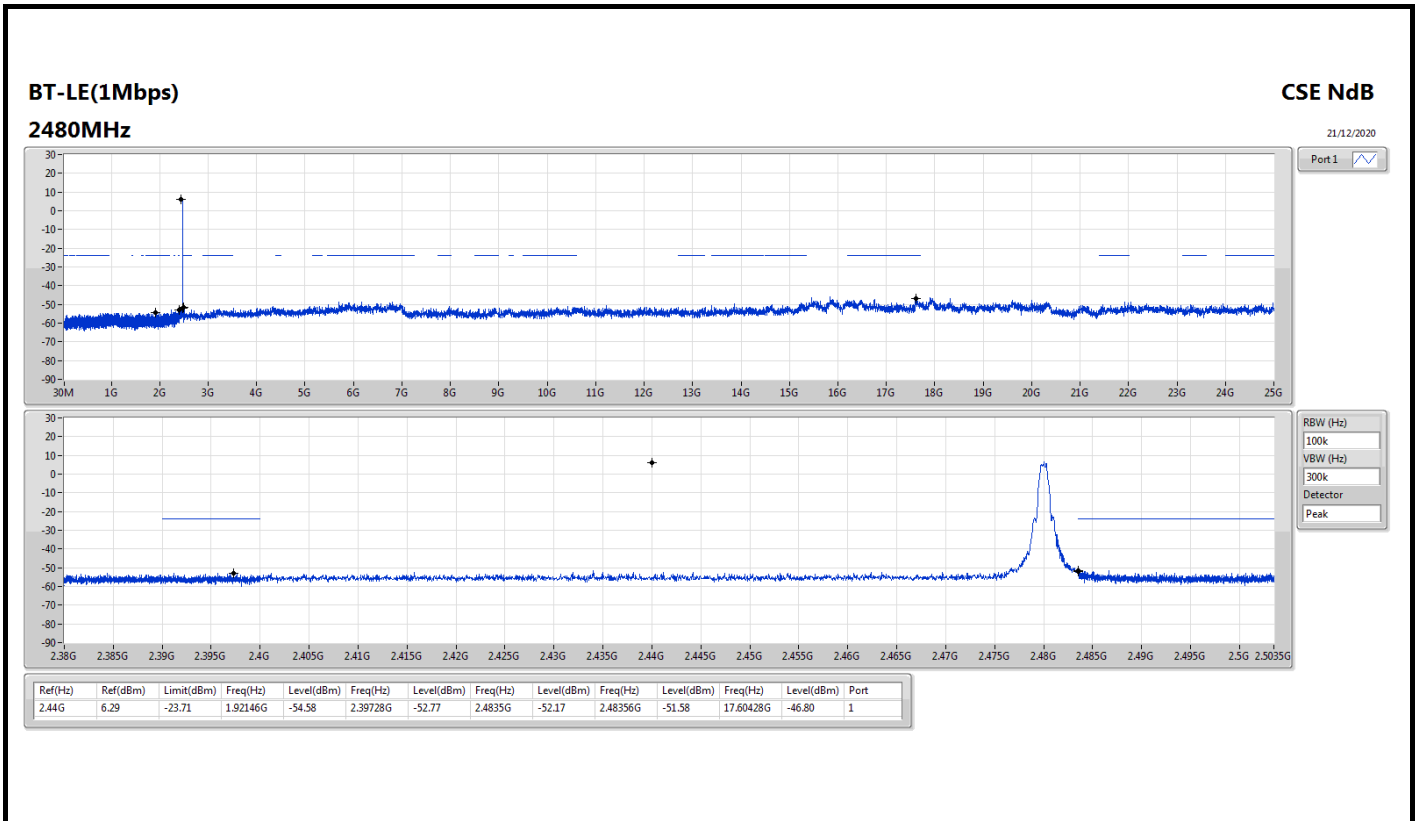

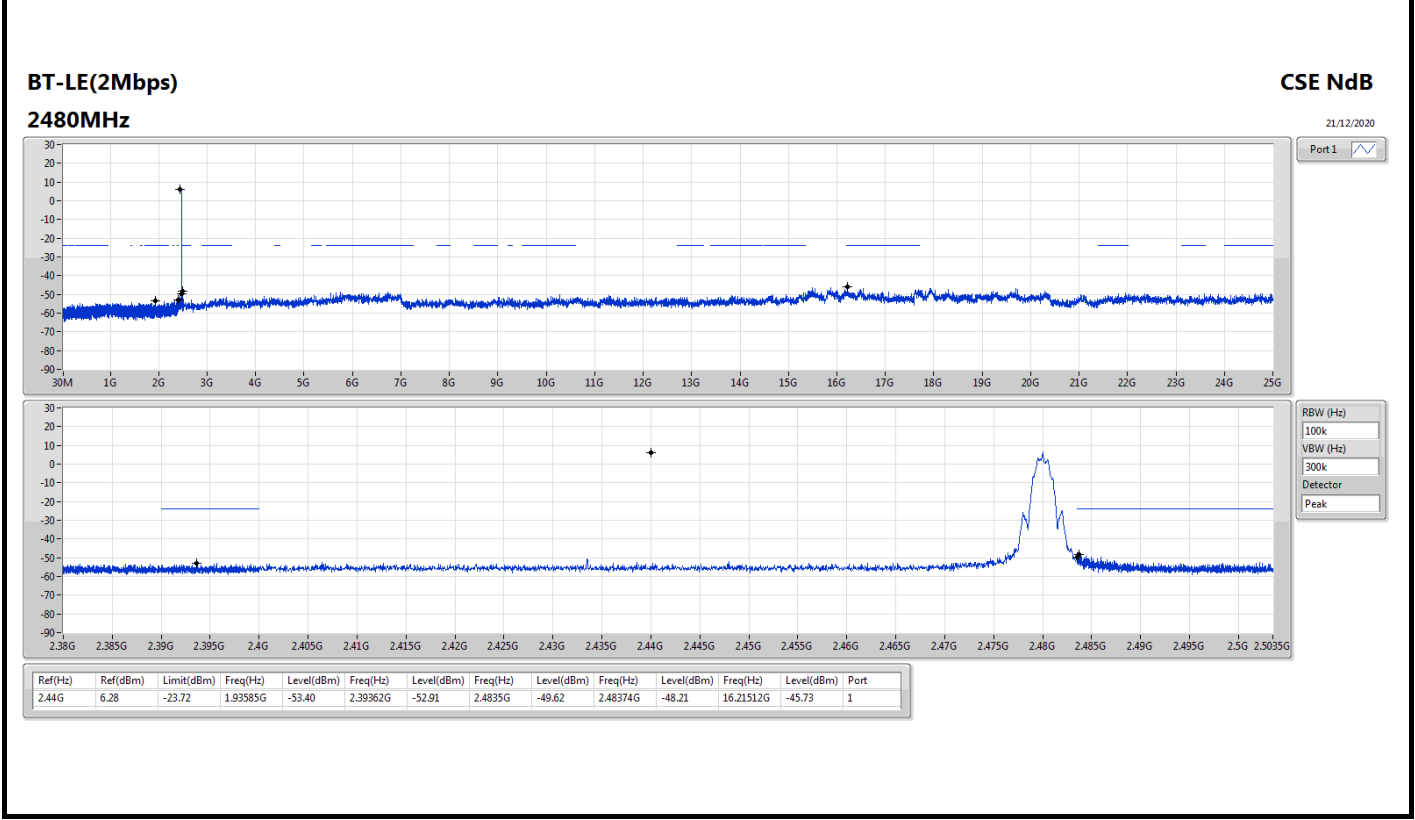
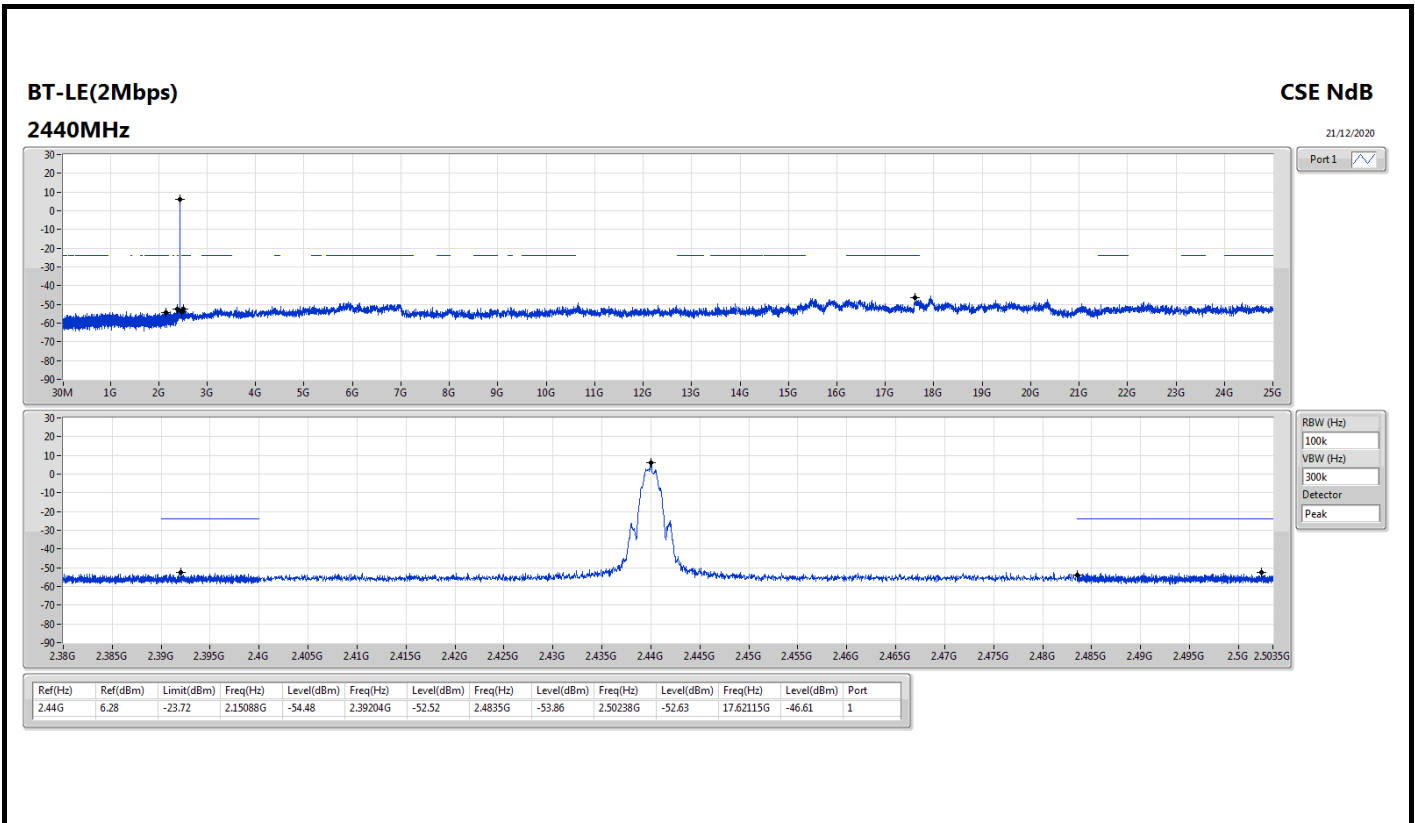



Summary

Mode	Result	Type	Freq (Hz)	Level (dBuV/m)	Limit (dBuV/m)	Margin (dB)	Condition
Mode 1	Pass	QP	34.85M	32.61	40.00	-7.39	Vertical

Mode 1

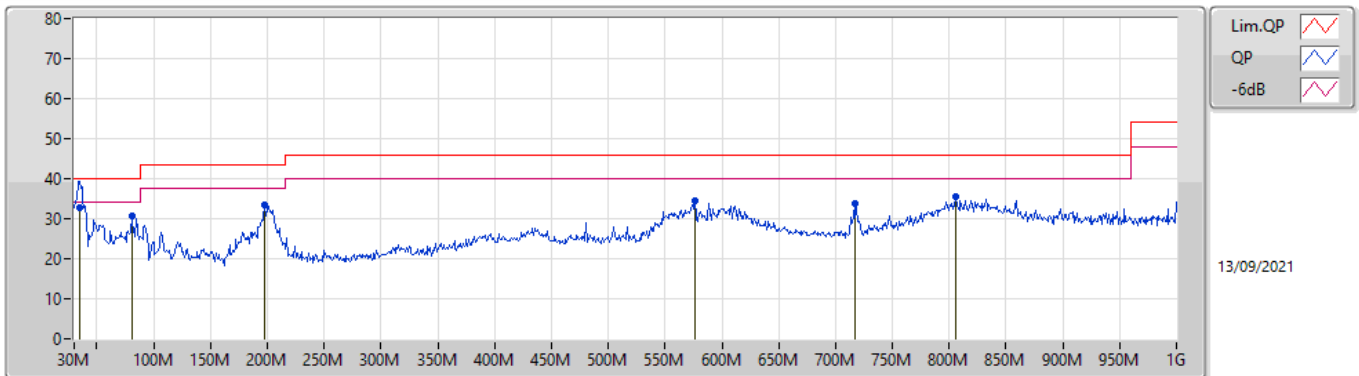

Type	Freq (Hz)	Level (dBuV/m)	Limit (dBuV/m)	Margin (dB)	Factor (dB/m)	Dist (m)	Condition	Azimuth (°)	Height (m)	Comment	Raw (dBuV/m)	AF (dB/m)	CL (dB)	PA (dB)
QP	34.85M	32.61	40.00	-7.39	-6.20	3	Vertical	28	1.00	"Worst"	38.81	21.57	0.71	28.48
PK	80.44M	30.66	40.00	-9.34	-14.51	3	Vertical	181	1.25	-	45.17	12.94	1.03	28.48
PK	197.81M	33.45	43.50	-10.05	-11.38	3	Vertical	352	1.25	-	44.83	14.92	1.70	28.00
PK	576.11M	34.44	46.00	-11.56	-2.28	3	Vertical	143	1.00	-	36.72	24.11	2.96	29.35
PK	716.76M	33.83	46.00	-12.17	-1.60	3	Vertical	319	1.50	-	35.43	24.38	3.29	29.27
PK	806M	35.51	46.00	-10.49	-0.41	3	Vertical	292	1.00	-	35.92	25.17	3.46	29.04

Mode 1

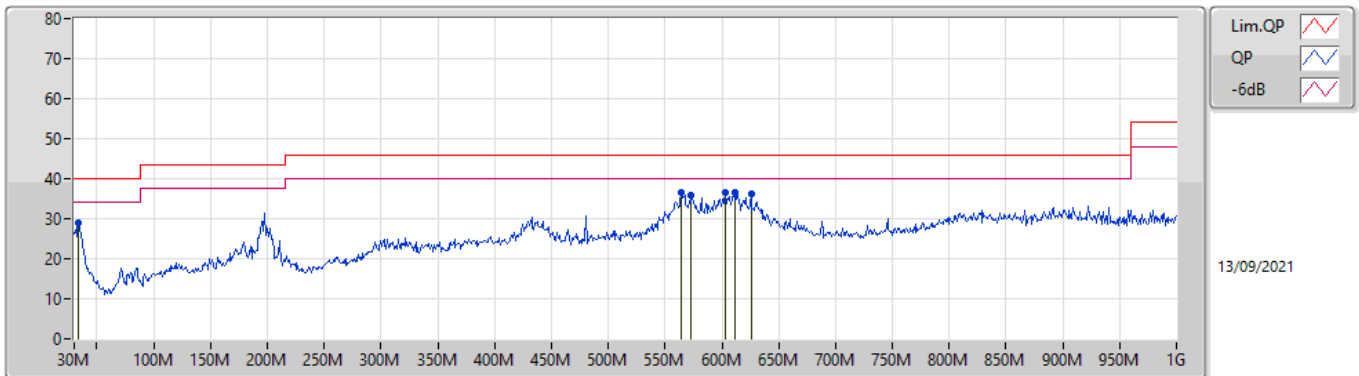

Type	Freq (Hz)	Level (dBuV/m)	Limit (dBuV/m)	Margin (dB)	Factor (dB/m)	Dist (m)	Condition	Azimuth (°)	Height (m)	Comment	Raw (dBuV/m)	AF (dB/m)	CL (dB)	PA (dB)
PK	33.88M	29.13	40.00	-10.87	-5.76	3	Horizontal	59	2.00	-	34.89	22.03	0.69	28.48
PK	564.47M	36.67	46.00	-9.33	-2.43	3	Horizontal	287	1.00	"Worst"	39.10	24.01	2.92	29.36
PK	573.2M	35.72	46.00	-10.28	-2.26	3	Horizontal	278	1.00	-	37.98	24.14	2.95	29.35
PK	603.27M	36.54	46.00	-9.46	-2.25	3	Horizontal	51	2.00	-	38.79	24.01	3.06	29.32
PK	612M	36.45	46.00	-9.55	-2.04	3	Horizontal	62	2.00	-	38.49	24.21	3.08	29.33
PK	625.58M	36.17	46.00	-9.83	-1.86	3	Horizontal	292	2.00	-	38.03	24.37	3.11	29.34



Summary

Mode	Result	Type	Freq (Hz)	Level (dBuV/m)	Limit (dBuV/m)	Margin (dB)	Dist (m)	Condition	Azimuth (°)	Height (m)	Comments
2.4-2.4835GHz	-	-	-	-	-	-	-	-	-	-	-
BT-LE(1Mbps)	Pass	AV	2.4835G	48.83	54.00	-5.17	3	Vertical	189	2.93	-

BT-LE(1Mbps)

07/12/2020

2402MHz_TX

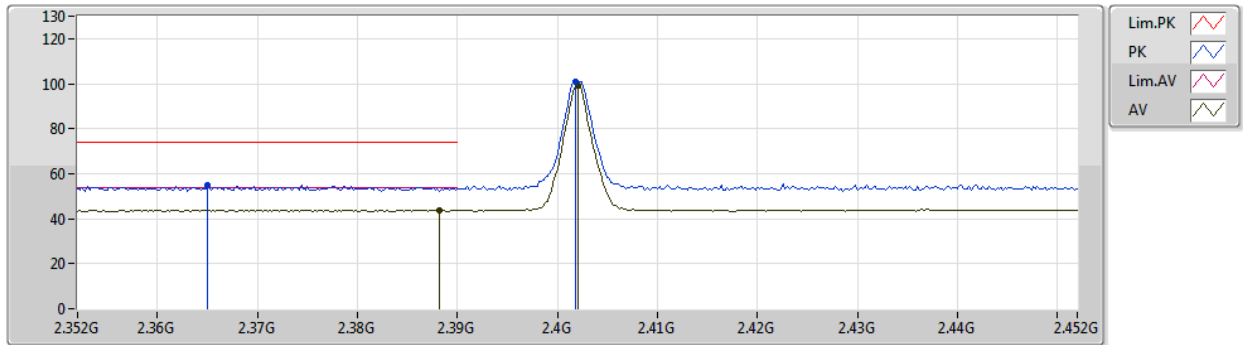

EUT_Z_1TX
Setting Default
04-F-K-4

Type	Freq (Hz)	Level (dBuV/m)	Limit (dBuV/m)	Margin (dB)	Raw (dBuV)	Dist (m)	Condition	Azimuth (°)	Height (m)	Comment	AF (dB)	CL (dB)	PA (dB)
PK	2.365G	54.93	74.00	-19.07	24.30	3	Vertical	1	3.00	-	27.43	3.20	-
AV	2.3882G	43.86	54.00	-10.14	13.18	3	Vertical	1	3.00	-	27.48	3.20	-
PK	2.4018G	100.75	Inf	-Inf	70.05	3	Vertical	1	3.00	-	27.50	3.20	-
AV	2.402G	99.31	Inf	-Inf	68.61	3	Vertical	1	3.00	-	27.50	3.20	-

BT-LE(1Mbps)

07/12/2020

2402MHz_TX

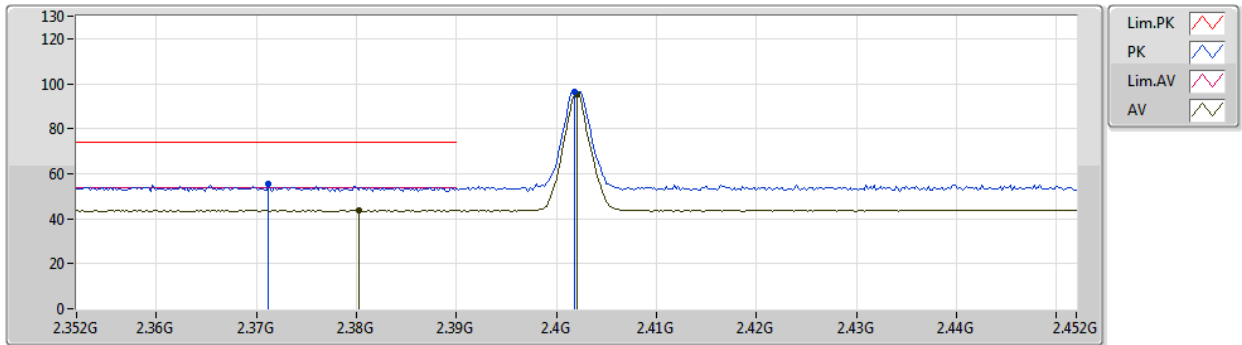

EUT_Z_1TX
Setting Default
04-F-K-4

Type	Freq (Hz)	Level (dBuV/m)	Limit (dBuV/m)	Margin (dB)	Raw (dBuV)	Dist (m)	Condition	Azimuth (°)	Height (m)	Comment	AF (dB)	CL (dB)	PA (dB)
PK	2.3712G	55.36	74.00	-18.64	24.72	3	Horizontal	317	2.87	-	27.44	3.20	-
AV	2.3802G	43.82	54.00	-10.18	13.16	3	Horizontal	317	2.87	-	27.46	3.20	-
PK	2.4018G	96.65	Inf	-Inf	65.95	3	Horizontal	317	2.87	-	27.50	3.20	-
AV	2.402G	95.13	Inf	-Inf	64.43	3	Horizontal	317	2.87	-	27.50	3.20	-

BT-LE(1Mbps)

07/12/2020

2402MHz_TX

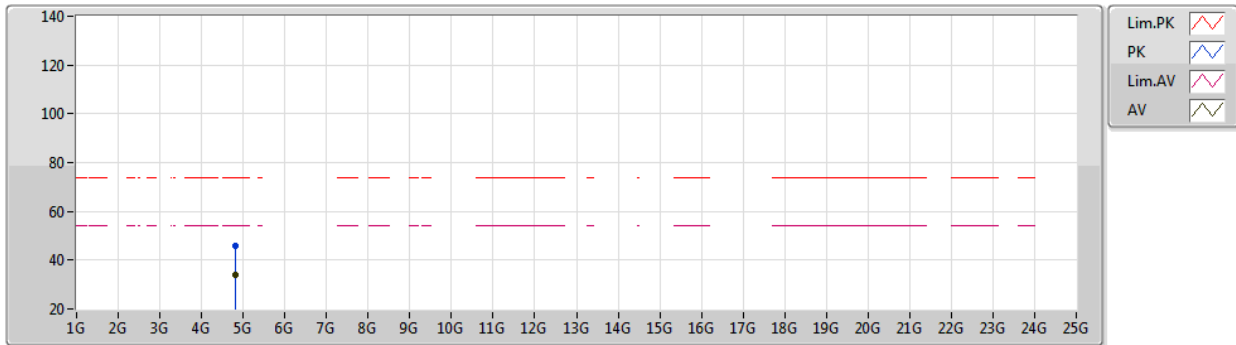

EUT Z_1TX
Setting Default
04-F-K-4

Type	Freq (Hz)	Level (dBuV/m)	Limit (dBuV/m)	Margin (dB)	Raw (dBuV)	Dist (m)	Condition	Azimuth (°)	Height (m)	Comment	AF (dB)	CL (dB)	PA (dB)
PK	4.80614G	45.80	74.00	-28.20	40.84	3	Vertical	32	1.33	-	32.44	5.40	32.88
AV	4.80768G	33.74	54.00	-20.26	28.77	3	Vertical	32	1.33	-	32.45	5.40	32.88

BT-LE(1Mbps)

07/12/2020

2402MHz_TX

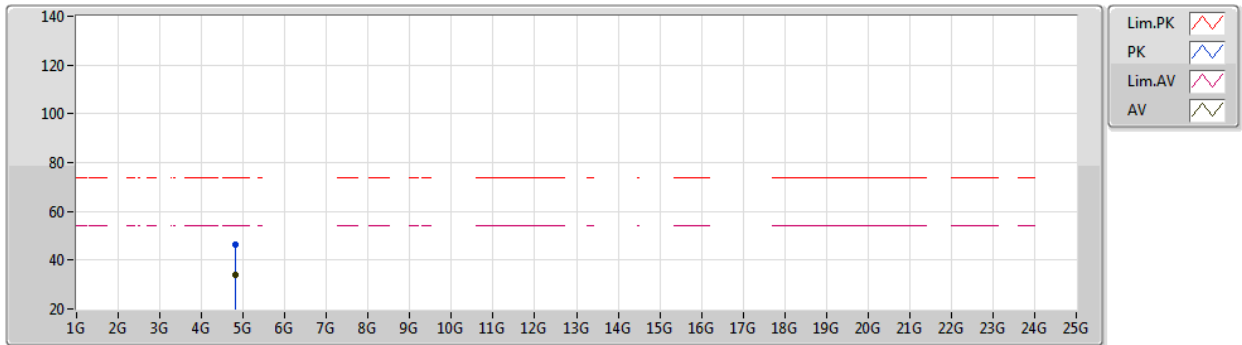

EUT Z_1TX
Setting Default
04-F-K-4

Type	Freq (Hz)	Level (dBuV/m)	Limit (dBuV/m)	Margin (dB)	Raw (dBuV)	Dist (m)	Condition	Azimuth (°)	Height (m)	Comment	AF (dB)	CL (dB)	PA (dB)
PK	4.8035G	46.57	74.00	-27.43	41.63	3	Horizontal	151	1.01	-	32.42	5.40	32.88
AV	4.8049G	33.82	54.00	-20.18	28.87	3	Horizontal	151	1.01	-	32.43	5.40	32.88

BT-LE(1Mbps)

07/12/2020

2440MHz_TX

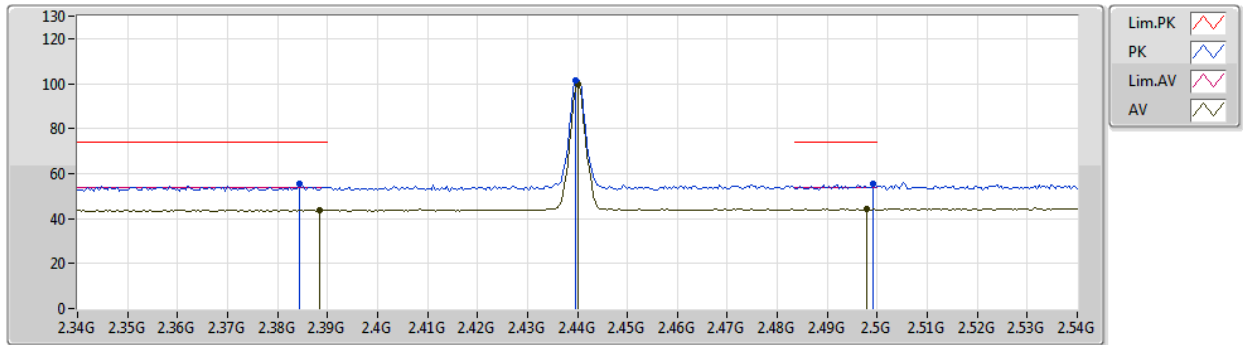

EUT Z_1TX
Setting Default
04-F-K-4

Type	Freq (Hz)	Level (dBuV/m)	Limit (dBuV/m)	Margin (dB)	Raw (dBuV)	Dist (m)	Condition	Azimuth (°)	Height (m)	Comment	AF (dB)	CL (dB)	PA (dB)
PK	2.3844G	55.23	74.00	-18.77	24.56	3	Vertical	196	3.00	-	27.47	3.20	-
AV	2.3884G	43.76	54.00	-10.24	13.08	3	Vertical	196	3.00	-	27.48	3.20	-
PK	2.4396G	101.52	Inf	-Inf	70.70	3	Vertical	196	3.00	-	27.58	3.24	-
AV	2.44G	99.99	Inf	-Inf	69.17	3	Vertical	196	3.00	-	27.58	3.24	-
PK	2.4992G	55.47	74.00	-18.53	24.37	3	Vertical	196	3.00	-	27.80	3.30	-
AV	2.498G	44.31	54.00	-9.69	13.22	3	Vertical	196	3.00	-	27.79	3.30	-

BT-LE(1Mbps)

07/12/2020

2440MHz_TX

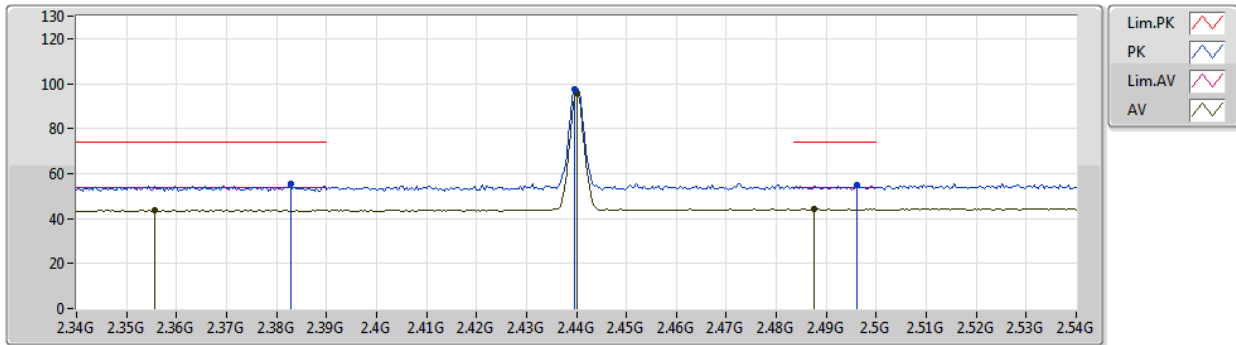

EUT Z_1TX
Setting Default
04-F-K-4

Type	Freq (Hz)	Level (dBuV/m)	Limit (dBuV/m)	Margin (dB)	Raw (dBuV)	Dist (m)	Condition	Azimuth (°)	Height (m)	Comment	AF (dB)	CL (dB)	PA (dB)
PK	2.3828G	55.22	74.00	-18.78	24.55	3	Horizontal	144	2.72	-	27.47	3.20	-
AV	2.3556G	43.84	54.00	-10.16	13.23	3	Horizontal	144	2.72	-	27.41	3.20	-
PK	2.4396G	97.48	Inf	-Inf	66.66	3	Horizontal	144	2.72	-	27.58	3.24	-
AV	2.44G	96.03	Inf	-Inf	65.21	3	Horizontal	144	2.72	-	27.58	3.24	-
PK	2.496G	54.76	74.00	-19.24	23.68	3	Horizontal	144	2.72	-	27.78	3.30	-
AV	2.4876G	44.22	54.00	-9.78	13.18	3	Horizontal	144	2.72	-	27.75	3.29	-

BT-LE(1Mbps)

07/12/2020

2440MHz_TX

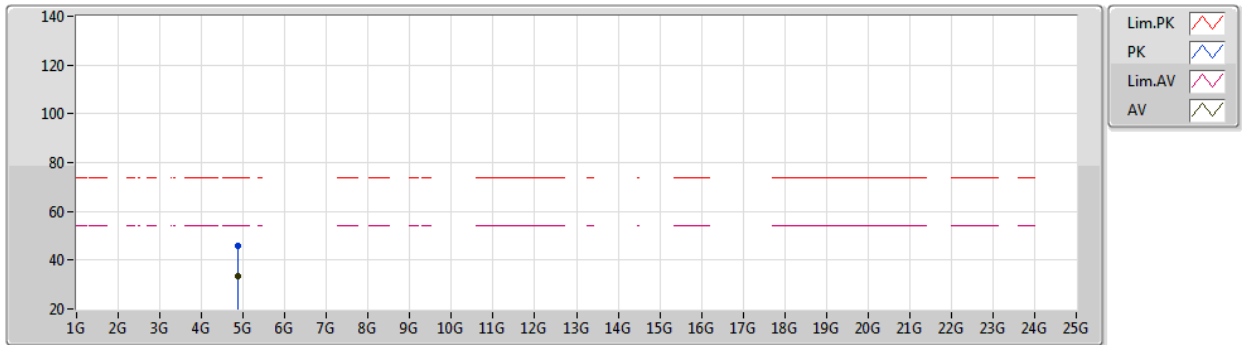

EUT Z_1TX
Setting Default
04-F-K-4

Type	Freq (Hz)	Level (dBuV/m)	Limit (dBuV/m)	Margin (dB)	Raw (dBuV)	Dist (m)	Condition	Azimuth (°)	Height (m)	Comment	AF (dB)	CL (dB)	PA (dB)
PK	4.88338G	45.87	74.00	-28.13	40.53	3	Vertical	354	2.30	-	32.77	5.44	32.87
AV	4.8816G	33.49	54.00	-20.51	28.16	3	Vertical	354	2.30	-	32.76	5.44	32.87

BT-LE(1Mbps)

07/12/2020

2440MHz_TX

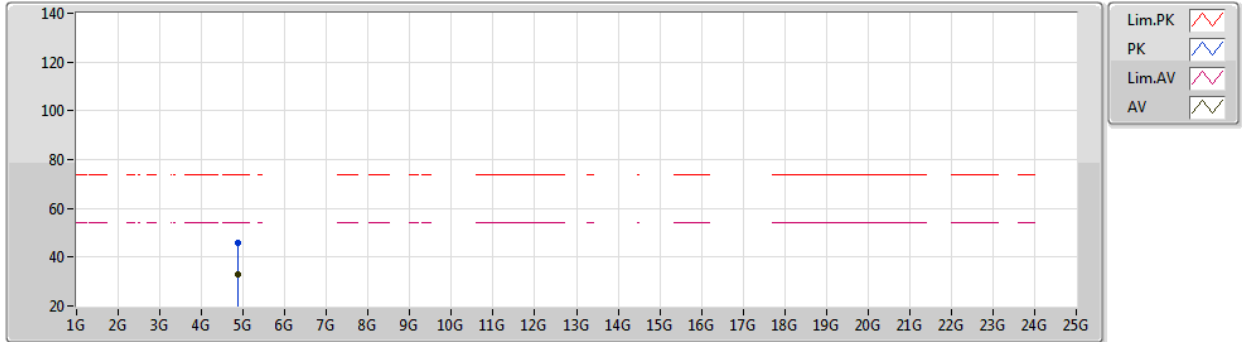

EUT Z_1TX
Setting Default
04-F-K-4

Type	Freq (Hz)	Level (dBuV/m)	Limit (dBuV/m)	Margin (dB)	Raw (dBuV)	Dist (m)	Condition	Azimuth (°)	Height (m)	Comment	AF (dB)	CL (dB)	PA (dB)
PK	4.88314G	45.97	74.00	-28.03	40.63	3	Horizontal	355	1.80	-	32.77	5.44	32.87
AV	4.8848G	33.05	54.00	-20.95	27.71	3	Horizontal	355	1.80	-	32.77	5.44	32.87

BT-LE(1Mbps)

07/12/2020

2480MHz_TX

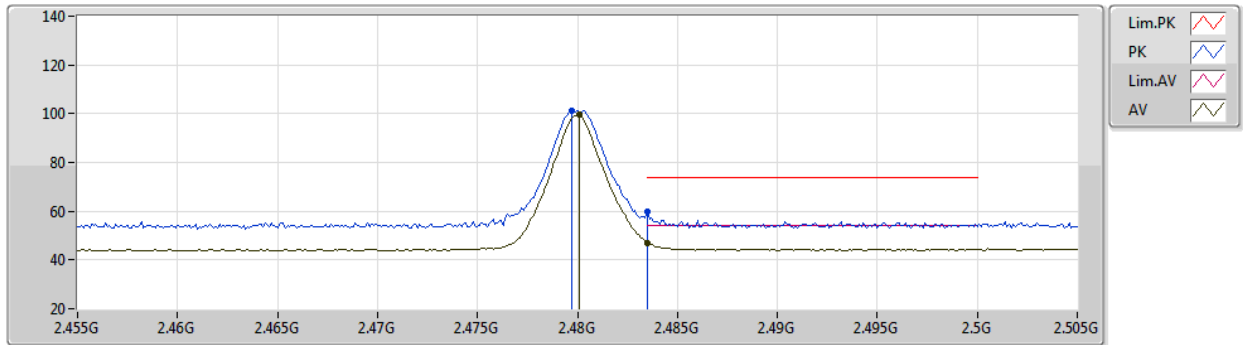

EUT Z_1TX
Setting Default
04-F-E-2

Type	Freq (Hz)	Level (dBuV/m)	Limit (dBuV/m)	Margin (dB)	Raw (dBuV)	Dist (m)	Condition	Azimuth (°)	Height (m)	Comment	AF (dB)	CL (dB)	PA (dB)
PK	2.4797G	100.99	Inf	-Inf	69.99	3	Vertical	190	2.59	-	27.72	3.28	-
AV	2.4801G	99.44	Inf	-Inf	68.44	3	Vertical	190	2.59	-	27.72	3.28	-
PK	2.4835G	59.59	74.00	-14.41	28.58	3	Vertical	190	2.59	-	27.73	3.28	-
AV	2.4835G	46.97	54.00	-7.03	15.96	3	Vertical	190	2.59	-	27.73	3.28	-

BT-LE(1Mbps)

07/12/2020

2480MHz_TX

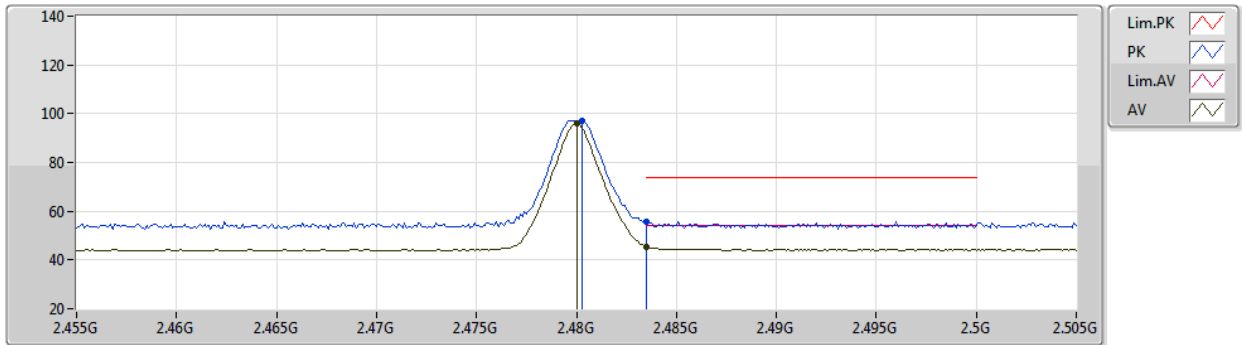

EUT Z_1TX
Setting Default
04-F-E-2

Type	Freq (Hz)	Level (dBuV/m)	Limit (dBuV/m)	Margin (dB)	Raw (dBuV)	Dist (m)	Condition	Azimuth (°)	Height (m)	Comment	AF (dB)	CL (dB)	PA (dB)
PK	2.4803G	97.31	Inf	-Inf	66.31	3	Horizontal	149	2.62	-	27.72	3.28	-
AV	2.48G	95.83	Inf	-Inf	64.83	3	Horizontal	149	2.62	-	27.72	3.28	-
PK	2.4835G	55.86	74.00	-18.14	24.85	3	Horizontal	149	2.62	-	27.73	3.28	-
AV	2.4835G	45.46	54.00	-8.54	14.45	3	Horizontal	149	2.62	-	27.73	3.28	-

BT-LE(1Mbps)

07/12/2020

2480MHz_TX

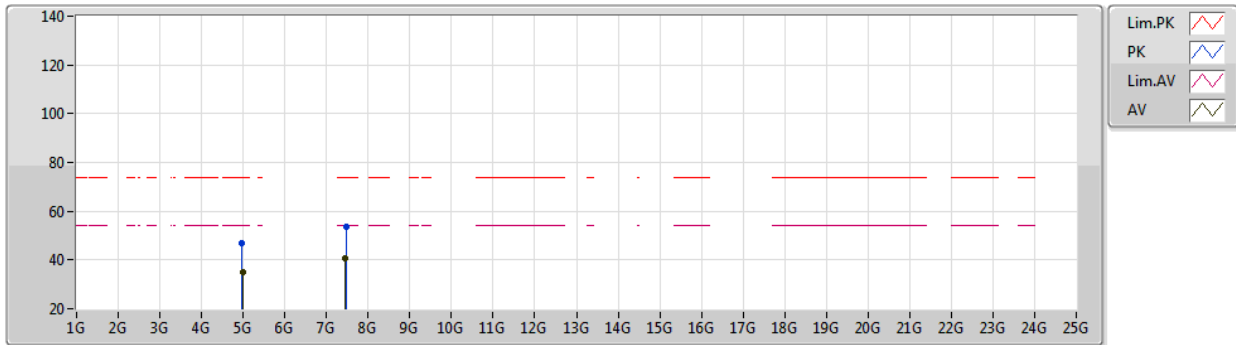

EUT Z_1TX
Setting Default
04-F-E-2

Type	Freq (Hz)	Level (dBuV/m)	Limit (dBuV/m)	Margin (dB)	Raw (dBuV)	Dist (m)	Condition	Azimuth (°)	Height (m)	Comment	AF (dB)	CL (dB)	PA (dB)
PK	4.9611G	46.66	74.00	-27.34	41.06	3	Vertical	81	1.80	-	32.98	5.48	32.86
AV	4.9844G	34.80	54.00	-19.20	29.23	3	Vertical	81	1.80	-	32.93	5.49	32.85
PK	7.4649G	53.42	74.00	-20.58	42.45	3	Vertical	325	1.20	-	37.47	6.96	33.46
AV	7.4501G	40.86	54.00	-13.14	29.86	3	Vertical	325	1.20	-	37.50	6.95	33.45

BT-LE(1Mbps)

07/12/2020

2480MHz_TX

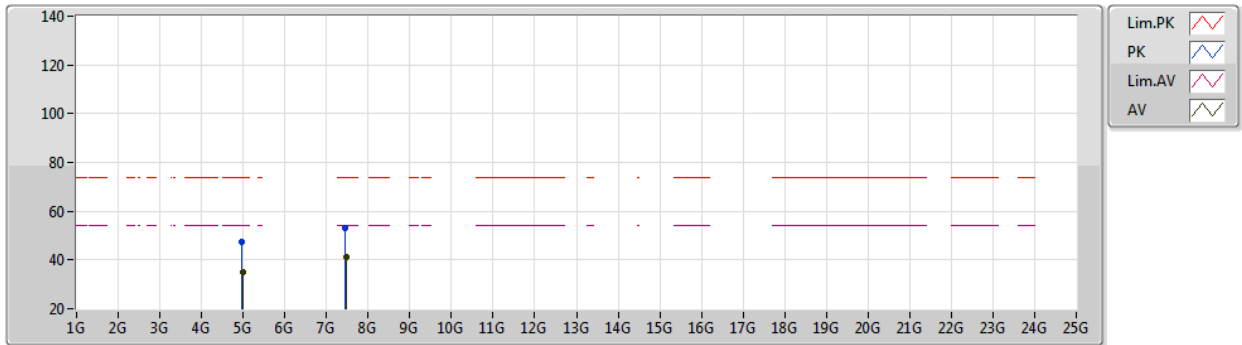

EUT Z_1TX
Setting Default
04-F-E-2

Type	Freq (Hz)	Level (dBuV/m)	Limit (dBuV/m)	Margin (dB)	Raw (dBuV)	Dist (m)	Condition	Azimuth (°)	Height (m)	Comment	AF (dB)	CL (dB)	PA (dB)
PK	4.9542G	47.29	74.00	-26.71	41.68	3	Horizontal	191	1.65	-	32.99	5.48	32.86
AV	4.984G	35.24	54.00	-18.76	29.67	3	Horizontal	191	1.65	-	32.93	5.49	32.85
PK	7.4326G	53.11	74.00	-20.89	42.14	3	Horizontal	183	2.84	-	37.47	6.93	33.43
AV	7.4632G	41.14	54.00	-12.86	30.16	3	Horizontal	183	2.84	-	37.47	6.96	33.45

BT-LE(1Mbps)

07/12/2020

2402MHz_TX

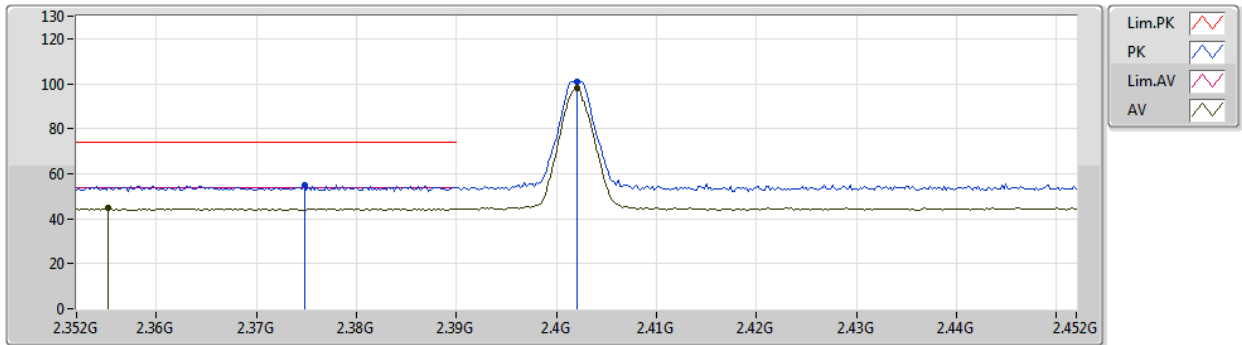

EUT_Z_1TX
Setting Default
04-F-K-4

Type	Freq (Hz)	Level (dBuV/m)	Limit (dBuV/m)	Margin (dB)	Raw (dBuV)	Dist (m)	Condition	Azimuth (°)	Height (m)	Comment	AF (dB)	CL (dB)	PA (dB)
PK	2.3748G	54.94	74.00	-19.06	24.29	3	Vertical	0	3.00	-	27.45	3.20	-
AV	2.3552G	44.64	54.00	-9.36	14.03	3	Vertical	0	3.00	-	27.41	3.20	-
PK	2.402G	100.71	Inf	-Inf	70.01	3	Vertical	0	3.00	-	27.50	3.20	-
AV	2.402G	97.94	Inf	-Inf	67.24	3	Vertical	0	3.00	-	27.50	3.20	-

BT-LE(1Mbps)

07/12/2020

2402MHz_TX

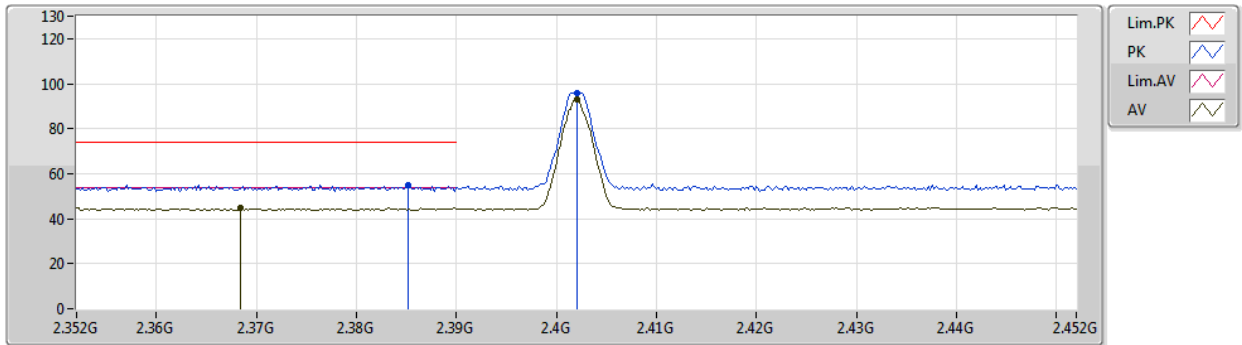

EUT Z_1TX
Setting Default
04-F-K-4

Type	Freq (Hz)	Level (dBuV/m)	Limit (dBuV/m)	Margin (dB)	Raw (dBuV)	Dist (m)	Condition	Azimuth (°)	Height (m)	Comment	AF (dB)	CL (dB)	PA (dB)
PK	2.3852G	55.19	74.00	-18.81	24.52	3	Horizontal	316	1.62	-	27.47	3.20	-
AV	2.3684G	44.80	54.00	-9.20	14.16	3	Horizontal	316	1.62	-	27.44	3.20	-
PK	2.402G	95.80	Inf	-Inf	65.10	3	Horizontal	316	1.62	-	27.50	3.20	-
AV	2.402G	93.01	Inf	-Inf	62.31	3	Horizontal	316	1.62	-	27.50	3.20	-

BT-LE(1Mbps)

07/12/2020

2402MHz_TX

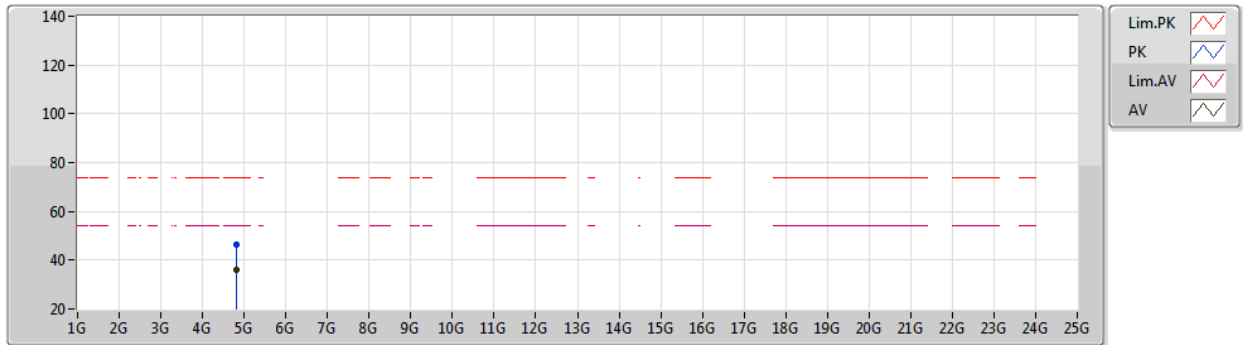

EUT Z_1TX
Setting Default
04-F-K-4

Type	Freq (Hz)	Level (dBuV/m)	Limit (dBuV/m)	Margin (dB)	Raw (dBuV)	Dist (m)	Condition	Azimuth (°)	Height (m)	Comment	AF (dB)	CL (dB)	PA (dB)
PK	4.80418G	46.53	74.00	-27.47	41.58	3	Vertical	131	2.15	-	32.43	5.40	32.88
AV	4.8076G	36.16	54.00	-17.84	31.19	3	Vertical	131	2.15	-	32.45	5.40	32.88

BT-LE(1Mbps)

07/12/2020

2402MHz_TX

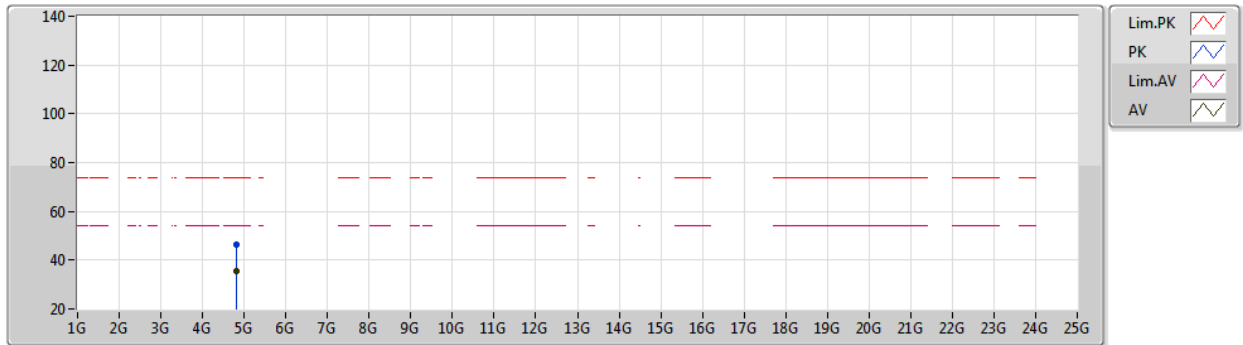

EUT Z_1TX
Setting Default
04-F-K-4

Type	Freq (Hz)	Level (dBuV/m)	Limit (dBuV/m)	Margin (dB)	Raw (dBuV)	Dist (m)	Condition	Azimuth (°)	Height (m)	Comment	AF (dB)	CL (dB)	PA (dB)
PK	4.80472G	46.27	74.00	-27.73	41.32	3	Horizontal	327	2.34	-	32.43	5.40	32.88
AV	4.80406G	35.32	54.00	-18.68	30.38	3	Horizontal	327	2.34	-	32.42	5.40	32.88

BT-LE(1Mbps)

07/12/2020

2440MHz_TX

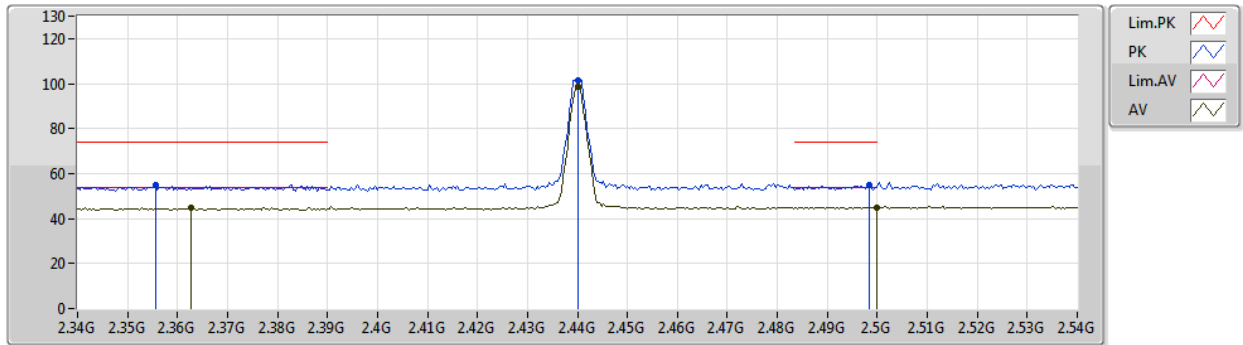

EUT Z_1TX
Setting Default
04-F-K-4

Type	Freq (Hz)	Level (dBuV/m)	Limit (dBuV/m)	Margin (dB)	Raw (dBuV)	Dist (m)	Condition	Azimuth (°)	Height (m)	Comment	AF (dB)	CL (dB)	PA (dB)
PK	2.3556G	54.87	74.00	-19.13	24.26	3	Vertical	196	3.00	-	27.41	3.20	-
AV	2.3628G	44.75	54.00	-9.25	14.12	3	Vertical	196	3.00	-	27.43	3.20	-
PK	2.44G	101.63	Inf	-Inf	70.81	3	Vertical	196	3.00	-	27.58	3.24	-
AV	2.44G	98.86	Inf	-Inf	68.04	3	Vertical	196	3.00	-	27.58	3.24	-
PK	2.4984G	54.80	74.00	-19.20	23.71	3	Vertical	196	3.00	-	27.79	3.30	-
AV	2.5G	45.08	54.00	-8.92	13.98	3	Vertical	196	3.00	-	27.80	3.30	-

BT-LE(1Mbps)

07/12/2020

2440MHz_TX

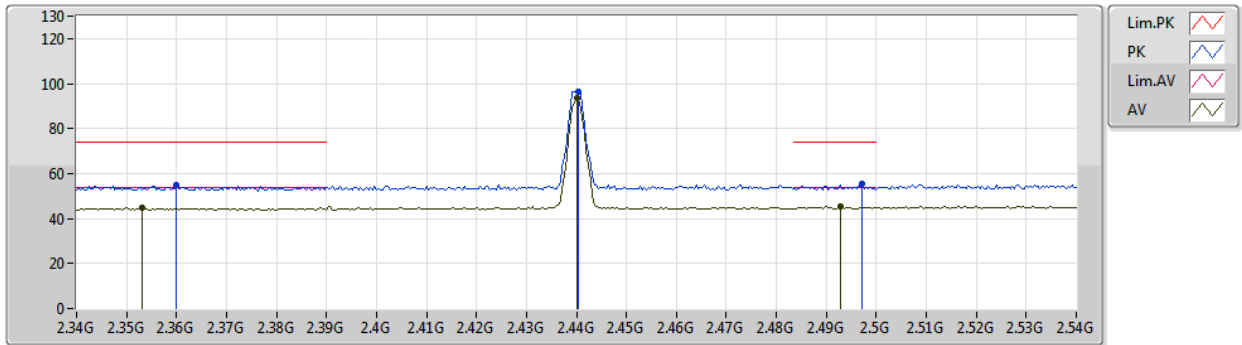

EUT Z_1TX
Setting Default
04-F-K-4

Type	Freq (Hz)	Level (dBuV/m)	Limit (dBuV/m)	Margin (dB)	Raw (dBuV)	Dist (m)	Condition	Azimuth (°)	Height (m)	Comment	AF (dB)	CL (dB)	PA (dB)
PK	2.36G	55.14	74.00	-18.86	24.52	3	Horizontal	117	3.00	-	27.42	3.20	-
AV	2.3532G	44.85	54.00	-9.15	14.24	3	Horizontal	117	3.00	-	27.41	3.20	-
PK	2.4404G	96.59	Inf	-Inf	65.77	3	Horizontal	117	3.00	-	27.58	3.24	-
AV	2.44G	93.72	Inf	-Inf	62.90	3	Horizontal	117	3.00	-	27.58	3.24	-
PK	2.4972G	55.43	74.00	-18.57	24.34	3	Horizontal	117	3.00	-	27.79	3.30	-
AV	2.4928G	45.33	54.00	-8.67	14.27	3	Horizontal	117	3.00	-	27.77	3.29	-

BT-LE(1Mbps)

07/12/2020

2440MHz_TX

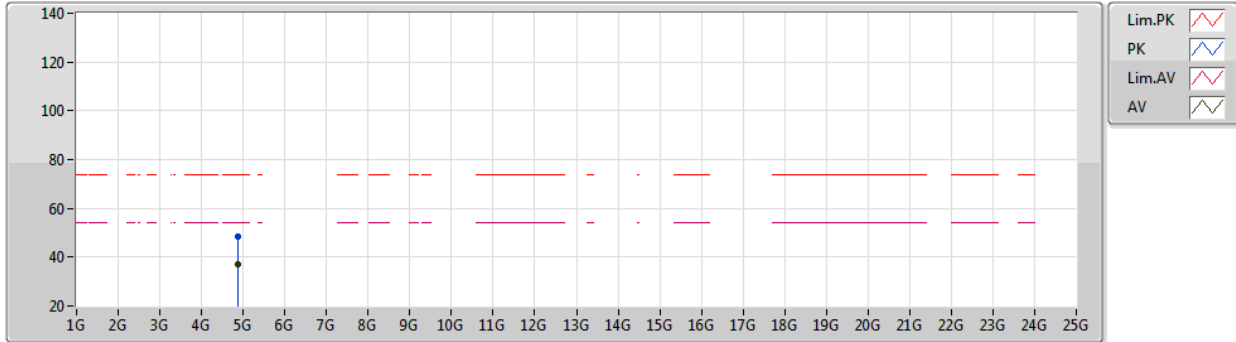

EUT Z_1TX
Setting Default
04-F-K-4

Type	Freq (Hz)	Level (dBuV/m)	Limit (dBuV/m)	Margin (dB)	Raw (dBuV)	Dist (m)	Condition	Azimuth (°)	Height (m)	Comment	AF (dB)	CL (dB)	PA (dB)
PK	4.87772G	48.23	74.00	-25.77	42.90	3	Vertical	241	2.39	-	32.76	5.44	32.87
AV	4.88368G	37.18	54.00	-16.82	31.84	3	Vertical	241	2.39	-	32.77	5.44	32.87

BT-LE(1Mbps)

07/12/2020

2440MHz_TX

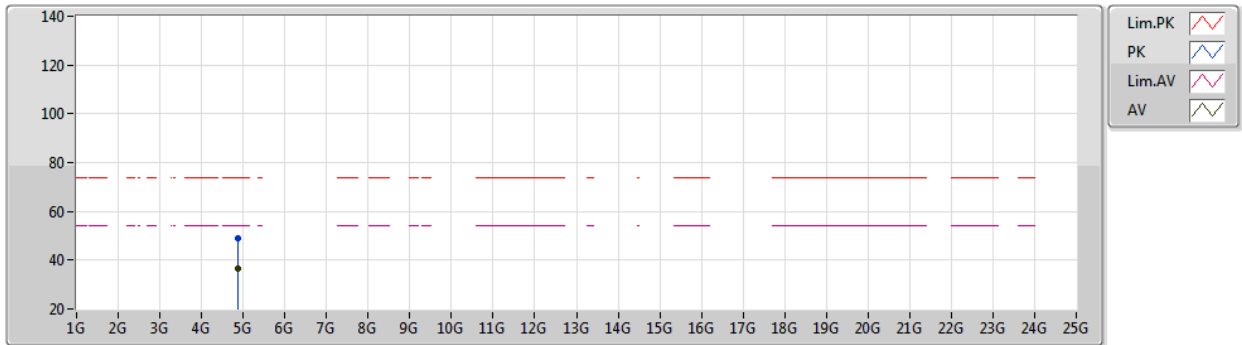

EUT Z_1TX
Setting Default
04-F-K-4

Type	Freq (Hz)	Level (dBuV/m)	Limit (dBuV/m)	Margin (dB)	Raw (dBuV)	Dist (m)	Condition	Azimuth (°)	Height (m)	Comment	AF (dB)	CL (dB)	PA (dB)
PK	4.88002G	48.76	74.00	-25.24	43.43	3	Horizontal	119	1.98	-	32.76	5.44	32.87
AV	4.88446G	36.58	54.00	-17.42	31.24	3	Horizontal	119	1.98	-	32.77	5.44	32.87

BT-LE(1Mbps)

07/12/2020

2480MHz_TX

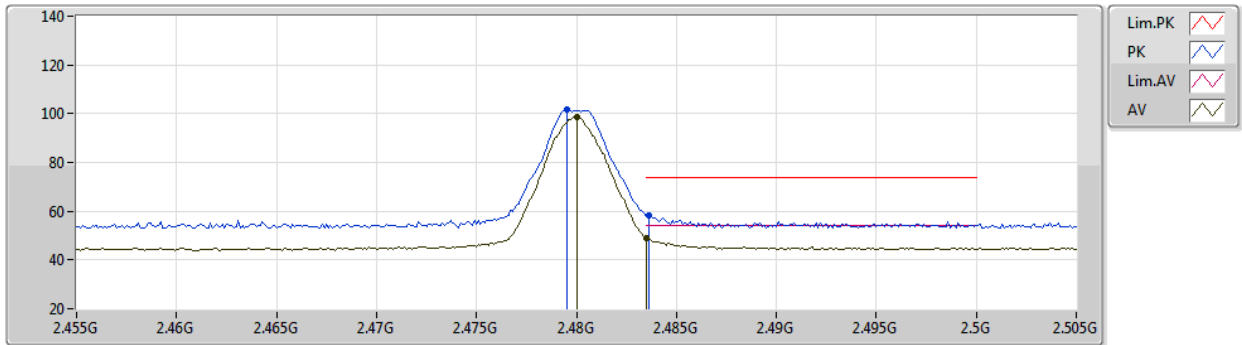

EUT Z_1TX
Setting Default
04-F-K-4

Type	Freq (Hz)	Level (dBuV/m)	Limit (dBuV/m)	Margin (dB)	Raw (dBuV)	Dist (m)	Condition	Azimuth (°)	Height (m)	Comment	AF (dB)	CL (dB)	PA (dB)
PK	2.4795G	101.50	Inf	-Inf	70.50	3	Vertical	189	2.93	-	27.72	3.28	-
AV	2.48G	98.68	Inf	-Inf	67.68	3	Vertical	189	2.93	-	27.72	3.28	-
PK	2.4836G	58.29	74.00	-15.71	27.28	3	Vertical	189	2.93	-	27.73	3.28	-
AV	2.4835G	48.83	54.00	-5.17	17.82	3	Vertical	189	2.93	-	27.73	3.28	-

BT-LE(1Mbps)

07/12/2020

2480MHz_TX

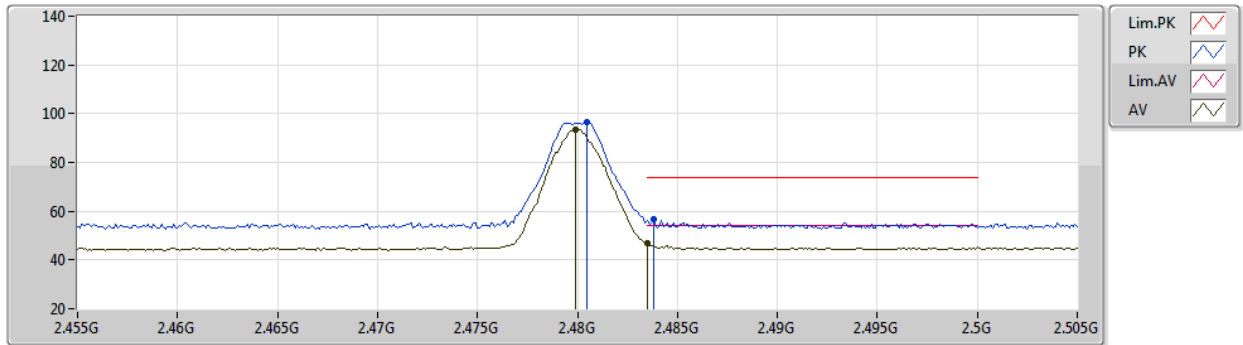

EUT_Z_1TX
Setting Default
04-F-K-4

Type	Freq (Hz)	Level (dBuV/m)	Limit (dBuV/m)	Margin (dB)	Raw (dBuV)	Dist (m)	Condition	Azimuth (°)	Height (m)	Comment	AF (dB)	CL (dB)	PA (dB)
PK	2.4805G	96.30	Inf	-Inf	65.30	3	Horizontal	121	2.60	-	27.72	3.28	-
AV	2.4799G	93.53	Inf	-Inf	62.53	3	Horizontal	121	2.60	-	27.72	3.28	-
PK	2.4838G	56.86	74.00	-17.14	25.84	3	Horizontal	121	2.60	-	27.74	3.28	-
AV	2.4835G	46.94	54.00	-7.06	15.93	3	Horizontal	121	2.60	-	27.73	3.28	-

BT-LE(1Mbps)

07/12/2020

2480MHz_TX

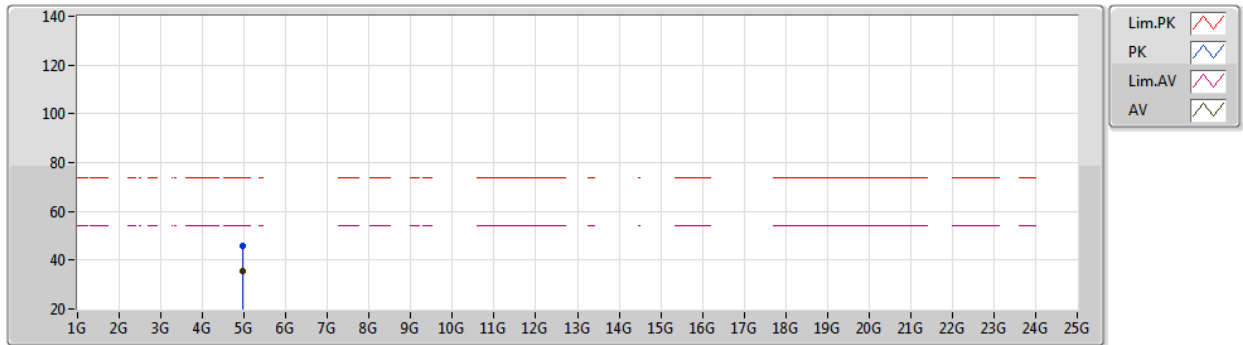

EUT Z_1TX
Setting Default
04-F-K-4

Type	Freq (Hz)	Level (dBuV/m)	Limit (dBuV/m)	Margin (dB)	Raw (dBuV)	Dist (m)	Condition	Azimuth (°)	Height (m)	Comment	AF (dB)	CL (dB)	PA (dB)
PK	4.96322G	45.83	74.00	-28.17	40.24	3	Vertical	118	1.61	-	32.97	5.48	32.86
AV	4.95832G	35.55	54.00	-18.45	29.95	3	Vertical	118	1.61	-	32.98	5.48	32.86

BT-LE(1Mbps)

07/12/2020

2480MHz_TX

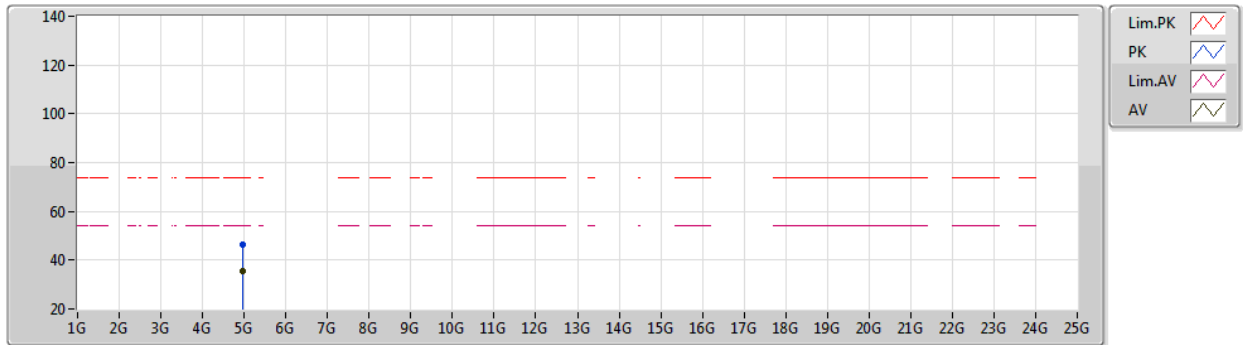

EUT Z_1TX
Setting Default
04-F-K-4

Type	Freq (Hz)	Level (dBuV/m)	Limit (dBuV/m)	Margin (dB)	Raw (dBuV)	Dist (m)	Condition	Azimuth (°)	Height (m)	Comment	AF (dB)	CL (dB)	PA (dB)
PK	4.96256G	46.19	74.00	-27.81	40.60	3	Horizontal	55	1.93	-	32.97	5.48	32.86
AV	4.9649G	35.55	54.00	-18.45	29.96	3	Horizontal	55	1.93	-	32.97	5.48	32.86



Summary

Mode	Result	Type	Freq (Hz)	Level (dBuV/m)	Limit (dBuV/m)	Margin (dB)	Condition
Mode 1	Pass	AV	1.4399G	32.31	54.00	-21.69	Vertical

