



RADIO TEST REPORT

FCC ID : 2AMQU-QN-H-245
Equipment : Dual-Band Wi-Fi 6 indoor Access Point (802.11 ax 4X4)
Brand Name : Quantum Networks
Model Name : QN-H-245
Applicant : QUANTUM NETWORKS (SG) PTE.LTD.
8 UBI ROAD 2 #08-10 ZERVEX SINGAPORE(408538),
Singapore
Manufacturer : QUANTUM NETWORKS (SG) PTE.LTD.
8 UBI ROAD 2 #08-10 ZERVEX SINGAPORE(408538),
Singapore
Standard : 47 CFR FCC Part 15.407

The product was received on Sep. 26, 2022, and testing was started from Sep. 27, 2022 and completed on Oct. 29, 2022. We, Sporton International Inc. Hsinchu Laboratory, would like to declare that the tested sample has been evaluated in accordance with the procedures given in ANSI C63.10-2013 and shown compliance with the applicable technical standards.

The test results in this report apply exclusively to the tested model / sample. Without written approval of Sporton International Inc. Hsinchu Laboratory, the test report shall not be reproduced except in full.



Approved by: Sam Chen

Sporton International Inc. Hsinchu Laboratory
No.8, Ln. 724, Bo'ai St., Zhubei City, Hsinchu County 302010, Taiwan (R.O.C.)



Table of Contents

History of this test report.....3

Summary of Test Result.....4

1 General Description5

1.1 Information.....5

1.2 Applicable Standards9

1.3 Testing Location Information9

1.4 Measurement Uncertainty10

2 Test Configuration of EUT11

2.1 Test Channel Mode11

2.2 The Worst Case Measurement Configuration12

2.3 EUT Operation during Test13

2.4 Accessories14

2.5 Support Equipment.....14

2.6 Test Setup Diagram16

3 Transmitter Test Result19

3.1 AC Power-line Conducted Emissions19

3.2 Emission Bandwidth21

3.3 Maximum Output Power22

3.4 Power Spectral Density24

3.5 Unwanted Emissions.....27

4 Test Equipment and Calibration Data31

Appendix A. Test Results of AC Power-line Conducted Emissions

Appendix B. Test Results of Emission Bandwidth

Appendix C. Test Results of Maximum Output Power

Appendix D. Test Results of Power Spectral Density

Appendix E. Test Results of Unwanted Emissions

Appendix F. Test Photos

Photographs of EUT v01



Summary of Test Result

Report Clause	Ref Std. Clause	Test Items	Result (PASS/FAIL)	Remark
1.1.2	15.203	Antenna Requirement	PASS	-
3.1	15.207	AC Power-line Conducted Emissions	PASS	-
3.2	15.407(a)	Emission Bandwidth	PASS	-
3.3	15.407(a)	Maximum Output Power	PASS	-
3.4	15.407(a)	Power Spectral Density	PASS	-
3.5	15.407(b)	Unwanted Emissions	PASS	-

Note: Reference to Sporton Project No.: FR292606AB

Declaration of Conformity:

1. The test results with all measurement uncertainty excluded are presented in accordance with the regulation limits or requirements declared by manufacturers. It's means measurement values may risk exceeding the limit of regulation standards, if measurement uncertainty is include in test results.
2. The measurement uncertainty please refer to report "Measurement Uncertainty".

Comments and Explanations:

The declared of product specification for EUT presented in the report are provided by the manufacturer, and the manufacturer takes all the responsibilities for the accuracy of product specification.

Reviewed by: Sam Chen

Report Producer: Vicky Huang



1 General Description

1.1 Information

1.1.1 RF General Information

Frequency Range (MHz)	IEEE Std. 802.11	Ch. Frequency (MHz)	Channel Number
5150-5250	a, n (HT20), ac (VHT20), ax (HEW20)	5180-5240	36-48 [4]
5725-5850		5745-5825	149-165 [5]
5150-5250	n (HT40), ac (VHT40), ax (HEW40)	5190-5230	38-46 [2]
5725-5850		5755-5795	151-159 [2]
5150-5250	ac (VHT80), ax (HEW80)	5210	42 [1]
5725-5850		5775	155 [1]

Band	Mode	BWch (MHz)	Nant
5.15-5.25GHz	802.11a	20	2TX
5.15-5.25GHz	802.11n HT20	20	2TX
5.15-5.25GHz	802.11n HT20-BF	20	2TX
5.15-5.25GHz	802.11ac VHT20	20	2TX
5.15-5.25GHz	802.11ac VHT20-BF	20	2TX
5.15-5.25GHz	802.11ax HEW20	20	2TX
5.15-5.25GHz	802.11ax HEW20-BF	20	2TX
5.15-5.25GHz	802.11n HT40	40	2TX
5.15-5.25GHz	802.11n HT40-BF	40	2TX
5.15-5.25GHz	802.11ac VHT40	40	2TX
5.15-5.25GHz	802.11ac VHT40-BF	40	2TX
5.15-5.25GHz	802.11ax HEW40	40	2TX
5.15-5.25GHz	802.11ax HEW40-BF	40	2TX
5.15-5.25GHz	802.11ac VHT80	80	2TX
5.15-5.25GHz	802.11ac VHT80-BF	80	2TX
5.15-5.25GHz	802.11ax HEW80	80	2TX
5.15-5.25GHz	802.11ax HEW80-BF	80	2TX
5.725-5.85GHz	802.11a	20	2TX
5.725-5.85GHz	802.11n HT20	20	2TX
5.725-5.85GHz	802.11n HT20-BF	20	2TX
5.725-5.85GHz	802.11ac VHT20	20	2TX
5.725-5.85GHz	802.11ac VHT20-BF	20	2TX
5.725-5.85GHz	802.11ax HEW20	20	2TX
5.725-5.85GHz	802.11ax HEW20-BF	20	2TX
5.725-5.85GHz	802.11n HT40	40	2TX



Band	Mode	BWch (MHz)	Nant
5.725-5.85GHz	802.11n HT40-BF	40	2TX
5.725-5.85GHz	802.11ac VHT40	40	2TX
5.725-5.85GHz	802.11ac VHT40-BF	40	2TX
5.725-5.85GHz	802.11ax HEW40	40	2TX
5.725-5.85GHz	802.11ax HEW40-BF	40	2TX
5.725-5.85GHz	802.11ac VHT80	80	2TX
5.725-5.85GHz	802.11ac VHT80-BF	80	2TX
5.725-5.85GHz	802.11ax HEW80	80	2TX
5.725-5.85GHz	802.11ax HEW80-BF	80	2TX

Note:

- ♦ 11a, HT20 and HT40 use a combination of OFDM-BPSK, QPSK, 16QAM, 64QAM modulation.
- ♦ VHT20, VHT40, VHT80 and VHT160 use a combination of OFDM-BPSK, QPSK, 16QAM, 64QAM, 256QAM modulation.
- ♦ HEW20, HEW40, HEW80 and HEW160 use a combination of OFDMA-BPSK, QPSK, 16QAM, 64QAM, 256QAM modulation.
- ♦ BWch is the nominal channel bandwidth.

1.1.2 Antenna Information

Ant.	Port			Brand	Model Name	Antenna Type	Connector	Gain (dBi)
	WLAN 2.4GHz	WLAN 5GHz	Bluetooth					
1	1	-	-	Accton	EC-3-PB01-001	Dipole	I-PEX	3.94
2	2	-	-	Accton	EC-3-PB01-002	PIFA	I-PEX	3.11
3	-	1	-	Accton	EC-5-PB02-001	Monopole	I-PEX	5.21
4	-	2	-	Accton	EC-5-PB02-002	Monopole	I-PEX	5.11
5	-	-	1	Accton	EC-4-PB10-001	Dipole	I-PEX	4.22

Note 1: The above information was declared by manufacturer.



Note 2: Directional gain information

Type	Maximum Output Power	Power Spectral Density
Non-BF	Directional gain = Max.gain + array gain. For power measurements on IEEE 802.11 devices Array Gain = 0 dB (i.e., no array gain) for N ANT ≤ 4	$Directional\ iGain = 10 \cdot \log \left[\frac{\sum_{j=1}^{N_{SS}} \left\{ \sum_{k=1}^{N_{ANT}} g_{j,k} \right\}^2}{N_{ANT}} \right]$
BF	$Directional\ iGain = 10 \cdot \log \left[\frac{\sum_{j=1}^{N_{SS}} \left\{ \sum_{k=1}^{N_{ANT}} g_{j,k} \right\}^2}{N_{ANT}} \right]$	$Directional\ iGain = 10 \cdot \log \left[\frac{\sum_{j=1}^{N_{SS}} \left\{ \sum_{k=1}^{N_{ANT}} g_{j,k} \right\}^2}{N_{ANT}} \right]$

Ex.

Directional Gain (NSS1) formula :

$$Directional\ iGain = 10 \cdot \log \left[\frac{\sum_{j=1}^{N_{SS}} \left\{ \sum_{k=1}^{N_{ANT}} g_{j,k} \right\}^2}{N_{ANT}} \right]$$

$$NSS1(g1,1) = 10^{G1/20} ; NSS1(g1,2) = 10^{G2/20};$$

$$g_{j,k} = (NSS1(g1,1) + NSS1(g1,2))^2$$

$$DG = 10 \log[(NSS1(g1,1) + NSS1(g1,2))^2 / N_{ANT}] => 10 \log[(10^{G1/20} + 10^{G2/20})^2 / N_{ANT}]$$

Where ;

$$G1 = 10 ; G2 = 10$$

$$2.4G \quad G1 = 3.94 \text{ dBi}; G2 = 3.11 \text{ dBi}; \quad DG = 6.55 \text{ dBi}$$

$$5G \quad G1 = 5.21 \text{ dBi}; G2 = 5.11 \text{ dBi}; \quad DG = 8.16 \text{ dBi}$$

Note 3: **For WLAN 2.4GHz function:**

For IEEE 802.11 b/g/n/VHT/ax (2TX/2RX):

Port 1 and Port 2 can be used as transmitting/receiving antenna.

Port 1 and Port 2 could transmit/receive simultaneously.

For WLAN 5GHz function:

For IEEE 802.11a/n/ac/ax (2TX/2RX):

Port 1 and Port 2 can be used as transmitting/receiving antenna.

Port 1 and Port 2 could transmit/receive simultaneously.

For Bluetooth function (1TX/1RX):

Port 1 can be used as transmitting/receiving antenna.



1.1.3 Mode Test Duty Cycle

Mode	DC	DCF(dB)	T(s)	VBW(Hz) ≥ 1/T
802.11a	0.992	0.03	n/a (DC>=0.98)	n/a (DC>=0.98)
802.11ax HEW20	0.997	0.01	n/a (DC>=0.98)	n/a (DC>=0.98)
802.11ax HEW40	0.997	0.01	n/a (DC>=0.98)	n/a (DC>=0.98)
802.11ax HEW80	0.997	0.01	n/a (DC>=0.98)	n/a (DC>=0.98)

Note:

- ◆ DC is Duty Cycle.
- ◆ DCF is Duty Cycle Factor.

1.1.4 EUT Operational Condition

EUT Power Type	From Power Adapter or PoE			
Beamforming Function	<input checked="" type="checkbox"/>	With beamforming	<input type="checkbox"/>	Without beamforming
	The product has beamforming function for n/VHT/ax in 2.4GHz and n/ac/ax in 5GHz.			
Function	<input type="checkbox"/>	Outdoor P2M	<input checked="" type="checkbox"/>	Indoor P2M
	<input type="checkbox"/>	Fixed P2P	<input type="checkbox"/>	Client
	<input checked="" type="checkbox"/>	Point-to-multipoint	<input type="checkbox"/>	Point-to-point
Channel Puncturing Function	<input type="checkbox"/>	Supported	<input checked="" type="checkbox"/>	Unsupported
Support RU	<input checked="" type="checkbox"/>	Full RU	<input type="checkbox"/>	Partial RU
Test Software Version	QSPR V5.0-00197			

Note: The above information was declared by manufacturer.



1.2 Applicable Standards

According to the specifications of the manufacturer, the EUT must comply with the requirements of the following standards:

- ◆ 47 CFR FCC Part 15
- ◆ ANSI C63.10-2013
- ◆ FCC KDB 789033 D02 v02r01

The following reference test guidance is not within the scope of accreditation of TAF.

- ◆ FCC KDB 662911 D01 v02r01
- ◆ FCC KDB 412172 D01 v01r01
- ◆ FCC KDB 414788 D01 v01r01

1.3 Testing Location Information

Testing Location Information	
Test Lab. : Sporton International Inc. Hsinchu Laboratory	
Hsinchu (TAF: 3787)	ADD: No.8, Ln. 724, Bo'ai St., Zhubei City, Hsinchu County 302010, Taiwan (R.O.C.) TEL: 886-3-656-9065 FAX: 886-3-656-9085 Test site Designation No. TW3787 with FCC. Conformity Assessment Body Identifier (CABID) TW3787 with ISED.

Test Condition	Test Site No.	Test Engineer	Test Environment (°C / %)	Test Date
RF Conducted	TH03-CB	Owen Hsu	23.6~23.7 / 56~67	Oct. 01, 2022~ Oct. 29, 2022
Radiated < 1GHz	03CH06-CB	Stim Sung	23.5-24.5 / 45-55	Oct. 20, 2022~ Oct. 21, 2022
Radiated > 1GHz	03CH02-CB	Chris Lee	23~23.5 / 55~60	Sep. 27, 2022~ Oct. 28, 2022
AC Conduction	CO01-CB	Elvin Yeh	21~23 / 58-61	Oct. 24, 2022



1.4 Measurement Uncertainty

ISO/IEC 17025 requires that an estimate of the measurement uncertainties associated with the emissions test results be included in the report. The measurement uncertainties given below are based on a 95% confidence level (based on a coverage factor (k=2))

Test Items	Uncertainty	Remark
Conducted Emission (150kHz ~ 30MHz)	3.4 dB	Confidence levels of 95%
Radiated Emission (9kHz ~ 30MHz)	3.4 dB	Confidence levels of 95%
Radiated Emission (30MHz ~ 1,000MHz)	5.6 dB	Confidence levels of 95%
Radiated Emission (1GHz ~ 18GHz)	5.2 dB	Confidence levels of 95%
Radiated Emission (18GHz ~ 40GHz)	4.7 dB	Confidence levels of 95%
Conducted Emission	3.2 dB	Confidence levels of 95%
Output Power Measurement	0.8 dB	Confidence levels of 95%
Power Density Measurement	3.2 dB	Confidence levels of 95%
Bandwidth Measurement	2.0 %	Confidence levels of 95%



2 Test Configuration of EUT

2.1 Test Channel Mode

Mode	Power Setting
5.15-5.25GHz_802.11a_Nss1,(6Mbps)_2TX	-
5180MHz	18
5200MHz	20.5
5240MHz	21
5745MHz	22.5
5785MHz	22
5825MHz	22.5
5.15-5.25GHz_802.11ax HEW20_Nss1,(MCS0)_2TX	-
5180MHz	18.5
5200MHz	20.5
5240MHz	20.5
5745MHz	21
5785MHz	24
5825MHz	20.5
5.15-5.25GHz_802.11ax HEW40_Nss1,(MCS0)_2TX	-
5190MHz	14.5
5230MHz	19
5755MHz	19.5
5795MHz	20
5.15-5.25GHz_802.11ax HEW80_Nss1,(MCS0)_2TX	-
5210MHz	13.5
5775MHz	17
5.15-5.25GHz_802.11ax HEW20-BF_Nss1,(MCS0)_2TX	-
5180MHz	18.5
5200MHz	20.5
5240MHz	22.5
5745MHz	21
5785MHz	24
5825MHz	20.5
5.15-5.25GHz_802.11ax HEW40-BF_Nss1,(MCS0)_2TX	-
5190MHz	14.5
5230MHz	19
5755MHz	19.5
5795MHz	20
5.15-5.25GHz_802.11ax HEW80-BF_Nss1,(MCS0)_2TX	-
5210MHz	13.5



Mode	Power Setting
5775MHz	17

Note:

- ♦ HEW20 / HEW40 / HEW80 covers HT20 / HT40 / VHT20 / VHT40 / VHT80 due to similar modulation. The power setting for HT20 / HT40 / VHT20 / VHT40 / VHT80 is the same or lower than HEW20 / HEW40 / HEW80.
- ♦ The EUT supports non-beamforming and beamforming modes, after evaluating, the non-beamforming mode has been evaluated to be the worst case, so it was selected to test. The beamforming mode evaluates the output power only.

2.2 The Worst Case Measurement Configuration

The Worst Case Mode for Following Conformance Tests	
Tests Item	AC power-line conducted emissions
Condition	AC power-line conducted measurement for line and neutral Test Voltage: 120Vac / 60Hz
Operating Mode	Normal Link
1	EUT + Adapter
2	EUT + PoE
Mode 2 generated the worst test result, so it was recorded in this report.	

The Worst Case Mode for Following Conformance Tests	
Tests Item	Emission Bandwidth Maximum Output Power Power Spectral Density
Test Condition	Conducted measurement at transmit chains



The Worst Case Mode for Following Conformance Tests	
Tests Item	Unwanted Emissions
Test Condition	Radiated measurement If EUT consist of multiple antenna assembly (multiple antenna are used in EUT regardless of spatial multiplexing MIMO configuration), the radiated test should be performed with highest antenna gain of each antenna type.
Operating Mode < 1GHz	Normal Link
1	Normal link: EUT in X axis + Adapter
2	Normal link: EUT in Y axis + Adapter
3	Normal link: EUT in Z axis + Adapter
Mode 3 has been evaluated to be the worst case among Mode 1~3, thus measurement for Mode 4 will follow this same test mode.	
4	Normal link: EUT in Z axis + PoE
Mode 3 generated the worst test result, so it was recorded in this report.	
Operating Mode > 1GHz	CTX
After evaluating, the worst case was found as below. So the measurement will follow this same test configuration.	
1	EUT in X axis

The Worst Case Mode for Following Conformance Tests	
Tests Item	Simultaneous Transmission Analysis - Co-location RF Exposure Evaluation
Operating Mode	
1	WLAN 2.4GHz + WLAN 5GHz + Bluetooth
Refer to Sporton Test Report No.: FA292606-02 for Co-location RF Exposure Evaluation.	

Note: The adapter and PoE were for measurement only and would not be marketed. Their information is showed as below:

Equipment	Brand	Model
Adapter	ITE	MU12AR120100-A1
PoE	PHIHONG	POEA30U-1ATE

2.3 EUT Operation during Test

For CTX Mode:

The EUT was programmed to be in continuously transmitting mode.

For Normal Link Mode:

During the test, the EUT operation to normal function.



2.4 Accessories

Others
Wall-mounted rack*1
RJ-45 cable*1 (Non-shielded, 0.05m)

2.5 Support Equipment

For AC Conduction:

Support Equipment				
No.	Equipment	Brand Name	Model Name	FCC ID
A	Pass-Thru NB	DELL	E6430	N/A
B	LAN1 NB	DELL	E6430	N/A
C	Device NB	DELL	E6430	N/A
D	Device	Accton	EAP104	N/A
E	2.4G NB	DELL	E6430	N/A
F	5G NB	DELL	E6430	N/A
G	iPad	Apple	A1430	N/A
H	PoE	PHIHONG	POEA30U-1ATE	N/A
I	LAN4 NB	DELL	E6430	N/A

For Radiated (below 1GHz):

Support Equipment				
No.	Equipment	Brand Name	Model Name	FCC ID
A	LAN1 NB	DELL	E4300	N/A
B	Pass-Thru NB	DELL	E4300	N/A
C	iPad	Apple	A1430	N/A
D	2.4G NB	DELL	E4300	N/A
E	5G NB	DELL	E4300	N/A
F	Adapter	ITE	MU12AR120100-A1	N/A

For Radiated (above 1GHz):

Support Equipment				
No.	Equipment	Brand Name	Model Name	FCC ID
A	NB	Lenovo	L440	N/A
B	Adapter	ITE	MU12AR120100-A1	N/A



For RF Conducted:

Support Equipment				
No.	Equipment	Brand Name	Model Name	FCC ID
A	NB	DELL	E4300	N/A
B	AC Adapter	ITE	MU12AR120100-A1	N/A

2.6 Test Setup Diagram

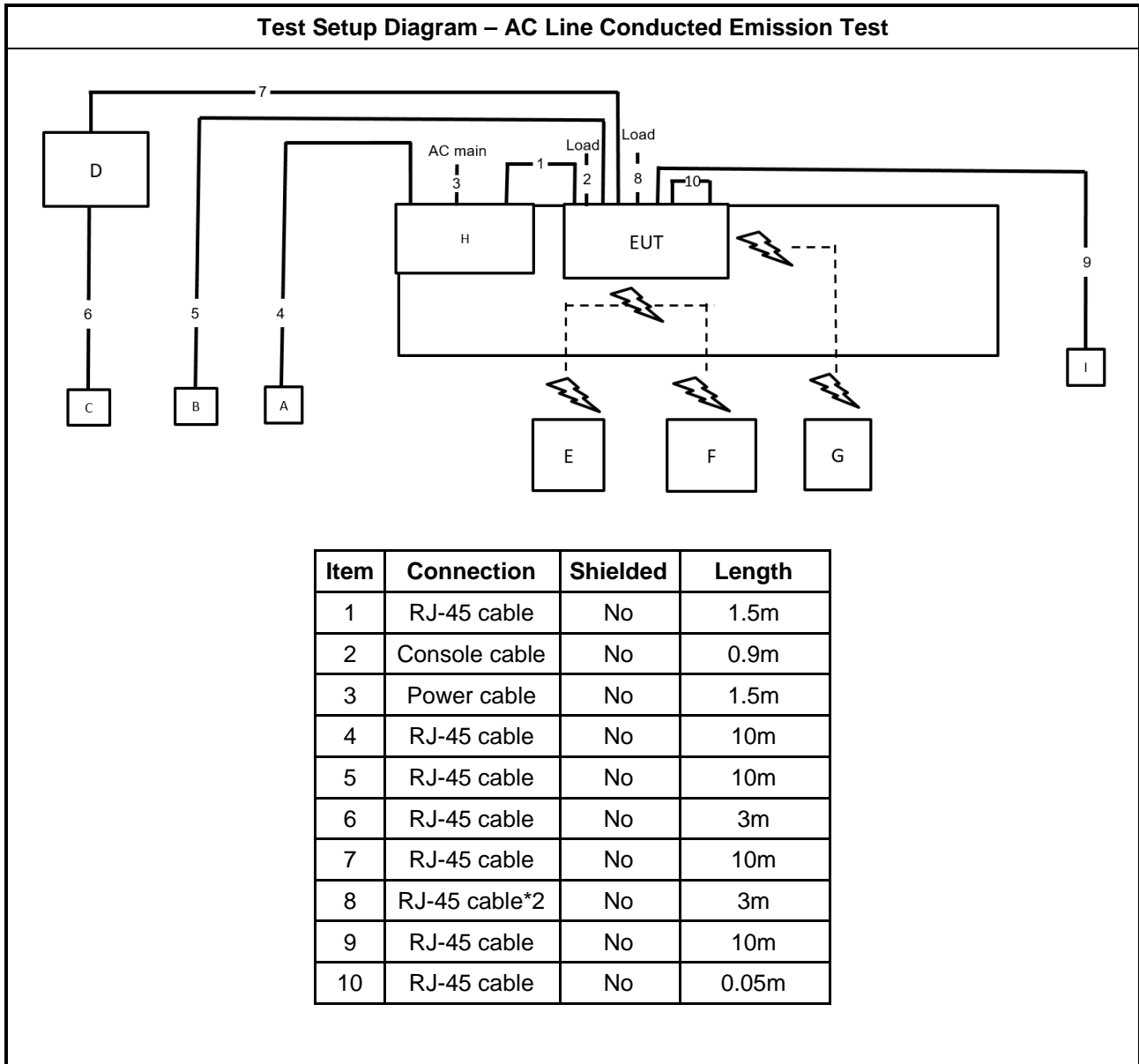

Test Setup Diagram - Radiated Test < 1GHz

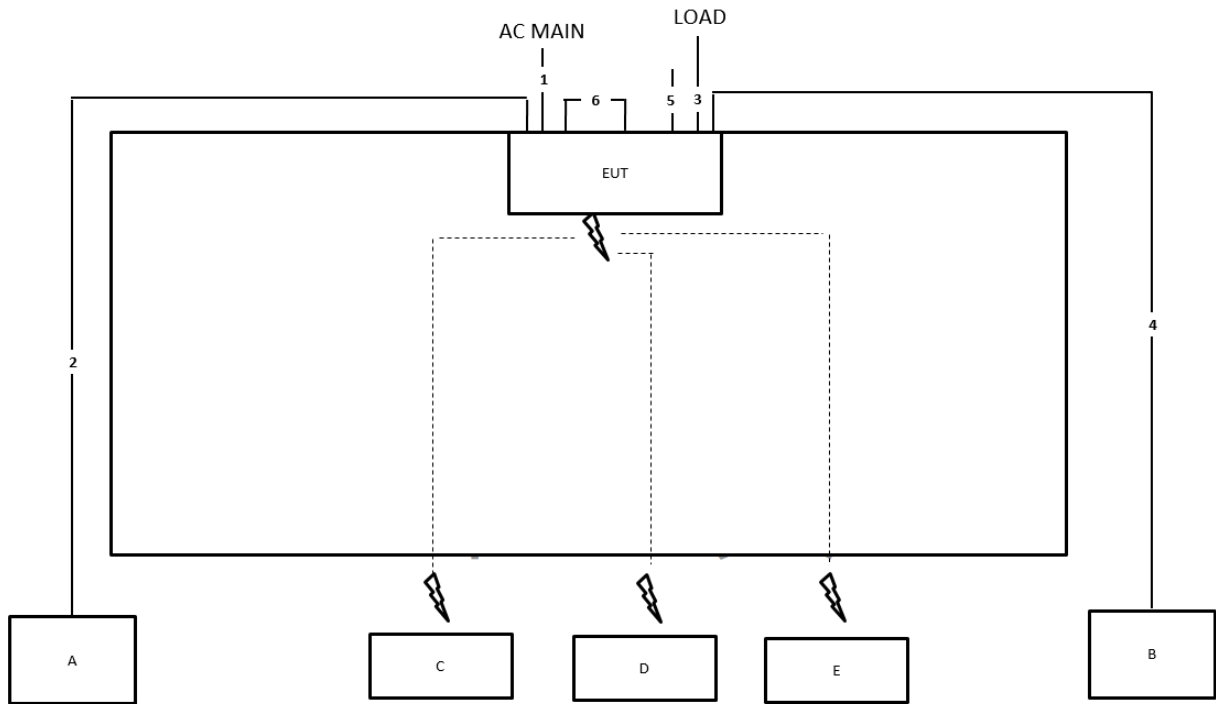

Item	Connection	Shielded	Length
1	Power cable	No	1.5m
2	RJ-45 cable	No	10m
3	RJ-45 cable*3	No	1.5m
4	RJ-45 cable	No	10m
5	Console cable	Yes	0.9m
6	RJ-45 cable	No	0.05m

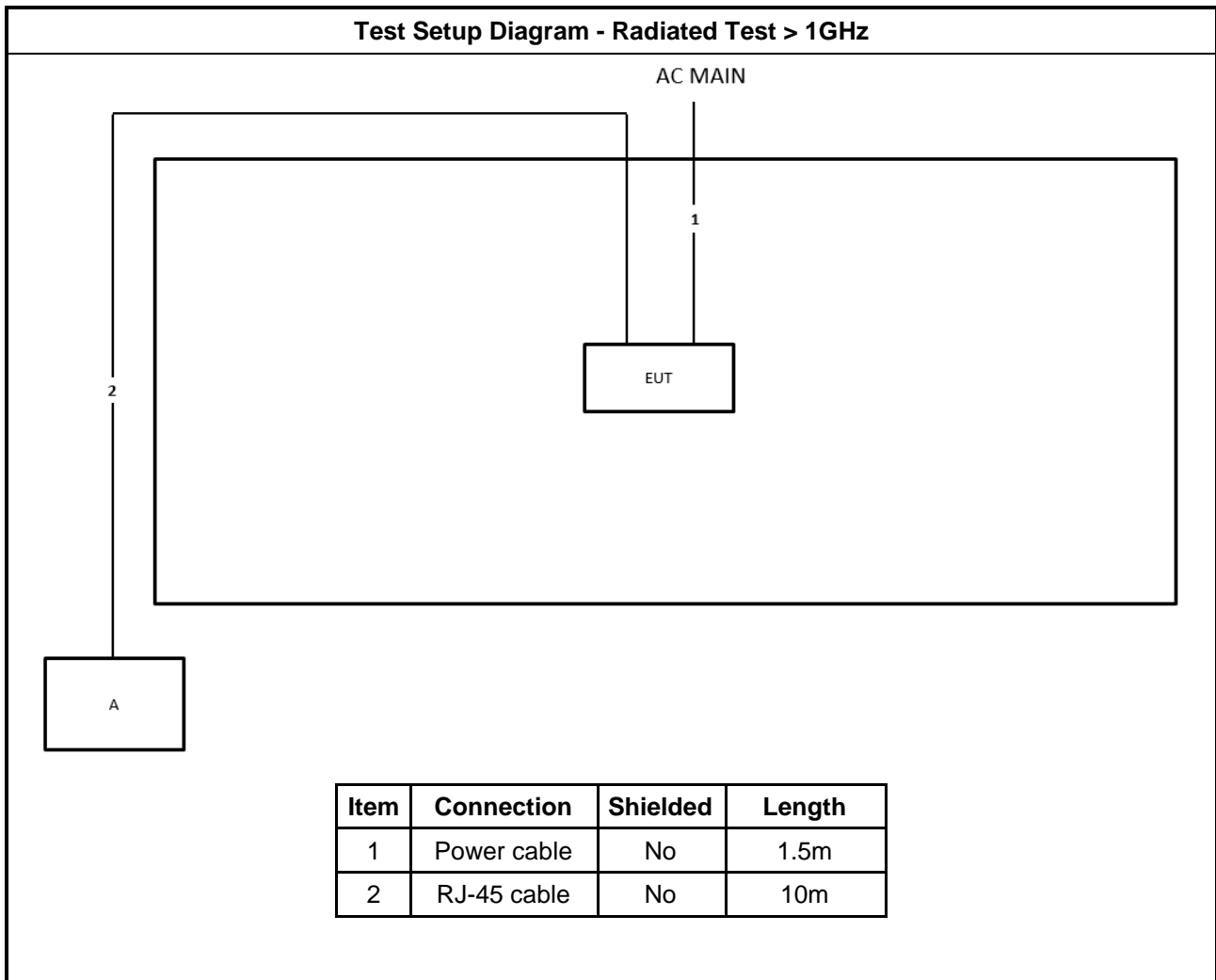



3 Transmitter Test Result

3.1 AC Power-line Conducted Emissions

3.1.1 AC Power-line Conducted Emissions Limit

AC Power-line Conducted Emissions Limit		
Frequency Emission (MHz)	Quasi-Peak	Average
0.15-0.5	66 - 56 *	56 - 46 *
0.5-5	56	46
5-30	60	50

Note 1: * Decreases with the logarithm of the frequency.

3.1.2 Measuring Instruments

Refer a test equipment and calibration data table in this test report.

3.1.3 Test Procedures

Test Method
<input checked="" type="checkbox"/> Refer as ANSI C63.10-2013, clause 6.2 for AC power-line conducted emissions.

3.1.4 Test Setup

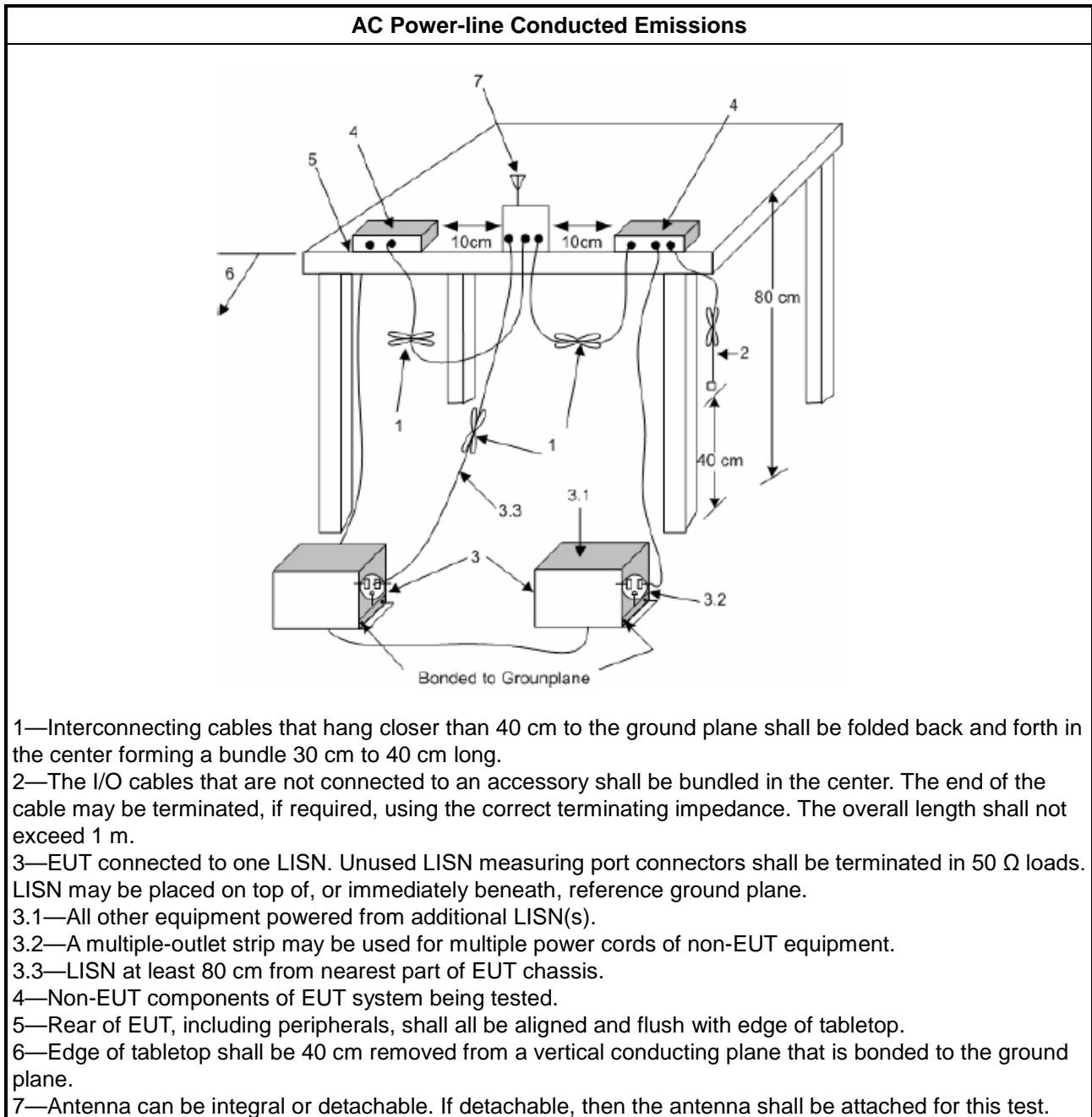

3.1.5 Measurement Results Calculation

The measured Level is calculated using:

- a. Corrected Reading: LISN Factor (LISN) + Attenuator (AT/AUX) + Cable Loss (CL) + Read Level (Raw) = Level
- b. Margin = -Limit + Level

3.1.6 Test Result of AC Power-line Conducted Emissions

Refer as Appendix A

3.2 Emission Bandwidth

3.2.1 Emission Bandwidth Limit

Emission Bandwidth Limit	
UNII Devices	
<input checked="" type="checkbox"/>	For the 5.15-5.25 GHz band, N/A
<input type="checkbox"/>	For the 5.25-5.35 GHz band, the maximum conducted output power shall not exceed the lesser of 250 mW or 11 dBm + 10 log B, where B is the 26 dB emission bandwidth in MHz.
<input type="checkbox"/>	For the 5.47-5.725 GHz band, the maximum conducted output power shall not exceed the lesser of 250 mW or 11 dBm + 10 log B, where B is the 26 dB emission bandwidth in MHz.
<input checked="" type="checkbox"/>	For the 5.725-5.85 GHz band, 26 dB emission bandwidth ,N/A. 6 dB emission bandwidth ≥ 500kHz.
LE-LAN Devices	
<input type="checkbox"/>	For the band 5.15-5.25 GHz, the maximum e.i.r.p. shall not exceed 200 mW or 10 + 10 log B, dBm, whichever power is less. B is the 99% emission bandwidth in MHz.
<input type="checkbox"/>	For the 5.25-5.35 GHz band, the maximum e.i.r.p. shall not exceed 1.0 W or 17 + 10 log B, dBm, whichever power is less. B is the 99% emission bandwidth in MHz
<input type="checkbox"/>	For the 5.47-5.6 GHz band and 5.65-5.725 GHz band, the maximum e.i.r.p. shall not exceed 1.0 W or 17 + 10 log B, dBm, whichever power is less. B is the 99% emission bandwidth in MHz
<input type="checkbox"/>	For the 5.725-5.85 GHz band, 6 dB emission bandwidth ≥ 500kHz.

3.2.2 Measuring Instruments

Refer a test equipment and calibration data table in this test report.

3.2.3 Test Procedures

Test Method							
<ul style="list-style-type: none"> ▪ For the emission bandwidth shall be measured using one of the options below: <table border="1" style="width: 100%; border-collapse: collapse;"> <tr> <td style="width: 20px;"><input checked="" type="checkbox"/></td> <td>Refer as FCC KDB 789033 D02, clause C for EBW and clause D for OBW measurement.</td> </tr> <tr> <td><input type="checkbox"/></td> <td>Refer as ANSI C63.10, clause 6.9.1 for occupied bandwidth testing.</td> </tr> <tr> <td><input type="checkbox"/></td> <td>Refer as IC RSS-Gen, clause 4.6 for bandwidth testing.</td> </tr> </table> 		<input checked="" type="checkbox"/>	Refer as FCC KDB 789033 D02, clause C for EBW and clause D for OBW measurement.	<input type="checkbox"/>	Refer as ANSI C63.10, clause 6.9.1 for occupied bandwidth testing.	<input type="checkbox"/>	Refer as IC RSS-Gen, clause 4.6 for bandwidth testing.
<input checked="" type="checkbox"/>	Refer as FCC KDB 789033 D02, clause C for EBW and clause D for OBW measurement.						
<input type="checkbox"/>	Refer as ANSI C63.10, clause 6.9.1 for occupied bandwidth testing.						
<input type="checkbox"/>	Refer as IC RSS-Gen, clause 4.6 for bandwidth testing.						

3.2.4 Test Setup

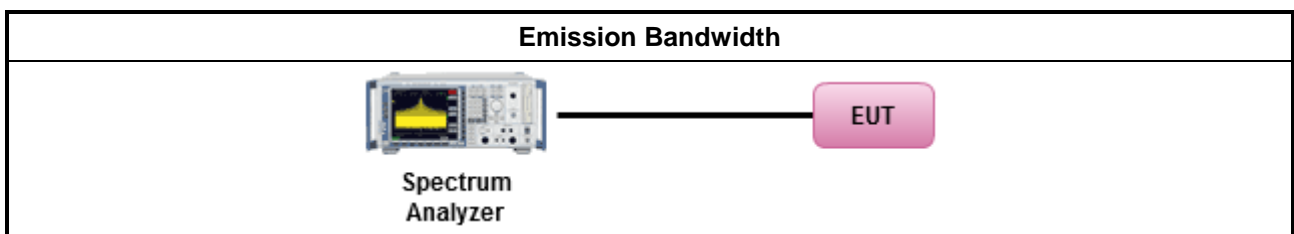

3.2.5 Test Result of Emission Bandwidth

Refer as Appendix B



3.3 Maximum Output Power

3.3.1 Limit

Maximum Output Power Limit	
UNII Devices	
<input checked="" type="checkbox"/> For the 5.15-5.25 GHz band:	
	<ul style="list-style-type: none"> ▪ Outdoor AP: the maximum conducted output power (P_{Out}) shall not exceed the lesser of 1 W. If $G_{TX} > 6$ dBi, then $P_{Out} = 30 - (G_{TX} - 6)$. e.i.r.p. at any elevation angle above 30 degrees $\leq 125mW$ [21dBm] ▪ Indoor AP: the maximum conducted output power (P_{Out}) shall not exceed the lesser of 1 W. If $G_{TX} > 6$ dBi, then $P_{Out} = 30 - (G_{TX} - 6)$ ▪ Point-to-point AP: the maximum conducted output power (P_{Out}) shall not exceed the lesser of 1 W. If $G_{TX} > 23$ dBi, then $P_{Out} = 30 - (G_{TX} - 23)$. ▪ Mobile or Portable Client: the maximum conducted output power (P_{Out}) shall not exceed the lesser of 250 mW. If $G_{TX} > 6$ dBi, then $P_{Out} = 24 - (G_{TX} - 6)$.
<input type="checkbox"/> For the 5.25-5.35 GHz band, the maximum conducted output power (P_{Out}) shall not exceed the lesser of 250 mW or $11 \text{ dBm} + 10 \log B$, where B is the 26 dB emission bandwidth in MHz. If $G_{TX} > 6$ dBi, then $P_{Out} = 24 - (G_{TX} - 6)$.	
<input type="checkbox"/> For the 5.47-5.725 GHz band, the maximum conducted output power (P_{Out}) shall not exceed the lesser of 250 mW or $11 \text{ dBm} + 10 \log B$, where B is the 26 dB emission bandwidth in MHz. If $G_{TX} > 6$ dBi, then $P_{Out} = 24 - (G_{TX} - 6)$.	
<input checked="" type="checkbox"/> For the 5.725-5.85 GHz band:	
	<ul style="list-style-type: none"> ▪ Point-to-multipoint systems (P2M): the maximum conducted output power (P_{Out}) shall not exceed the lesser of 1 W. If $G_{TX} > 6$ dBi, then $P_{Out} = 30 - (G_{TX} - 6)$. ▪ Point-to-point systems (P2P): the maximum conducted output power (P_{Out}) shall not exceed the lesser of 1 W.
LE-LAN Devices	
<input type="checkbox"/> For the 5.15-5.25 GHz band, the maximum e.i.r.p. shall not exceed 200 mW or $10 + 10 \log B$, dBm, whichever power is less. B is the 99% emission bandwidth in MHz.	
<input type="checkbox"/> For the 5.25-5.35 GHz band, the maximum e.i.r.p. shall not exceed 1.0 W or $17 + 10 \log B$, dBm, whichever power is less. B is the 99% emission bandwidth in MHz	
<input type="checkbox"/> For the 5.47-5.6 GHz band and 5.65-5.725 GHz band, the maximum e.i.r.p. shall not exceed 1.0 W or $17 + 10 \log B$, dBm, whichever power is less. B is the 99% emission bandwidth in MHz	
<input type="checkbox"/> For the 5.725-5.85 GHz band:	
	<ul style="list-style-type: none"> ▪ Point-to-multipoint systems (P2M): the maximum conducted output power (P_{Out}) shall not exceed the lesser of 1 W. If $G_{TX} > 6$ dBi, then $P_{Out} = 30 - (G_{TX} - 6)$. ▪ Point-to-point systems (P2P): the maximum conducted output power (P_{Out}) shall not exceed the lesser of 1 W.
P_{Out} = maximum conducted output power in dBm, G_{TX} = the maximum transmitting antenna directional gain in dBi.	

3.3.2 Measuring Instruments

Refer a test equipment and calibration data table in this test report.

3.3.3 Test Procedures

Test Method	
	Average over on/off periods with duty factor
<input type="checkbox"/>	Refer as FCC KDB 789033 D02, clause E Method SA-2 (spectral trace averaging).
<input type="checkbox"/>	Refer as FCC KDB 789033 D02, clause E Method SA-2 Alt. (RMS detection with slow sweep speed)
	Wideband RF power meter and average over on/off periods with duty factor
<input checked="" type="checkbox"/>	Refer as FCC KDB 789033 D02, clause E Method PM-G (using an RF average power meter).
<input checked="" type="checkbox"/>	For conducted measurement.
	<ul style="list-style-type: none"> If the EUT supports multiple transmit chains using options given below: Refer as FCC KDB 662911, In-band power measurements. Using the measure-and-sum approach, measured all transmit ports individually. Sum the power (in linear power units e.g., mW) of all ports for each individual sample and save them.
	<ul style="list-style-type: none"> If multiple transmit chains, EIRP calculation could be following as methods: $P_{total} = P_1 + P_2 + \dots + P_n$ (calculated in linear unit [mW] and transfer to log unit [dBm]) $EIRP_{total} = P_{total} + DG$
<input type="checkbox"/>	For radiated measurement.
	<ul style="list-style-type: none"> Refer as FCC KDB 789033 D02 clause II A.1.F "Antenna-port Conducted versus Radiated Testing" Refer as ANSI C63.10, clause 6.6 for radiated emissions above 1GHz. Refer as FCC KDB 412172 D01 clause 2.2 for EIRP calculation.

3.3.4 Test Setup

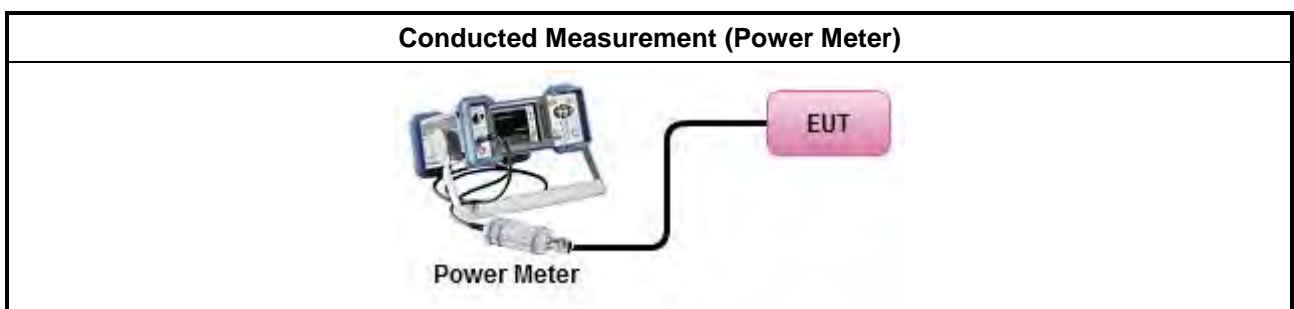

3.3.5 Test Result of Maximum Output Power

Refer as Appendix C



3.4 Power Spectral Density

3.4.1 Limit

Peak Power Spectral Density Limit	
UNII Devices	
<input checked="" type="checkbox"/> For the 5.15-5.25 GHz band:	
	<ul style="list-style-type: none"> ▪ Outdoor AP: the peak power spectral density (PPSD) shall not exceed the lesser of 17dBm/MHz. If $G_{TX} > 6$ dBi, then $P_{Out} = 17 - (G_{TX} - 6)$. ▪ Indoor AP: the peak power spectral density (PPSD) shall not exceed the lesser of 17dBm/MHz. If $G_{TX} > 6$ dBi, then $P_{Out} = 17 - (G_{TX} - 6)$. ▪ Point-to-point AP: the peak power spectral density (PPSD) shall not exceed the lesser of 17dBm/MHz. If $G_{TX} > 23$ dBi, then $P_{Out} = 17 - (G_{TX} - 23)$. ▪ Mobile or Portable Client: the peak power spectral density (PPSD) ≤ 11 dBm/MHz. If $G_{TX} > 6$ dBi, then $PPSD = 11 - (G_{TX} - 6)$.
<input type="checkbox"/> For the 5.25-5.35 GHz band, the peak power spectral density (PPSD) ≤ 11 dBm/MHz. If $G_{TX} > 6$ dBi, then $PPSD = 11 - (G_{TX} - 6)$.	
<input type="checkbox"/> For the 5.47-5.725 GHz band, the peak power spectral density (PPSD) ≤ 11 dBm/MHz. If $G_{TX} > 6$ dBi, then $PPSD = 11 - (G_{TX} - 6)$.	
<input checked="" type="checkbox"/> For the 5.725-5.85 GHz band:	
	<ul style="list-style-type: none"> ▪ Point-to-multipoint systems (P2M): the peak power spectral density (PPSD) ≤ 30 dBm/500kHz. If $G_{TX} > 6$ dBi, then $PPSD = 30 - (G_{TX} - 6)$. ▪ Point-to-point systems (P2P): the peak power spectral density (PPSD) ≤ 30 dBm/500kHz.
LE-LAN Devices	
<input type="checkbox"/> For the 5.15-5.25 GHz band, the e.i.r.p. peak power spectral density (PPSD) ≤ 10 dBm/MHz.	
<input type="checkbox"/> For the 5.25-5.35 GHz band, the peak power spectral density (PPSD) ≤ 11 dBm/MHz.	
	<ul style="list-style-type: none"> ▪ e.i.r.p. greater than 200 mW shall comply with the following e.i.r.p. at different elevations, where θ is the angle above the local horizontal plane (of the Earth) as shown below: -13 dBW/MHz for $0^\circ \leq \theta < 8^\circ$; -13 - 0.716 ($\theta - 8$) dBW/MHz for $8^\circ \leq \theta < 40^\circ$ -35.9 - 1.22 ($\theta - 40$) dBW/MHz for $40^\circ \leq \theta \leq 45^\circ$; -42 dBW/MHz for $\theta > 45^\circ$
<input type="checkbox"/> For the 5.47-5.6 GHz band and 5.65-5.725 GHz band, the peak power spectral density (PPSD) ≤ 11 dBm/MHz.	
<input type="checkbox"/> For the 5.725-5.85 GHz band:	
	<ul style="list-style-type: none"> ▪ Point-to-multipoint systems (P2M): the peak power spectral density (PPSD) ≤ 30 dBm/500kHz. If $G_{TX} > 6$ dBi, then $PPSD = 30 - (G_{TX} - 6)$. ▪ Point-to-point systems (P2P): the peak power spectral density (PPSD) ≤ 30 dBm/500kHz.
<p>PPSD = peak power spectral density that he same method as used to determine the conducted output power shall be used to determine the power spectral density. And power spectral density in dBm/MHz G_{TX} = the maximum transmitting antenna directional gain in dBi.</p>	



3.4.2 Measuring Instruments

Refer a test equipment and calibration data table in this test report.

3.4.3 Test Procedures

Test Method	
<ul style="list-style-type: none"> ▪ Peak power spectral density procedures that the same method as used to determine the conducted output power shall be used to determine the peak power spectral density and use the peak search function on the spectrum analyzer to find the peak of the spectrum. For the peak power spectral density shall be measured using below options: 	
<input type="checkbox"/>	Refer as FCC KDB 789033 D02, F5) power spectral density can be measured using resolution bandwidths < 1 MHz provided that the results are integrated over 1 MHz bandwidth
[duty cycle ≥ 98% or external video / power trigger]	
<input checked="" type="checkbox"/>	Refer as FCC KDB 789033 D02, clause E Method SA-1 (spectral trace averaging).
<input type="checkbox"/>	Refer as FCC KDB 789033 D02, clause E Method SA-1 Alt. (RMS detection with slow sweep speed)
duty cycle < 98% and average over on/off periods with duty factor	
<input checked="" type="checkbox"/>	Refer as FCC KDB 789033 D02, clause E Method SA-2 (spectral trace averaging).
<input type="checkbox"/>	Refer as FCC KDB 789033 D02, clause E Method SA-2 Alt. (RMS detection with slow sweep speed)
<input checked="" type="checkbox"/>	For conducted measurement.
<ul style="list-style-type: none"> ▪ If the EUT supports multiple transmit chains using options given below: 	
<input checked="" type="checkbox"/>	Option 1: Measure and sum the spectra across the outputs. Refer as FCC KDB 662911, In-band power spectral density (PSD). Sample all transmit ports simultaneously using a spectrum analyzer for each transmit port. Where the trace bin-by-bin of each transmit port summing can be performed. (i.e., in the first spectral bin of output 1 is summed with that in the first spectral bin of output 2 and that from the first spectral bin of output 3, and so on up to the NTX output to obtain the value for the first frequency bin of the summed spectrum.). Add up the amplitude (power) values for the different transmit chains and use this as the new data trace.
<input type="checkbox"/>	Option 2: Measure and sum spectral maxima across the outputs. With this technique, spectra are measured at each output of the device at the required resolution bandwidth. The maximum value (peak) of each spectrum is determined. These maximum values are then summed mathematically in linear power units across the outputs. These operations shall be performed separately over frequency spans that have different out-of-band or spurious emission limits,
<input type="checkbox"/>	Option 3: Measure and add 10 log(N) dB, where N is the number of transmit chains. Refer as FCC KDB 662911, In-band power spectral density (PSD). Performed at each transmit chains and each transmit chains shall be compared with the limit have been reduced with 10 log(N). Or each transmit chains shall be add 10 log(N) to compared with the limit.
<ul style="list-style-type: none"> ▪ If multiple transmit chains, EIRP PPSD calculation could be following as methods: $PPSD_{total} = PPSD_1 + PPSD_2 + \dots + PPSD_n$ (calculated in linear unit [mW] and transfer to log unit [dBm]) $EIRP_{total} = PPSD_{total} + DG$ 	
<input type="checkbox"/>	For radiated measurement.

Test Method	
	<ul style="list-style-type: none"> ▪ Refer as FCC KDB 789033 D02 clause II A.1.F "Antenna-port Conducted versus Radiated Testing"
	<ul style="list-style-type: none"> ▪ Refer as ANSI C63.10, clause 6.6 for radiated emissions above 1GHz.
	<ul style="list-style-type: none"> ▪ Refer as FCC KDB 412172 D01 clause 2.2 for EIRP calculation.

3.4.4 Test Setup

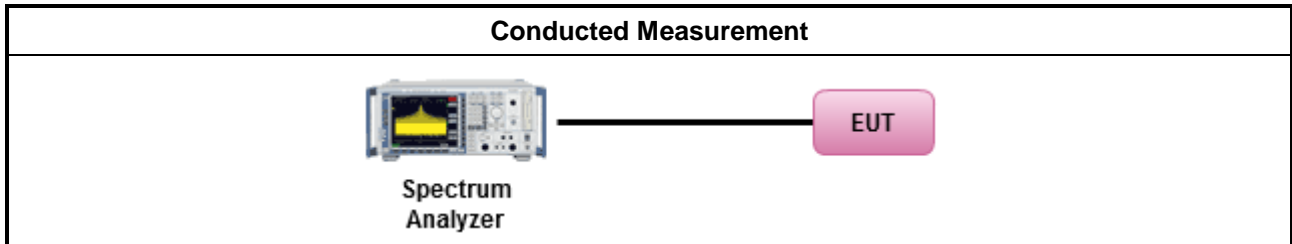

3.4.5 Test Result of Power Spectral Density

Refer as Appendix D



3.5 Unwanted Emissions

3.5.1 Transmitter Unwanted Emissions Limit

Unwanted emissions below 1 GHz and restricted band emissions above 1GHz limit			
Frequency Range (MHz)	Field Strength (uV/m)	Field Strength (dBuV/m)	Measure Distance (m)
0.009~0.490	2400/F(kHz)	48.5 - 13.8	300
0.490~1.705	24000/F(kHz)	33.8 - 23	30
1.705~30.0	30	29	30
30~88	100	40	3
88~216	150	43.5	3
216~960	200	46	3
Above 960	500	54	3

Note 1: Test distance for frequencies at or above 30 MHz, measurements may be performed at a distance other than the limit distance provided they are not performed in the near field and the emissions to be measured can be detected by the measurement equipment. When performing measurements at a distance other than that specified, the results shall be extrapolated to the specified distance using an extrapolation factor of 20 dB/decade (inverse of linear distance for field-strength measurements, inverse of linear distance-squared for power-density measurements).

Note 2: Test distance for frequencies at below 30 MHz, measurements may be performed at a distance closer than the EUT limit distance; however, an attempt should be made to avoid making measurements in the near field. When performing measurements below 30 MHz at a closer distance than the limit distance, the results shall be extrapolated to the specified distance by either making measurements at a minimum of two or more distances on at least one radial to determine the proper extrapolation factor or by using the square of an inverse linear distance extrapolation factor (40 dB/decade). The test report shall specify the extrapolation method used to determine compliance of the EUT.

Note 3: Using the distance of 1m during the test for above 18 GHz, and the test value to correct for the distance factor at 3m.

Un-restricted band emissions above 1GHz Limit	
Operating Band	Limit
<input checked="" type="checkbox"/> 5.15 - 5.25 GHz	e.i.r.p. -27 dBm [68.2 dBuV/m @3m]
<input type="checkbox"/> 5.25 - 5.35 GHz	e.i.r.p. -27 dBm [68.2 dBuV/m @3m]
<input type="checkbox"/> 5.47 - 5.725 GHz	e.i.r.p. -27 dBm [68.2 dBuV/m @3m]
<input checked="" type="checkbox"/> 5.725 - 5.85 GHz	all emissions shall be limited to a level of -27 dBm/MHz at 75 MHz or more above or below the band edge increasing linearly to 10 dBm/MHz at 25 MHz above or below the band edge, and from 25 MHz above or below the band edge increasing linearly to a level of 15.6 dBm/MHz at 5 MHz above or below the band edge, and from 5 MHz above or below the band edge increasing linearly to a level of 27 dBm/MHz at the band edge.

Note 1: Measurements may be performed at a distance other than the limit distance provided they are not performed in the near field and the emissions to be measured can be detected by the measurement equipment. When performing measurements at a distance other than that specified, the results shall be extrapolated to the specified distance using an extrapolation factor of 20 dB/decade (inverse of



linear distance for field-strength measurements, inverse of linear distance-squared for power-density measurements).

3.5.2 Measuring Instruments

Refer a test equipment and calibration data table in this test report.

3.5.3 Test Procedures

Test Method	
<ul style="list-style-type: none"> ▪ Measurements may be performed at a distance other than the limit distance provided they are not performed in the near field and the emissions to be measured can be detected by the measurement equipment. Measurements shall not be performed at a distance greater than 30 m for frequencies above 30 MHz, unless it can be further demonstrated that measurements at a distance of 30 m or less are impractical. When performing measurements at a distance other than that specified, the results shall be extrapolated to the specified distance using an extrapolation factor of 20 dB/decade (inverse of linear distance for field-strength measurements, inverse of linear distance-squared for power-density measurements). 	
<ul style="list-style-type: none"> ▪ The average emission levels shall be measured in [duty cycle ≥ 98 or duty factor]. 	
<ul style="list-style-type: none"> ▪ For the transmitter unwanted emissions shall be measured using following options below: 	
	<ul style="list-style-type: none"> ▪ Refer as FCC KDB 789033 D02, clause G)2) for unwanted emissions into non-restricted bands.
	<ul style="list-style-type: none"> ▪ Refer as FCC KDB 789033 D02, clause G)1) for unwanted emissions into restricted bands.
<input type="checkbox"/>	Refer as FCC KDB 789033 D02, G)6) Method AD (Trace Averaging).
<input checked="" type="checkbox"/>	Refer as FCC KDB 789033 D02, G)6) Method VB (Reduced VBW).
<input type="checkbox"/>	Refer as ANSI C63.10, clause 11.12.2.5.3 (Reduced VBW). VBW ≥ 1/T, where T is pulse time.
<input type="checkbox"/>	Refer as ANSI C63.10, clause 7.5 average value of pulsed emissions.
<input checked="" type="checkbox"/>	Refer as FCC KDB 789033 D02, clause G)5) measurement procedure peak limit.
<input type="checkbox"/>	Refer as ANSI C63.10, clause 4.1.4.2.2 measurement procedure peak limit.
<ul style="list-style-type: none"> ▪ For radiated measurement. 	
	<ul style="list-style-type: none"> ▪ Refer as ANSI C63.10, clause 6.4 for radiated emissions below 30 MHz and test distance is 3m.
	<ul style="list-style-type: none"> ▪ Refer as ANSI C63.10, clause 6.5 for radiated emissions 30 MHz to 1 GHz and test distance is 3m.
	<ul style="list-style-type: none"> ▪ Refer as ANSI C63.10, clause 6.6 for radiated emissions above 1GHz.
<ul style="list-style-type: none"> ▪ The any unwanted emissions level shall not exceed the fundamental emission level. 	
<ul style="list-style-type: none"> ▪ All amplitude of spurious emissions that are attenuated by more than 20 dB below the permissible value has no need to be reported. 	

3.5.4 Test Setup

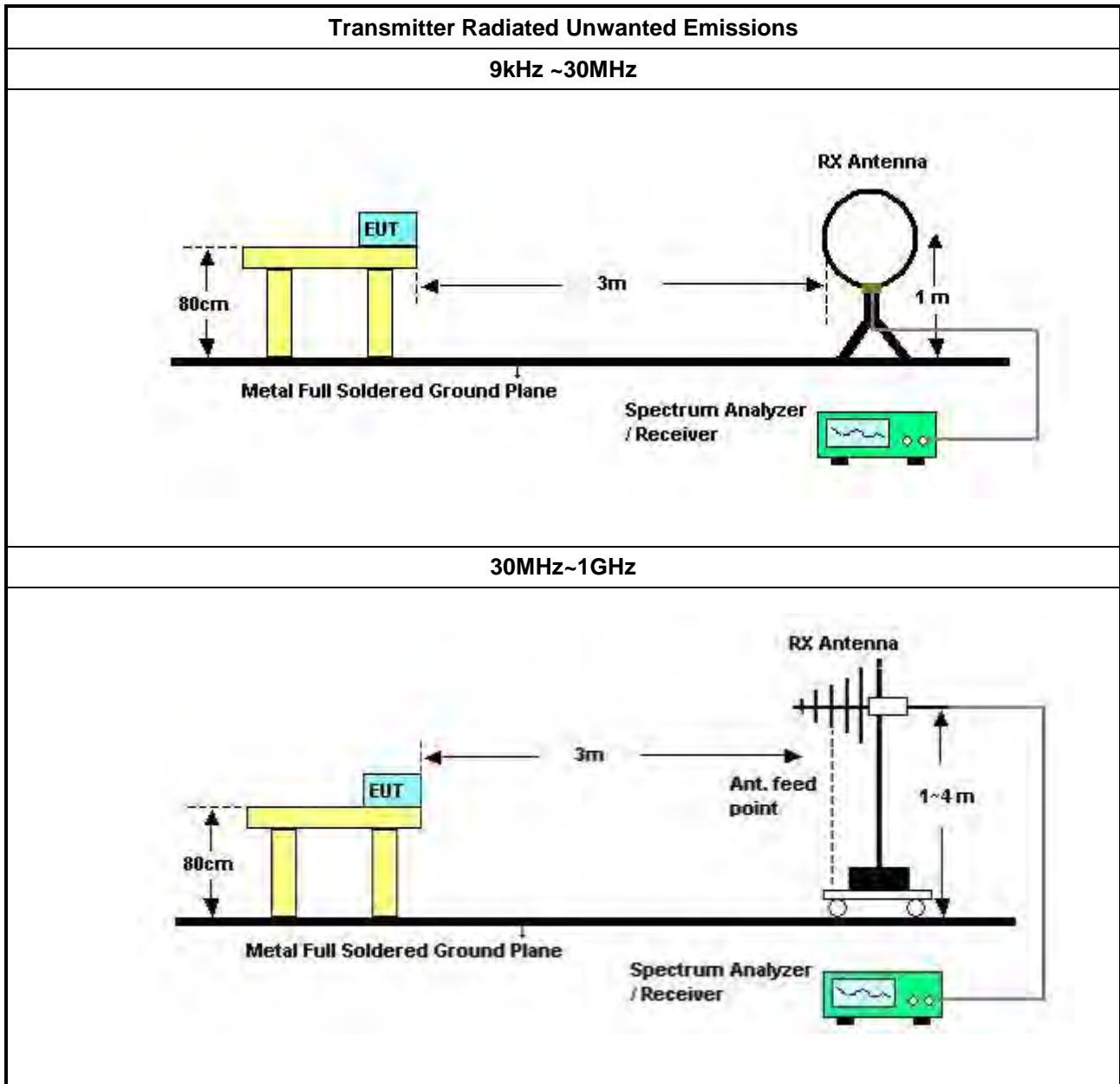

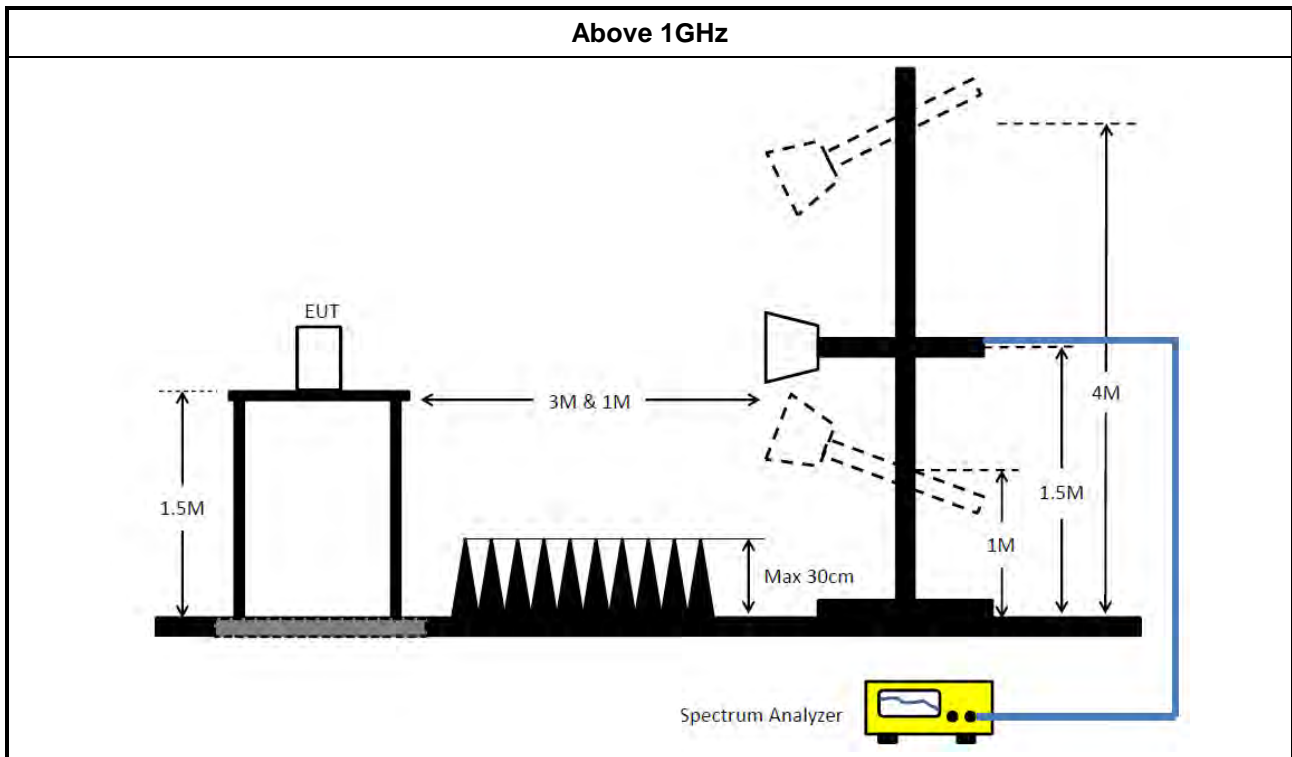

3.5.5 Measurement Results Calculation

The measured Level is calculated using:

Corrected Reading: Antenna factor (AF) + Cable loss (CL) + Read level (Raw) - Preamp factor (PA)(if applicable) = Level.

3.5.6 Transmitter Unwanted Emissions (Below 30MHz)

There is a comparison data of both open-field test site and alternative test site - semi-Anechoic chamber according to KDB414788 Radiated Test Site, and the result came out very similar.

All amplitude of spurious emissions that are attenuated by more than 20 dB below the permissible value has no need to be reported.

The radiated emissions were investigated from 9 kHz or the lowest frequency generated within the device, up to the 10th harmonic or 40 GHz, whichever is appropriate.

3.5.7 Test Result of Transmitter Unwanted Emissions

Refer as Appendix E



4 Test Equipment and Calibration Data

Instrument	Brand	Model No.	Serial No.	Characteristics	Calibration Date	Calibration Due Date	Remark
EMI Receiver	Agilent	N9038A	My52260123	9kHz ~ 8.4GHz	Feb. 22, 2022	Feb. 21, 2023	Conduction (CO01-CB)
LISN	F.C.C.	FCC-LISN-50-16-2	04083	150kHz ~ 100MHz	Feb. 09, 2022	Feb. 08, 2023	Conduction (CO01-CB)
LISN	Schwarzbeck	NSLK 8127	8127647	9kHz ~ 30MHz	Apr. 12, 2022	Apr. 11, 2023	Conduction (CO01-CB)
Pulse Limiter	Rohde & Schwarz	ESH3-Z2	100430	9kHz ~ 30MHz	Feb. 10, 2022	Feb. 09, 2023	Conduction (CO01-CB)
COND Cable	Woken	Cable	Low cable-CO01	9kHz ~ 30MHz	Oct. 18, 2022	Oct. 17, 2023	Conduction (CO01-CB)
Software	SPORTON	SENSE	V5.10	-	N.C.R.	N.C.R.	Conduction (CO01-CB)
Loop Antenna	Teseq	HLA 6120	24155	9kHz - 30 MHz	May 14, 2022	May 13, 2023	Radiation (03CH06-CB)
3m Semi Anechoic Chamber NSA	TDK	SAC-3M	03CH06-CB	30 MHz ~ 1 GHz	Aug. 04, 2022	Aug. 03, 2023	Radiation (03CH06-CB)
Bilog Antenna with 6 dB attenuator	TESEQ & EMC I	CBL6112D & N-6-06	37878 & AT-N0606	20MHz ~ 2GHz	Jul. 31, 2022	Jul. 30, 2023	Radiation (03CH06-CB)
Pre-Amplifier	Agilent	310N	187290	0.1MHz ~ 1GHz	Nov. 04, 2021	Nov. 03, 2022	Radiation (03CH06-CB)
Spectrum analyzer	R&S	FSP40	100080	9kHz~40GHz	Dec. 24, 2021	Dec. 23, 2022	Radiation (03CH06-CB)
EMI Test Receiver	R&S	ESCS	826547/017	9kHz ~ 2.75GHz	Jun. 17, 2022	Jun. 16, 2023	Radiation (03CH06-CB)
RF Cable-low	Woken	RG402	Low Cable-24+67	30MHz~1GHz	Oct. 03, 2022	Oct. 02, 2023	Radiation (03CH06-CB)
Test Software	SPORTON	SENSE	V5.10	-	N.C.R.	N.C.R.	Radiation (03CH06-CB)
3m Semi Anechoic Chamber VSWR	RIKEN	SAC-3M	03CH02-CB	1GHz ~18GHz	Mar. 26, 2022	Mar. 25, 2023	Radiation (03CH02-CB)
Horn Antenna	EMCO	3115	9610-4976	1GHz ~ 18GHz	Apr. 19, 2022	Apr. 18, 2023	Radiation (03CH02-CB)
Horn Antenna	Schwarzbeck	BBHA 9170	BBHA9170252	15GHz ~ 40GHz	Aug. 22, 2022	Aug. 21, 2023	Radiation (03CH02-CB)
Pre-Amplifier	Agilent	83017A	MY39501305	1GHz ~ 26.5GHz	Jul. 01, 2022	Jun. 30, 2023	Radiation (03CH02-CB)
Pre-Amplifier	MITEQ	TTA1840-35-H G	1864479	18GHz ~ 40GHz	Jul. 20, 2022	Jul. 19, 2023	Radiation (03CH02-CB)



Instrument	Brand	Model No.	Serial No.	Characteristics	Calibration Date	Calibration Due Date	Remark
Spectrum analyzer	R&S	FSP	100593	9kHz~40GHz	Apr. 08, 2022	Apr. 07, 2023	Radiation (03CH02-CB)
RF Cable-high	Woken	RG402	High Cable-18	1GHz ~ 18GHz	Oct. 04, 2021	Oct. 03, 2022	Radiation (03CH02-CB)
RF Cable-high	Woken	RG402	High Cable-18	1GHz ~ 18GHz	Oct. 03, 2022	Oct. 02, 2023	Radiation (03CH02-CB)
RF Cable-high	Woken	RG402	High Cable-18+19	1GHz ~ 18GHz	Oct. 04, 2021	Oct. 03, 2022	Radiation (03CH02-CB)
RF Cable-high	Woken	RG402	High Cable-18+19	1GHz ~ 18GHz	Oct. 03, 2022	Oct. 02, 2023	Radiation (03CH02-CB)
High Cable	Woken	WCA0929M	40G#5+7	1GHz ~ 40 GHz	Dec. 14, 2021	Dec. 13, 2022	Radiation (03CH02-CB)
High Cable	Woken	WCA0929M	40G#5	1GHz ~ 40 GHz	Dec. 08, 2021	Dec. 07, 2022	Radiation (03CH02-CB)
High Cable	Woken	WCA0929M	40G#7	1GHz ~ 40 GHz	Dec. 14, 2021	Dec. 13, 2022	Radiation (03CH02-CB)
Test Software	SPORTON	SENSE	V5.10	-	N.C.R.	N.C.R.	Radiation (03CH02-CB)
Spectrum analyzer	R&S	FSV40	101028	9kHz~40GHz	Jan. 07, 2022	Jan. 06, 2023	Conducted (TH03-CB)
Power Sensor	Anritsu	MA2411B	1531344	300MHz~40GHz	Jul. 31, 2022	Jul. 30, 2023	Conducted (TH03-CB)
Power Meter	Anritsu	ML2495A	1728002	300MHz~40GHz	Jul. 31, 2022	Jul. 30, 2023	Conducted (TH03-CB)
RF Cable-high	Woken	RG402	High Cable-11	1 GHz ~18 GHz	Oct. 04, 2021	Oct. 03, 2022	Conducted (TH03-CB)
RF Cable-high	Woken	RG402	High Cable-11	1 GHz ~18 GHz	Oct. 03, 2022	Oct. 02, 2023	Conducted (TH03-CB)
RF Cable-high	Woken	RG402	High Cable-12	1 GHz ~18 GHz	Oct. 04, 2021	Oct. 03, 2022	Conducted (TH03-CB)
RF Cable-high	Woken	RG402	High Cable-12	1 GHz ~18 GHz	Oct. 03, 2022	Oct. 02, 2023	Conducted (TH03-CB)
RF Cable-high	Woken	RG402	High Cable-13	1 GHz ~18 GHz	Oct. 04, 2021	Oct. 03, 2022	Conducted (TH03-CB)
RF Cable-high	Woken	RG402	High Cable-13	1 GHz ~18 GHz	Oct. 03, 2022	Oct. 02, 2023	Conducted (TH03-CB)
RF Cable-high	Woken	RG402	High Cable-14	1 GHz ~18 GHz	Oct. 04, 2021	Oct. 03, 2022	Conducted (TH03-CB)
RF Cable-high	Woken	RG402	High Cable-14	1 GHz ~18 GHz	Oct. 03, 2022	Oct. 02, 2023	Conducted (TH03-CB)
RF Cable-high	Woken	RG402	High Cable-15	1 GHz ~18 GHz	Oct. 04, 2021	Oct. 03, 2022	Conducted (TH03-CB)
RF Cable-high	Woken	RG402	High Cable-15	1 GHz ~18 GHz	Oct. 03, 2022	Oct. 02, 2023	Conducted (TH03-CB)
Switch	SPTCB	SP-SWI	SWI-03	1 GHz ~ 26.5 GHz	Dec. 13, 2021	Dec. 12, 2022	Conducted (TH03-CB)



Instrument	Brand	Model No.	Serial No.	Characteristics	Calibration Date	Calibration Due Date	Remark
Test Software	SPORTON	SENSE	V5.10	-	N.C.R.	N.C.R.	Conducted (TH03-CB)

Note: Calibration Interval of instruments listed above is one year.

NCR means Non-Calibration required.



Summary

Mode	Result	Type	Freq (Hz)	Level (dBuV)	Limit (dBuV)	Margin (dB)	Condition
Mode 2	Pass	QP	154.5k	61.46	65.75	-4.29	Line

Mode 2

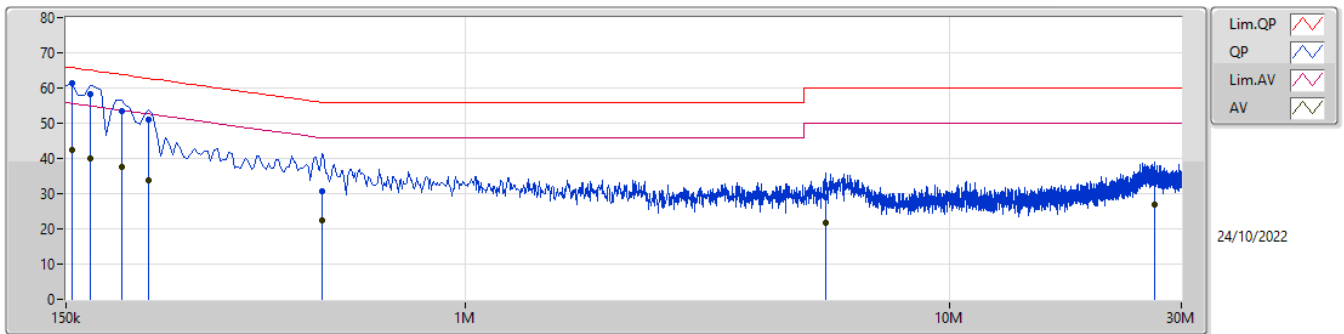

Type	Freq (Hz)	Level (dBuV)	Limit (dBuV)	Margin (dB)	Factor (dB)	Condition	Comment	Raw (dBuV)	LISN (dB)	CL (dB)	AT (dB)
QP	154.5k	61.46	65.75	-4.29	9.99	Line	"Worst"	51.47	0.06	0.04	9.89
AV	154.5k	42.54	55.75	-13.21	9.99	Line	-	32.55	0.06	0.04	9.89
QP	168k	58.29	65.06	-6.77	9.99	Line	-	48.30	0.06	0.04	9.89
AV	168k	39.97	55.06	-15.09	9.99	Line	-	29.98	0.06	0.04	9.89
QP	195k	53.30	63.82	-10.52	9.99	Line	-	43.31	0.06	0.04	9.89
AV	195k	37.52	53.82	-16.30	9.99	Line	-	27.53	0.06	0.04	9.89
QP	222k	51.01	62.75	-11.74	9.99	Line	-	41.02	0.06	0.04	9.89
AV	222k	33.93	52.75	-18.82	9.99	Line	-	23.94	0.06	0.04	9.89
QP	505.5k	30.83	56.00	-25.17	10.00	Line	-	20.83	0.06	0.05	9.89
AV	505.5k	22.50	46.00	-23.50	10.00	Line	-	12.50	0.06	0.05	9.89
QP	5.541M	29.10	60.00	-30.90	10.18	Line	-	18.92	0.16	0.12	9.90
AV	5.541M	21.67	50.00	-28.33	10.18	Line	-	11.49	0.16	0.12	9.90
QP	26.403M	33.24	60.00	-26.76	10.66	Line	-	22.58	0.37	0.30	9.99
AV	26.403M	26.82	50.00	-23.18	10.66	Line	-	16.16	0.37	0.30	9.99

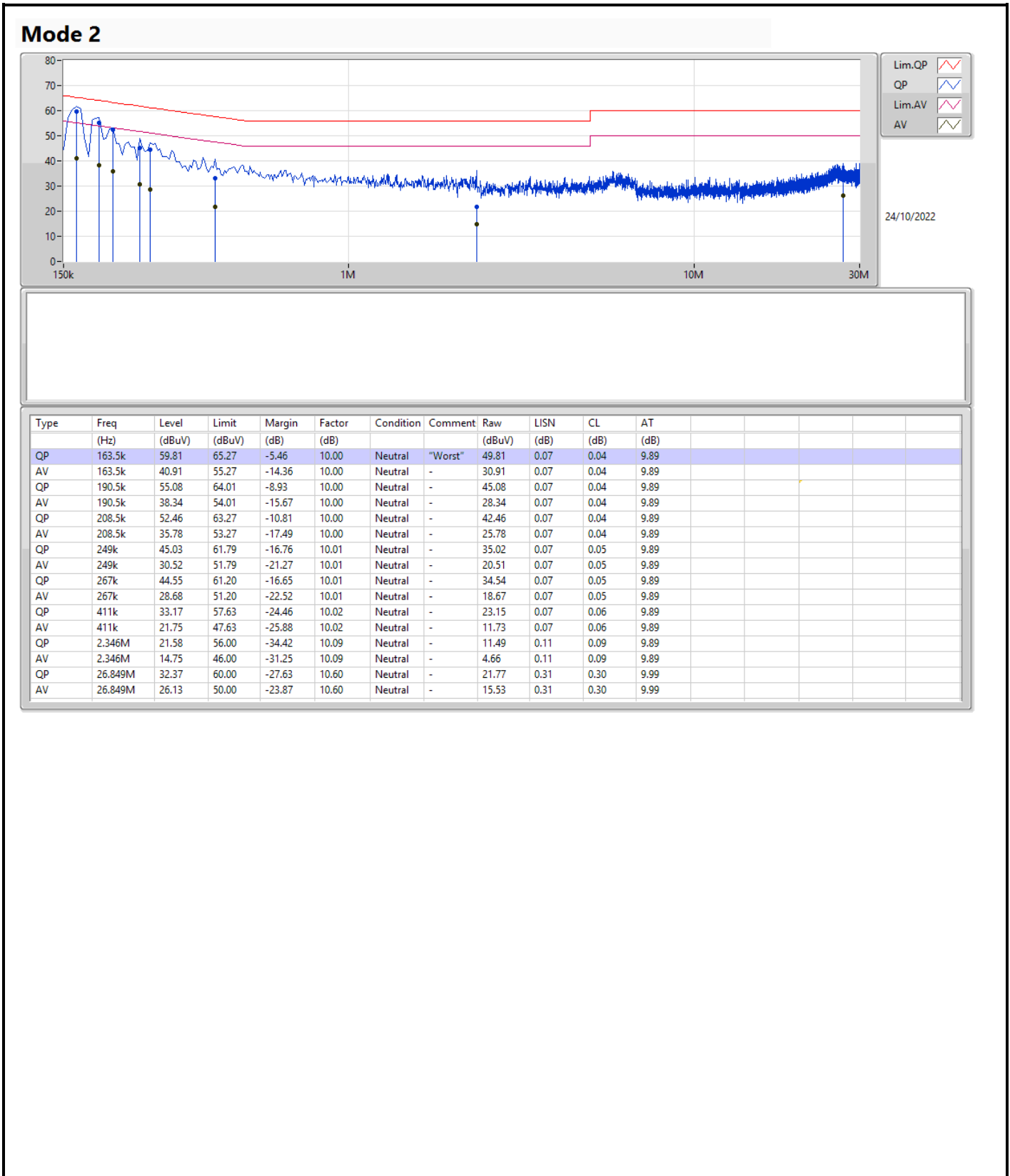

Summary

Mode	Max-N dB (Hz)	Max-OBW (Hz)	ITU-Code	Min-N dB (Hz)	Min-OBW (Hz)
5.15-5.25GHz	-	-	-	-	-
5.15-5.25GHz_802.11a_Nss1,(6Mbps)_2TX	28.26M	16.618M	16M7D1D	18.72M	16.235M
5.15-5.25GHz_802.11ax HEW20_Nss1,(MCS0)_2TX	29.04M	18.954M	19M0D1D	20.85M	18.777M
5.15-5.25GHz_802.11ax HEW40_Nss1,(MCS0)_2TX	40.08M	37.672M	37M7D1D	39.96M	37.496M
5.15-5.25GHz_802.11ax HEW80_Nss1,(MCS0)_2TX	81.72M	76.754M	76M8D1D	81.48M	76.637M
5.725-5.85GHz	-	-	-	-	-
5.725-5.85GHz_802.11a_Nss1,(6Mbps)_2TX	15.09M	30.1M	30M1D1D	15M	27.169M
5.725-5.85GHz_802.11ax HEW20_Nss1,(MCS0)_2TX	16.41M	32.118M	32M2D1D	11.88M	19.336M
5.725-5.85GHz_802.11ax HEW40_Nss1,(MCS0)_2TX	34.98M	53.716M	53M8D1D	27.48M	38.73M
5.725-5.85GHz_802.11ax HEW80_Nss1,(MCS0)_2TX	75M	76.99M	77M0D1D	72.12M	76.754M

Max-N dB = Maximum 6dB down bandwidth for 5.725-5.85GHz band / Maximum 26dB down bandwidth for other band;
 Max-OBW = Maximum 99% occupied bandwidth;
 Min-N dB = Minimum 6dB down bandwidth for 5.725-5.85GHz band / Maximum 26dB down bandwidth for other band;
 Min-OBW = Minimum 99% occupied bandwidth

Result

Mode	Result	Limit (Hz)	Port 1-N dB (Hz)	Port 1-OBW (Hz)	Port 2-N dB (Hz)	Port 2-OBW (Hz)
5.15-5.25GHz_802.11a_Nss1,(6Mbps)_2TX	-	-	-	-	-	-
5180MHz	Pass	Inf	18.96M	16.235M	18.72M	16.235M
5200MHz	Pass	Inf	22.41M	16.363M	22.17M	16.363M
5240MHz	Pass	Inf	28.26M	16.618M	25.8M	16.541M
5745MHz	Pass	500k	15.03M	29.616M	15.09M	29.361M
5785MHz	Pass	500k	15M	30.1M	15.09M	27.705M
5825MHz	Pass	500k	15.06M	27.96M	15.03M	27.169M
5.15-5.25GHz_802.11ax HEW20_Nss1,(MCS0)_2TX	-	-	-	-	-	-
5180MHz	Pass	Inf	20.85M	18.807M	21.27M	18.777M
5200MHz	Pass	Inf	26.7M	18.954M	29.04M	18.924M
5240MHz	Pass	Inf	27.42M	18.954M	27.27M	18.895M
5745MHz	Pass	500k	14.1M	26.153M	13.23M	23.185M
5785MHz	Pass	500k	11.88M	28.886M	16.41M	32.118M
5825MHz	Pass	500k	14.64M	19.336M	15.06M	22.303M
5.15-5.25GHz_802.11ax HEW40_Nss1,(MCS0)_2TX	-	-	-	-	-	-
5190MHz	Pass	Inf	39.96M	37.496M	40.02M	37.496M
5230MHz	Pass	Inf	40.08M	37.672M	40.08M	37.613M
5755MHz	Pass	500k	34.98M	38.847M	27.48M	38.73M
5795MHz	Pass	500k	31.8M	52.13M	30M	53.716M
5.15-5.25GHz_802.11ax HEW80_Nss1,(MCS0)_2TX	-	-	-	-	-	-
5210MHz	Pass	Inf	81.72M	76.754M	81.48M	76.637M
5775MHz	Pass	500k	75M	76.754M	72.12M	76.99M

Port X-N dB = Port X 6dB down bandwidth for 5.725-5.85GHz band / 26dB down bandwidth for other band
 Port X-OBW = Port X 99% occupied bandwidth

5.15-5.25GHz_802.11a_Nss1,(6Mbps)_2TX

EBW

5180MHz

01/10/2022

CF: 5.18GHz
 Span: 60MHz
 RBW: 300kHz
 VBW: 1MHz
 Sweep Time: 100ms
 Detector Type: Peak

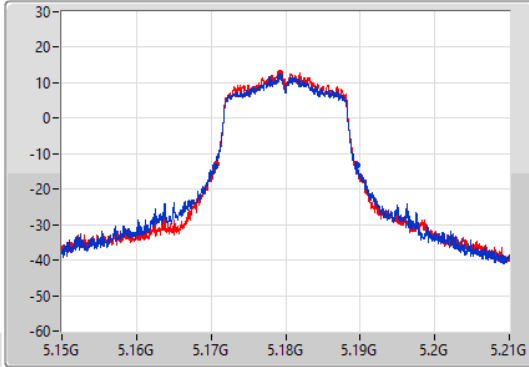

CF: 5.18GHz
 Span: 51MHz
 RBW: 200kHz
 VBW: 1MHz
 Sweep Time: 100ms
 Detector Type: Peak

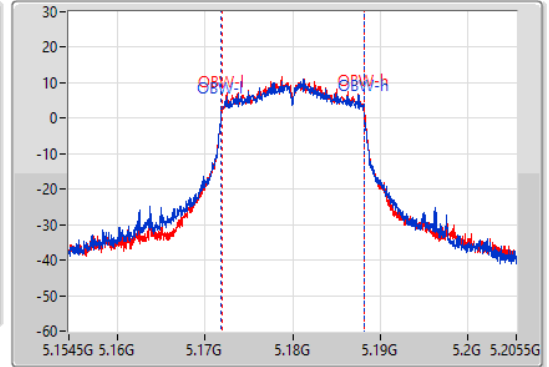

26dB(Hz)	Fl-26dB(Hz)	Fh-26dB(Hz)	OBW(Hz)	Fl-OBW(Hz)	Fh-OBW(Hz)	Limit(Hz)	Port
18.96M	5.17061G	5.18957G	16.235M	5.171895G	5.18813G	Inf	1
18.72M	5.1707G	5.18942G	16.235M	5.171921G	5.188156G	Inf	2

5.15-5.25GHz_802.11a_Nss1,(6Mbps)_2TX

EBW

5200MHz

01/10/2022

CF: 5.2GHz
 Span: 60MHz
 RBW: 300kHz
 VBW: 1MHz
 Sweep Time: 100ms
 Detector Type: Peak

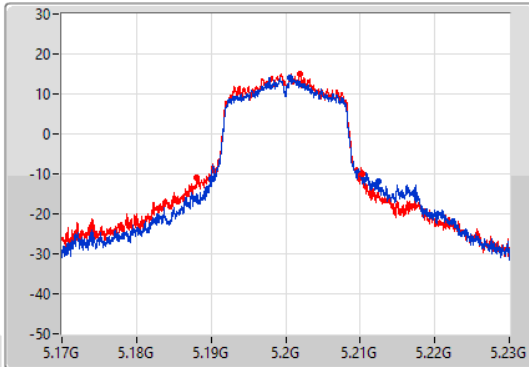

CF: 5.2GHz
 Span: 51MHz
 RBW: 200kHz
 VBW: 1MHz
 Sweep Time: 100ms
 Detector Type: Peak

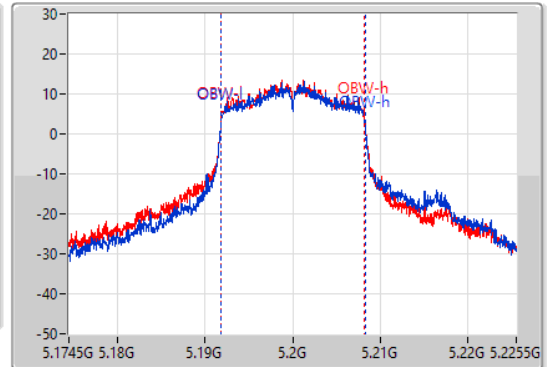

26dB(Hz)	Fl-26dB(Hz)	Fh-26dB(Hz)	OBW(Hz)	Fl-OBW(Hz)	Fh-OBW(Hz)	Limit(Hz)	Port
22.41M	5.18998G	5.21239G	16.363M	5.191895G	5.208258G	Inf	1
22.17M	5.18812G	5.21029G	16.363M	5.191844G	5.208207G	Inf	2

5.15-5.25GHz_802.11a_Nss1,(6Mbps)_2TX

EBW

5240MHz

01/10/2022

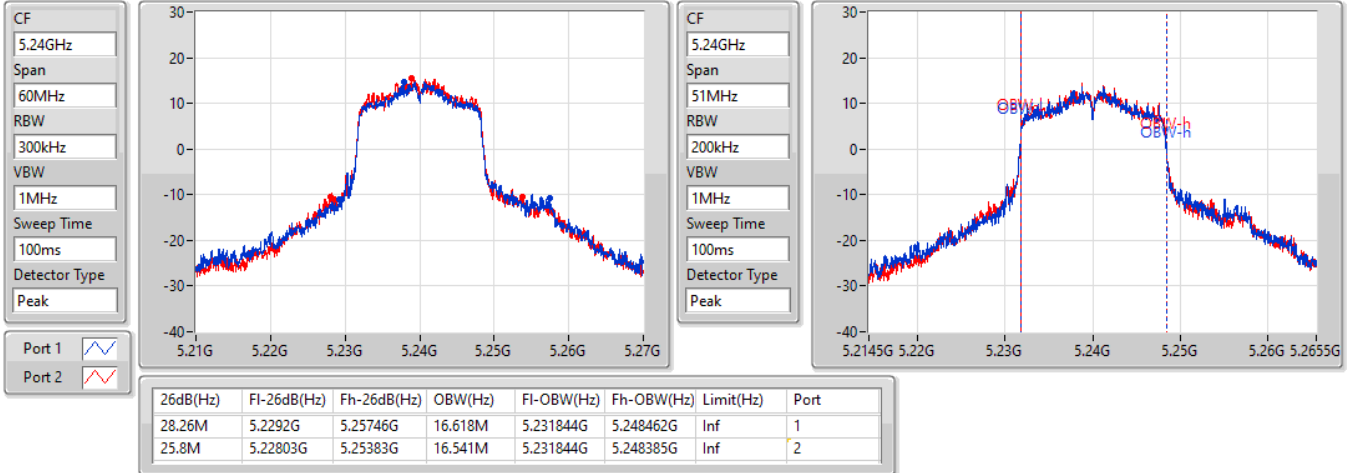

5.725-5.85GHz_802.11a_Nss1,(6Mbps)_2TX

EBW

5745MHz

01/10/2022

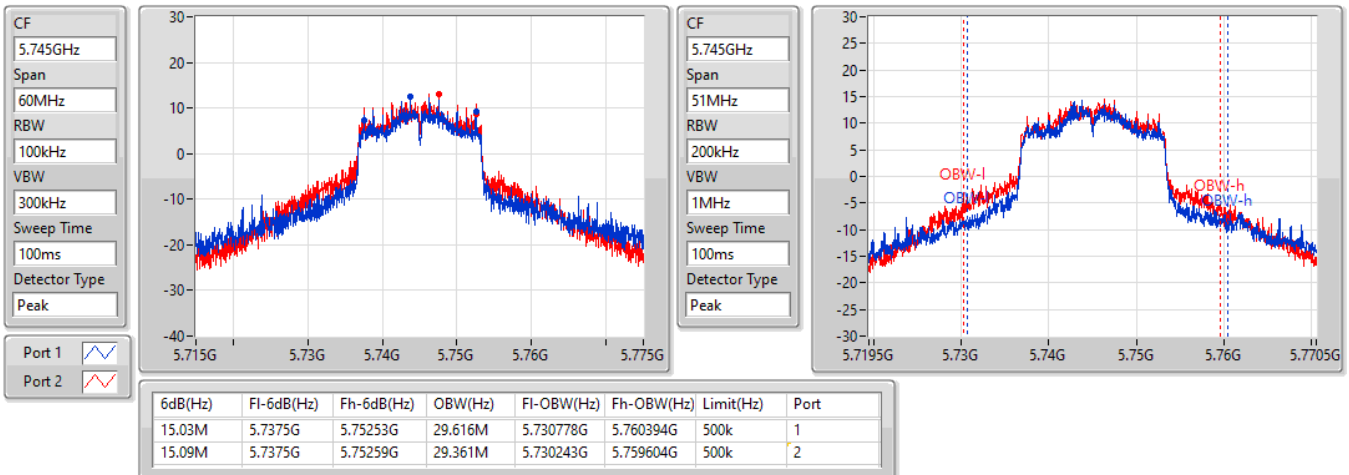

5.725-5.85GHz_802.11a_Nss1,(6Mbps)_2TX

EBW

5745MHz

01/10/2022

CF
5.745GHz

Span
51MHz

RBW
200kHz

VBW
1MHz

Sweep Time
100ms

Detector Type
Peak

Port 1

Port 2

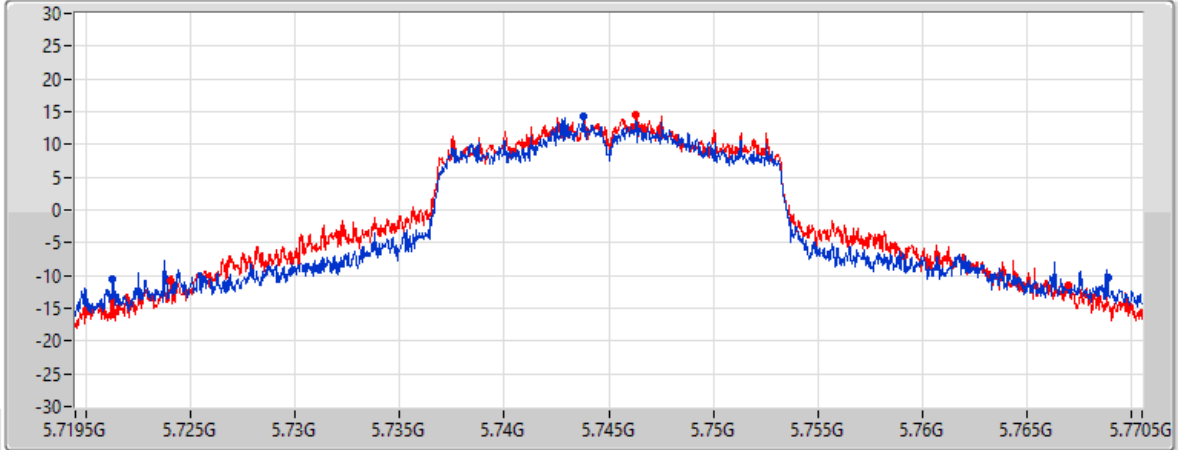

26dB(Hz)	Fl-26dB(Hz)	Fh-26dB(Hz)	Limit(Hz)	Port
47.609M	5.72126G	5.768868G	Inf	1
42.942M	5.724014G	5.766956G	Inf	2

5.725-5.85GHz_802.11a_Nss1,(6Mbps)_2TX

EBW

5785MHz

01/10/2022

CF
5.785GHz

Span
60MHz

RBW
100kHz

VBW
300kHz

Sweep Time
100ms

Detector Type
Peak

Port 1

Port 2

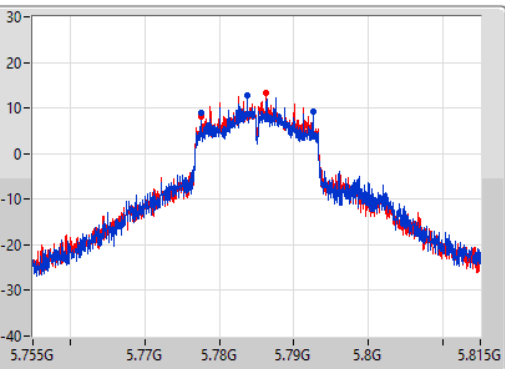

CF
5.785GHz

Span
51MHz

RBW
200kHz

VBW
1MHz

Sweep Time
100ms

Detector Type
Peak

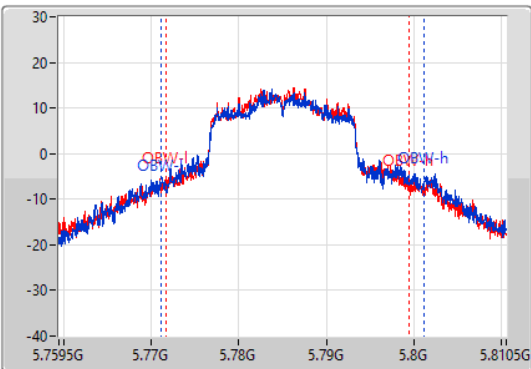

6dB(Hz)	Fl-6dB(Hz)	Fh-6dB(Hz)	OBW(Hz)	Fl-OBW(Hz)	Fh-OBW(Hz)	Limit(Hz)	Port
15M	5.77756G	5.79256G	30.1M	5.771084G	5.801184G	500k	1
15.09M	5.7775G	5.79259G	27.705M	5.771772G	5.799477G	500k	2

5.725-5.85GHz_802.11a_Nss1,(6Mbps)_2TX

EBW

5785MHz

01/10/2022

CF
5.785GHz

Span
51MHz

RBW
200kHz

VBW
1MHz

Sweep Time
100ms

Detector Type
Peak

Port 1

Port 2

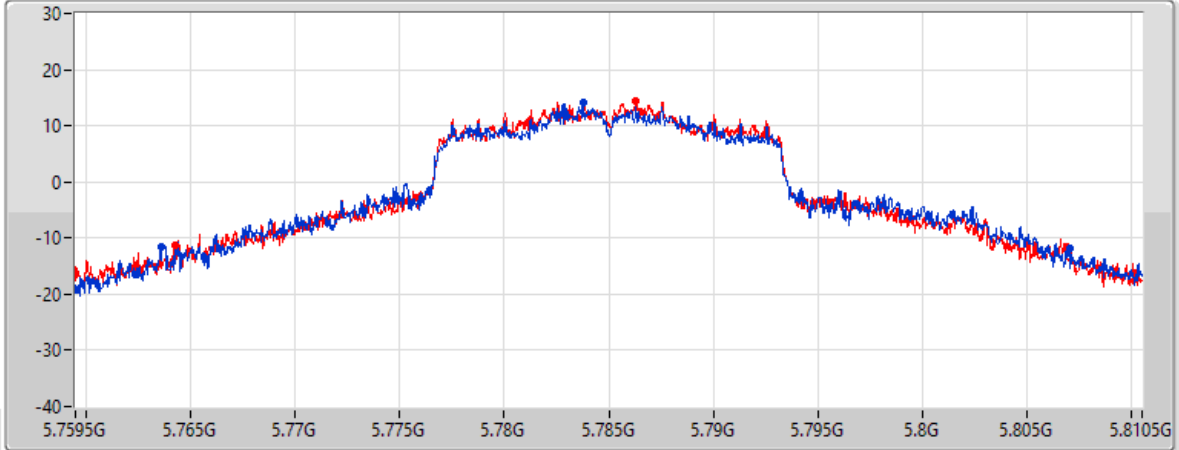

26dB(Hz)	Fl-26dB(Hz)	Fh-26dB(Hz)	Limit(Hz)	Port
43.452M	5.76358G	5.807032G	Inf	1
42.611M	5.764294G	5.806905G	Inf	2

5.725-5.85GHz_802.11a_Nss1,(6Mbps)_2TX

EBW

5825MHz

01/10/2022

CF
5.825GHz

Span
60MHz

RBW
100kHz

VBW
300kHz

Sweep Time
100ms

Detector Type
Peak

Port 1

Port 2

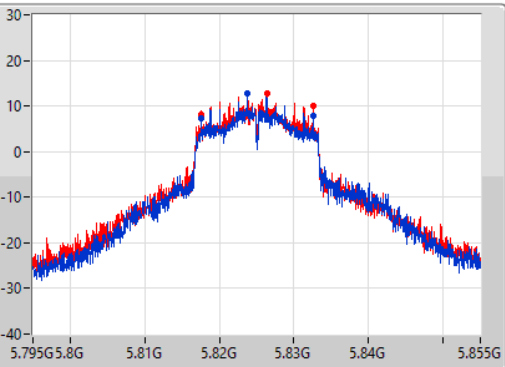

CF
5.825GHz

Span
51MHz

RBW
200kHz

VBW
1MHz

Sweep Time
100ms

Detector Type
Peak

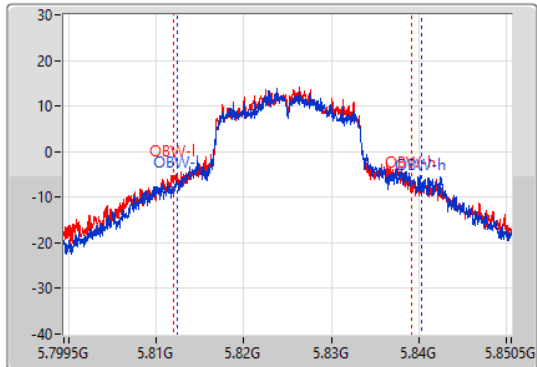

6dB(Hz)	Fl-6dB(Hz)	Fh-6dB(Hz)	OBW(Hz)	Fl-OBW(Hz)	Fh-OBW(Hz)	Limit(Hz)	Port
15.06M	5.81753G	5.83259G	27.96M	5.812358G	5.840318G	500k	1
15.03M	5.81753G	5.83256G	27.169M	5.811951G	5.83912G	500k	2

5.725-5.85GHz_802.11a_Nss1,(6Mbps)_2TX

EBW

5825MHz

01/10/2022

CF
5.825GHz

Span
51MHz

RBW
200kHz

VBW
1MHz

Sweep Time
100ms

Detector Type
Peak

Port 1

Port 2

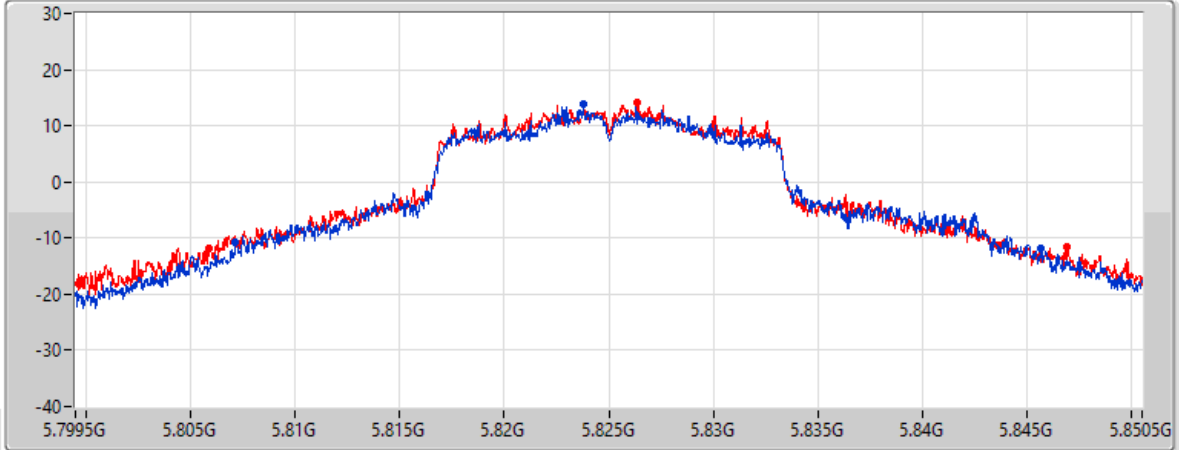

26dB(Hz)	Fl-26dB(Hz)	Fh-26dB(Hz)	Limit(Hz)	Port
38.556M	5.807125G	5.845681G	Inf	1
41.004M	5.805875G	5.846879G	Inf	2

5.15-5.25GHz_802.11ax HEW20_Nss1,(MCS0)_2TX

EBW

5180MHz

01/10/2022

CF
5.18GHz

Span
60MHz

RBW
300kHz

VBW
1MHz

Sweep Time
100ms

Detector Type
Peak

Port 1

Port 2

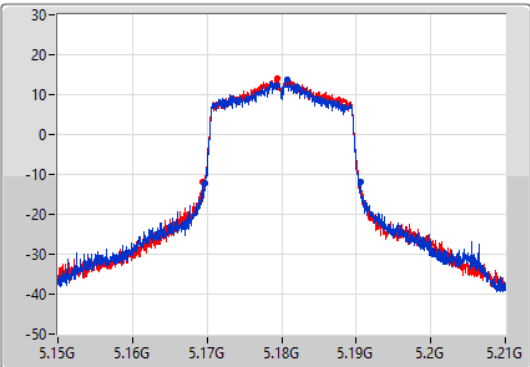

CF
5.18GHz

Span
58.8MHz

RBW
200kHz

VBW
1MHz

Sweep Time
100ms

Detector Type
Peak

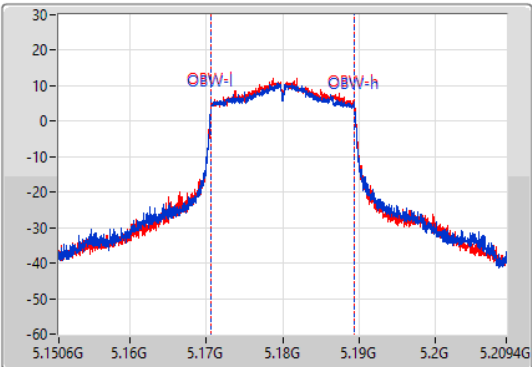

26dB(Hz)	Fl-26dB(Hz)	Fh-26dB(Hz)	OBW(Hz)	Fl-OBW(Hz)	Fh-OBW(Hz)	Limit(Hz)	Port
20.85M	5.16968G	5.19053G	18.807M	5.170626G	5.189433G	Inf	1
21.27M	5.16935G	5.19062G	18.777M	5.170655G	5.189433G	Inf	2

5.15-5.25GHz_802.11ax HEW20_Nss1,(MCS0)_2TX

EBW

5200MHz

01/10/2022

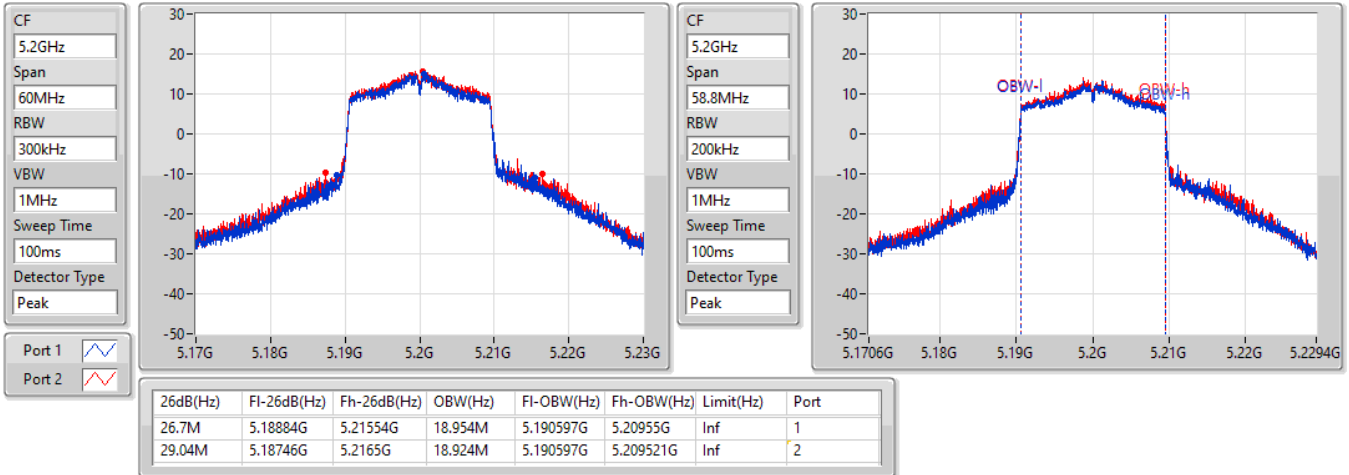

5.15-5.25GHz_802.11ax HEW20_Nss1,(MCS0)_2TX

EBW

5240MHz

01/10/2022

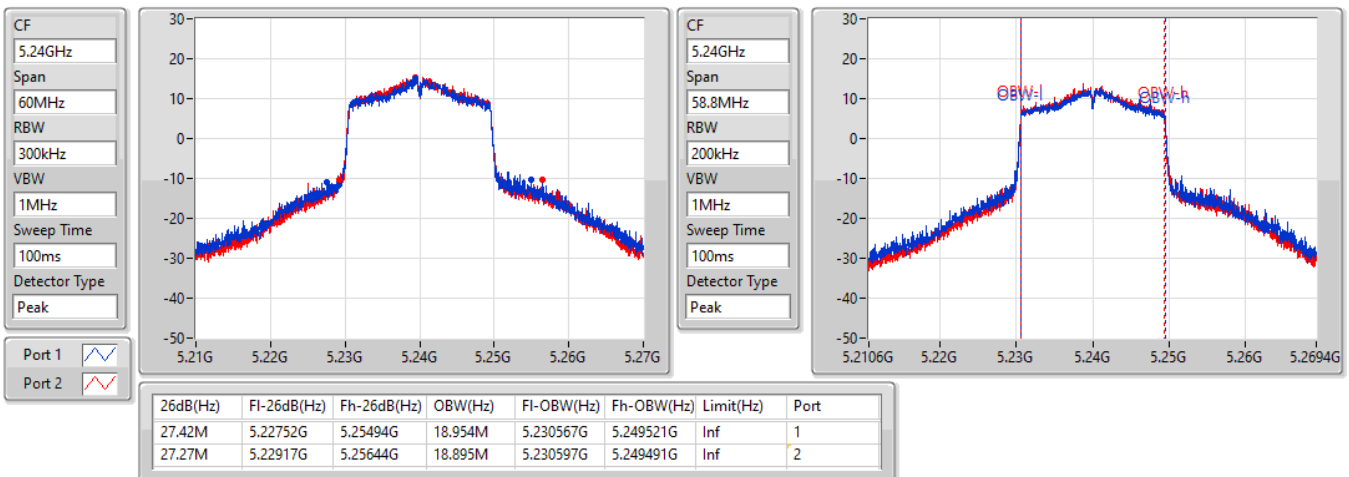

5.725-5.85GHz_802.11ax HEW20_Nss1,(MCS0)_2TX

EBW

5745MHz

01/10/2022

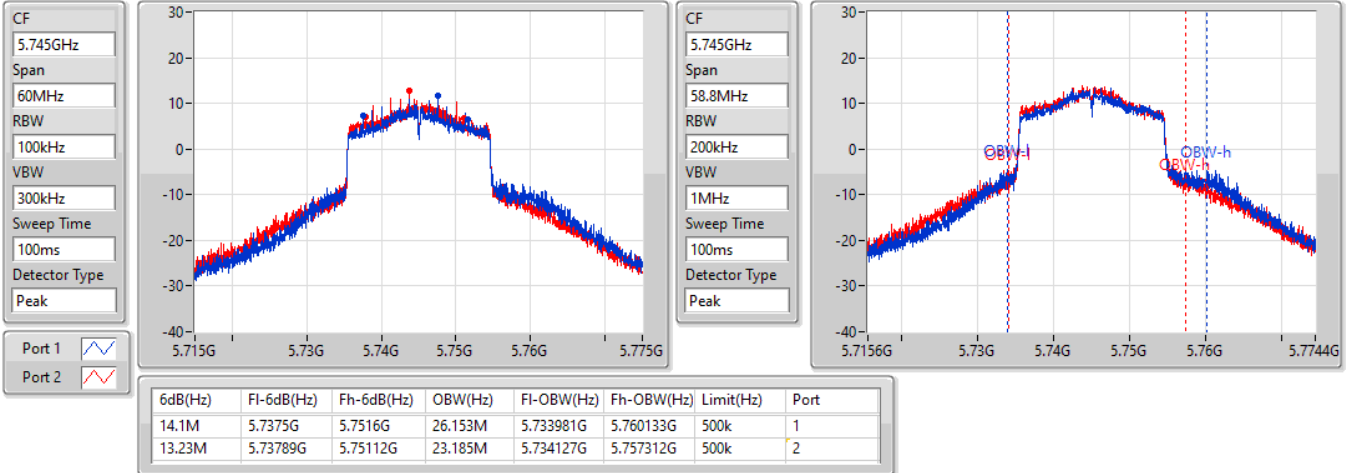

5.725-5.85GHz_802.11ax HEW20_Nss1,(MCS0)_2TX

EBW

5745MHz

01/10/2022

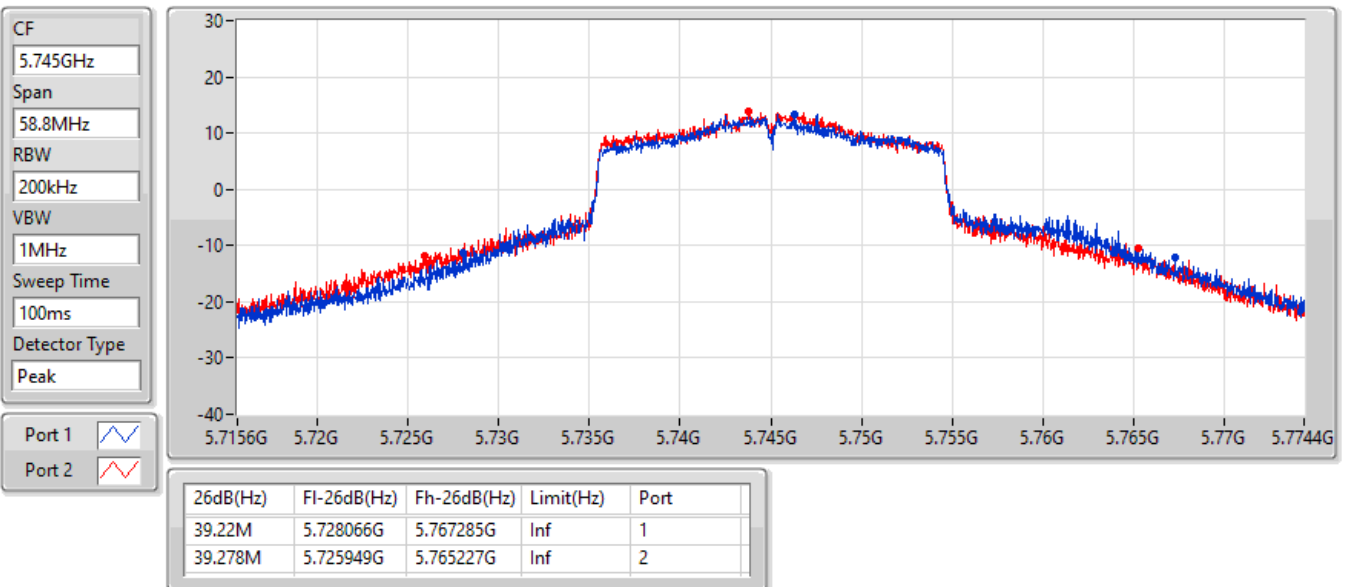

5.725-5.85GHz_802.11ax HEW20_Nss1,(MCS0)_2TX

EBW

5785MHz

01/10/2022

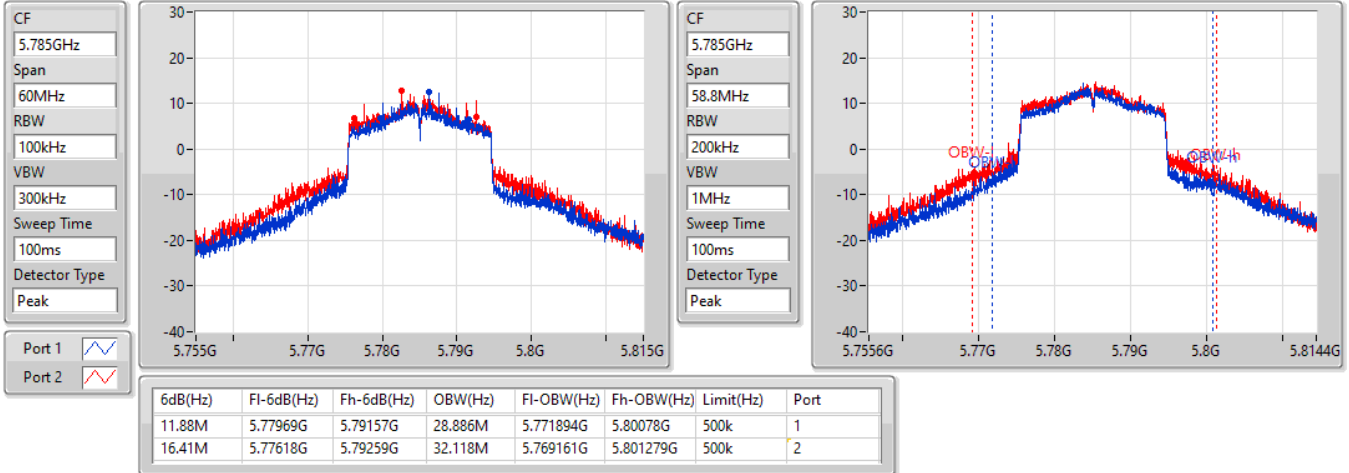

5.725-5.85GHz_802.11ax HEW20_Nss1,(MCS0)_2TX

EBW

5785MHz

01/10/2022

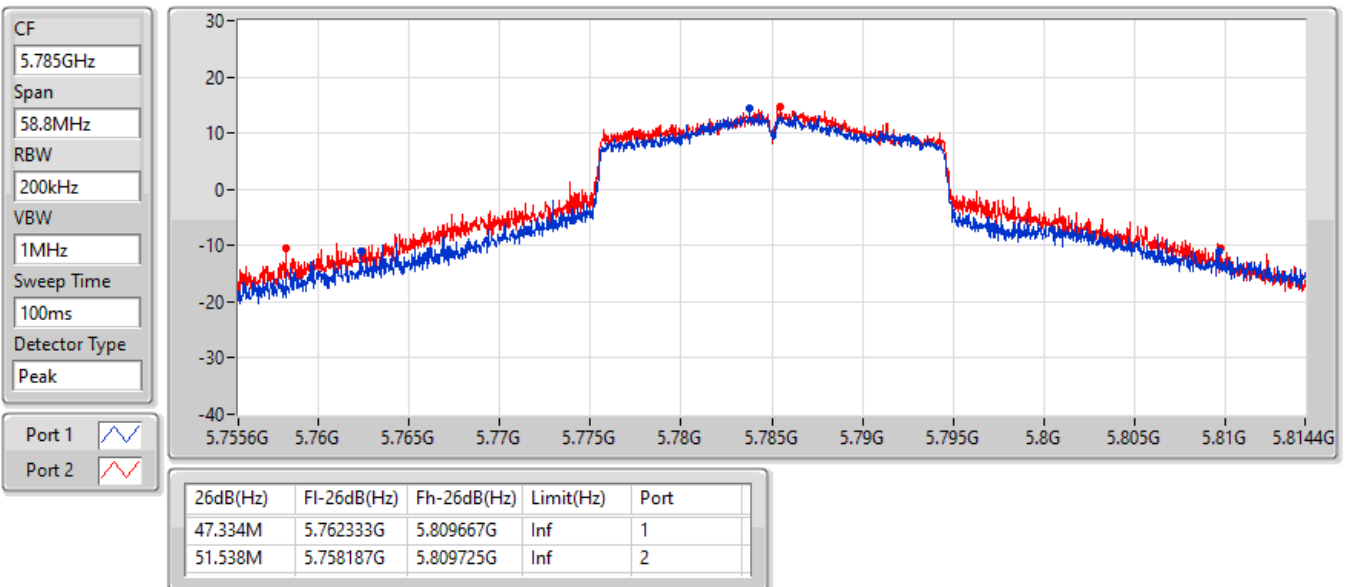

5.725-5.85GHz_802.11ax HEW20_Nss1,(MCS0)_2TX

EBW

5825MHz

01/10/2022

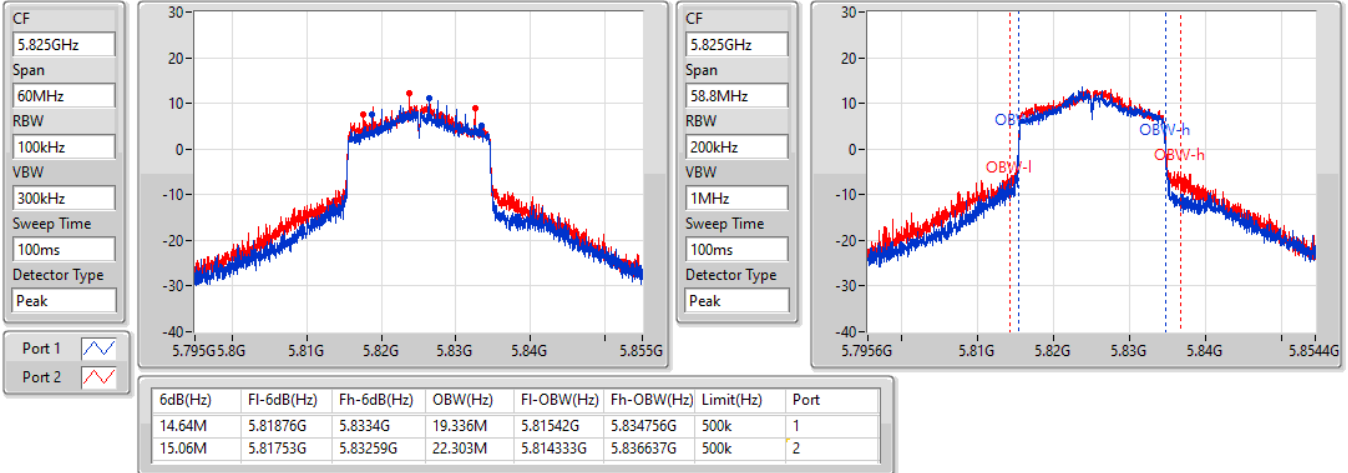

5.725-5.85GHz_802.11ax HEW20_Nss1,(MCS0)_2TX

EBW

5825MHz

01/10/2022

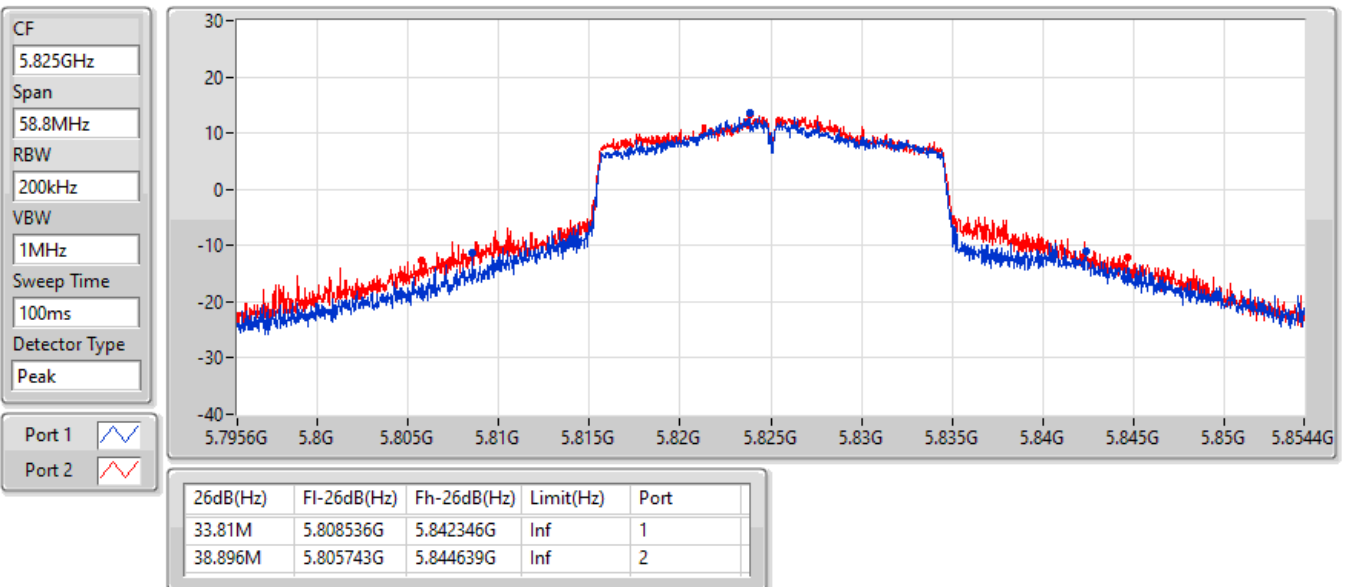

5.15-5.25GHz_802.11ax HEW40_Nss1,(MCS0)_2TX

EBW

5190MHz

01/10/2022

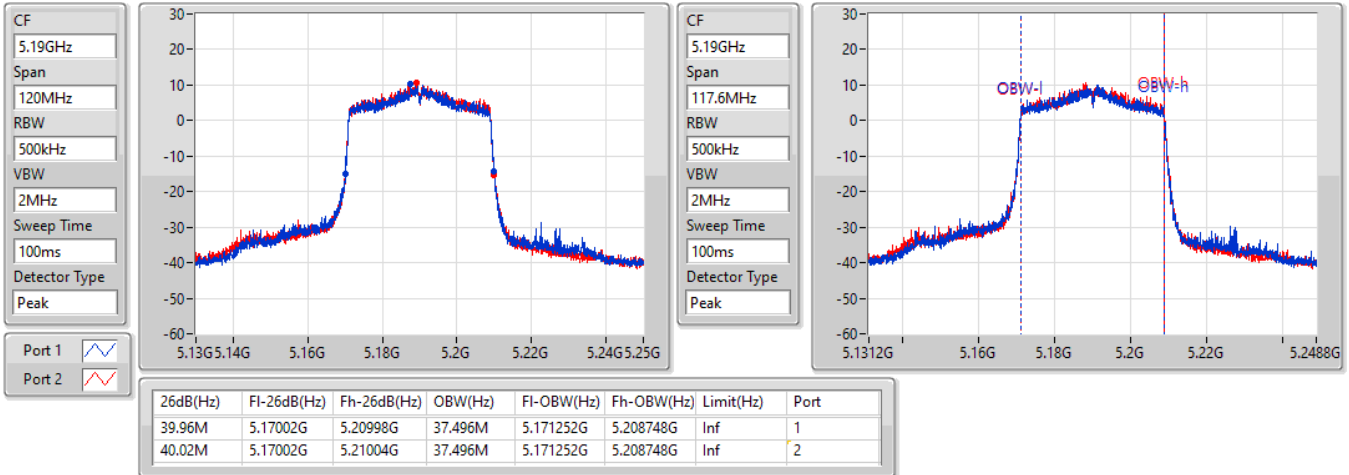

5.15-5.25GHz_802.11ax HEW40_Nss1,(MCS0)_2TX

EBW

5230MHz

01/10/2022

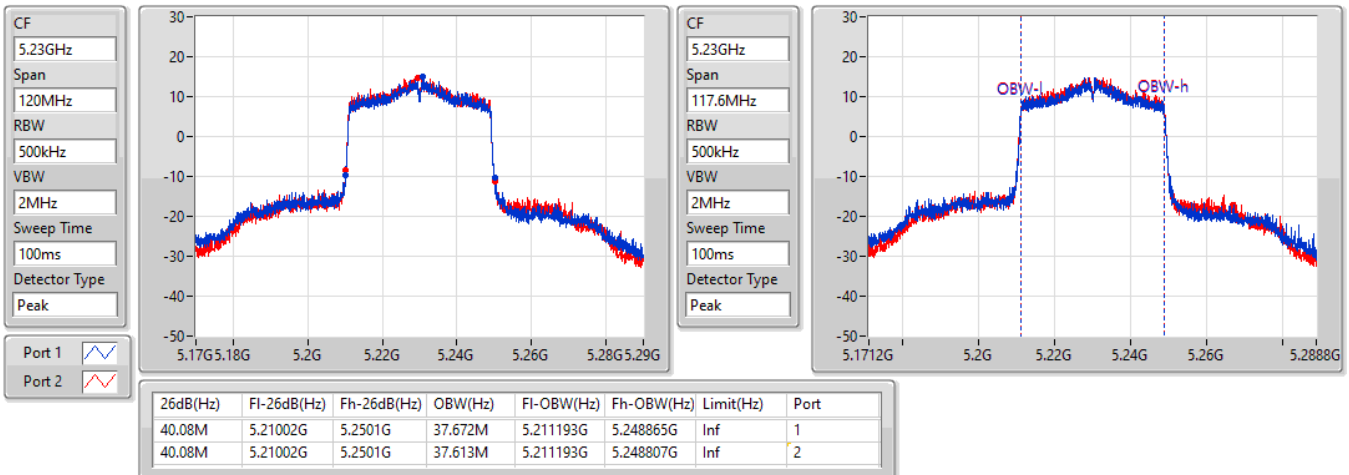

5.725-5.85GHz_802.11ax HEW40_Nss1,(MCS0)_2TX

EBW

5755MHz

01/10/2022

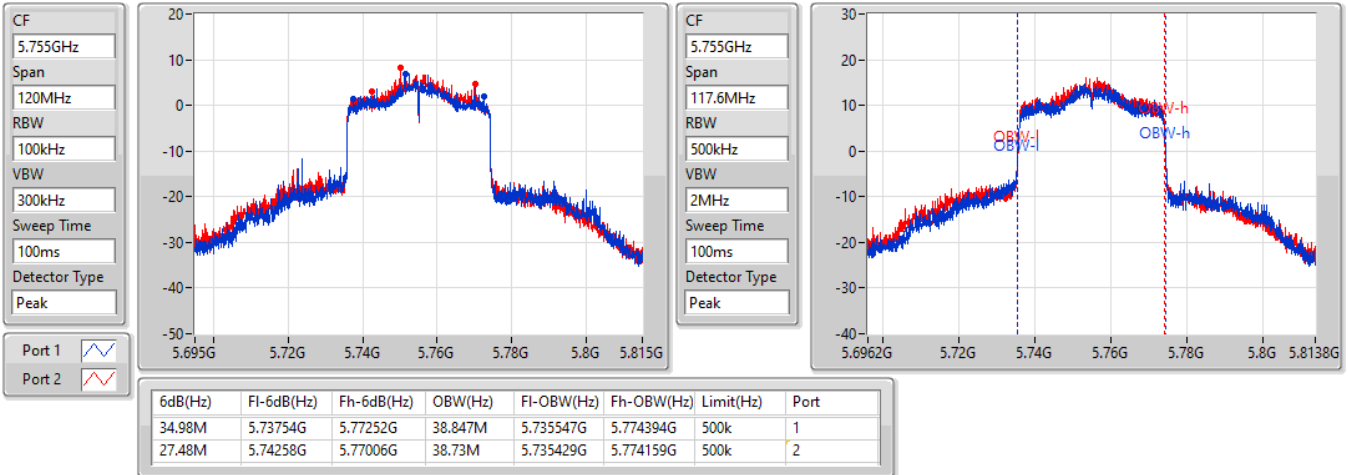

5.725-5.85GHz_802.11ax HEW40_Nss1,(MCS0)_2TX

EBW

5755MHz

01/10/2022

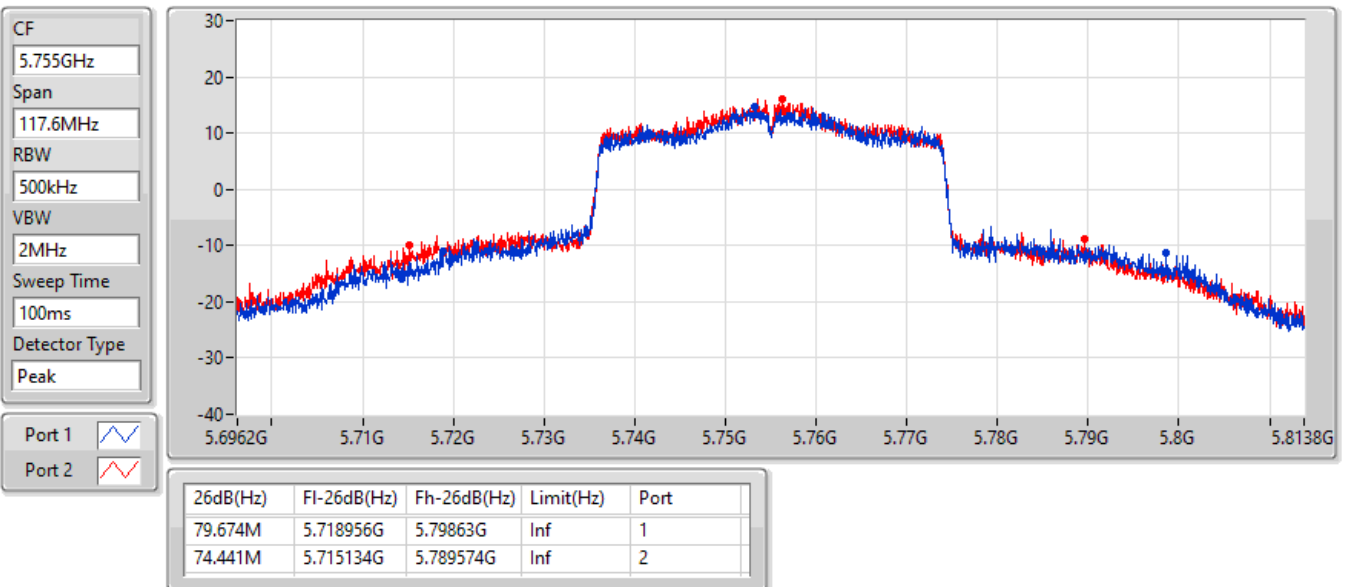

5.725-5.85GHz_802.11ax HEW40_Nss1,(MCS0)_2TX

EBW

5795MHz

01/10/2022

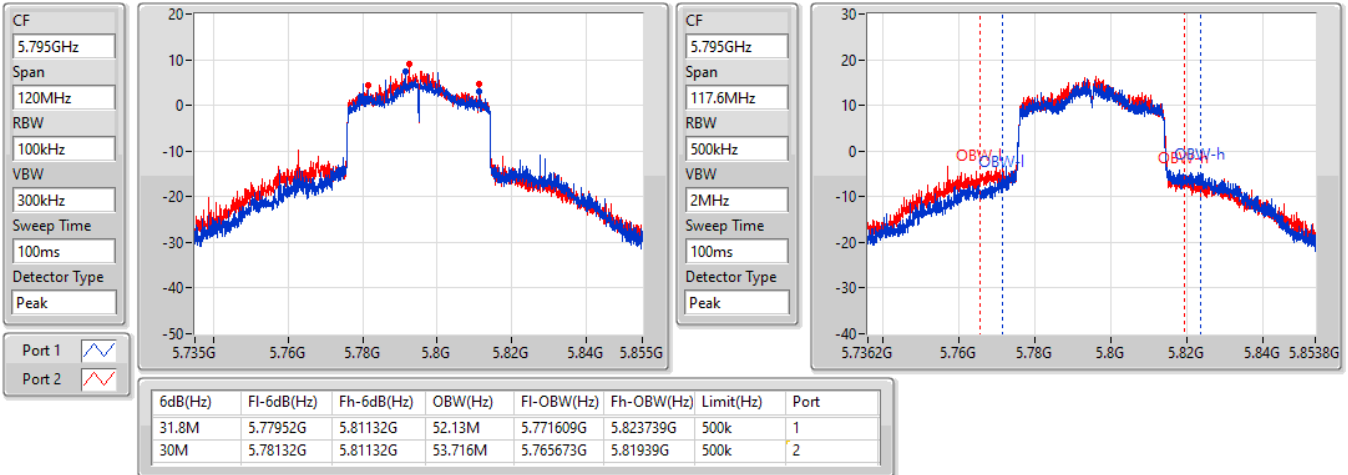

5.725-5.85GHz_802.11ax HEW40_Nss1,(MCS0)_2TX

EBW

5795MHz

01/10/2022

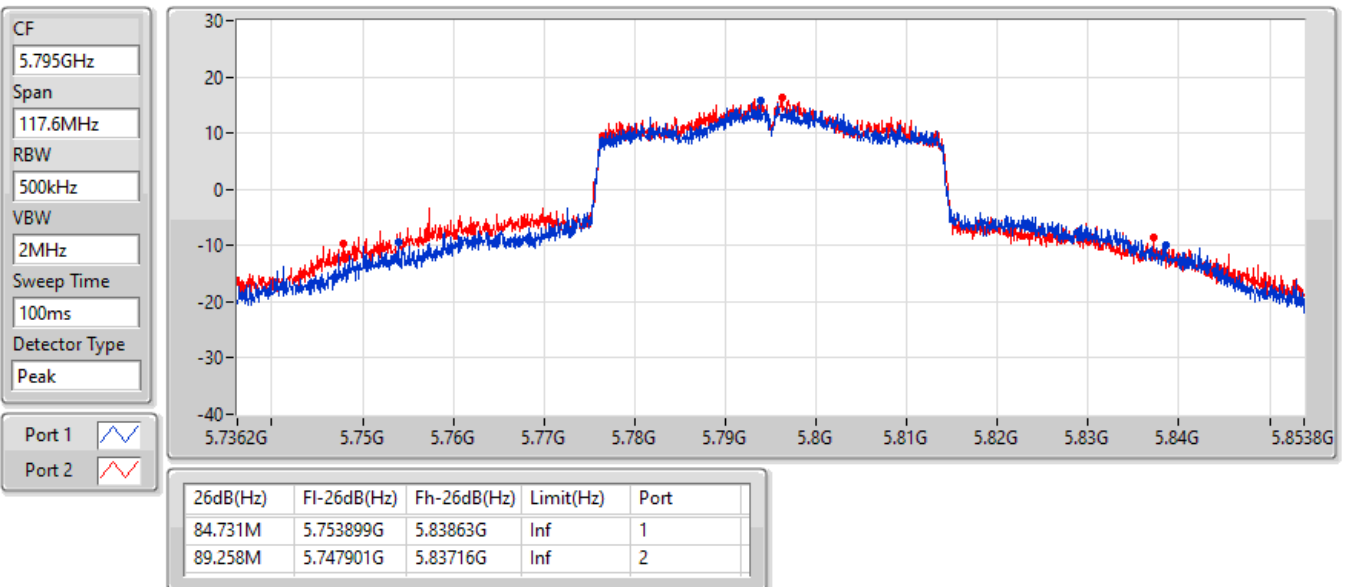

5.15-5.25GHz_802.11ax HEW80_Nss1,(MCS0)_2TX

EBW

5210MHz

01/10/2022

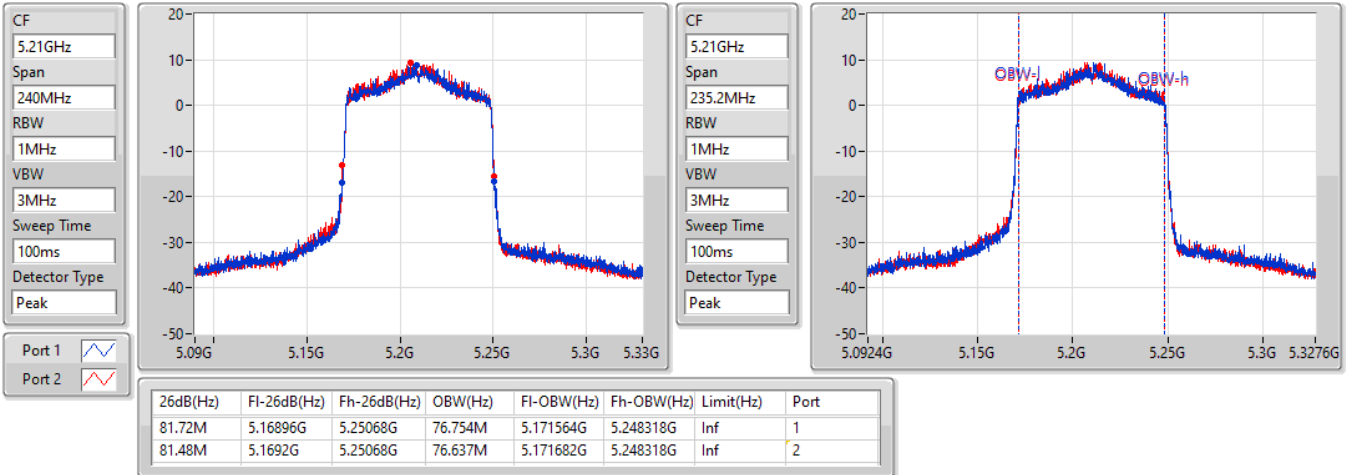

5.725-5.85GHz_802.11ax HEW80_Nss1,(MCS0)_2TX

EBW

5775MHz

01/10/2022

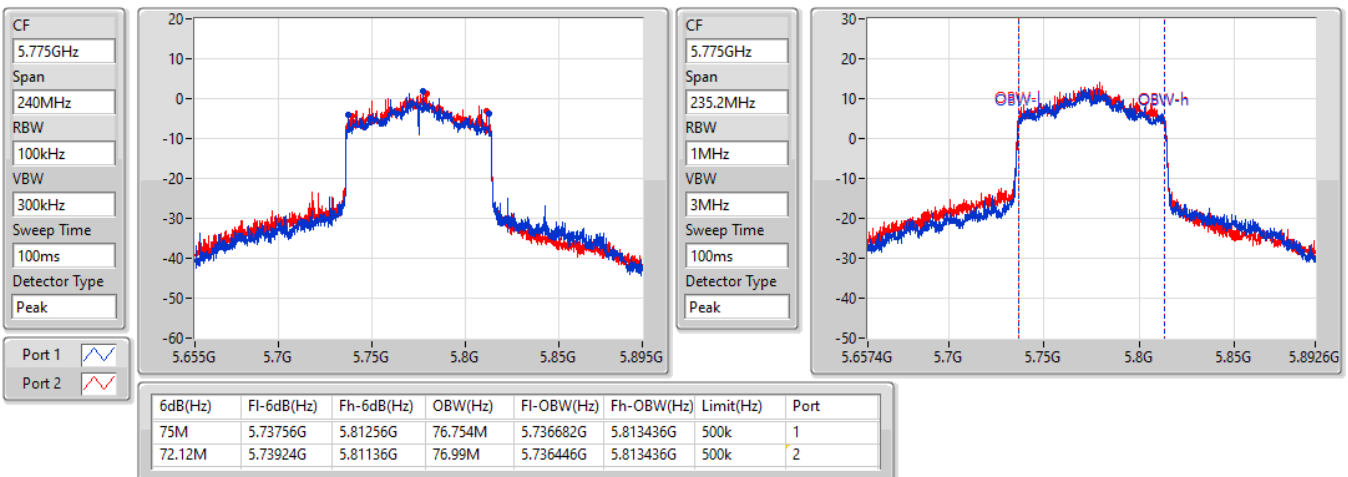

5.725-5.85GHz_802.11ax HEW80_Nss1,(MCS0)_2TX

EBW

5775MHz

01/10/2022

CF
5.775GHz

Span
235.2MHz

RBW
1MHz

VBW
3MHz

Sweep Time
100ms

Detector Type
Peak

Port 1 

Port 2 

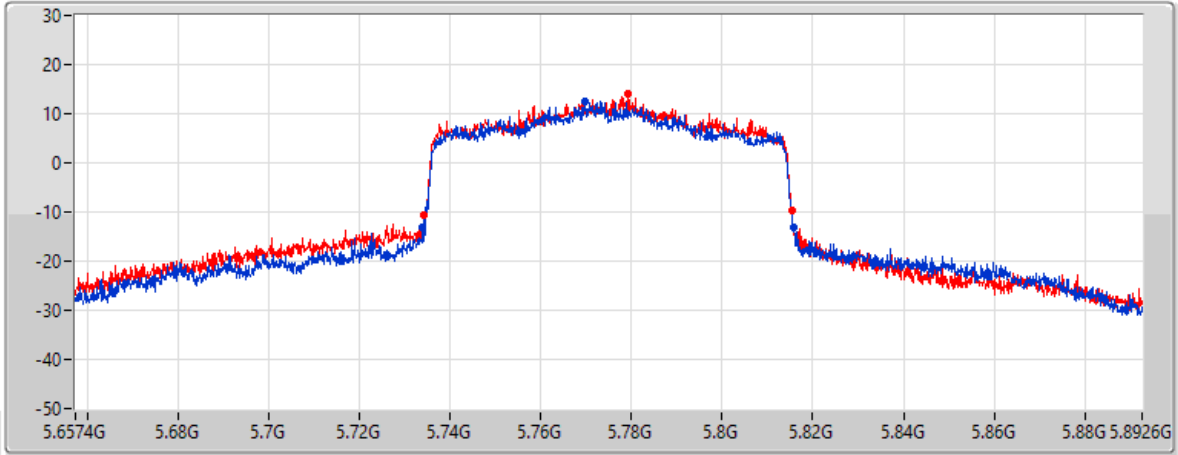

26dB(Hz)	F1-26dB(Hz)	Fh-26dB(Hz)	Limit(Hz)	Port
81.967M	5.733958G	5.815925G	Inf	1
81.144M	5.734193G	5.815337G	Inf	2



Summary

Mode	Total Power (dBm)	Total Power (W)
5.15-5.25GHz	-	-
5.15-5.25GHz_802.11a_Nss1,(6Mbps)_2TX	24.53	0.28379
5.15-5.25GHz_802.11ax HEW20_Nss1,(MCS0)_2TX	24.00	0.25119
5.15-5.25GHz_802.11ax HEW20-BF_Nss1,(MCS0)_2TX	24.00	0.25119
5.15-5.25GHz_802.11ax HEW40_Nss1,(MCS0)_2TX	22.72	0.18707
5.15-5.25GHz_802.11ax HEW40-BF_Nss1,(MCS0)_2TX	22.72	0.18707
5.15-5.25GHz_802.11ax HEW80_Nss1,(MCS0)_2TX	16.89	0.04887
5.15-5.25GHz_802.11ax HEW80-BF_Nss1,(MCS0)_2TX	16.89	0.04887
5.725-5.85GHz	-	-
5.725-5.85GHz_802.11a_Nss1,(6Mbps)_2TX	25.08	0.32211
5.725-5.85GHz_802.11ax HEW20_Nss1,(MCS0)_2TX	25.31	0.33963
5.725-5.85GHz_802.11ax HEW20-BF_Nss1,(MCS0)_2TX	25.31	0.33963
5.725-5.85GHz_802.11ax HEW40_Nss1,(MCS0)_2TX	23.81	0.24044
5.725-5.85GHz_802.11ax HEW40-BF_Nss1,(MCS0)_2TX	23.81	0.24044
5.725-5.85GHz_802.11ax HEW80_Nss1,(MCS0)_2TX	20.37	0.10889
5.725-5.85GHz_802.11ax HEW80-BF_Nss1,(MCS0)_2TX	20.37	0.10889



Result

Mode	Result	DG (dBi)	Port 1 (dBm)	Port 2 (dBm)	Total Power (dBm)	Power Limit (dBm)
5.15-5.25GHz_802.11a_Nss1,(6Mbps)_2TX	-	-	-	-	-	-
5180MHz	Pass	5.21	18.41	19.10	21.78	30.00
5200MHz	Pass	5.21	20.69	21.36	24.05	30.00
5240MHz	Pass	5.21	21.27	21.75	24.53	30.00
5745MHz	Pass	5.21	21.62	22.46	25.07	30.00
5785MHz	Pass	5.21	21.73	22.38	25.08	30.00
5825MHz	Pass	5.21	21.33	22.03	24.70	30.00
5.15-5.25GHz_802.11ax HEW20_Nss1,(MCS0)_2TX	-	-	-	-	-	-
5180MHz	Pass	5.21	19.00	19.58	22.31	30.00
5200MHz	Pass	5.21	20.61	21.33	24.00	30.00
5240MHz	Pass	5.21	20.63	20.99	23.82	30.00
5745MHz	Pass	5.21	21.10	21.72	24.43	30.00
5785MHz	Pass	5.21	21.92	22.65	25.31	30.00
5825MHz	Pass	5.21	20.54	21.29	23.94	30.00
5.15-5.25GHz_802.11ax HEW40_Nss1,(MCS0)_2TX	-	-	-	-	-	-
5190MHz	Pass	5.21	14.89	15.32	18.12	30.00
5230MHz	Pass	5.21	19.52	19.90	22.72	30.00
5755MHz	Pass	5.21	19.93	20.67	23.33	30.00
5795MHz	Pass	5.21	20.40	21.16	23.81	30.00
5.15-5.25GHz_802.11ax HEW80_Nss1,(MCS0)_2TX	-	-	-	-	-	-
5210MHz	Pass	5.21	13.81	13.94	16.89	30.00
5775MHz	Pass	5.21	16.92	17.76	20.37	30.00
5.15-5.25GHz_802.11ax HEW20-BF_Nss1,(MCS0)_2TX	-	-	-	-	-	-
5180MHz	Pass	8.17	19.00	19.58	22.31	27.83
5200MHz	Pass	8.17	20.61	21.33	24.00	27.83
5240MHz	Pass	8.17	20.63	20.99	23.82	27.83
5745MHz	Pass	8.17	21.10	21.72	24.43	27.83
5785MHz	Pass	8.17	21.92	22.65	25.31	27.83
5825MHz	Pass	8.17	20.54	21.29	23.94	27.83
5.15-5.25GHz_802.11ax HEW40-BF_Nss1,(MCS0)_2TX	-	-	-	-	-	-
5190MHz	Pass	8.17	14.89	15.32	18.12	27.83
5230MHz	Pass	8.17	19.52	19.90	22.72	27.83
5755MHz	Pass	8.17	19.93	20.67	23.33	27.83
5795MHz	Pass	8.17	20.40	21.16	23.81	27.83
5.15-5.25GHz_802.11ax HEW80-BF_Nss1,(MCS0)_2TX	-	-	-	-	-	-
5210MHz	Pass	8.17	13.81	13.94	16.89	27.83
5775MHz	Pass	8.17	16.92	17.76	20.37	27.83

DG = Directional Gain; Port X = Port X output power



Summary

Mode	PD (dBm/RBW)
5.15-5.25GHz	-
5.15-5.25GHz_802.11a_Nss1,(6Mbps)_2TX	13.77
5.15-5.25GHz_802.11ax HEW20_Nss1,(MCS0)_2TX	12.74
5.15-5.25GHz_802.11ax HEW40_Nss1,(MCS0)_2TX	8.89
5.15-5.25GHz_802.11ax HEW80_Nss1,(MCS0)_2TX	0.19
5.725-5.85GHz	-
5.725-5.85GHz_802.11a_Nss1,(6Mbps)_2TX	12.89
5.725-5.85GHz_802.11ax HEW20_Nss1,(MCS0)_2TX	12.13
5.725-5.85GHz_802.11ax HEW40_Nss1,(MCS0)_2TX	8.56
5.725-5.85GHz_802.11ax HEW80_Nss1,(MCS0)_2TX	2.10

RBW = 500kHz for 5.725-5.85GHz band / 1MHz for other band;

Result

Mode	Result	DG (dBi)	Port 1 (dBm/RBW)	Port 2 (dBm/RBW)	PD (dBm/RBW)	PD Limit (dBm/RBW)
5.15-5.25GHz_802.11a_Nss1,(6Mbps)_2TX	-	-	-	-	-	-
5180MHz	Pass	8.17	7.89	8.61	11.13	14.83
5200MHz	Pass	8.17	10.10	10.84	13.41	14.83
5240MHz	Pass	8.17	10.58	11.07	13.77	14.83
5745MHz	Pass	8.17	9.52	10.59	12.89	27.83
5785MHz	Pass	8.17	9.64	10.45	12.82	27.83
5825MHz	Pass	8.17	9.41	10.28	12.60	27.83
5.15-5.25GHz_802.11ax HEW20_Nss1,(MCS0)_2TX	-	-	-	-	-	-
5180MHz	Pass	8.17	7.91	8.47	11.14	14.83
5200MHz	Pass	8.17	9.48	10.13	12.74	14.83
5240MHz	Pass	8.17	9.43	9.73	12.54	14.83
5745MHz	Pass	8.17	8.40	9.23	11.67	27.83
5785MHz	Pass	8.17	8.71	9.67	12.13	27.83
5825MHz	Pass	8.17	8.01	8.77	11.24	27.83
5.15-5.25GHz_802.11ax HEW40_Nss1,(MCS0)_2TX	-	-	-	-	-	-
5190MHz	Pass	8.17	1.09	1.57	4.28	14.83
5230MHz	Pass	8.17	5.78	6.13	8.89	14.83
5755MHz	Pass	8.17	4.78	5.70	8.02	27.83
5795MHz	Pass	8.17	5.19	6.27	8.56	27.83
5.15-5.25GHz_802.11ax HEW80_Nss1,(MCS0)_2TX	-	-	-	-	-	-
5210MHz	Pass	8.17	-2.82	-2.64	0.19	14.83
5775MHz	Pass	8.17	-0.94	-0.09	2.10	27.83

DG = Directional Gain; RBW = 500kHz for 5.725-5.85GHz band / 1MHz for other band;
 PD = trace bin-by-bin of each transmits port summing can be performed maximum power density; Port X = Port X Power Density;

5.15-5.25GHz_802.11a_Nss1,(6Mbps)_2TX

PSD

5180MHz

01/10/2022

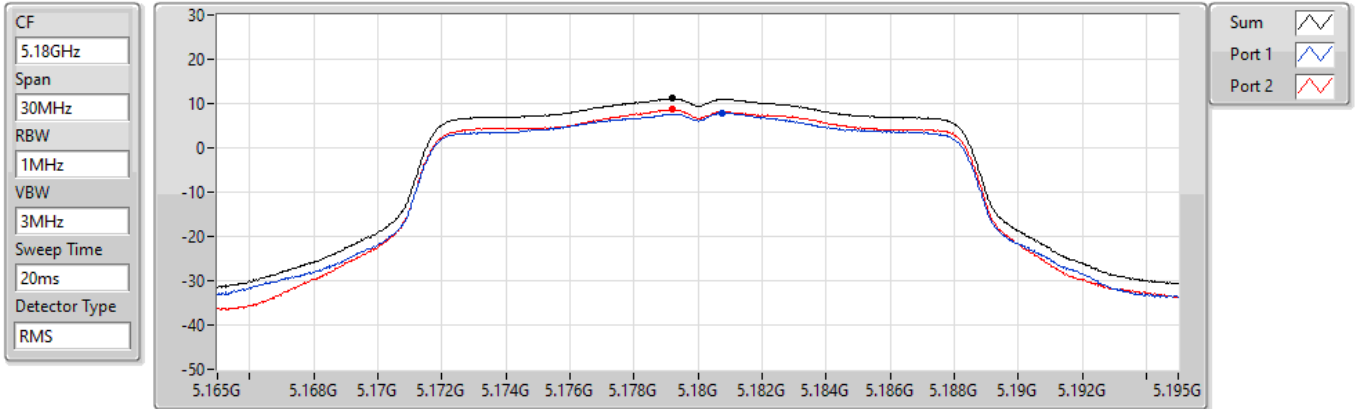

Sum	PD	Port 1	Port 2
(dBm/RBW)	(dBm/RBW)	(dBm/RBW)	(dBm/RBW)
11.13	11.13	7.89	8.61

5.15-5.25GHz_802.11a_Nss1,(6Mbps)_2TX

PSD

5200MHz

01/10/2022

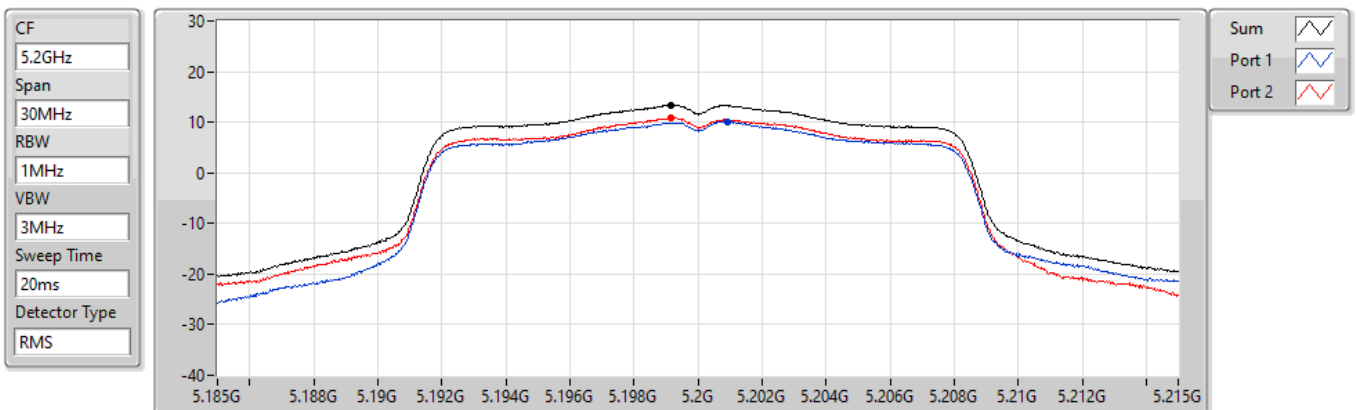

Sum	PD	Port 1	Port 2
(dBm/RBW)	(dBm/RBW)	(dBm/RBW)	(dBm/RBW)
13.41	13.41	10.10	10.84

5.15-5.25GHz_802.11a_Nss1,(6Mbps)_2TX

PSD

5240MHz

01/10/2022

CF
5.24GHz

Span
30MHz

RBW
1MHz

VBW
3MHz

Sweep Time
20ms

Detector Type
RMS

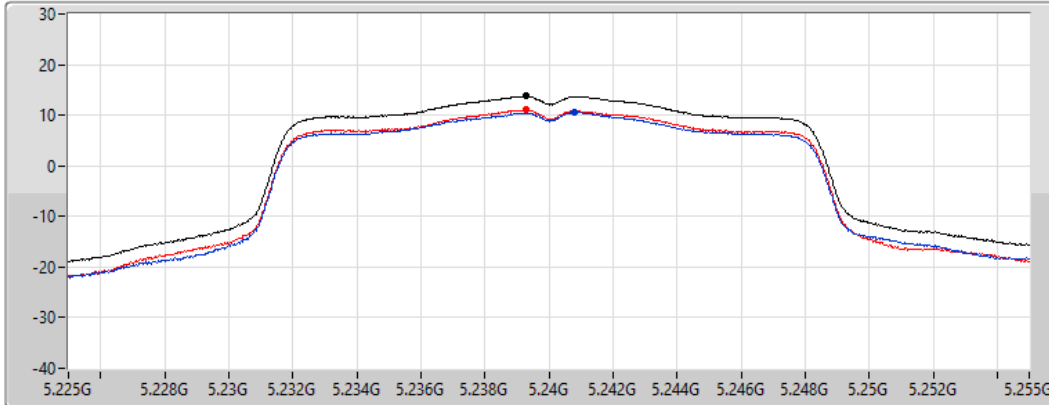

Sum 

Port 1 

Port 2 

Sum	PD	Port 1	Port 2
(dBm/RBW)	(dBm/RBW)	(dBm/RBW)	(dBm/RBW)
13.77	13.77	10.58	11.07

5.725-5.85GHz_802.11a_Nss1,(6Mbps)_2TX

PSD

5745MHz

01/10/2022

CF
5.745GHz

Span
30MHz

RBW
500kHz

VBW
3MHz

Sweep Time
20ms

Detector Type
RMS

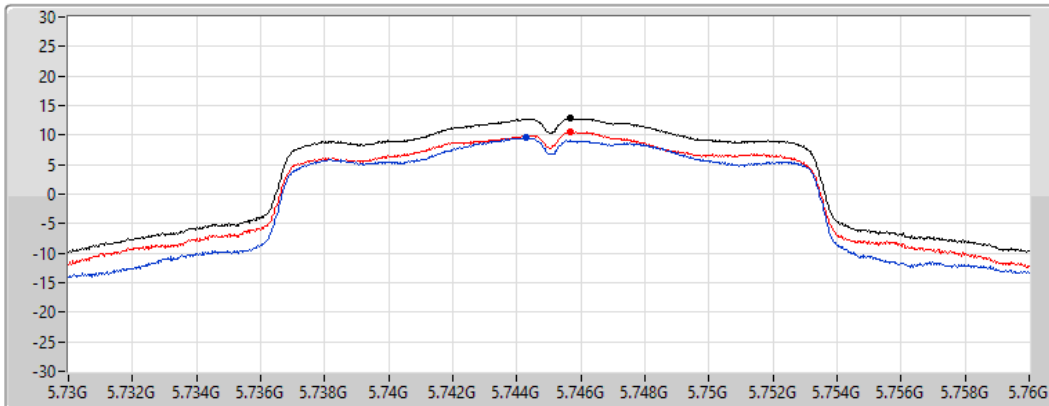

Sum 

Port 1 

Port 2 

Sum	PD	Port 1	Port 2
(dBm/RBW)	(dBm/RBW)	(dBm/RBW)	(dBm/RBW)
12.89	12.89	9.52	10.59

5.725-5.85GHz_802.11a_Nss1,(6Mbps)_2TX

PSD

5785MHz

01/10/2022

CF
5.785GHz

Span
30MHz

RBW
500kHz

VBW
3MHz

Sweep Time
20ms

Detector Type
RMS

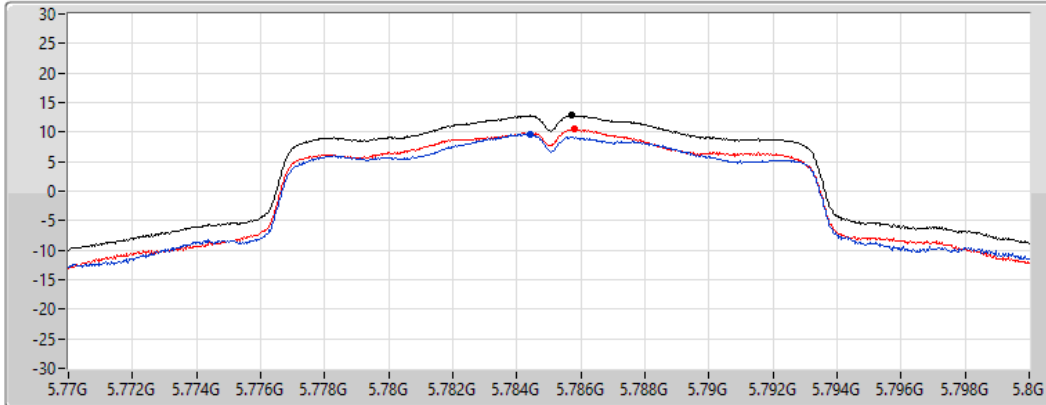

Sum

Port 1

Port 2

Sum	PD	Port 1	Port 2
(dBm/RBW)	(dBm/RBW)	(dBm/RBW)	(dBm/RBW)
12.82	12.82	9.64	10.45

5.725-5.85GHz_802.11a_Nss1,(6Mbps)_2TX

PSD

5825MHz

01/10/2022

CF
5.825GHz

Span
30MHz

RBW
500kHz

VBW
3MHz

Sweep Time
20ms

Detector Type
RMS

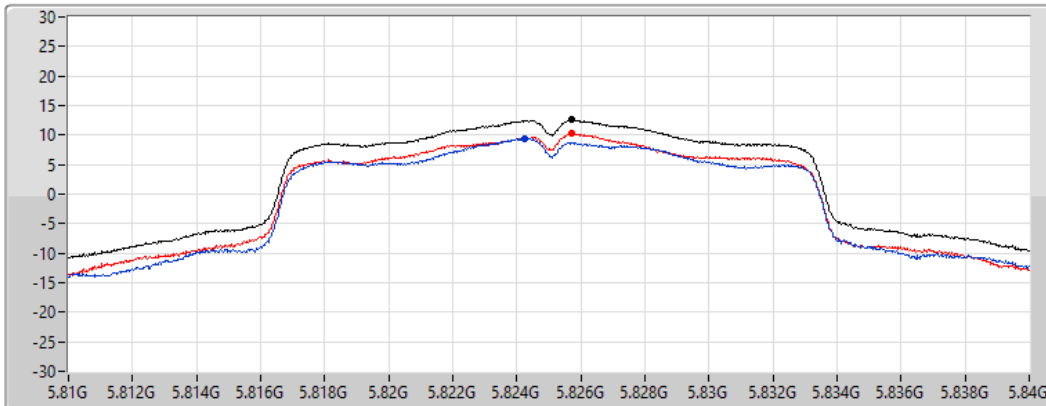

Sum

Port 1

Port 2

Sum	PD	Port 1	Port 2
(dBm/RBW)	(dBm/RBW)	(dBm/RBW)	(dBm/RBW)
12.60	12.60	9.41	10.28

5.15-5.25GHz_802.11ax HEW20_Nss1,(MCS0)_2TX



PSD

5180MHz

01/10/2022

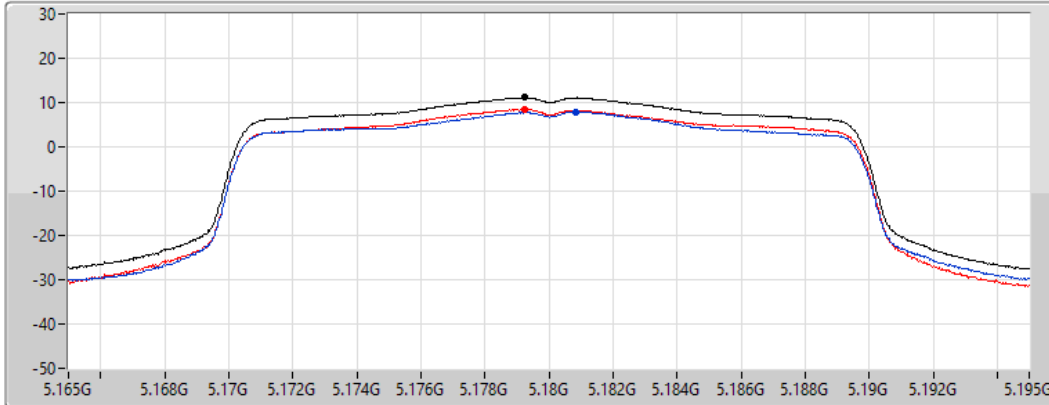
CF
5.18GHz
Span
30MHz
RBW
1MHz
VBW
3MHz
Sweep Time
20ms
Detector Type
RMS



Sum 
Port 1 
Port 2 

Sum	PD	Port 1	Port 2
(dBm/RBW)	(dBm/RBW)	(dBm/RBW)	(dBm/RBW)
11.14	11.14	7.91	8.47

5.15-5.25GHz_802.11ax HEW20_Nss1,(MCS0)_2TX



PSD

5200MHz

01/10/2022

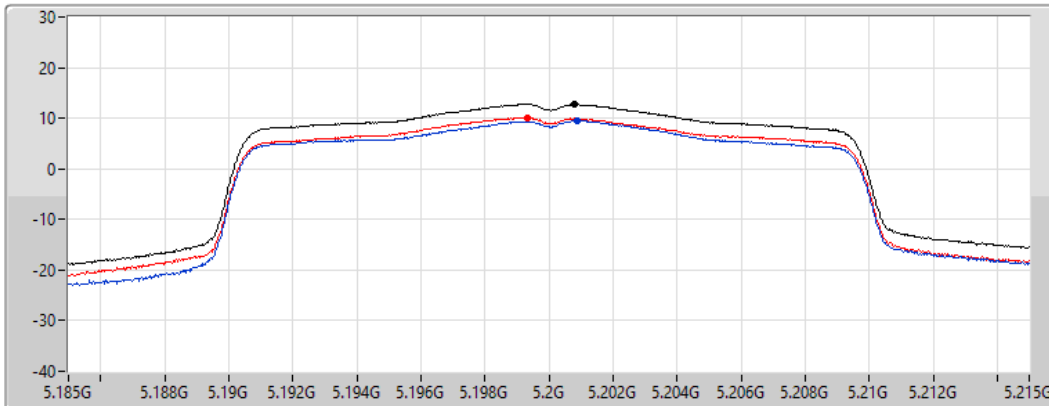
CF
5.2GHz
Span
30MHz
RBW
1MHz
VBW
3MHz
Sweep Time
20ms
Detector Type
RMS



Sum 
Port 1 
Port 2 

Sum	PD	Port 1	Port 2
(dBm/RBW)	(dBm/RBW)	(dBm/RBW)	(dBm/RBW)
12.74	12.74	9.48	10.13

5.15-5.25GHz_802.11ax HEW20_Nss1,(MCS0)_2TX

PSD

5240MHz

01/10/2022

CF
5.24GHz
Span
30MHz
RBW
1MHz
VBW
3MHz
Sweep Time
20ms
Detector Type
RMS

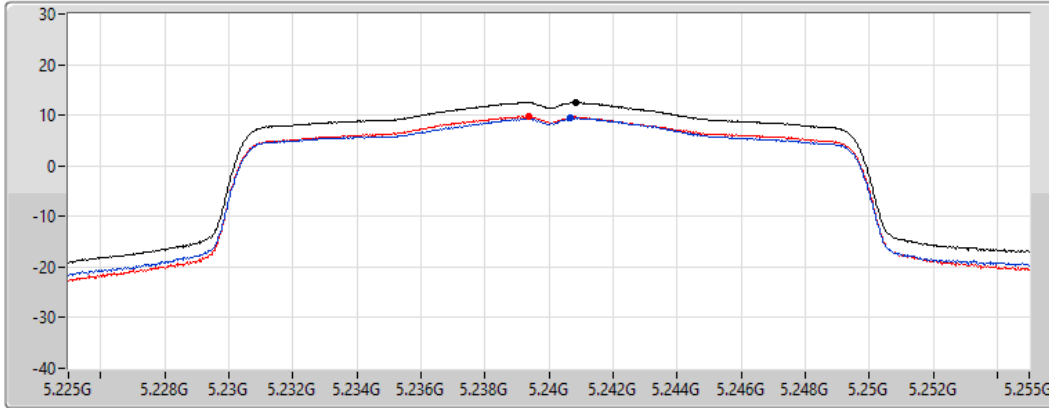

Sum
Port 1
Port 2

Sum	PD	Port 1	Port 2
(dBm/RBW)	(dBm/RBW)	(dBm/RBW)	(dBm/RBW)
12.54	12.54	9.43	9.73

5.725-5.85GHz_802.11ax HEW20_Nss1,(MCS0)_2TX

PSD

5745MHz

01/10/2022

CF
5.745GHz
Span
30MHz
RBW
500kHz
VBW
3MHz
Sweep Time
20ms
Detector Type
RMS

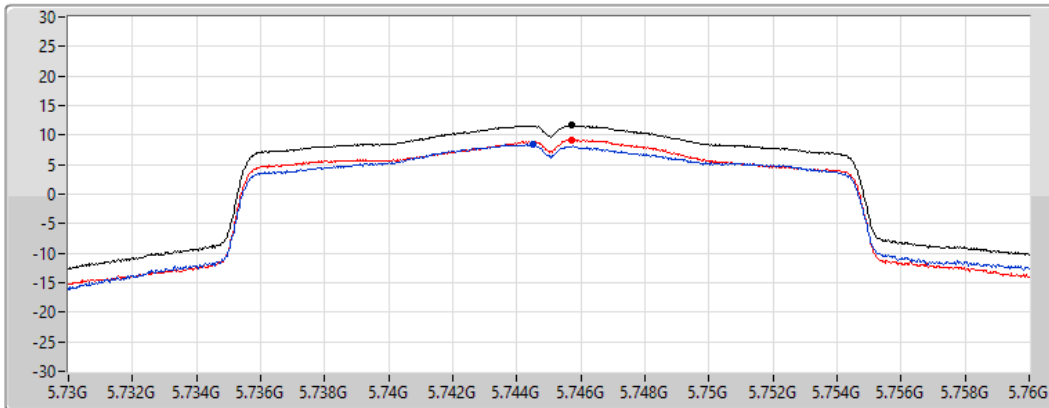

Sum
Port 1
Port 2

Sum	PD	Port 1	Port 2
(dBm/RBW)	(dBm/RBW)	(dBm/RBW)	(dBm/RBW)
11.67	11.67	8.40	9.23

5.725-5.85GHz_802.11ax HEW20_Nss1,(MCS0)_2TX

PSD

5785MHz

01/10/2022

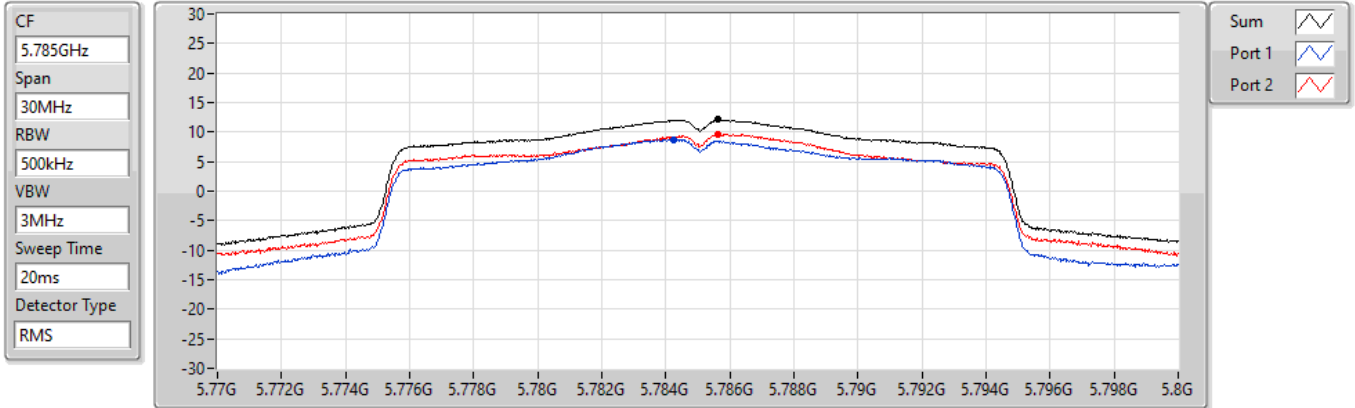

Sum	PD	Port 1	Port 2
(dBm/RBW)	(dBm/RBW)	(dBm/RBW)	(dBm/RBW)
12.13	12.13	8.71	9.67

5.725-5.85GHz_802.11ax HEW20_Nss1,(MCS0)_2TX

PSD

5825MHz

01/10/2022

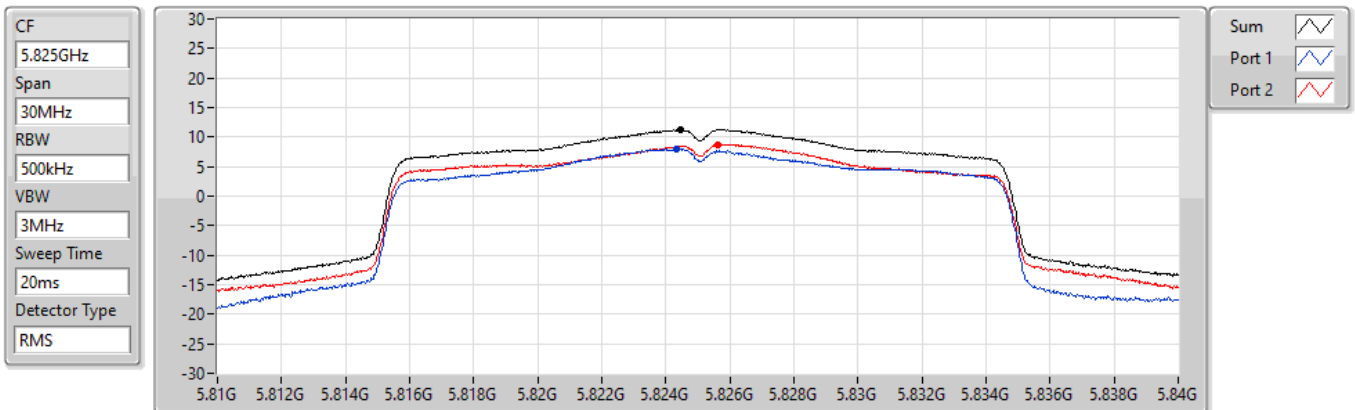

Sum	PD	Port 1	Port 2
(dBm/RBW)	(dBm/RBW)	(dBm/RBW)	(dBm/RBW)
11.24	11.24	8.01	8.77

5.15-5.25GHz_802.11ax HEW40_Nss1,(MCS0)_2TX

PSD

5190MHz

01/10/2022

CF
5.19GHz
Span
60MHz
RBW
1MHz
VBW
3MHz
Sweep Time
20ms
Detector Type
RMS

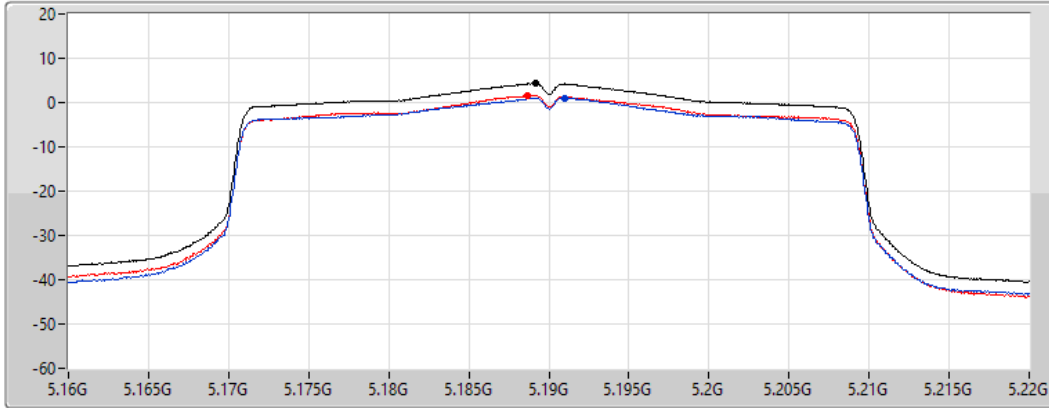

Sum
Port 1
Port 2

Sum	PD	Port 1	Port 2
(dBm/RBW)	(dBm/RBW)	(dBm/RBW)	(dBm/RBW)
4.28	4.28	1.09	1.57

5.15-5.25GHz_802.11ax HEW40_Nss1,(MCS0)_2TX

PSD

5230MHz

01/10/2022

CF
5.23GHz
Span
60MHz
RBW
1MHz
VBW
3MHz
Sweep Time
20ms
Detector Type
RMS

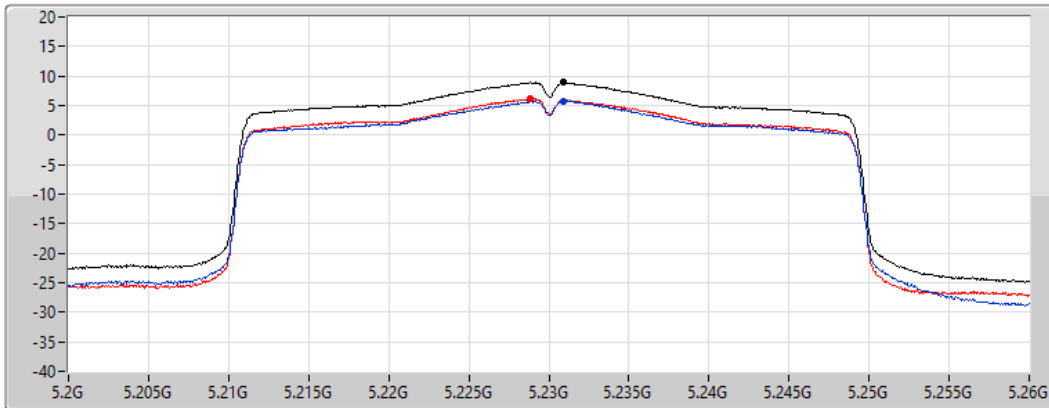

Sum
Port 1
Port 2

Sum	PD	Port 1	Port 2
(dBm/RBW)	(dBm/RBW)	(dBm/RBW)	(dBm/RBW)
8.89	8.89	5.78	6.13

5.725-5.85GHz_802.11ax HEW40_Nss1,(MCS0)_2TX

PSD

5755MHz

01/10/2022

CF
5.755GHz
Span
60MHz
RBW
500kHz
VBW
3MHz
Sweep Time
20ms
Detector Type
RMS

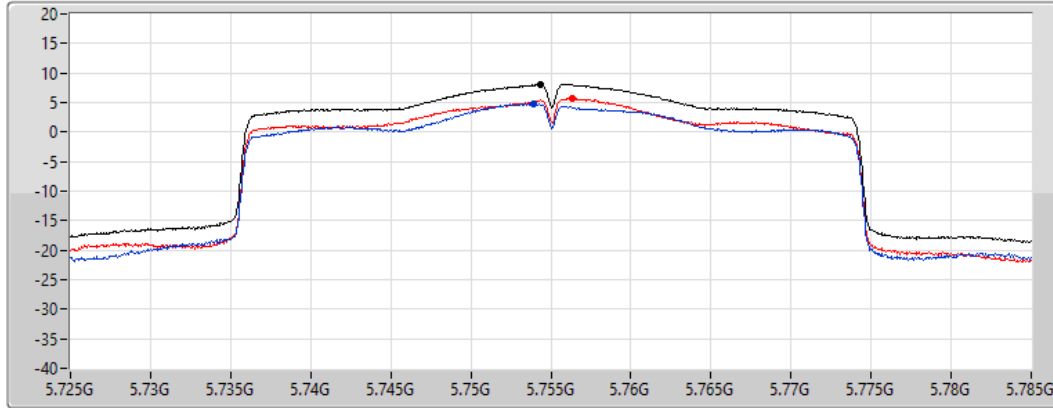

Sum
Port 1
Port 2

Sum	PD	Port 1	Port 2
(dBm/RBW)	(dBm/RBW)	(dBm/RBW)	(dBm/RBW)
8.02	8.02	4.78	5.70

5.725-5.85GHz_802.11ax HEW40_Nss1,(MCS0)_2TX

PSD

5795MHz

01/10/2022

CF
5.795GHz
Span
60MHz
RBW
500kHz
VBW
3MHz
Sweep Time
20ms
Detector Type
RMS

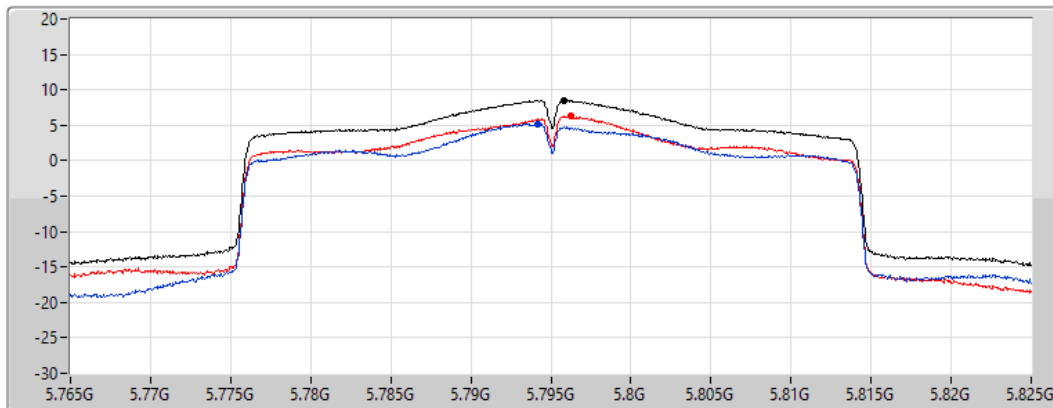

Sum
Port 1
Port 2

Sum	PD	Port 1	Port 2
(dBm/RBW)	(dBm/RBW)	(dBm/RBW)	(dBm/RBW)
8.56	8.56	5.19	6.27

5.15-5.25GHz_802.11ax HEW80_Nss1,(MCS0)_2TX

PSD

5210MHz

01/10/2022

CF
5.21GHz
Span
120MHz
RBW
1MHz
VBW
3MHz
Sweep Time
20ms
Detector Type
RMS

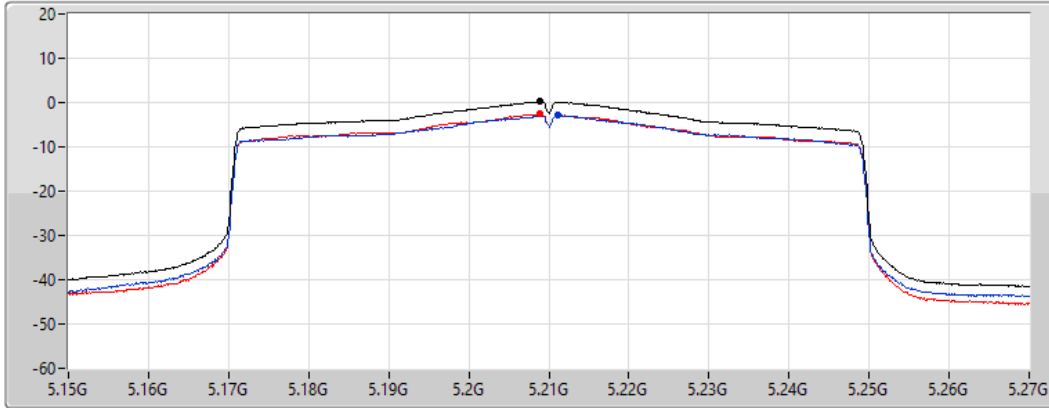

Sum
Port 1
Port 2

Sum	PD	Port 1	Port 2
(dBm/RBW)	(dBm/RBW)	(dBm/RBW)	(dBm/RBW)
0.19	0.19	-2.82	-2.64

5.725-5.85GHz_802.11ax HEW80_Nss1,(MCS0)_2TX

PSD

5775MHz

01/10/2022

CF
5.775GHz
Span
120MHz
RBW
500kHz
VBW
3MHz
Sweep Time
20ms
Detector Type
RMS

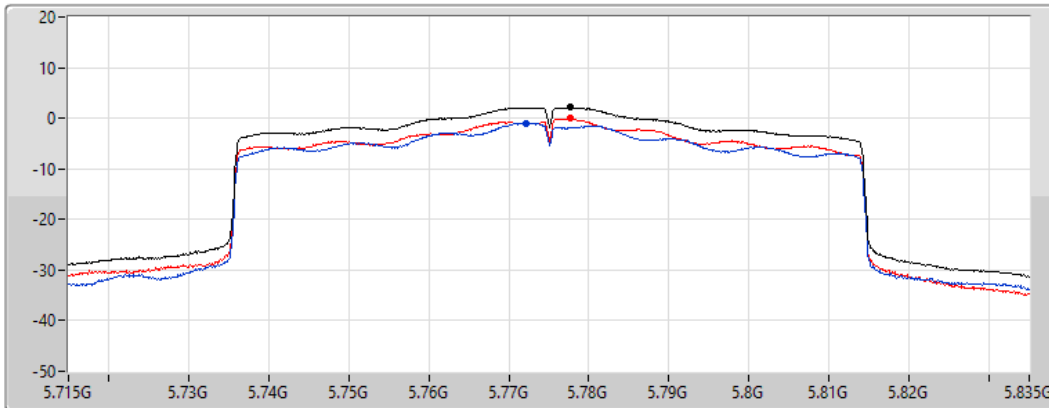

Sum
Port 1
Port 2

Sum	PD	Port 1	Port 2
(dBm/RBW)	(dBm/RBW)	(dBm/RBW)	(dBm/RBW)
2.10	2.10	-0.94	-0.09



Summary

Mode	Result	Type	Freq (Hz)	Level (dBuV/m)	Limit (dBuV/m)	Margin (dB)	Condition
Mode 3	Pass	QP	44.55M	36.91	40.00	-3.09	Vertical

Mode 3

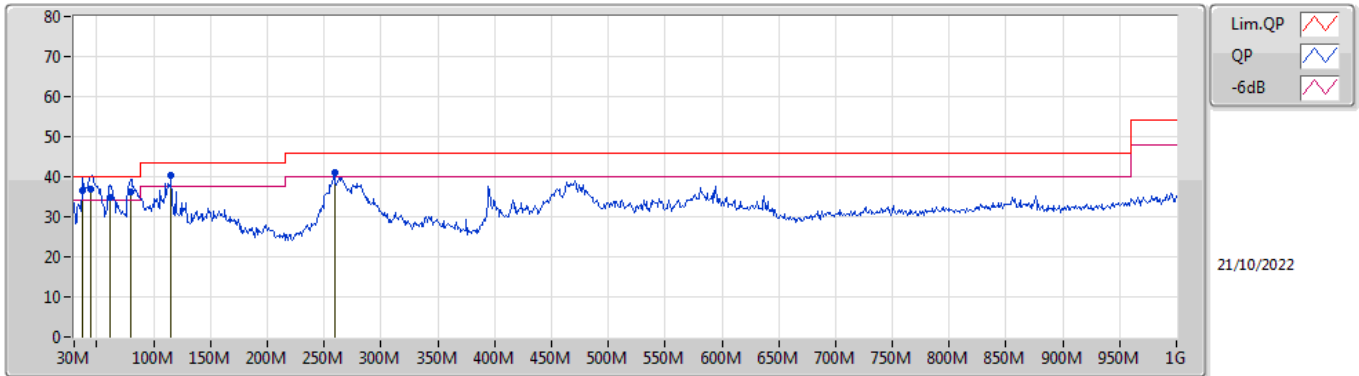

Type	Freq (Hz)	Level (dBuV/m)	Limit (dBuV/m)	Margin (dB)	Factor (dB/m)	Dist (m)	Condition	Azimuth (°)	Height (m)	Comment	Raw (dBuV/m)	AF (dB/m)	CL (dB)	PA (dB)
QP	37.76M	36.69	40.00	-3.31	-10.89	3	Vertical	191	1.00	-	47.58	20.43	1.14	32.46
QP	44.55M	36.91	40.00	-3.09	-14.49	3	Vertical	291	1.00	"Worst"	51.40	16.76	1.23	32.48
QP	61.04M	34.88	40.00	-5.12	-18.52	3	Vertical	0	1.50	-	53.40	12.44	1.50	32.46
QP	79.47M	36.28	40.00	-3.72	-17.81	3	Vertical	0	2.00	-	54.09	12.92	1.66	32.39
PK	115.36M	40.26	43.50	-3.24	-12.47	3	Vertical	224	1.00	-	52.73	17.90	2.02	32.39
PK	258.92M	40.87	46.00	-5.13	-9.65	3	Vertical	125	1.25	-	50.52	19.57	3.09	32.31

Mode 3

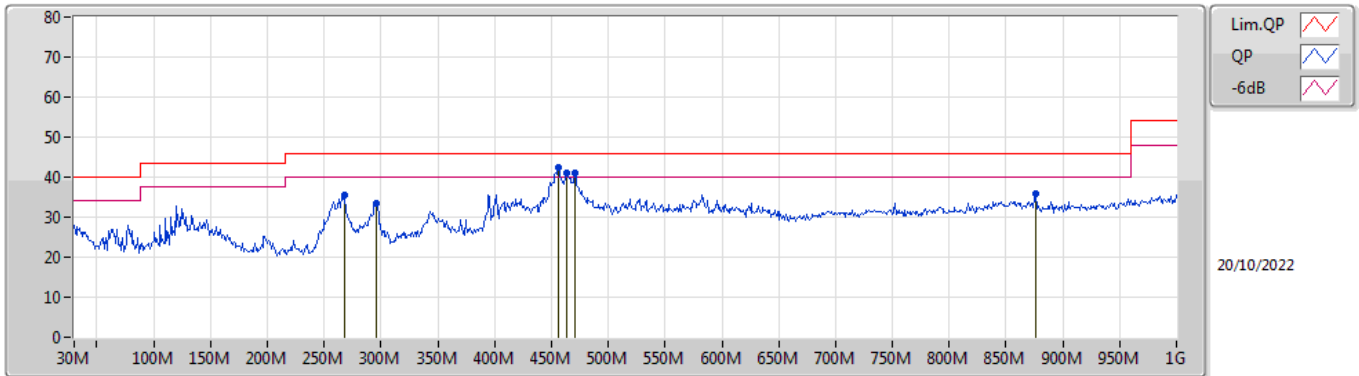

Type	Freq (Hz)	Level (dBuV/m)	Limit (dBuV/m)	Margin (dB)	Factor (dB/m)	Dist (m)	Condition	Azimuth (°)	Height (m)	Comment	Raw (dBuV/m)	AF (dB/m)	CL (dB)	PA (dB)
PK	267.65M	35.49	46.00	-10.51	-9.99	3	Horizontal	186	1.00	-	45.48	19.19	3.14	32.32
PK	295.78M	33.37	46.00	-12.63	-10.05	3	Horizontal	249	1.25	-	43.42	18.99	3.32	32.36
PK	455.83M	42.34	46.00	-3.66	-5.23	3	Horizontal	252	1.00	"Worst"	47.57	22.72	4.20	32.15
PK	463.59M	41.11	46.00	-4.89	-5.03	3	Horizontal	252	1.00	-	46.14	22.90	4.23	32.16
PK	470.38M	40.94	46.00	-5.06	-4.82	3	Horizontal	278	1.00	-	45.76	23.09	4.26	32.17
PK	875.84M	35.73	46.00	-10.27	0.68	3	Horizontal	181	1.00	-	35.05	26.31	5.92	31.55



Summary

Mode	Result	Type	Freq (Hz)	Level (dBuV/m)	Limit (dBuV/m)	Margin (dB)	Dist (m)	Condition	Azimuth (°)	Height (m)	Comments
5.725-5.85GHz	-	-	-	-	-	-	-	-	-	-	-
802.11a_Nss1,(6Mbps)_2TX	Pass	PK	5.928G	68.16	68.20	-0.04	3	Horizontal	7	1.05	-

802.11a_Nss1,(6Mbps)_2TX

5180MHz_TnomVnom

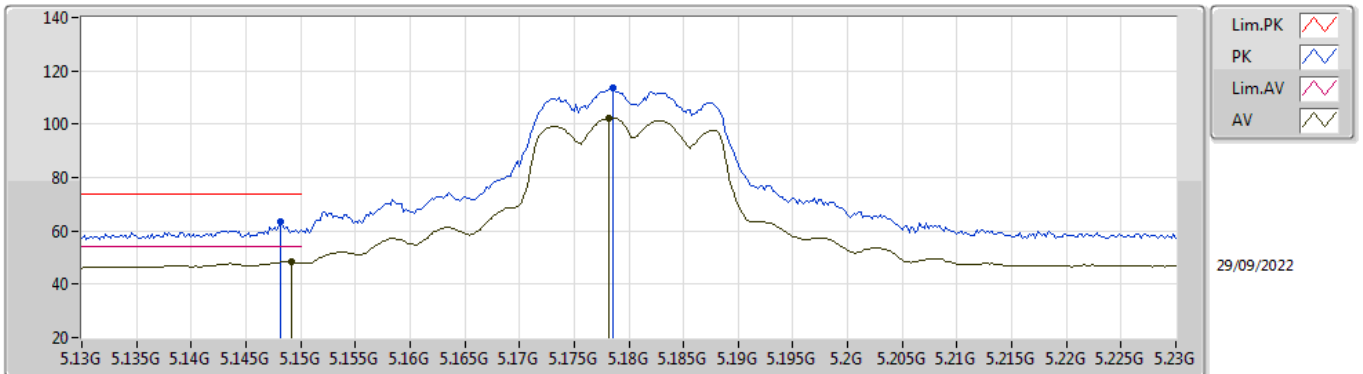

EUT_X_2TX
Setting 18
02-F-G-4-10

Type	Freq (Hz)	Level (dBuV/m)	Limit (dBuV/m)	Margin (dB)	Raw (dBuV)	Dist (m)	Condition	Azimuth (°)	Height (m)	Comment	AF (dB)	CL (dB)	PA (dB)
PK	5.1482G	63.23	74.00	-10.77	55.11	3	Vertical	4	2.04	-	33.60	5.25	30.73
AV	5.1492G	48.41	54.00	-5.59	40.29	3	Vertical	4	2.04	-	33.60	5.25	30.73
PK	5.1786G	113.47	Inf	-Inf	105.26	3	Vertical	4	2.04	-	33.66	5.28	30.73
AV	5.1782G	102.13	Inf	-Inf	93.92	3	Vertical	4	2.04	-	33.66	5.28	30.73

802.11a_Nss1,(6Mbps)_2TX

5180MHz_TnomVnom

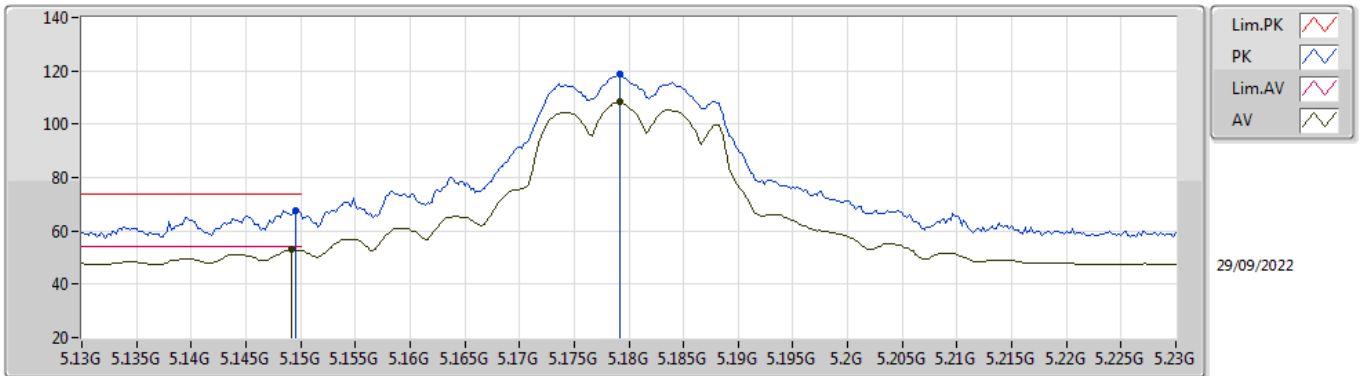

EUT_X_2TX
Setting 18
02-F-G-4-10

Type	Freq (Hz)	Level (dBuV/m)	Limit (dBuV/m)	Margin (dB)	Raw (dBuV)	Dist (m)	Condition	Azimuth (°)	Height (m)	Comment	AF (dB)	CL (dB)	PA (dB)
PK	5.1496G	67.80	74.00	-6.20	59.68	3	Horizontal	10	1.92	-	33.60	5.25	30.73
AV	5.1492G	52.90	54.00	-1.10	44.78	3	Horizontal	10	1.92	-	33.60	5.25	30.73
PK	5.1792G	118.55	Inf	-Inf	110.34	3	Horizontal	10	1.92	-	33.66	5.28	30.73
AV	5.1792G	108.35	Inf	-Inf	100.14	3	Horizontal	10	1.92	-	33.66	5.28	30.73

802.11a_Nss1,(6Mbps)_2TX

5180MHz_TnomVnom

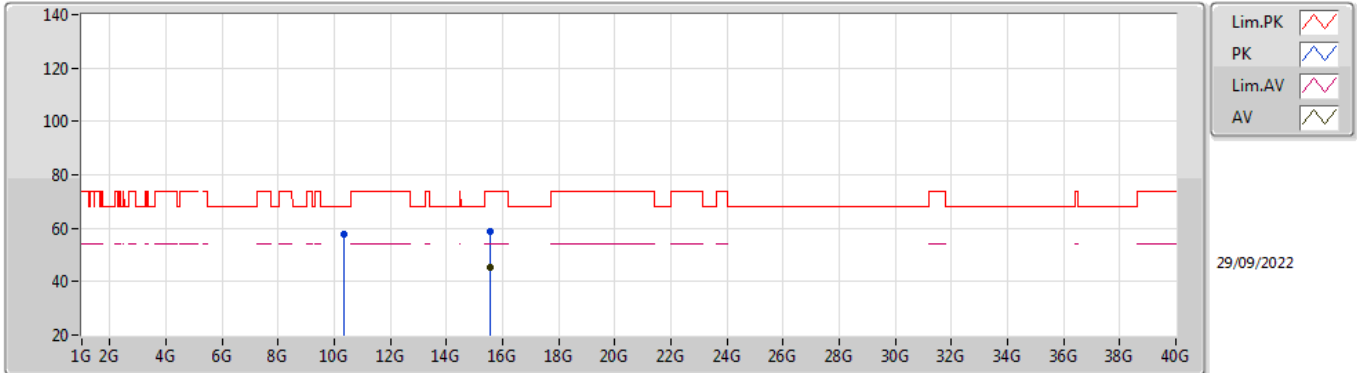

EUT X_2TX
Setting 18
02-F-G-4

Type	Freq (Hz)	Level (dBuV/m)	Limit (dBuV/m)	Margin (dB)	Raw (dBuV)	Dist (m)	Condition	Azimuth (°)	Height (m)	Comment	AF (dB)	CL (dB)	PA (dB)
PK	10.35982G	57.88	68.20	-10.32	43.63	3	Vertical	19	2.06	-	38.64	7.44	31.83
PK	15.54606G	58.88	74.00	-15.12	42.61	3	Vertical	102	1.83	-	37.82	9.80	31.35
AV	15.54198G	45.24	54.00	-8.76	28.95	3	Vertical	102	1.83	-	37.85	9.79	31.35

802.11a_Nss1,(6Mbps)_2TX

5180MHz_TnomVnom

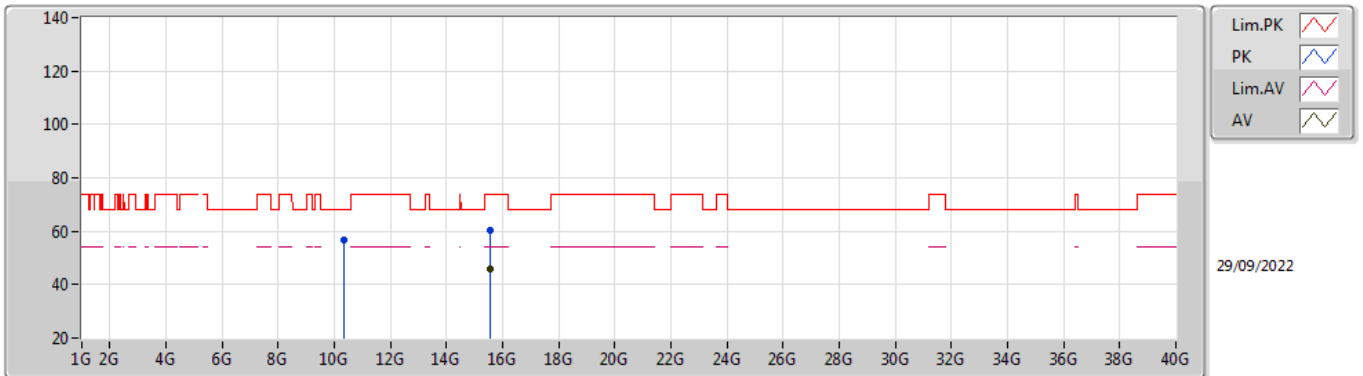

EUT_X_2TX
Setting 18
02-F-G-4

Type	Freq (Hz)	Level (dBuV/m)	Limit (dBuV/m)	Margin (dB)	Raw (dBuV)	Dist (m)	Condition	Azimuth (°)	Height (m)	Comment	AF (dB)	CL (dB)	PA (dB)
PK	10.35994G	56.90	68.20	-11.30	42.65	3	Horizontal	263	1.66	-	38.64	7.44	31.83
PK	15.54282G	60.43	74.00	-13.57	44.15	3	Horizontal	52	1.77	-	37.84	9.79	31.35
AV	15.54174G	46.07	54.00	-7.93	29.78	3	Horizontal	52	1.77	-	37.85	9.79	31.35

802.11a_Nss1,(6Mbps)_2TX

5200MHz_TnomVnom

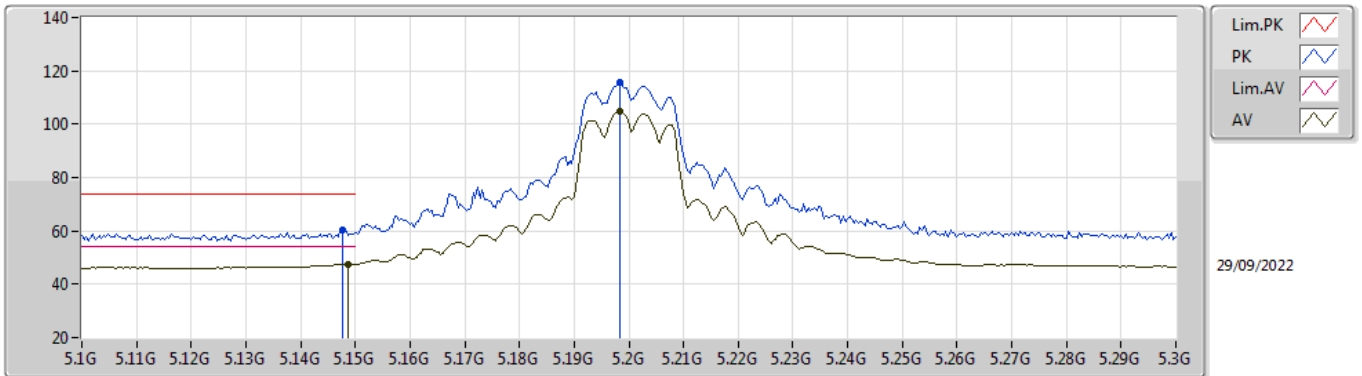

EUT_X_2TX
Setting 20.5
02-F-G-4-10

Type	Freq (Hz)	Level (dBuV/m)	Limit (dBuV/m)	Margin (dB)	Raw (dBuV)	Dist (m)	Condition	Azimuth (°)	Height (m)	Comment	AF (dB)	CL (dB)	PA (dB)
PK	5.1476G	60.60	74.00	-13.40	52.48	3	Vertical	3	2.03	-	33.60	5.25	30.73
AV	5.1488G	47.60	54.00	-6.40	39.48	3	Vertical	3	2.03	-	33.60	5.25	30.73
PK	5.1984G	115.72	Inf	-Inf	107.45	3	Vertical	3	2.03	-	33.70	5.30	30.73
AV	5.1984G	104.64	Inf	-Inf	96.37	3	Vertical	3	2.03	-	33.70	5.30	30.73

802.11a_Nss1,(6Mbps)_2TX

5200MHz_TnomVnom

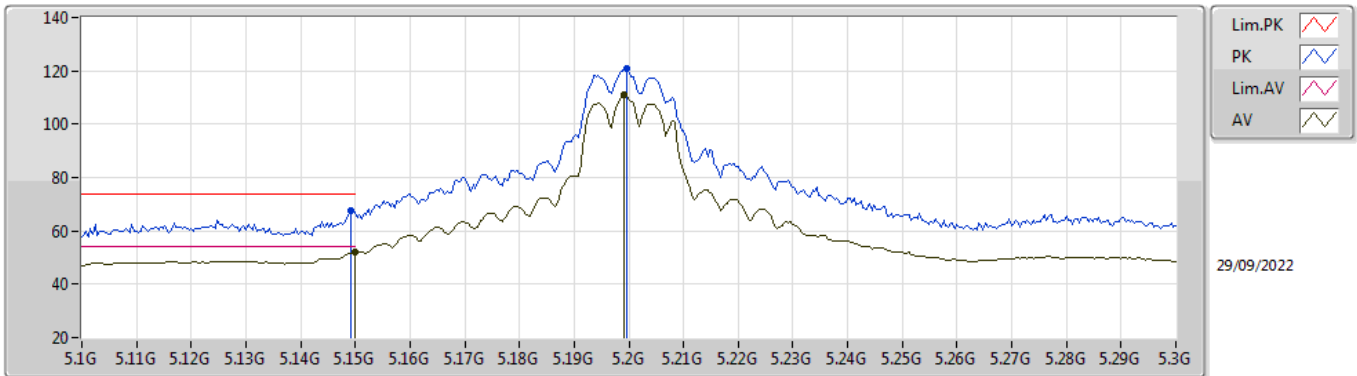

EUT_X_2TX
 Setting 20.5
 02-F-G-4-10

Type	Freq (Hz)	Level (dBuV/m)	Limit (dBuV/m)	Margin (dB)	Raw (dBuV)	Dist (m)	Condition	Azimuth (°)	Height (m)	Comment	AF (dB)	CL (dB)	PA (dB)
PK	5.1492G	67.82	74.00	-6.18	59.70	3	Horizontal	360	2.64	-	33.60	5.25	30.73
AV	5.15G	52.05	54.00	-1.95	43.93	3	Horizontal	360	2.64	-	33.60	5.25	30.73
PK	5.1996G	120.88	Inf	-Inf	112.61	3	Horizontal	360	2.64	-	33.70	5.30	30.73
AV	5.1992G	110.92	Inf	-Inf	102.65	3	Horizontal	360	2.64	-	33.70	5.30	30.73

802.11a_Nss1,(6Mbps)_2TX

5200MHz_TnomVnom

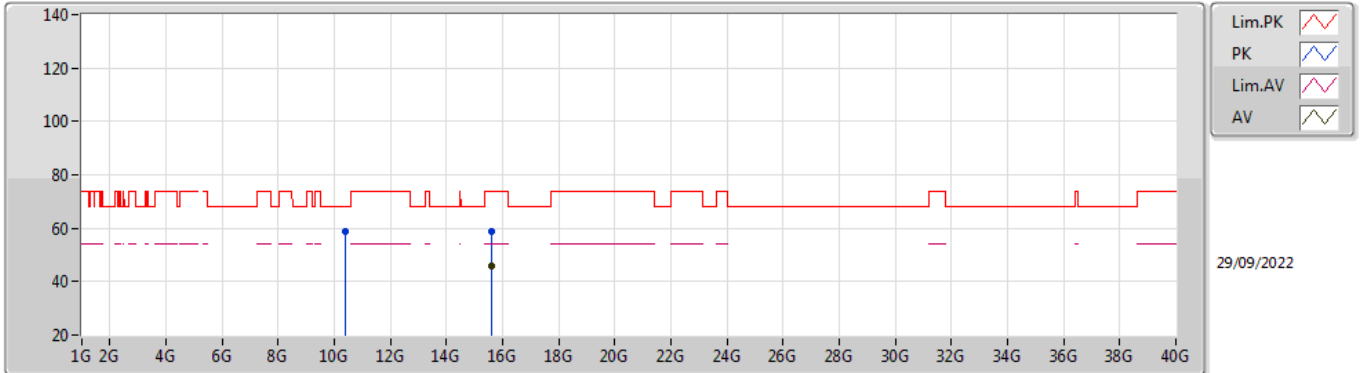

EUT X_2TX
Setting 20.5
02-F-G-4

Type	Freq (Hz)	Level (dBuV/m)	Limit (dBuV/m)	Margin (dB)	Raw (dBuV)	Dist (m)	Condition	Azimuth (°)	Height (m)	Comment	AF (dB)	CL (dB)	PA (dB)
PK	10.4G	58.66	68.20	-9.54	44.43	3	Vertical	18	2.15	-	38.60	7.46	31.83
PK	15.6009G	58.91	74.00	-15.09	42.97	3	Vertical	329	1.40	-	37.50	9.82	31.38
AV	15.59712G	46.01	54.00	-7.99	30.05	3	Vertical	329	1.40	-	37.52	9.82	31.38

802.11a_Nss1,(6Mbps)_2TX

5200MHz_TnomVnom

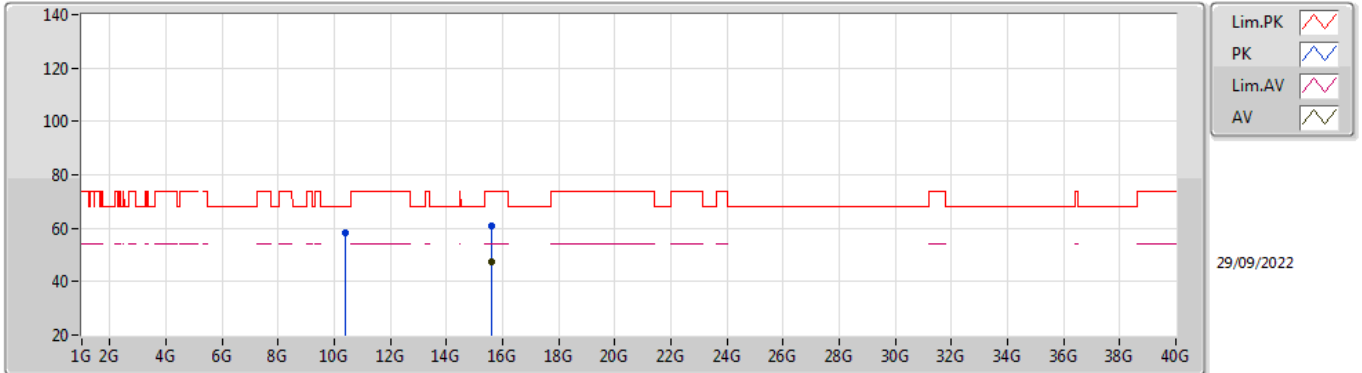

EUT X_2TX
Setting 20.5
02-F-G-4

Type	Freq (Hz)	Level (dBuV/m)	Limit (dBuV/m)	Margin (dB)	Raw (dBuV)	Dist (m)	Condition	Azimuth (°)	Height (m)	Comment	AF (dB)	CL (dB)	PA (dB)
PK	10.39994G	58.05	68.20	-10.15	43.82	3	Horizontal	264	1.61	-	38.60	7.46	31.83
PK	15.59628G	60.85	74.00	-13.15	44.89	3	Horizontal	56	1.80	-	37.52	9.82	31.38
AV	15.5973G	47.30	54.00	-6.70	31.34	3	Horizontal	56	1.80	-	37.52	9.82	31.38

802.11a_Nss1,(6Mbps)_2TX

5240MHz_TnomVnom

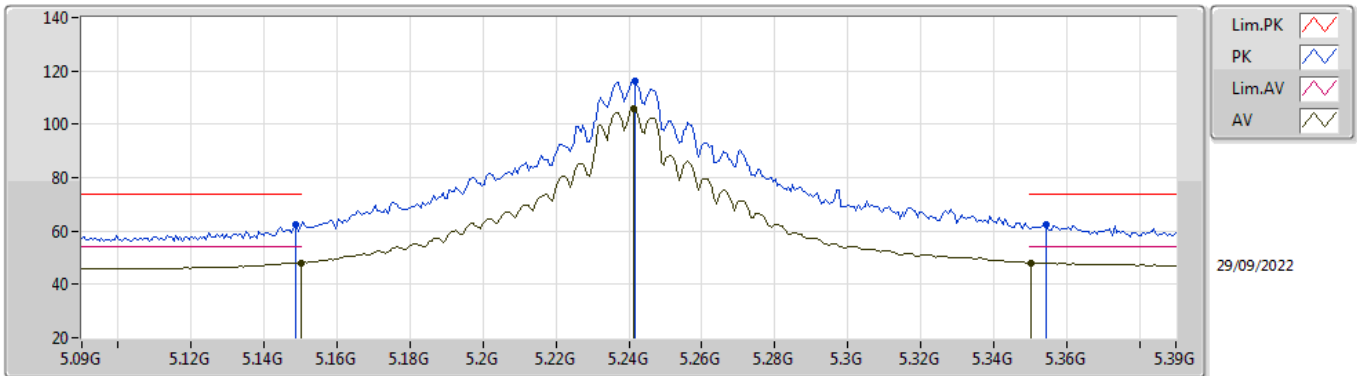

EUT_X_2TX
Setting 23
02-F-G-4-10

Type	Freq (Hz)	Level (dBuV/m)	Limit (dBuV/m)	Margin (dB)	Raw (dBuV)	Dist (m)	Condition	Azimuth (°)	Height (m)	Comment	AF (dB)	CL (dB)	PA (dB)
PK	5.1488G	62.32	74.00	-11.68	54.20	3	Vertical	335	1.80	-	33.60	5.25	30.73
AV	5.15G	48.09	54.00	-5.91	39.97	3	Vertical	335	1.80	-	33.60	5.25	30.73
PK	5.2418G	116.04	Inf	-Inf	107.75	3	Vertical	335	1.80	-	33.70	5.32	30.73
AV	5.2412G	106.04	Inf	-Inf	97.75	3	Vertical	335	1.80	-	33.70	5.32	30.73
PK	5.3546G	62.55	74.00	-11.45	53.98	3	Vertical	335	1.80	-	33.91	5.38	30.72
AV	5.3504G	48.07	54.00	-5.93	39.51	3	Vertical	335	1.80	-	33.90	5.38	30.72

802.11a_Nss1,(6Mbps)_2TX

5240MHz_TnomVnom

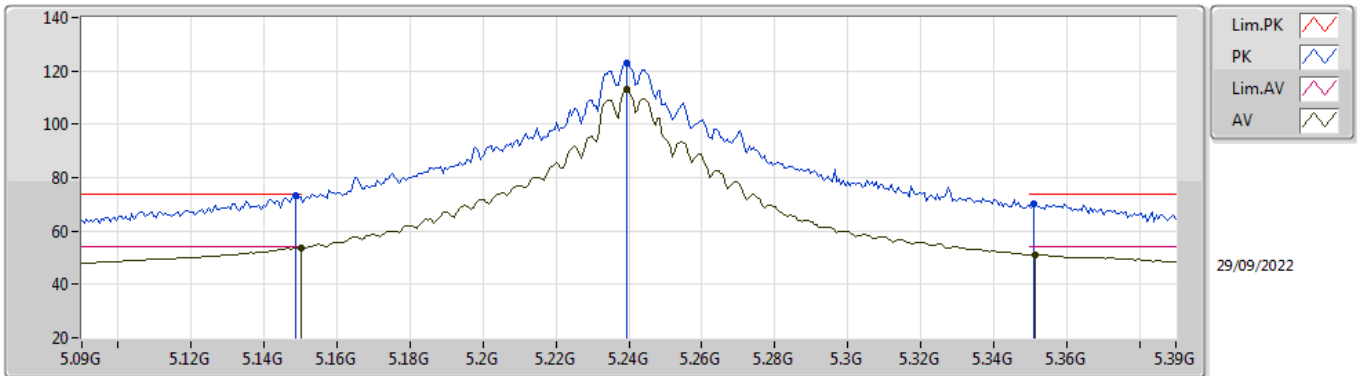

EUT_X_2TX
Setting 23
02-F-G-4-10

Type	Freq (Hz)	Level (dBuV/m)	Limit (dBuV/m)	Margin (dB)	Raw (dBuV)	Dist (m)	Condition	Azimuth (°)	Height (m)	Comment	AF (dB)	CL (dB)	PA (dB)
PK	5.1488G	73.38	74.00	-0.62	65.26	3	Horizontal	3	2.59	-	33.60	5.25	30.73
AV	5.15G	53.71	54.00	-0.29	45.59	3	Horizontal	3	2.59	-	33.60	5.25	30.73
PK	5.2394G	122.87	Inf	-Inf	114.58	3	Horizontal	3	2.59	-	33.70	5.32	30.73
AV	5.2394G	112.99	Inf	-Inf	104.70	3	Horizontal	3	2.59	-	33.70	5.32	30.73
PK	5.351G	69.97	74.00	-4.03	61.41	3	Horizontal	3	2.59	-	33.90	5.38	30.72
AV	5.3516G	51.08	54.00	-2.92	42.52	3	Horizontal	3	2.59	-	33.90	5.38	30.72

802.11a_Nss1,(6Mbps)_2TX

5240MHz_TnomVnom

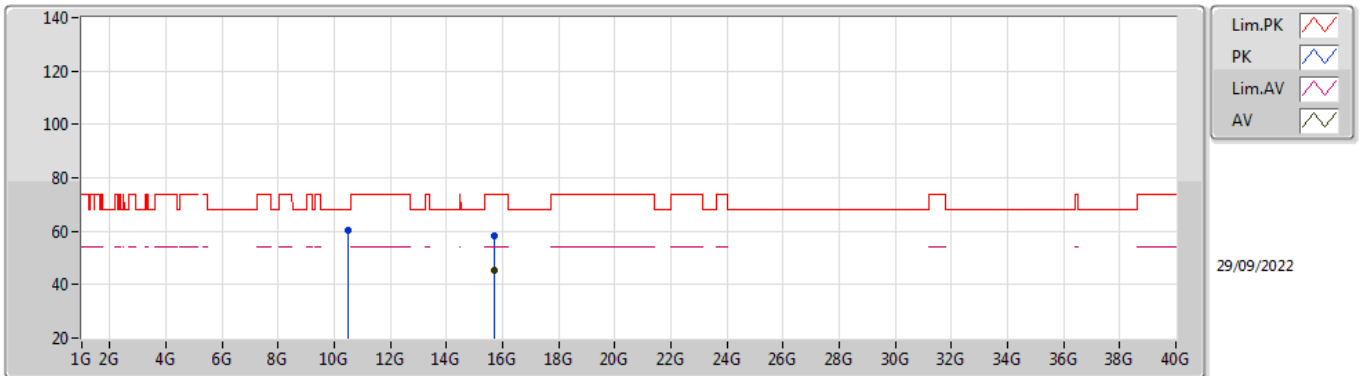

EUT X_2TX
Setting 23
02-F-G-4

Type	Freq (Hz)	Level (dBuV/m)	Limit (dBuV/m)	Margin (dB)	Raw (dBuV)	Dist (m)	Condition	Azimuth (°)	Height (m)	Comment	AF (dB)	CL (dB)	PA (dB)
PK	10.47994G	60.14	68.20	-8.06	45.90	3	Vertical	18	2.13	-	38.60	7.49	31.85
PK	15.72306G	58.33	74.00	-15.67	42.40	3	Vertical	348	1.80	-	37.50	9.88	31.45
AV	15.70812G	45.58	54.00	-8.42	29.65	3	Vertical	348	1.80	-	37.50	9.87	31.44

802.11a_Nss1,(6Mbps)_2TX

5240MHz_TnomVnom

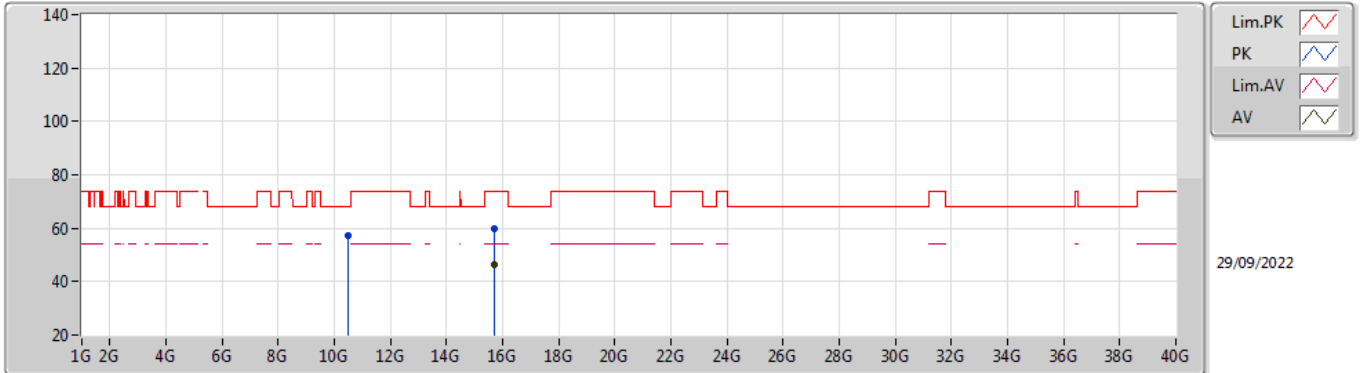

EUT X_2TX
Setting 23
02-F-G-4

Type	Freq (Hz)	Level (dBuV/m)	Limit (dBuV/m)	Margin (dB)	Raw (dBuV)	Dist (m)	Condition	Azimuth (°)	Height (m)	Comment	AF (dB)	CL (dB)	PA (dB)
PK	10.47976G	57.32	68.20	-10.88	43.08	3	Horizontal	262	1.70	-	38.60	7.49	31.85
PK	15.72294G	59.64	74.00	-14.36	43.71	3	Horizontal	305	1.93	-	37.50	9.88	31.45
AV	15.717G	46.40	54.00	-7.60	30.47	3	Horizontal	305	1.93	-	37.50	9.87	31.44

802.11a_Nss1,(6Mbps)_2TX

5745MHz_TnomVnom

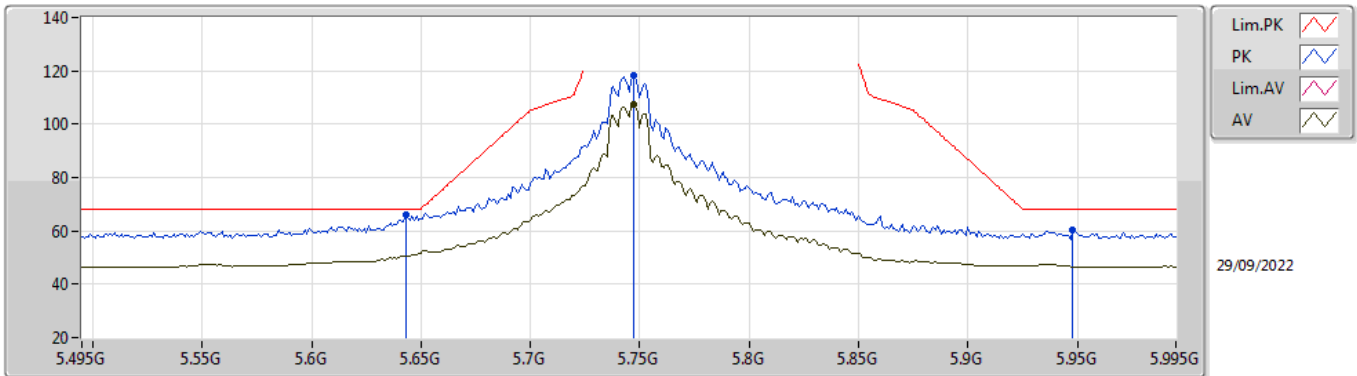

EUT_X_2TX
Setting 22.5
02-F-C-6-10

Type	Freq (Hz)	Level (dBuV/m)	Limit (dBuV/m)	Margin (dB)	Raw (dBuV)	Dist (m)	Condition	Azimuth (°)	Height (m)	Comment	AF (dB)	CL (dB)	PA (dB)
PK	5.643G	65.82	68.20	-2.38	57.24	3	Vertical	34	2.44	-	33.81	5.60	30.83
PK	5.747G	118.40	Inf	-Inf	109.90	3	Vertical	34	2.44	-	33.81	5.60	30.91
AV	5.747G	107.30	Inf	-Inf	98.80	3	Vertical	34	2.44	-	33.81	5.60	30.91
PK	5.948G	60.37	68.20	-7.83	51.48	3	Vertical	34	2.44	-	34.20	5.75	31.06

802.11a_Nss1,(6Mbps)_2TX

5745MHz_TnomVnom

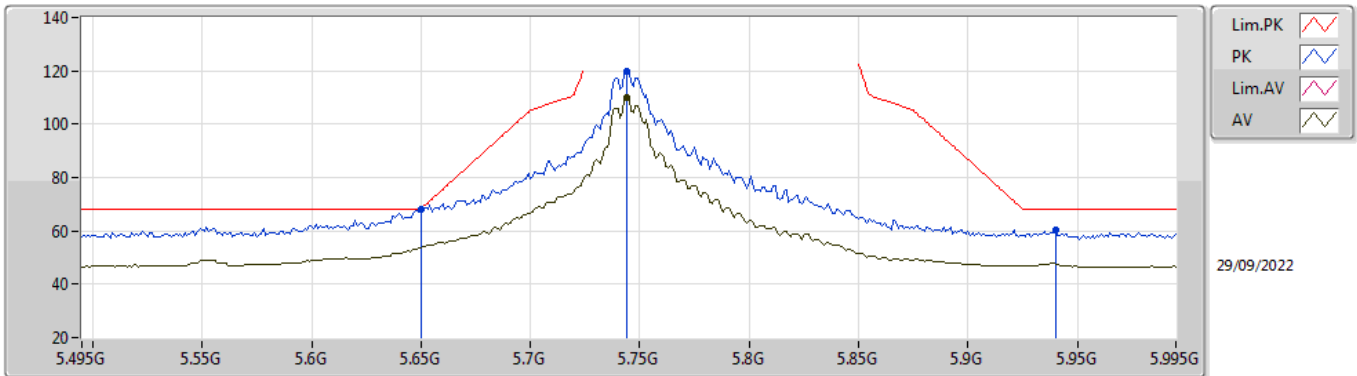

EUT_X_2TX
Setting 22.5
02-F-C-6-10

Type	Freq (Hz)	Level (dBuV/m)	Limit (dBuV/m)	Margin (dB)	Raw (dBuV)	Dist (m)	Condition	Azimuth (°)	Height (m)	Comment	AF (dB)	CL (dB)	PA (dB)
PK	5.65G	68.03	68.20	-0.17	59.46	3	Horizontal	8	1.80	-	33.80	5.60	30.83
PK	5.744G	119.87	Inf	-Inf	111.37	3	Horizontal	8	1.80	-	33.81	5.60	30.91
AV	5.744G	110.11	Inf	-Inf	101.61	3	Horizontal	8	1.80	-	33.81	5.60	30.91
PK	5.94G	60.17	68.20	-8.03	51.30	3	Horizontal	8	1.80	-	34.18	5.74	31.05

802.11a_Nss1,(6Mbps)_2TX

5745MHz_TnomVnom

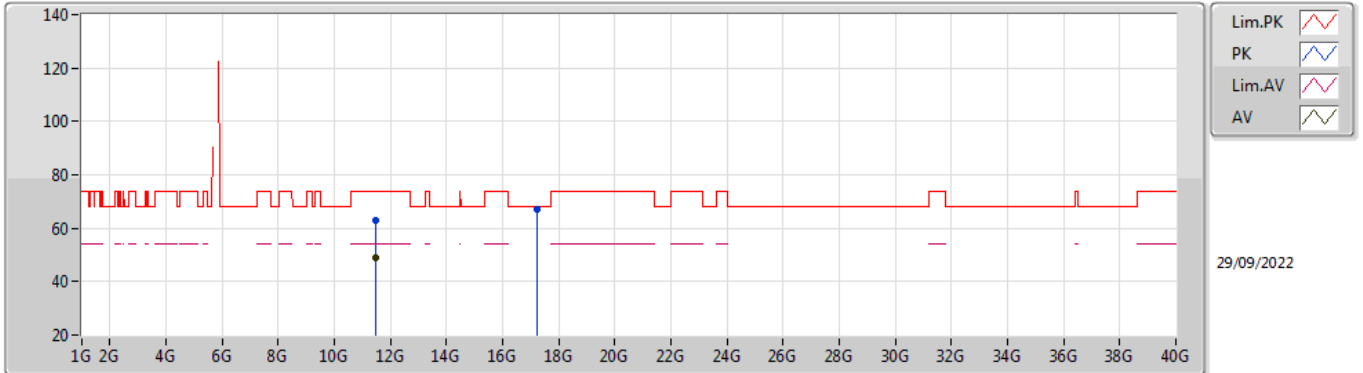

EUT X_2TX
Setting 22.5
02-F-C-6

Type	Freq (Hz)	Level (dBuV/m)	Limit (dBuV/m)	Margin (dB)	Raw (dBuV)	Dist (m)	Condition	Azimuth (°)	Height (m)	Comment	AF (dB)	CL (dB)	PA (dB)
PK	11.4912G	62.81	74.00	-11.19	48.05	3	Vertical	356	3.00	-	38.98	7.90	32.12
AV	11.49198G	48.87	54.00	-5.13	34.11	3	Vertical	356	3.00	-	38.98	7.90	32.12
PK	17.2338G	66.94	68.20	-1.26	44.39	3	Vertical	350	2.68	-	42.17	10.62	30.24

802.11a_Nss1,(6Mbps)_2TX

5745MHz_TnomVnom

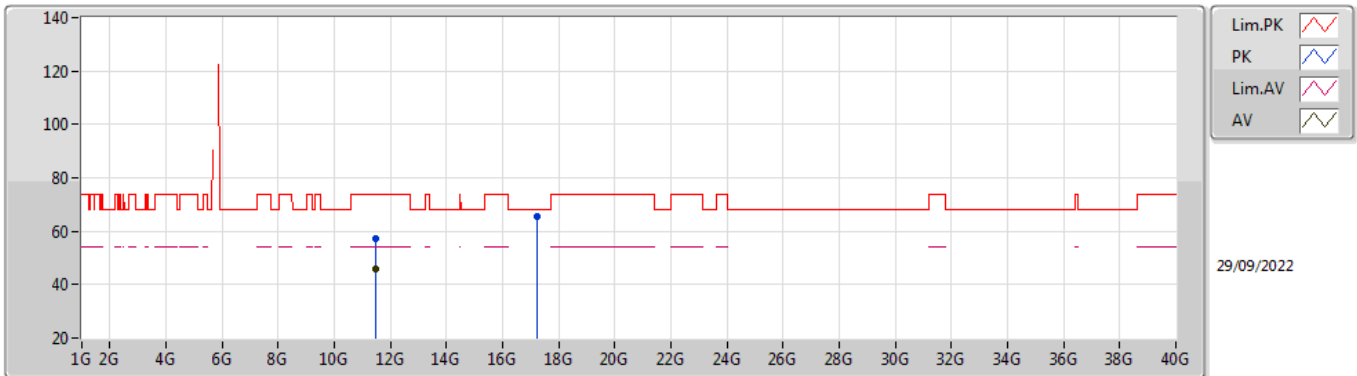

EUT X_2TX
Setting 22.5
02-F-C-6

Type	Freq (Hz)	Level (dBuV/m)	Limit (dBuV/m)	Margin (dB)	Raw (dBuV)	Dist (m)	Condition	Azimuth (°)	Height (m)	Comment	AF (dB)	CL (dB)	PA (dB)
PK	11.4885G	57.30	74.00	-16.70	42.54	3	Horizontal	93	1.64	-	38.98	7.90	32.12
AV	11.49G	45.91	54.00	-8.09	31.15	3	Horizontal	93	1.64	-	38.98	7.90	32.12
PK	17.2377G	65.46	68.20	-2.74	42.89	3	Horizontal	81	1.51	-	42.19	10.62	30.24

802.11a_Nss1,(6Mbps)_2TX

5785MHz_TnomVnom

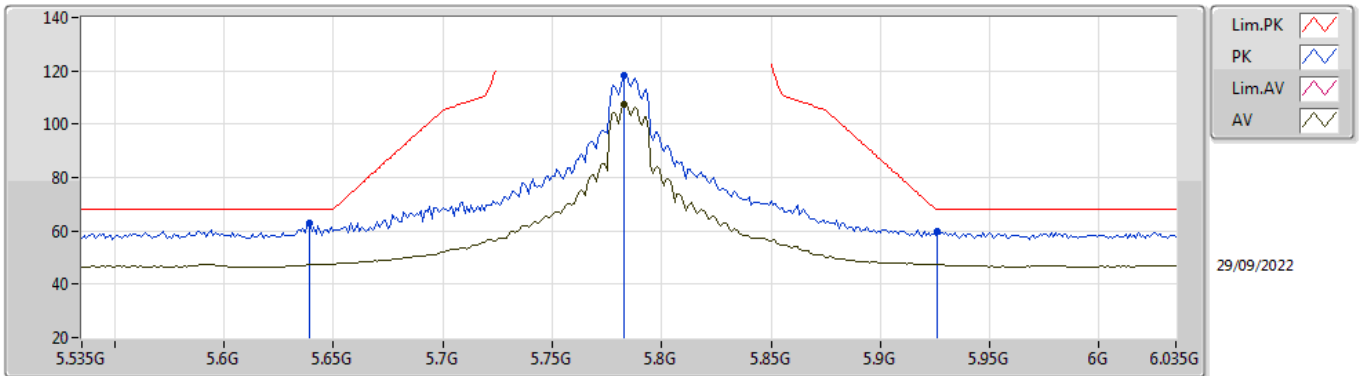

EUT_X_2TX
Setting 22
02-F-C-6-10

Type	Freq (Hz)	Level (dBuV/m)	Limit (dBuV/m)	Margin (dB)	Raw (dBuV)	Dist (m)	Condition	Azimuth (°)	Height (m)	Comment	AF (dB)	CL (dB)	PA (dB)
PK	5.639G	62.89	68.20	-5.31	54.30	3	Vertical	40	2.54	-	33.82	5.60	30.83
PK	5.783G	118.44	Inf	-Inf	109.98	3	Vertical	40	2.54	-	33.80	5.60	30.94
AV	5.783G	107.52	Inf	-Inf	99.06	3	Vertical	40	2.54	-	33.80	5.60	30.94
PK	5.926G	59.64	68.20	-8.56	50.80	3	Vertical	40	2.54	-	34.15	5.73	31.04

802.11a_Nss1,(6Mbps)_2TX

5785MHz_TnomVnom

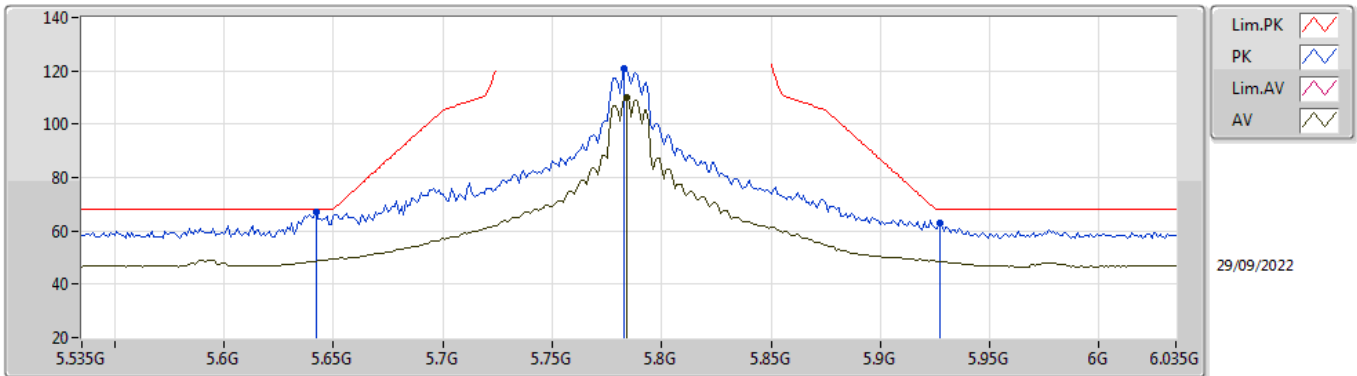

EUT_X_2TX
Setting 22
02-F-C-6-10

Type	Freq (Hz)	Level (dBuV/m)	Limit (dBuV/m)	Margin (dB)	Raw (dBuV)	Dist (m)	Condition	Azimuth (°)	Height (m)	Comment	AF (dB)	CL (dB)	PA (dB)
PK	5.642G	66.86	68.20	-1.34	58.27	3	Horizontal	7	1.30	-	33.82	5.60	30.83
PK	5.783G	120.66	Inf	-Inf	112.20	3	Horizontal	7	1.30	-	33.80	5.60	30.94
AV	5.784G	109.99	Inf	-Inf	101.53	3	Horizontal	7	1.30	-	33.80	5.60	30.94
PK	5.927G	62.74	68.20	-5.46	53.90	3	Horizontal	7	1.30	-	34.15	5.73	31.04

802.11a_Nss1,(6Mbps)_2TX

5785MHz_TnomVnom

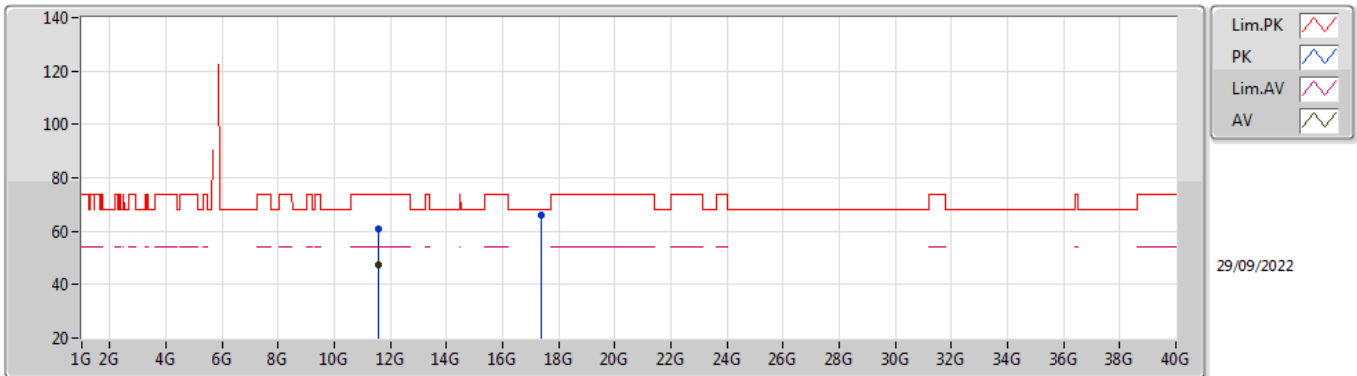

EUT X_2TX
Setting 22
02-F-C-6

Type	Freq (Hz)	Level (dBuV/m)	Limit (dBuV/m)	Margin (dB)	Raw (dBuV)	Dist (m)	Condition	Azimuth (°)	Height (m)	Comment	AF (dB)	CL (dB)	PA (dB)
PK	11.57162G	61.11	74.00	-12.89	46.13	3	Vertical	354	3.00	-	39.21	7.93	32.16
AV	11.57192G	47.42	54.00	-6.58	32.43	3	Vertical	354	3.00	-	39.22	7.93	32.16
PK	17.3568G	66.11	68.20	-2.09	42.81	3	Vertical	360	2.65	-	42.84	10.68	30.22

802.11a_Nss1,(6Mbps)_2TX

5785MHz_TnomVnom

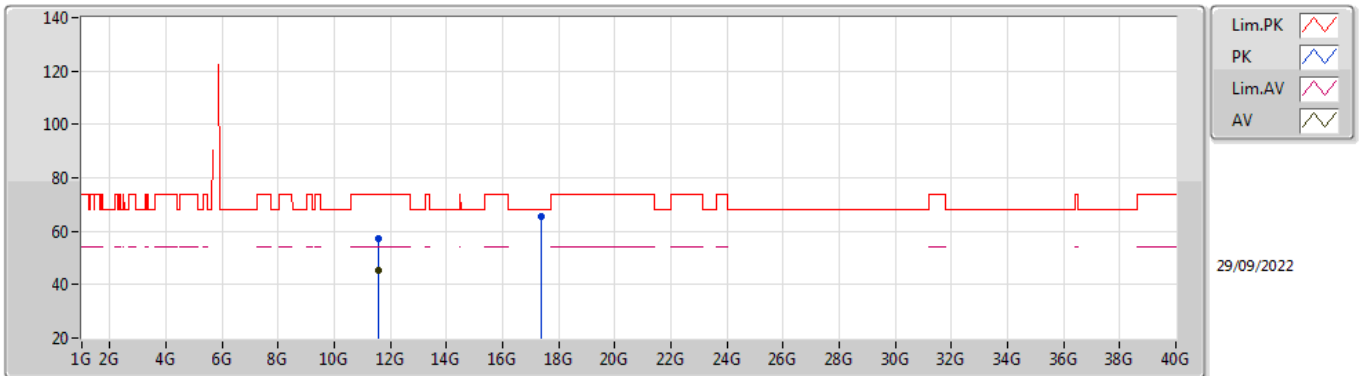

EUT X_2TX
Setting 22
02-F-C-6

Type	Freq (Hz)	Level (dBuV/m)	Limit (dBuV/m)	Margin (dB)	Raw (dBuV)	Dist (m)	Condition	Azimuth (°)	Height (m)	Comment	AF (dB)	CL (dB)	PA (dB)
PK	11.57024G	57.30	74.00	-16.70	42.32	3	Horizontal	85	1.53	-	39.21	7.93	32.16
AV	11.57G	45.57	54.00	-8.43	30.59	3	Horizontal	85	1.53	-	39.21	7.93	32.16
PK	17.36682G	65.74	68.20	-2.46	42.38	3	Horizontal	82	1.84	-	42.90	10.68	30.22

802.11a_Nss1,(6Mbps)_2TX

5825MHz_TnomVnom

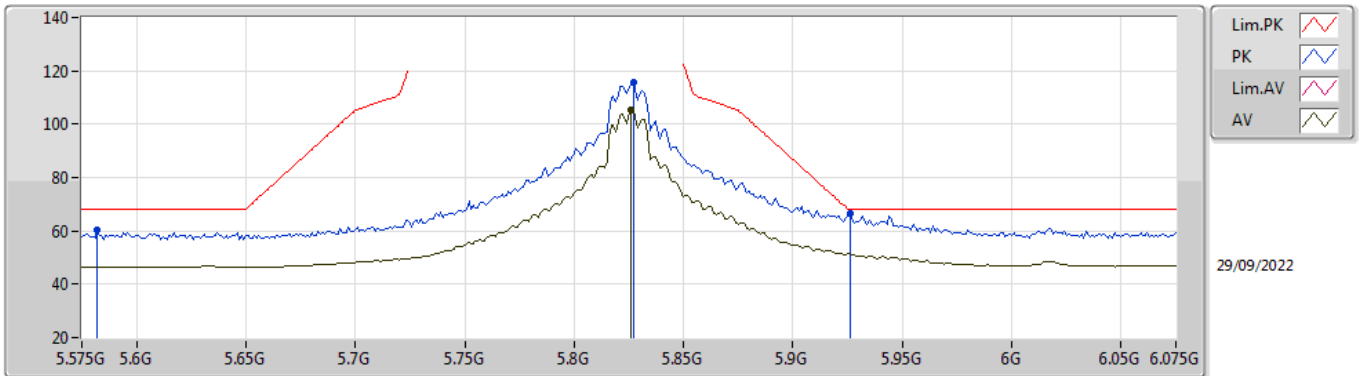

EUT_X_2TX
Setting 22.5
02-F-C-6-10

Type	Freq (Hz)	Level (dBuV/m)	Limit (dBuV/m)	Margin (dB)	Raw (dBuV)	Dist (m)	Condition	Azimuth (°)	Height (m)	Comment	AF (dB)	CL (dB)	PA (dB)
PK	5.582G	60.10	68.20	-8.10	51.36	3	Vertical	5	2.14	-	33.94	5.58	30.78
PK	5.827G	115.48	Inf	-Inf	107.02	3	Vertical	5	2.14	-	33.80	5.63	30.97
AV	5.826G	105.46	Inf	-Inf	97.00	3	Vertical	5	2.14	-	33.80	5.63	30.97
PK	5.926G	66.54	68.20	-1.66	57.70	3	Vertical	5	2.14	-	34.15	5.73	31.04

802.11a_Nss1,(6Mbps)_2TX

5825MHz_TnomVnom

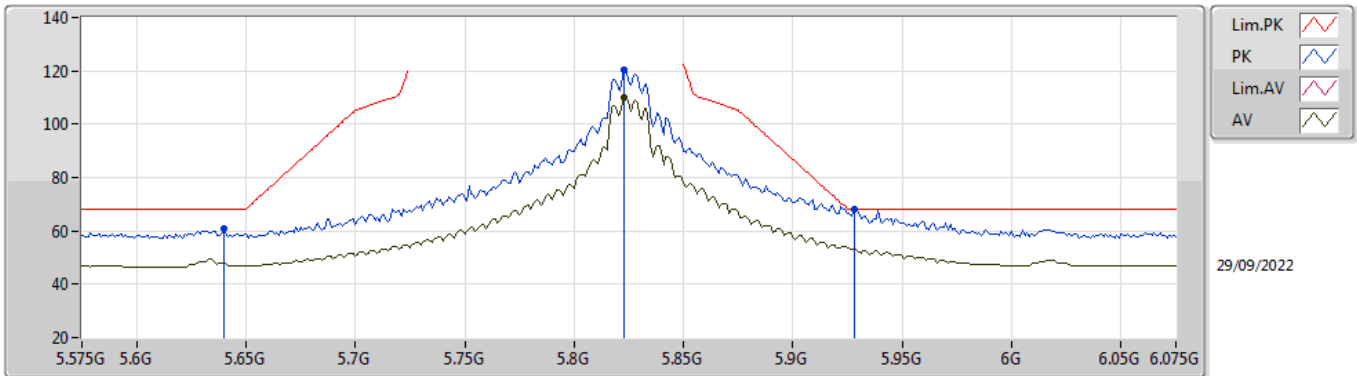

EUT_X_2TX
Setting 22.5
02-F-C-6-10

Type	Freq (Hz)	Level (dBuV/m)	Limit (dBuV/m)	Margin (dB)	Raw (dBuV)	Dist (m)	Condition	Azimuth (°)	Height (m)	Comment	AF (dB)	CL (dB)	PA (dB)
PK	5.64G	60.86	68.20	-7.34	52.27	3	Horizontal	7	1.05	-	33.82	5.60	30.83
PK	5.823G	120.41	Inf	-Inf	111.96	3	Horizontal	7	1.05	-	33.80	5.62	30.97
AV	5.823G	109.93	Inf	-Inf	101.48	3	Horizontal	7	1.05	-	33.80	5.62	30.97
PK	5.928G	68.16	68.20	-0.04	59.32	3	Horizontal	7	1.05	-	34.16	5.73	31.05

802.11a_Nss1,(6Mbps)_2TX

5825MHz_TnomVnom

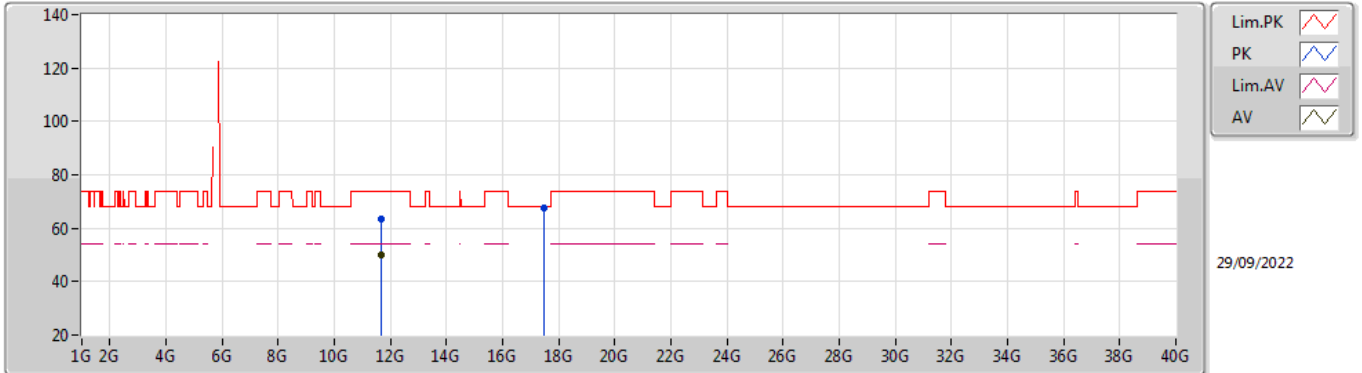

EUT X_2TX
Setting 22.5
02-F-C-6

Type	Freq (Hz)	Level (dBuV/m)	Limit (dBuV/m)	Margin (dB)	Raw (dBuV)	Dist (m)	Condition	Azimuth (°)	Height (m)	Comment	AF (dB)	CL (dB)	PA (dB)
PK	11.65294G	63.38	74.00	-10.62	48.22	3	Vertical	353	3.00	-	39.41	7.96	32.21
AV	11.65204G	49.75	54.00	-4.25	34.60	3	Vertical	353	3.00	-	39.40	7.96	32.21
PK	17.47596G	67.77	68.20	-0.43	43.53	3	Vertical	311	1.80	-	43.71	10.74	30.21

802.11a_Nss1,(6Mbps)_2TX

5825MHz_TnomVnom

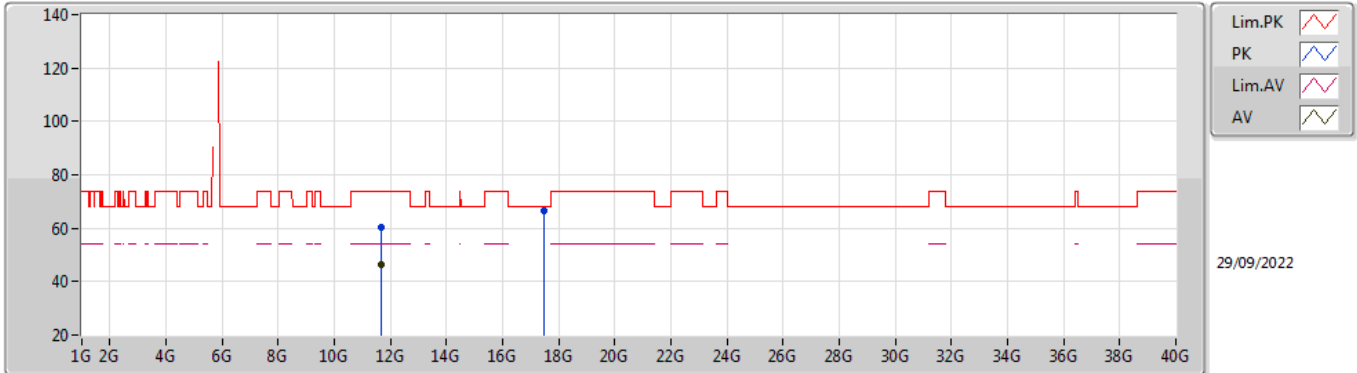

EUT X_2TX
Setting 22.5
02-F-C-6

Type	Freq (Hz)	Level (dBuV/m)	Limit (dBuV/m)	Margin (dB)	Raw (dBuV)	Dist (m)	Condition	Azimuth (°)	Height (m)	Comment	AF (dB)	CL (dB)	PA (dB)
PK	11.6518G	60.19	74.00	-13.81	45.04	3	Horizontal	109	1.68	-	39.40	7.96	32.21
AV	11.65198G	46.32	54.00	-7.68	31.17	3	Horizontal	109	1.68	-	39.40	7.96	32.21
PK	17.47152G	66.78	68.20	-1.42	42.58	3	Horizontal	348	1.80	-	43.67	10.74	30.21

802.11ax HEW20_Nss1,(MCS0)_2TX

5180MHz_TnomVnom

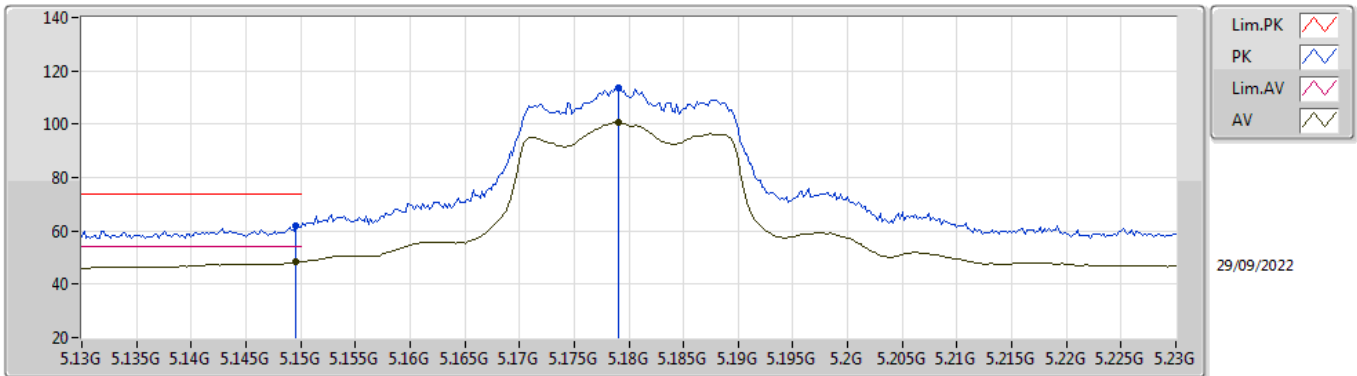

EUT X_2TX
Setting 18.5
02-F-C-6-10

Type	Freq (Hz)	Level (dBuV/m)	Limit (dBuV/m)	Margin (dB)	Raw (dBuV)	Dist (m)	Condition	Azimuth (°)	Height (m)	Comment	AF (dB)	CL (dB)	PA (dB)
PK	5.1496G	61.66	74.00	-12.34	53.54	3	Vertical	0	2.54	-	33.60	5.25	30.73
AV	5.1496G	48.24	54.00	-5.76	40.12	3	Vertical	0	2.54	-	33.60	5.25	30.73
PK	5.179G	113.71	Inf	-Inf	105.50	3	Vertical	0	2.54	-	33.66	5.28	30.73
AV	5.179G	100.72	Inf	-Inf	92.51	3	Vertical	0	2.54	-	33.66	5.28	30.73

802.11ax HEW20_Nss1,(MCS0)_2TX

5180MHz_TnomVnom

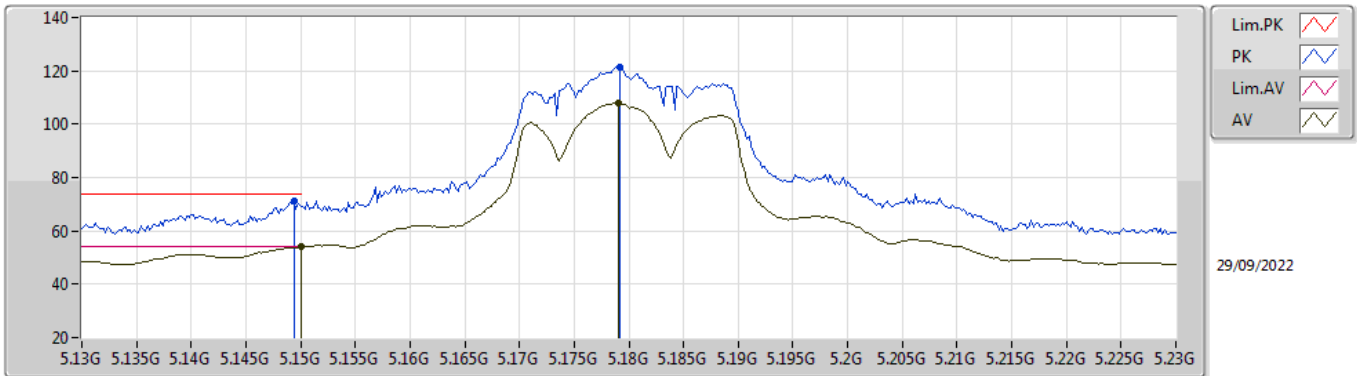

EUT_X_2TX
Setting 18.5
02-F-C-6-10

Type	Freq (Hz)	Level (dBuV/m)	Limit (dBuV/m)	Margin (dB)	Raw (dBuV)	Dist (m)	Condition	Azimuth (°)	Height (m)	Comment	AF (dB)	CL (dB)	PA (dB)
PK	5.1494G	71.25	74.00	-2.75	63.13	3	Horizontal	0	2.65	-	33.60	5.25	30.73
AV	5.15G	53.88	54.00	-0.12	45.76	3	Horizontal	0	2.65	-	33.60	5.25	30.73
PK	5.1792G	121.25	Inf	-Inf	113.04	3	Horizontal	0	2.65	-	33.66	5.28	30.73
AV	5.179G	107.93	Inf	-Inf	99.72	3	Horizontal	0	2.65	-	33.66	5.28	30.73

802.11ax HEW20_Nss1,(MCS0)_2TX

5180MHz_TnomVnom

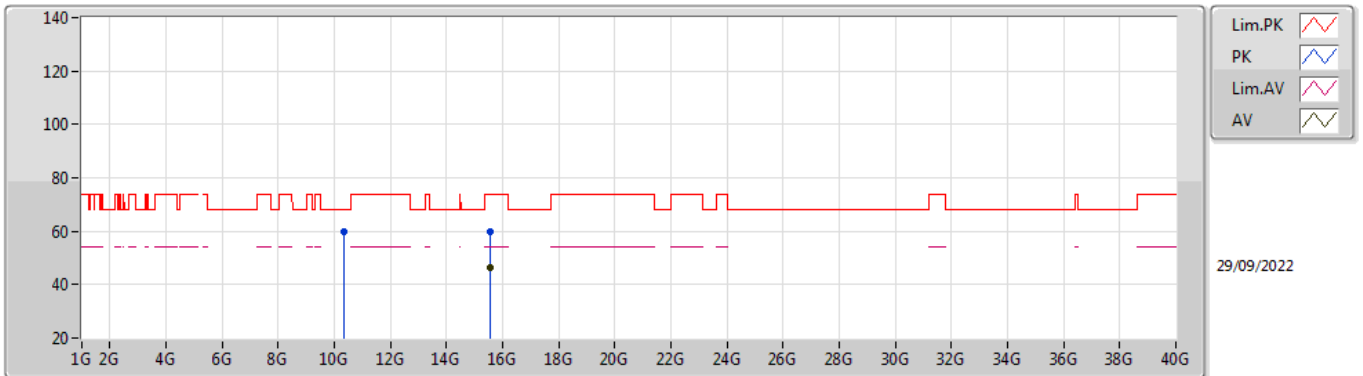

EUT X_2TX
Setting 18.5
02-F-C-6

Type	Freq (Hz)	Level (dBuV/m)	Limit (dBuV/m)	Margin (dB)	Raw (dBuV)	Dist (m)	Condition	Azimuth (°)	Height (m)	Comment	AF (dB)	CL (dB)	PA (dB)
PK	10.36G	59.92	68.20	-8.28	45.67	3	Vertical	19	2.06	-	38.64	7.44	31.83
PK	15.5352G	59.92	74.00	-14.08	43.59	3	Vertical	323	2.66	-	37.89	9.79	31.35
AV	15.5346G	46.21	54.00	-7.79	29.88	3	Vertical	323	2.66	-	37.89	9.79	31.35

802.11ax HEW20_Nss1,(MCS0)_2TX

5180MHz_TnomVnom

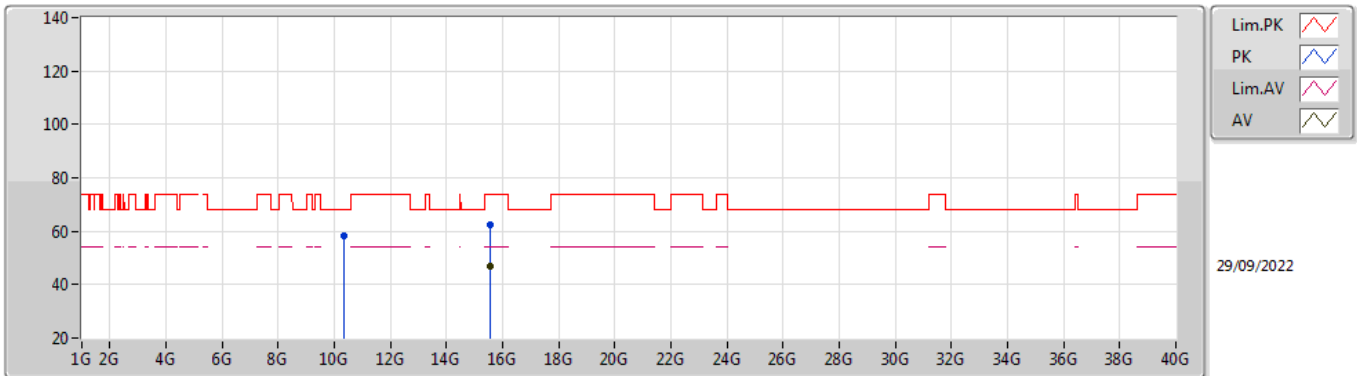

EUT X_2TX
Setting 18.5
02-F-C-6

Type	Freq (Hz)	Level (dBuV/m)	Limit (dBuV/m)	Margin (dB)	Raw (dBuV)	Dist (m)	Condition	Azimuth (°)	Height (m)	Comment	AF (dB)	CL (dB)	PA (dB)
PK	10.36006G	58.02	68.20	-10.18	43.77	3	Horizontal	262	1.70	-	38.64	7.44	31.83
PK	15.53616G	62.26	74.00	-11.74	45.94	3	Horizontal	60	1.80	-	37.88	9.79	31.35
AV	15.53448G	47.03	54.00	-6.97	30.70	3	Horizontal	60	1.80	-	37.89	9.79	31.35

802.11ax HEW20_Nss1,(MCS0)_2TX

5200MHz_TnomVnom

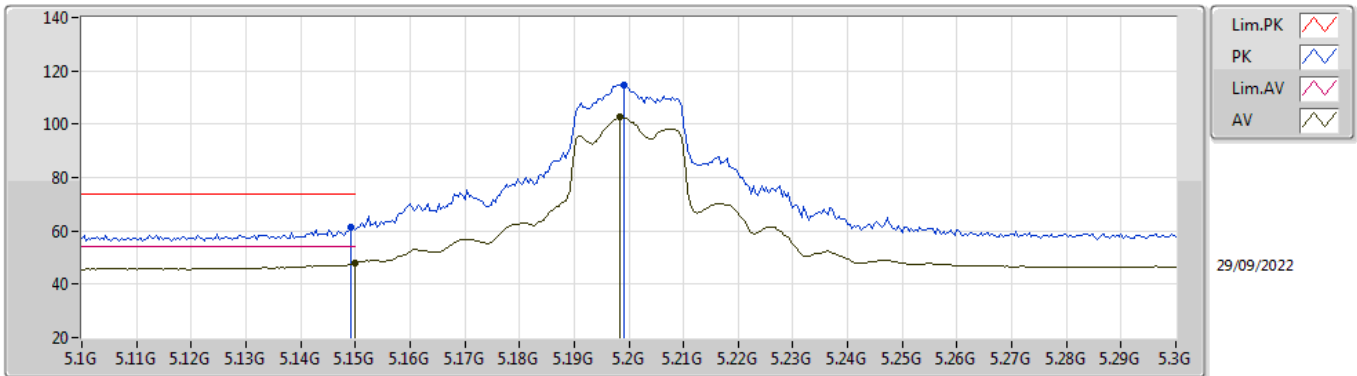

EUT_X_2TX
Setting 20.5
02-F-C-6-10

Type	Freq (Hz)	Level (dBuV/m)	Limit (dBuV/m)	Margin (dB)	Raw (dBuV)	Dist (m)	Condition	Azimuth (°)	Height (m)	Comment	AF (dB)	CL (dB)	PA (dB)
PK	5.1492G	61.59	74.00	-12.41	53.47	3	Vertical	0	2.54	-	33.60	5.25	30.73
AV	5.15G	47.97	54.00	-6.03	39.85	3	Vertical	0	2.54	-	33.60	5.25	30.73
PK	5.1992G	114.80	Inf	-Inf	106.53	3	Vertical	0	2.54	-	33.70	5.30	30.73
AV	5.1984G	102.54	Inf	-Inf	94.27	3	Vertical	0	2.54	-	33.70	5.30	30.73

802.11ax HEW20_Nss1,(MCS0)_2TX

5200MHz_TnomVnom

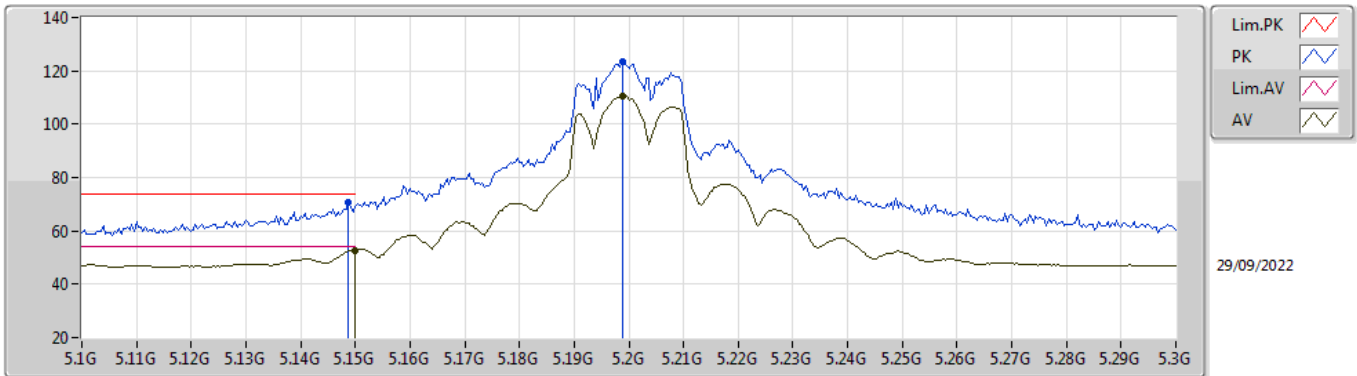

EUT X_2TX
Setting 20.5
02-F-C-6-10

Type	Freq (Hz)	Level (dBuV/m)	Limit (dBuV/m)	Margin (dB)	Raw (dBuV)	Dist (m)	Condition	Azimuth (°)	Height (m)	Comment	AF (dB)	CL (dB)	PA (dB)
PK	5.1488G	70.73	74.00	-3.27	62.61	3	Horizontal	0	2.62	-	33.60	5.25	30.73
AV	5.15G	52.76	54.00	-1.24	44.64	3	Horizontal	0	2.62	-	33.60	5.25	30.73
PK	5.1988G	123.65	Inf	-Inf	115.38	3	Horizontal	0	2.62	-	33.70	5.30	30.73
AV	5.1988G	110.67	Inf	-Inf	102.40	3	Horizontal	0	2.62	-	33.70	5.30	30.73

802.11ax HEW20_Nss1,(MCS0)_2TX

5200MHz_TnomVnom

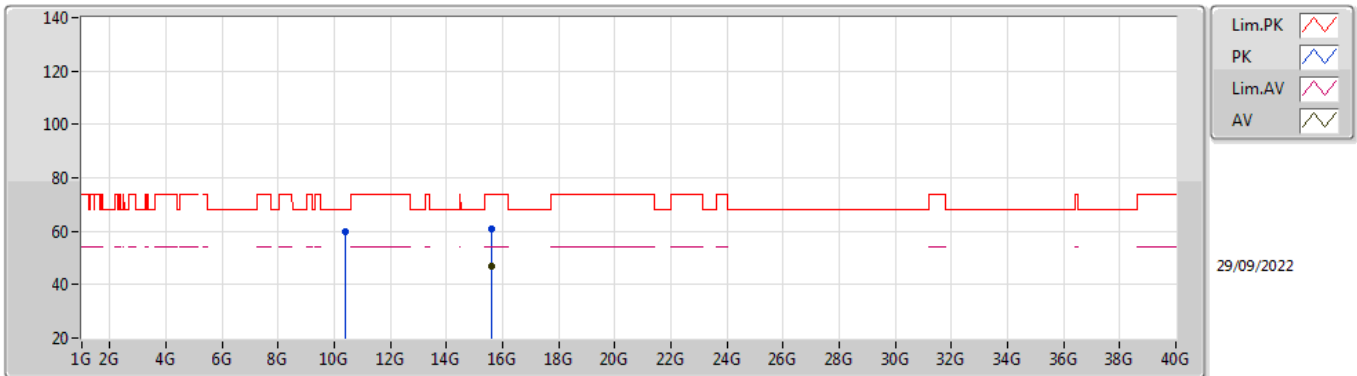

EUT X_2TX
Setting 20.5
02-F-C-6

Type	Freq (Hz)	Level (dBuV/m)	Limit (dBuV/m)	Margin (dB)	Raw (dBuV)	Dist (m)	Condition	Azimuth (°)	Height (m)	Comment	AF (dB)	CL (dB)	PA (dB)
PK	10.39988G	59.81	68.20	-8.39	45.58	3	Vertical	19	2.15	-	38.60	7.46	31.83
PK	15.60564G	60.96	74.00	-13.04	45.02	3	Vertical	349	2.76	-	37.50	9.82	31.38
AV	15.60426G	46.78	54.00	-7.22	30.84	3	Vertical	349	2.76	-	37.50	9.82	31.38

802.11ax HEW20_Nss1,(MCS0)_2TX

5200MHz_TnomVnom

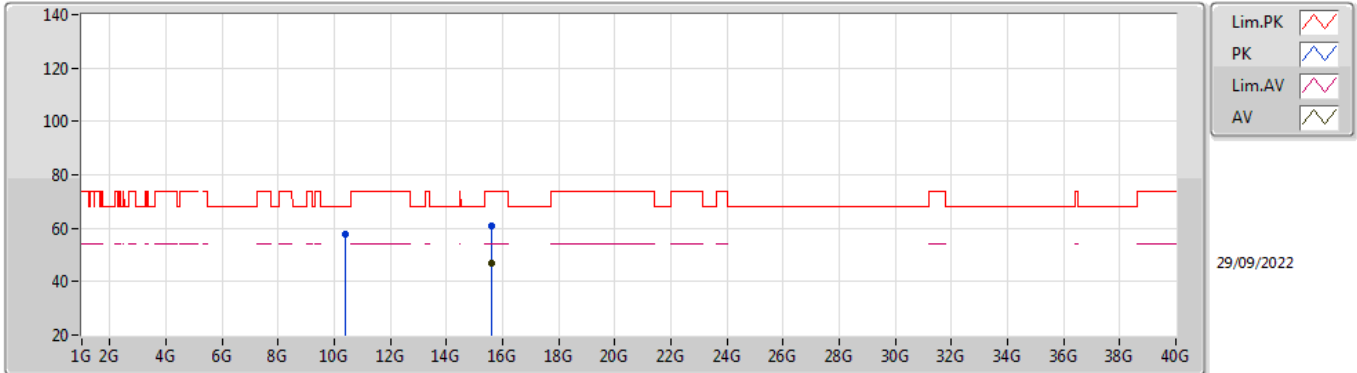

EUT X_2TX
Setting 20.5
02-F-C-6

Type	Freq (Hz)	Level (dBuV/m)	Limit (dBuV/m)	Margin (dB)	Raw (dBuV)	Dist (m)	Condition	Azimuth (°)	Height (m)	Comment	AF (dB)	CL (dB)	PA (dB)
PK	10.4G	57.84	68.20	-10.36	43.61	3	Horizontal	261	1.61	-	38.60	7.46	31.83
PK	15.60252G	60.80	74.00	-13.20	44.86	3	Horizontal	56	1.71	-	37.50	9.82	31.38
AV	15.60294G	46.97	54.00	-7.03	31.03	3	Horizontal	56	1.71	-	37.50	9.82	31.38

802.11ax HEW20_Nss1,(MCS0)_2TX

5240MHz_TnomVnom

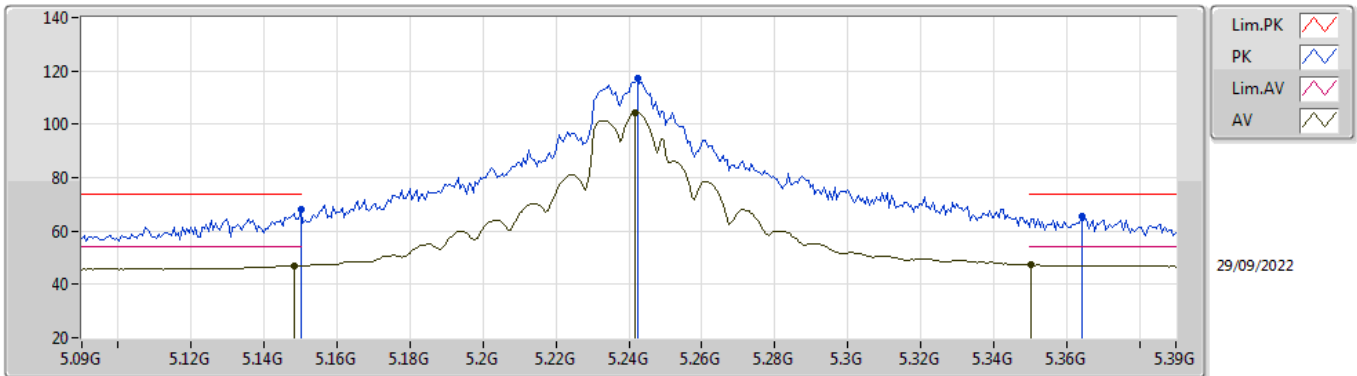

EUT_X_2TX
Setting 22.5
02-F-C-6-10

Type	Freq (Hz)	Level (dBuV/m)	Limit (dBuV/m)	Margin (dB)	Raw (dBuV)	Dist (m)	Condition	Azimuth (°)	Height (m)	Comment	AF (dB)	CL (dB)	PA (dB)
PK	5.15G	67.86	74.00	-6.14	59.74	3	Vertical	336	1.80	-	33.60	5.25	30.73
AV	5.1482G	46.97	54.00	-7.03	38.85	3	Vertical	336	1.80	-	33.60	5.25	30.73
PK	5.2424G	117.15	Inf	-Inf	108.86	3	Vertical	336	1.80	-	33.70	5.32	30.73
AV	5.2418G	104.51	Inf	-Inf	96.22	3	Vertical	336	1.80	-	33.70	5.32	30.73
PK	5.3642G	65.39	74.00	-8.61	56.80	3	Vertical	336	1.80	-	33.93	5.38	30.72
AV	5.3504G	47.25	54.00	-6.75	38.69	3	Vertical	336	1.80	-	33.90	5.38	30.72

802.11ax HEW20_Nss1,(MCS0)_2TX

5240MHz_TnomVnom

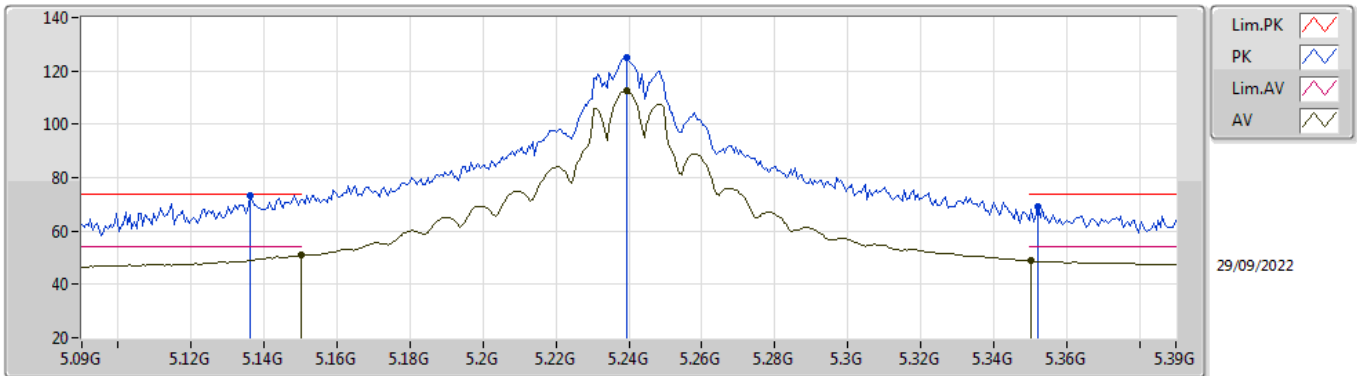

EUT_X_2TX
Setting 22.5
02-F-C-6-10

Type	Freq (Hz)	Level (dBuV/m)	Limit (dBuV/m)	Margin (dB)	Raw (dBuV)	Dist (m)	Condition	Azimuth (°)	Height (m)	Comment	AF (dB)	CL (dB)	PA (dB)
PK	5.1362G	73.26	74.00	-0.74	65.18	3	Horizontal	3	2.59	-	33.57	5.24	30.73
AV	5.15G	50.90	54.00	-3.10	42.78	3	Horizontal	3	2.59	-	33.60	5.25	30.73
PK	5.2394G	124.92	Inf	-Inf	116.63	3	Horizontal	3	2.59	-	33.70	5.32	30.73
AV	5.2394G	112.66	Inf	-Inf	104.37	3	Horizontal	3	2.59	-	33.70	5.32	30.73
PK	5.3522G	69.18	74.00	-4.82	60.62	3	Horizontal	3	2.59	-	33.90	5.38	30.72
AV	5.3504G	48.78	54.00	-5.22	40.22	3	Horizontal	3	2.59	-	33.90	5.38	30.72

802.11ax HEW20_Nss1,(MCS0)_2TX

5240MHz_TnomVnom

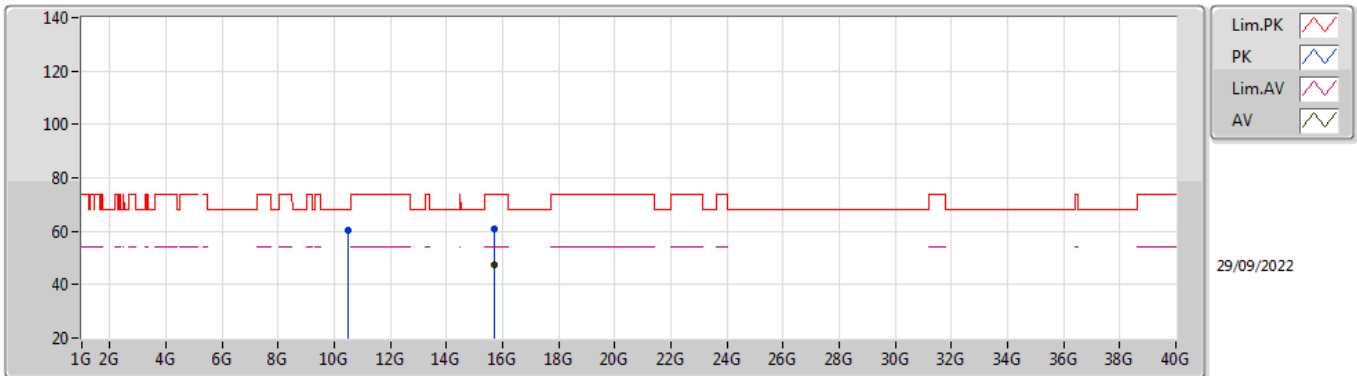

EUT X_2TX
Setting 22.5
02-F-C-6

Type	Freq (Hz)	Level (dBuV/m)	Limit (dBuV/m)	Margin (dB)	Raw (dBuV)	Dist (m)	Condition	Azimuth (°)	Height (m)	Comment	AF (dB)	CL (dB)	PA (dB)
PK	10.48G	60.38	68.20	-7.82	46.14	3	Vertical	15	2.12	-	38.60	7.49	31.85
PK	15.72438G	60.71	74.00	-13.29	44.78	3	Vertical	348	2.85	-	37.50	9.88	31.45
AV	15.71454G	47.63	54.00	-6.37	31.70	3	Vertical	348	2.85	-	37.50	9.87	31.44

802.11ax HEW20_Nss1,(MCS0)_2TX

5240MHz_TnomVnom

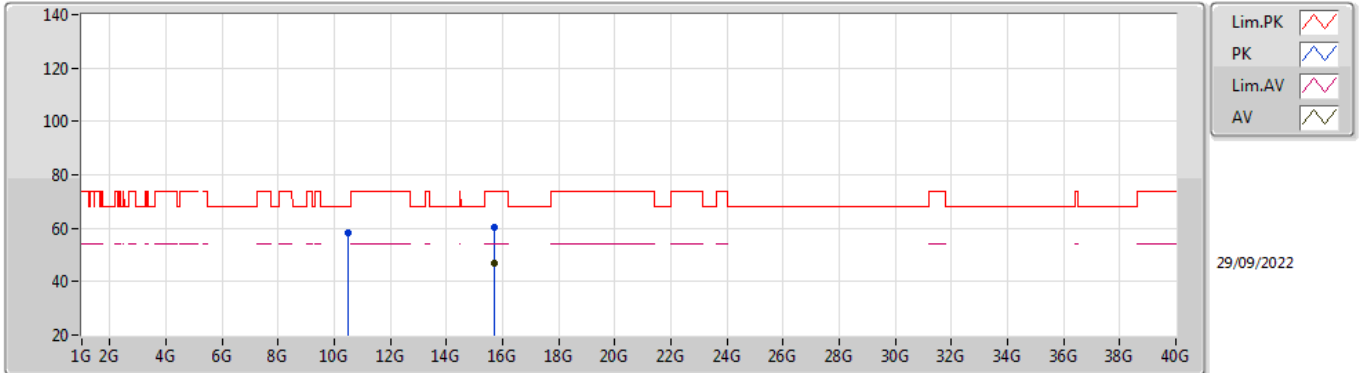

EUT X_2TX
Setting 22.5
02-F-C-6

Type	Freq (Hz)	Level (dBuV/m)	Limit (dBuV/m)	Margin (dB)	Raw (dBuV)	Dist (m)	Condition	Azimuth (°)	Height (m)	Comment	AF (dB)	CL (dB)	PA (dB)
PK	10.47994G	58.10	68.20	-10.10	43.86	3	Horizontal	263	1.70	-	38.60	7.49	31.85
PK	15.71484G	60.51	74.00	-13.49	44.58	3	Horizontal	304	1.92	-	37.50	9.87	31.44
AV	15.71508G	46.93	54.00	-7.07	31.00	3	Horizontal	304	1.92	-	37.50	9.87	31.44

802.11ax HEW20_Nss1,(MCS0)_2TX

5745MHz_TnomVnom

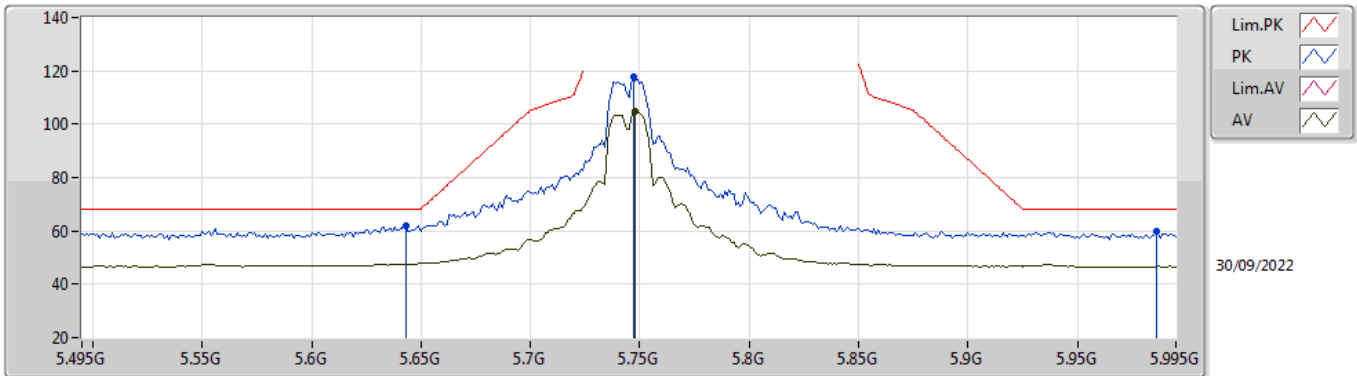

EUT_X_2TX
Setting 21
02-F-G-4-10

Type	Freq (Hz)	Level (dBuV/m)	Limit (dBuV/m)	Margin (dB)	Raw (dBuV)	Dist (m)	Condition	Azimuth (°)	Height (m)	Comment	AF (dB)	CL (dB)	PA (dB)
PK	5.643G	62.08	68.20	-6.12	53.50	3	Vertical	33	2.43	-	33.81	5.60	30.83
PK	5.747G	117.87	Inf	-Inf	109.37	3	Vertical	33	2.43	-	33.81	5.60	30.91
AV	5.748G	104.96	Inf	-Inf	96.47	3	Vertical	33	2.43	-	33.80	5.60	30.91
PK	5.986G	59.60	68.20	-8.60	50.70	3	Vertical	33	2.43	-	34.20	5.79	31.09

802.11ax HEW20_Nss1,(MCS0)_2TX

5745MHz_TnomVnom

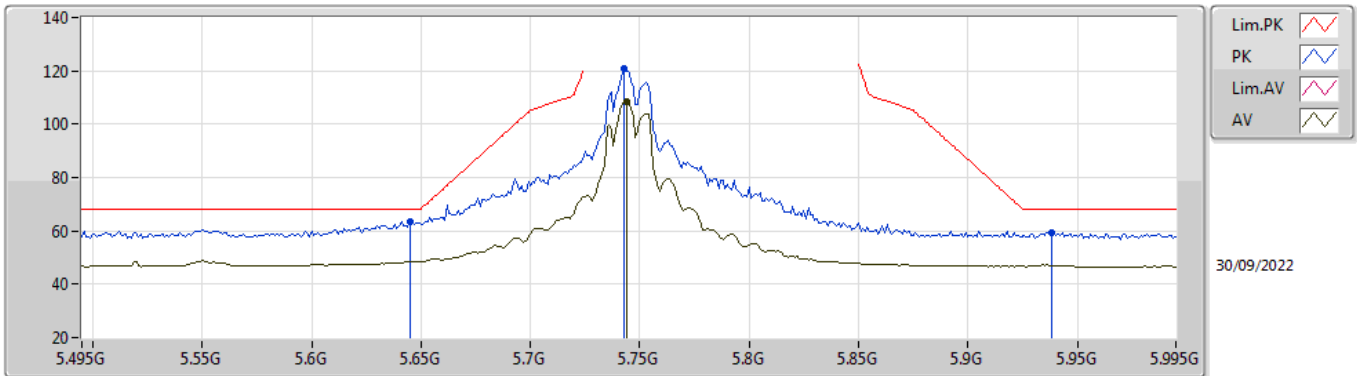

EUT_X_2TX
Setting 21
02-F-G-4-10

Type	Freq (Hz)	Level (dBuV/m)	Limit (dBuV/m)	Margin (dB)	Raw (dBuV)	Dist (m)	Condition	Azimuth (°)	Height (m)	Comment	AF (dB)	CL (dB)	PA (dB)
PK	5.645G	63.49	68.20	-4.71	54.91	3	Horizontal	8	1.80	-	33.81	5.60	30.83
PK	5.743G	120.64	Inf	-Inf	112.13	3	Horizontal	8	1.80	-	33.81	5.60	30.90
AV	5.744G	108.51	Inf	-Inf	100.01	3	Horizontal	8	1.80	-	33.81	5.60	30.91
PK	5.938G	59.56	68.20	-8.64	50.69	3	Horizontal	8	1.80	-	34.18	5.74	31.05

802.11ax HEW20_Nss1,(MCS0)_2TX

5745MHz_TnomVnom

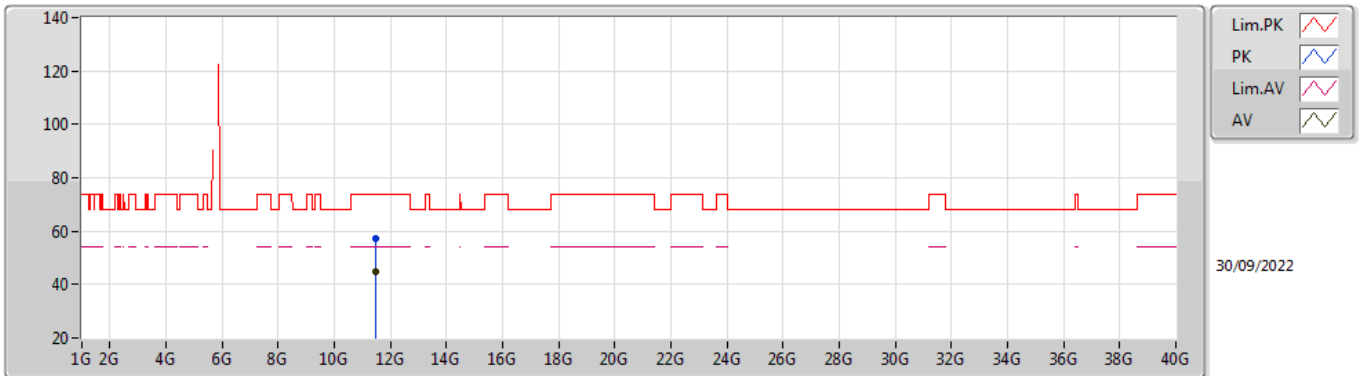

EUT_X_2TX
Setting 21
02-F-G-4

Type	Freq (Hz)	Level (dBuV/m)	Limit (dBuV/m)	Margin (dB)	Raw (dBuV)	Dist (m)	Condition	Azimuth (°)	Height (m)	Comment	AF (dB)	CL (dB)	PA (dB)
PK	11.4933G	57.29	74.00	-16.71	42.52	3	Vertical	47	1.83	-	38.99	7.90	32.12
AV	11.48994G	44.87	54.00	-9.13	30.11	3	Vertical	47	1.83	-	38.98	7.90	32.12

802.11ax HEW20_Nss1,(MCS0)_2TX

5745MHz_TnomVnom

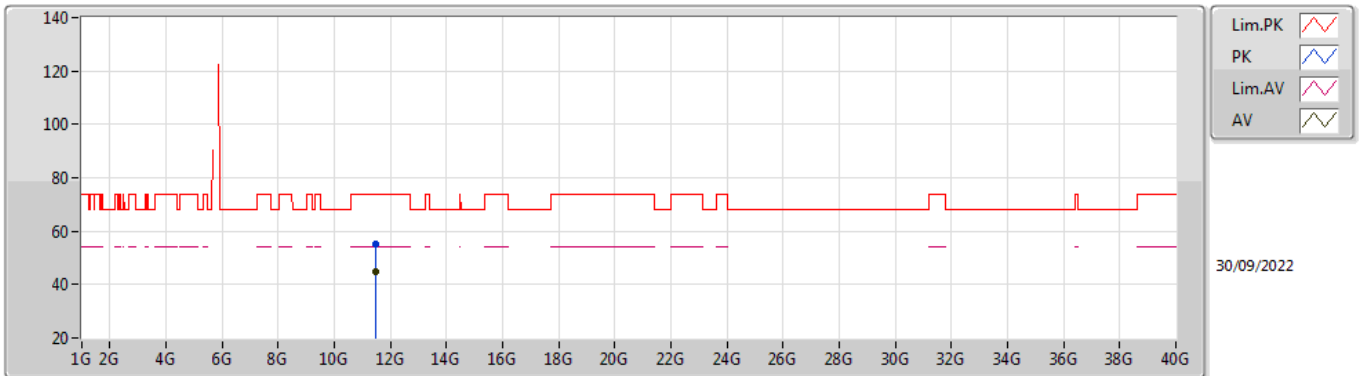

EUT_X_2TX
Setting 21
02-F-G-4

Type	Freq (Hz)	Level (dBuV/m)	Limit (dBuV/m)	Margin (dB)	Raw (dBuV)	Dist (m)	Condition	Azimuth (°)	Height (m)	Comment	AF (dB)	CL (dB)	PA (dB)
PK	11.48994G	55.15	74.00	-18.85	40.39	3	Horizontal	96	1.64	-	38.98	7.90	32.12
AV	11.49G	44.67	54.00	-9.33	29.91	3	Horizontal	96	1.64	-	38.98	7.90	32.12

802.11ax HEW20_Nss1,(MCS0)_2TX

5785MHz_TnomVnom

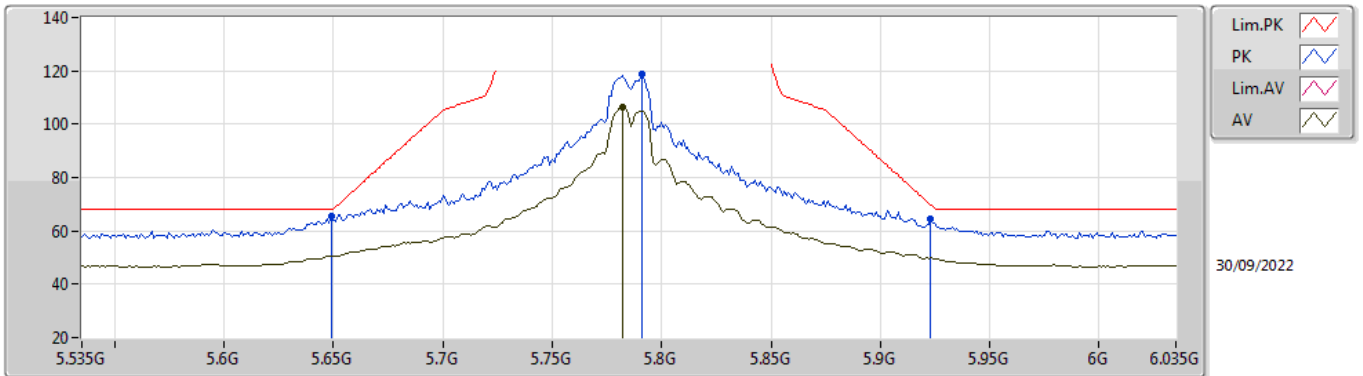

EUT_X_2TX
Setting 24
02-F-G-4-10

Type	Freq (Hz)	Level (dBuV/m)	Limit (dBuV/m)	Margin (dB)	Raw (dBuV)	Dist (m)	Condition	Azimuth (°)	Height (m)	Comment	AF (dB)	CL (dB)	PA (dB)
PK	5.649G	65.74	68.20	-2.46	57.17	3	Vertical	39	2.54	-	33.80	5.60	30.83
PK	5.791G	118.77	Inf	-Inf	110.31	3	Vertical	39	2.54	-	33.80	5.60	30.94
AV	5.782G	106.56	Inf	-Inf	98.09	3	Vertical	39	2.54	-	33.80	5.60	30.93
PK	5.923G	64.34	69.68	-5.34	55.51	3	Vertical	39	2.54	-	34.15	5.72	31.04

802.11ax HEW20_Nss1,(MCS0)_2TX

5785MHz_TnomVnom

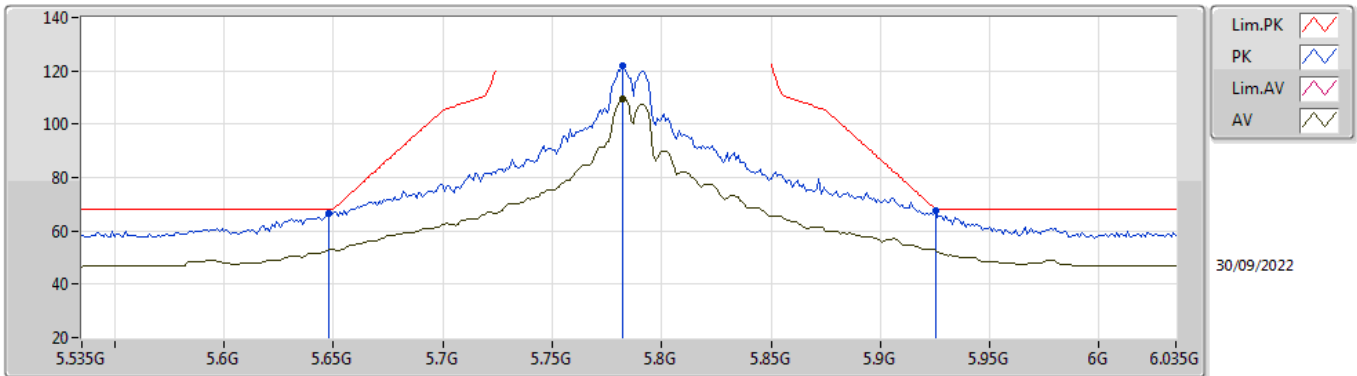

EUT_X_2TX
Setting 24
02-F-G-4-10

Type	Freq (Hz)	Level (dBuV/m)	Limit (dBuV/m)	Margin (dB)	Raw (dBuV)	Dist (m)	Condition	Azimuth (°)	Height (m)	Comment	AF (dB)	CL (dB)	PA (dB)
PK	5.648G	66.81	68.20	-1.39	58.24	3	Horizontal	9	1.08	-	33.80	5.60	30.83
PK	5.782G	121.67	Inf	-Inf	113.20	3	Horizontal	9	1.08	-	33.80	5.60	30.93
AV	5.782G	109.44	Inf	-Inf	100.97	3	Horizontal	9	1.08	-	33.80	5.60	30.93
PK	5.925G	67.72	68.20	-0.48	58.88	3	Horizontal	9	1.08	-	34.15	5.73	31.04

802.11ax HEW20_Nss1,(MCS0)_2TX

5785MHz_TnomVnom

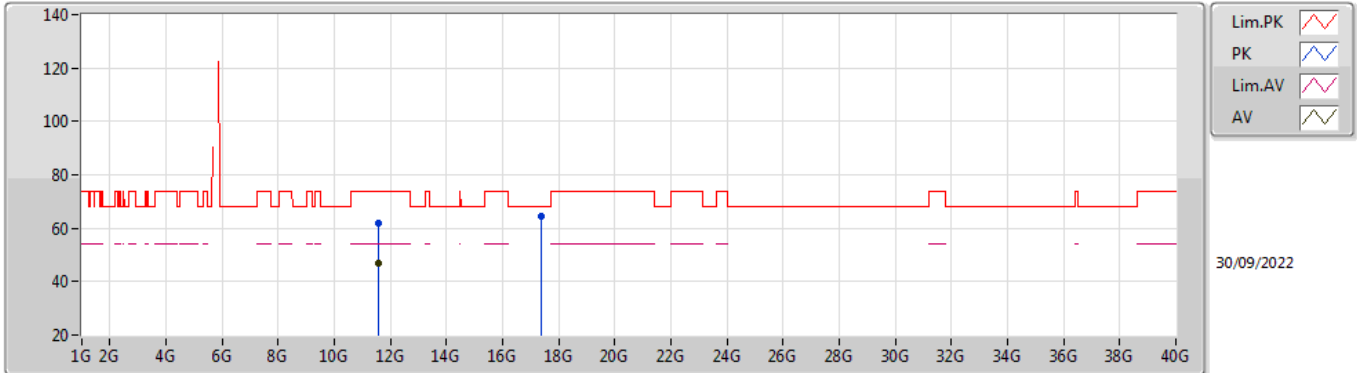

EUT X_2TX
Setting 24
02-F-G-4

Type	Freq (Hz)	Level (dBuV/m)	Limit (dBuV/m)	Margin (dB)	Raw (dBuV)	Dist (m)	Condition	Azimuth (°)	Height (m)	Comment	AF (dB)	CL (dB)	PA (dB)
PK	11.5733G	61.93	74.00	-12.07	46.94	3	Vertical	353	1.83	-	39.22	7.93	32.16
AV	11.57294G	46.88	54.00	-7.12	31.89	3	Vertical	353	1.83	-	39.22	7.93	32.16
PK	17.35296G	64.25	68.20	-3.95	40.97	3	Vertical	256	1.37	-	42.82	10.68	30.22

802.11ax HEW20_Nss1,(MCS0)_2TX

5785MHz_TnomVnom

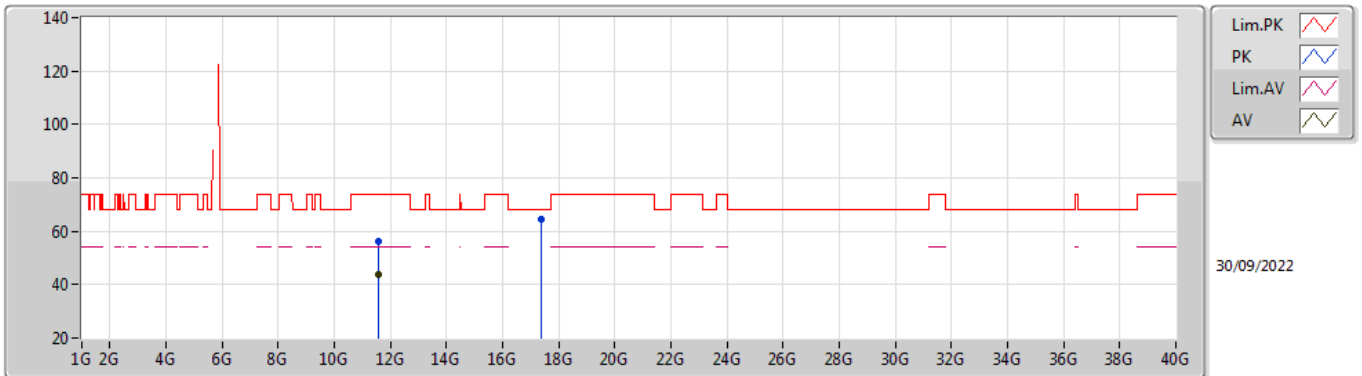

EUT X_2TX
Setting 24
02-F-G-4

Type	Freq (Hz)	Level (dBuV/m)	Limit (dBuV/m)	Margin (dB)	Raw (dBuV)	Dist (m)	Condition	Azimuth (°)	Height (m)	Comment	AF (dB)	CL (dB)	PA (dB)
PK	11.57024G	56.22	74.00	-17.78	41.24	3	Horizontal	97	1.80	-	39.21	7.93	32.16
AV	11.56994G	43.58	54.00	-10.42	28.60	3	Horizontal	97	1.80	-	39.21	7.93	32.16
PK	17.35578G	64.47	68.20	-3.73	41.18	3	Horizontal	329	2.78	-	42.83	10.68	30.22

802.11ax HEW20_Nss1,(MCS0)_2TX

5825MHz_TnomVnom

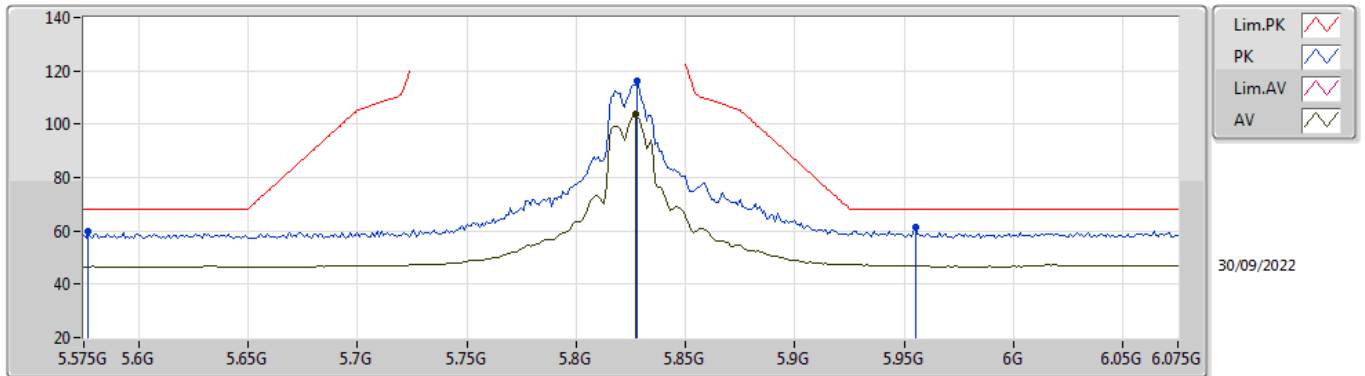

EUT_X_2TX
Setting 20.5
02-F-G-4-10

Type	Freq (Hz)	Level (dBuV/m)	Limit (dBuV/m)	Margin (dB)	Raw (dBuV)	Dist (m)	Condition	Azimuth (°)	Height (m)	Comment	AF (dB)	CL (dB)	PA (dB)
PK	5.577G	59.68	68.20	-8.52	50.93	3	Vertical	0	2.13	-	33.95	5.58	30.78
PK	5.828G	116.15	Inf	-Inf	107.69	3	Vertical	0	2.13	-	33.80	5.63	30.97
AV	5.827G	103.63	Inf	-Inf	95.17	3	Vertical	0	2.13	-	33.80	5.63	30.97
PK	5.955G	61.50	68.20	-6.70	52.62	3	Vertical	0	2.13	-	34.20	5.75	31.07

802.11ax HEW20_Nss1,(MCS0)_2TX

5825MHz_TnomVnom

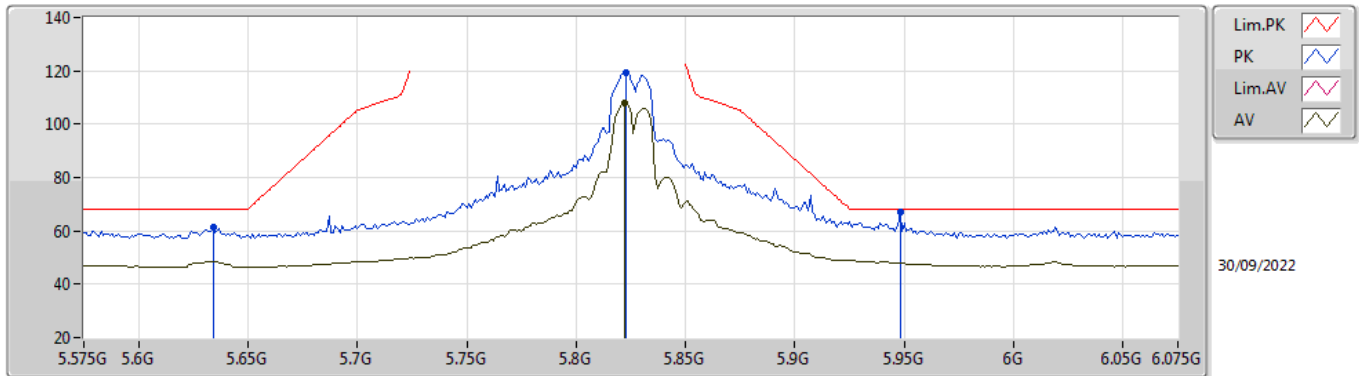

EUT_X_2TX
Setting 20.5
02-F-G-4-10

Type	Freq (Hz)	Level (dBuV/m)	Limit (dBuV/m)	Margin (dB)	Raw (dBuV)	Dist (m)	Condition	Azimuth (°)	Height (m)	Comment	AF (dB)	CL (dB)	PA (dB)
PK	5.634G	61.13	68.20	-7.07	52.52	3	Horizontal	6	1.05	-	33.83	5.60	30.82
PK	5.823G	119.38	Inf	-Inf	110.93	3	Horizontal	6	1.05	-	33.80	5.62	30.97
AV	5.822G	107.95	Inf	-Inf	99.49	3	Horizontal	6	1.05	-	33.80	5.62	30.96
PK	5.948G	66.96	68.20	-1.24	58.07	3	Horizontal	6	1.05	-	34.20	5.75	31.06

802.11ax HEW20_Nss1,(MCS0)_2TX

5825MHz_TnomVnom

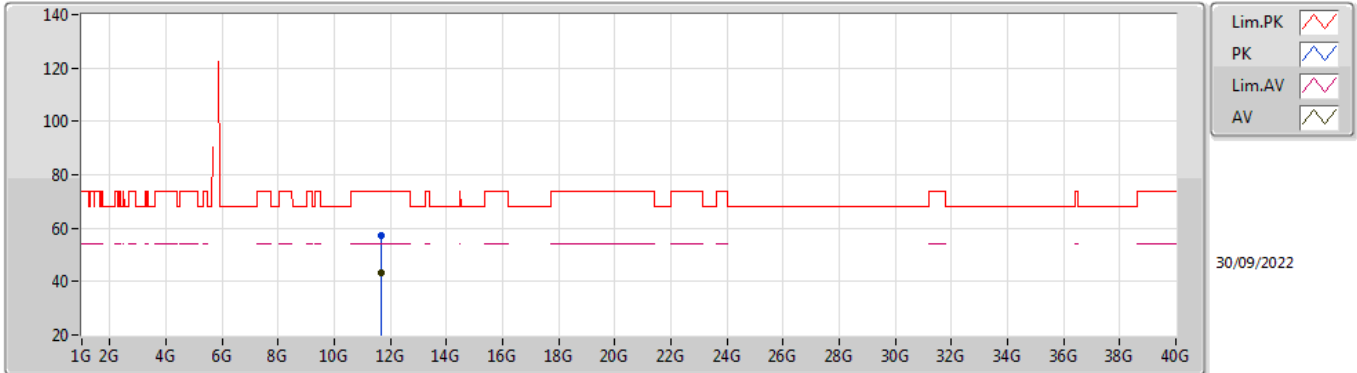

EUT_X_2TX
Setting 20.5
02-F-G-4

Type	Freq (Hz)	Level (dBuV/m)	Limit (dBuV/m)	Margin (dB)	Raw (dBuV)	Dist (m)	Condition	Azimuth (°)	Height (m)	Comment	AF (dB)	CL (dB)	PA (dB)
PK	11.65384G	57.17	74.00	-16.83	42.01	3	Vertical	41	1.76	-	39.41	7.96	32.21
AV	11.6545G	43.30	54.00	-10.70	28.14	3	Vertical	41	1.76	-	39.41	7.96	32.21

802.11ax HEW20_Nss1,(MCS0)_2TX

5825MHz_TnomVnom

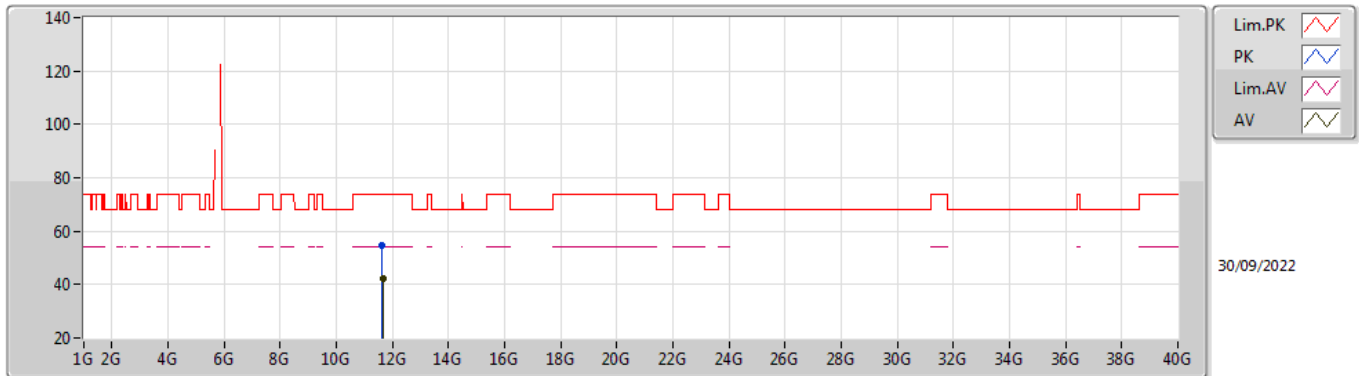

EUT X_2TX
Setting 20.5
02-F-G-4

Type	Freq (Hz)	Level (dBuV/m)	Limit (dBuV/m)	Margin (dB)	Raw (dBuV)	Dist (m)	Condition	Azimuth (°)	Height (m)	Comment	AF (dB)	CL (dB)	PA (dB)
PK	11.64574G	54.48	74.00	-19.52	39.33	3	Horizontal	88	1.54	-	39.39	7.96	32.20
AV	11.65G	42.30	54.00	-11.70	27.15	3	Horizontal	88	1.54	-	39.40	7.96	32.21

802.11ax HEW40_Nss1,(MCS0)_2TX

5190MHz_TnomVnom

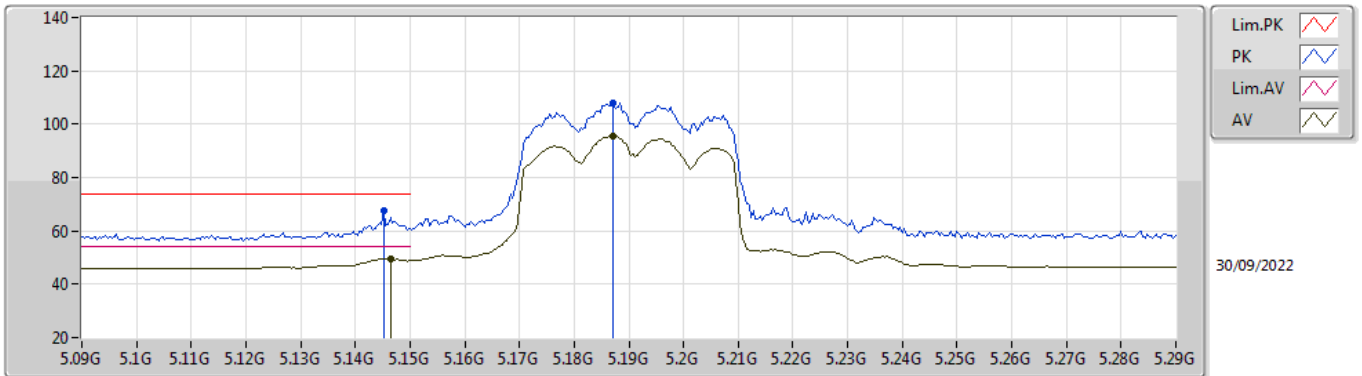

EUT_X_2TX
Setting 14.5
02-F-J-8-10

Type	Freq (Hz)	Level (dBuV/m)	Limit (dBuV/m)	Margin (dB)	Raw (dBuV)	Dist (m)	Condition	Azimuth (°)	Height (m)	Comment	AF (dB)	CL (dB)	PA (dB)
PK	5.1452G	67.58	74.00	-6.42	59.47	3	Vertical	3	2.02	-	33.59	5.25	30.73
AV	5.1464G	49.61	54.00	-4.39	41.50	3	Vertical	3	2.02	-	33.59	5.25	30.73
PK	5.1872G	107.89	Inf	-Inf	99.66	3	Vertical	3	2.02	-	33.67	5.29	30.73
AV	5.1872G	95.37	Inf	-Inf	87.14	3	Vertical	3	2.02	-	33.67	5.29	30.73

802.11ax HEW40_Nss1,(MCS0)_2TX

5190MHz_TnomVnom

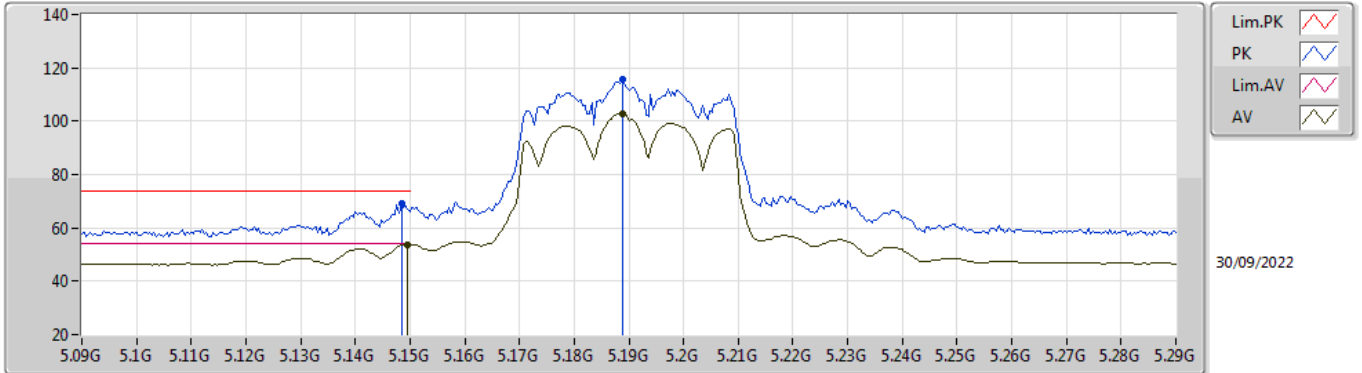

EUT_X_2TX
Setting 14.5
02-F-J-8-10

Type	Freq (Hz)	Level (dBuV/m)	Limit (dBuV/m)	Margin (dB)	Raw (dBuV)	Dist (m)	Condition	Azimuth (°)	Height (m)	Comment	AF (dB)	CL (dB)	PA (dB)
PK	5.1484G	69.00	74.00	-5.00	60.88	3	Horizontal	-0	2.62	-	33.60	5.25	30.73
AV	5.1496G	53.79	54.00	-0.21	45.67	3	Horizontal	-0	2.62	-	33.60	5.25	30.73
PK	5.1888G	115.72	Inf	-Inf	107.48	3	Horizontal	-0	2.62	-	33.68	5.29	30.73
AV	5.1888G	102.88	Inf	-Inf	94.64	3	Horizontal	-0	2.62	-	33.68	5.29	30.73

802.11ax HEW40_Nss1,(MCS0)_2TX

5190MHz_TnomVnom

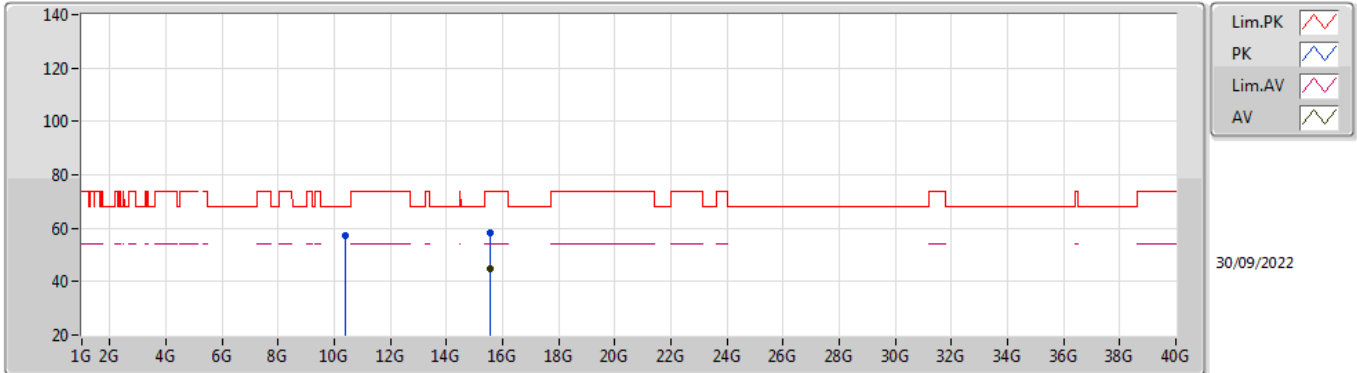

EUT X_2TX
Setting 14.5
02-F-J-8

Type	Freq (Hz)	Level (dBuV/m)	Limit (dBuV/m)	Margin (dB)	Raw (dBuV)	Dist (m)	Condition	Azimuth (°)	Height (m)	Comment	AF (dB)	CL (dB)	PA (dB)
PK	10.37988G	57.49	68.20	-10.71	43.25	3	Vertical	20	2.10	-	38.62	7.45	31.83
PK	15.56016G	58.39	74.00	-15.61	42.21	3	Vertical	198	1.70	-	37.74	9.80	31.36
AV	15.55554G	45.00	54.00	-9.00	28.79	3	Vertical	198	1.70	-	37.77	9.80	31.36

802.11ax HEW40_Nss1,(MCS0)_2TX

5190MHz_TnomVnom

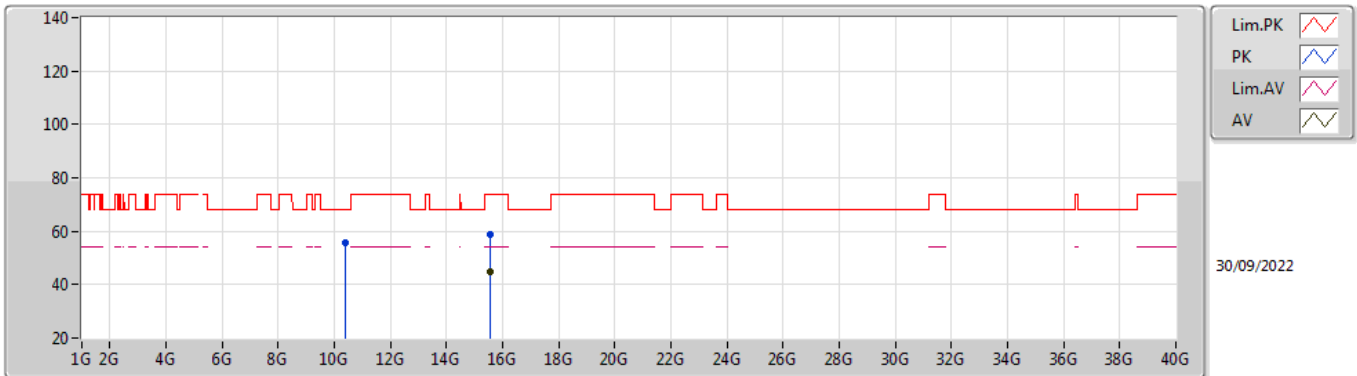

EUT X_2TX
Setting 14.5
02-F-J-8

Type	Freq (Hz)	Level (dBuV/m)	Limit (dBuV/m)	Margin (dB)	Raw (dBuV)	Dist (m)	Condition	Azimuth (°)	Height (m)	Comment	AF (dB)	CL (dB)	PA (dB)
PK	10.37994G	55.53	68.20	-12.67	41.29	3	Horizontal	311	1.76	-	38.62	7.45	31.83
PK	15.56592G	58.61	74.00	-15.39	42.47	3	Horizontal	172	1.86	-	37.70	9.80	31.36
AV	15.55704G	44.91	54.00	-9.09	28.71	3	Horizontal	172	1.86	-	37.76	9.80	31.36

802.11ax HEW40_Nss1,(MCS0)_2TX

5230MHz_TnomVnom

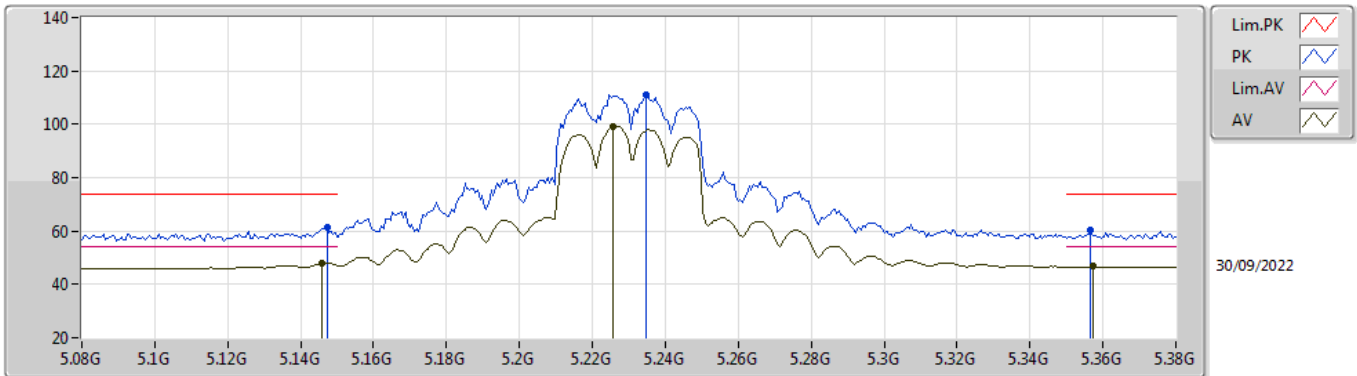

EUT_X_2TX
Setting 19
02-F-J-8-10

Type	Freq (Hz)	Level (dBuV/m)	Limit (dBuV/m)	Margin (dB)	Raw (dBuV)	Dist (m)	Condition	Azimuth (°)	Height (m)	Comment	AF (dB)	CL (dB)	PA (dB)
PK	5.1472G	61.53	74.00	-12.47	53.42	3	Vertical	6	1.83	-	33.59	5.25	30.73
AV	5.146G	48.04	54.00	-5.96	39.93	3	Vertical	6	1.83	-	33.59	5.25	30.73
PK	5.2348G	111.14	Inf	-Inf	102.85	3	Vertical	6	1.83	-	33.70	5.32	30.73
AV	5.2258G	99.33	Inf	-Inf	91.05	3	Vertical	6	1.83	-	33.70	5.31	30.73
PK	5.3566G	60.42	74.00	-13.58	51.85	3	Vertical	6	1.83	-	33.91	5.38	30.72
AV	5.3572G	46.67	54.00	-7.33	38.10	3	Vertical	6	1.83	-	33.91	5.38	30.72

802.11ax HEW40_Nss1,(MCS0)_2TX

5230MHz_TnomVnom

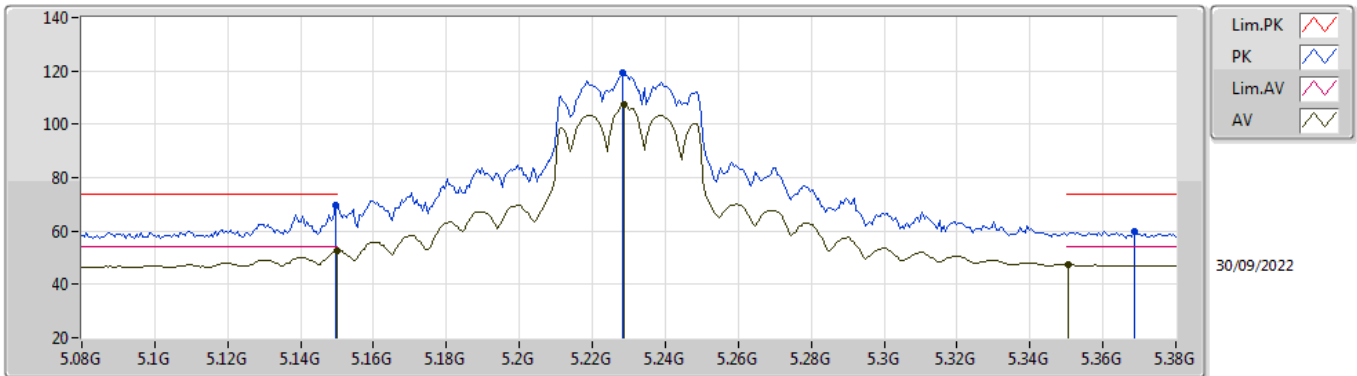

EUT_X_2TX
Setting 19
02-F-J-8-10

Type	Freq (Hz)	Level (dBuV/m)	Limit (dBuV/m)	Margin (dB)	Raw (dBuV)	Dist (m)	Condition	Azimuth (°)	Height (m)	Comment	AF (dB)	CL (dB)	PA (dB)
PK	5.1496G	69.48	74.00	-4.52	61.36	3	Horizontal	4	2.60	-	33.60	5.25	30.73
AV	5.15G	52.49	54.00	-1.51	44.37	3	Horizontal	4	2.60	-	33.60	5.25	30.73
PK	5.2282G	119.44	Inf	-Inf	111.16	3	Horizontal	4	2.60	-	33.70	5.31	30.73
AV	5.2288G	107.19	Inf	-Inf	98.91	3	Horizontal	4	2.60	-	33.70	5.31	30.73
PK	5.3686G	60.06	74.00	-13.94	51.46	3	Horizontal	4	2.60	-	33.94	5.38	30.72
AV	5.3506G	47.32	54.00	-6.68	38.76	3	Horizontal	4	2.60	-	33.90	5.38	30.72

802.11ax HEW40_Nss1,(MCS0)_2TX

5230MHz_TnomVnom

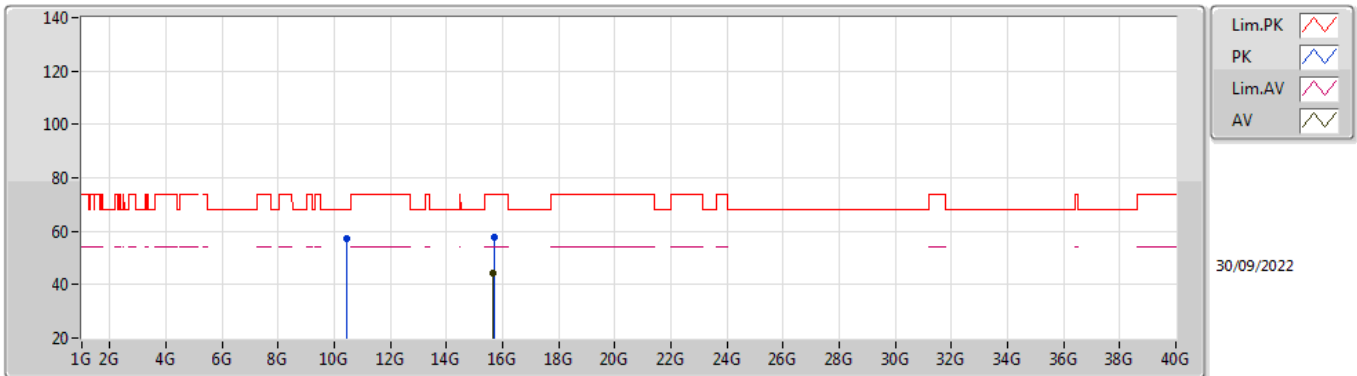

EUT X_2TX
Setting 19
02-F-J-8

Type	Freq (Hz)	Level (dBuV/m)	Limit (dBuV/m)	Margin (dB)	Raw (dBuV)	Dist (m)	Condition	Azimuth (°)	Height (m)	Comment	AF (dB)	CL (dB)	PA (dB)
PK	10.45994G	57.12	68.20	-11.08	42.88	3	Vertical	17	2.13	-	38.60	7.48	31.84
PK	15.69408G	57.82	74.00	-16.18	41.89	3	Vertical	7	1.93	-	37.50	9.86	31.43
AV	15.6783G	44.55	54.00	-9.45	28.61	3	Vertical	7	1.93	-	37.50	9.86	31.42

802.11ax HEW40_Nss1,(MCS0)_2TX

5230MHz_TnomVnom

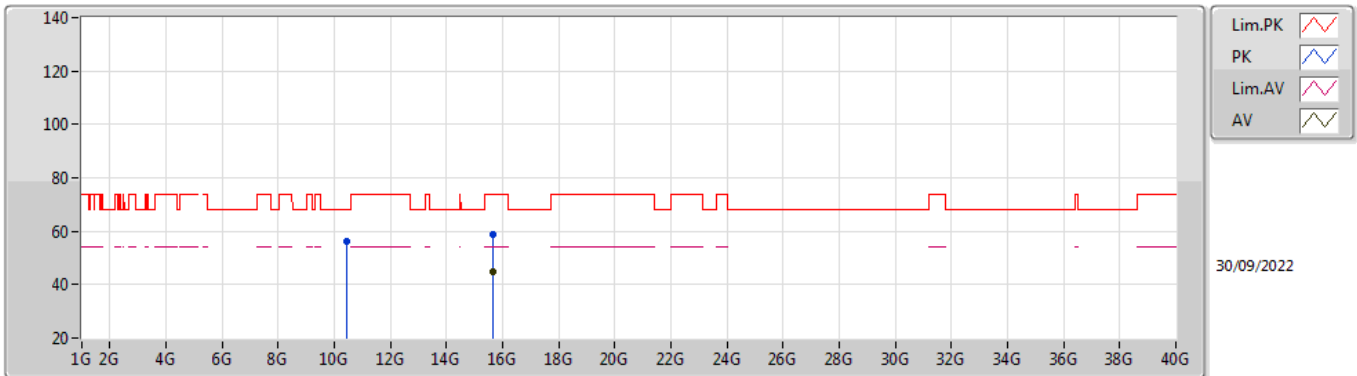

EUT X_2TX
Setting 19
02-F-J-8

Type	Freq (Hz)	Level (dBuV/m)	Limit (dBuV/m)	Margin (dB)	Raw (dBuV)	Dist (m)	Condition	Azimuth (°)	Height (m)	Comment	AF (dB)	CL (dB)	PA (dB)
PK	10.46G	56.08	68.20	-12.12	41.84	3	Horizontal	312	3.00	-	38.60	7.48	31.84
PK	15.67644G	58.59	74.00	-15.41	42.66	3	Horizontal	274	2.19	-	37.50	9.85	31.42
AV	15.67716G	44.75	54.00	-9.25	28.82	3	Horizontal	274	2.19	-	37.50	9.85	31.42

802.11ax HEW40_Nss1,(MCS0)_2TX

5755MHz_TnomVnom

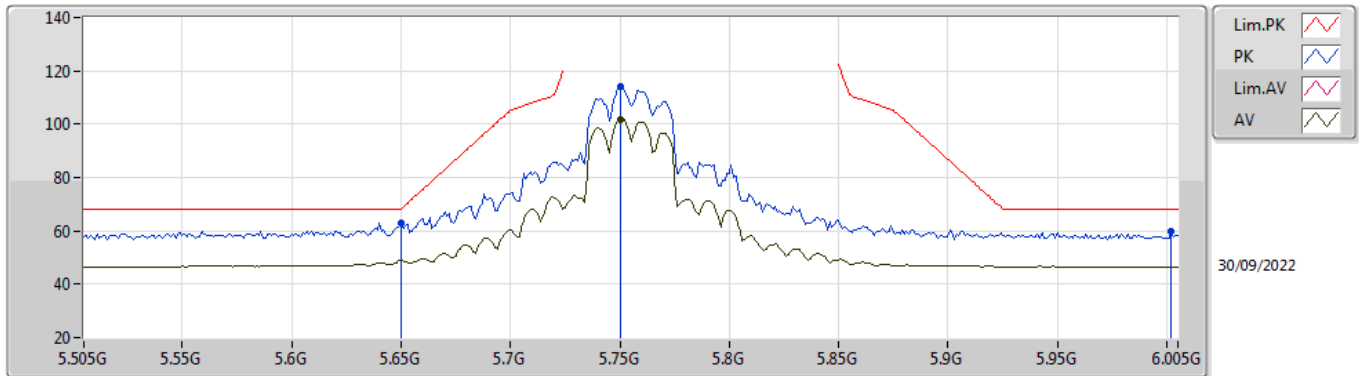

EUT_X_2TX
Setting 19.5
02-F-J-8-10

Type	Freq (Hz)	Level (dBuV/m)	Limit (dBuV/m)	Margin (dB)	Raw (dBuV)	Dist (m)	Condition	Azimuth (°)	Height (m)	Comment	AF (dB)	CL (dB)	PA (dB)
PK	5.65G	63.10	68.20	-5.10	54.53	3	Vertical	35	2.45	-	33.80	5.60	30.83
PK	5.75G	114.35	Inf	-Inf	105.86	3	Vertical	35	2.45	-	33.80	5.60	30.91
AV	5.75G	101.94	Inf	-Inf	93.45	3	Vertical	35	2.45	-	33.80	5.60	30.91
PK	6.002G	59.74	68.20	-8.46	50.84	3	Vertical	35	2.45	-	34.20	5.80	31.10

802.11ax HEW40_Nss1,(MCS0)_2TX

5755MHz_TnomVnom

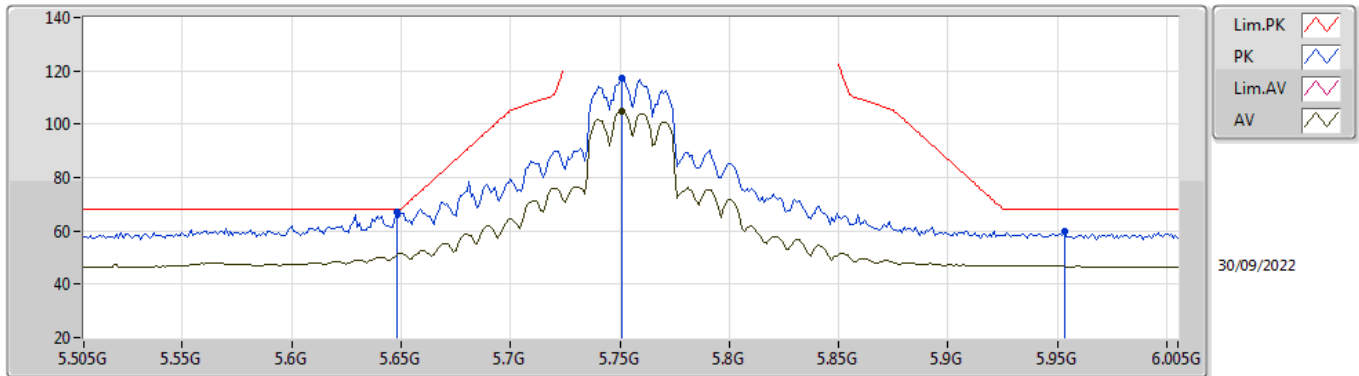

EUT_X_2TX
Setting 19.5
02-F-J-8-10

Type	Freq (Hz)	Level (dBuV/m)	Limit (dBuV/m)	Margin (dB)	Raw (dBuV)	Dist (m)	Condition	Azimuth (°)	Height (m)	Comment	AF (dB)	CL (dB)	PA (dB)
PK	5.648G	66.88	68.20	-1.32	58.31	3	Horizontal	4	1.03	-	33.80	5.60	30.83
PK	5.751G	117.31	Inf	-Inf	108.82	3	Horizontal	4	1.03	-	33.80	5.60	30.91
AV	5.751G	104.95	Inf	-Inf	96.46	3	Horizontal	4	1.03	-	33.80	5.60	30.91
PK	5.953G	59.68	68.20	-8.52	50.79	3	Horizontal	4	1.03	-	34.20	5.75	31.06

802.11ax HEW40_Nss1,(MCS0)_2TX

5755MHz_TnomVnom

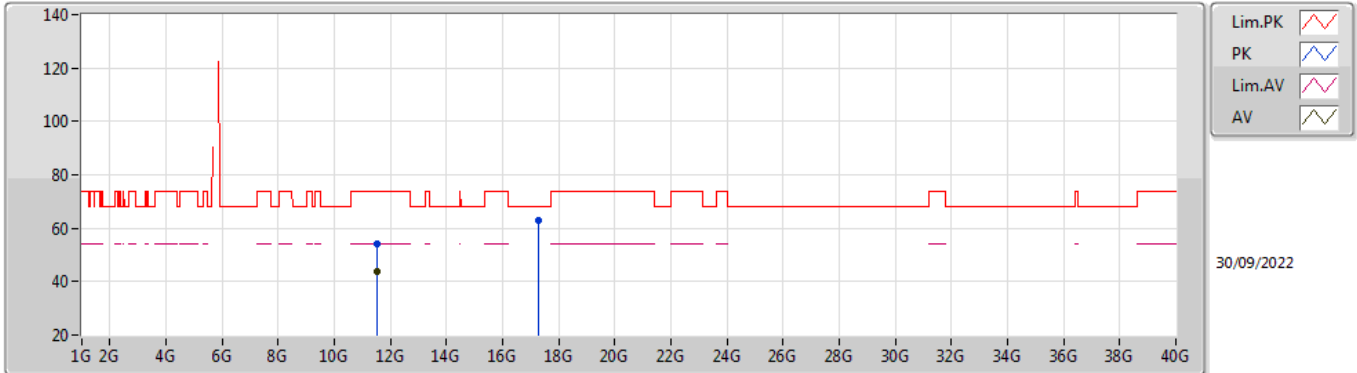

EUT X_2TX
Setting 19.5
02-F-J-8

Type	Freq (Hz)	Level (dBuV/m)	Limit (dBuV/m)	Margin (dB)	Raw (dBuV)	Dist (m)	Condition	Azimuth (°)	Height (m)	Comment	AF (dB)	CL (dB)	PA (dB)
PK	11.51006G	53.90	74.00	-20.10	39.10	3	Vertical	45	1.96	-	39.03	7.90	32.13
AV	11.50994G	43.88	54.00	-10.12	29.08	3	Vertical	45	1.96	-	39.03	7.90	32.13
PK	17.2695G	63.15	68.20	-5.05	40.40	3	Vertical	106	1.08	-	42.35	10.63	30.23

802.11ax HEW40_Nss1,(MCS0)_2TX

5755MHz_TnomVnom

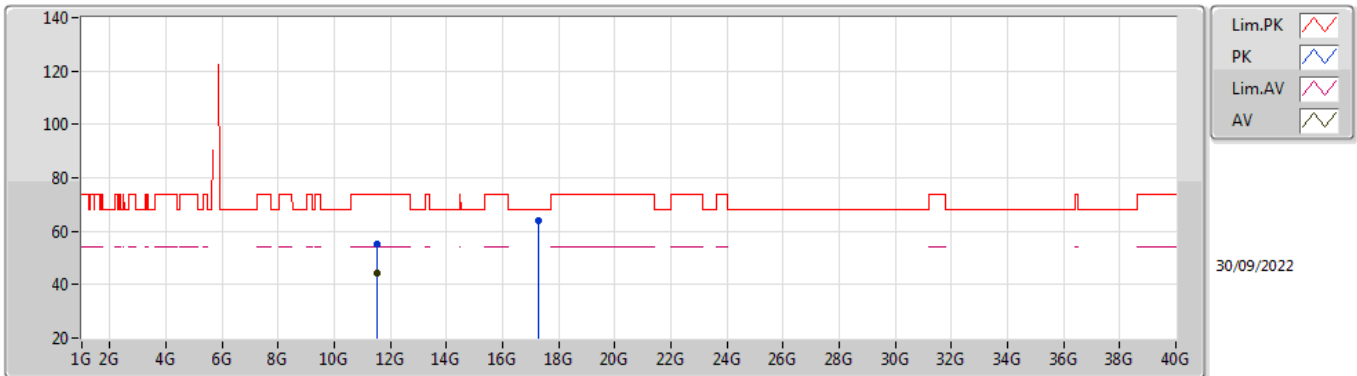

EUT X_2TX
Setting 19.5
02-F-J-8

Type	Freq (Hz)	Level (dBuV/m)	Limit (dBuV/m)	Margin (dB)	Raw (dBuV)	Dist (m)	Condition	Azimuth (°)	Height (m)	Comment	AF (dB)	CL (dB)	PA (dB)
PK	11.50964G	55.13	74.00	-18.87	40.33	3	Horizontal	96	1.64	-	39.03	7.90	32.13
AV	11.51G	44.45	54.00	-9.55	29.65	3	Horizontal	96	1.64	-	39.03	7.90	32.13
PK	17.26692G	63.93	68.20	-4.27	41.20	3	Horizontal	360	2.08	-	42.33	10.63	30.23

802.11ax HEW40_Nss1,(MCS0)_2TX

5795MHz_TnomVnom

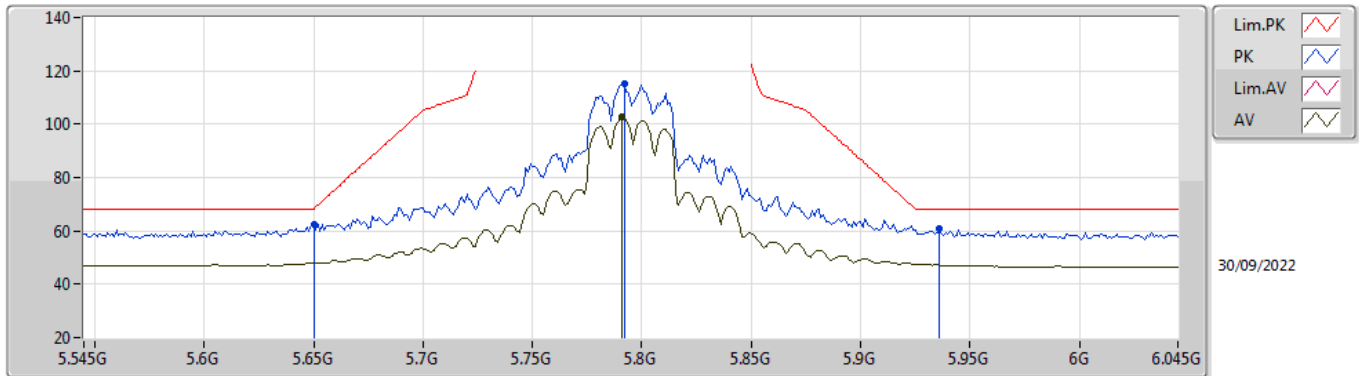

EUT X_2TX
Setting 20
02-F-J-8-10

Type	Freq (Hz)	Level (dBuV/m)	Limit (dBuV/m)	Margin (dB)	Raw (dBuV)	Dist (m)	Condition	Azimuth (°)	Height (m)	Comment	AF (dB)	CL (dB)	PA (dB)
PK	5.65G	62.54	68.20	-5.66	53.97	3	Vertical	35	2.65	-	33.80	5.60	30.83
PK	5.792G	115.03	Inf	-Inf	106.57	3	Vertical	35	2.65	-	33.80	5.60	30.94
AV	5.791G	102.55	Inf	-Inf	94.09	3	Vertical	35	2.65	-	33.80	5.60	30.94
PK	5.936G	60.78	68.20	-7.42	51.92	3	Vertical	35	2.65	-	34.17	5.74	31.05

802.11ax HEW40_Nss1,(MCS0)_2TX

5795MHz_TnomVnom

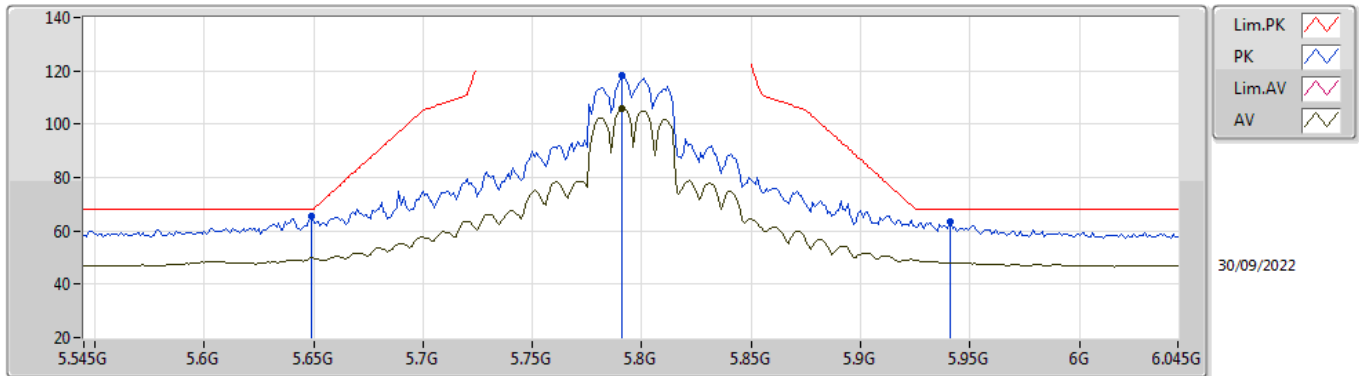

EUT_X_2TX
Setting 20
02-F-J-8-10

Type	Freq (Hz)	Level (dBuV/m)	Limit (dBuV/m)	Margin (dB)	Raw (dBuV)	Dist (m)	Condition	Azimuth (°)	Height (m)	Comment	AF (dB)	CL (dB)	PA (dB)
PK	5.649G	65.66	68.20	-2.54	57.09	3	Horizontal	7	1.03	-	33.80	5.60	30.83
PK	5.791G	118.52	Inf	-Inf	110.06	3	Horizontal	7	1.03	-	33.80	5.60	30.94
AV	5.791G	105.95	Inf	-Inf	97.49	3	Horizontal	7	1.03	-	33.80	5.60	30.94
PK	5.941G	63.40	68.20	-4.80	54.54	3	Horizontal	7	1.03	-	34.18	5.74	31.06

802.11ax HEW40_Nss1,(MCS0)_2TX

5795MHz_TnomVnom

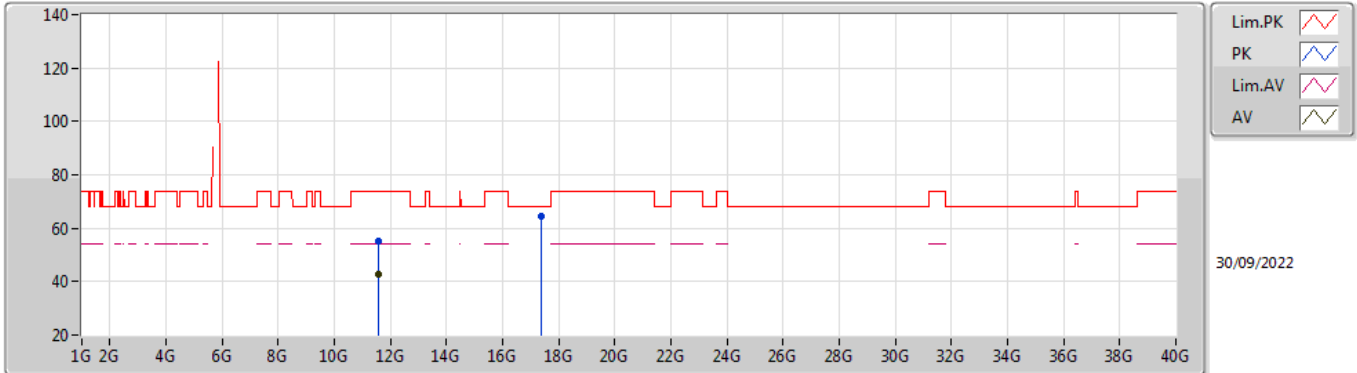

EUT X_2TX
Setting 20
02-F-J-8

Type	Freq (Hz)	Level (dBuV/m)	Limit (dBuV/m)	Margin (dB)	Raw (dBuV)	Dist (m)	Condition	Azimuth (°)	Height (m)	Comment	AF (dB)	CL (dB)	PA (dB)
PK	11.5849G	55.39	74.00	-18.61	40.38	3	Vertical	46	1.86	-	39.25	7.93	32.17
AV	11.58994G	42.93	54.00	-11.07	27.89	3	Vertical	46	1.86	-	39.27	7.94	32.17
PK	17.37642G	64.28	68.20	-3.92	40.85	3	Vertical	29	2.39	-	42.96	10.69	30.22

802.11ax HEW40_Nss1,(MCS0)_2TX

5795MHz_TnomVnom

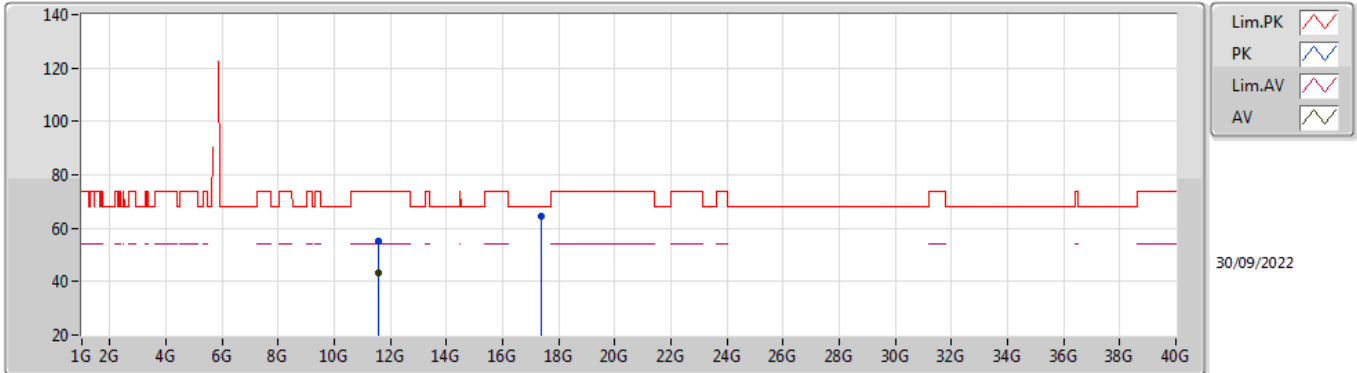

EUT X_2TX
Setting 20
02-F-J-8

Type	Freq (Hz)	Level (dBuV/m)	Limit (dBuV/m)	Margin (dB)	Raw (dBuV)	Dist (m)	Condition	Azimuth (°)	Height (m)	Comment	AF (dB)	CL (dB)	PA (dB)
PK	11.5903G	54.98	74.00	-19.02	39.94	3	Horizontal	94	1.61	-	39.27	7.94	32.17
AV	11.59G	43.06	54.00	-10.94	28.02	3	Horizontal	94	1.61	-	39.27	7.94	32.17
PK	17.3787G	64.46	68.20	-3.74	41.02	3	Horizontal	286	2.05	-	42.97	10.69	30.22

802.11ax HEW80_Nss1,(MCS0)_2TX

5210MHz_TnomVnom

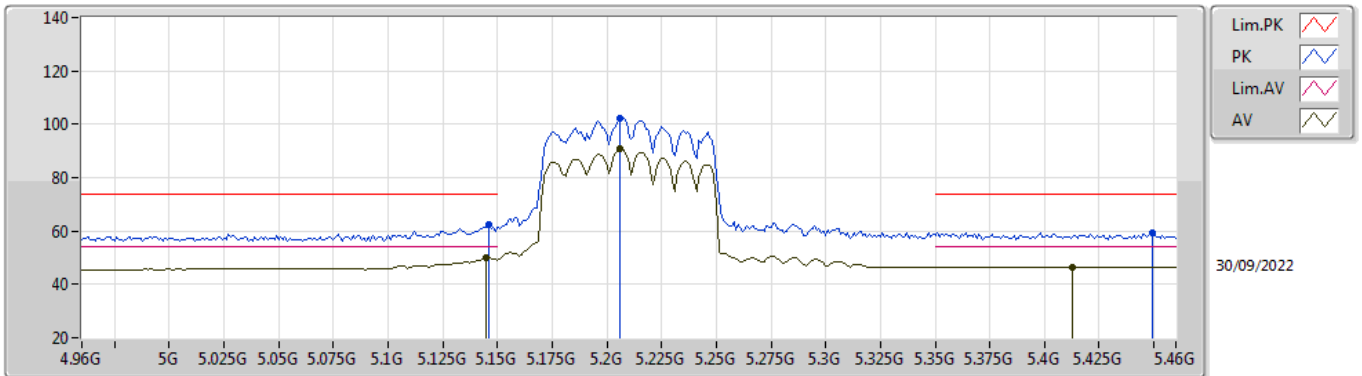

EUT_X_2TX
Setting 13.5
02-F-J-8-10

Type	Freq (Hz)	Level (dBuV/m)	Limit (dBuV/m)	Margin (dB)	Raw (dBuV)	Dist (m)	Condition	Azimuth (°)	Height (m)	Comment	AF (dB)	CL (dB)	PA (dB)
PK	5.146G	62.44	74.00	-11.56	54.33	3	Vertical	0	1.91	-	33.59	5.25	30.73
AV	5.145G	49.93	54.00	-4.07	41.82	3	Vertical	0	1.91	-	33.59	5.25	30.73
PK	5.206G	102.25	Inf	-Inf	93.98	3	Vertical	0	1.91	-	33.70	5.30	30.73
AV	5.206G	90.64	Inf	-Inf	82.37	3	Vertical	0	1.91	-	33.70	5.30	30.73
PK	5.449G	59.52	74.00	-14.48	50.79	3	Vertical	0	1.91	-	34.00	5.45	30.72
AV	5.413G	46.62	54.00	-7.38	37.93	3	Vertical	0	1.91	-	34.00	5.41	30.72

802.11ax HEW80_Nss1,(MCS0)_2TX

5210MHz_TnomVnom

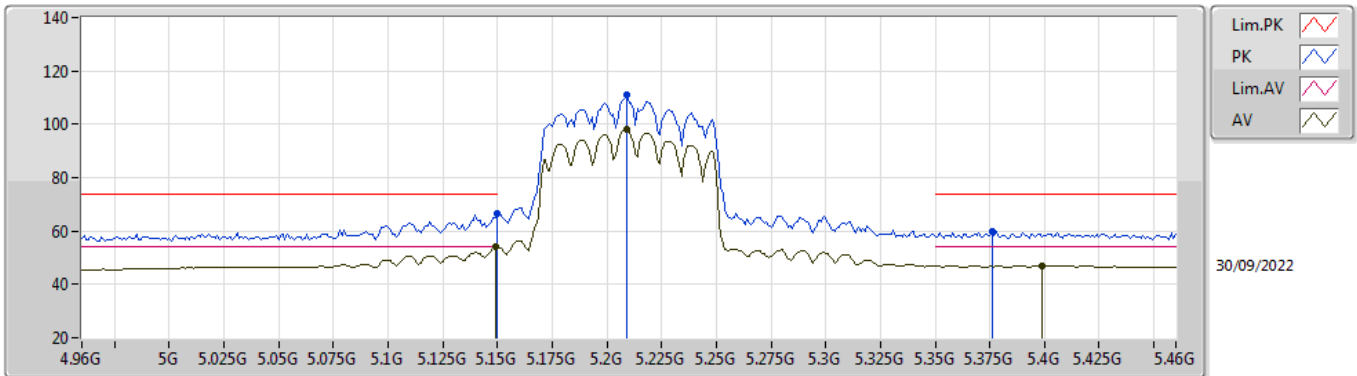

EUT_X_2TX
Setting 13.5
02-F-J-8-10

Type	Freq (Hz)	Level (dBuV/m)	Limit (dBuV/m)	Margin (dB)	Raw (dBuV)	Dist (m)	Condition	Azimuth (°)	Height (m)	Comment	AF (dB)	CL (dB)	PA (dB)
PK	5.15G	66.68	74.00	-7.32	58.56	3	Horizontal	0	2.61	-	33.60	5.25	30.73
AV	5.149G	53.96	54.00	-0.04	45.84	3	Horizontal	0	2.61	-	33.60	5.25	30.73
PK	5.209G	110.94	Inf	-Inf	102.67	3	Horizontal	0	2.61	-	33.70	5.30	30.73
AV	5.209G	98.19	Inf	-Inf	89.92	3	Horizontal	0	2.61	-	33.70	5.30	30.73
PK	5.376G	59.69	74.00	-14.31	51.07	3	Horizontal	0	2.61	-	33.95	5.39	30.72
AV	5.399G	46.84	54.00	-7.16	38.16	3	Horizontal	0	2.61	-	34.00	5.40	30.72

802.11ax HEW80_Nss1,(MCS0)_2TX

5210MHz_TnomVnom

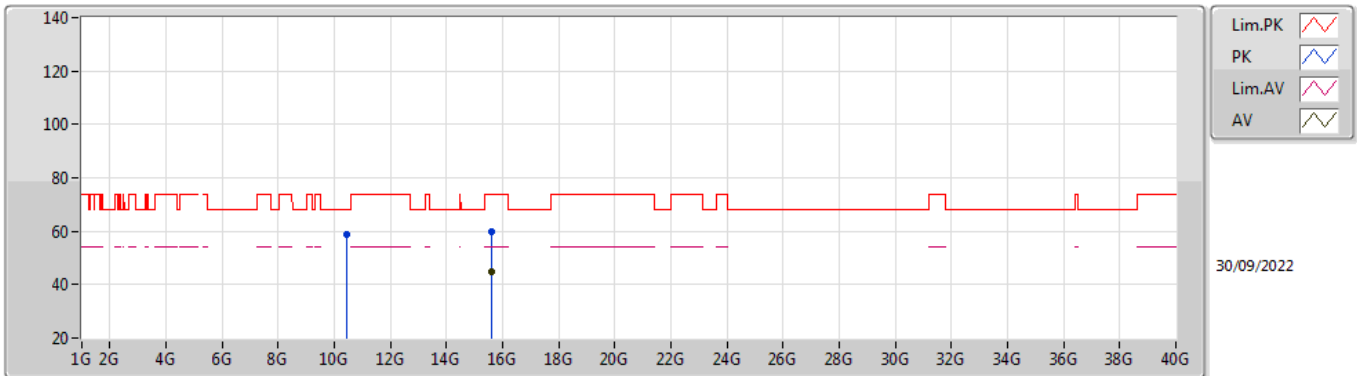

EUT X_2TX
Setting 13.5
02-F-C-6

Type	Freq (Hz)	Level (dBuV/m)	Limit (dBuV/m)	Margin (dB)	Raw (dBuV)	Dist (m)	Condition	Azimuth (°)	Height (m)	Comment	AF (dB)	CL (dB)	PA (dB)
PK	10.42G	58.70	68.20	-9.50	44.47	3	Vertical	16	2.09	-	38.60	7.47	31.84
PK	15.61662G	59.57	74.00	-14.43	43.63	3	Vertical	27	2.13	-	37.50	9.83	31.39
AV	15.6222G	44.61	54.00	-9.39	28.67	3	Vertical	27	2.13	-	37.50	9.83	31.39

802.11ax HEW80_Nss1,(MCS0)_2TX

5210MHz_TnomVnom

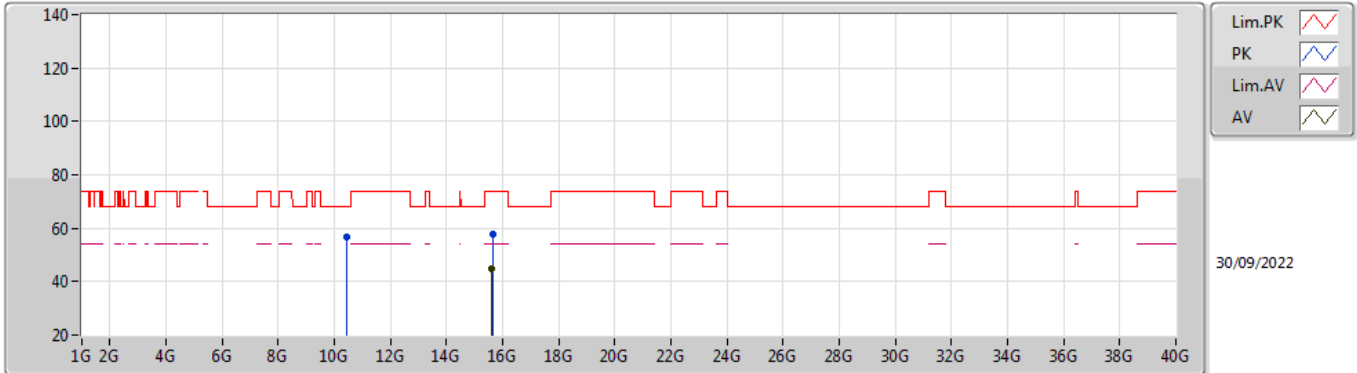

EUT X_2TX
Setting 13.5
02-F-C-6

Type	Freq (Hz)	Level (dBuV/m)	Limit (dBuV/m)	Margin (dB)	Raw (dBuV)	Dist (m)	Condition	Azimuth (°)	Height (m)	Comment	AF (dB)	CL (dB)	PA (dB)
PK	10.41994G	56.59	68.20	-11.61	42.36	3	Horizontal	262	1.67	-	38.60	7.47	31.84
PK	15.63858G	57.82	74.00	-16.18	41.88	3	Horizontal	52	1.07	-	37.50	9.84	31.40
AV	15.61764G	44.65	54.00	-9.35	28.71	3	Horizontal	52	1.07	-	37.50	9.83	31.39

802.11ax HEW80_Nss1,(MCS0)_2TX

5775MHz_TnomVnom

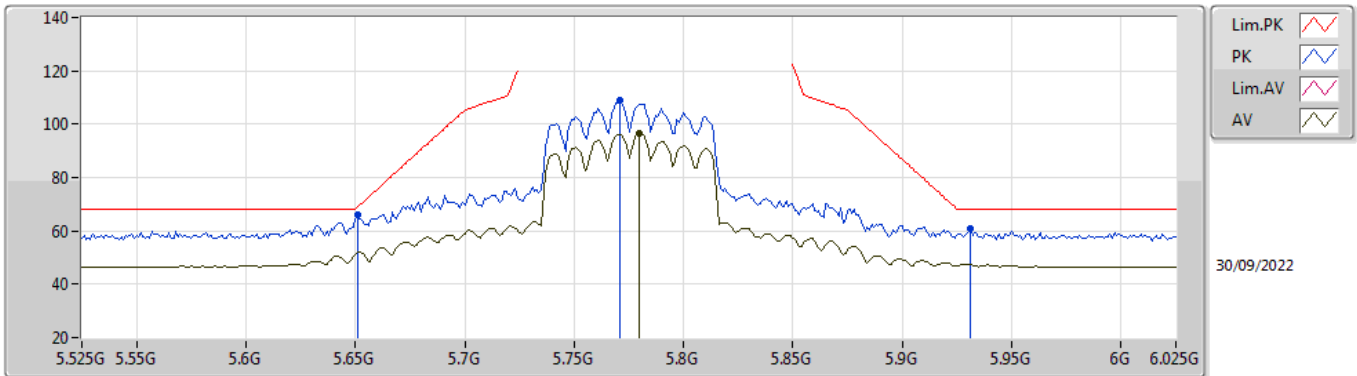

EUT_X_2TX
Setting 17
02-F-J-8-10

Type	Freq (Hz)	Level (dBuV/m)	Limit (dBuV/m)	Margin (dB)	Raw (dBuV)	Dist (m)	Condition	Azimuth (°)	Height (m)	Comment	AF (dB)	CL (dB)	PA (dB)
PK	5.651G	66.00	68.94	-2.94	57.43	3	Vertical	39	2.52	-	33.80	5.60	30.83
PK	5.771G	109.19	Inf	-Inf	100.72	3	Vertical	39	2.52	-	33.80	5.60	30.93
AV	5.78G	96.62	Inf	-Inf	88.15	3	Vertical	39	2.52	-	33.80	5.60	30.93
PK	5.931G	60.87	68.20	-7.33	52.03	3	Vertical	39	2.52	-	34.16	5.73	31.05

802.11ax HEW80_Nss1,(MCS0)_2TX

5775MHz_TnomVnom

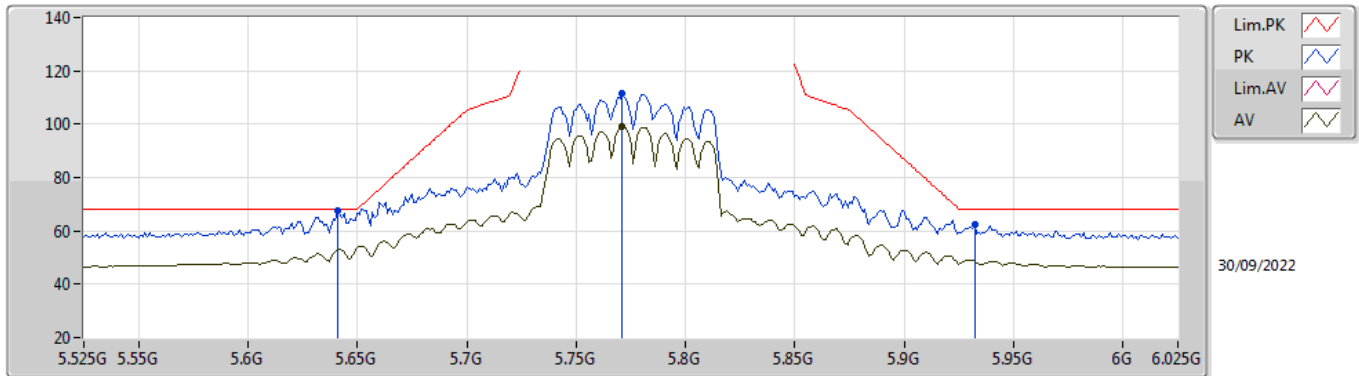

EUT_X_2TX
Setting 17
02-F-J-8-10

Type	Freq (Hz)	Level (dBuV/m)	Limit (dBuV/m)	Margin (dB)	Raw (dBuV)	Dist (m)	Condition	Azimuth (°)	Height (m)	Comment	AF (dB)	CL (dB)	PA (dB)
PK	5.641G	67.42	68.20	-0.78	58.83	3	Horizontal	7	1.06	-	33.82	5.60	30.83
PK	5.771G	111.54	Inf	-Inf	103.07	3	Horizontal	7	1.06	-	33.80	5.60	30.93
AV	5.771G	99.31	Inf	-Inf	90.84	3	Horizontal	7	1.06	-	33.80	5.60	30.93
PK	5.932G	62.31	68.20	-5.89	53.47	3	Horizontal	7	1.06	-	34.16	5.73	31.05

802.11ax HEW80_Nss1,(MCS0)_2TX

5775MHz_TnomVnom

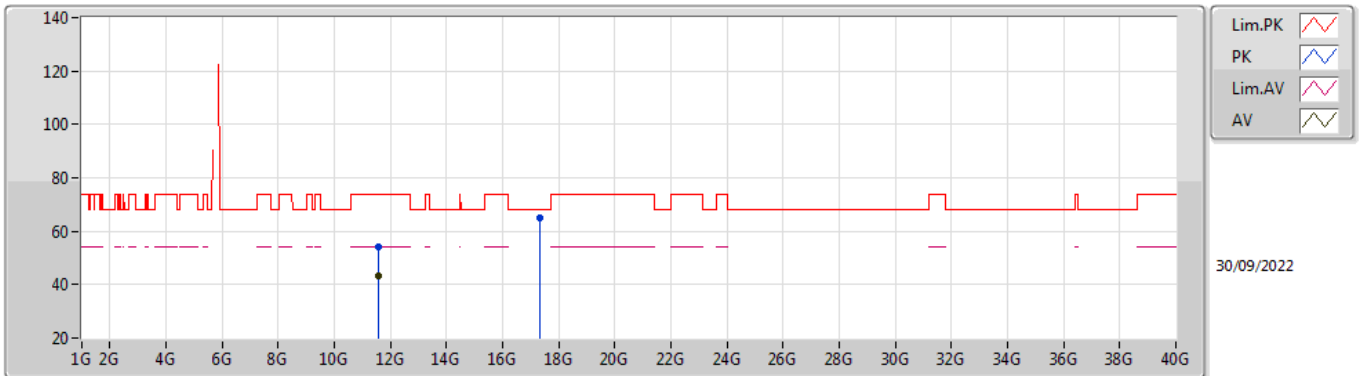

EUT X_2TX
Setting 17
02-F-C-6

Type	Freq (Hz)	Level (dBuV/m)	Limit (dBuV/m)	Margin (dB)	Raw (dBuV)	Dist (m)	Condition	Azimuth (°)	Height (m)	Comment	AF (dB)	CL (dB)	PA (dB)
PK	11.54982G	54.02	74.00	-19.98	39.10	3	Vertical	47	2.04	-	39.15	7.92	32.15
AV	11.55G	43.43	54.00	-10.57	28.51	3	Vertical	47	2.04	-	39.15	7.92	32.15
PK	17.32842G	64.76	68.20	-3.44	41.66	3	Vertical	297	2.57	-	42.67	10.66	30.23

802.11ax HEW80_Nss1,(MCS0)_2TX

5775MHz_TnomVnom

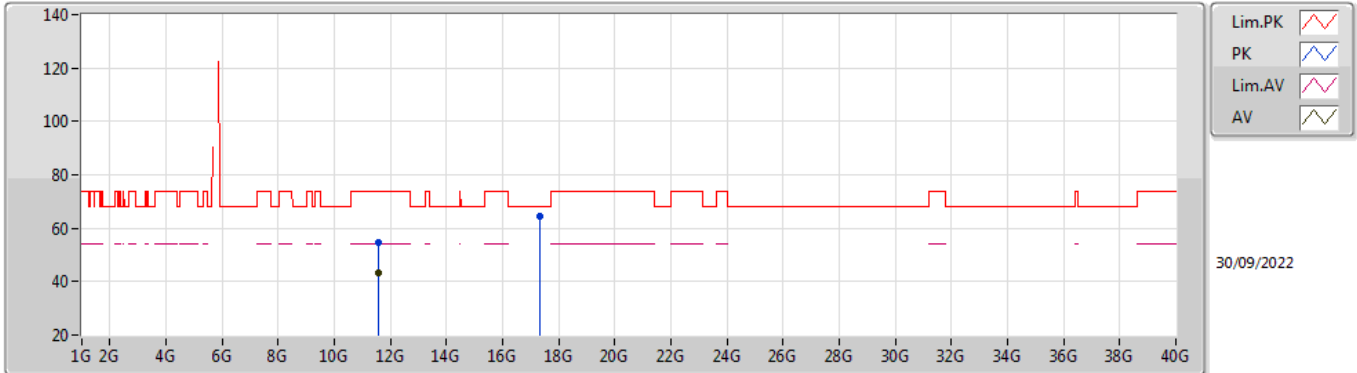

EUT X_2TX
Setting 17
02-F-C-6

Type	Freq (Hz)	Level (dBuV/m)	Limit (dBuV/m)	Margin (dB)	Raw (dBuV)	Dist (m)	Condition	Azimuth (°)	Height (m)	Comment	AF (dB)	CL (dB)	PA (dB)
PK	11.55894G	54.43	74.00	-19.57	39.48	3	Horizontal	86	1.80	-	39.18	7.92	32.15
AV	11.54994G	43.21	54.00	-10.79	28.29	3	Horizontal	86	1.80	-	39.15	7.92	32.15
PK	17.328G	64.49	68.20	-3.71	41.39	3	Horizontal	8	1.11	-	42.67	10.66	30.23