

More Ideas Will Be Discovered



Android

iOS

Download APP by Scanning the QR Code

STEM



MASTER CONTROL



SENSOR



MOTOR



User Manual

Table of Contents

Main Control Unit ----- 001

Distance Sensor ----- 002

Motor ----- 002

APP Instructions ----- 003

Programming ----- 004

Basic Knowledge ----- 005

FAQ ----- 058



SpaceShip ----- 008



Elasti-Car ----- 013



Inertia Car ----- 017



Tumbler ----- 022



Pivoting Fan ----- 028



Electric Buhr Mill ----- 034



Tyrannosaurus ----- 042

Main Control Unit

Obverse Side

1. Power Button
2. Pause Motor
3. Motor Socket 1
4. Motor Socket 2
5. Distance Sensor Socket 1
6. Distance Sensor Socket 2
7. Gyro Sensor Socket



Reverse Side

1. Spin Motor Clockwise
2. Spin Motor Counter-clockwise
3. Colorful LED Light 1
4. Colorful LED Light 2



How to use the power button of the main control unit



Remote control mode pairing
 Shortly press the power button, it will flash red within 10 seconds. It means remote control mode pairing.



APP control mode pairing
 Shortly press the power button, it will flash green after 10 seconds. It means APP control mode pairing.



Off-line mode running
 Press the power button and hold for 10 seconds to turn it on. The robot starts off-line mode and runs automatically according to the uploaded program from APP programming page.

Steps for Usage

1



Turn on the power

2



Shortly press the button and spin motor clockwise

3



Shortly press the button and pause motor



Shortly press the button and spin motor counter-clockwise

Battery Installation

Open the battery case



Put in 2 AA batteries



Close the battery case



Instructions for Battery Installation

Non-rechargeable batteries cannot be charged. The supply terminals are not to be short-circuited. Rechargeable batteries should be charged under the supervision of an adult. Batteries with different models, old and new batteries should not be mixed. Exhausted batteries should be removed from the product. The toy cannot be connected to more than the recommended number of power sources; Rechargeable batteries are to be removed from the toy before being charged. Batteries are to be inserted with the correct polarity. This product does not contain battery.

Distance Sensor



Infrared Distance Sensor

Use infrared principle to realize the functions of measuring distance, avoiding obstacles, or tracking line. Make robots intelligent, let children truly feel the future of intelligence.

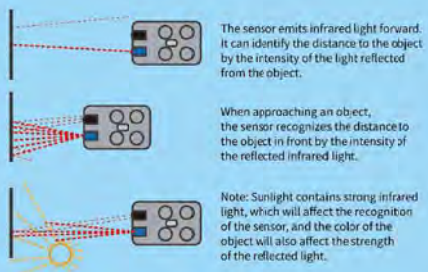

Motor



The motor use the principle of electric energy conversion kinetic energy, provides strong power for the robot to make it move.



Spin motor clockwise

Spin motor counter-clockwise

APP Instructions



Download APP



APP icon

① Scan the QR code

② Searching "RobotMake" in the Google Play Store

Android



Download APP



APP icon

① Scan the QR code

② Searching "RobotMake" in the Apple App Store

iOS

① Download APP



It contains different packages, more ways to play, unlimited fun.

② Choose a package



It contains more than 100 creative ways to play.

③ Choose a way to play

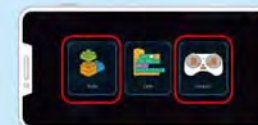

It contains building, tutorial and control (need main control unit connection).

④ Build/Control



Bring your phone or tablet computer closer to the main control unit. After the pairing is completed, the signal light of the main control unit will change to green.

⑤ Connect to the main control unit

Programming

Method One



1 Choose a kind of form

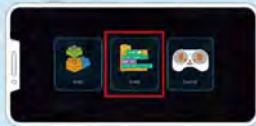

2 Choose Code

Method Two



1 Create, press "+" button

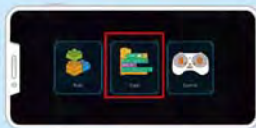

2 Choose Code



3 Coding

Scratch 3.0



1 Enter the download address in your computer browser to download "Scratch Link"
<https://downloads.scratch.mit.edu/link/windows.zip>



Scratch Link

2 Unzip and run "ScratchLinkSetup". "Scratch Link" must be opened before each use of Scratch



3 Enter the "Scratch" address in the browser, open the Scratch editor.
<http://scratch.td-robot.com/>



4 On the Scratch editor, click the "Add Extension" icon in the lower left corner



5 Choose "Robotmaster"

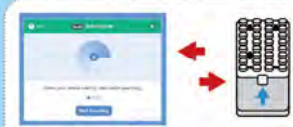

6 Press the main control unit for pairing.
Your computer must be equipped with Bluetooth.



7 After the pairing completed, go back to the Scratch editor, drag some programming block in the toolbox into the workspace for programming.



8 For example, drag "light" block into the workspace and click it. All lights of the main control unit will turn "red".

Basic Knowledge

1. Unit size

1 unit size = 8mm (mm), we call it 1 unit.
Generally the width, height,
length and unit size of the part are all integer multiples.

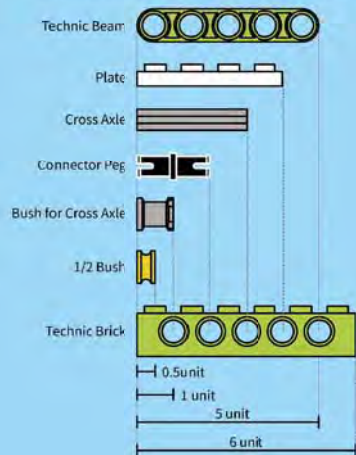

2. Height of beam and hamburger structure

The height of beam and brick

The height of beam and brick = 1.2 unit size = 9.6mm
1 layer of beams or bricks = the height of 3 layers of plates,
so the height of each layer of plates is 0.4 unit size = 3.2mm

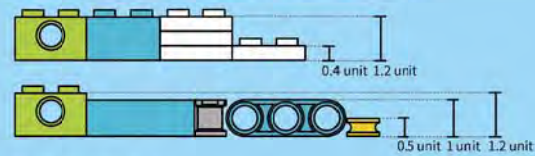

hamburger structure

The height of two layers of beams or bricks plus two layers of plates is 3.2 units, and the hole spacing is 2 units, we call it 2 thick 2 thin (2 thin ones must be placed in the middle).

The height of two layers of beams or brick's hole spacing is 1.2 units + plate 0.4 units + plate 0.4 units = 2 units

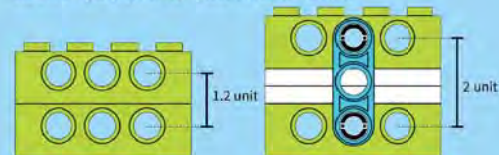

3. Types of connector peg

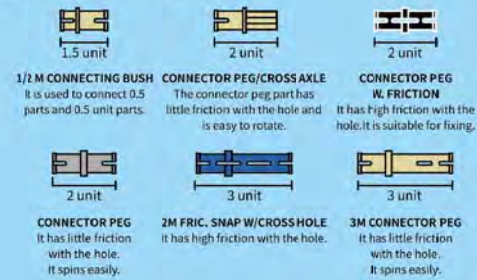

5. Disassembly Skills

The disassembler uses the principle of leverage.
It help you to disassemble parts swiftly and easy to use.

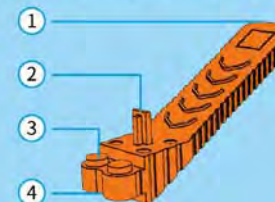

4. Assembly Skills

Interlock



Two points determine a straight line.

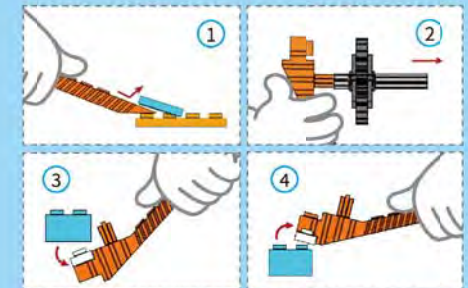
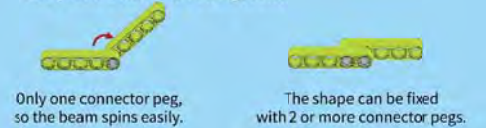

Spaceship

Assembly difficulty
☆☆☆☆

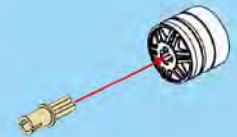
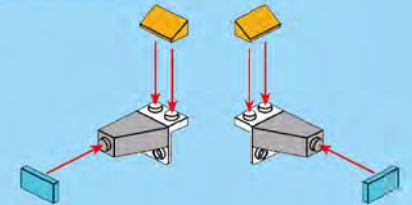
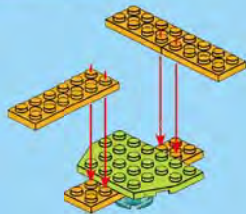
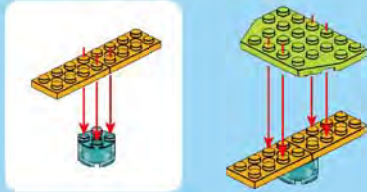
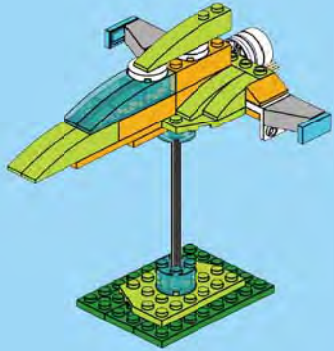

15



16



17



18

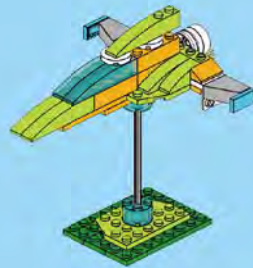

Elasti-Car

Assembly difficulty
 ★★★★★

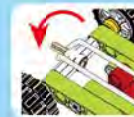
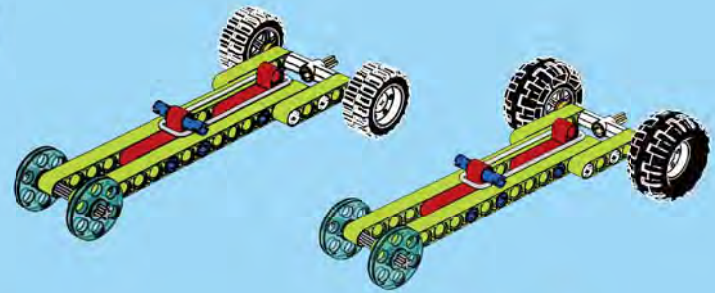

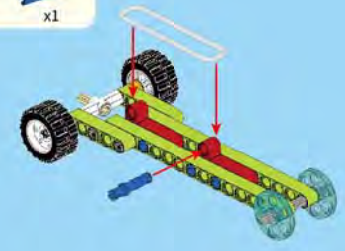
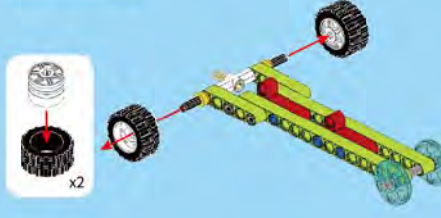
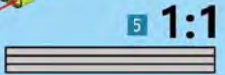
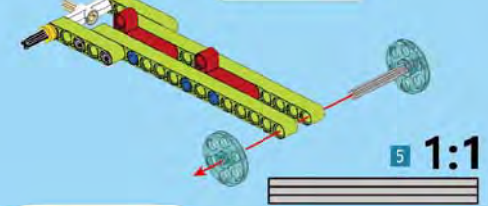
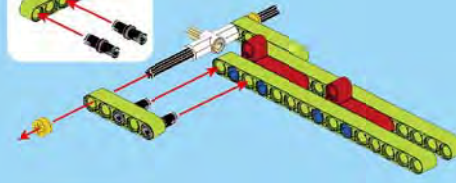
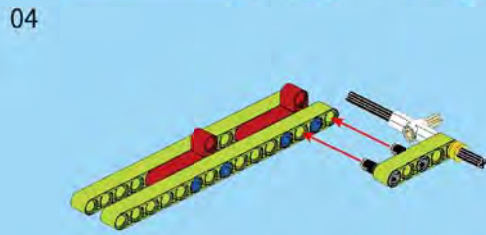
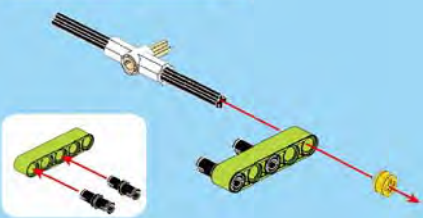
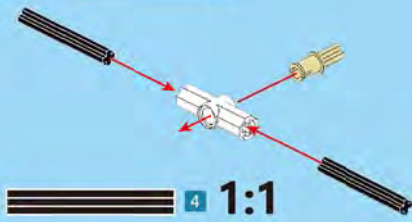
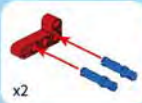
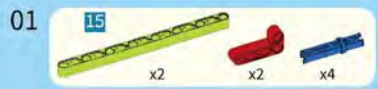

Let's see which car is farther

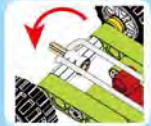
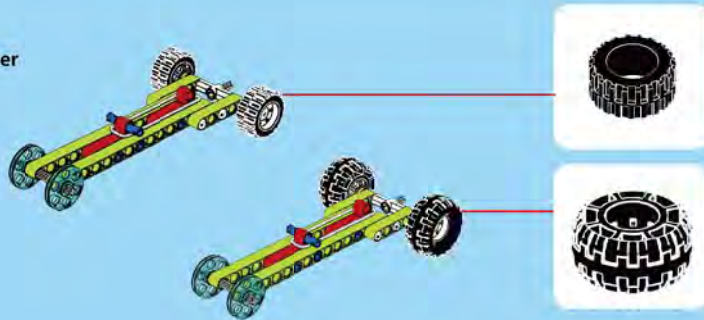

1 Buckle up the rubber band and hold it, pull the Elasti-Car back.

2 Loosen the Elasti-Car, the rubber band's elasticity makes the car move forward.

Inertia Car

Assembly difficulty
☆☆☆☆☆

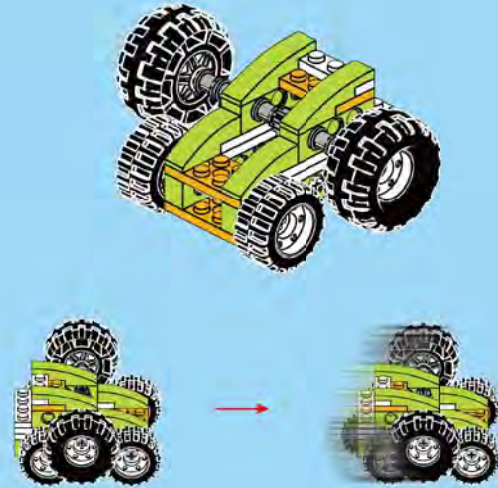

- 01 **6** x1 **4** x1 **1** x1 **2** x2 **1** x1



- 02 **8** x2

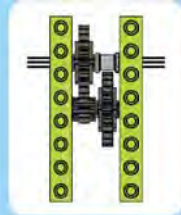
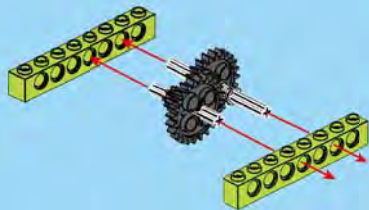

- 03 **2x4** x1 **1x6** x2

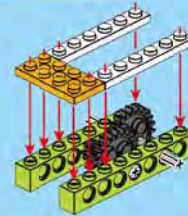

- 04 **1x6** x2 **1x4** x1 **2** x2

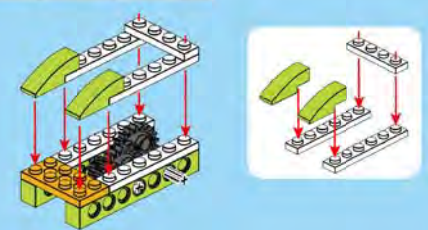

- 05 **10** x1 **5** x5 **1** x1 **4** x2

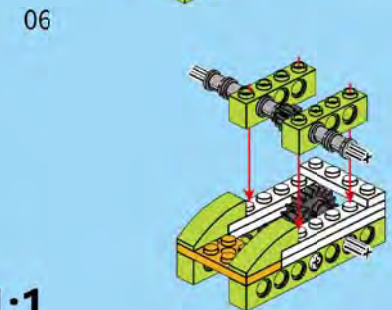
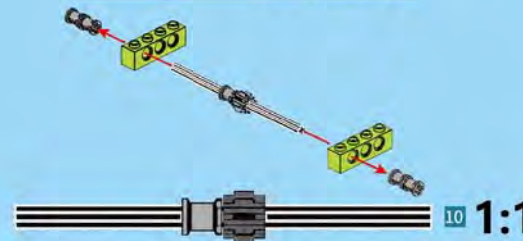

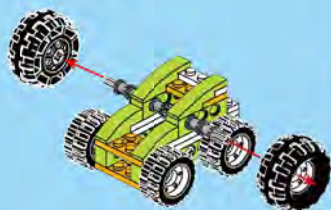
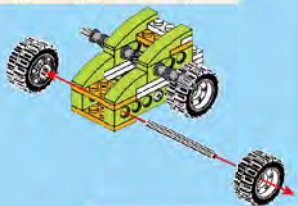
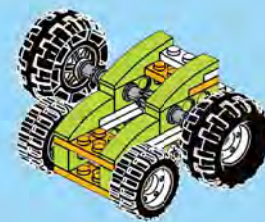
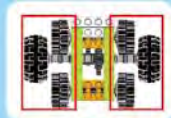
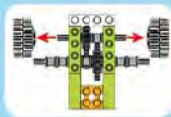
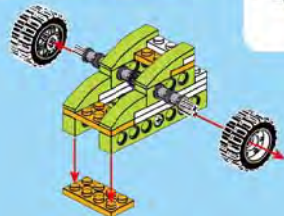
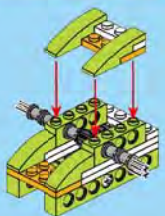

1 Push the trolley by hand

2 The car travels farther due to inertia

Tumbler

Assembly difficulty
☆☆☆☆☆

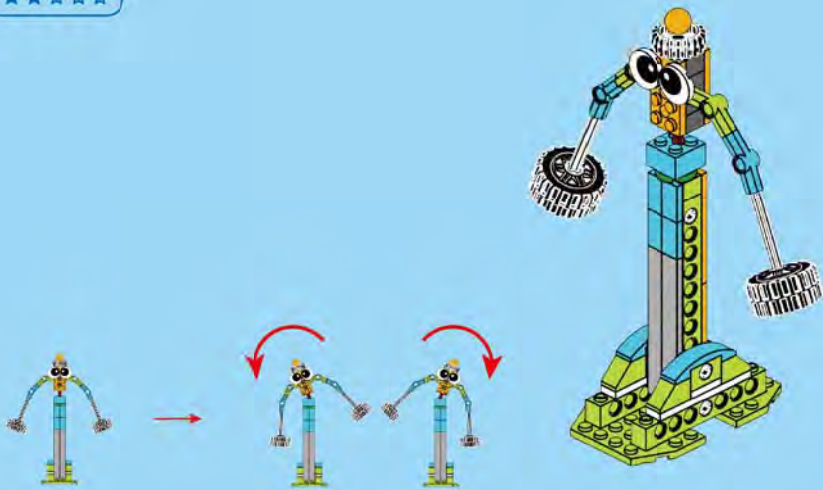

022

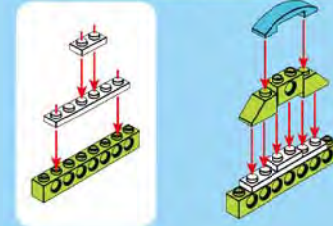
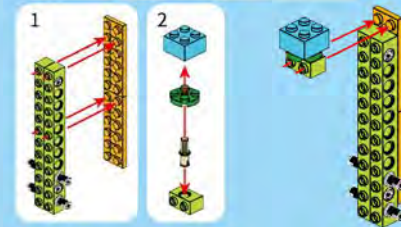
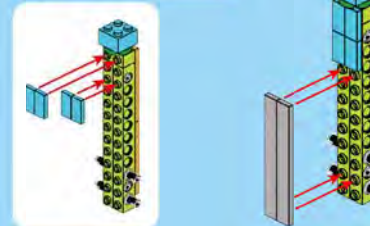
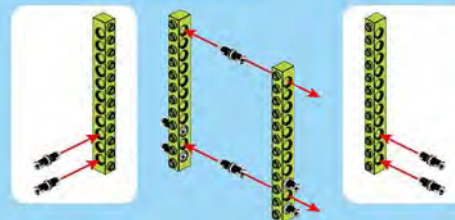

023

05

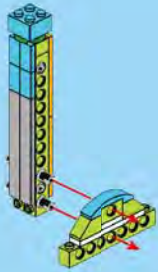

06

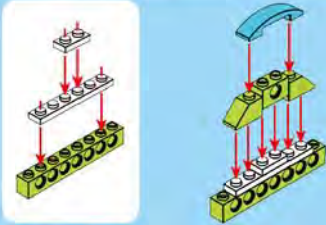

09

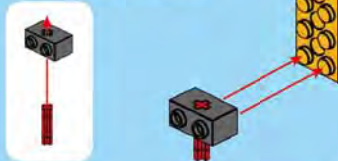

10

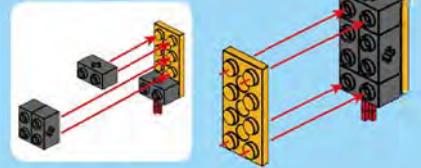

07

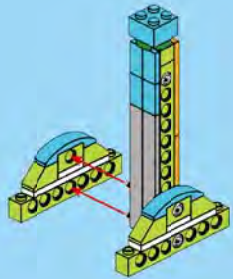

08

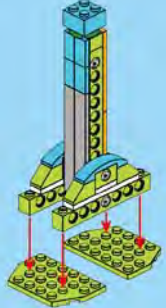

11

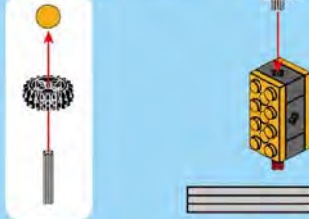

2 1:1

3 1:1

12

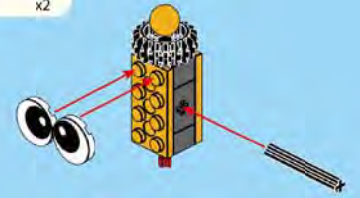

4 1:1

024

025

13

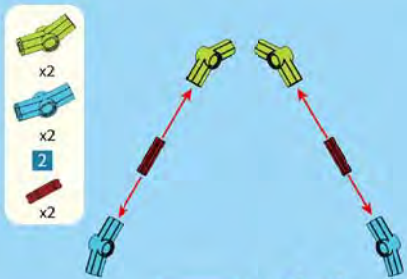

2 1:1

14



6 1:1

15

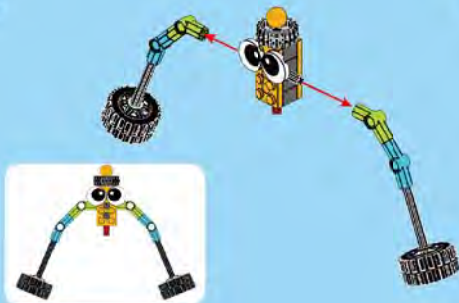

16

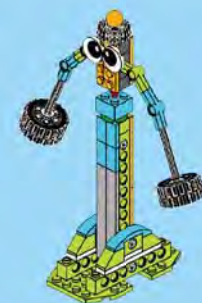
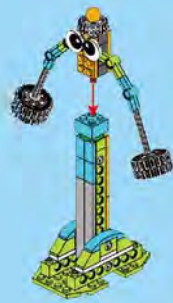

1 Toggle the tumbler

2 The tumbler swayed from side to side but will not fall.

Pivoting Fan

Assembly difficulty
★★★★☆

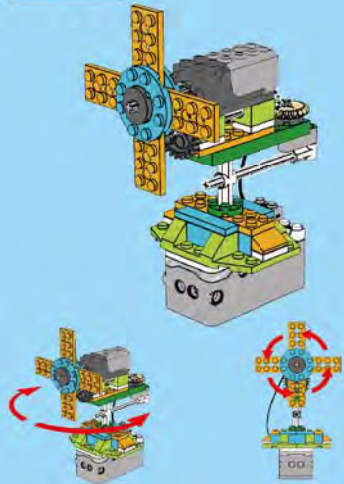

01 x1 x2 x1

02 x2 x2

Step 01 shows a grey 1x4 brick with holes being placed on a green 1x4 plate, which is then placed on a green 1x2 plate with a hole. This assembly is then placed on a grey motor base. Step 02 shows two blue 1x2 plates being placed on top of the assembly, with red arrows indicating they are being pushed down onto the grey motor base.

03 x4

05 x4

Step 03 shows four green 1x2 plates being placed on top of the assembly, with red arrows indicating they are being pushed down onto the grey motor base. Step 05 shows four blue 1x2 plates being placed on top of the assembly, with red arrows indicating they are being pushed down onto the grey motor base.

04 x2 x2

06 x1 x1

Step 04 shows two orange 1x2 plates and two white 1x2 plates being placed on top of the assembly, with red arrows indicating they are being pushed down onto the grey motor base. Step 06 shows a blue 2x6 plate and a green 1x2 plate with a hole being placed on top of the assembly, with red arrows indicating they are being pushed down onto the grey motor base.

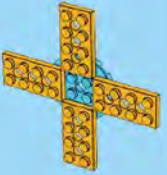
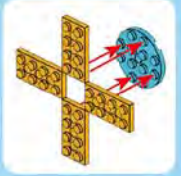
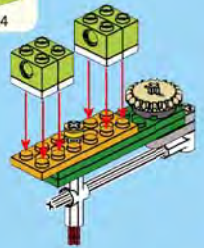
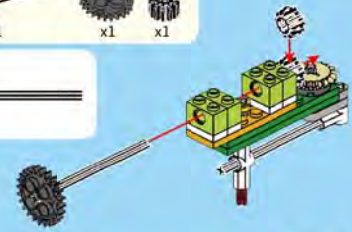
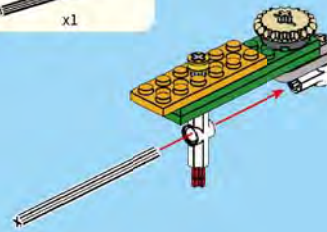
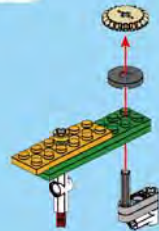
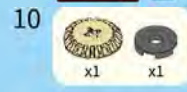
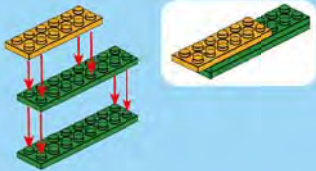

15

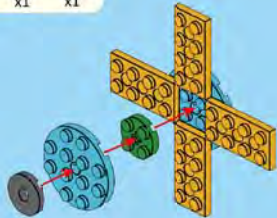

17

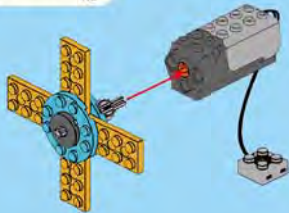

16

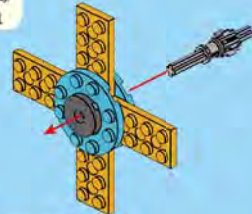

18

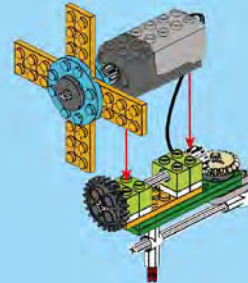

19

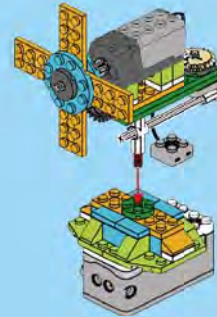

20

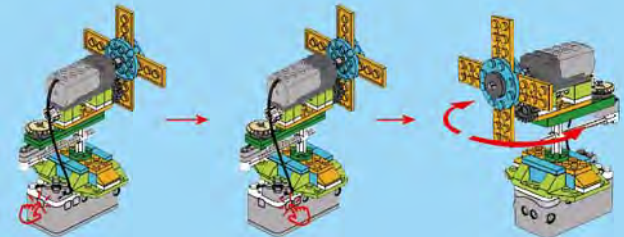
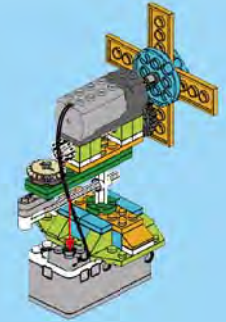

Electric Buhr Mill

Assembly difficulty
★★★★☆

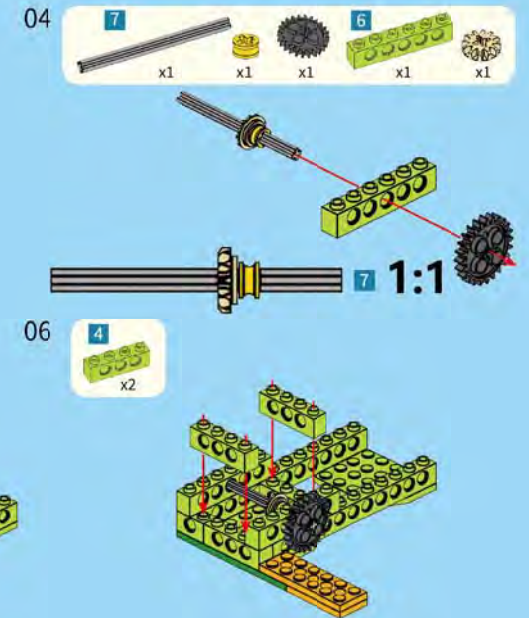
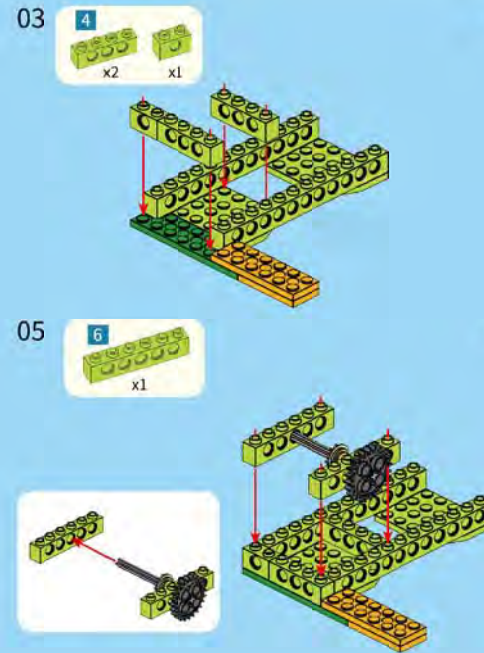
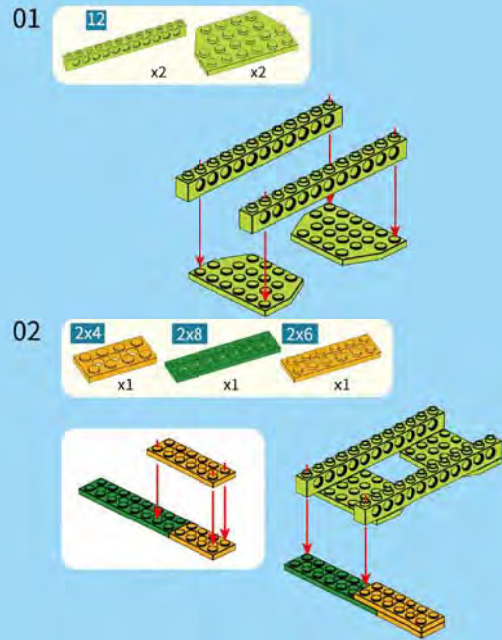
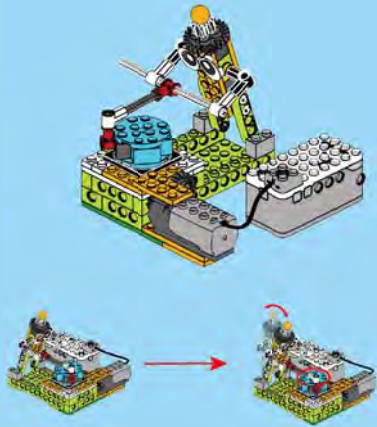

- 07 **1x4** **1x6**
x2 x2

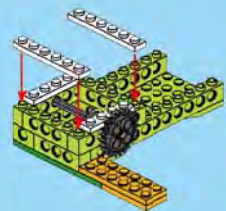
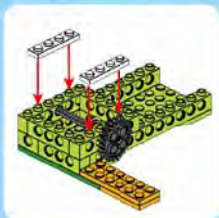

- 08 **2x4** **2x6**
x2 x1 x1 x1



- 09 **3**
x1 x1 x1



- 10 x1 x1 x3

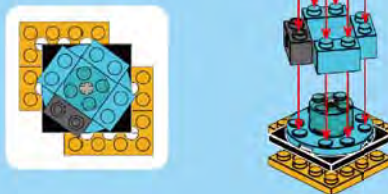

- 11 **2**
x1 x1 x1 x1

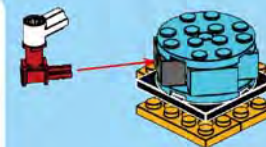

2 1:1

- 12 x4

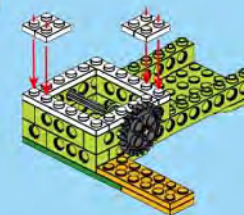

13

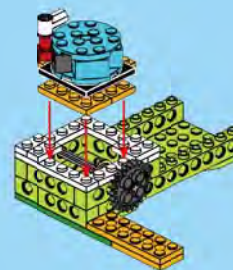

- 14 **2x6**
x2 x4 x1

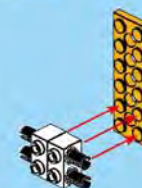
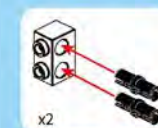

23

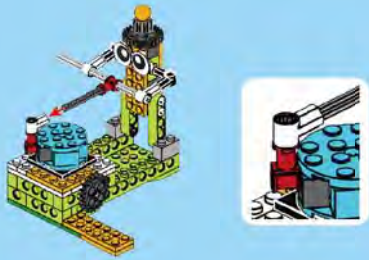

24

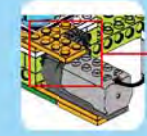
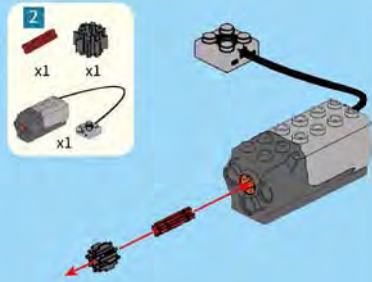

Gear Ratio 1:3

Change gear
See what's different



Gear Ratio 3:5

25

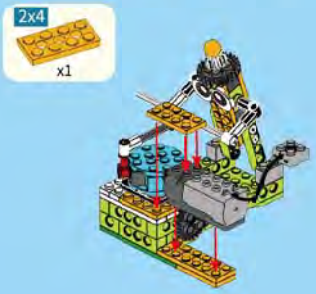

26

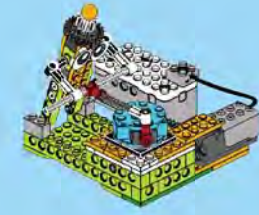
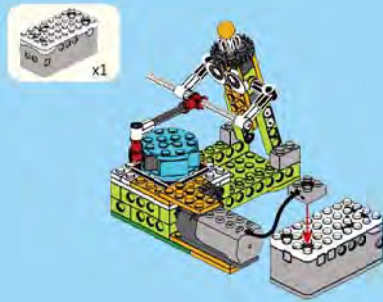

Tyrannosaurus

Assembly difficulty
★★★★★

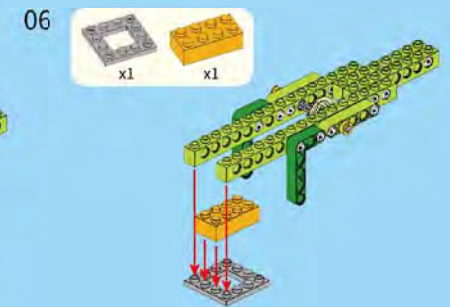
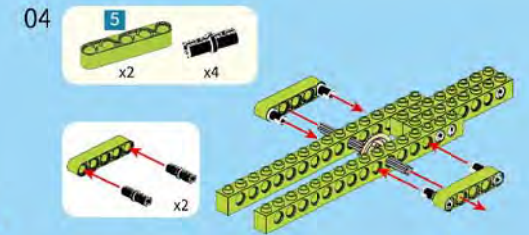
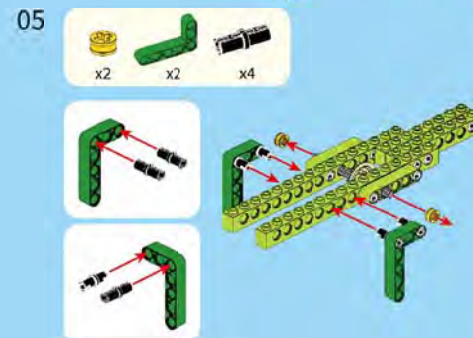
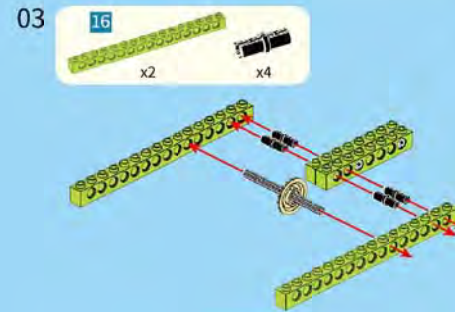
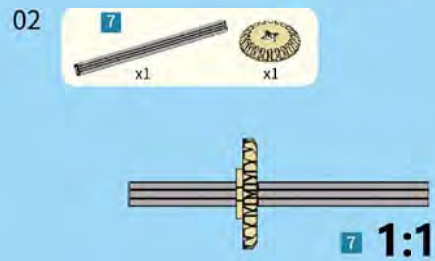
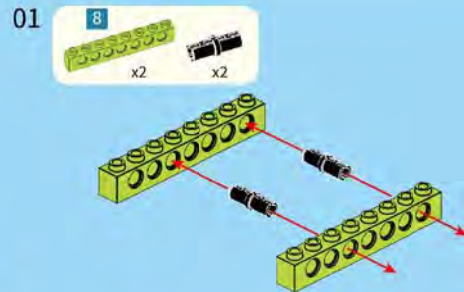

07

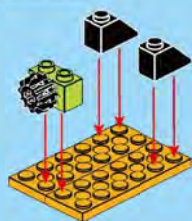

08

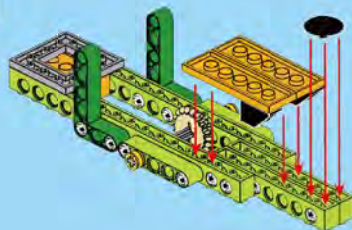

11

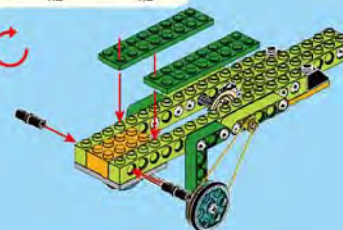

12

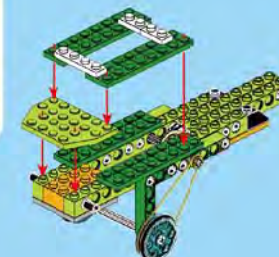

09

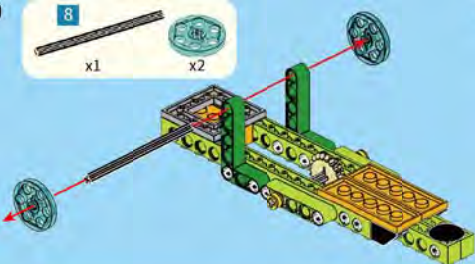

10

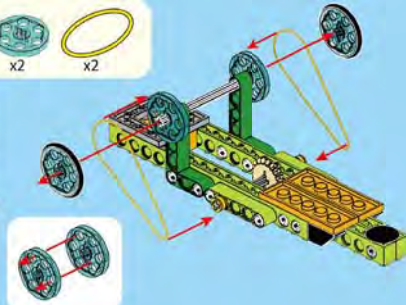

13

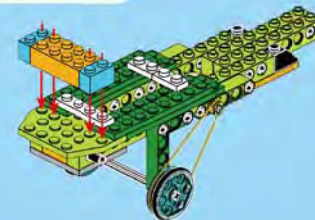

14

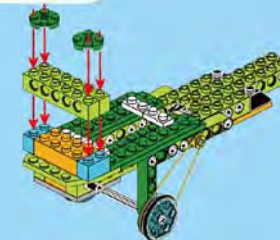

23



24



27

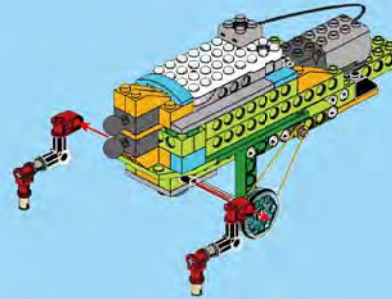

28

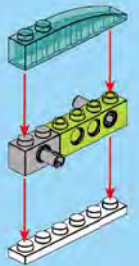
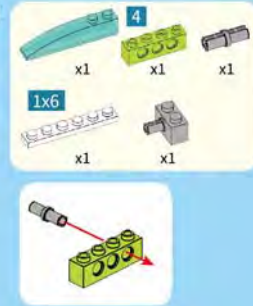

25

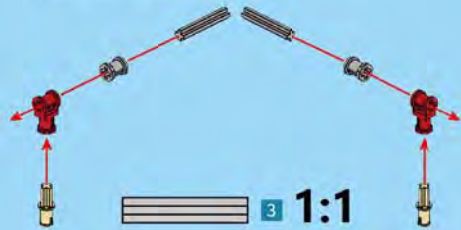

26



29

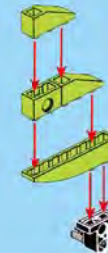

30

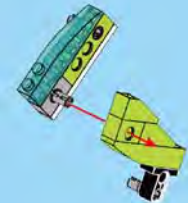

31

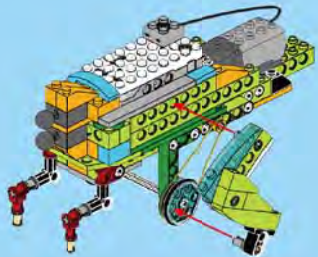

32

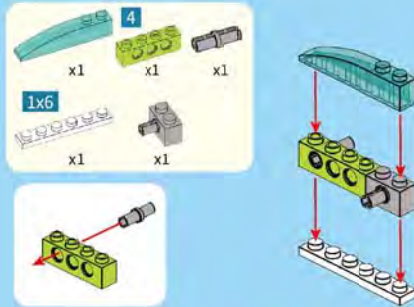

35

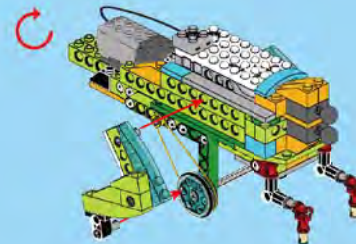

36

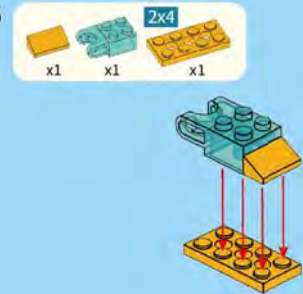

33

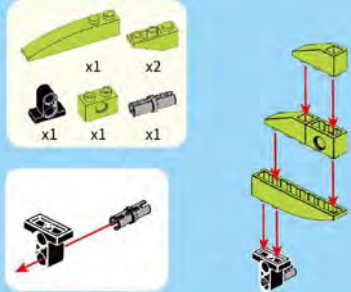

34

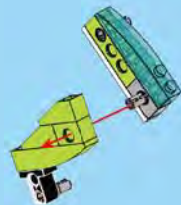

37

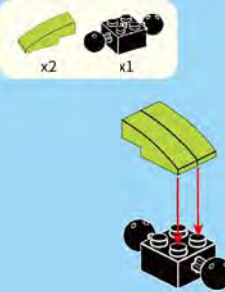

38

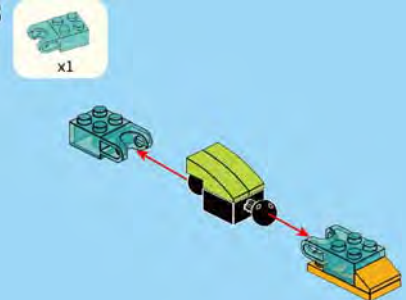

39

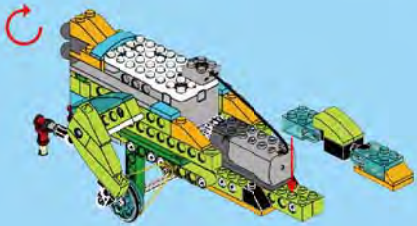

40

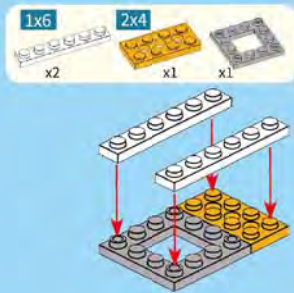

43

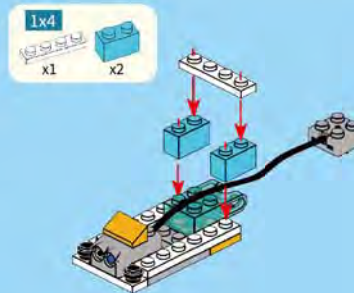

44

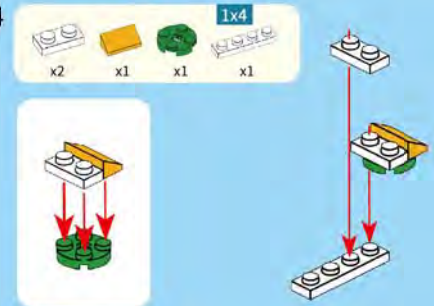

41

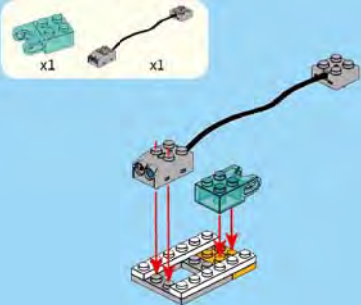

42

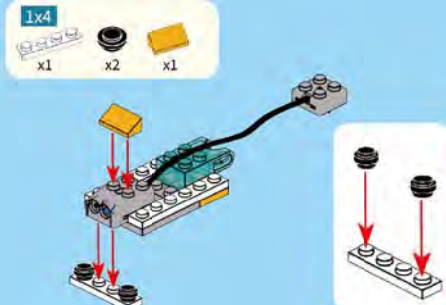

45

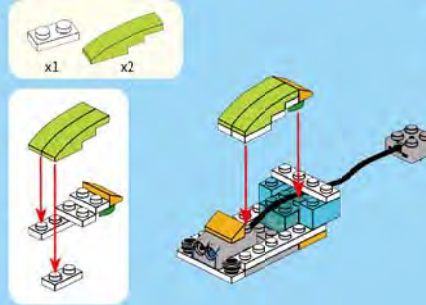

46

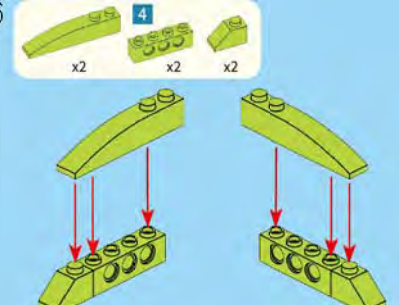

47

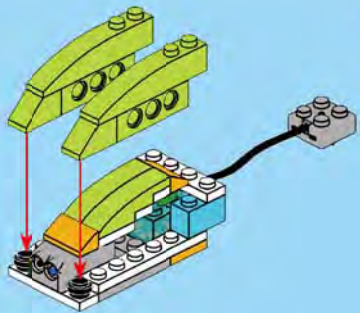

48

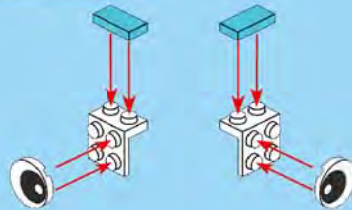

51



52

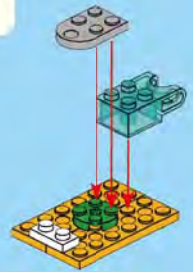

49

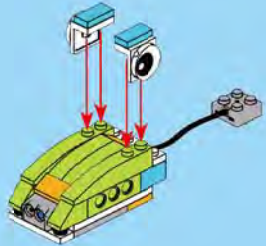

50

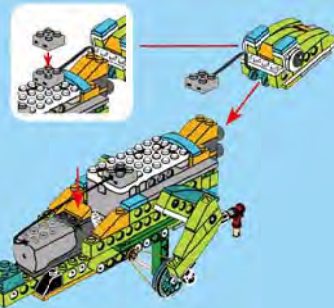

53

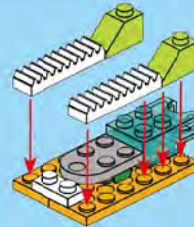

54

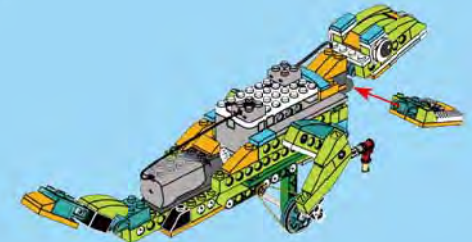

054

055

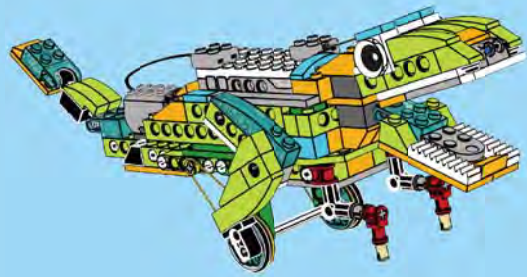

Building Block List

	x5		x4		x4		x2		x2		x4		x4
	x4		x6		x4		x2		x2		x8		x4
	x4		x2		x2		x2		x2		x8		x2
	x4		x2		x4		x2		x2		x2		x2
	x4		x2		x4		x4		x2		x2		x2
	x2		x2		x2		x13		x4		x2		x2
	x4		x2		x2		x16		x2		x2		x2
	x4		x2		x2		x6		x4		x4		x2
	x2		x4		x4		x4		x2		x2		x1
	x2		x4		x4		x4		x4		x2		x1
	x4		x4		x4		x4		x2		x4		x1
	x4		x4		x4		x4		x4		x4		x1
	x2		x2		x2		x4		x2		x2		x2
	x1		x2		x4		x4		x2		x2		x1

FAQ

Product Details

Product Name: Educational Building Block
Model No.: TD-Robot-EN
Power Supply: 2x AA batteries (not included)
Rated Power: 5W
Suitable for: 6 years old and above

The main control unit cannot be paired with APP?
Please check if the Bluetooth of your device is turned on. If the Bluetooth is off, please turn it on.
If the Bluetooth is turned on, please turn off the main control unit, then turn it on, and restart the APP, then try to connect to Bluetooth again.
Please check if the power of main control units is enough. If not, please replace the battery.

Warning! Do not aim at the eyes or face.

Warning! Do not use projectiles not provided by the manufacturer.

Warning! This product contains small accessories, it is not for children under 3 years old.

Warning! This product contains small balls, which may cause a choking hazard and is not suitable for children under three years of age.

The user manual contains important information, please keep it for future use.

Rechargeable batteries should be charged under the supervision of an adult.

Maintenance: This product shall not be used in water or a humid environment.

Remove surface strains with a dry cloth before use.

FCC ID: 2AMQS009A

FCC Compliance

This device complies with Part 15 of the FCC Rules. Operation is subject to the following two conditions: (1) this device may not cause harmful interference, and (2) this device must accept any interference received, including interference that may cause undesired operation.

Note: This equipment has been tested and found to comply with the limits for a Class B digital device, pursuant to Part 15 of the FCC Rules. These limits are designed to provide reasonable protection against harmful interference in a residential installation. This equipment generates, uses and can radiate radio frequency energy and, if not installed and used in accordance with the instructions, may cause harmful interference to radio communications. However, there is no guarantee that interference will not occur in a particular installation.

If this equipment does cause harmful interference to radio or television reception, which can be determined by turning the equipment off and on, the user is encouraged to try to correct the interference by one or more of the following measures:

- Reorient or relocate the receiving antenna.
- Increase the separation between the equipment and receiver.
- Connect the equipment into an outlet on a circuit different from that to which the receiver is connected.
- Consult the dealer or an experienced radio/TV technician for help.

Caution: changes or modifications not expressly approved by the party responsible for compliance could void the user's authority to operate the equipment.

