

APPLICATION CERTIFICATION FCC Part 15C
On Behalf of
Dongguan Esmooth Acoustic Technology Co., Ltd.

Wireless earphones

Model No.: A2, A3, A2-1, A2-2, A3-1, A3-2, X6 Plus, X6P, X5, X5S, C6P, C8, BH107

FCC ID: 2AMQI-A2

Prepared for : Dongguan Esmooth Acoustic Technology Co., Ltd.
Address : Xinzhou Industrial Zone, Xinhe Community, Wanjiang District,
Dongguan City, 523061, Guangdong Province, China

Prepared by : Shenzhen Accurate Technology Co., Ltd.
Address : 1/F., Building A, Changyuan New Material Port, Science & Industry
Park, Nanshan District, Shenzhen, Guangdong, P.R. China

Tel: (0755) 26503290
Fax: (0755) 26503396

Report No. : ATE20181594
Date of Test : August 31-September 3, 2018
Date of Report : September 3, 2018

TABLE OF CONTENTS

Description	Page
Test Report Certification	
TABLE OF CONTENTS	2
1. GENERAL INFORMATION	5
1.1. Description of Device (EUT).....	5
1.2. Accessory and Auxiliary Equipment	5
1.3. Description of Test Facility	6
1.4. Measurement Uncertainty	6
2. MEASURING DEVICE AND TEST EQUIPMENT	7
3. OPERATION OF EUT DURING TESTING	8
3.1. Operating Mode	8
3.2. Configuration and peripherals	8
4. TEST PROCEDURES AND RESULTS	9
5. 20DB BANDWIDTH TEST	10
5.1. Block Diagram of Test Setup.....	10
5.2. The Requirement For Section 15.247(a)(1).....	10
5.3. EUT Configuration on Measurement	10
5.4. Operating Condition of EUT	10
5.5. Test Procedure	10
5.6. Test Result	11
6. CARRIER FREQUENCY SEPARATION TEST	16
6.1. Block Diagram of Test Setup.....	16
6.2. The Requirement For Section 15.247(a)(1).....	16
6.3. EUT Configuration on Measurement	16
6.4. Operating Condition of EUT	16
6.5. Test Procedure	17
6.6. Test Result	17
7. NUMBER OF HOPPING FREQUENCY TEST	23
7.1. Block Diagram of Test Setup.....	23
7.2. The Requirement For Section 15.247(a)(1)(iii).....	23
7.3. EUT Configuration on Measurement	23
7.4. Operating Condition of EUT	23
7.5. Test Procedure	23
7.6. Test Result	24
8. DWELL TIME TEST	26
8.1. Block Diagram of Test Setup.....	26
8.2. The Requirement For Section 15.247(a)(1)(iii).....	26
8.3. EUT Configuration on Measurement	26
8.4. Operating Condition of EUT	26
8.5. Test Procedure	26
8.6. Test Result	27
9. MAXIMUM PEAK OUTPUT POWER TEST	33
9.1. Block Diagram of Test Setup.....	33

9.2.	The Requirement For Section 15.247(b)(1).....	33
9.3.	EUT Configuration on Measurement	33
9.4.	Operating Condition of EUT	33
9.5.	Test Procedure	33
9.6.	Test Result	34
10.	RADIATED EMISSION TEST	40
10.1.	Block Diagram of Test Setup.....	40
10.2.	The Limit For Section 15.247(d)	41
10.3.	Restricted bands of operation	42
10.4.	Configuration of EUT on Measurement	42
10.5.	Operating Condition of EUT	43
10.6.	Test Procedure	43
10.7.	Data Sample.....	44
10.8.	The Field Strength of Radiation Emission Measurement Results	44
11.	BAND EDGE COMPLIANCE TEST	57
11.1.	Block Diagram of Test Setup.....	57
11.2.	The Requirement For Section 15.247(d)	57
11.3.	EUT Configuration on Measurement	57
11.4.	Operating Condition of EUT	57
11.5.	Test Procedure	58
11.6.	Test Result	58
12.	AC POWER LINE CONDUCTED EMISSION FOR FCC PART 15 SECTION 15.207(A) ..	69
12.1.	Block Diagram of Test Setup.....	69
12.2.	Power Line Conducted Emission Measurement Limits.....	70
12.3.	Configuration of EUT on Measurement	70
12.4.	Operating Condition of EUT	70
12.5.	Test Procedure	70
12.6.	Data Sample.....	71
12.7.	Power Line Conducted Emission Measurement Results	71
13.	ANTENNA REQUIREMENT.....	74
13.1.	The Requirement	74
13.2.	Antenna Construction	74

Test Report Certification

Applicant : Dongguan Esmooth Acoustic Technology Co., Ltd.
Manufacturer : KINGVIE TECHNOLOGY CO., LIMITED
EUT Description : Wireless earphones
Model No. : A2, A3, A2-1, A2-2, A3-1, A3-2, X6 Plus, X6P, X5, X5S, C6P, C8,
BH107
Brand Name : Inopera

Measurement Procedure Used:

FCC Rules and Regulations Part 15 Subpart C Section 15.247: 2018 ANSI C63.10: 2013

The device described above is tested by Shenzhen Accurate Technology Co., Ltd. to determine the maximum emission levels emanating from the device. The maximum emission levels are compared to the FCC Part 15 Subpart C Section 15.247 limits. The measurement results are contained in this test report and Shenzhen Accurate Technology Co., Ltd. is assumed full responsibility for the accuracy and completeness of these measurements. Also, this report shows that the Equipment Under Test (EUT) is to be technically compliant with the FCC requirements.

This report applies to above tested sample only. This report shall not be reproduced in part without written approval of Shenzhen Accurate Technology Co., Ltd.

Date of Test : August 31-September 3, 2018
Date of Report : September 3, 2018

Test Engineer : 
(Bob Wang, Engineer)

Prepared by : 
(Bob Wang, Engineer)

Approved & Authorized Signer : 
(Sean Liu, Manager)



1. GENERAL INFORMATION

1.1. Description of Device (EUT)

Model Number	: A2, A3, A2-1, A2-2, A3-1, A3-2, X6 Plus, X6P, X5, X5S, C6P, C8, BH107 (Note: These samples are same except their appearance is different. So we prepare A2 for test only.)
Bluetooth version	: V 4.1
Frequency Range	: 2402MHz-2480MHz
Number of Channels	: 79
Antenna Gain(Max)	: 2.5dBi
Antenna type	: Integral Antenna
Adapter Input Voltage	: DC 3.7V (Powered by Lithium battery) or DC 5V (Powered by USB port)
Modulation mode	: GFSK, $\pi/4$ DQPSK, 8DPSK
Hardware version	: HYH-H3-8635-V2.01
Software version	: JWHT_HONGMI_8635_V2.0
Applicant Address	: Dongguan Esmooth Acoustic Technology Co., Ltd. Xinzhou Industrial Zone, Xinhe Community, Wanjiang District, Dongguan City, 523061, Guangdong Province, China
Manufacturer Address	: KINGVIE TECHNOLOGY CO., LIMITED No.240, Fuqian Road, Xintang village, Guanlan town, Longhua New district, Shenzhen, China

1.2. Accessory and Auxiliary Equipment

Adapter:	Model:BEK-QC-001 INPUT: 120V~60Hz OUTPUT:5V/1A
----------	--

1.3. Description of Test Facility

- EMC Lab : Recognition of accreditation by Federal Communications Commission (FCC)
The Designation Number is CN1189
The Registration Number is 708358
- Listed by Innovation, Science and Economic Development Canada (ISED)
The Registration Number is 5077A-2
- Accredited by China National Accreditation Service for Conformity Assessment (CNAS)
The Registration Number is CNAS L3193
- Accredited by American Association for Laboratory Accreditation (A2LA)
The Certificate Number is 4297.01
- Name of Firm : Shenzhen Accurate Technology Co., Ltd.
- Site Location : 1/F., Building A, Changyuan New Material Port, Science & Industry Park, Nanshan District, Shenzhen, Guangdong, P.R. China

1.4. Measurement Uncertainty

- Conducted Emission Expanded Uncertainty = 2.23dB, k=2
- Radiated emission expanded uncertainty (9kHz-30MHz) = 3.08dB, k=2
- Radiated emission expanded uncertainty (30MHz-1000MHz) = 4.42dB, k=2
- Radiated emission expanded uncertainty (Above 1GHz) = 4.06dB, k=2

2. MEASURING DEVICE AND TEST EQUIPMENT

Table 1: List of Test and Measurement Equipment

Kind of equipment	Manufacturer	Type	S/N	Calibrated dates	Calibrated until
EMI Test Receiver	Rohde&Schwarz	ESCS30	100307	Jan. 06, 2018	1 Year
EMI Test Receiver	Rohde&Schwarz	ESPI3	101526/003	Jan. 06, 2018	1 Year
Spectrum Analyzer	Agilent	E7405A	MY45115511	Jan. 06, 2018	1 Year
Pre-Amplifier	Rohde&Schwarz	CBLU1183540-01	3791	Jan. 06, 2018	1 Year
Loop Antenna	Schwarzbeck	FMZB1516	1516131	Jan. 06, 2018	1 Year
Bilog Antenna	Schwarzbeck	VULB9163	9163-323	Jan. 06, 2018	1 Year
Horn Antenna	Schwarzbeck	BBHA9120D	9120D-655	Jan. 06, 2018	1 Year
Horn Antenna	Schwarzbeck	BBHA9170	9170-359	Jan. 06, 2018	1 Year
LISN	Rohde&Schwarz	ESH3-Z5	100305	Jan. 06, 2018	1 Year
LISN	Schwarzbeck	NSLK8126	8126431	Jan. 06, 2018	1 Year
Highpass Filter	Wainwright Instruments	WHKX3.6/18G-10SS	N/A	Jan. 06, 2018	1 Year
Band Reject Filter	Wainwright Instruments	WRCG2400/2485-2375/2510-60/11SS	N/A	Jan. 06, 2018	1 Year
RF COAXIAL CABLE	SUHNER	N-5m(Frequency range:9KHz-26.5GHz)	NO.3	Jan. 06, 2018	1 Year
RF COAXIAL CABLE	SUHNER	N-5m(Frequency range:9KHz-26.5GHz)	NO.4	Jan. 06, 2018	1 Year
RF COAXIAL CABLE	SUHNER	N-1m(Frequency range:9KHz-26.5GHz)	NO.5	Jan. 06, 2018	1 Year
RF COAXIAL CABLE	SUHNER	N-1m(Frequency range:9KHz-26.5GHz)	NO.6	Jan. 06, 2018	1 Year
Temporary antenna connector	NTGS	14AE	N/A	March 21, 2018	N/A

Note: The temporary antenna connector is soldered on the PCB board in order to perform conducted tests and this temporary antenna connector is listed in the equipment list.

3. OPERATION OF EUT DURING TESTING

3.1. Operating Mode

The mode is used: Transmitting mode

Low Channel: 2402MHz

Middle Channel: 2441MHz

High Channel: 2480MHz

Hopping

Note: The equipment under test (EUT) was tested under fully-charged battery.
The Bluetooth has been tested under continuous transmission mode.

3.2. Configuration and peripherals

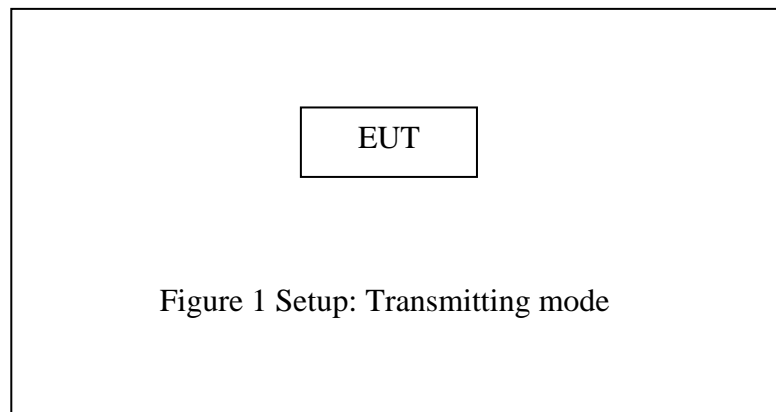

4. TEST PROCEDURES AND RESULTS

FCC Rules	Description of Test	Result
Section 15.207	Conducted Emission Test	Compliant
Section 15.247(a)(1)	20dB Bandwidth Test	Compliant
Section 15.247(a)(1)	Carrier Frequency Separation Test	Compliant
Section 15.247(a)(1)(iii)	Number Of Hopping Frequency Test	Compliant
Section 15.247(a)(1)(iii)	Dwell Time Test	Compliant
Section 15.247(b)(1)	Maximum Peak Output Power Test	Compliant
Section 15.247(d) Section 15.209	Radiated Emission Test	Compliant
Section 15.247(d)	Band Edge Compliance Test	Compliant
Section 15.203	Antenna Requirement	Compliant

5. 20DB BANDWIDTH TEST

5.1. Block Diagram of Test Setup

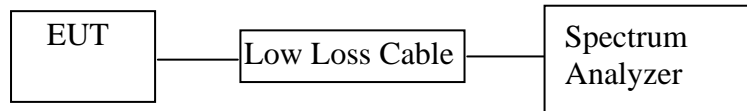

(EUT: Wireless earphones)

5.2. The Requirement For Section 15.247(a)(1)

Section 15.247(a)(1): Frequency hopping systems shall have hopping channel carrier frequencies separated by a minimum of 25 kHz or the 20 dB bandwidth of the hopping channel, whichever is greater.

5.3. EUT Configuration on Measurement

The equipment are installed on the emission measurement to meet the commission requirements and operating regulations in a manner which tends to maximize its emission characteristics in normal application.

5.4. Operating Condition of EUT

5.4.1. Setup the EUT and simulator as shown as Section 5.1.

5.4.2. Turn on the power of all equipment.

5.4.3. Let the EUT work in TX (Hopping off) modes measure it. The transmit frequency are 2402-2480MHz. We select 2402MHz, 2441MHz, and 2480MHz TX frequency to transmit.

5.5. Test Procedure

5.5.1. The transmitter output was connected to the spectrum analyzer through a low loss cable.

5.5.2. Set RBW of spectrum analyzer to 100 kHz and VBW to 300 kHz.

5.5.3. The 20dB bandwidth is defined as the total spectrum the power of which is higher than peak power minus 20dB.

5.6. Test Result

Test Lab: Shielding room
Test Engineer: Bob

Channel	Frequency (MHz)	GFSK 20dB Bandwidth (MHz)	$\Pi/4$ -DQPSK 20dB Bandwidth (MHz)	8DPSK 20dB Bandwidth (MHz)	Result
Low	2402	1.104	1.338	1.320	Pass
Middle	2441	1.086	1.362	1.392	Pass
High	2480	1.098	1.368	1.368	Pass

The spectrum analyzer plots are attached as below.

GFSK Mode

Low channel

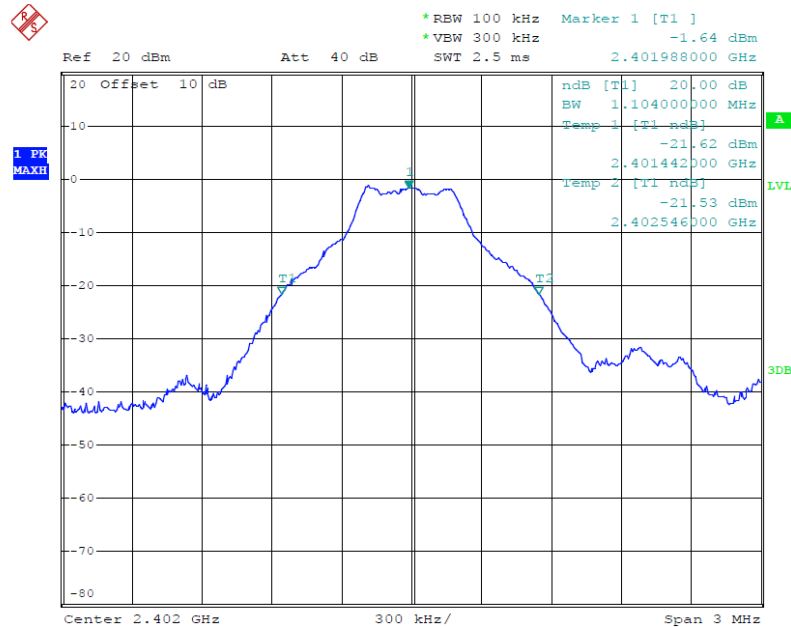

Date: 3.SEP.2018 15:47:40

Middle channel

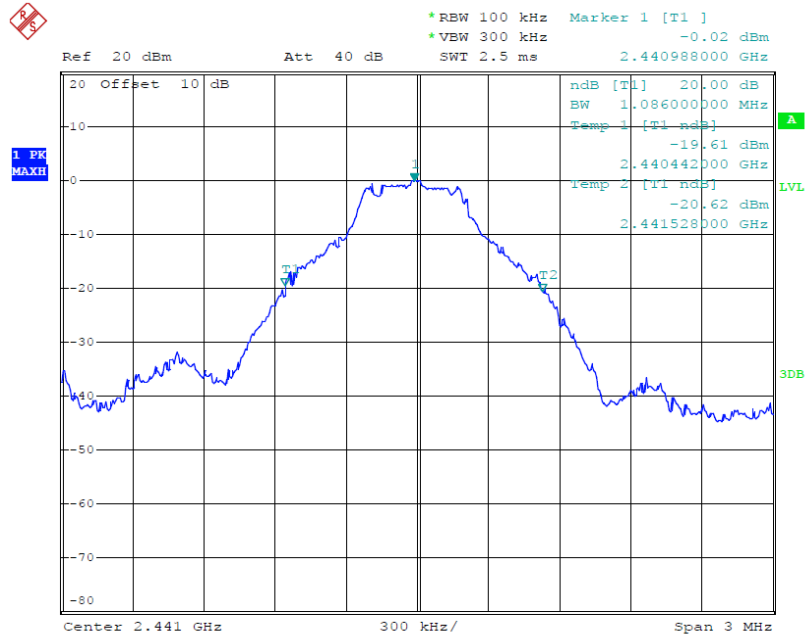

Date: 3.SEP.2018 15:50:19

High channel

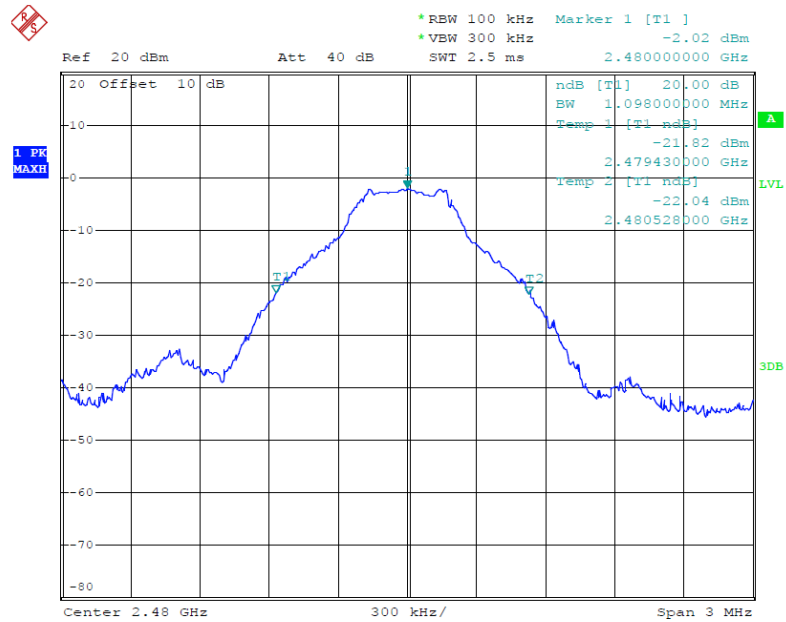

Date: 3.SEP.2018 15:52:45

Π/4-DQPSK Mode

Low channel

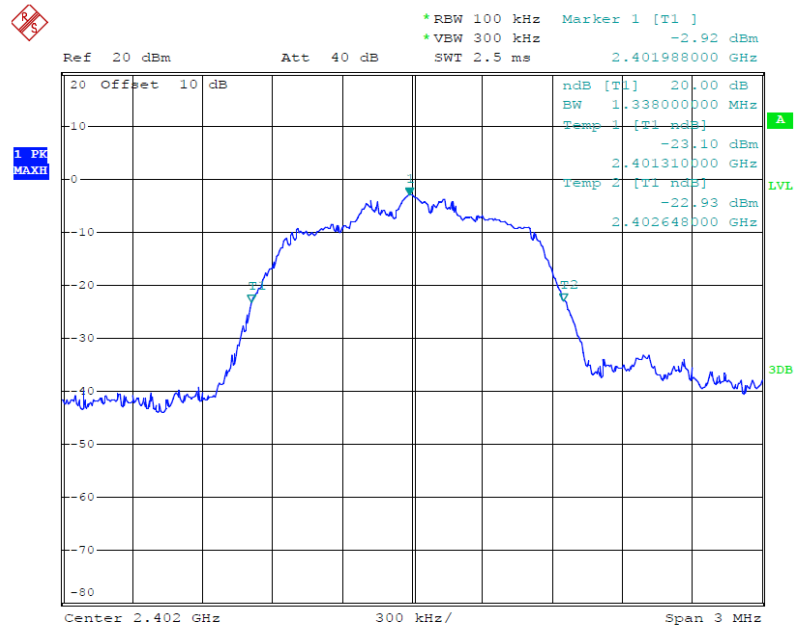

Date: 3.SEP.2018 15:48:50

Middle channel

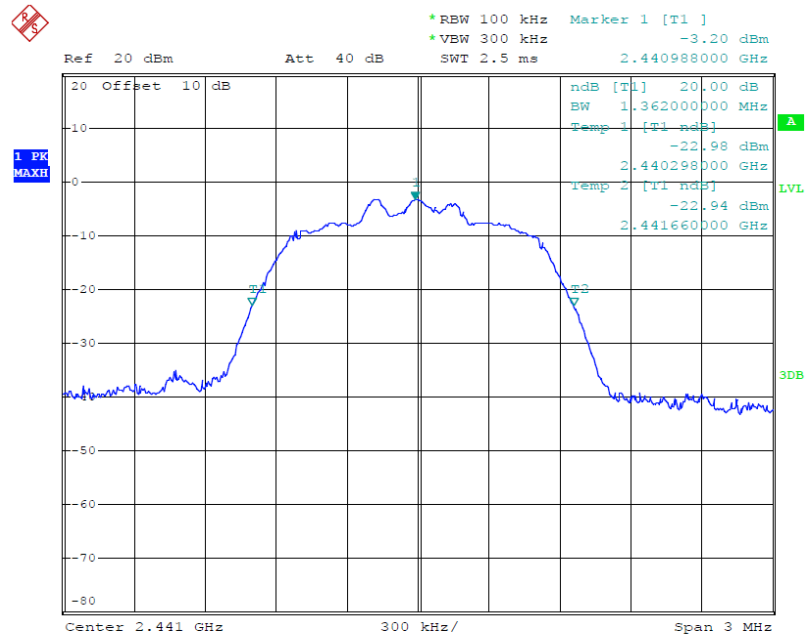

Date: 3.SEP.2018 15:50:58

High channel

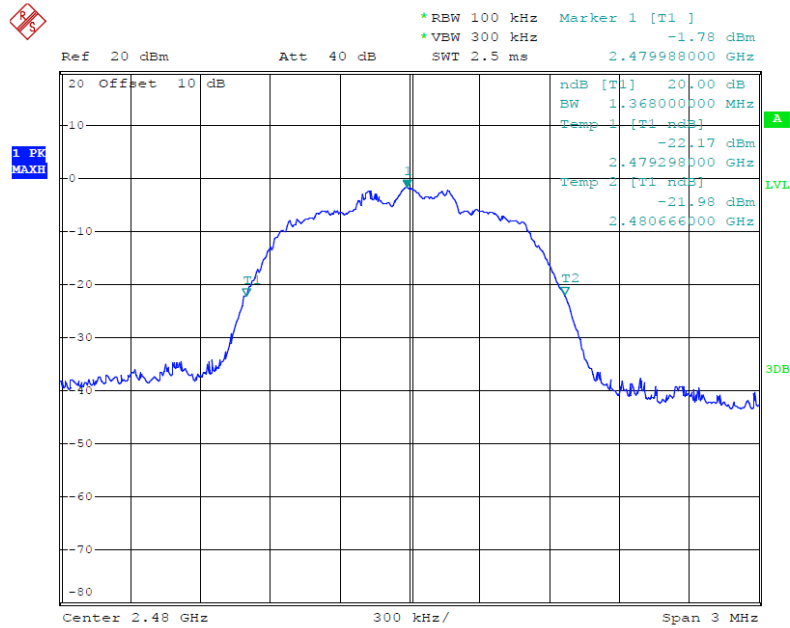

Date: 3.SEP.2018 15:53:24

8DPSK Mode

Low channel

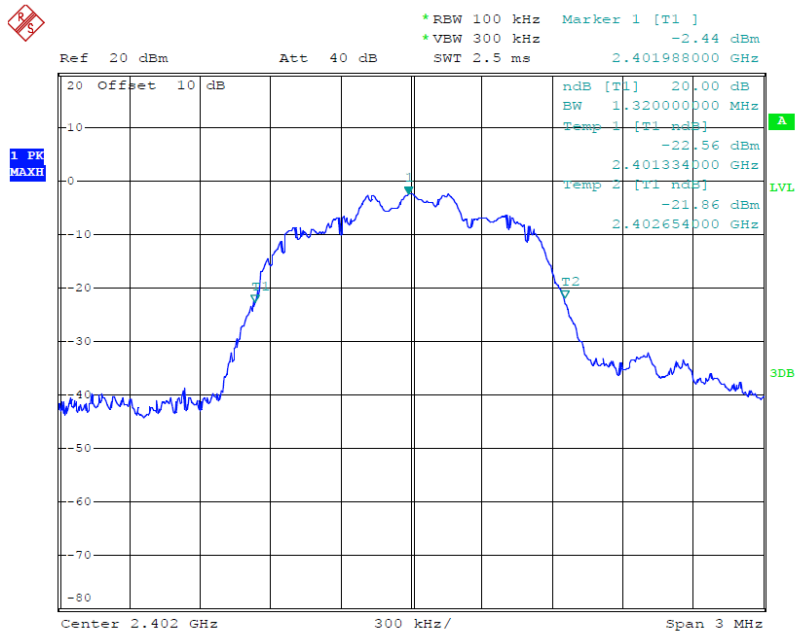

Date: 3.SEP.2018 15:49:23

Middle channel

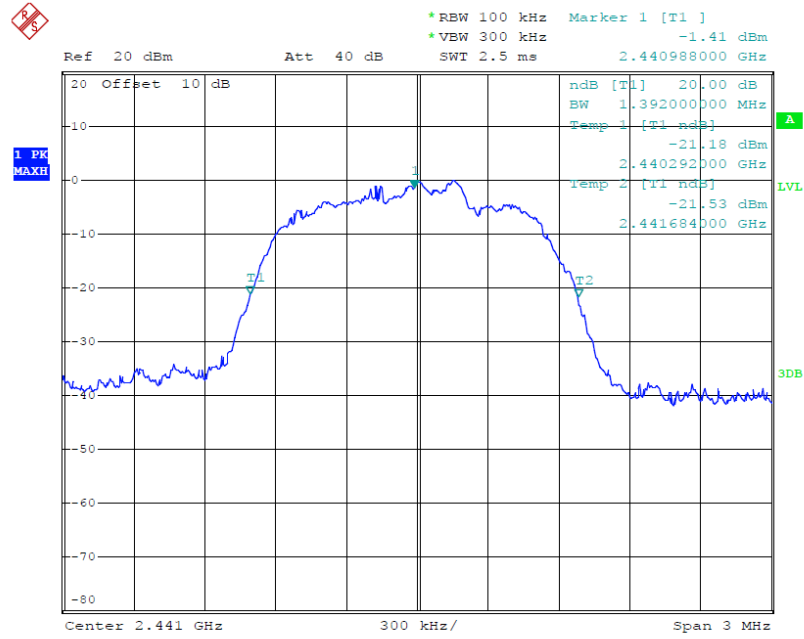

Date: 3.SEP.2018 15:51:36

High channel

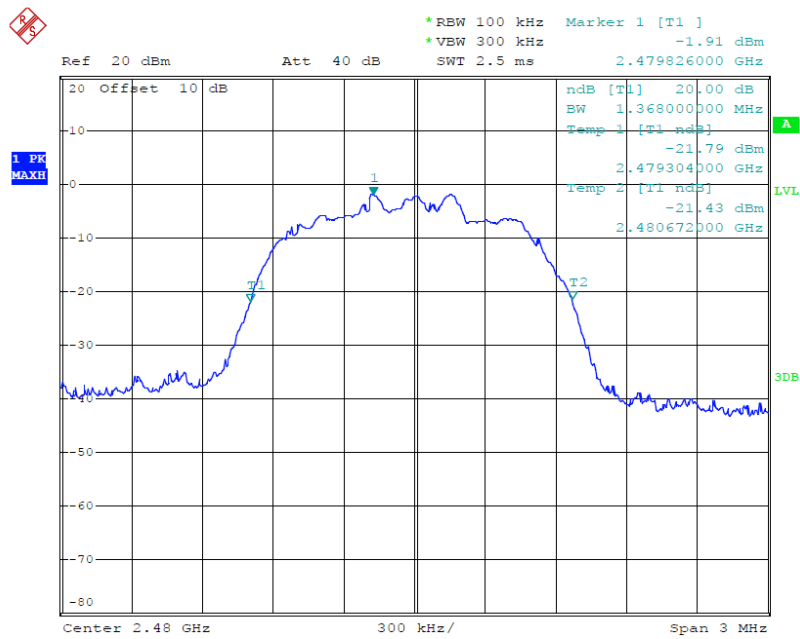

Date: 3.SEP.2018 15:54:11

6. CARRIER FREQUENCY SEPARATION TEST

6.1. Block Diagram of Test Setup

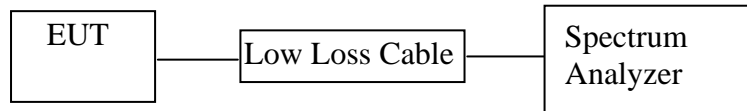

(EUT: Wireless earphones)

6.2. The Requirement For Section 15.247(a)(1)

Section 15.247(a)(1): Frequency hopping systems shall have hopping channel carrier frequencies separated by a minimum of 25 kHz or the 20 dB bandwidth of the hopping channel, whichever is greater. Alternatively, frequency hopping systems operating in the 2400-2483.5 MHz band may have hopping channel carrier frequencies that are separated by 25 kHz or two-thirds of the 20 dB bandwidth of the hopping channel, whichever is greater, provided the systems operate with an output power no greater than 125 mW. The system shall hop to channel frequencies that are selected at the system hopping rate from a pseudorandomly ordered list of hopping frequencies. Each frequency must be used equally on the average by each transmitter. The system receivers shall have input bandwidths that match the hopping channel bandwidths of their corresponding transmitters and shall shift frequencies in synchronization with the transmitted signals.

6.3. EUT Configuration on Measurement

The equipment are installed on the emission measurement to meet the commission requirements and operating regulations in a manner which tends to maximize its emission characteristics in normal application.

6.4. Operating Condition of EUT

6.4.1. Setup the EUT and simulator as shown as Section 6.1.

6.4.2. Turn on the power of all equipment.

6.4.3. Let the EUT work in TX (Hopping on) modes measure it. The transmit frequency are 2402-2480MHz. We select 2402MHz, 2441MHz, and 2480MHz TX frequency to transmit.

6.5. Test Procedure

6.5.1. The transmitter output was connected to the spectrum analyzer through a low loss cable.

6.5.2. Set RBW of spectrum analyzer to 30 kHz and VBW to 100 kHz. Adjust Span to 2MHz.

6.5.3. Set the adjacent channel of the EUT Maxhold another trace.

6.5.4. Measurement the channel separation

6.6. Test Result

Test Lab: Shielding room

Test Engineer: Bob

GFSK

Channel	Frequency (MHz)	Channel Separation(MHz)	Limit (MHz)	Result
Low	2402	1.002	25KHz or 2/3*20dB bandwidth	PASS
	2403			
Middle	2440	1.002	25KHz or 2/3*20dB bandwidth	PASS
	2441			
High	2479	1.008	25KHz or 2/3*20dB bandwidth	PASS
	2480			

Π/4-DQPSK

Channel	Frequency (MHz)	Channel Separation(MHz)	Limit (MHz)	Result
Low	2402	1.002	25KHz or 2/3*20dB bandwidth	PASS
	2403			
Middle	2440	1.008	25KHz or 2/3*20dB bandwidth	PASS
	2441			
High	2479	1.008	25KHz or 2/3*20dB bandwidth	PASS
	2480			

8DPSK

Channel	Frequency (MHz)	Channel Separation(MHz)	Limit (MHz)	Result
Low	2402	1.002	25KHz or 2/3*20dB bandwidth	PASS
	2403			
Middle	2440	1.008	25KHz or 2/3*20dB bandwidth	PASS
	2441			
High	2479	1.002	25KHz or 2/3*20dB bandwidth	PASS
	2480			

GFSK Mode

Low channel

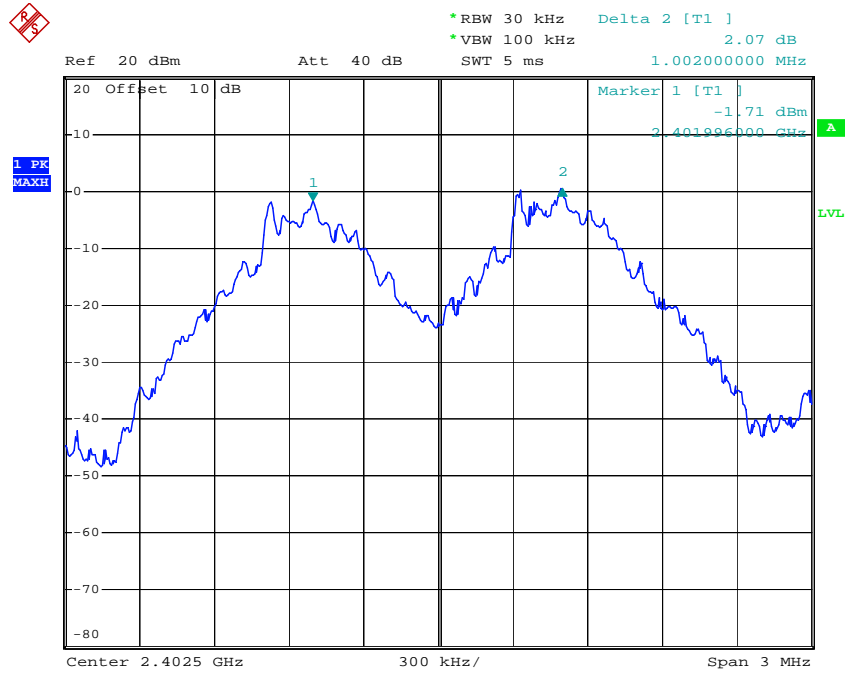

Comment A:
Date: 3.SEP.2018 10:56:04

Middle channel

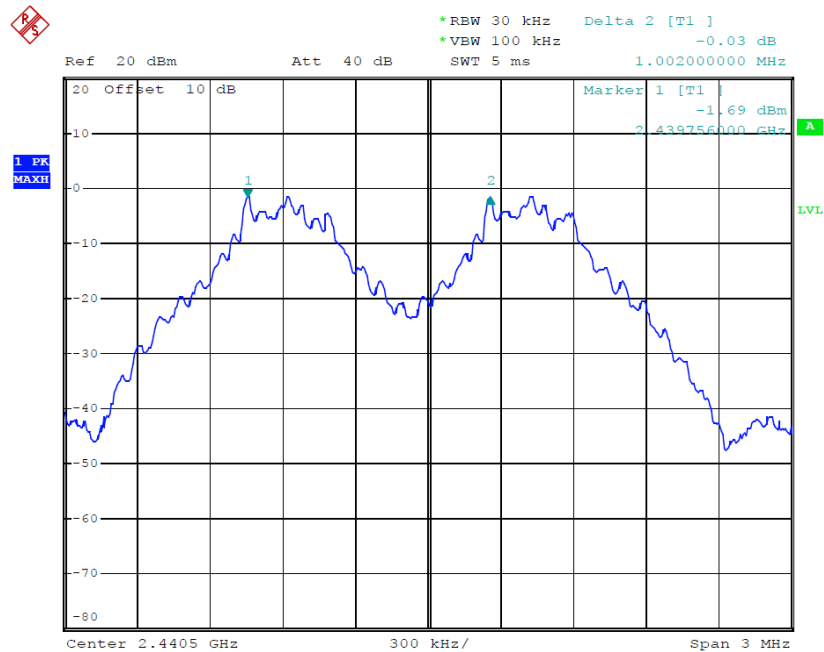

Comment A:
Date: 3.SEP.2018 10:37:23

High channel

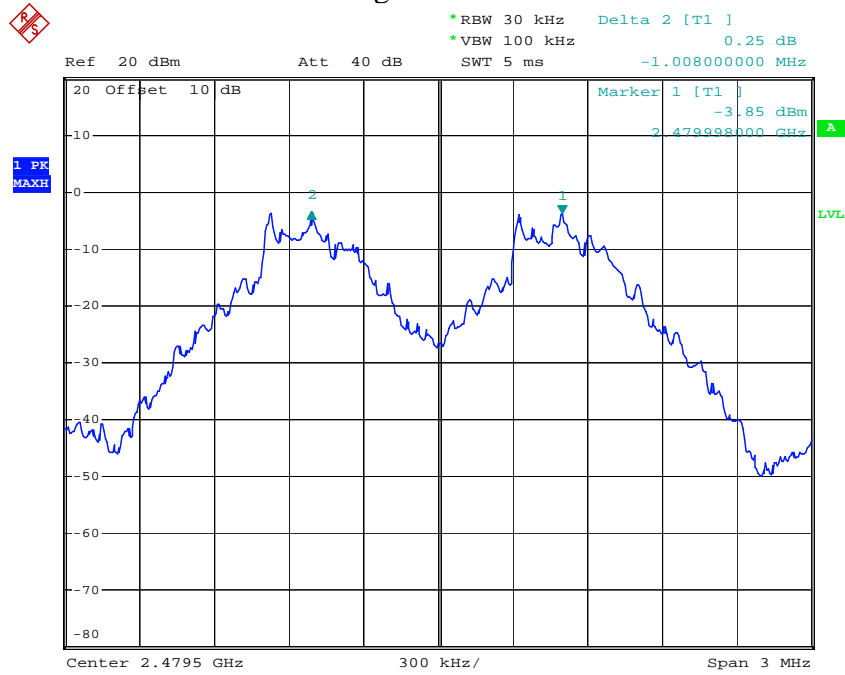

Comment A:
Date: 3.SEP.2018 10:57:57

Π/4-DQPSK Mode

Low channel

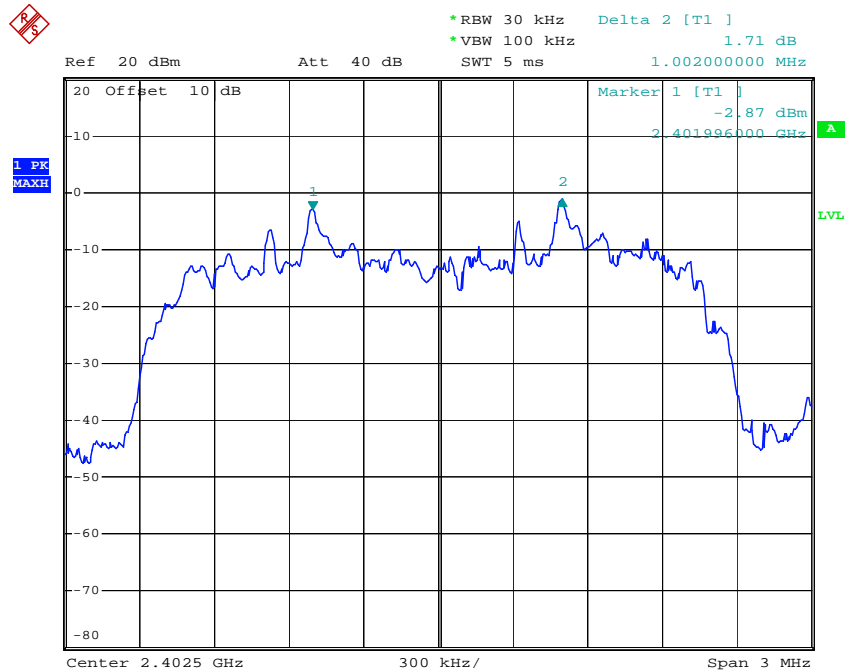

Comment A:
Date: 3.SEP.2018 11:00:46

Middle channel

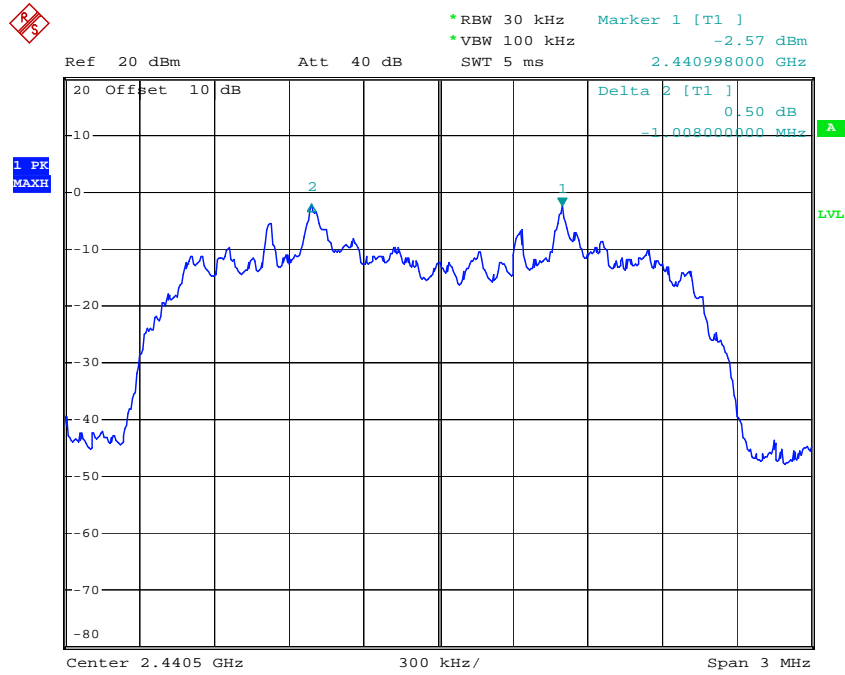

Comment A:
Date: 3.SEP.2018 10:59:56

High channel

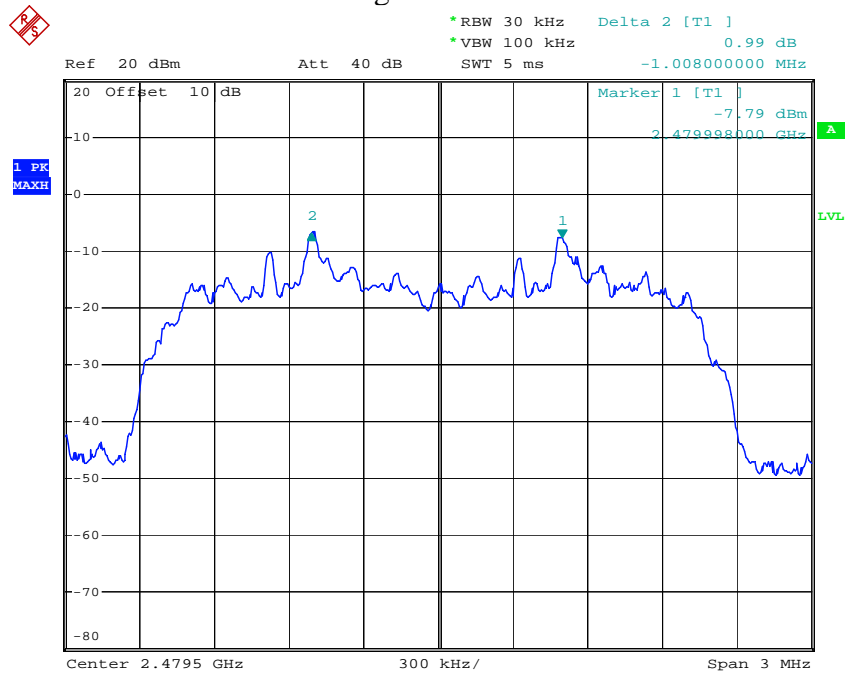

Comment A:
Date: 3.SEP.2018 10:59:02

8DPSK Mode

Low channel

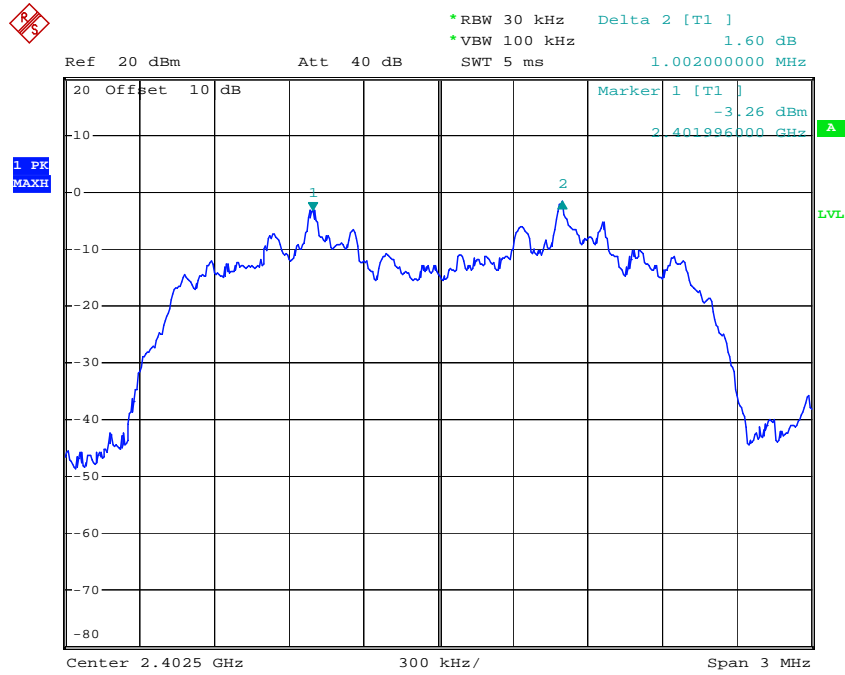

Comment A:
Date: 3.SEP.2018 11:01:44

Middle channel

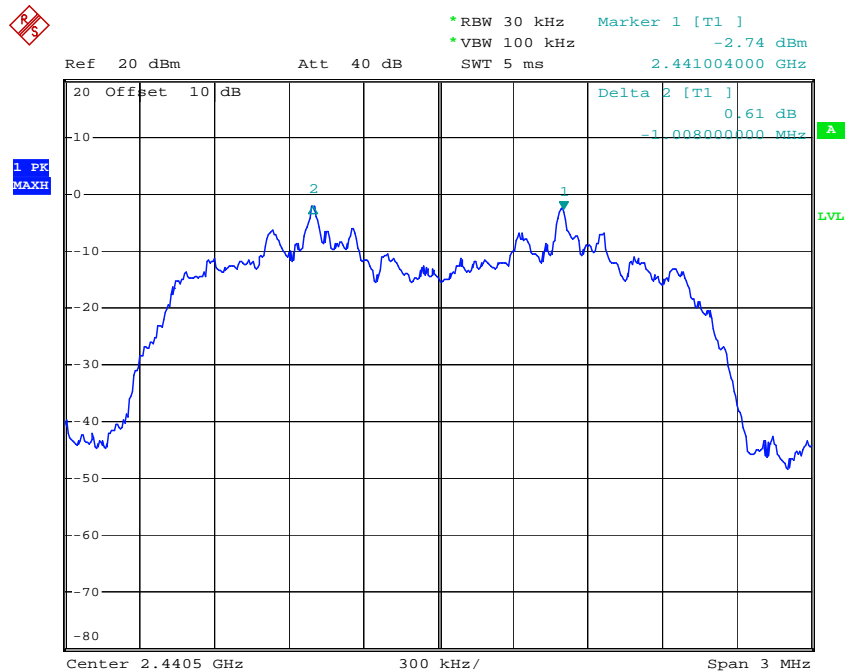

Comment A:
Date: 3.SEP.2018 11:02:40

High channel

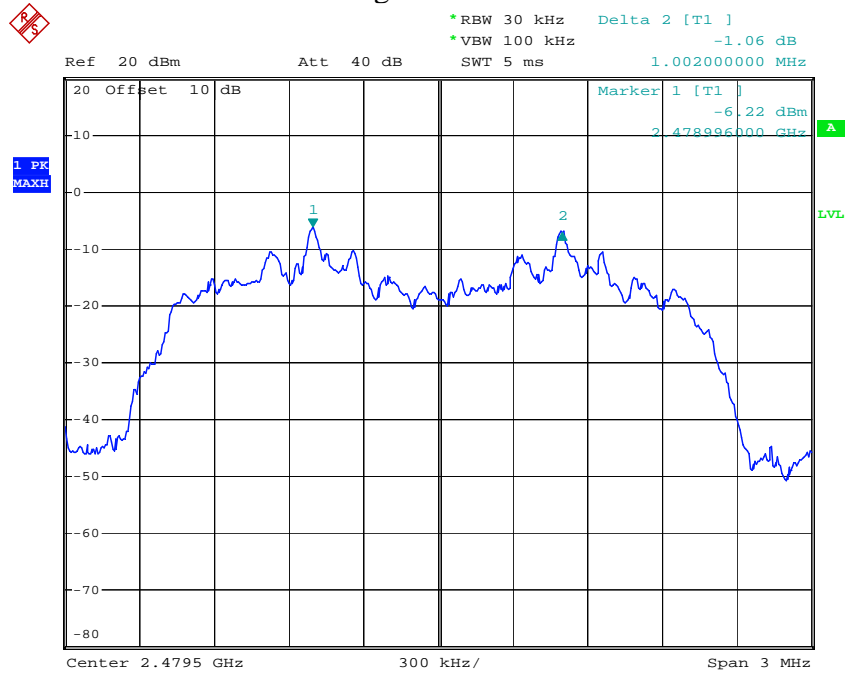

Comment A:
Date: 3.SEP.2018 11:03:24

7. NUMBER OF HOPPING FREQUENCY TEST

7.1. Block Diagram of Test Setup

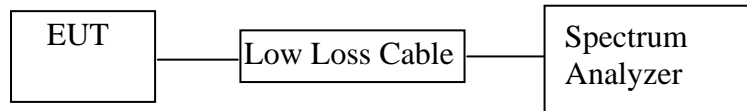

(EUT: Wireless earphones)

7.2. The Requirement For Section 15.247(a)(1)(iii)

Section 15.247(a)(1)(iii): Frequency hopping systems in the 2400-2483.5 MHz band shall use at least 15 channels.

7.3. EUT Configuration on Measurement

The equipment are installed on the emission measurement to meet the commission requirements and operating regulations in a manner which tends to maximize its emission characteristics in normal application.

7.4. Operating Condition of EUT

7.4.1. Setup the EUT and simulator as shown as Section 7.1.

7.4.2. Turn on the power of all equipment.

7.4.3. Let the EUT work in TX (Hopping on) modes measure it.

7.5. Test Procedure

7.5.1. The transmitter output was connected to the spectrum analyzer through a low loss cable.

7.5.2. Set the spectrum analyzer as RBW=100 kHz, VBW=300 kHz.

7.5.3. Max hold, view and count how many channel in the band.

7.6. Test Result

Test Lab: Shielding room
Test Engineer: Bob

Total number of hopping channel	Measurement result(CH)	Limit(CH)
	79	≥ 15

Number of hopping channels(GFSK)

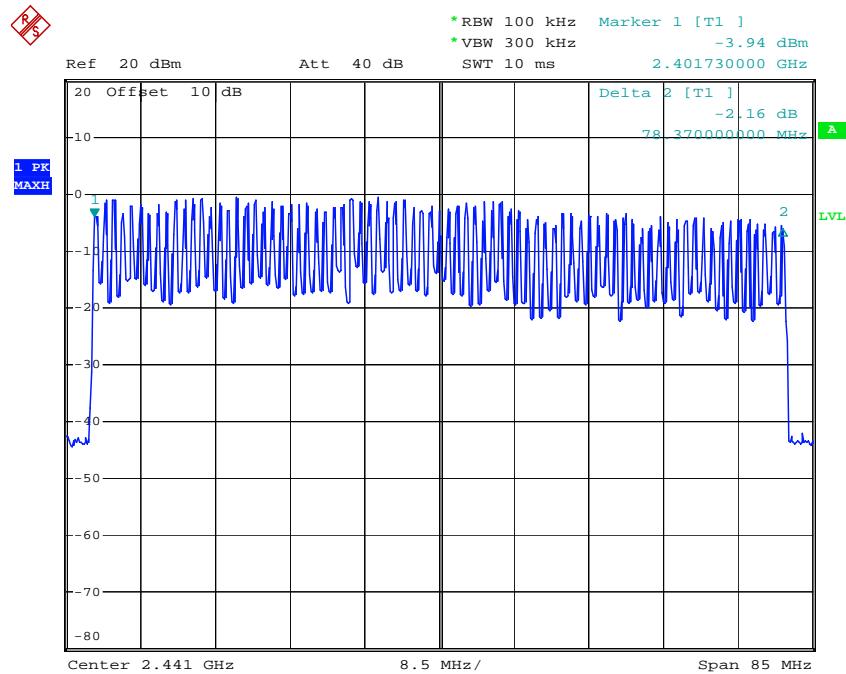

Number of hopping channels($\Pi/4$ -DQPSK)

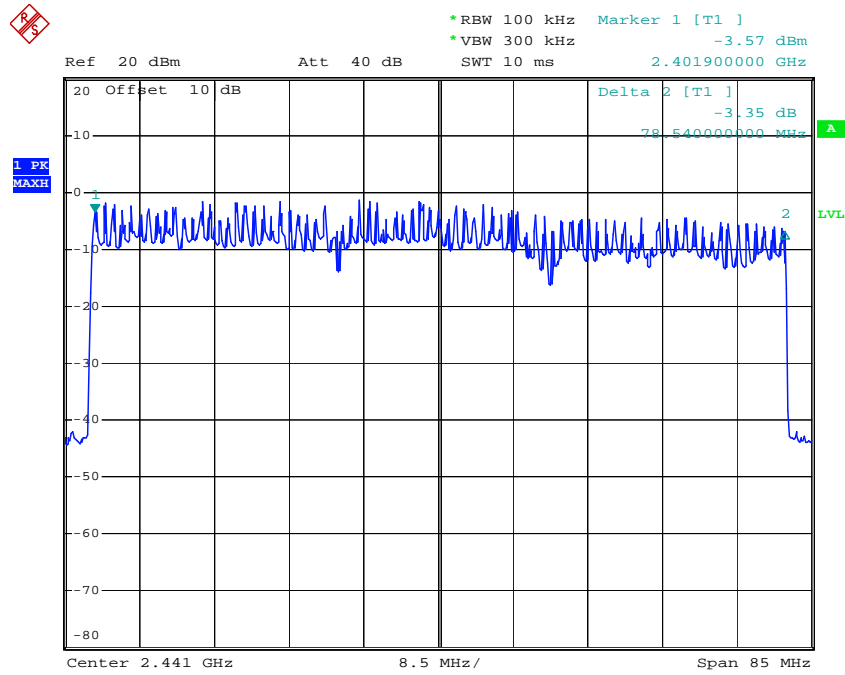

Comment A:
Date: 3.SEP.2018 10:52:29

Number of hopping channels(8DPSK)

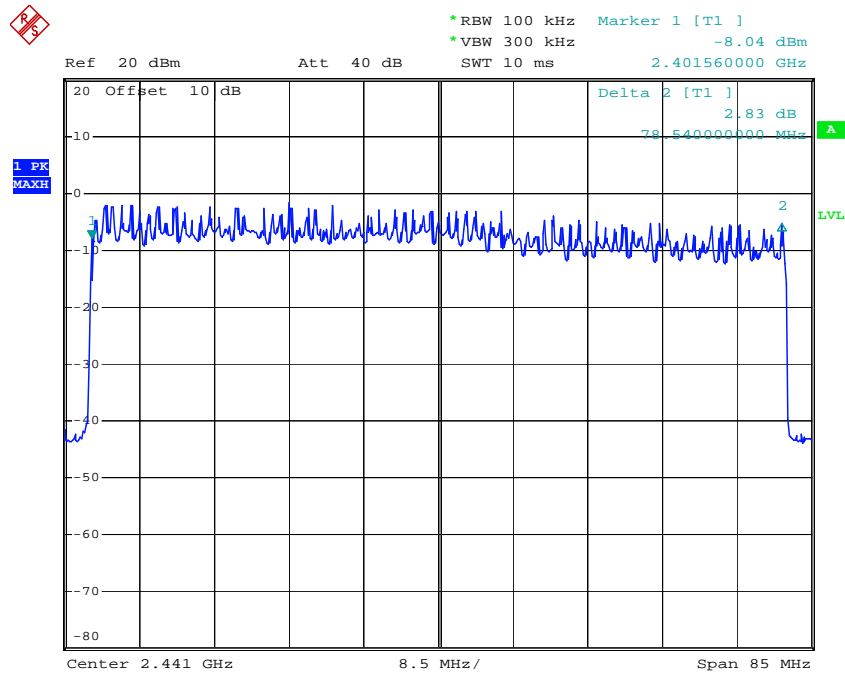

Comment A:
Date: 3.SEP.2018 10:50:33

8. DWELL TIME TEST

8.1. Block Diagram of Test Setup

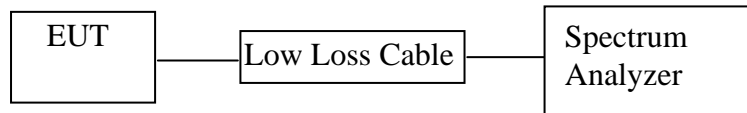

(EUT: Wireless earphones)

8.2. The Requirement For Section 15.247(a)(1)(iii)

Section 15.247(a)(1)(iii): Frequency hopping systems in the 2400-2483.5 MHz band shall use at least 15 channels. The average time of occupancy on any channel shall not be greater than 0.4 seconds within a period of 0.4 seconds multiplied by the number of hopping channels employed. Frequency hopping systems may avoid or suppress transmissions on a particular hopping frequency provided that a minimum of 15 channels are used.

8.3. EUT Configuration on Measurement

The equipment are installed on the emission measurement to meet the commission requirements and operating regulations in a manner which tends to maximize its emission characteristics in normal application.

8.4. Operating Condition of EUT

8.4.1. Setup the EUT and simulator as shown as Section 8.1.

8.4.2. Turn on the power of all equipment.

8.4.3. Let the EUT work in TX (Hopping on) modes measure it. The transmit frequency are 2402-2480MHz. We select 2402MHz, 2441MHz, and 2480MHz TX frequency to transmit.

8.5. Test Procedure

8.5.1. The transmitter output was connected to the spectrum analyzer through a low loss cable.

8.5.2. Set center frequency of spectrum analyzer = operating frequency.

8.5.3. Set the spectrum analyzer as RBW=1MHz, VBW=3MHz, Span=0Hz, Adjust Sweep=5ms, 10ms, 15ms. Get the pulse time.

8.5.4. Repeat above procedures until all frequency measured were complete.

8.6. Test Result

Test Lab: Shielding room

Test Engineer: Bob

GFSK Mode (Worst case)

Mode	Channel Frequency (MHz)	Pulse Time (ms)	Dwell Time (ms)	Limit (ms)
DH1	2441	0.43	137.6	400
A period transmit time = $0.4 \times 79 = 31.6$ Dwell time = pulse time $\times (1600/(2*79)) \times 31.6$				
DH3	2441	1.69	270.4	400
A period transmit time = $0.4 \times 79 = 31.6$ Dwell time = pulse time $\times (1600/(4*79)) \times 31.6$				
DH5	2441	2.98	317.9	400
A period transmit time = $0.4 \times 79 = 31.6$ Dwell time = pulse time $\times (1600/(6*79)) \times 31.6$				

$\Pi/4$ -DQPSK (Worst case)

Mode	Channel Frequency (MHz)	Pulse Time (ms)	Dwell Time (ms)	Limit (ms)
DH1	2441	0.45	144.0	400
A period transmit time = $0.4 \times 79 = 31.6$ Dwell time = pulse time $\times (1600/(2*79)) \times 31.6$				
DH3	2441	1.73	276.8	400
A period transmit time = $0.4 \times 79 = 31.6$ Dwell time = pulse time $\times (1600/(4*79)) \times 31.6$				
DH5	2441	1.85	197.3	400
A period transmit time = $0.4 \times 79 = 31.6$ Dwell time = pulse time $\times (1600/(6*79)) \times 31.6$				

8DPSK (Worst case)

Mode	Channel Frequency (MHz)	Pulse Time (ms)	Dwell Time (ms)	Limit (ms)
DH1	2441	0.45	144.0	400
A period transmit time = $0.4 \times 79 = 31.6$ Dwell time = pulse time $\times (1600/(2*79)) \times 31.6$				
DH3	2441	1.73	276.8	400
A period transmit time = $0.4 \times 79 = 31.6$ Dwell time = pulse time $\times (1600/(4*79)) \times 31.6$				
DH5	2441	2.99	318.9	400
A period transmit time = $0.4 \times 79 = 31.6$ Dwell time = pulse time $\times (1600/(6*79)) \times 31.6$				

Note: We tested GFSK mode and $\Pi/4$ -DQPSK & 8DPSK mode the low, middle and high channel and recorded the worst case data for all test mode.

The spectrum analyzer plots are attached as below.

GFSK Mode

DH1 Middle channel

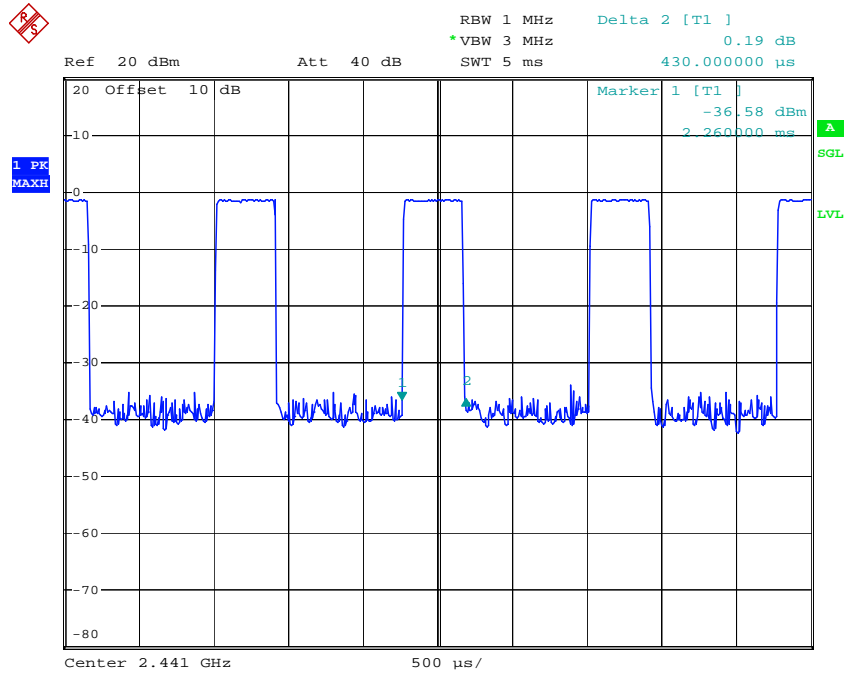

Comment A:
Date: 3.SEP.2018 11:33:40

DH3 Middle channel

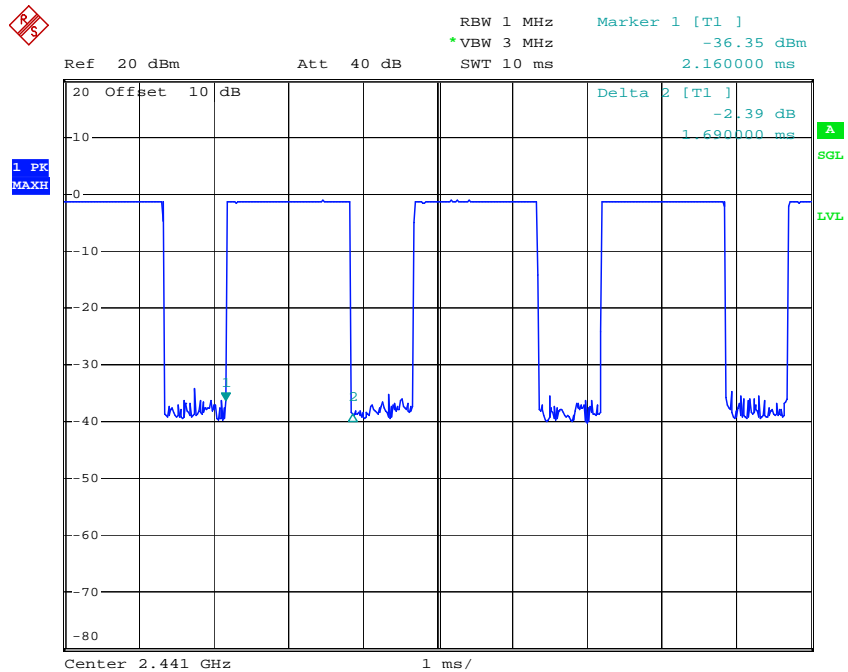

Comment A:
Date: 3.SEP.2018 11:34:20

DH5 Middle channel

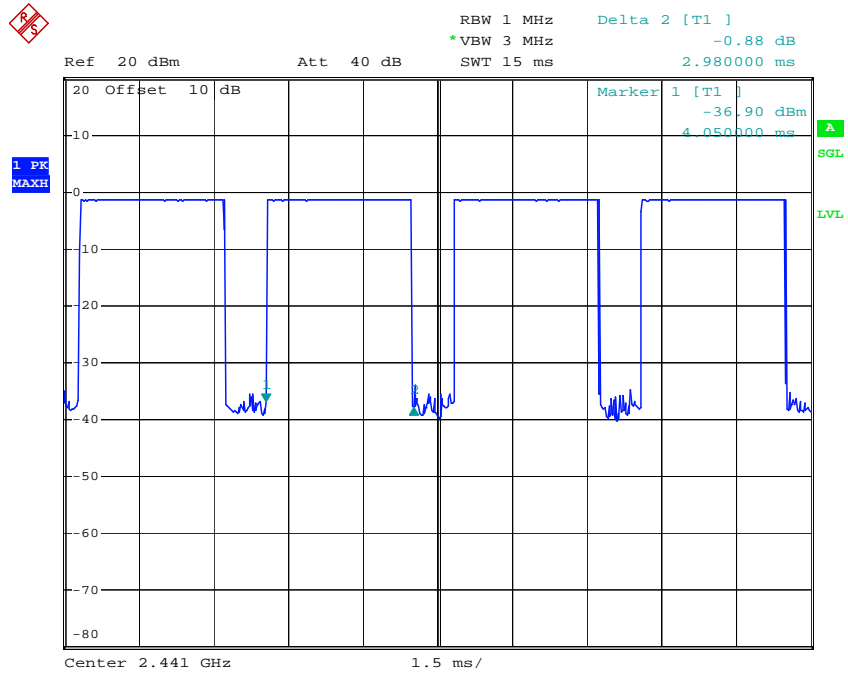

Comment A:
Date: 3.SEP.2018 11:34:58

Π/4-DQPSK

2DH1 Middle channel

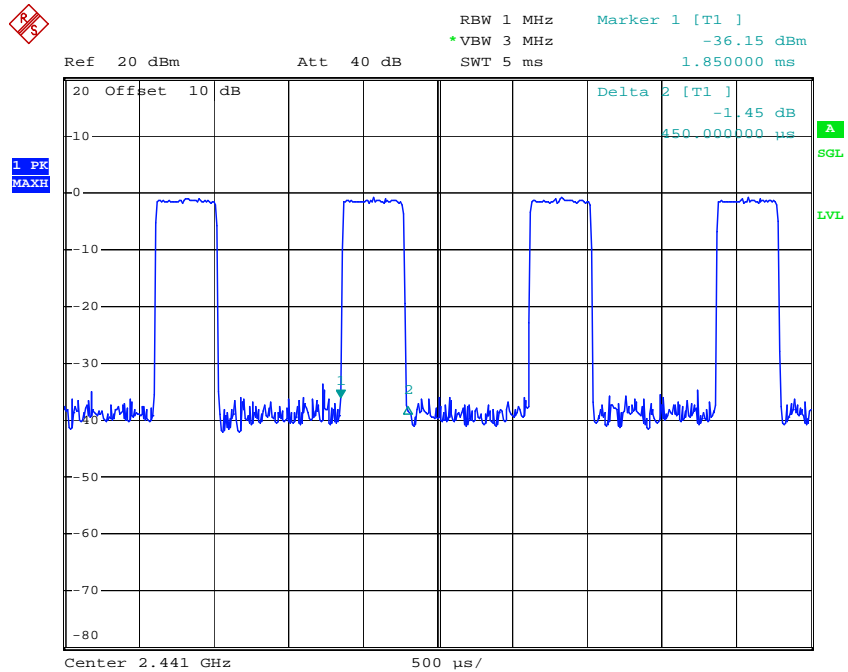

Comment A:
Date: 3.SEP.2018 11:33:01

2DH3 Middle channel

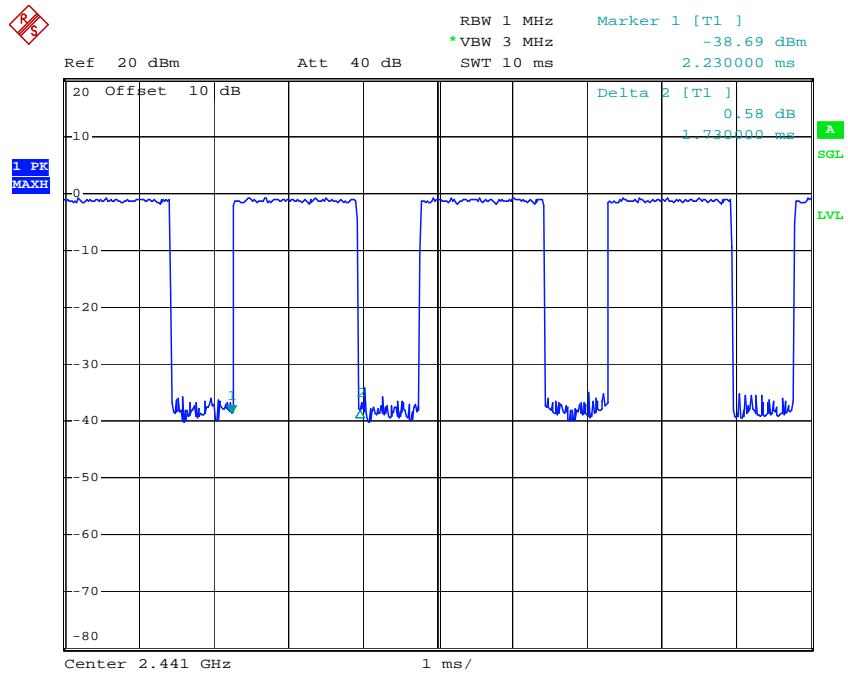

Comment A:
Date: 3.SEP.2018 11:32:14

2DH5 Middle channel

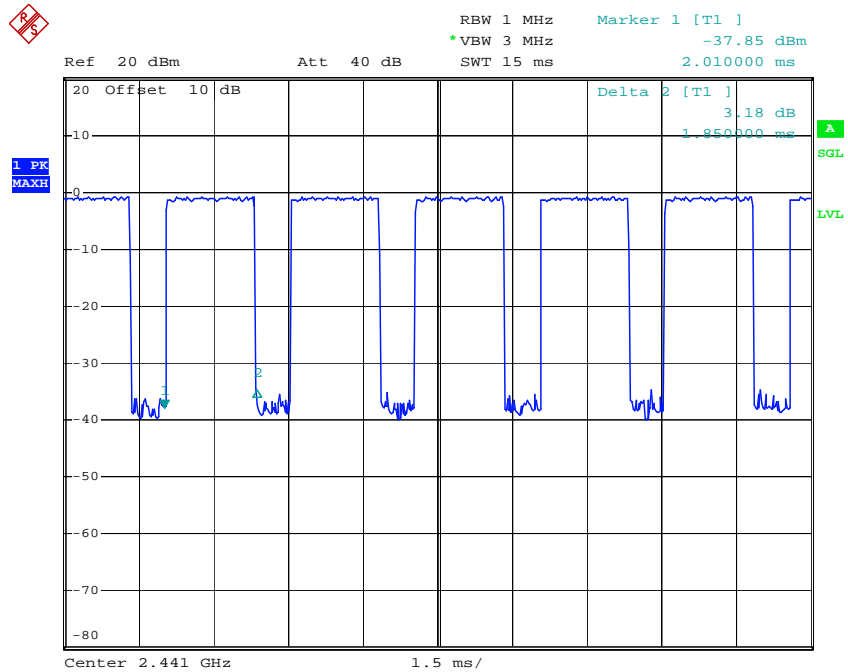

Comment A:
Date: 3.SEP.2018 11:31:32

8DPSK

3DH1 Middle channel

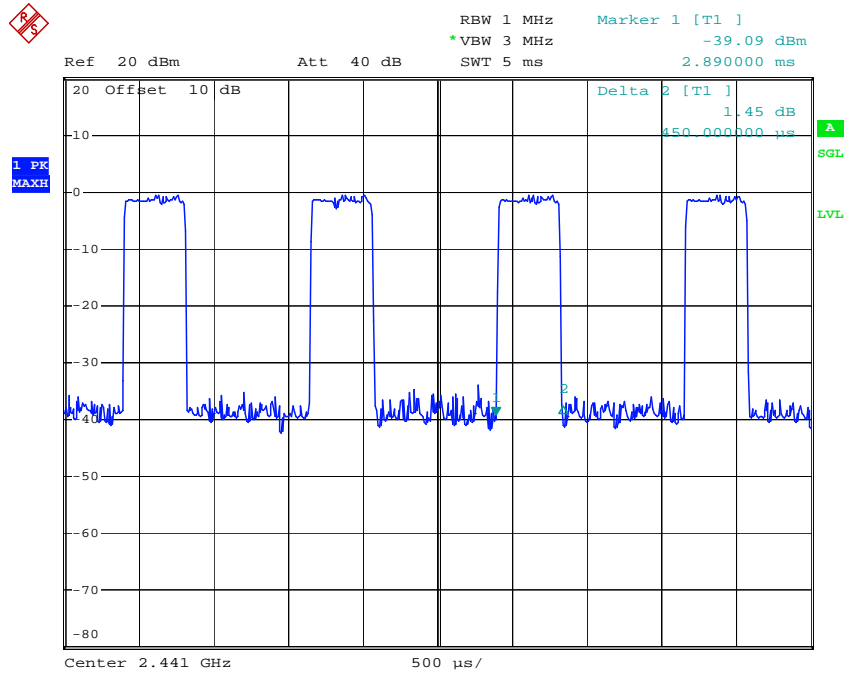

Comment A:
Date: 3.SEP.2018 11:28:55

3DH3 Middle channel

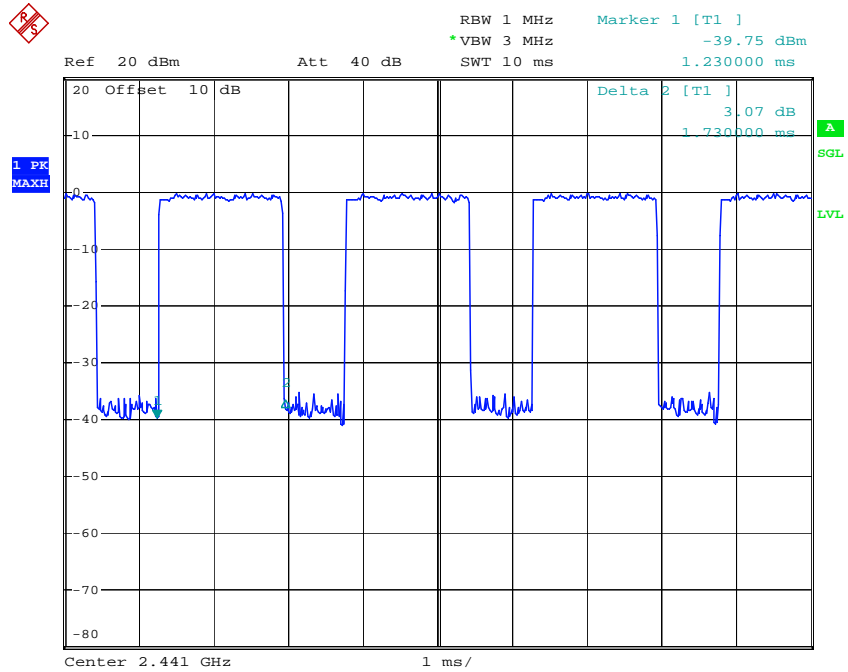

Comment A:
Date: 3.SEP.2018 11:29:29

3DH5 Middle channel

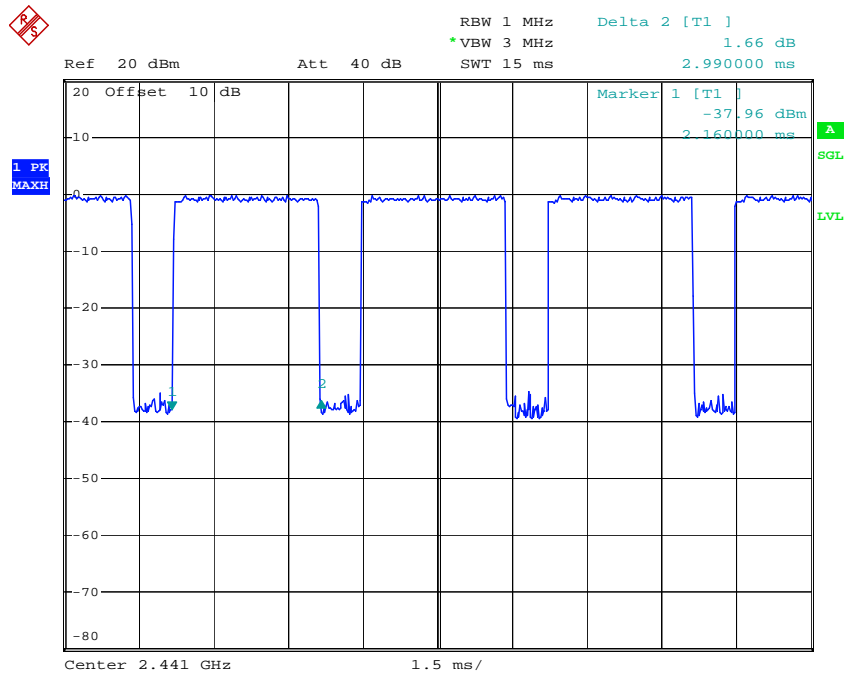

Comment A:
Date: 3.SEP.2018 11:30:11

9. MAXIMUM PEAK OUTPUT POWER TEST

9.1. Block Diagram of Test Setup

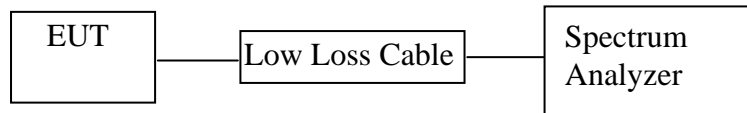

(EUT: Wireless earphones)

9.2. The Requirement For Section 15.247(b)(1)

Section 15.247(b)(1): For frequency hopping systems operating in the 2400-2483.5 MHz band employing at least 75 non-overlapping hopping channels, and all frequency hopping systems in the 5725-5850 MHz band: 1 watt. For all other frequency hopping systems in the 2400-2483.5 MHz band: 0.125 watts.

9.3. EUT Configuration on Measurement

The equipment are installed on the emission Measurement to meet the commission requirements and operating regulations in a manner which tends to maximize its emission characteristics in normal application.

9.4. Operating Condition of EUT

9.4.1. Setup the EUT and simulator as shown as Section 9.1.

9.4.2. Turn on the power of all equipment.

9.4.3. Let the EUT work in TX (Hopping off) modes measure it. The transmit frequency are 2402-2480MHz. We select 2402MHz, 2441MHz, and 2480MHz TX frequency to transmit.

9.5. Test Procedure

9.5.1. The transmitter output was connected to the spectrum analyzer through a low loss cable.

9.5.2. Set RBW of spectrum analyzer to 3MHz and VBW to 3MHz.

9.5.3. Measurement the maximum peak output power.

9.6. Test Result

Test Lab: Shielding room

Test Engineer: Bob

GFSK Mode

Channel	Frequency (MHz)	Peak Output Power (dBm/W)	Limits dBm / W
Low	2402	-0.72/0.0008	21 / 0.125
Middle	2441	-1.07/0.0008	21 / 0.125
High	2480	-4.70/0.0003	21 / 0.125

Π/4-DQPSK Mode

Channel	Frequency (MHz)	Peak Output Power (dBm/W)	Limits dBm / W
Low	2402	-0.82/0.0008	21 / 0.125
Middle	2441	-1.07/0.0008	21 / 0.125
High	2480	-3.98/0.0004	21 / 0.125

8DPSK

Channel	Frequency (MHz)	Peak Output Power (dBm/W)	Limits dBm / W
Low	2402	-1.08/0.0008	21 / 0.125
Middle	2441	-1.07/0.0008	21 / 0.125
High	2480	-3.44/0.0005	21 / 0.125

The spectrum analyzer plots are attached as below.

GFSK Mode

Low channel

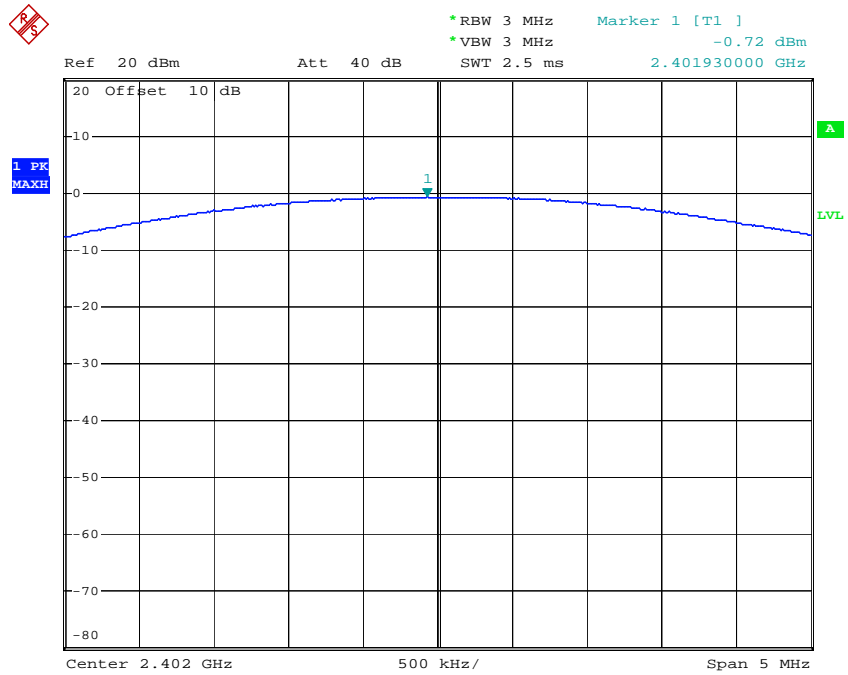

Comment A:
Date: 3.SEP.2018 10:37:13

Middle channel

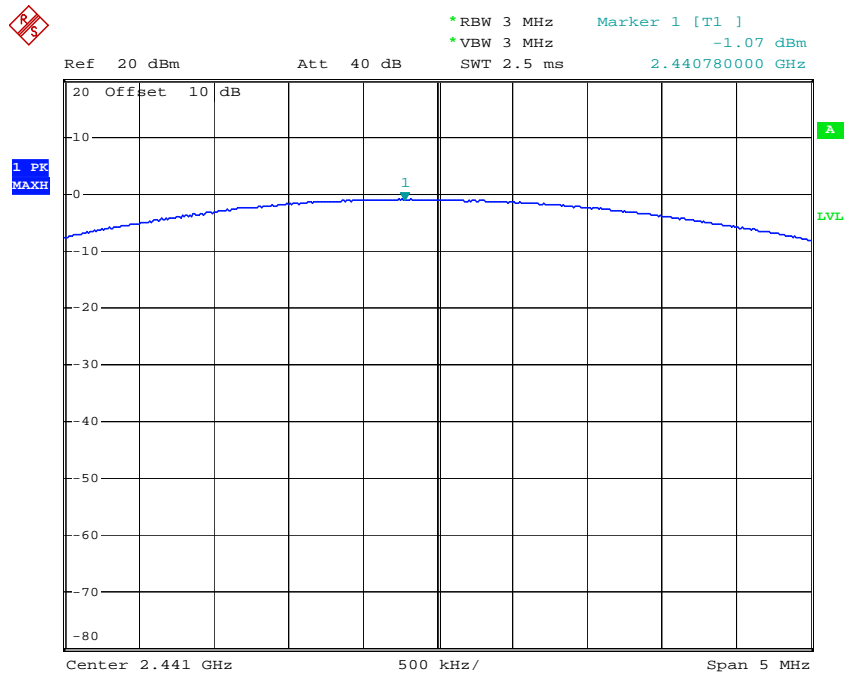

Comment A:
Date: 3.SEP.2018 10:40:16

High channel

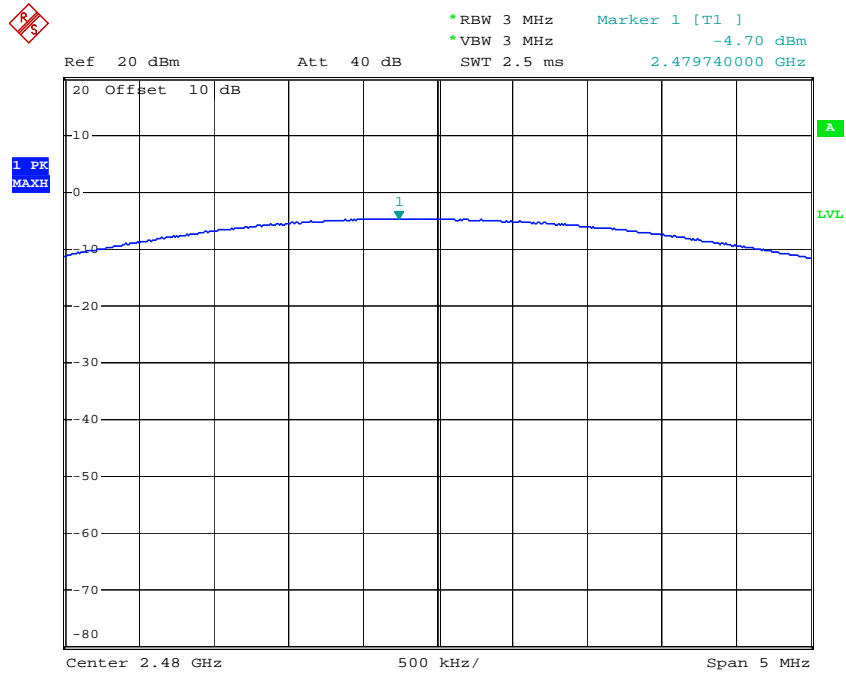

Comment A:
Date: 3.SEP.2018 10:45:17

Π/4-DQPSK Mode

Low channel

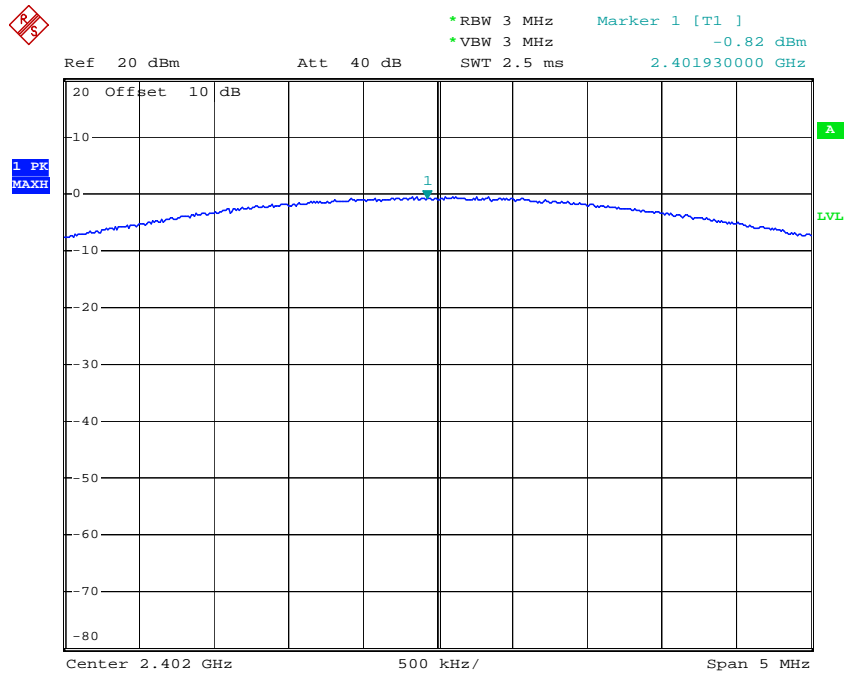

Comment A:
Date: 3.SEP.2018 10:38:41

Middle channel

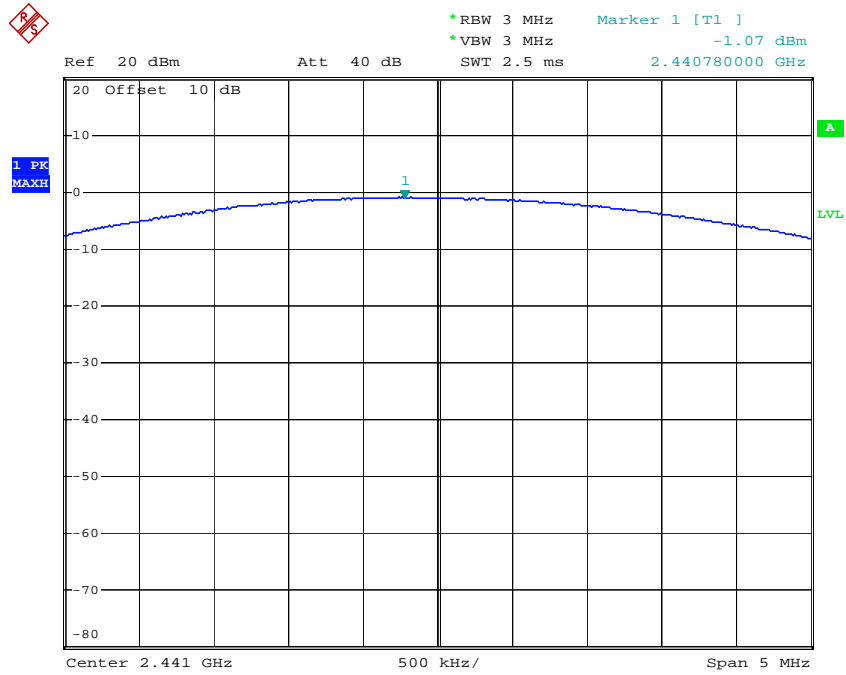

Comment A:
Date: 3.SEP.2018 10:40:47

High channel

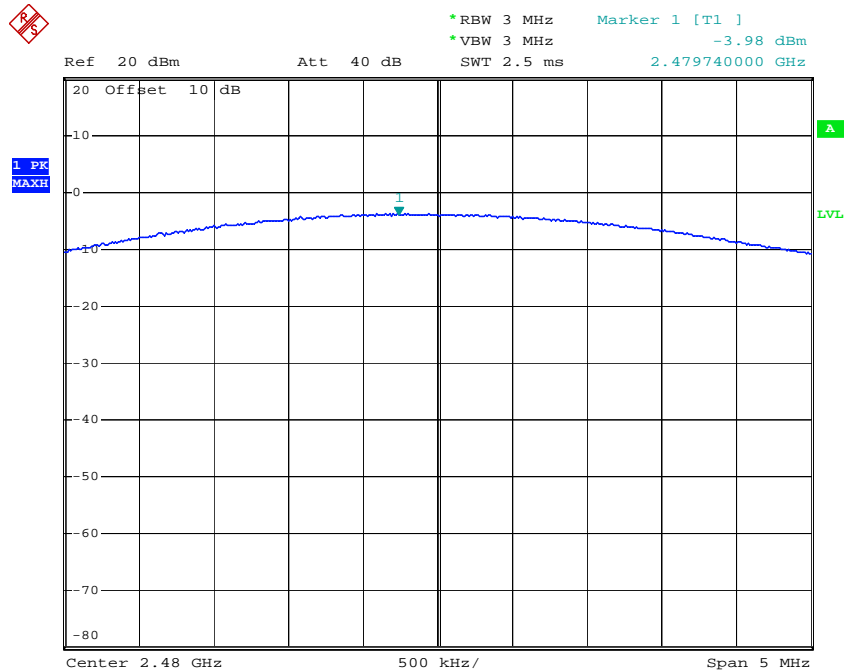

Comment A:
Date: 3.SEP.2018 10:46:05

8DPSK Mode

Low channel

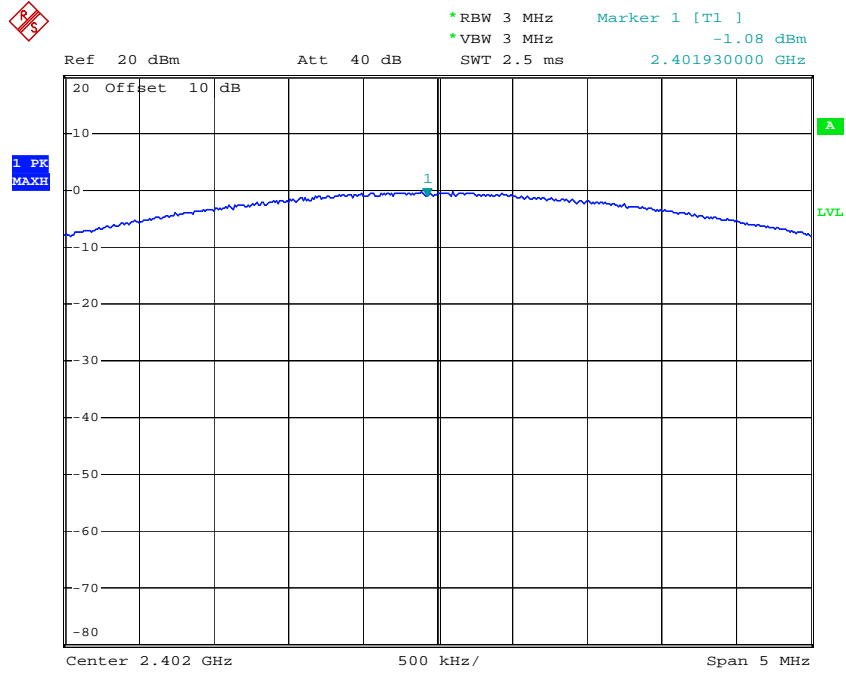

Comment A:
Date: 3.SEP.2018 10:39:16

Middle channel

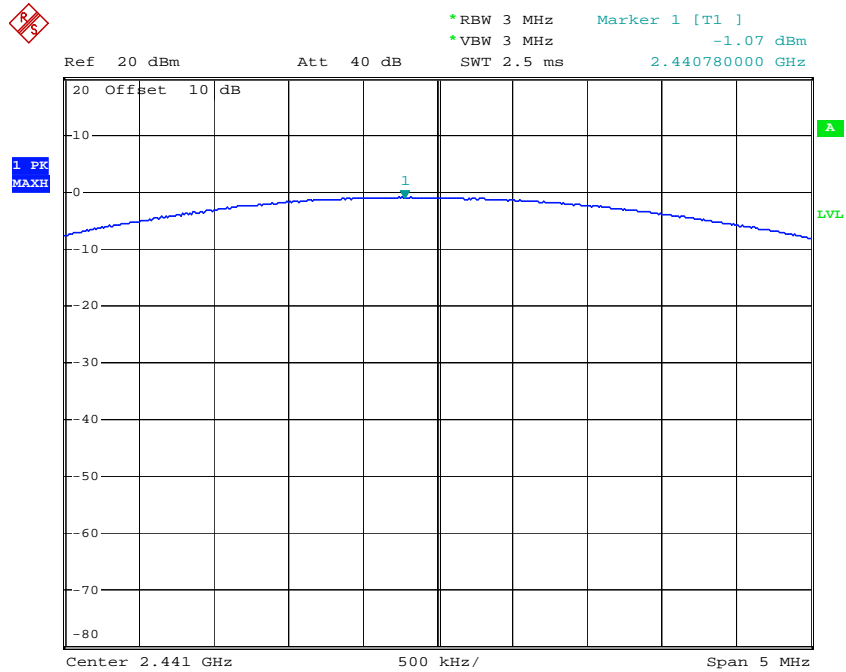

Comment A:
Date: 3.SEP.2018 10:40:47

High channel

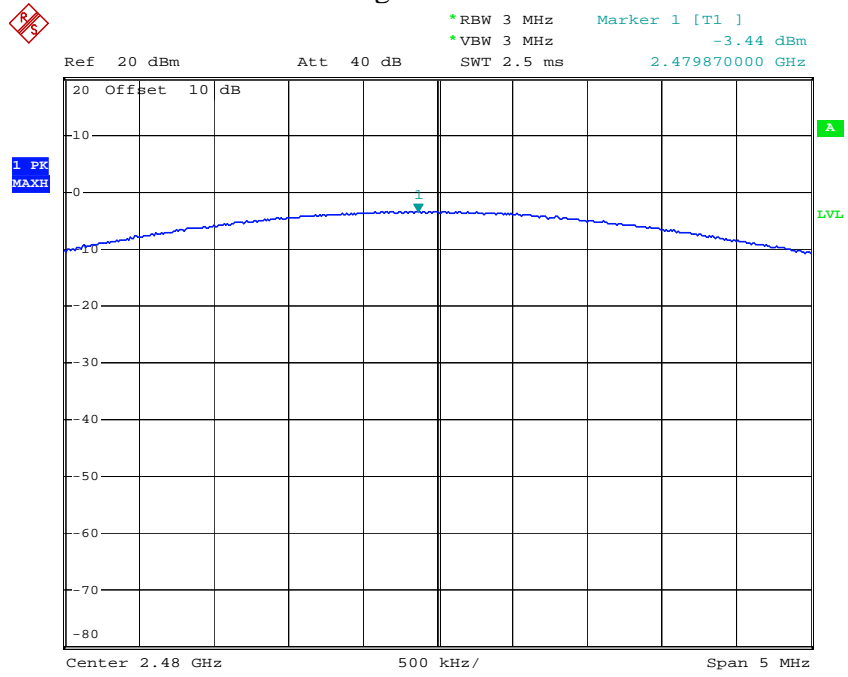

Comment A:
Date: 3.SEP.2018 10:46:38

10. RADIATED EMISSION TEST

10.1. Block Diagram of Test Setup

10.1.1. Block diagram of connection between the EUT and peripherals

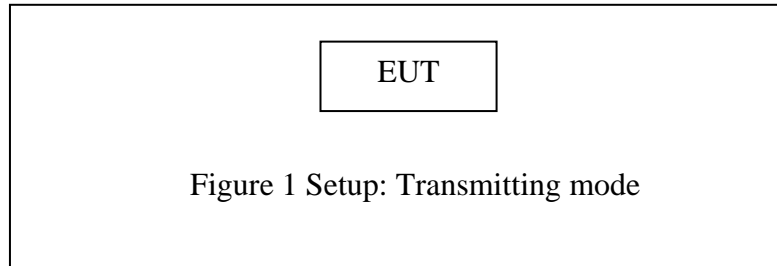

10.1.2. Semi-Anechoic Chamber Test Setup Diagram

(A) Radiated Emission Test Set-Up, Frequency below 30MHz

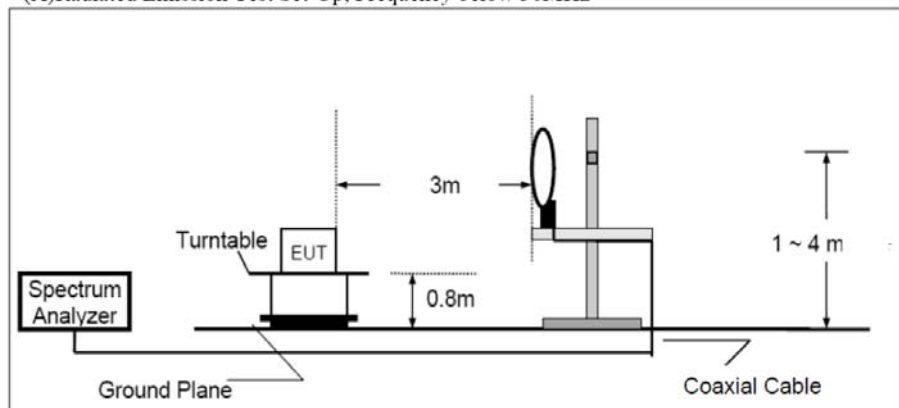

(B) Radiated Emission Test Set-Up, Frequency 30MHz-1GHz

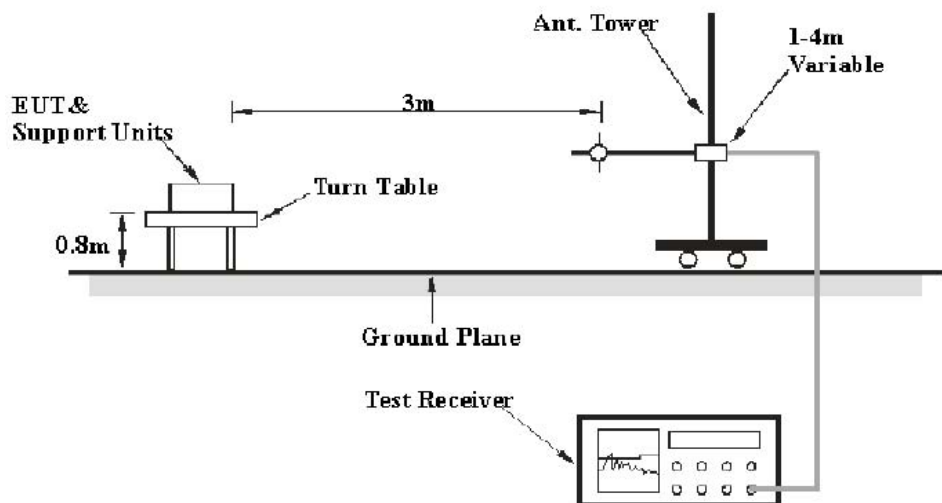

(C) Radiated Emission Test Set-Up, Frequency above 1GHz

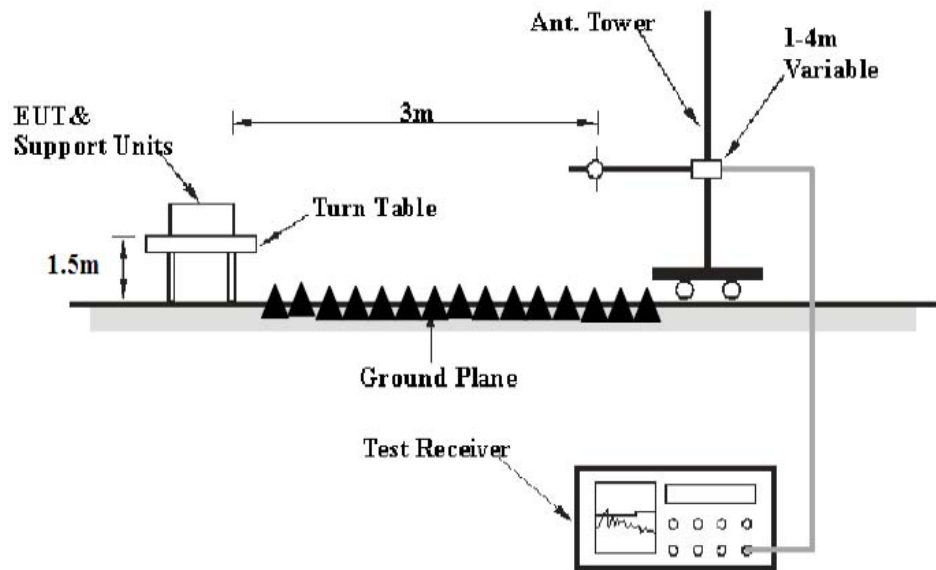

10.2. The Limit For Section 15.247(d)

Section 15.247(d): In any 100 kHz bandwidth outside the frequency band in which the spread spectrum or digitally modulated intentional radiator is operating, the radio frequency power that is produced by the intentional radiator shall be at least 20 dB below that in the 100 kHz bandwidth within the band that contains the highest level of the desired power, based on either an RF conducted or a radiated measurement, provided the transmitter demonstrates compliance with the peak conducted power limits. If the transmitter complies with the conducted power limits based on the use of RMS averaging over a time interval, as permitted under paragraph (b)(3) of this section, the attenuation required under this paragraph shall be 30 dB instead of 20 dB. Attenuation below the general limits specified in Section 15.209(a) is not required. In addition, radiated emissions which fall in the restricted bands, as defined in Section 15.205(a), must also comply with the radiated emission limits specified in Section 15.209(a).

10.3.Restricted bands of operation

10.3.1.FCC Part 15.205 Restricted bands of operation

(a) Except as shown in paragraph (d) of this section, Only spurious emissions are permitted in any of the frequency bands listed below:

MHz	MHz	MHz	GHz
0.090-0.110	16.42-16.423	399.9-410	4.5-5.15
¹ 0.495-0.505	16.69475-16.69525	608-614	5.35-5.46
2.1735-2.1905	16.80425-16.80475	960-1240	7.25-7.75
4.125-4.128	25.5-25.67	1300-1427	8.025-8.5
4.17725-4.17775	37.5-38.25	1435-1626.5	9.0-9.2
4.20725-4.20775	73-74.6	1645.5-1646.5	9.3-9.5
6.215-6.218	74.8-75.2	1660-1710	10.6-12.7
6.26775-6.26825	108-121.94	1718.8-1722.2	13.25-13.4
6.31175-6.31225	123-138	2200-2300	14.47-14.5
8.291-8.294	149.9-150.05	2310-2390	15.35-16.2
8.362-8.366	156.52475-156.52525	2483.5-2500	17.7-21.4
8.37625-8.38675	156.7-156.9	2690-2900	22.01-23.12
8.41425-8.41475	162.0125-167.17	3260-3267	23.6-24.0
12.29-12.293	167.72-173.2	3332-3339	31.2-31.8
12.51975-12.52025	240-285	3345.8-3358	36.43-36.5
12.57675-12.57725	322-335.4	3600-4400	(²)
13.36-13.41			

¹Until February 1, 1999, this restricted band shall be 0.490-0.510

²Above 38.6

(b) Except as provided in paragraphs (d) and (e), the field strength of emission appearing within these frequency bands shall not exceed the limits shown in Section 15.209. At frequencies equal to or less than 1000MHz, Compliance with the limits in Section 15.209 shall be demonstrated using measurement instrumentation employing a CISPR quasi-peak detector. Above 1000MHz, compliance with the emission limits in Section 15.209 shall be demonstrated based on the average value of the measured emissions. The provisions in Section 15.35 apply to these measurements.

10.4.Configuration of EUT on Measurement

The equipment is installed on Radiated Emission Measurement to meet the commission requirements and operating regulations in a manner which tends to maximize its emission characteristics in normal application.

10.5. Operating Condition of EUT

10.5.1. Setup the EUT and simulator as shown as Section 10.1.

10.5.2. Turn on the power of all equipment.

10.5.3. Let the EUT work in TX modes measure it. The transmit frequency are 2402-2480MHz. We select 2402MHz, 2441MHz, and 2480MHz TX frequency to transmit.

10.6. Test Procedure

The EUT and its simulators are placed on a turntable, which is 0.8 meter high above ground (Below 1GHz). The EUT and its simulators are placed on a turntable, which is 1.5 meter high above ground (Above 1GHz). The turntable can rotate 360 degrees to determine the position of the maximum emission level. EUT is set 3.0 meters away from the receiving antenna, which is mounted on an antenna tower. The antenna can be moved up and down between 1.0 meter and 4 meters to find out the maximum emission level. Broadband antenna (calibrated bi-log antenna) is used as receiving antenna. Both horizontal and vertical polarizations of the antenna are set on measurement. In order to find the maximum emission levels, all of the EUT location must be manipulated according to ANSI C63.10:2013 on radiated emission measurement. This EUT was tested in 3 orthogonal positions and the worst case position data was reported.

During the radiated emission test, the spectrum analyzer was set with the following configurations:

1. The resolution bandwidth and video bandwidth of test receiver/spectrum analyzer is 120kHz for Quasi-peak at frequency below 1GHz.
2. The resolution bandwidth of test receiver/spectrum analyzer is 1MHz and video bandwidth is 3MHz for peak measurement with peak detector at frequency above 1GHz.
3. The resolution bandwidth of test receiver/spectrum analyzer is 1MHz and video bandwidth is 10Hz for Average measurement with peak detection at frequency above 1GHz.
4. All modes of operation were investigated and the worst-case emissions are reported.

10.7.Data Sample

Frequency (MHz)	Reading (dB μ v)	Factor (dB/m)	Result (dB μ v/m)	Limit (dB μ v/m)	Margin (dB)	Remark
X.XX	48.69	-13.35	35.34	46	-10.66	QP

Frequency(MHz) = Emission frequency in MHz

Reading(dB μ v) = Uncorrected Analyzer/Receiver reading

Factor (dB/m) = Antenna factor + Cable Loss – Amplifier gain

Result(dB μ v/m) = Reading(dB μ v) + Factor(dB/m)

Limit (dB μ v/m) = Limit stated in standard

Margin (dB) = Result(dB μ v/m) - Limit (dB μ v/m)

QP = Quasi-peak Reading

Calculation Formula:

Margin(dB) = Result (dB μ V/m)–Limit(dB μ V/m)

Result(dB μ V/m)= Reading(dB μ V)+ Factor(dB/m)

The “Margin” column of the following data tables indicates the degree of compliance with the applicable limit. For example, a margin of -7dB means the emission is 7dB below the limit.

10.8.The Field Strength of Radiation Emission Measurement Results

PASS.

Test Lab: 3m Anechoic chamber

Test Engineer: Bob

Note: 1.We tested GFSK mode, $\Pi/4$ -DQPSK & 8DPSK Mode and recorded the worst case data (GFSK mode) for all test mode.

2. Testing is carried out with frequency rang 9kHz to the tenth harmonics, which above 3th Harmonics are attenuated more than 20dB below the permissible limits or the field strength is too small to be measured. The measurements greater than 20dB below the limit from 9kHz to 30MHz and 18 to 26.5GHz.

The spectrum analyzer plots are attached as below.

Below 1GHz



ACCURATE TECHNOLOGY CO., LTD.

F1,Bldg,A,Changyuan New Material Port Keyuan Rd,
Science & Industry Park,Nanshan Shenzhen,P.R.China

Site: 1# Chamber
Tel:+86-0755-26503290
Fax:+86-0755-26503396

Job No.: frank2018 #1132

Standard: FCC Class B 3M Radiated

Test item: Radiation Test

Temp.(C)/Hum.(%) 25 C / 55 %

EUT: Wireless earphones

Mode: TX2402MHz(GFSK)

Model: A2

Manufacturer: KINGVIE TECHNOLOGY CO., LIMITED

Polarization: Vertical

Power Source: DC 3.7V

Date: 18/08/31/

Time: 14/06/01

Engineer Signature: Bob

Distance:

Note: Report NO.:ATE20181594

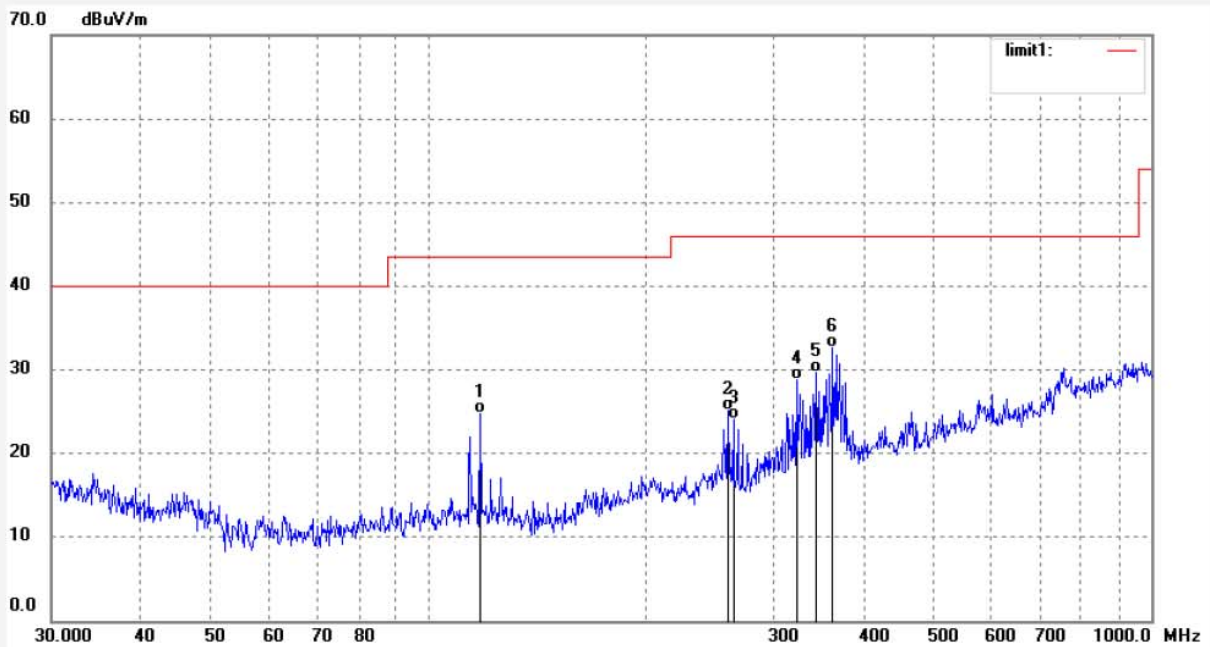

No.	Freq. (MHz)	Reading (dBuV/m)	Factor (dB)	Result (dBuV/m)	Limit (dBuV/m)	Margin (dB)	Detector	Height (cm)	Degree (deg.)	Remark
1	117.6814	46.04	-21.27	24.77	43.50	-18.73	QP	100	321	
2	259.4433	42.73	-17.60	25.13	46.00	-20.87	QP	100	94	
3	264.0416	41.34	-17.34	24.00	46.00	-22.00	QP	100	266	
4	322.5896	44.54	-15.68	28.86	46.00	-17.14	QP	100	89	
5	343.6505	44.58	-14.86	29.72	46.00	-16.28	QP	100	56	
6	362.2479	46.93	-14.28	32.65	46.00	-13.35	QP	100	241	



ACCURATE TECHNOLOGY CO., LTD.

F1,Bldg,A,Changyuan New Material Port Keyuan Rd,
Science & Industry Park,Nanshan Shenzhen,P.R.China

Site: 1# Chamber
Tel:+86-0755-26503290
Fax:+86-0755-26503396

Job No.: frank2018 #1133

Standard: FCC Class B 3M Radiated

Test item: Radiation Test

Temp.(C)/Hum.(%) 25 C / 55 %

EUT: Wireless earphones

Mode: TX2402MHz(GFSK)

Model: A2

Manufacturer: KINGVIE TECHNOLOGY CO., LIMITED

Polarization: Horizontal

Power Source: DC 3.7V

Date: 18/08/31/

Time: 14/08/15

Engineer Signature: Bob

Distance:

Note: Report NO.:ATE20181594

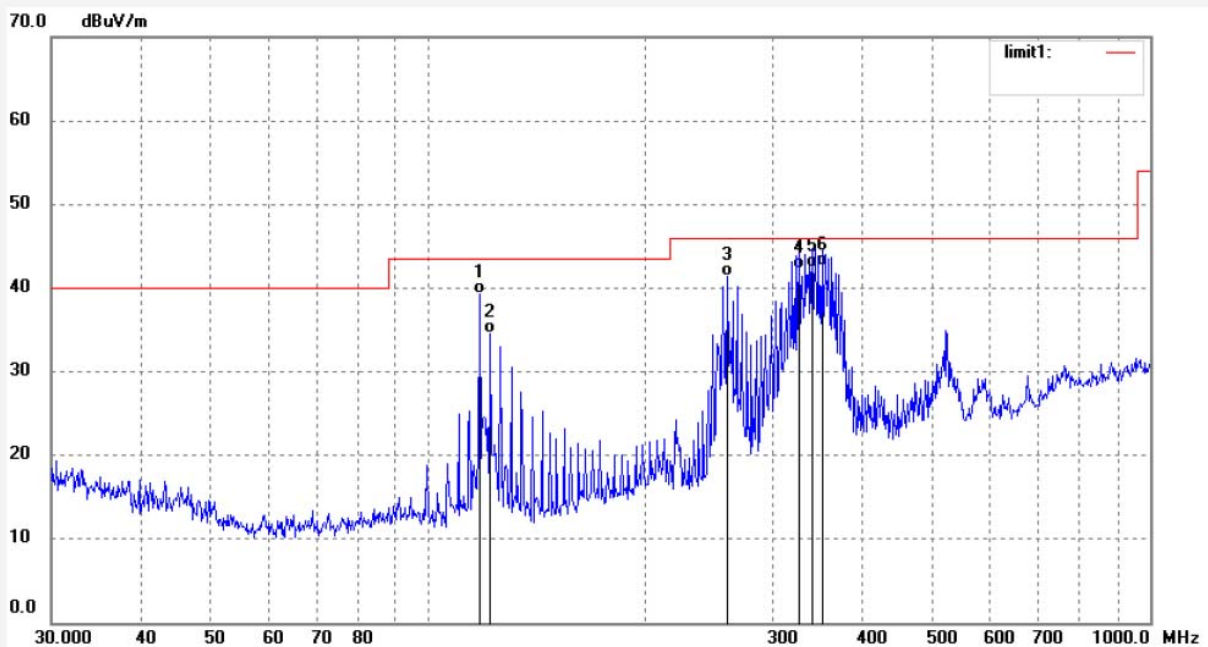

No.	Freq. (MHz)	Reading (dBuV/m)	Factor (dB)	Result (dBuV/m)	Limit (dBuV/m)	Margin (dB)	Detector	Height (cm)	Degree (deg.)	Remark
1	117.6813	60.61	-21.27	39.34	43.50	-4.16	QP	200	55	
2	121.8897	55.98	-21.41	34.57	43.50	-8.93	QP	200	164	
3	259.4433	58.91	-17.60	41.31	46.00	-4.69	QP	200	56	
4	326.0079	57.86	-15.55	42.31	46.00	-3.69	QP	200	145	
5	340.0473	57.49	-15.02	42.47	46.00	-3.53	QP	200	126	
6	350.9721	57.15	-14.59	42.56	46.00	-3.44	QP	200	302	



ACCURATE TECHNOLOGY CO., LTD.

F1,Bldg,A,Changyuan New Material Port Keyuan Rd,
Science & Industry Park,Nanshan Shenzhen,P.R.China

Site: 1# Chamber
Tel:+86-0755-26503290
Fax:+86-0755-26503396

Job No.: frank2018 #1134

Standard: FCC Class B 3M Radiated

Test item: Radiation Test

Temp.(C)/Hum.(%) 25 C / 55 %

EUT: Wireless earphones

Mode: TX2441MHz(GFSK)

Model: A2

Manufacturer: KINGVIE TECHNOLOGY CO., LIMITED

Polarization: Horizontal

Power Source: DC 3.7V

Date: 18/08/31/

Time: 14/10/02

Engineer Signature: Bob

Distance:

Note: Report NO.:ATE20181594

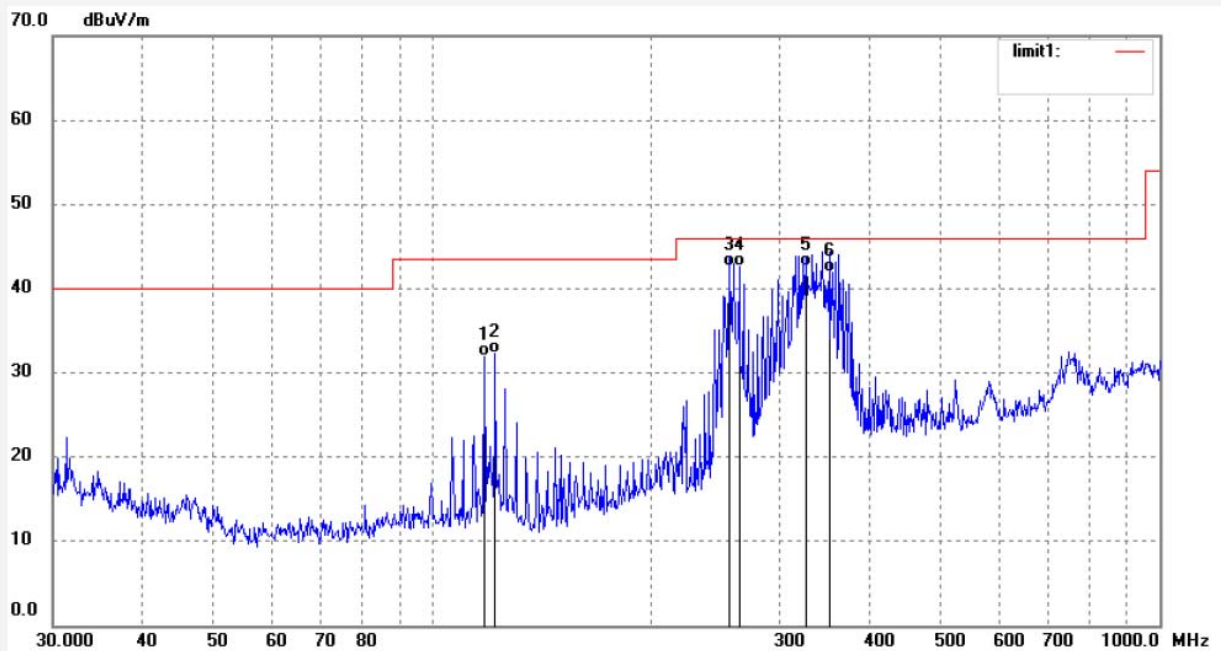

No.	Freq. (MHz)	Reading (dBuV/m)	Factor (dB)	Result (dBuV/m)	Limit (dBuV/m)	Margin (dB)	Detector	Height (cm)	Degree (deg.)	Remark
1	117.6813	53.14	-21.27	31.87	43.50	-11.63	QP	200	302	
2	121.8897	53.65	-21.41	32.24	43.50	-11.26	QP	200	155	
3	255.8224	60.48	-17.84	42.64	46.00	-3.36	QP	200	56	
4	264.0416	59.95	-17.34	42.61	46.00	-3.39	QP	200	255	
5	326.0079	58.15	-15.55	42.60	46.00	-3.40	QP	200	41	
6	350.9721	56.45	-14.59	41.86	46.00	-4.14	QP	200	320	



ACCURATE TECHNOLOGY CO., LTD.

F1,Bldg,A,Changyuan New Material Port Keyuan Rd,
Science & Industry Park,Nanshan Shenzhen,P.R.China

Site: 1# Chamber

Tel:+86-0755-26503290

Fax:+86-0755-26503396

Job No.: frank2018 #1135

Standard: FCC Class B 3M Radiated

Test item: Radiation Test

Temp.(C)/Hum.(%) 25 C / 55 %

EUT: Wireless earphones

Mode: TX2441MHz(GFSK)

Model: A2

Manufacturer: KINGVIE TECHNOLOGY CO., LIMITED

Polarization: Vertical

Power Source: DC 3.7V

Date: 18/08/31/

Time: 14/12/43

Engineer Signature: Bob

Distance:

Note: Report NO.:ATE20181594

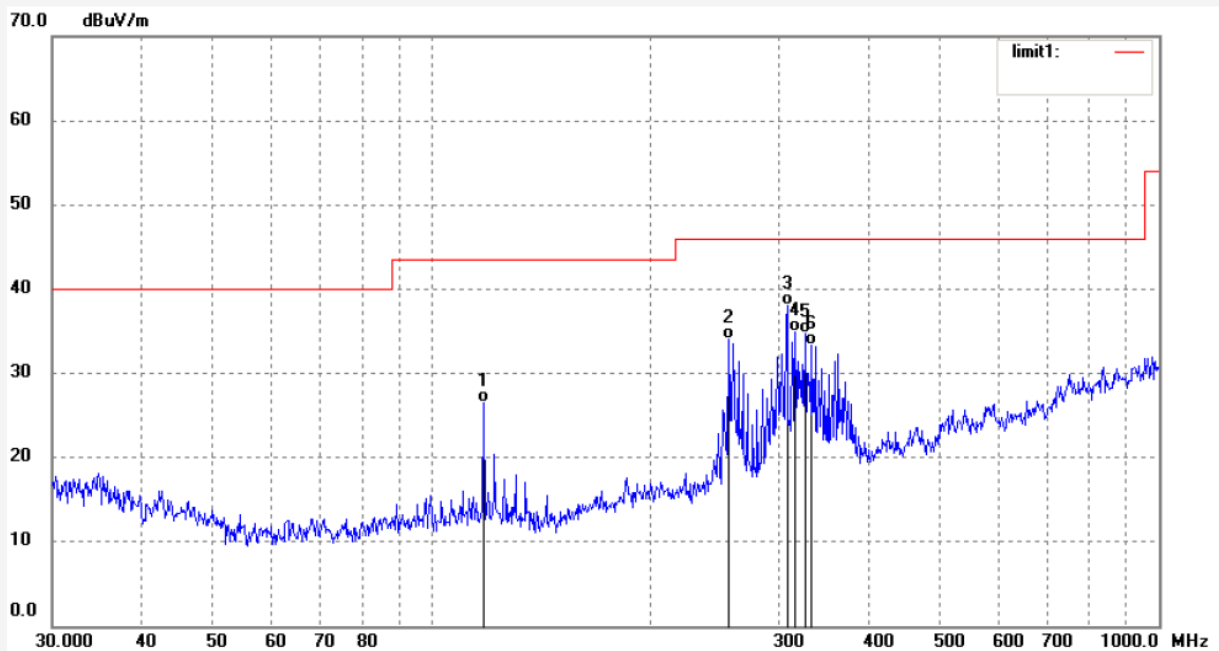

No.	Freq. (MHz)	Reading (dBuV/m)	Factor (dB)	Result (dBuV/m)	Limit (dBuV/m)	Margin (dB)	Detector	Height (cm)	Degree (deg.)	Remark
1	117.6814	47.74	-21.27	26.47	43.50	-17.03	QP	100	185	
2	255.8225	51.83	-17.84	33.99	46.00	-12.01	QP	100	133	
3	308.1860	54.13	-16.11	38.02	46.00	-7.98	QP	100	66	
4	315.8599	50.81	-15.91	34.90	46.00	-11.10	QP	100	154	
5	326.0079	50.24	-15.55	34.69	46.00	-11.31	QP	100	254	
6	332.9534	48.51	-15.22	33.29	46.00	-12.71	QP	100	301	



ACCURATE TECHNOLOGY CO., LTD.

F1,Bldg,A,Changyuan New Material Port Keyuan Rd,
Science & Industry Park,Nanshan Shenzhen,P.R.China

Site: 1# Chamber

Tel:+86-0755-26503290

Fax:+86-0755-26503396

Job No.: frank2018 #1131

Standard: FCC Class B 3M Radiated

Test item: Radiation Test

Temp.(C)/Hum.(%) 25 C / 55 %

EUT: Wireless earphones

Mode: TX2480MHz(GFSK)

Model: A2

Manufacturer: KINGVIE TECHNOLOGY CO., LIMITED

Polarization: Vertical

Power Source: DC 3.7V

Date: 18/08/31/

Time: 14/02/30

Engineer Signature: Bob

Distance:

Note: Report NO.:ATE20181594

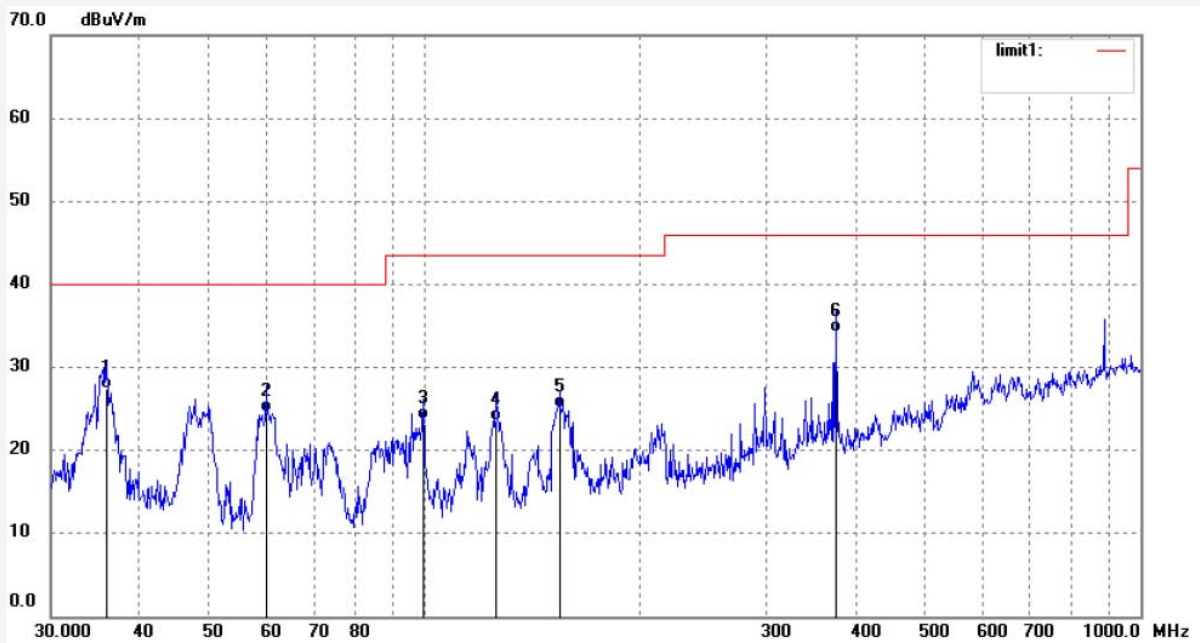

No.	Freq. (MHz)	Reading (dBuV/m)	Factor (dB)	Result (dBuV/m)	Limit (dBuV/m)	Margin (dB)	Detector	Height (cm)	Degree (deg.)	Remark
1	35.8875	45.12	-17.79	27.33	40.00	-12.67	QP	100	211	
2	59.9418	47.12	-22.60	24.52	40.00	-15.48	QP	100	224	
3	99.4176	45.32	-21.67	23.65	43.50	-19.85	QP	100	261	
4	125.8058	45.11	-21.57	23.54	43.50	-19.96	QP	100	56	
5	154.2427	47.12	-21.95	25.17	43.50	-18.33	QP	100	155	
6	375.2022	48.32	-14.19	34.13	46.00	-11.87	QP	100	302	



ACCURATE TECHNOLOGY CO., LTD.

F1,Bldg,A,Changyuan New Material Port Keyuan Rd,
Science & Industry Park,Nanshan Shenzhen,P.R.China

Site: 1# Chamber
Tel:+86-0755-26503290
Fax:+86-0755-26503396

Job No.: frank2018 #1137	Polarization: Horizontal
Standard: FCC Class B 3M Radiated	Power Source: DC 3.7V
Test item: Radiation Test	Date: 18/08/31/
Temp.(C)/Hum.(%) 25 C / 55 %	Time: 14/16/23
EUT: Wireless earphones	Engineer Signature: Bob
Mode: TX2480MHz(GFSK)	Distance:
Model: A2	
Manufacturer: KINGVIE TECHNOLOGY CO., LIMITED	

Note: Report NO.:ATE20181594

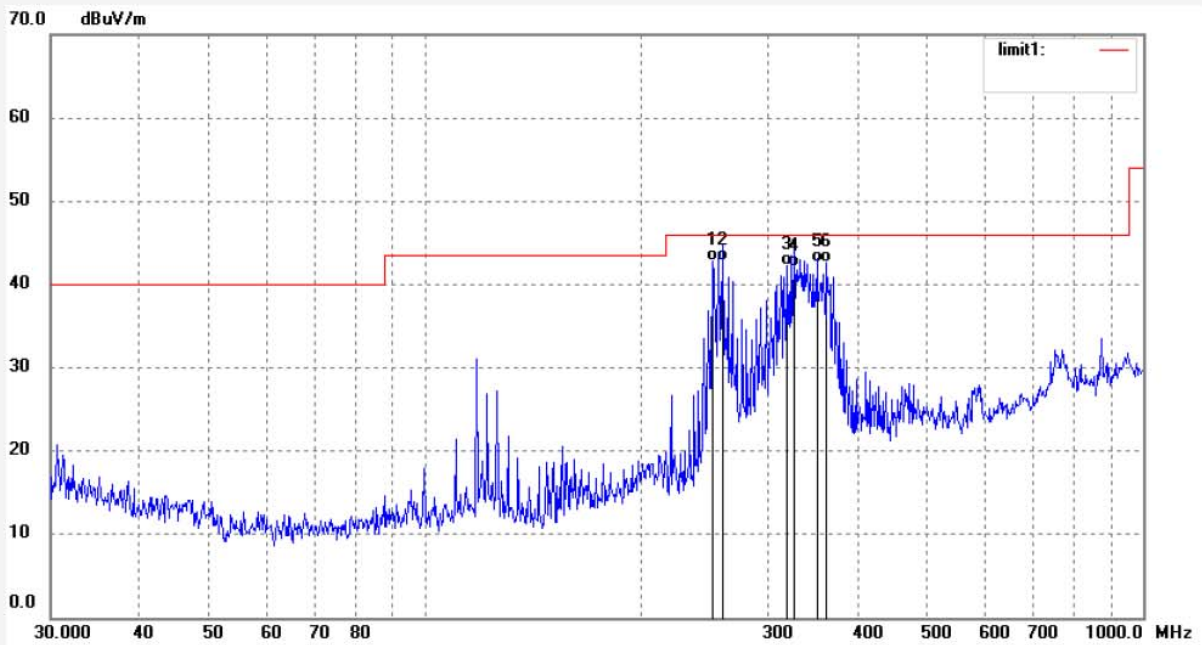

No.	Freq. (MHz)	Reading (dBuV/m)	Factor (dB)	Result (dBuV/m)	Limit (dBuV/m)	Margin (dB)	Detector	Height (cm)	Degree (deg.)	Remark
1	251.3676	60.81	-18.10	42.71	46.00	-3.29	QP	200	321	
2	259.4433	60.47	-17.60	42.87	46.00	-3.13	QP	200	141	
3	319.2071	58.14	-15.82	42.32	46.00	-3.68	QP	200	56	
4	326.0079	57.71	-15.55	42.16	46.00	-3.84	QP	200	45	
5	350.9721	57.12	-14.59	42.53	46.00	-3.47	QP	200	215	
6	362.2479	56.97	-14.28	42.69	46.00	-3.31	QP	200	103	

Above 1GHz



ACCURATE TECHNOLOGY CO., LTD.

F1,Bldg,A,Changyuan New Material Port Keyuan Rd,
Science & Industry Park,Nanshan Shenzhen,P.R.China

Site: 1# Chamber
Tel:+86-0755-26503290
Fax:+86-0755-26503396

Job No.: frank2018 #1138

Standard: FCC PK

Test item: Radiation Test

Temp.(C)/Hum.(%) 25 C / 55 %

EUT: Wireless earphones

Mode: TX2402MHz(GFSK)

Model: A2

Manufacturer: KINGVIE TECHNOLOGY CO., LIMITED

Polarization: Horizontal

Power Source: DC 3.7V

Date: 18/08/31/

Time: 14/20/32

Engineer Signature: Bob

Distance:

Note: Report NO.:ATE20181594

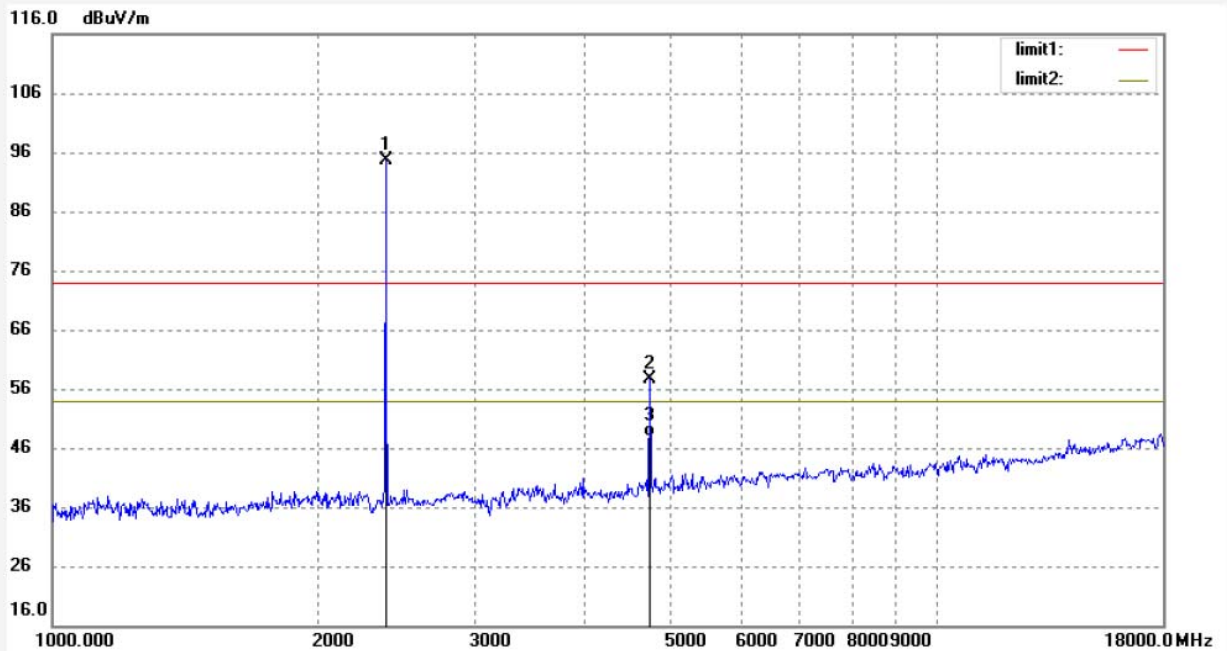

No.	Freq. (MHz)	Reading (dBuV/m)	Factor (dB)	Result (dBuV/m)	Limit (dBuV/m)	Margin (dB)	Detector	Height (cm)	Degree (deg.)	Remark
1	2402.000	102.73	-8.03	94.70			peak	150	320	
2	4804.000	60.21	-2.53	57.68	74.00	-16.32	peak	150	41	
3	4804.000	50.41	-2.53	47.88	54.00	-6.12	AVG	150	152	



ACCURATE TECHNOLOGY CO., LTD.

F1,Bldg,A,Changyuan New Material Port Keyuan Rd,
Science & Industry Park,Nanshan Shenzhen,P.R.China

Site: 1# Chamber

Tel:+86-0755-26503290

Fax:+86-0755-26503396

Job No.: frank2018 #1139

Standard: FCC PK

Test item: Radiation Test

Temp.(C)/Hum.(%) 25 C / 55 %

EUT: Wireless earphones

Mode: TX2402MHz(GFSK)

Model: A2

Manufacturer: KINGVIE TECHNOLOGY CO., LIMITED

Polarization: Vertical

Power Source: DC 3.7V

Date: 18/08/31/

Time: 14/22/53

Engineer Signature: Bob

Distance:

Note: Report NO.:ATE20181594

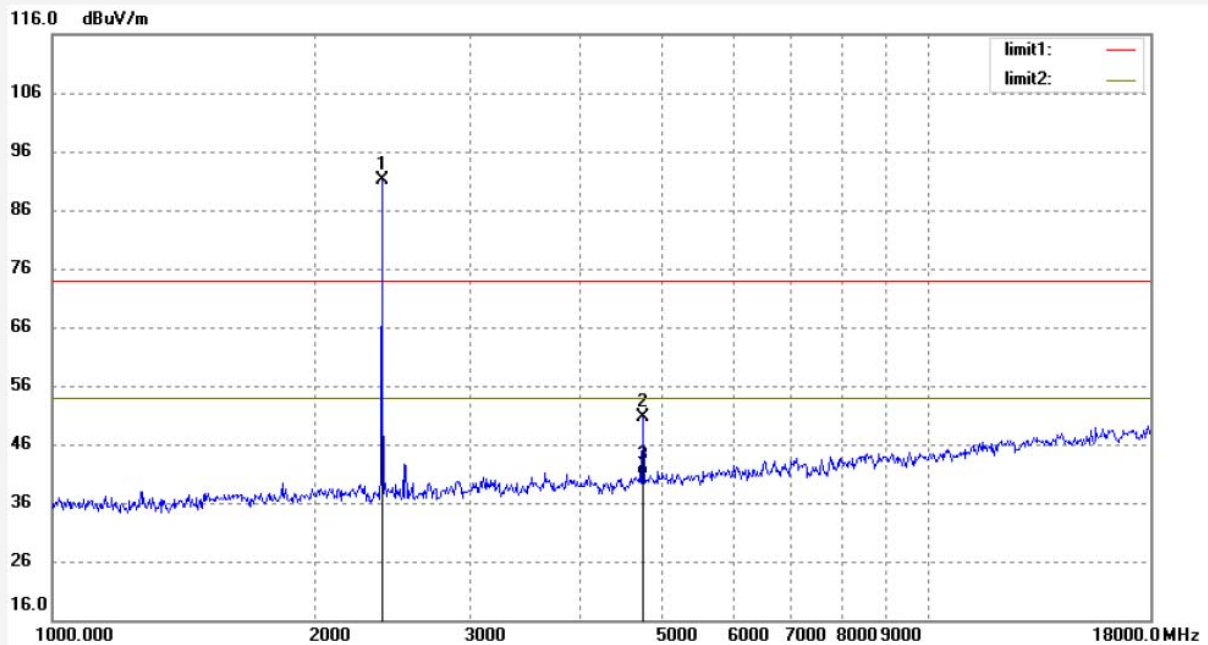

No.	Freq. (MHz)	Reading (dBuV/m)	Factor (dB)	Result (dBuV/m)	Limit (dBuV/m)	Margin (dB)	Detector	Height (cm)	Degree (deg.)	Remark
1	2402.000	99.08	-8.03	91.05			peak	250	302	
2	4804.000	53.13	-2.53	50.60	74.00	-23.40	peak	250	115	
3	4804.000	43.15	-2.53	40.62	54.00	-13.38	AVG	250	158	



ACCURATE TECHNOLOGY CO., LTD.

F1,Bldg,A,Changyuan New Material Port Keyuan Rd,
Science & Industry Park,Nanshan Shenzhen,P.R.China

Site: 1# Chamber
Tel:+86-0755-26503290
Fax:+86-0755-26503396

Job No.: frank2018 #1140

Standard: FCC PK

Test item: Radiation Test

Temp.(C)/Hum.(%) 25 C / 55 %

EUT: Wireless earphones

Mode: TX2441MHz(GFSK)

Model: A2

Manufacturer: KINGVIE TECHNOLOGY CO., LIMITED

Polarization: Vertical

Power Source: DC 3.7V

Date: 18/08/31/

Time: 14/24/21

Engineer Signature: Bob

Distance:

Note: Report NO.:ATE20181594

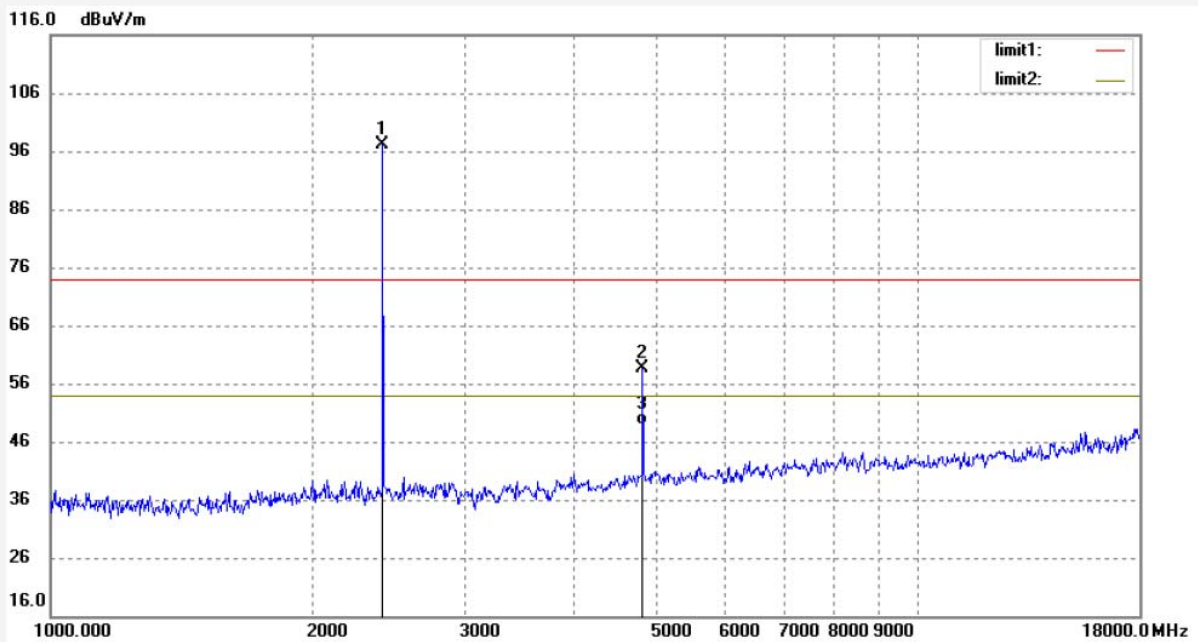

No.	Freq. (MHz)	Reading (dBuV/m)	Factor (dB)	Result (dBuV/m)	Limit (dBuV/m)	Margin (dB)	Detector	Height (cm)	Degree (deg.)	Remark
1	2441.000	104.97	-7.93	97.04			peak	250	156	
2	4882.000	60.93	-2.25	58.68	74.00	-15.32	peak	250	122	
3	4882.000	51.15	-2.25	48.90	54.00	-5.10	AVG	250	302	



ACCURATE TECHNOLOGY CO., LTD.

F1,Bldg,A,Changyuan New Material Port Keyuan Rd,
Science & Industry Park,Nanshan Shenzhen,P.R.China

Site: 1# Chamber

Tel:+86-0755-26503290

Fax:+86-0755-26503396

Job No.: frank2018 #1141

Standard: FCC PK

Test item: Radiation Test

Temp.(C)/Hum.(%) 25 C / 55 %

EUT: Wireless earphones

Mode: TX2441MHz(GFSK)

Model: A2

Manufacturer: KINGVIE TECHNOLOGY CO., LIMITED

Polarization: Horizontal

Power Source: DC 3.7V

Date: 18/08/31/

Time: 14/26/40

Engineer Signature: Bob

Distance:

Note: Report NO.:ATE20181594

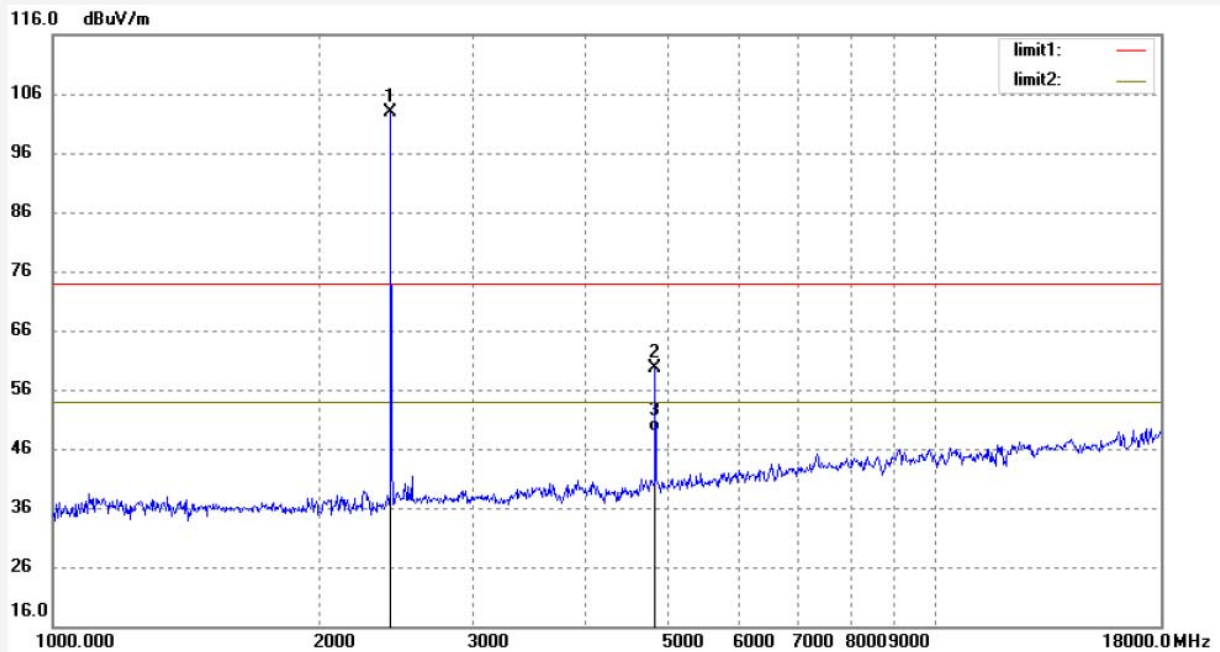

No.	Freq. (MHz)	Reading (dBuV/m)	Factor (dB)	Result (dBuV/m)	Limit (dBuV/m)	Margin (dB)	Detector	Height (cm)	Degree (deg.)	Remark
1	2441.000	110.90	-7.93	102.97			peak	150	165	
2	4882.000	61.98	-2.25	59.73	74.00	-14.27	peak	150	55	
3	4882.000	51.12	-2.25	48.87	54.00	-5.13	AVG	150	326	



ACCURATE TECHNOLOGY CO., LTD.

F1,Bldg,A,Changyuan New Material Port Keyuan Rd,
Science & Industry Park,Nanshan Shenzhen,P.R.China

Site: 1# Chamber

Tel:+86-0755-26503290

Fax:+86-0755-26503396

Job No.: frank2018 #1142

Standard: FCC PK

Test item: Radiation Test

Temp.(C)/Hum.(%) 25 C / 55 %

EUT: Wireless earphones

Mode: TX2480MHz(GFSK)

Model: A2

Manufacturer: KINGVIE TECHNOLOGY CO., LIMITED

Polarization: Horizontal

Power Source: DC 3.7V

Date: 18/08/31/

Time: 14/28/49

Engineer Signature: Bob

Distance:

Note: Report NO.:ATE20181594

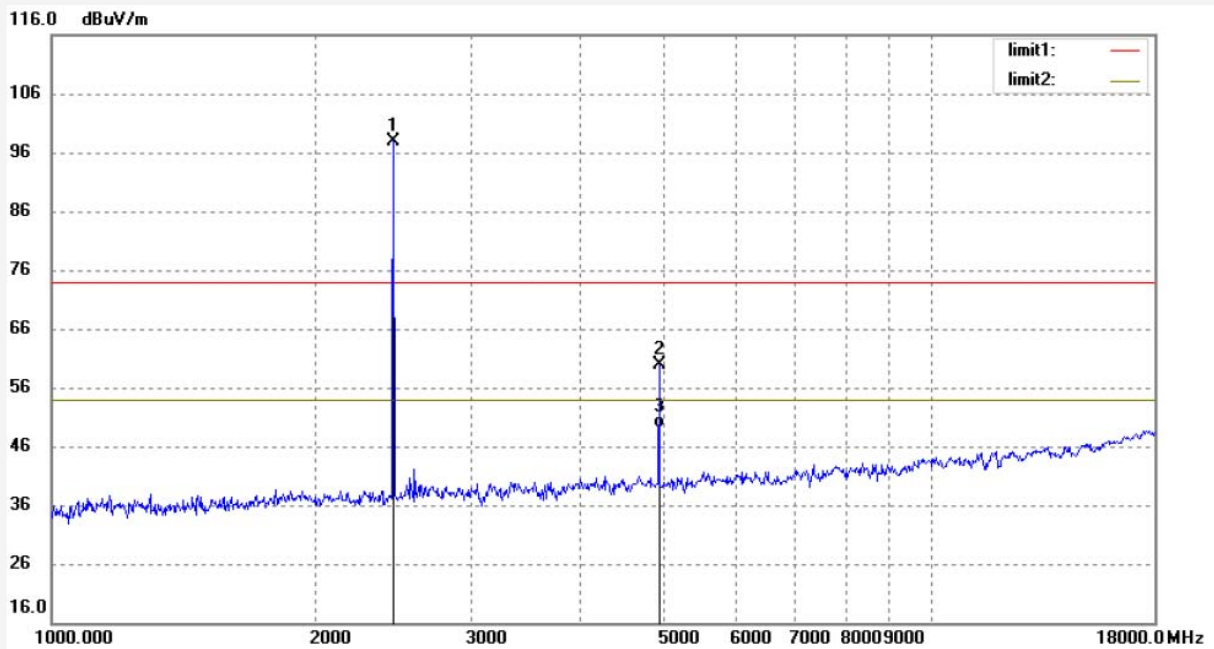

No.	Freq. (MHz)	Reading (dBuV/m)	Factor (dB)	Result (dBuV/m)	Limit (dBuV/m)	Margin (dB)	Detector	Height (cm)	Degree (deg.)	Remark
1	2480.000	105.76	-7.84	97.92			peak	150	302	
2	4960.000	61.72	-1.92	59.80	74.00	-14.20	peak	150	115	
3	4960.000	51.12	-1.92	49.20	54.00	-4.80	AVG	150	197	



ACCURATE TECHNOLOGY CO., LTD.

F1,Bldg,A,Changyuan New Material Port Keyuan Rd,
Science & Industry Park,Nanshan Shenzhen,P.R.China

Site: 1# Chamber

Tel:+86-0755-26503290

Fax:+86-0755-26503396

Job No.: frank2018 #1143

Standard: FCC PK

Test item: Radiation Test

Temp.(C)/Hum.(%) 25 C / 55 %

EUT: Wireless earphones

Mode: TX2480MHz(GFSK)

Model: A2

Manufacturer: KINGVIE TECHNOLOGY CO., LIMITED

Polarization: Horizontal

Power Source: DC 3.7V

Date: 18/08/31/

Time: 14/30/41

Engineer Signature: Bob

Distance:

Note: Report NO.:ATE20181594

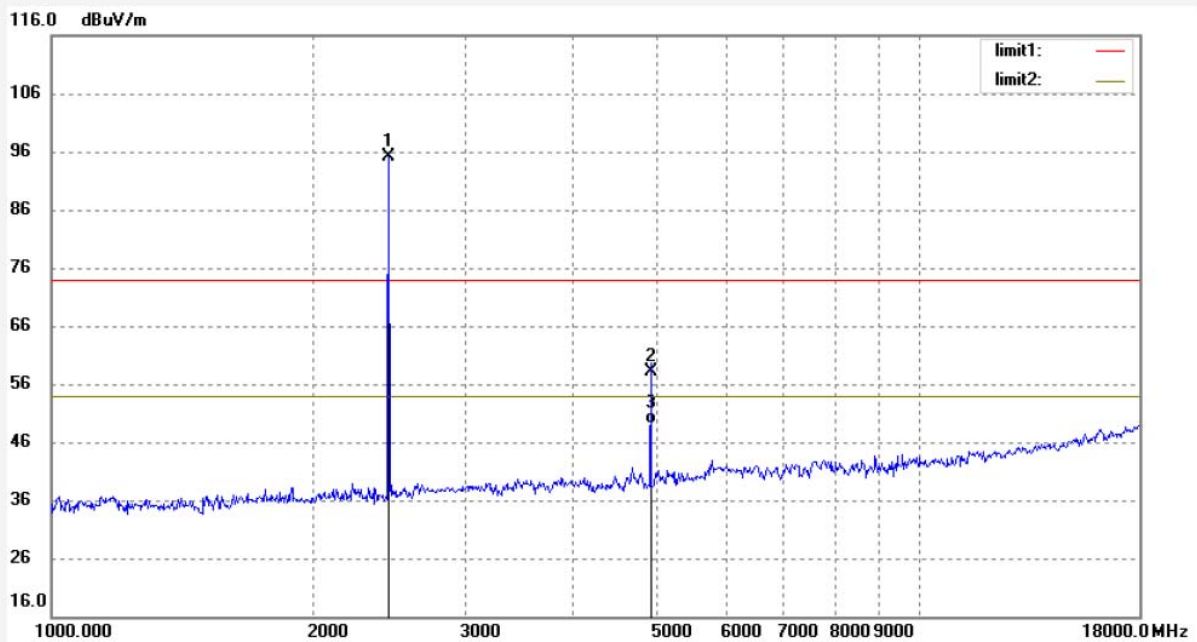

No.	Freq. (MHz)	Reading (dBuV/m)	Factor (dB)	Result (dBuV/m)	Limit (dBuV/m)	Margin (dB)	Detector	Height (cm)	Degree (deg.)	Remark
1	2480.000	102.89	-7.84	95.05			peak	250	25	
2	4960.000	60.15	-1.92	58.23	74.00	-15.77	peak	250	121	
3	4960.000	51.15	-1.92	49.23	54.00	-4.77	AVG	250	133	

11. BAND EDGE COMPLIANCE TEST

11.1. Block Diagram of Test Setup

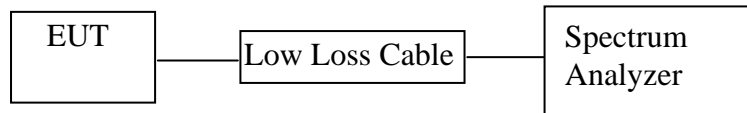

(EUT: Wireless earphones)

11.2. The Requirement For Section 15.247(d)

Section 15.247(d): In any 100 kHz bandwidth outside the frequency band in which the spread spectrum or digitally modulated intentional radiator is operating, the radio frequency power that is produced by the intentional radiator shall be at least 20 dB below that in the 100 kHz bandwidth within the band that contains the highest level of the desired power, based on either an RF conducted or a radiated measurement, provided the transmitter demonstrates compliance with the peak conducted power limits. If the transmitter complies with the conducted power limits based on the use of RMS averaging over a time interval, as permitted under paragraph (b)(3) of this section, the attenuation required under this paragraph shall be 30 dB instead of 20 dB. Attenuation below the general limits specified in Section 15.209(a) is not required. In addition, radiated emissions which fall in the restricted bands, as defined in Section 15.205(a), must also comply with the radiated emission limits specified in Section 15.209(a).

11.3. EUT Configuration on Measurement

The equipment are installed on the emission Measurement to meet the commission requirements and operating regulations in a manner which tends to maximize its emission characteristics in normal application.

11.4. Operating Condition of EUT

11.4.1. Setup the EUT and simulator as shown as Section 11.1.

11.4.2. Turn on the power of all equipment.

11.4.3. Let the EUT work in TX (Hopping off, Hopping on) modes measure it. The transmit frequency are 2402-2480MHz. We select 2402MHz, 2480MHz TX frequency to transmit.

11.5. Test Procedure

11.5.1. The transmitter output was connected to the spectrum analyzer via a low loss cable.

11.5.2. Set RBW of spectrum analyzer to 100 kHz and VBW to 300 kHz with convenient frequency span including 100 kHz bandwidth from band edge.

11.5.3. The band edges was measured and recorded.

11.6. Test Result

Test Lab: Shielding room

Test Engineer: Bob

Note: Both hopping-on mode and hopping-off mode had been pre-tested, and only the worst case was recorded in the test report.

Frequency (MHz)	Result of Band Edge (dBc)	Limit of Band Edge (dBc)
GFSK Mode		
2400.00	42.41	> 20dBc
2483.50	38.31	> 20dBc
Π/4-DQPSK Mode		
2400.00	41.05	> 20dBc
2483.50	38.16	> 20dBc
8DPSK Mode		
2400.00	41.52	> 20dBc
2483.50	37.04	> 20dBc

The spectrum analyzer plots are attached as below.

GFSK Mode

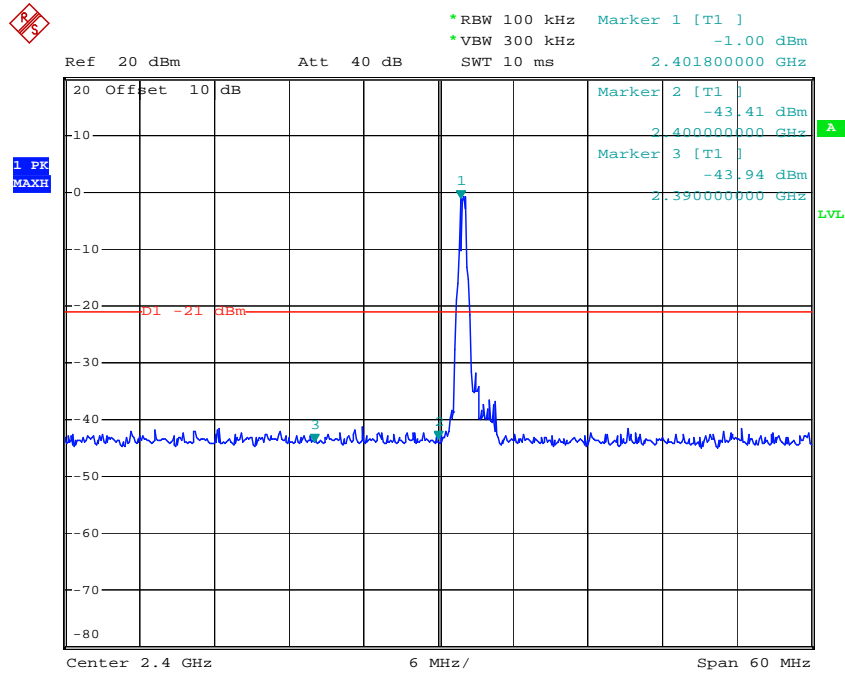

Comment A:
Date: 3.SEP.2018 11:08:17

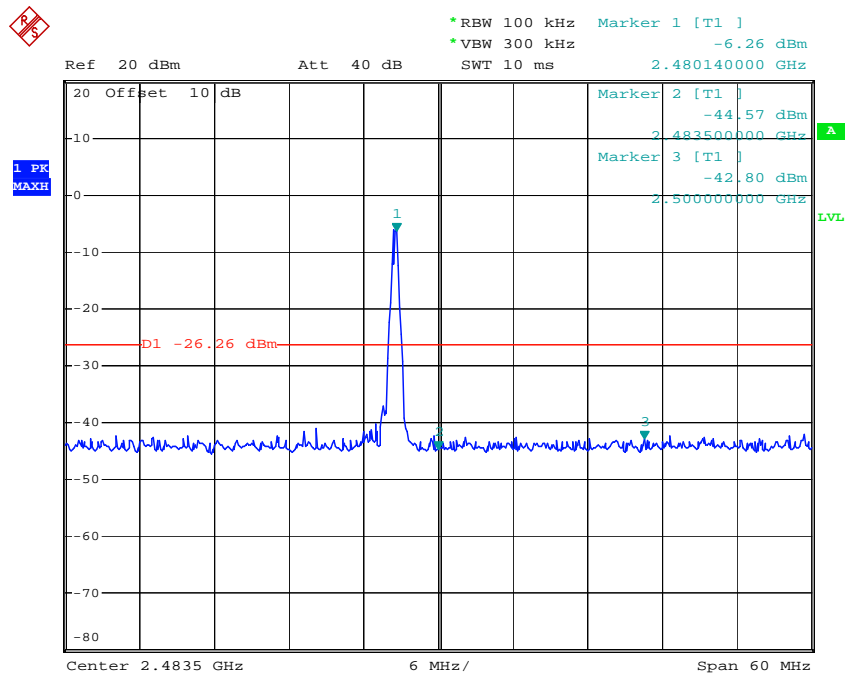

Comment A:
Date: 3.SEP.2018 11:06:53

Π/4-DQPSK Mode

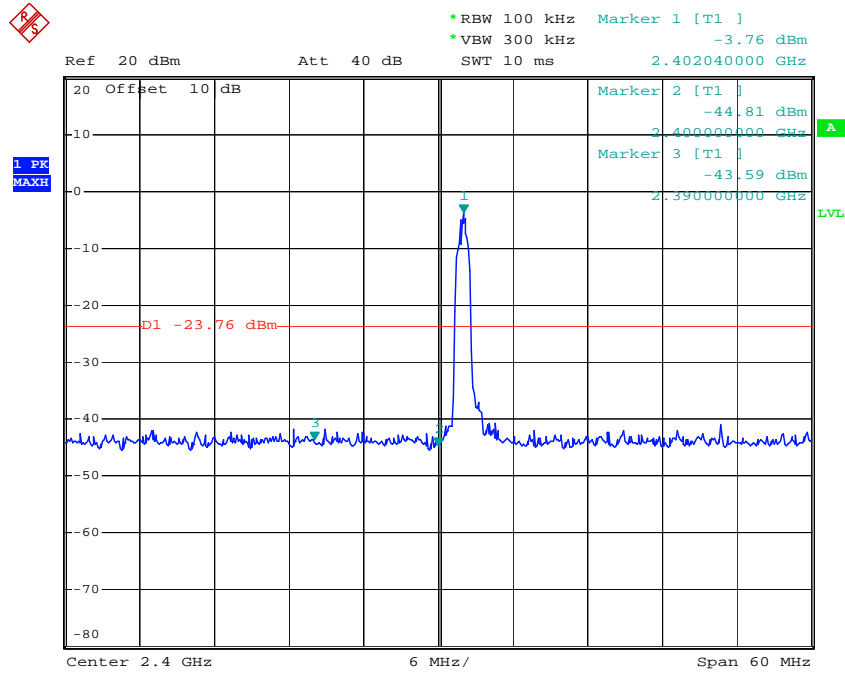

Comment A:
Date: 3.SEP.2018 11:09:11

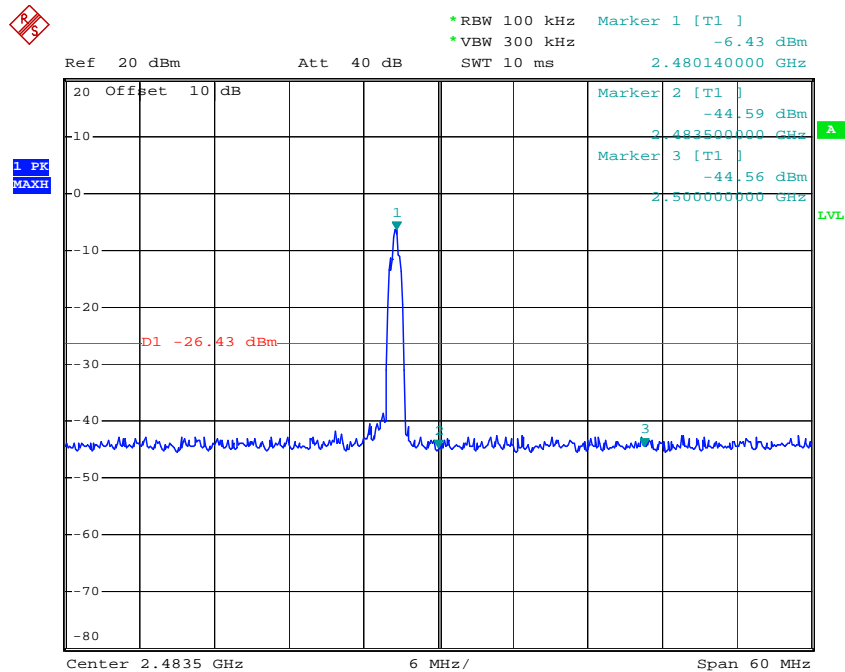

Comment A:
Date: 3.SEP.2018 11:06:12

8DPSK Mode

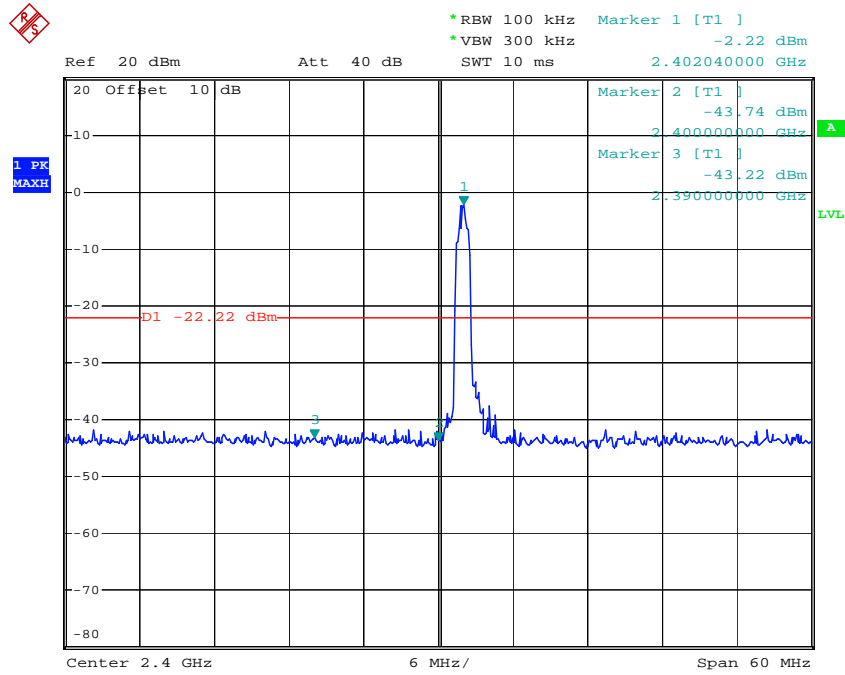

Comment A:
Date: 3.SEP.2018 11:10:06

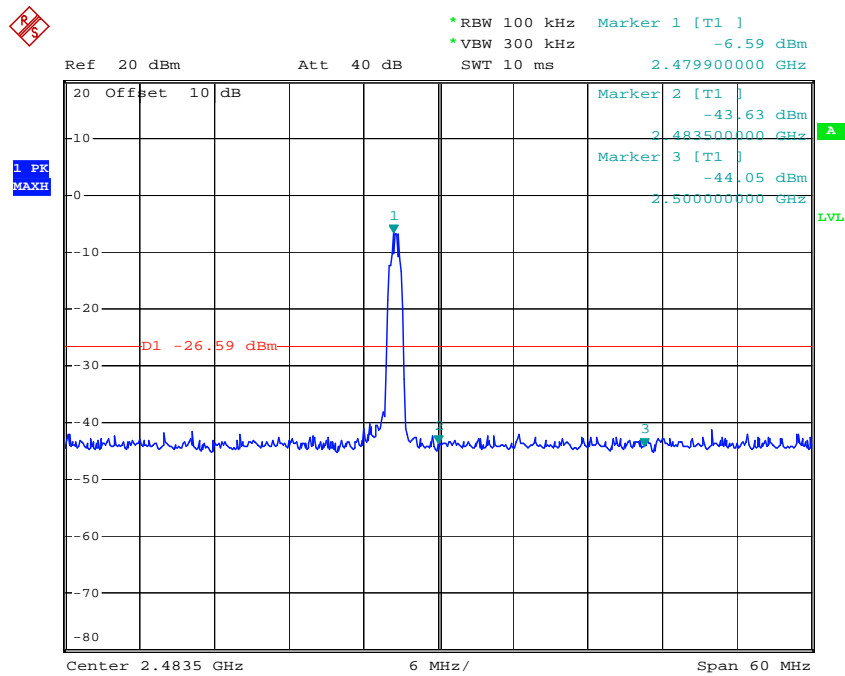

Comment A:
Date: 3.SEP.2018 11:10:59

Radiated Band Edge Result

Note:

1. Emissions attenuated more than 20 dB below the permissible value are not reported.
2. The field strength is calculated by adding the antenna factor, high pass filter loss(if used) and cable loss, and subtracting the amplifier gain(if any)from the measured reading. The basic equation calculation is as follows:

Result = Reading + Corrected Factor

3. Display the measurement of peak values.

Test Procedure:

The EUT and its simulators are placed on a turntable, which is 1.5 meter high above ground(Above 1GHz). The turntable can rotate 360 degrees to determine the position of the maximum emission level. EUT is set 3.0 meters away from the receiving antenna, which is mounted on an antenna tower. The antenna can be moved up and down between 1.0 meter and 4 meters to find out the maximum emission level. Broadband antenna (calibrated bi-log antenna) is used as receiving antenna. Both horizontal and vertical polarizations of the antenna are set on measurement. In order to find the maximum emission levels, all of the EUT location must be manipulated according to ANSI C63.10:2013 on radiated emission measurement. The EUT was tested in 3 orthogonal planes.

Let the EUT work in TX (Hopping off, Hopping on) modes measure it.
We select 2402MHz, 2480MHz TX frequency to transmit(Hopping off mode).
We select 2402-2480MHz TX frequency to transmit(Hopping on mode).

During the radiated emission test, the spectrum analyzer was set with the following configurations:

- 1.The resolution bandwidth of test receiver/spectrum analyzer is 1MHz and video bandwidth is 3MHz for peak measurement with peak detector at frequency above 1GHz.
- 2.The resolution bandwidth of test receiver/spectrum analyzer is 1MHz and video bandwidth is 10Hz for Average measurement with peak detection at frequency above 1GHz.
- 3.All modes of operation were investigated and the worst case (GFSK mode) emissions are reported.

Test Lab: 3m Anechoic chamber

Test Engineer: Bob

Non-hopping mode



ACCURATE TECHNOLOGY CO., LTD.

F1,Bldg,A,Changyuan New Material Port Keyuan Rd,
Science & Industry Park,Nanshan Shenzhen,P.R.China

Site: 1# Chamber
Tel:+86-0755-26503290
Fax:+86-0755-26503396

Job No.: frank2018 #1144	Polarization: Vertical
Standard: FCC PK	Power Source: DC 3.7V
Test item: Radiation Test	Date: 18/08/31/
Temp.(C)/Hum.(%) 25 C / 55 %	Time: 14/34/24
EUT: Wireless earphones	Engineer Signature: Bob
Mode: TX2402MHz(GFSK)	Distance:
Model: A2	
Manufacturer: KINGVIE TECHNOLOGY CO., LIMITED	

Note: Report NO.:ATE20181594

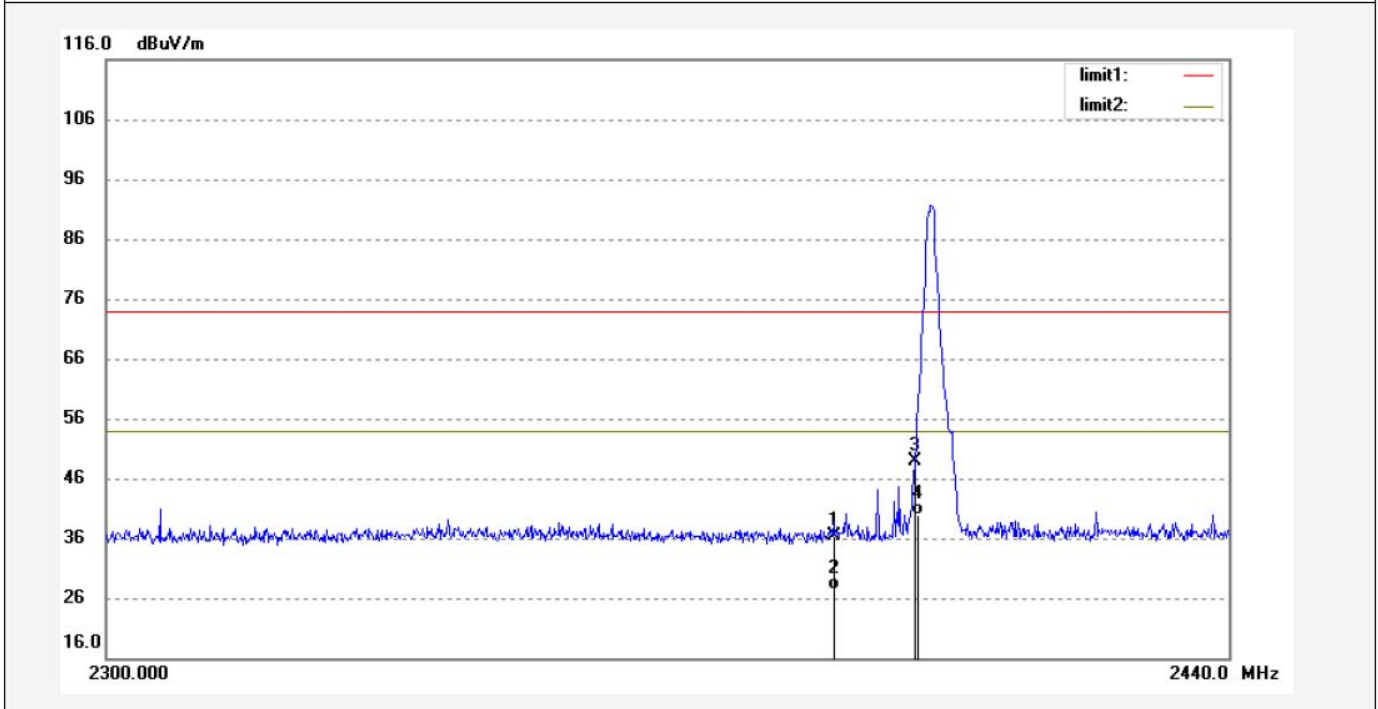

No.	Freq. (MHz)	Reading (dBuV/m)	Factor (dB)	Result (dBuV/m)	Limit (dBuV/m)	Margin (dB)	Detector	Height (cm)	Degree (deg.)	Remark
1	2390.000	44.45	-8.00	36.45	74.00	-37.55	peak	150	302	
2	2390.000	35.32	-8.00	27.32	54.00	-26.68	AVG	150	156	
3	2400.000	56.94	-7.97	48.97	74.00	-25.03	peak	150	56	
4	2400.000	47.95	-7.97	39.98	54.00	-14.02	AVG	150	162	

Note: Average measurement with peak detection at No.2&4



ACCURATE TECHNOLOGY CO., LTD.

F1,Bldg,A,Changyuan New Material Port Keyuan Rd,
Science & Industry Park,Nanshan Shenzhen,P.R.China

Site: 1# Chamber
Tel:+86-0755-26503290
Fax:+86-0755-26503396

Job No.: frank2018 #1145	Polarization: Horizontal
Standard: FCC PK	Power Source: DC 3.7V
Test item: Radiation Test	Date: 18/08/31/
Temp.(C)/Hum.(%) 25 C / 55 %	Time: 14/36/47
EUT: Wireless earphones	Engineer Signature: Bob
Mode: TX2402MHz(GFSK)	Distance:
Model: A2	
Manufacturer: KINGVIE TECHNOLOGY CO., LIMITED	

Note: Report NO.:ATE20181594

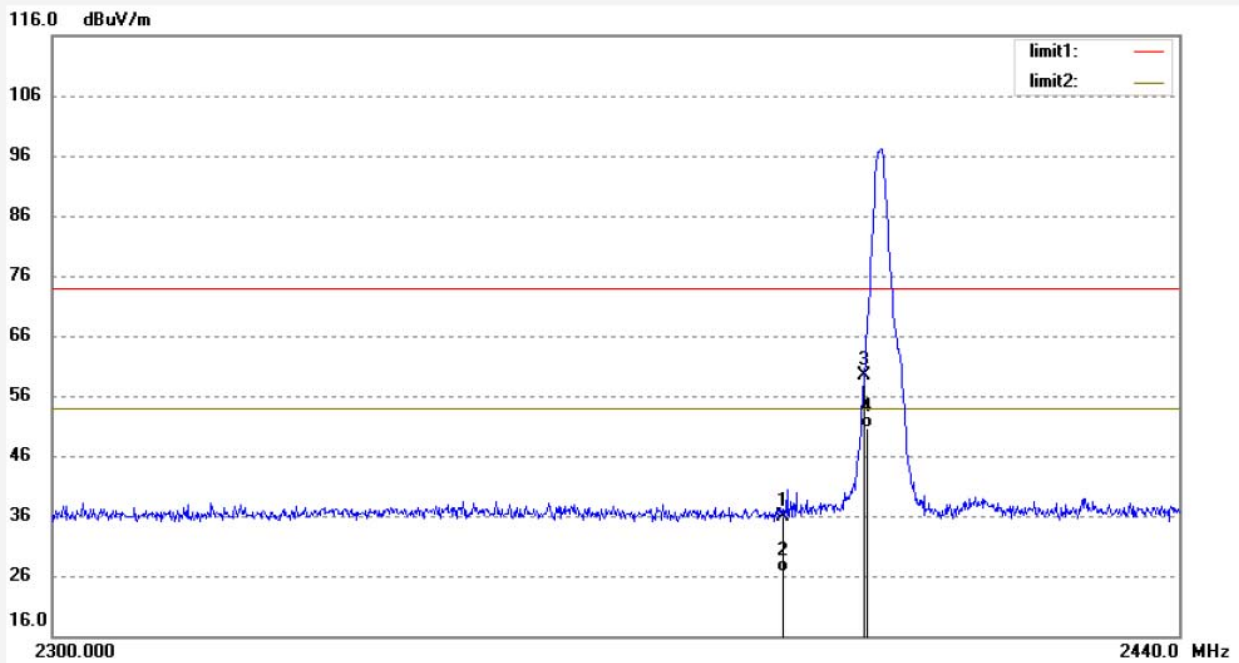

No.	Freq. (MHz)	Reading (dBuV/m)	Factor (dB)	Result (dBuV/m)	Limit (dBuV/m)	Margin (dB)	Detector	Height (cm)	Degree (deg.)	Remark
1	2390.000	43.84	-8.00	35.84	74.00	-38.16	peak	250	302	
2	2390.000	34.52	-8.00	26.52	54.00	-27.48	AVG	250	115	
3	2400.000	67.31	-7.97	59.34	74.00	-14.66	peak	250	204	
4	2400.000	58.66	-7.97	50.69	54.00	-3.31	AVG	250	66	

Note: Average measurement with peak detection at No.2&4



ACCURATE TECHNOLOGY CO., LTD.

F1,Bldg,A,Changyuan New Material Port Keyuan Rd,
Science & Industry Park,Nanshan Shenzhen,P.R.China

Site: 1# Chamber
Tel:+86-0755-26503290
Fax:+86-0755-26503396

Job No.: frank2018 #1146

Standard: FCC PK

Test item: Radiation Test

Temp.(C)/Hum.(%) 25 C / 55 %

EUT: Wireless earphones

Mode: TX2480MHz(GFSK)

Model: A2

Manufacturer: KINGVIE TECHNOLOGY CO., LIMITED

Polarization: Horizontal

Power Source: DC 3.7V

Date: 18/08/31/

Time: 14/38/27

Engineer Signature: Bob

Distance:

Note: Report NO.:ATE20181594

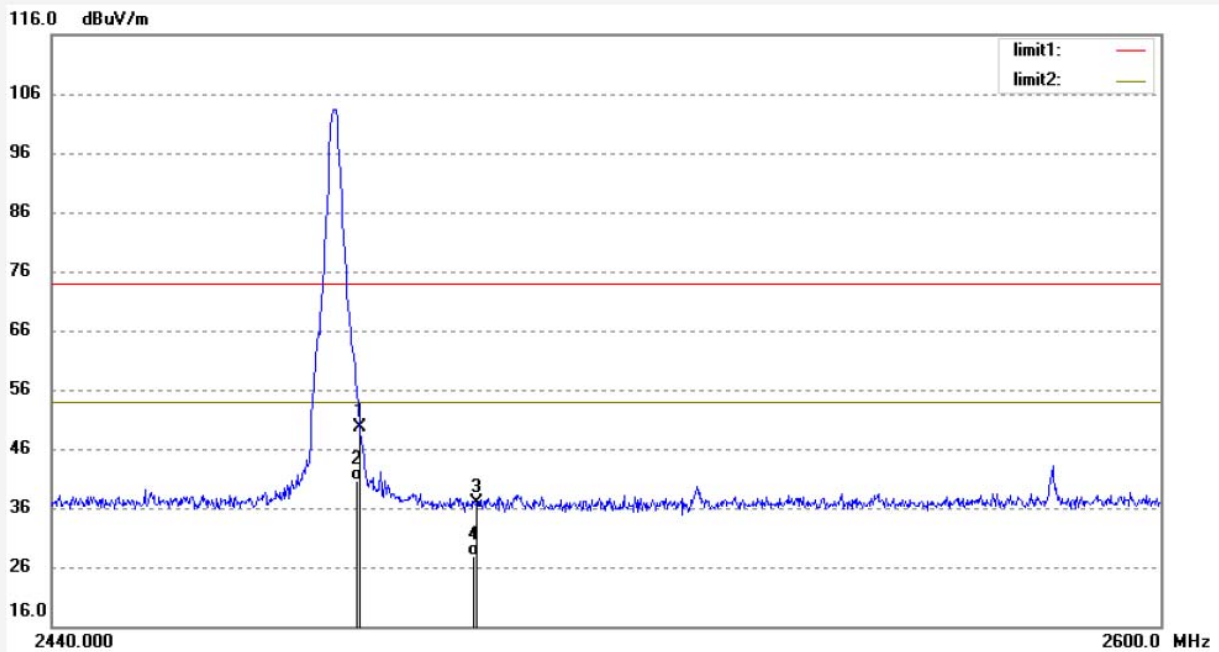

No.	Freq. (MHz)	Reading (dBuV/m)	Factor (dB)	Result (dBuV/m)	Limit (dBuV/m)	Margin (dB)	Detector	Height (cm)	Degree (deg.)	Remark
1	2483.500	57.49	-7.76	49.73	74.00	-24.27	peak	250	94	
2	2483.500	48.36	-7.76	40.60	54.00	-13.40	AVG	250	156	
3	2500.000	44.53	-7.71	36.82	74.00	-37.18	peak	250	320	
4	2500.000	35.65	-7.71	27.94	54.00	-26.06	AVG	250	102	

Note: Average measurement with peak detection at No.2&4



ACCURATE TECHNOLOGY CO., LTD.

F1,Bldg,A,Changyuan New Material Port Keyuan Rd,
Science & Industry Park,Nanshan Shenzhen,P.R.China

Site: 1# Chamber
Tel:+86-0755-26503290
Fax:+86-0755-26503396

Job No.: frank2018 #1147

Standard: FCC PK

Test item: Radiation Test

Temp.(C)/Hum.(%) 25 C / 55 %

EUT: Wireless earphones

Mode: TX2480MHz(GFSK)

Model: A2

Manufacturer: KINGVIE TECHNOLOGY CO., LIMITED

Polarization: Vertical

Power Source: DC 3.7V

Date: 18/08/31/

Time: 14/40/38

Engineer Signature: Bob

Distance:

Note: Report NO.:ATE20181594

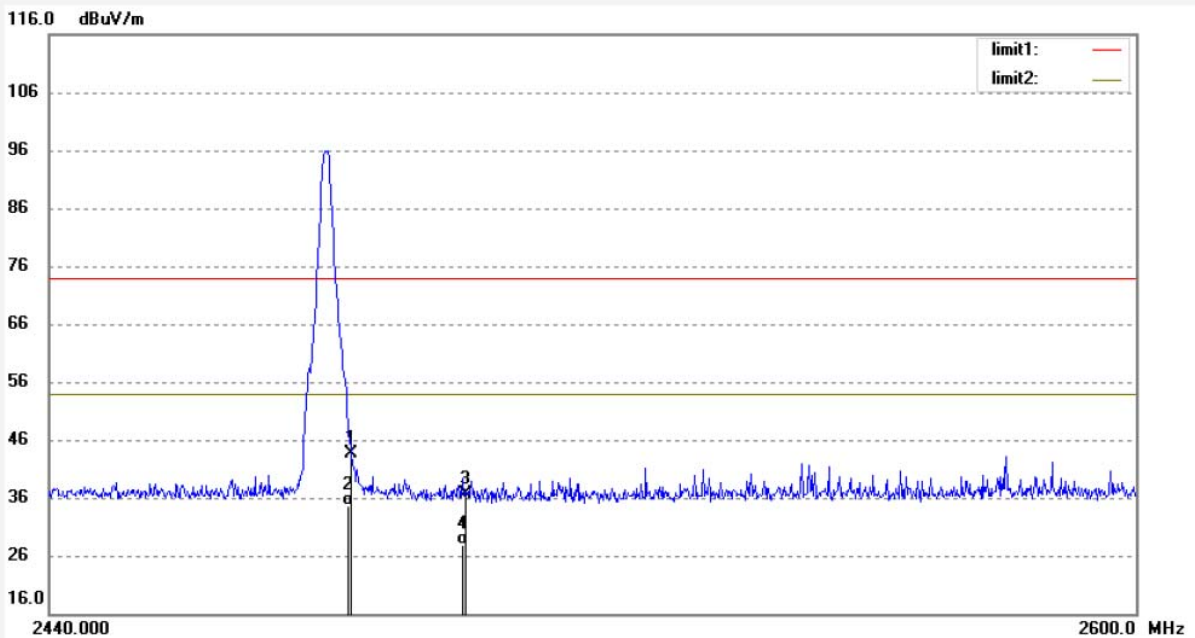

No.	Freq. (MHz)	Reading (dBuV/m)	Factor (dB)	Result (dBuV/m)	Limit (dBuV/m)	Margin (dB)	Detector	Height (cm)	Degree (deg.)	Remark
1	2483.500	51.38	-7.76	43.62	74.00	-30.38	peak	150	97	
2	2483.500	42.34	-7.76	34.58	54.00	-19.42	AVG	150	121	
3	2500.000	44.32	-7.71	36.61	74.00	-37.39	peak	150	156	
4	2500.000	35.65	-7.71	27.94	54.00	-26.06	AVG	150	360	

Note: Average measurement with peak detection at No.2&4

Hopping mode



ACCURATE TECHNOLOGY CO., LTD.

F1,Bldg,A,Changyuan New Material Port Keyuan Rd,
Science & Industry Park,Nanshan Shenzhen,P.R.China

Site: 1# Chamber
Tel:+86-0755-26503290
Fax:+86-0755-26503396

Job No.: frank2018 #1156	Polarization: Vertical
Standard: FCC PK	Power Source: DC 3.7V
Test item: Radiation Test	Date: 18/08/31/
Temp.(C)/Hum.(%) 25 C / 55 %	Time: 14/53/38
EUT: Wireless earphones	Engineer Signature: Bob
Mode: Hopping (GFSK)	Distance:
Model: A2	
Manufacturer: KINGVIE TECHNOLOGY CO., LIMITED	

Note: Report NO.:ATE20181594

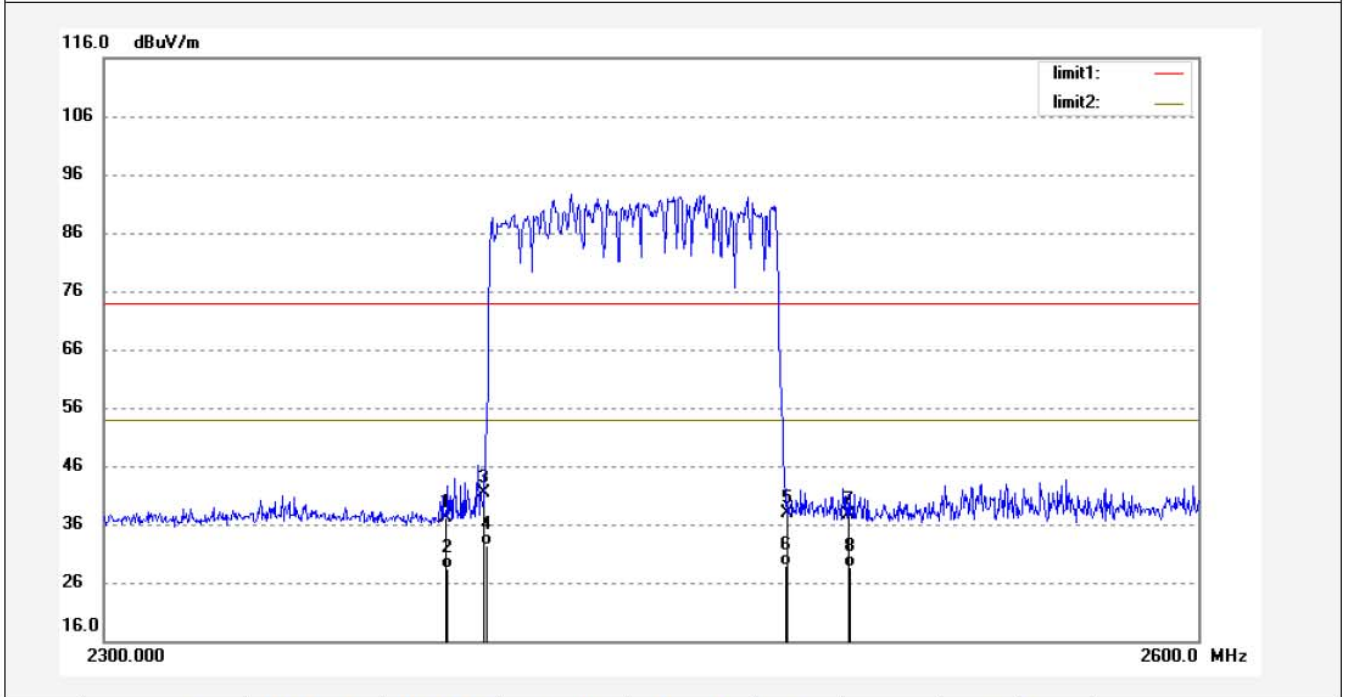

No.	Freq. (MHz)	Reading (dBuV/m)	Factor (dB)	Result (dBuV/m)	Limit (dBuV/m)	Margin (dB)	Detector	Height (cm)	Degree (deg.)	Remark
1	2390.000	45.02	-8.00	37.02	74.00	-36.98	peak	250	306	
2	2390.000	36.45	-8.00	28.45	54.00	-25.55	AVG	250	216	
3	2400.000	49.34	-7.97	41.37	74.00	-32.63	peak	250	52	
4	2400.000	40.25	-7.97	32.28	54.00	-21.72	AVG	250	123	
5	2483.500	45.65	-7.76	37.89	74.00	-36.11	peak	250	202	
6	2483.500	36.55	-7.76	28.79	54.00	-25.21	AVG	250	103	
7	2500.000	45.44	-7.71	37.73	74.00	-36.27	peak	250	232	
8	2500.000	36.22	-7.71	28.51	54.00	-25.49	AVG	250	201	

Note: Average measurement with peak detection at No.2&4&6&8



ACCURATE TECHNOLOGY CO., LTD.

F1,Bldg,A,Changyuan New Material Port Keyuan Rd,
Science & Industry Park,Nanshan Shenzhen,P.R.China

Site: 1# Chamber
Tel:+86-0755-26503290
Fax:+86-0755-26503396

Job No.: frank2018 #1157

Standard: FCC PK

Test item: Radiation Test

Temp.(C)/Hum.(%) 25 C / 55 %

EUT: Wireless earphones

Mode: Hopping (GFSK)

Model: A2

Manufacturer: KINGVIE TECHNOLOGY CO., LIMITED

Polarization: Horizontal

Power Source: DC 3.7V

Date: 18/08/31/

Time: 14/58/59

Engineer Signature: Bob

Distance:

Note: Report NO.:ATE20181594

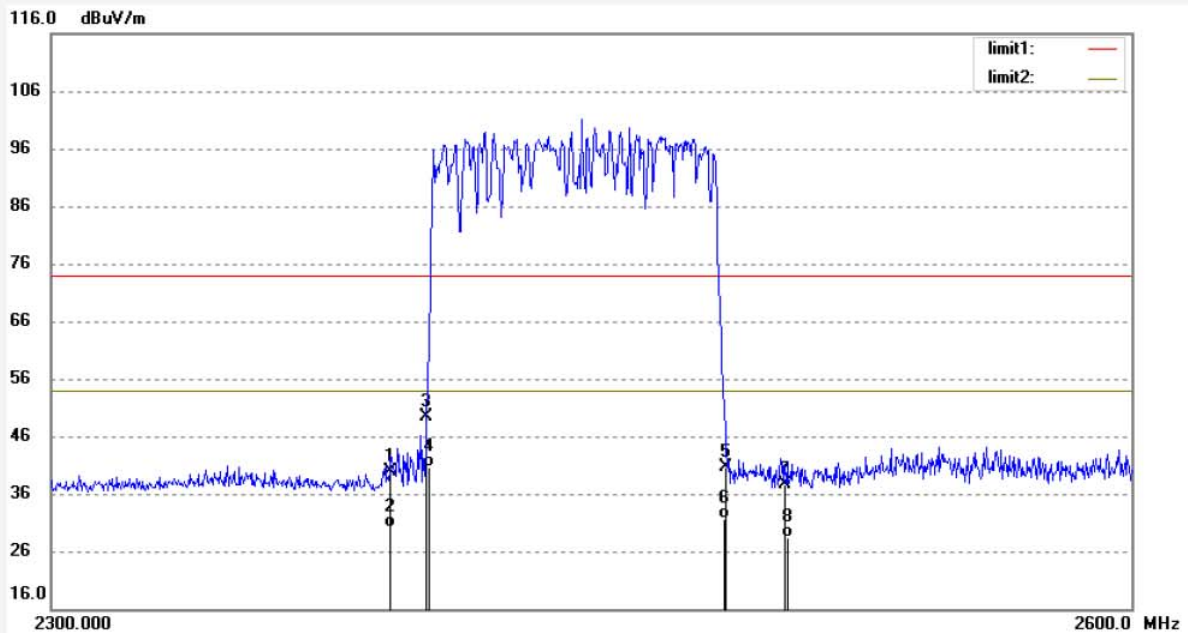

No.	Freq. (MHz)	Reading (dBuV/m)	Factor (dB)	Result (dBuV/m)	Limit (dBuV/m)	Margin (dB)	Detector	Height (cm)	Degree (deg.)	Remark
1	2390.000	47.88	-8.00	39.88	74.00	-34.12	peak	250	66	
2	2390.000	38.15	-8.00	30.15	54.00	-23.85	AVG	250	26	
3	2400.000	57.23	-7.97	49.26	74.00	-24.74	peak	250	224	
4	2400.000	48.48	-7.97	40.51	54.00	-13.49	AVG	250	123	
5	2483.500	48.46	-7.76	40.70	74.00	-33.30	peak	250	103	
6	2483.500	39.48	-7.76	31.72	54.00	-22.28	AVG	250	56	
7	2500.000	45.44	-7.71	37.73	74.00	-36.27	peak	250	204	
8	2500.000	36.19	-7.71	28.48	54.00	-25.52	AVG	250	301	

Note: Average measurement with peak detection at No.2&4&6&8

12.AC POWER LINE CONDUCTED EMISSION FOR FCC PART

15 SECTION 15.207(A)

12.1.Block Diagram of Test Setup

12.1.1.Block diagram of connection between the EUT and simulators

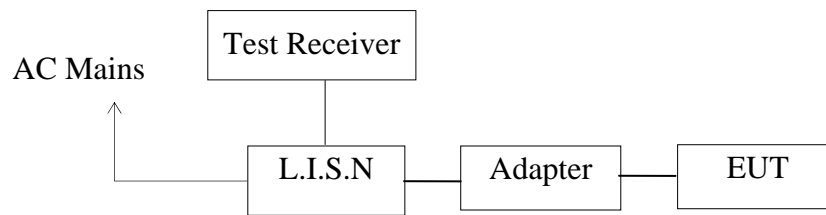

(EUT: Wireless earphones)

12.1.2.Test System Setup

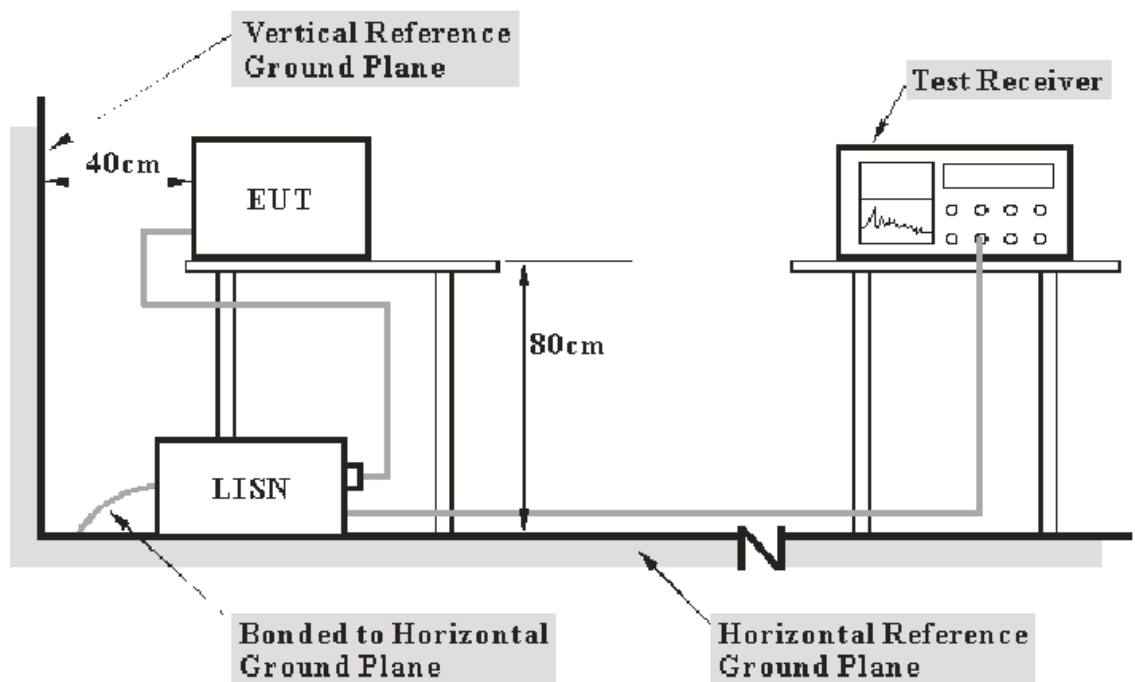

- Note: 1. Support units were connected to second LISN.
2. Both of LISNs (AMN) 80 cm from EUT and at the least 80 cm from other units and other metal planes support units.

12.2. Power Line Conducted Emission Measurement Limits

Frequency (MHz)	Limit dB(μV)	
	Quasi-peak Level	Average Level
0.15 - 0.50	66.0 – 56.0 *	56.0 – 46.0 *
0.50 - 5.00	56.0	46.0
5.00 - 30.00	60.0	50.0

NOTE1: The lower limit shall apply at the transition frequencies.
 NOTE2: The limit decreases linearly with the logarithm of the frequency in the range 0.15MHz to 0.50MHz.

12.3. Configuration of EUT on Measurement

The equipments are installed on Power Line Conducted Emission Measurement to meet the commission requirement and operating regulations in a manner, which tends to maximize its emission characteristics in a normal application.

12.4. Operating Condition of EUT

12.4.1. Setup the EUT and simulator as shown as Section 12.1.

12.4.2. Turn on the power of all equipment.

12.4.3. Let the EUT work in test mode and measure it.

12.5. Test Procedure

The EUT is put on the plane 0.8m high above the ground by insulating support and is connected to the power mains through a line impedance stabilization network (L.I.S.N.). This provides a 50ohm coupling impedance for the EUT system. Please refer the block diagram of the test setup and photographs. Both sides of AC lines are checked to find out the maximum conducted emission. In order to find the maximum emission levels, the relative positions of equipment and all of the interface cables shall be changed according to ANSI C63.10: 2013 on Conducted Emission Measurement. The bandwidth of test receiver (R & S ESCS30) is set at 9kHz.

The frequency range from 150kHz to 30MHz is checked.

12.6.Data Sample

Frequency (MHz)	Transducer value (dB)	QuasiPeak Level (dBμV)	Average Level (dBμV)	QuasiPeak Limit (dBμV)	Average Limit (dBμV)	QuasiPeak Margin (dB)	Average Margin (dB)	Remark (Pass/Fail)
X.XX	10.5	51.1	34.2	56.0	46.0	4.9	11.8	Pass

Frequency(MHz) = Emission frequency in MHz

Transducer value(dB) = Insertion loss of LISN + Cable Loss

Level(dBμV) = Quasi-peak Reading/Average Reading + Transducer value

Limit (dBμV) = Limit stated in standard

Margin = Limit (dBμV) - Level (dBμV)

Calculation Formula:

Margin = Limit (dBμV) - Level (dBμV)

12.7.Power Line Conducted Emission Measurement Results

PASS.

Test Lab: Shielding room

Test Engineer: Bob

The frequency range from 150kHz to 30MHz is checked.

Maximizing procedure was performed on the six (6) highest emissions of the EUT. Emissions attenuated more than 20 dB below the permissible value are not reported.

All data was recorded in the Quasi-peak and average detection mode.

The spectral diagrams are attached as below.

ACCURATE TECHNOLOGY CO., LTD

CONDUCTED EMISSION STANDARD FCC PART 15B

EUT: Wireless earphones M/N:A2
 Manufacturer: KINGVIE TECHNOLOGY CO., LIMITED
 Operating Condition: Charging and Operating
 Test Site: 2#Shielding Room
 Operator: Bob
 Test Specification: N 120V/60Hz
 Comment: Report NO.:ATE20181594
 Start of Test: 2018-8-31 / 17:23:28

SCAN TABLE: "V 150K-30MHz fin"

Short Description: _SUB_STD_VTERM2 1.70
 Start Stop Step Detector Meas. IF Transducer
 Frequency Frequency Width Time Bandw.
 150.0 kHz 30.0 MHz 4.5 kHz QuasiPeak 1.0 s 9 kHz NSLK8126 2008
 Average

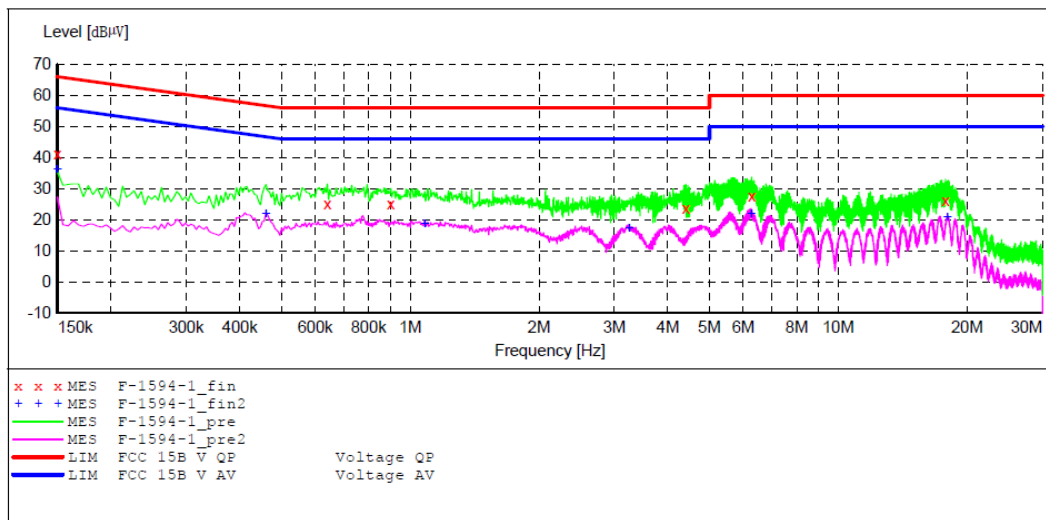

MEASUREMENT RESULT: "F-1594-1_fin"

2018-8-31 17:25

Frequency MHz	Level dBµV	Transd dB	Limit dBµV	Margin dB	Detector	Line	PE
0.150000	41.30	10.8	66	24.7	QP	N	GND
0.640500	25.30	11.0	56	30.7	QP	N	GND
0.901500	25.30	11.1	56	30.7	QP	N	GND
4.402500	23.60	11.4	56	32.4	QP	N	GND
6.274500	27.60	11.5	60	32.4	QP	N	GND
17.821500	26.40	11.7	60	33.6	QP	N	GND

MEASUREMENT RESULT: "F-1594-1_fin2"

2018-8-31 17:25

Frequency MHz	Level dBµV	Transd dB	Limit dBµV	Margin dB	Detector	Line	PE
0.150000	36.20	10.8	56	19.8	AV	N	GND
0.460500	22.10	11.0	47	24.6	AV	N	GND
1.081500	18.60	11.1	46	27.4	AV	N	GND
3.246000	17.30	11.4	46	28.7	AV	N	GND
6.256500	22.00	11.5	50	28.0	AV	N	GND
17.988000	20.80	11.7	50	29.2	AV	N	GND

ACCURATE TECHNOLOGY CO., LTD

CONDUCTED EMISSION STANDARD FCC PART 15B

EUT: Wireless earphones M/N:A2
 Manufacturer: KINGVIE TECHNOLOGY CO., LIMITED
 Operating Condition: Charging and Operating
 Test Site: 2#Shielding Room
 Operator: Bob
 Test Specification: L 120V/60Hz
 Comment: Report NO.:ATE20181594
 Start of Test: 2018-8-31 / 17:26:25

SCAN TABLE: "V 150K-30MHz fin"

Short Description: _SUB_STD_VTERM2 1.70
 Start Stop Step Detector Meas. IF Transducer
 Frequency Frequency Width Time Bandw.
 150.0 kHz 30.0 MHz 4.5 kHz QuasiPeak 1.0 s 9 kHz NSLK8126 2008
 Average

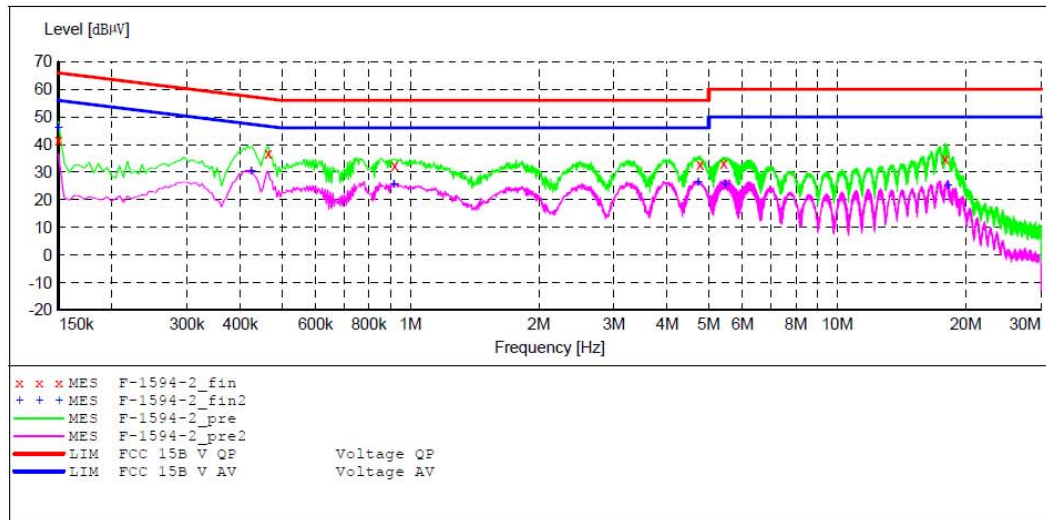

MEASUREMENT RESULT: "F-1594-2_fin"

2018-8-31 17:28

Frequency MHz	Level dBµV	Transd dB	Limit dBµV	Margin dB	Detector	Line	PE
0.150000	41.80	10.8	66	24.2	QP	L1	GND
0.465000	36.80	11.0	57	19.8	QP	L1	GND
0.919500	32.40	11.1	56	23.6	QP	L1	GND
4.771500	32.90	11.4	56	23.1	QP	L1	GND
5.415000	33.10	11.5	60	26.9	QP	L1	GND
17.902500	34.70	11.7	60	25.3	QP	L1	GND

MEASUREMENT RESULT: "F-1594-2_fin2"

2018-8-31 17:28

Frequency MHz	Level dBµV	Transd dB	Limit dBµV	Margin dB	Detector	Line	PE
0.150000	46.00	10.8	56	10.0	AV	L1	GND
0.424500	30.40	11.0	47	17.0	AV	L1	GND
0.915000	25.50	11.1	46	20.5	AV	L1	GND
4.726500	26.30	11.4	46	19.7	AV	L1	GND
5.464500	25.70	11.5	50	24.3	AV	L1	GND
18.145500	25.20	11.7	50	24.8	AV	L1	GND

13. ANTENNA REQUIREMENT

13.1. The Requirement

According to Section 15.203, an intentional radiator shall be designed to ensure that no antenna other than that furnished by the responsible party shall be used with the device.

13.2. Antenna Construction

Device is equipped with permanent attached antenna, which isn't displaced by other antenna. The Max Antenna gain of EUT is 2.5dBi. Therefore, the equipment complies with the antenna requirement of Section 15.203.

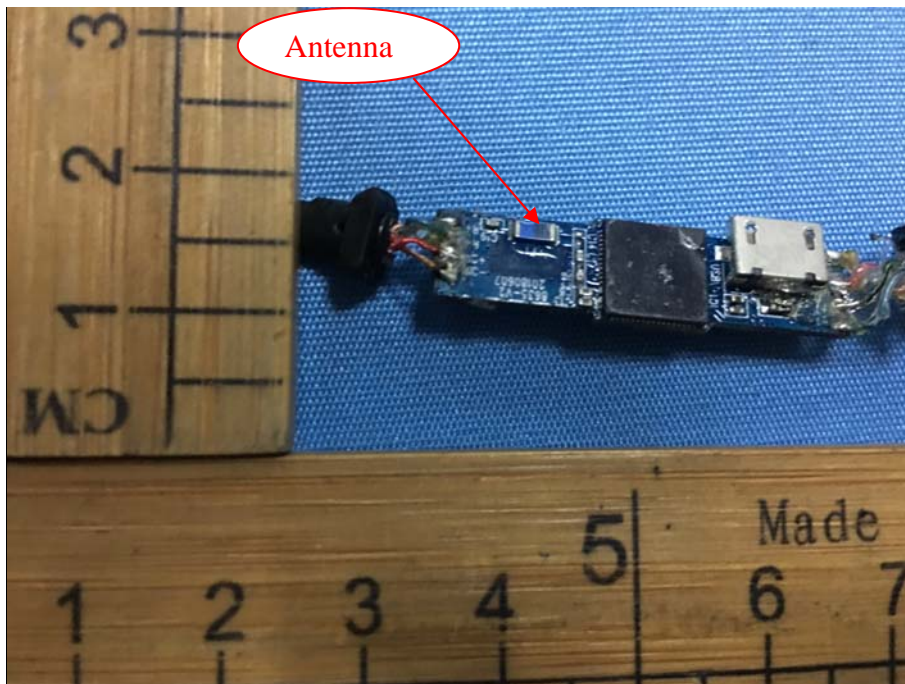

***** End of Test Report *****