

FCC RF TEST REPORT
No. 171201124SHA-001

Applicant : Ningbo Litesun Electronics Co., Ltd.
Simen Town, Yuyao City, Zhejiang, 315472, China

Manufacturer : Ningbo Litesun Electronics Co., Ltd.
Simen Town, Yuyao City, Zhejiang, 315472, China

Product Name : Smart Plug

Type/Model : LA-WF2

TEST RESULT : PASS

SUMMARY

The equipment complies with the requirements according to the following standard(s) or specification:

47CFR Part 15 (2017): Radio Frequency Devices (Subpart C)

ANSI C63.10 (2013): American National Standard of Procedures for Compliance Testing of Unlicensed Wireless Devices

Date of issue: Jan 23, 2018

Prepared by:



Teddy Yin (Project engineer)

Reviewed by:



Daniel Zhao (Reviewer)

Description of Test Facility

Name: Intertek Testing Service Limited Shanghai
Address: Building No.86, 1198 Qinzhou Road (North), Shanghai 200233, P.R. China

FCC Designation Number: CN1175
IC Assigned Code: 2402B-1

Name of contact: Leah Xu
Tel: 86 21 61278200
Fax: 86 21 54262353

Content

SUMMARY	1
DESCRIPTION OF TEST FACILITY	2
1 GENERAL INFORMATION	5
1.1 DESCRIPTION OF CLIENT	5
1.2 IDENTIFICATION OF THE EUT	5
1.3 TECHNICAL SPECIFICATION	6
2 TEST SPECIFICATIONS	7
2.1 STANDARDS OR SPECIFICATION	7
2.2 MODE OF OPERATION DURING THE TEST.....	7
2.3 TEST SOFTWARE LIST	8
2.4 TEST PERIPHERALS LIST	8
2.5 INSTRUMENT LIST	9
2.6 TEST SUMMARY	10
2.7 MEASUREMENT UNCERTAINTY	11
3 MINIMUM 6DB BANDWIDTH	12
3.1 LIMIT	12
3.2 TEST CONFIGURATION	12
3.3 TEST PROCEDURE AND TEST SETUP	12
3.4 TEST PROTOCOL	13
4 MAXIMUM CONDUCTED OUTPUT POWER	14
4.1 TEST LIMIT	14
4.2 TEST CONFIGURATION	14
4.3 TEST PROCEDURE AND TEST SETUP	15
4.4 TEST PROTOCOL	16
5 POWER SPECTRUM DENSITY	17
5.1 TEST LIMIT	17
5.2 TEST CONFIGURATION	17
5.3 TEST PROCEDURE AND TEST SETUP	18
5.4 TEST PROTOCOL	19
6 EMISSION OUTSIDE THE FREQUENCY BAND	20
6.1 TEST LIMIT	20
6.2 TEST CONFIGURATION	20
6.3 TEST PROCEDURE AND TEST SETUP	21
6.4 TEST PROTOCOL	22
7 RADIATED EMISSIONS	23
7.1 TEST LIMIT	23
7.2 TEST CONFIGURATION	23
7.3 TEST PROCEDURE AND TEST SETUP	25
7.4 TEST PROTOCOL	27
8 POWER LINE CONDUCTED EMISSION	32
8.1 LIMIT	32
8.2 TEST CONFIGURATION	32
8.3 TEST PROCEDURE AND TEST SET UP	33
8.4 TEST PROTOCOL	34
9 ANTENNA REQUIREMENT	36

APPENDIX A: TEST RESULTS37

1 GENERAL INFORMATION

1.1 Description of Client

Applicant : Ningbo Litesun Electronics Co., Ltd.
Simen Town, Yuyao City, Zhejiang, 315472, China

Name of contact : Mr. Ding Gang Gang

Tel : 0086-574-62128318

Fax : 0086-574-62128700

Manufacturer : Ningbo Litesun Electronics Co., Ltd.
Simen Town, Yuyao City, Zhejiang, 315472, China

1.2 Identification of the EUT

Product Name : Smart Plug

Type/model : LA-WF2

FCC ID : 2AMQ8-WIFI-002

1.3 Technical Specification

Operation Frequency : 2412~2462MHz
Band

Type of Modulation : DBPSK, DQPSK, CCK, BPSK, QPSK, 16-QAM,
64-QAM

EUT Modes of Modulation : 802.11b, 802.11g, 802.11n(HT20)

Channel Number : 11Channels for 802.11b, 802.11g and 802.11n(HT20)

Description of EUT : The EUT is a smart plug, it support WIFI 2.4G band, and there is only one model. We tested it and listed the 2.4G band results in this report.

Antenna : PCB antenna, 3.0dBi gain

Rating : 125VAC 60Hz 10A Max.1250W resistive or general purpose, 5A
Max.625W tungsten lamp

Category of EUT : Class B

EUT type : Table top
 Floor standing

Sample received date : Jan 5, 2018

Date of test : Jan 5~Jan 22, 2018

2 TEST SPECIFICATIONS

2.1 Standards or specification

47CFR Part 15 (2017)
ANSI C63.10 (2013)
KDB 558074 (v04)

2.2 Mode of operation during the test

While testing transmitting mode of EUT, the internal modulation and continuously transmission was applied.

The EUT is a small unlicensed wireless device, so three axes (X, Y, Z) were observed while the test receiver worked as “max hold” continuously and the highest reading (X axis) among the whole test procedure was recorded.

The lowest, middle and highest channel were tested as representatives.

Frequency Band (MHz)	Mode	Lowest (MHz)	Middle (MHz)	Highest (MHz)
2400-2483.5	802.11b	2412	2437	2462
	802.11g	2412	2437	2462
	802.11n(HT20)	2412	2437	2462
	/	/	/	/

Data rate VS Power:

The pre-scan for the conducted power with all rates in each modulation and bands was used, and the worst case was found and used in all test cases.

After this pre-scan, we choose the following table of the data rata as the worst case.

Frequency Band (MHz)	Mode	Worst case data rate
2400-2483.5	802.11b	1Mbps
	802.11g	6Mbps
	802.11n(HT20)	MCS0
	/	/

2.3 Test software list

Test Items	Software	Manufacturer	Version
Conducted emission	ESxS-K1	R&S	V2.1.0
Radiated emission	ES-K1	R&S	V1.71

2.4 Test peripherals list

Item No.	Name	Band and Model	Description
1	Laptop computer	HP ProBook 6470b	100-240V AC, 50/60Hz
2	Lamp	--	200W

2.5 Instrument list

Conducted Emission					
Used	Equipment	Manufacturer	Type	Internal no.	Due date
<input checked="" type="checkbox"/>	Test Receiver	R&S	ESCS 30	EC 2107	2018-09-12
<input checked="" type="checkbox"/>	A.M.N.	R&S	ESH2-Z5	EC 3119	2018-12-07
<input checked="" type="checkbox"/>	Shielded room	Zhongyu	-	EC 2838	2019-01-07
Radiated Emission					
Used	Equipment	Manufacturer	Type	Internal no.	Due date
<input checked="" type="checkbox"/>	Test Receiver	R&S	ESIB 26	EC 3045	2018-09-12
<input checked="" type="checkbox"/>	Bilog Antenna	TESEQ	CBL 6112D	EC 4206	2018-05-30
<input checked="" type="checkbox"/>	Horn antenna	R&S	HF 906	EC 3049	2018-09-23
<input checked="" type="checkbox"/>	Horn antenna	TOYO	HAP18-26W	EC 4792-3	2018-07-09
<input checked="" type="checkbox"/>	Pre-amplifier	R&S	Pre-amp 18	EC5881	2018-06-19
<input checked="" type="checkbox"/>	Semi-anechoic chamber	Albatross project	-	EC 3048	2018-09-15
RF test					
Used	Equipment	Manufacturer	Type	Internal no.	Due date
<input checked="" type="checkbox"/>	PXA Signal Analyzer	Keysight	N9030A	EC 5338	2018-09-10
<input type="checkbox"/>	Power sensor	Agilent	U2021XA	EC 5338-1	2018-03-06
<input type="checkbox"/>	Vector Signal Generator	Agilent	N5182B	EC 5175	2018-03-06
<input type="checkbox"/>	MXG Analog Signal Generator	Agilent	N5181A	EC 5338-2	2018-03-03
<input type="checkbox"/>	Mobile Test System	Litepoint	Iqxel	EC 5176	2019-01-11
<input checked="" type="checkbox"/>	Power meter	Agilent	N1911A/N1921A	EC4318	2018-05-12
Additional instrument					
Used	Equipment	Manufacturer	Type	Internal no.	Due date
<input checked="" type="checkbox"/>	Therom-Hygrograph	ZJ1-2A	S.M.I.F.	EC 2323	2018-06-14
<input checked="" type="checkbox"/>	Therom-Hygrograph	ZJ1-2A	S.M.I.F.	EC 3325	2018-03-23

2.6 Test Summary

This report applies to tested sample only. The test results have been compared directly with the limits, and the measurement uncertainty is recorded. This report shall not be reproduced in part without written approval of Intertek Testing Service Shanghai Limited.

TEST ITEM	FCC REFERANCE	RESULT
Minimum 6dB Bandwidth	15.247(a)(2)	Pass
Maximum peak output power	15.247(b)	Pass
Power spectrum density	15.247(e)	Pass
Radiated emission	15.205 & 15.209	Pass
Emission outside the frequency band	15.247(d)	Pass
Power line conducted emission	15.207	Pass

Notes: 1: NA =Not Applicable

2: This report is for the exclusive use of Intertek's Client and is provided pursuant to the agreement between Intertek and its Client. Intertek's responsibility and liability are limited to the terms and conditions of the agreement. Intertek assumes no liability to any party, other than to the Client in accordance with the agreement, for any loss, expense or damage occasioned by the use of this report. Only the Client is authorized to permit copying or distribution of this report and then only in its entirety. Any use of the Intertek name or one of its marks for the sale or advertisement of the tested material, product or service must first be approved in writing by Intertek. The observations and test results in this report are relevant only to the sample tested. This report by itself does not imply that the material, product, or service is or has ever been under an Intertek certification program.

2.7 Measurement uncertainty

The measurement uncertainty represents an expanded uncertainty expressed at approximately the 95% confidence level using a coverage factor of k=2.

Test item	Measurement uncertainty
Maximum peak output power	± 0.74dB
Radiated Emissions in restricted frequency bands below 1GHz	± 4.90dB
Radiated Emissions in restricted frequency bands above 1GHz	± 5.02dB
Emission outside the frequency band	± 2.89dB
Power line conducted emission	± 3.19dB

3 Minimum 6dB Bandwidth

Test result: Pass

3.1 Limit

For systems using digital modulation techniques that may operate in the 902 - 928 MHz, 2400 - 2483.5 MHz and 5725 - 5850 MHz bands, the minimum 6 dB bandwidth shall be at least 500 kHz.

3.2 Test Configuration

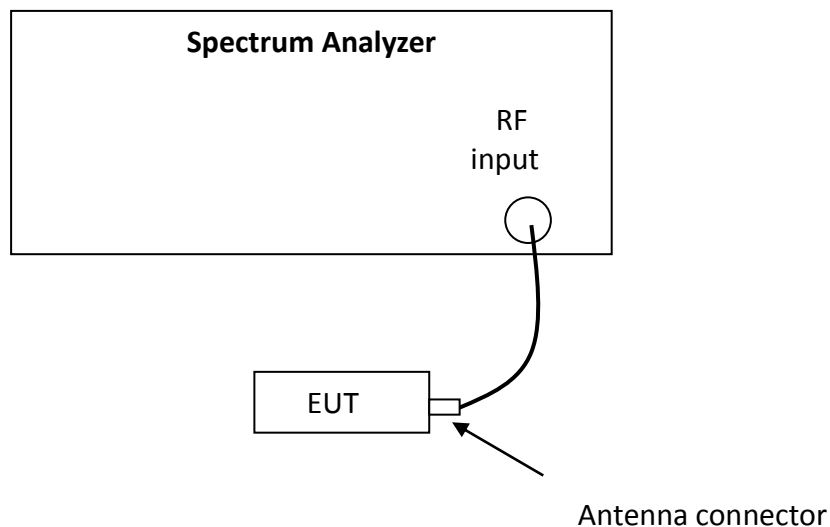

3.3 Test Procedure and test setup

The minimum 6dB bandwidth per FCC §15.247(a)(2) is measured using the Spectrum Analyzer according to DTS test procedure of "KDB558074 D01 DTS Meas Guidance" for compliance to FCC 47CFR 15.247 requirements (clause 8.2).

- a) Set RBW = 100 kHz.
- b) Set the video bandwidth (VBW) $\geq 3 \times$ RBW.
- c) Detector = Peak.
- d) Trace mode = max hold.
- e) Sweep = auto couple.
- f) Allow the trace to stabilize.
- g) Measure the maximum width of the emission that is constrained by the frequencies associated with the two outermost amplitude points (upper and lower frequencies) that are attenuated by 6 dB relative to the maximum level measured in the fundamental emission.

3.4 Test Protocol

Temperature: 25 °C

Relative Humidity: 55 %

Test Results of Minimum 6dB bandwidth

Please refer to Appendix A

4 Maximum Conducted Output power

Test result: Pass

4.1 Test limit

- For frequency hopping systems operating in the 2400-2483.5 MHz band employing at least 75 non-overlapping hopping channels, and all frequency hopping systems in the 5725-5850 MHz band: 1 watt
- For all other frequency hopping systems in the 2400-2483.5 MHz band: 0.125 watts
- For systems using digital modulation in the 902-928 MHz, 2400-2483.5 MHz, and 5725-5850 MHz bands: 1 Watt and the e.i.r.p. shall not exceed 4 W.

If the transmitting antenna of directional gain greater than 6dBi is used, the power shall be reduced by the amount in dB that the directional gain of the antenna exceeds 6dBi. If there have a beam forming type, the limit should be the minimum of 30dBm and 30+ (6 –antenna gain-beam forming gain).

4.2 Test Configuration

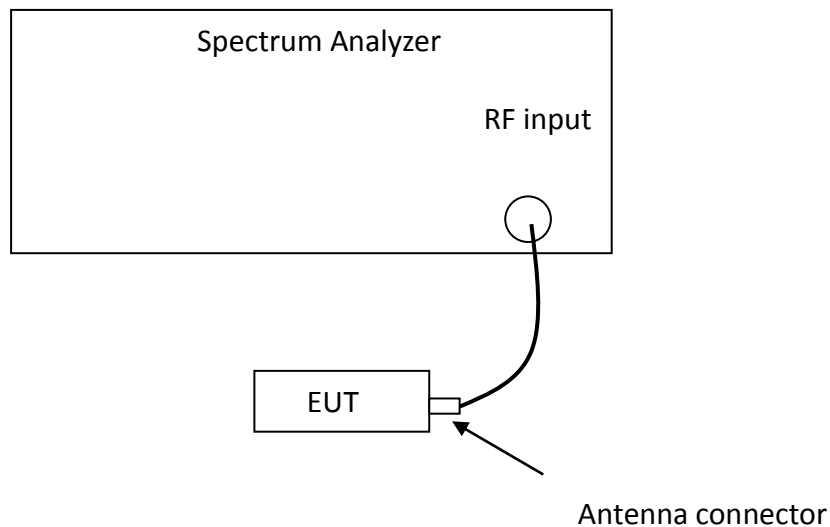

4.3 Test procedure and test setup

The EUT was tested according to DTS test procedure of “KDB558074 D01 DTS Meas Guidance” for compliance to FCC 47CFR 15.247 requirements (clause 9.2.2.4).

- a) Measure the duty cycle, x , of the transmitter output signal as described in Section 6.0.
- b) Set span to at least $1.5 \times \text{OBW}$.
- c) Set RBW = 1 % to 5 % of the OBW, not to exceed 1 MHz.
- d) Set VBW $\geq 3 \times \text{RBW}$.
- e) Number of points in sweep $\geq 2 \times \text{span} / \text{RBW}$. (This gives bin-to-bin spacing $\leq \text{RBW}/2$, so that narrowband signals are not lost between frequency bins.)
- f) Sweep time = auto.
- g) Detector = RMS (i.e., power averaging), if available. Otherwise, use sample detector mode.
- h) Do not use sweep triggering. Allow the sweep to “free run”.
- i) Trace average at least 100 traces in power averaging (i.e., RMS) mode; however, the number of traces to be averaged shall be increased above 100 as needed such that the average accurately represents the true average over the on and off periods of the transmitter.
- j) Compute power by integrating the spectrum across the OBW of the signal using the instrument’s band power measurement function with band limits set equal to the OBW band edges. If the instrument does not have a band power function, sum the spectrum levels (in power units) at intervals equal to the RBW extending across the entire OBW of the spectrum.
- k) Add $10 \log (1/x)$, where x is the duty cycle, to the measured power in order to compute the average power during the actual transmission times (because the measurement represents an average over both the on- and off-times of the transmission). For example, add $10 \log (1/0.25) = 6 \text{ dB}$ if the duty cycle is 25 %.

4.4 Test protocol

Temperature: 25 °C

Relative Humidity: 55 %

Test Results of Maximum conducted output power

Please refer to Appendix A

5 Power spectrum density

Test result:Pass

5.1 Test limit

For digitally modulated systems, the power spectral density conducted from the intentional radiator to the antenna shall not be greater than 8dBm in any 3kHz band during any time interval of continuous transmission.

If the transmitting antenna of directional gain greater than 6dBi is used, the power shall be reduced by the amount in dB that the directional gain of the antenna exceeds 6dBi. If there have a beam forming type, the limit should be the minimum of 8dBm/3kHz and $8 + (6 - \text{antenna gain} - \text{beam forming gain})$.

5.2 Test Configuration

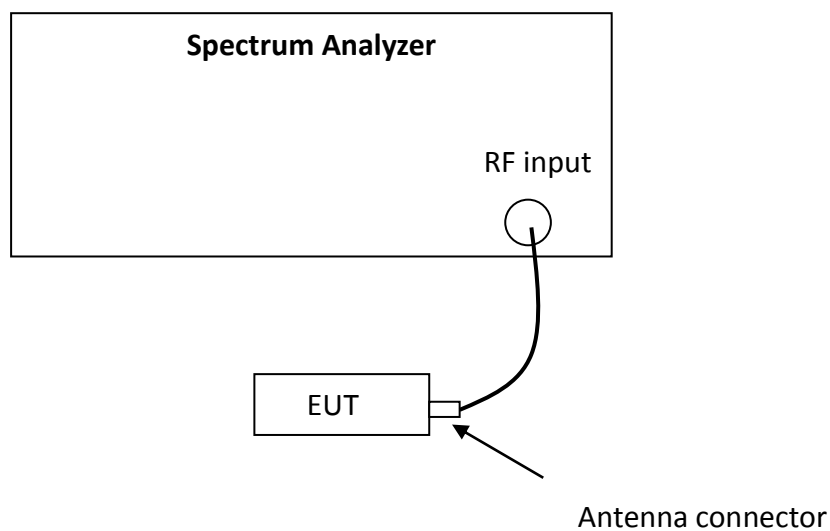

5.3 Test procedure and test setup

The power output per FCC §15.247(e) was tested according to DTS test procedure of “KDB558074 D01 DTS Meas Guidance” (clause 10.5) for compliance to FCC 47CFR 15.247 requirements.

This procedure is applicable when the EUT cannot be configured to transmit continuously (i.e., duty cycle < 98 %), and when sweep triggering/signal gating cannot be used to measure only when the EUT is transmitting at its maximum power control level, and when the transmission duty cycle is constant (i.e., duty cycle variations are less than $\pm 2\%$):

- a) Measure the duty cycle (x) of the transmitter output signal as described in Section 6.0.
- b) Set instrument center frequency to DTS channel center frequency.
- c) Set span to at least $1.5 \times \text{OBW}$.
- d) Set RBW to: $3 \text{ kHz} \leq \text{RBW} \leq 100 \text{ kHz}$.
- e) Set VBW $\geq 3 \times \text{RBW}$.
- f) Detector = power averaging (RMS) or sample detector (when RMS not available).
- g) Ensure that the number of measurement points in the sweep $\geq 2 \times \text{span/RBW}$.
- h) Sweep time = auto couple.
- i) Do not use sweep triggering. Allow sweep to “free run”.
- j) Employ trace averaging (RMS) mode over a minimum of 100 traces.
- k) Use the peak marker function to determine the maximum amplitude level.
- l) Add $10 \log(1/x)$, where x is the duty cycle measured in step (a), to the measured PSD to compute the average PSD during the actual transmission time.
- m) If resultant value exceeds the limit, then reduce RBW (no less than 3 kHz) and repeat (note that this may require zooming in on the emission of interest and reducing the span in order to meet the minimum measurement point requirement as the RBW is reduced).

5.4 Test Protocol

Temperature: 25 °C

Relative Humidity: 55 %

Test Results of Power spectrum density

Please refer to Appendix A

6 Emission outside the frequency band

Test result: Pass

6.1 Test limit

In any 100 kHz bandwidth outside the frequency band in which the spread spectrum intentional radiator is operating, the radio frequency power that is produced by the intentional radiator shall be at least 30 dB below that in the 100 kHz bandwidth within the band that contains the highest level of the desired power.

6.2 Test Configuration

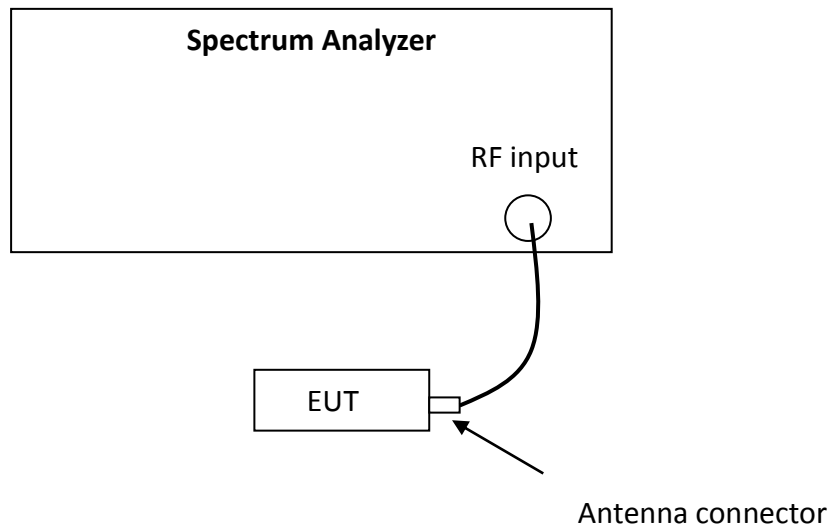

6.3 Test procedure and test setup

The EUT was tested according to DTS test procedure of “KDB558074 D01 DTS Meas Guidance” (clause 11.0) for compliance to FCC 47CFR 15.247 requirements.

Reference level measurement

Establish a reference level by using the following procedure:

- a) Set instrument center frequency to DTS channel center frequency.
- b) Set the span to ≥ 1.5 times the *DTS bandwidth*.
- c) Set the RBW = 100 kHz.
- d) Set the VBW $\geq 3 \times$ RBW.
- e) Detector = peak.
- f) Sweep time = auto couple.
- g) Trace mode = max hold.
- h) Allow trace to fully stabilize.
- i) Use the peak marker function to determine the maximum PSD level.

Note that the channel found to contain the maximum PSD level can be used to establish the reference level.

Emission level measurement

- a) Set the center frequency and span to encompass frequency range to be measured.
- b) Set the RBW = 100 kHz.
- c) Set the VBW $\geq 3 \times$ RBW.
- d) Detector = peak.
- e) Sweep time = auto couple.
- f) Trace mode = max hold.
- g) Allow trace to fully stabilize.
- h) Use the peak marker function to determine the maximum amplitude level.

Ensure that the amplitude of all unwanted emissions outside of the authorized frequency band (excluding restricted frequency bands) are attenuated by at least the minimum requirements specified in 11.1 a) or 11.1 b). Report the three highest emissions relative to the limit.

6.4 Test Protocol

Temperature: 25 °C

Relative Humidity: 55 %

The results of Emission outside the frequency band

Please refer to Appendix A

7 Radiated Emissions

Test result: Pass

7.1 Test limit

The radiated emissions which fall in the restricted bands, as defined in §15.205(a), must also comply with the radiated emission limits specified in §15.209(a) showed as below:

Frequencies (MHz)	Field Strength (microvolts/meter)	Measurement Distance (meters)
0.009 ~ 0.490	2400/F(kHz)	300
0.490 ~ 1.705	24000/F(kHz)	30
1.705 ~ 30.0	30	30
30 ~ 88	100	3
88 ~ 216	150	3
216 ~ 960	200	3
Above 960	500	3

7.2 Test Configuration

For Radiated emission below 30MHz:

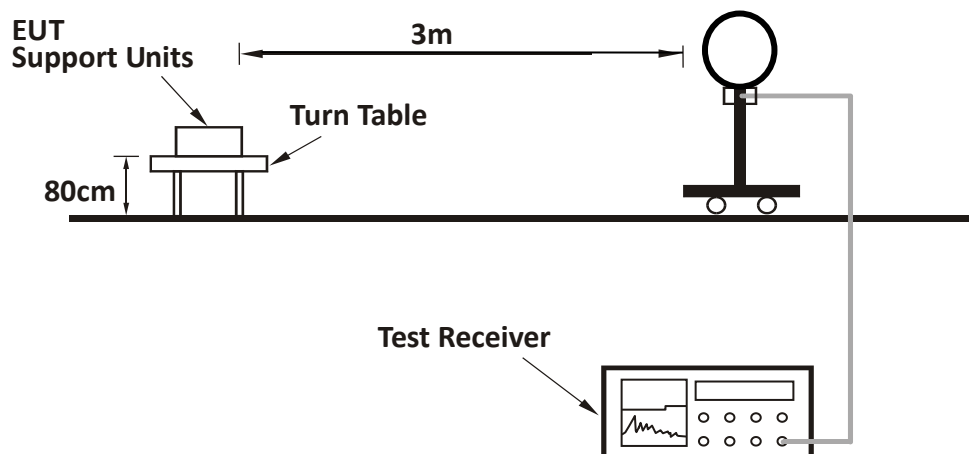

For Radiated emission 30MHz to 1GHz:

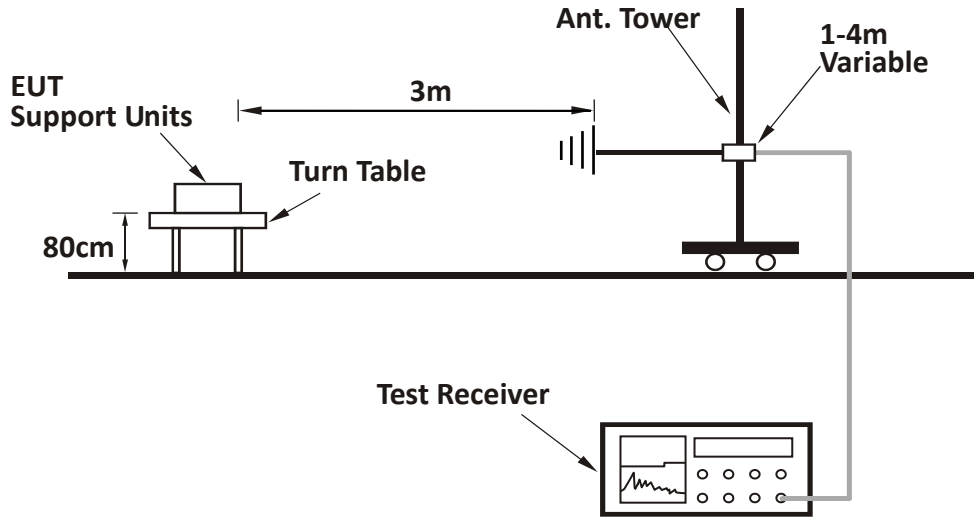

For Radiated emission above 1GHz:

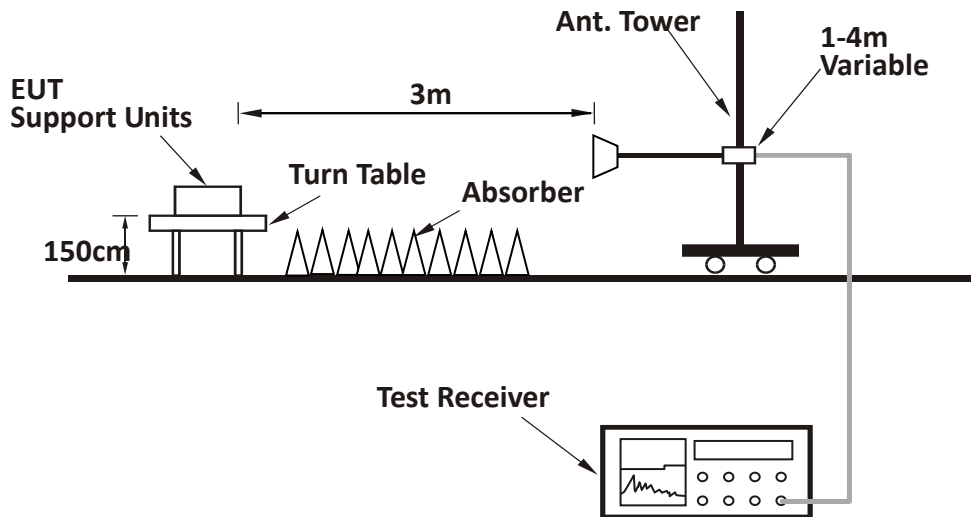

7.3 Test procedure and test setup

For Radiated emission below 30MHz:

a) The EUT was placed on the top of a rotating table 0.8 meters above the ground at a 3 meter chamber room. The table was rotated 360 degrees to determine the position of the highest radiation.

b) The EUT was set 3 meters away from the interference-receiving antenna, which was mounted on the top of a variable-height antenna tower.

c) Both X and Y axes of the antenna are set to make the measurement.

d) For each suspected emission, the EUT was arranged to its worst case and the rotatable table was turned from 0 degrees to 360 degrees to find the maximum reading.

e) The test-receiver system was set to Quasi-Peak Detect Function and Specified Bandwidth with Maximum Hold Mode.

NOTE:

1. The resolution bandwidth and video bandwidth of test receiver/spectrum analyzer is 9kHz at frequency below 30MHz.

For Radiated emission above 30MHz:

a) The EUT was placed on the top of a rotating table 0.8 meters (for 30MHz ~ 1GHz) / 1.5 meters (for above 1GHz) above the ground at 3 meter chamber room for test. The table was rotated 360 degrees to determine the position of the highest radiation.

b) The EUT was set 3 meters away from the interference-receiving antenna, which was mounted on the top of a variable-height antenna tower.

c) The height of antenna is varied from one meter to four meters above the ground to determine the maximum value of the field strength. Both horizontal and vertical polarizations of the antenna are set to make the measurement.

d) For each suspected emission, the EUT was arranged to its worst case and then the antenna was tuned to heights from 1 meter to 4 meters and the rotatable table was turned from 0 degrees to 360 degrees to find the maximum reading.

e) The test-receiver system was set to quasi-peak detect function and specified bandwidth with maximum hold mode when the test frequency is below 1 GHz.

f) The test-receiver system was set to peak and average detect function and specified bandwidth with maximum hold mode when the test frequency is above 1 GHz. If the peak reading value also meets average limit, measurement with the average detector is unnecessary.

Note:

1. The resolution bandwidth and video bandwidth of test receiver/spectrum analyzer is 120kHz for Quasi-peak detection (QP) at frequency below 1GHz.

2. The resolution bandwidth of test receiver/spectrum analyzer is 1 MHz and the video bandwidth is 3 MHz for Peak detection (PK) at frequency above 1GHz.

3. The resolution bandwidth of test receiver/spectrum analyzer is 1 MHz and the video bandwidth is $\geq 1/T$ (Duty cycle $< 98\%$) or $3 \times \text{RBW}$ (Duty cycle $\geq 98\%$) for Average detection (AV) at frequency above 1GHz.
4. All modes of operation were investigated and the worst-case emissions are reported

7.4 Test Protocol

Temperature: 25 °C
Relative Humidity: 55 %

The low frequency, which started from 9 kHz to 30MHz, was pre-scanned and the result which was 20dB lower than the limit line per 15.31(o) was not reported.

The worst waveform from 30MHz to 1000MHz is listed as below:

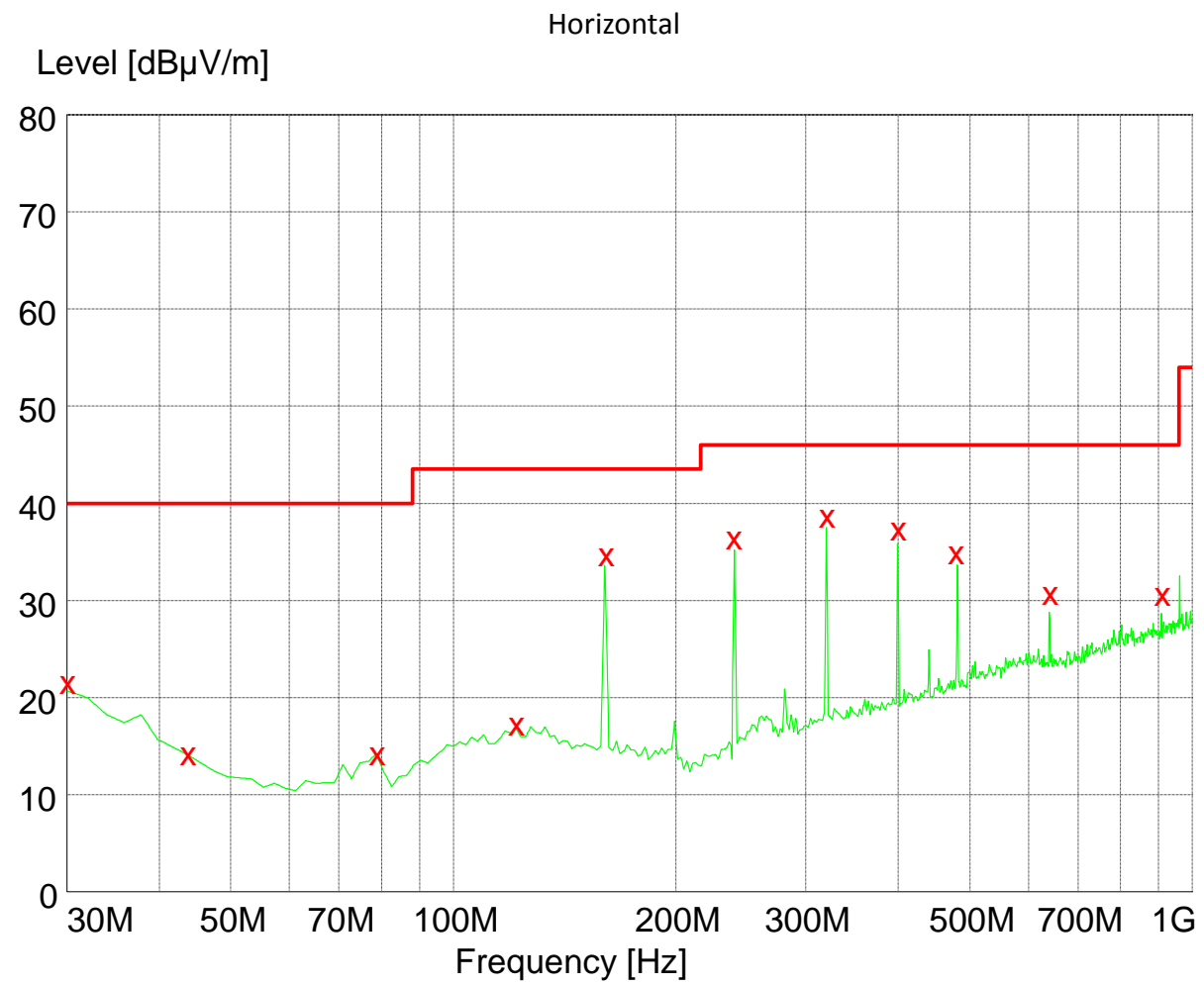

Vertical

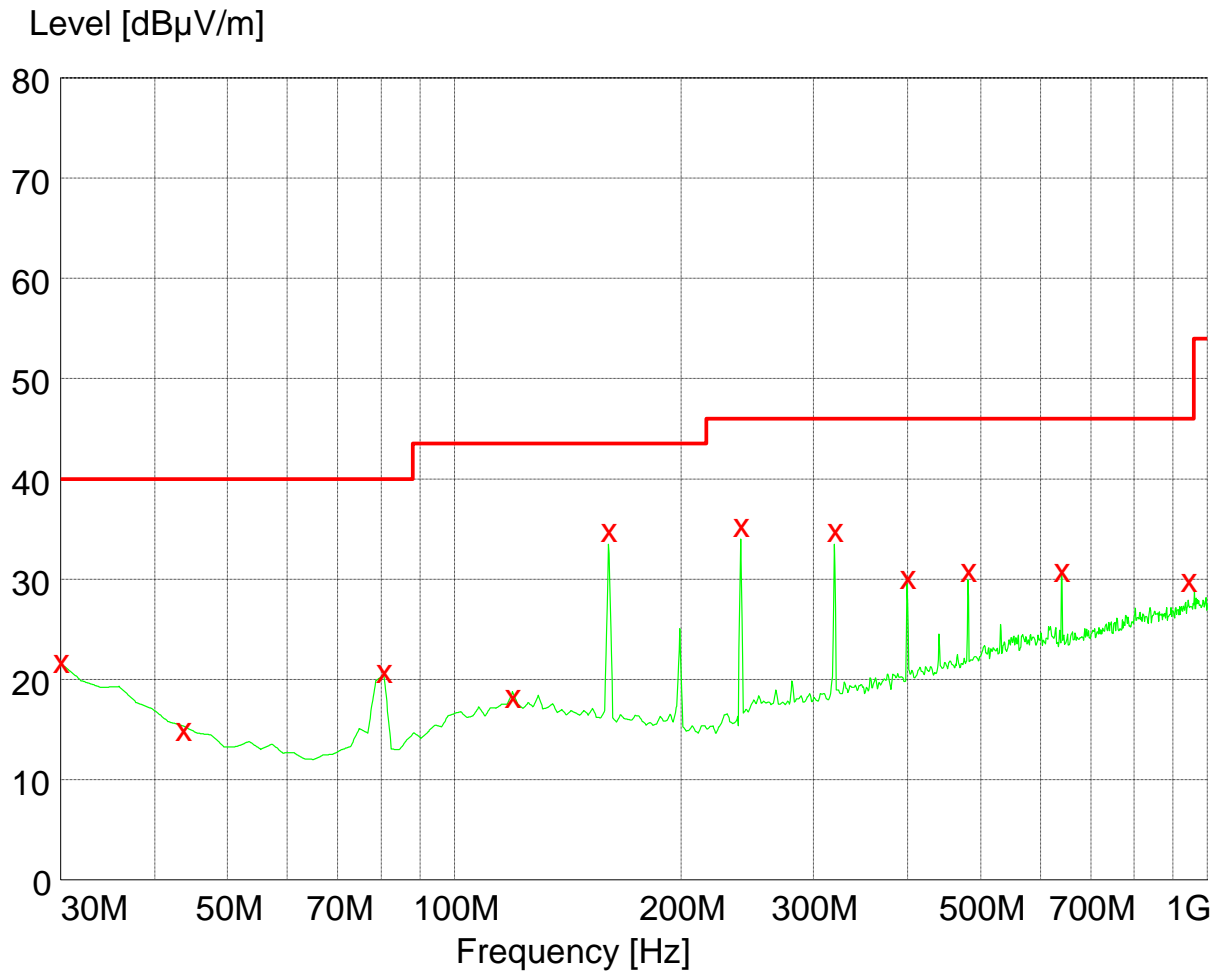

Test data 30MHz~1GHz:

Polarization	Frequency (MHz)	Measured level (dB μ V/m)	Limits (dB μ V/m)	Margin (dB)	Detector
H	30.00	21.8	40.0	18.2	PK
	78.59	14.3	40.0	25.7	PK
	121.36	17.5	43.5	26	PK
	160.24	36.3	43.5	7.2	PK
	239.93	36.7	46.0	9.3	PK
	319.63	38.5	46.0	7.5	PK
	399.33	37.4	46.0	8.6	PK
V	30.00	22.0	40.0	18	PK
	80.54	20.5	40.0	19.5	PK
	119.41	18.3	43.5	25.2	PK
	160.24	35.3	43.5	8.2	PK
	239.93	36.7	46.0	9.3	PK
	319.63	35.8	46.0	10.2	PK
	480.98	30.9	46.0	15.1	PK

Note: The worst test result (30MHz to 1GHz) of 802.11g channel L (2412MHz) was chosen to list in the report as representative.

Test result above 1GHz:

The emission was conducted from 1GHz to 25GHz.

802.11b:

CH	Antenna	Frequency (MHz)	Measure Level (dBuV/m)	Reading Level (dBuV)	Over Limit (dB)	Limit (dBuV/m)	Factor (dB)	Type
L	H	2390.00	47.23	16.03	-26.77	74.00	31.20	PK
	H	2390.00	38.25	7.05	-15.75	54.00	31.20	AV
	V	4824.00	39.17	36.47	-34.83	74.00	2.70	PK
	V	4824.00	33.25	30.55	-20.75	54.00	2.70	AV
M	V	4874.00	39.68	37.01	-34.32	74.00	2.67	PK
	V	4874.00	32.46	29.79	-21.54	54.00	2.67	AV
H	V	2483.50	45.36	14.17	-28.64	74.00	31.19	PK
	V	2483.50	36.28	5.09	-17.72	54.00	31.19	AV
	V	4924.00	46.15	43.38	-27.85	74.00	2.77	PK
	V	4924.00	38.48	35.71	-15.52	54.00	2.77	AV

802.11g:

CH	Antenna	Frequency (MHz)	Measure Level (dBuV/m)	Reading Level (dBuV)	Over Limit (dB)	Limit (dBuV/m)	Factor (dB)	Type
L	V	2390.00	49.47	18.27	-24.53	74.00	31.20	PK
	V	2390.00	41.25	10.05	-12.75	54.00	31.20	AV
	V	4824.00	40.36	37.66	-33.64	74.00	2.70	PK
	V	4824.00	35.63	32.93	-18.37	54.00	2.70	AV
M	V	4874.00	37.27	34.60	-36.73	74.00	2.67	PK
	V	4874.00	32.14	29.47	-21.86	54.00	2.67	AV
H	V	2483.50	44.52	13.33	-29.48	74.00	31.19	PK
	V	2483.50	34.74	3.55	-19.26	54.00	31.19	AV
	V	4924.00	44.39	41.62	-29.61	74.00	2.77	PK
	V	4924.00	36.83	34.06	-17.17	54.00	2.77	AV

802.11n (HT20):

CH	Antenna	Frequency (MHz)	Measure Level (dBuV/m)	Reading Level (dBuV)	Over Limit (dB)	Limit (dBuV/m)	Factor (dB)	Type
L	V	2390.00	48.41	17.21	-25.59	74.00	31.20	PK
	V	2390.00	41.24	10.04	-12.76	54.00	31.20	AV
	V	4824.00	42.83	40.13	-31.17	74.00	2.70	PK
	V	4824.00	36.81	34.11	-17.19	54.00	2.70	AV
M	V	4874.00	40.66	37.99	-33.34	74.00	2.67	PK
	V	4874.00	33.47	30.80	-20.53	54.00	2.67	AV
H	V	2483.50	43.75	12.56	-30.25	74.00	31.19	PK
	V	2483.50	37.84	6.65	-16.16	54.00	31.19	AV
	V	4924.00	44.36	41.59	-29.64	74.00	2.77	PK
	V	4924.00	37.57	34.80	-16.43	54.00	2.77	AV

- Remark: 1. Correct Factor = Antenna Factor + Cable Loss (+ Amplifier, for higher than 1GHz), the value was added to Original Receiver Reading by the software automatically.
 2. Corrected Reading = Original Receiver Reading + Correct Factor
 3. Margin = Limit - Corrected Reading
 4. If the PK Corrected Reading is lower than AV limit, the AV test can be elided.

Example: Assuming Antenna Factor = 30.20dB/m, Cable Loss = 2.00dB,
 Gain of Preamplifier = 32.00dB, Original Receiver Reading = 10.00dBuV,
 Limit = 40.00dBuV/m.
 Then Correct Factor = 30.20 + 2.00 – 32.00 = 0.20dB/m;
 Corrected Reading = 10dBuV + 0.20dB/m = 10.20dBu

8 Power line conducted emission

Test result: Pass

8.1 Limit

Frequency of Emission (MHz)	Conducted Limit (dBuV)	
	QP	AV
0.15-0.5	66 to 56*	56 to 46 *
0.5-5	56	46
5-30	60	50

* Decreases with the logarithm of the frequency.

8.2 Test configuration

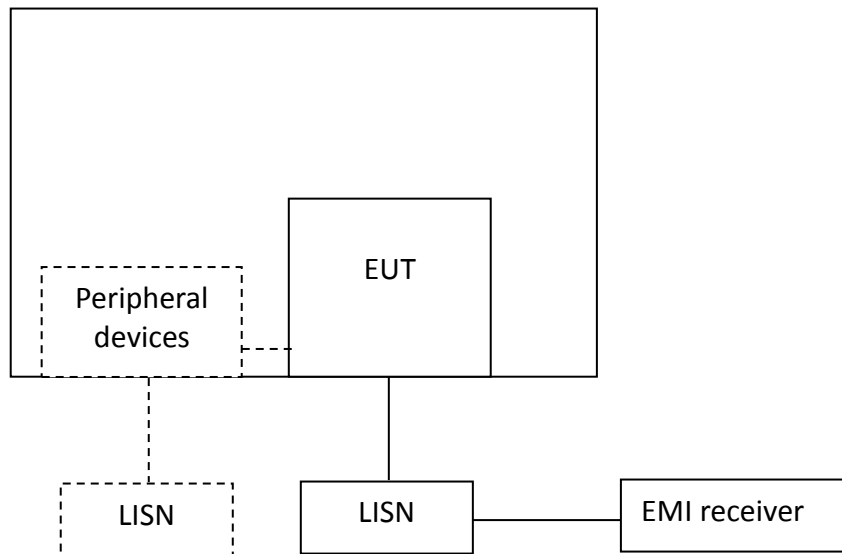

For table top equipment, wooden support is 0.8m height table

For floor standing equipment, wooden support is 0.1m height rack.

8.3 Test procedure and test set up

Measured levels of ac power-line conducted emission shall be the emission voltages from the voltage probe, where permitted, or across the 50 Ω LISN port (to which the EUT is connected), where permitted, terminated into a 50 Ω measuring instrument. All emission voltage and current measurements shall be made on each current-carrying conductor at the plug end of the EUT power cord by the use of mating plugs and receptacles on the LISN, if used. Equipment shall be tested with power cords that are normally supplied or recommended by the manufacturer and that have electrical and shielding characteristics that are the same as those cords normally supplied or recommended by the manufacturer. For those measurements using a LISN, the 50 Ω measuring port is terminated by a measuring instrument having 50 Ω input impedance. All other ports are terminated in 50 Ω loads.

Tabletop devices shall be placed on a platform of nominal size 1 m by 1.5 m, raised 80 cm above the reference ground plane. The vertical conducting plane or wall of an RF-shielded (screened) room shall be located 40 cm to the rear of the EUT. Floor-standing devices shall be placed either directly on the reference ground-plane or on insulating material as described in ANSI C63.4. All other surfaces of tabletop or floor-standing EUTs shall be at least 80 cm from any other grounded conducting surface, including the case or cases of one or more LISNs.

The bandwidth of the test receiver is set at 9 kHz.

8.4 Test protocol

Temperature: 25 °C
Relative Humidity: 55 %

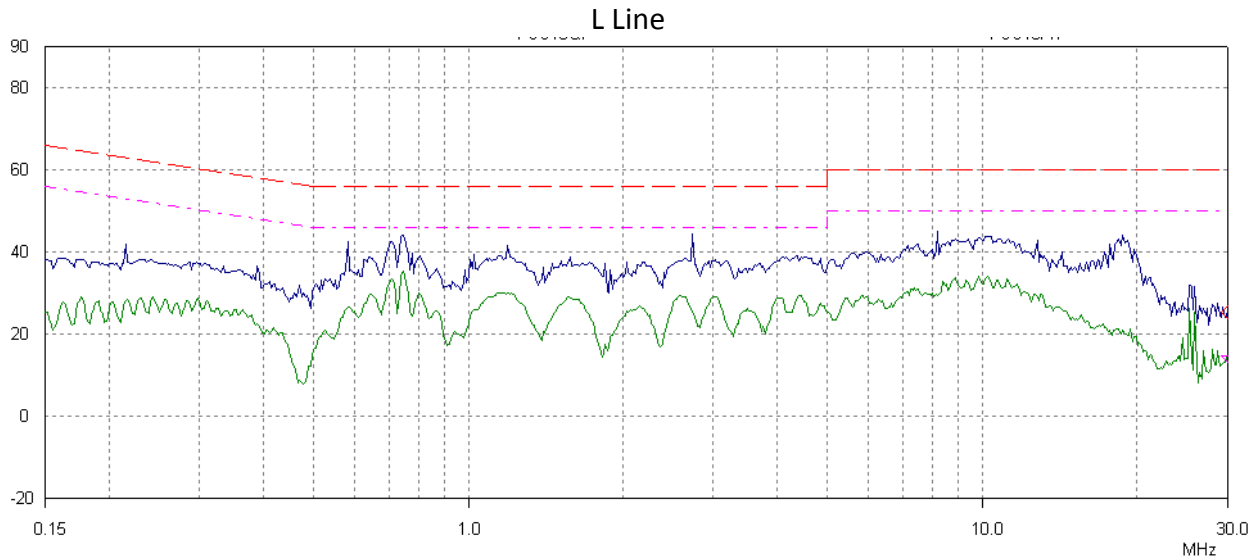

Test Data:

Frequency (MHz)	Quasi-peak			Average		
	level dB(µV)	Limit dB(µV)	Margin (dB)	level dB(µV)	limit dB(µV)	Margin (dB)
0.16	*	65.3	*	*	55.3	*
0.25	*	61.9	*	*	51.9	*
0.60	*	56.0	*	*	46.0	*
4.29	*	56.0	*	*	46.0	*
10.45	*	60.0	*	*	50.0	*
19.40	*	60.0	*	*	50.0	*

Note: *means margin is more than 10dB.

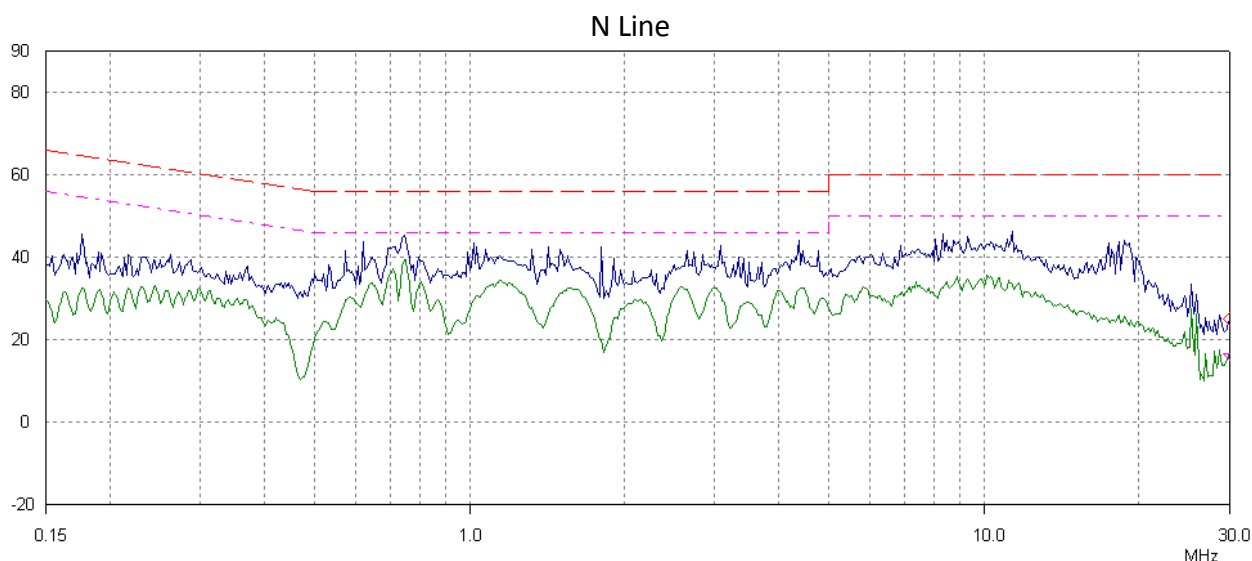

Test Data:

Frequency (MHz)	Quasi-peak			Average		
	level dB(μV)	Limit dB(μV)	Margin (dB)	level dB(μV)	limit dB(μV)	Margin (dB)
0.16	*	65.2	*	*	55.2	*
0.25	*	61.8	*	*	51.8	*
0.95	*	56.0	*	*	46.0	*
4.14	*	56.0	*	*	46.0	*
10.32	*	60.0	*	*	50.0	*
19.24	*	60.0	*	*	50.0	*

Note: *means margin is more than 10dB.

Remark: 1. Correct Factor = LISN Factor + Cable Loss, the value was added to Original Receiver Reading by the software automatically.

2. Corrected Reading = Original Receiver Reading + Correct Factor

3. Margin = Limit - Corrected Reading

4. If the PK Corrected Reading is lower than AV limit, the AV test can be elided.

Example: Assuming LISN Factor = 10.00dB, Cable Loss = 2.00dB, Original Receiver Reading = 10.00dBuV, Limit = 66.00dBuV.

Then Correct Factor = 10.00 + 2.00 = 12.00dB;

Corrected Reading = 10dBuV + 12.00dB = 22.00dBuV;

Margin = 66.00dBuV – 22.00dBuV = 44.00dB.

9 Antenna Requirement

An intentional radiator shall be designed to ensure that no antenna other than that furnished by the responsible party shall be used with the device. The use of a permanently attached antenna or of an antenna that uses a unique coupling to the intentional radiator shall be considered sufficient to comply with the provisions of this section. The manufacturer may design the unit so that a broken antenna can be replaced by the user, but the use of a standard antenna jack or electrical connector is prohibited.

Result:

EUT uses permanently attached antenna to the intentional radiator, so it can comply with the provisions of this section.

Appendix A: Test results

1. Duty cycle

1.1 Test Result and Data

WLAN Duty Cycle				
Mode	Test Frequency(MHz)	Ant	Duty Cycle(%)	Duty Cycle Factor (dB)
802.11b	2412	Ant1	88.98	0.51
802.11b	2437	Ant1	88.98	0.51
802.11b	2462	Ant1	89.24	0.49
802.11g	2412	Ant1	86.67	0.62
802.11g	2437	Ant1	86.67	0.62
802.11g	2462	Ant1	86.67	0.62
802.11n(HT20)	2412	Ant1	87.72	0.57
802.11n(HT20)	2437	Ant1	85.96	0.66
802.11n(HT20)	2462	Ant1	85.96	0.66

1.2 Test Plots

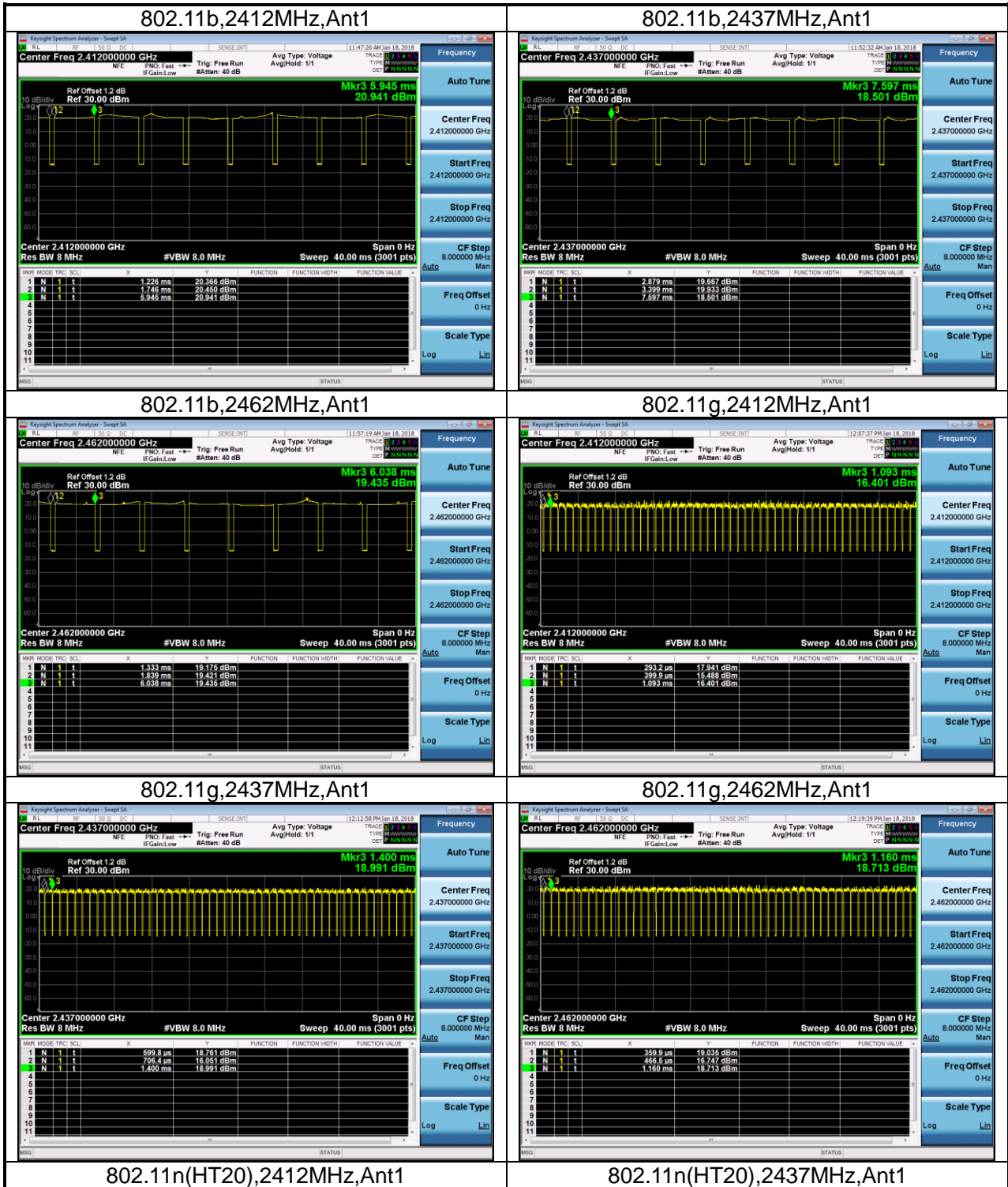

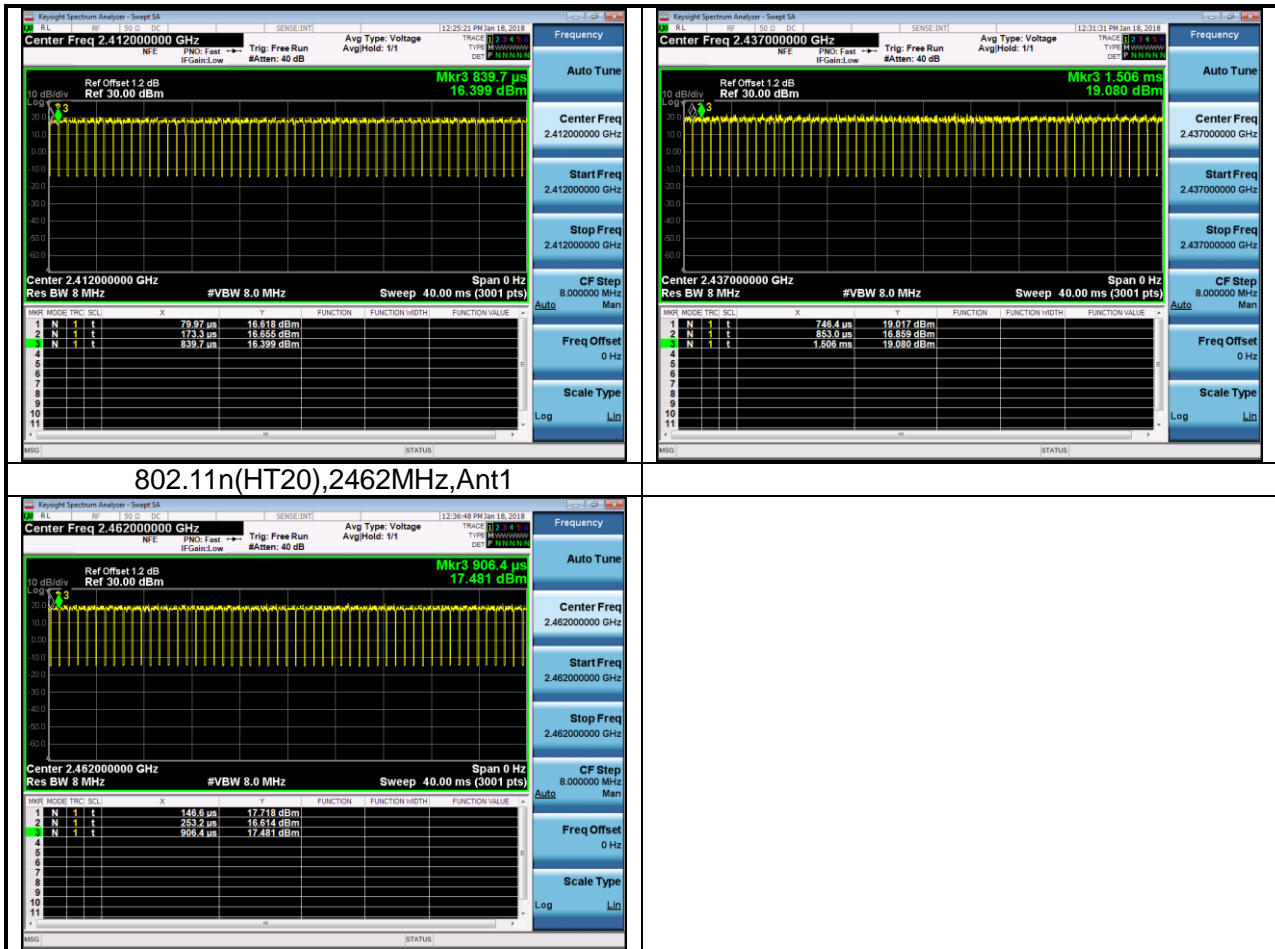

2. RF Output Power

2.1 Test Result and Data

WLAN AVGSA Output Power						
Mode	Test Frequency(MHz)	Ant	Duty Cycle Factor (dB)	Max Power (dBm)	Limit (dBm)	Result
802.11b	2412	Ant1	0.51	15.94	30	Pass
802.11b	2437	Ant1	0.51	15.48	30	Pass
802.11b	2462	Ant1	0.49	15.75	30	Pass
802.11g	2412	Ant1	0.62	14.27	30	Pass
802.11g	2437	Ant1	0.62	14.39	30	Pass
802.11g	2462	Ant1	0.62	14.81	30	Pass
802.11n(HT20)	2412	Ant1	0.57	13.97	30	Pass
802.11n(HT20)	2437	Ant1	0.66	14.25	30	Pass
802.11n(HT20)	2462	Ant1	0.66	14.74	30	Pass

2.2 Test Plots

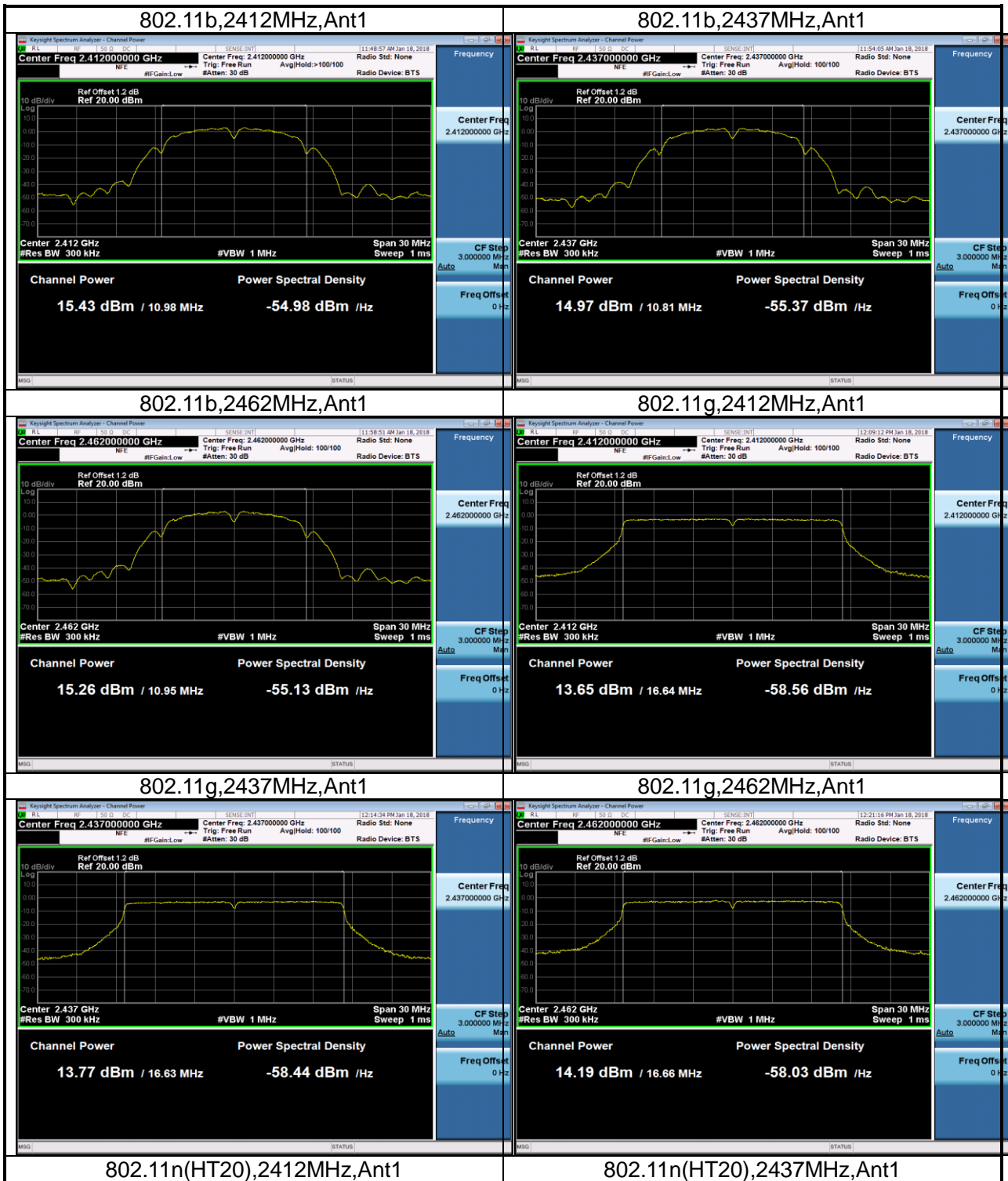

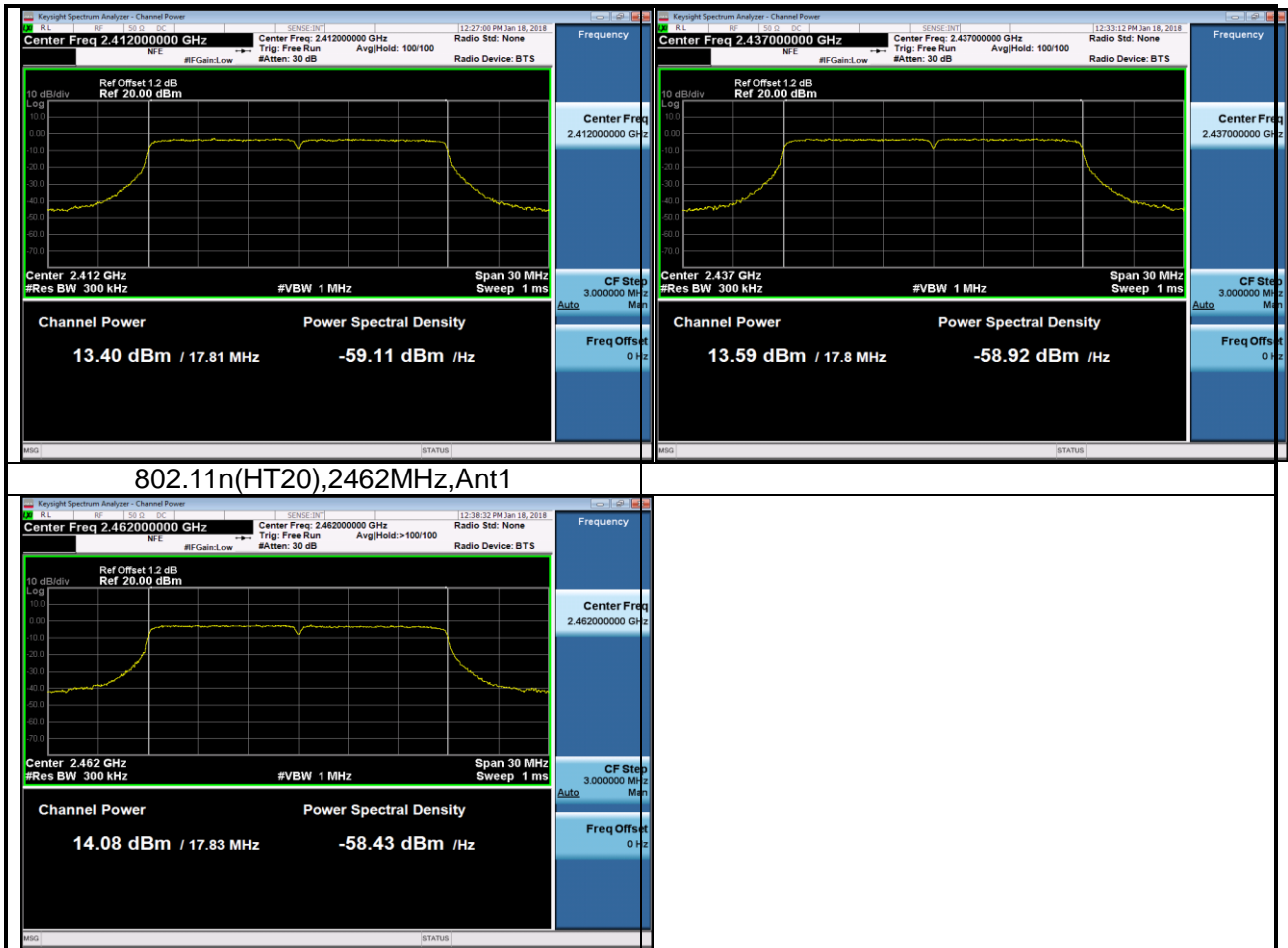

3. Minimum 6dB bandwidth

3.1 Test Result and Data

WLAN Occupied 6dB Bandwidth				
Mode	Test Frequency(MHz)	Ant	Occupied Bandwidth(MHz)	Result
802.11b	2412	Ant1	8.59	Pass
802.11b	2437	Ant1	8.10	Pass
802.11b	2462	Ant1	8.56	Pass
802.11g	2412	Ant1	16.38	Pass
802.11g	2437	Ant1	16.38	Pass
802.11g	2462	Ant1	16.37	Pass
802.11n(HT20)	2412	Ant1	17.56	Pass
802.11n(HT20)	2437	Ant1	17.56	Pass
802.11n(HT20)	2462	Ant1	17.56	Pass

3.2 Test Plots

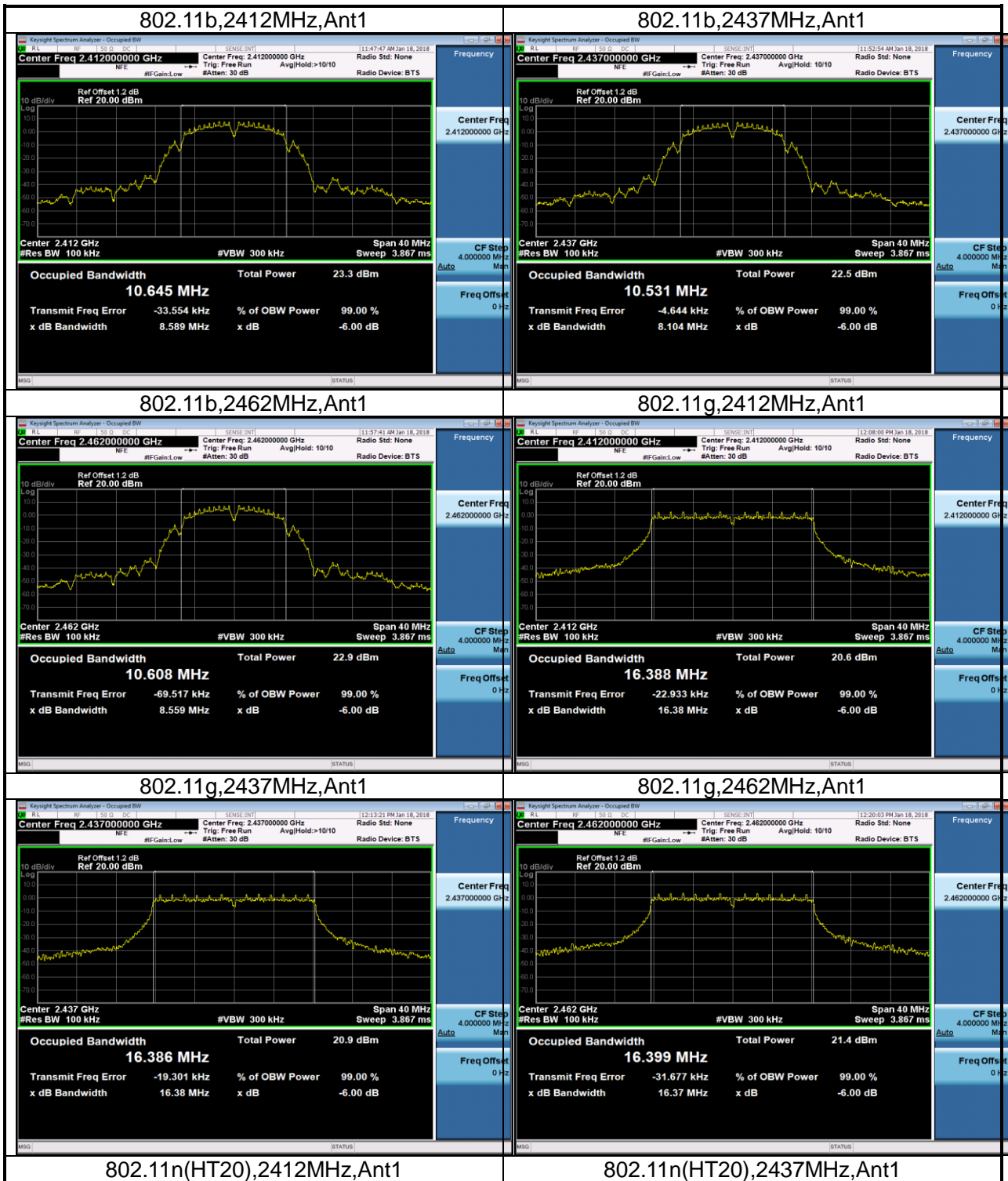

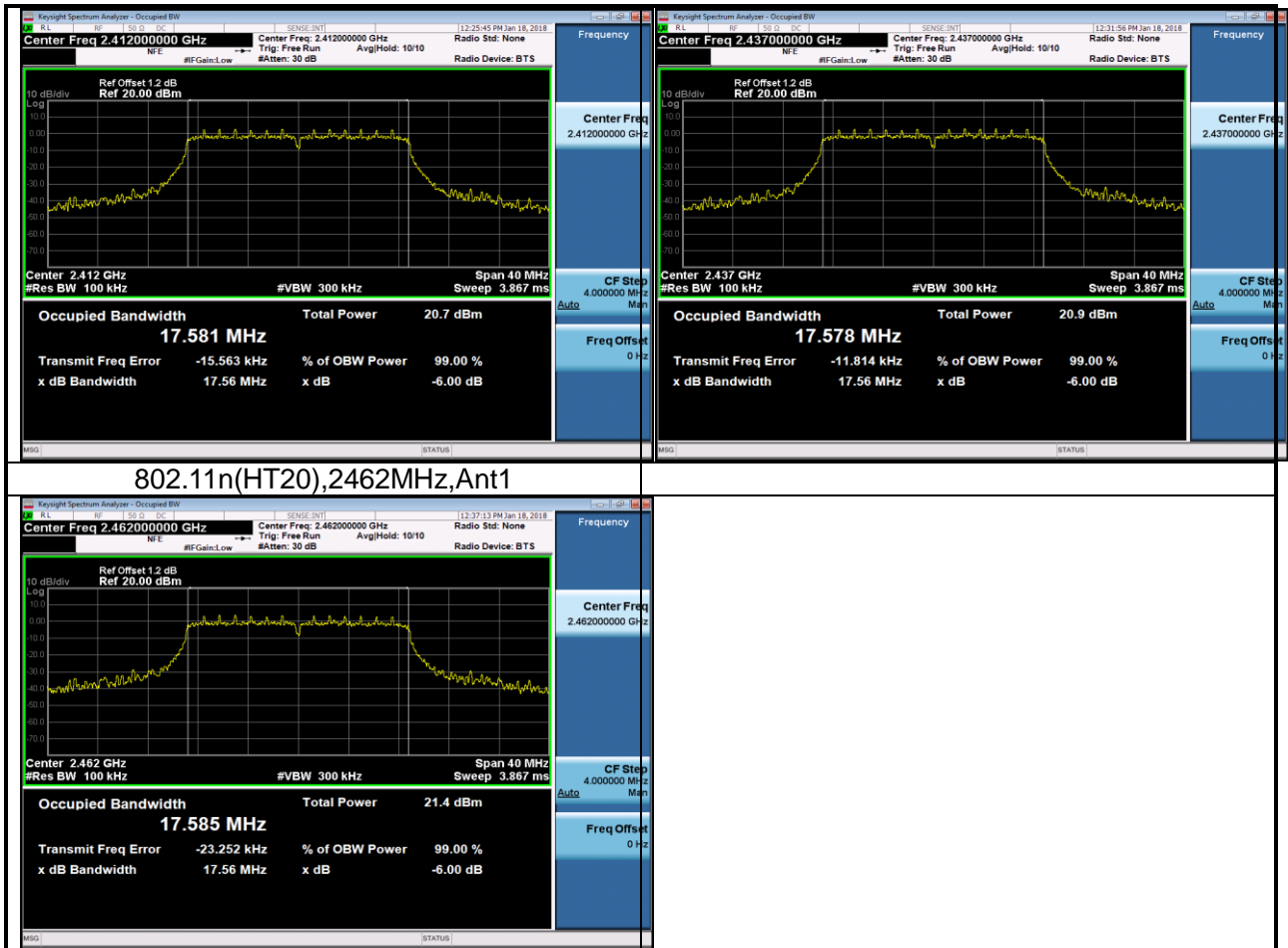

4. Occupied Bandwidth

4.1 Test Result and Data

WLAN 99% Occupied Bandwidth				
Mode	Test Frequency(MHz)	Ant	99% Occupied Bandwidth(MHz)	Result
802.11b	2412	Ant1	10.976	Pass
802.11b	2437	Ant1	10.810	Pass
802.11b	2462	Ant1	10.948	Pass
802.11g	2412	Ant1	16.641	Pass
802.11g	2437	Ant1	16.632	Pass
802.11g	2462	Ant1	16.662	Pass
802.11n(HT20)	2412	Ant1	17.807	Pass
802.11n(HT20)	2437	Ant1	17.799	Pass
802.11n(HT20)	2462	Ant1	17.829	Pass

4.2 Test Plots

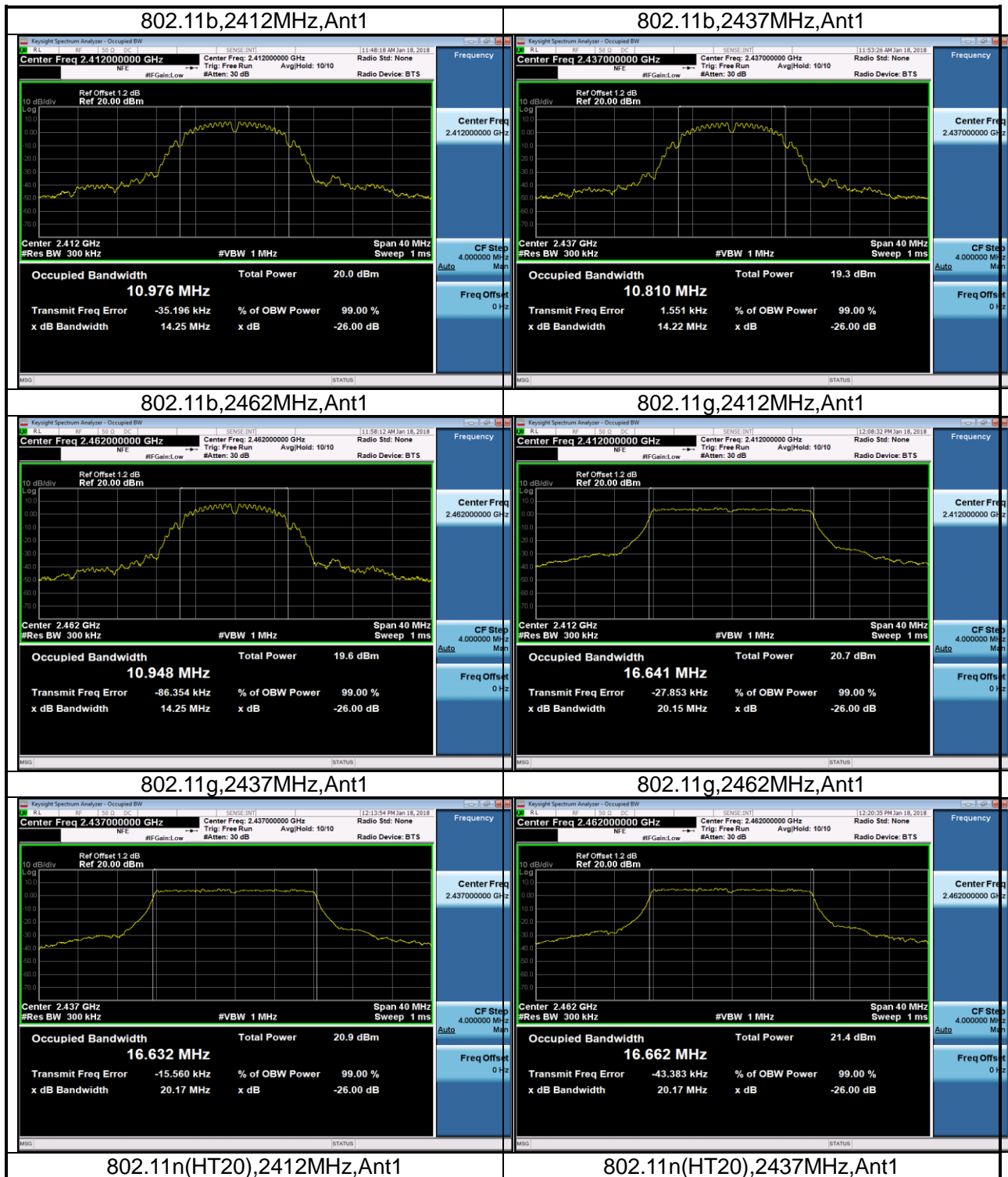



5. Power Spectral Density

5.1 Test Result and Data

WLAN AVGSA Power Spectral Density							
Mode	Test Frequency (MHz)	Ant	Duty Cycle Factor(dB)	PSD(dBm)	RBW(kHz)	Limit(dBm)	Result
802.11b	2412	Ant1	0.51	-15.422	3	8	Pass
802.11b	2437	Ant1	0.51	-15.645	3	8	Pass
802.11b	2462	Ant1	0.49	-15.894	3	8	Pass
802.11g	2412	Ant1	0.62	-19.151	3	8	Pass
802.11g	2437	Ant1	0.62	-19.239	3	8	Pass
802.11g	2462	Ant1	0.62	-18.678	3	8	Pass
802.11n(HT20)	2412	Ant1	0.57	-19.705	3	8	Pass
802.11n(HT20)	2437	Ant1	0.66	-19.359	3	8	Pass
802.11n(HT20)	2462	Ant1	0.66	-19.327	3	8	Pass

5.2 Test Plots

