

# FCC Report (Bluetooth)

**Product Name** : Haylou Wireless Earbuds  
**Trade mark** : Haylou  
**Model No.** : GT3  
**FCC ID** : 2AMQ6-GT3  
**Report Number** : BLA-EMC-202007-A21-01  
**Date of sample receipt** : 2020/7/8  
**Date of Test** : 2020/7/8 - 2020/7/15  
**Date of Issue** : 2020/7/24  
**Test standard** : FCC CFR Title 47 Part 15 Subpart C Section 15.247  
**Test result** : PASS

Prepared for:

**Dongguan Liesheng Electronic Co., Ltd.**  
**13/F,Project Phrase 2 of GaoshengTechTower,No.5,Longxi Road,Nancheng,Dongguan,Guangdong,China.**

Prepared by:

**BlueAsia of Technical Services(Shenzhen) Co., Ltd.**  
**IOT Test Centre of BlueAsia**  
**No. 448 Bulong Road, Bantian Street, Longgang District, Shenzhen, China**

**TEL: +86-755-28682673**

**FAX: +86-755-28682673**

Compile by: <i>Eason</i>	Review by: <i>Brand weir</i>
Approved by: <i>Emen-li</i>	Date:2020/7/24



BlueAsia of Technical Services(Shenzhen) Co., Ltd.

IOT Test Centre of BlueAsia, No. 448 Bulong Road, Bantian Street, Longgang District, Shenzhen, China

Telephone: TEL: +86-755-28682673 FAX: +86-755-28682673

Email: marketing@cblueasia.com

## 2 Version

Version No.	Date	Description
00	2020/7/24	Original

BlueAsia

### 3 Contents

	Page
<b>1 COVER PAGE</b> .....	<b>1</b>
<b>2 VERSION</b> .....	<b>2</b>
<b>3 CONTENTS</b> .....	<b>3</b>
<b>4 TEST SUMMARY</b> .....	<b>4</b>
<b>5 GENERAL INFORMATION</b> .....	<b>5</b>
5.1 GENERAL DESCRIPTION OF EUT.....	5
5.2 TEST MODE.....	7
5.3 TEST FACILITY.....	7
5.4 TEST LOCATION.....	7
5.5 OTHER INFORMATION REQUESTED BY THE CUSTOMER.....	7
5.6 DESCRIPTION OF SUPPORT UNITS.....	7
<b>6 TEST INSTRUMENTS LIST</b> .....	<b>8</b>
<b>7 TEST RESULTS AND MEASUREMENT DATA</b> .....	<b>10</b>
7.1 ANTENNA REQUIREMENT.....	10
7.2 CONDUCTED EMISSIONS.....	11
7.3 CONDUCTED PEAK OUTPUT POWER.....	14
7.4 20dB EMISSION BANDWIDTH.....	15
7.5 CARRIER FREQUENCIES SEPARATION.....	16
7.6 HOPPING CHANNEL NUMBER.....	17
7.7 DWELL TIME.....	18
7.8 PSEUDORANDOM FREQUENCY HOPPING SEQUENCE.....	19
7.9 BAND EDGE.....	20
7.9.1 <i>Conducted Emission Method</i> .....	20
7.9.2 <i>Radiated Emission Method</i> .....	21
7.10 SPURIOUS EMISSION.....	26
7.10.1 <i>Conducted Emission Method</i> .....	26
7.10.2 <i>Radiated Emission Method</i> .....	27
<b>8 TEST SETUP PHOTO</b> .....	<b>38</b>
<b>9 EUT CONSTRUCTIONAL DETAILS</b> .....	<b>40</b>
<b>10 APPENDIX</b> .....	<b>52</b>

## 4 Test Summary

Test Item	Section in CFR 47	Result
Antenna Requirement	15.203/15.247 (c)	Pass
AC Power Line Conducted Emission	15.207	Pass
Conducted Peak Output Power	15.247 (b)(1)	Pass
20dB Occupied Bandwidth	15.247 (a)(1)	Pass
Carrier Frequencies Separation	15.247 (a)(1)	Pass
Hopping Channel Number	15.247 (a)(1)	Pass
Dwell Time	15.247 (a)(1)	Pass
Pseudorandom Frequency Hopping Sequence	15.247(b)(4)	Pass
Radiated Emission	15.205/15.209	Pass
Band Edge	15.247(d)	Pass

*Pass: The EUT complies with the essential requirements in the standard.*

*Remark: Test according ANSI C63.10:2013*

### Measurement Uncertainty

Test Item	Frequency Range	Measurement Uncertainty	Notes
Radiated Emission	9kHz ~ 30MHz	± 4.34dB	(1)
Radiated Emission	30MHz ~ 1000MHz	± 4.24dB	(1)
Radiated Emission	1GHz ~ 26.5GHz	± 4.68dB	(1)
AC Power Line Conducted Emission	0.15MHz ~ 30MHz	± 3.45dB	(1)

Note (1): The measurement uncertainty is for coverage factor of k=2 and a level of confidence of 95%.

## 5 General Information

### 5.1 General Description of EUT

Product Name:	Haylou Wireless Earbuds
Model No.:	GT3
Test Model No.:	GT3
Serial No.:	N/A
Sample(s) Status	Engineer sample
Hardware:	V1.0
Software:	V1.0
Operation Frequency:	2402MHz-2480MHz
Channel numbers:	79
Channel separation:	1MHz
Modulation type:	GFSK, $\pi/4$ -DQPSK, 8-DPSK
Antenna Type:	Internal Antenna
Antenna gain:	1.1dBi
Power supply:	DC 3.7V
Remark:The Antenna Gain is supplied by the customer.BlueAsia is not responsible for this data	

Operation Frequency each of channel							
Channel	Frequency	Channel	Frequency	Channel	Frequency	Channel	Frequency
1	2402MHz	21	2422MHz	41	2442MHz	61	2462MHz
2	2403MHz	22	2423MHz	42	2443MHz	62	2463MHz
3	2404MHz	23	2424MHz	43	2444MHz	63	2464MHz
4	2405MHz	24	2425MHz	44	2445MHz	64	2465MHz
5	2406MHz	25	2426MHz	45	2446MHz	65	2466MHz
6	2407MHz	26	2427MHz	46	2447MHz	66	2467MHz
7	2408MHz	27	2428MHz	47	2448MHz	67	2468MHz
8	2409MHz	28	2429MHz	48	2449MHz	68	2469MHz
9	2410MHz	29	2430MHz	49	2450MHz	69	2470MHz
10	2411MHz	30	2431MHz	50	2451MHz	70	2471MHz
11	2412MHz	31	2432MHz	51	2452MHz	71	2472MHz
12	2413MHz	32	2433MHz	52	2453MHz	72	2473MHz
13	2414MHz	33	2434MHz	53	2454MHz	73	2474MHz
14	2415MHz	34	2435MHz	54	2455MHz	74	2475MHz
15	2416MHz	35	2436MHz	55	2456MHz	75	2476MHz
16	2417MHz	36	2437MHz	56	2457MHz	76	2477MHz
17	2418MHz	37	2438MHz	57	2458MHz	77	2478MHz
18	2419MHz	38	2439MHz	58	2459MHz	78	2479MHz
19	2420MHz	39	2440MHz	59	2460MHz	79	2480MHz
20	2421MHz	40	2441MHz	60	2461MHz		

**Note:**

In section 15.31(m), regards to the operating frequency range over 10 MHz, the Lowest frequency, the middle frequency, and the highest frequency of channel were selected to perform the test, and the selected channel see below:

Channel	Frequency
The lowest channel	2402MHz
The middle channel	2441MHz
The Highest channel	2480MHz

## 5.2 Test mode

Transmitting mode	Keep the EUT in continuously transmitting mode with modulation. (hopping or non hopping mode,non hopping mode is worse case for RE.)
<p><i>Remark: During the test,the test voltage was tuned from 85% to 115% of the nominal rated supply voltage, and found that the worst case was under the nominal rated supply condition. So the report just shows that condition's data.</i></p> <p><i>Full battery is used during all test except ac conducted emission, DH1, DH3, DH5 all have been tested, during the test, GFSK, Pi/4QPSK, 8-DPSK modulation were all pre-scanned only worse case is reported.</i></p>	

## 5.3 Test Facility

<p>The test facility is recognized, certified, or accredited by the following organizations:</p> <ul style="list-style-type: none"> <li>● <b>FCC — Designation No.: CN1252</b> <i>BlueAsia of Technical Services(Shenzhen) Co., Ltd</i> has been registered and fully described in a report filed with the (FCC) Federal Communications Commission. The acceptance letter from the FCC is maintained in files. Designation CN1252.</li> <li>● <b>ISED — CAB identifier No.: CN0028</b> <i>BlueAsia of Technical Services(Shenzhen) Co., Ltd</i> has been registered by Certification and Engineering Bureau of ISED for radio equipment testing with CAB identifier CN0028</li> </ul>
---

## 5.4 Test Location

All tests were performed at:
<p><i>All tests were performed at:</i> <i>BlueAsia of Technical Services(Shenzhen) Co., Ltd.</i> <i>IOT Test Centre of BlueAsia</i> <i>No. 448 Bulong Road, Bantian Street, Longgang District, Shenzhen, China</i> <i>Telephone: TEL: +86-755-28682673 FAX: +86-755-28682673</i></p> <p>No tests were sub-contracted.</p>

## 5.5 Other Information Requested by the Customer

None.
-------

## 5.6 Description of Support Units

Manufacturer	Description	Model	Serial Number
UGREEN	Adapter	CD112	20358
Lenovo	Notebook computer	E470C	PF-10FB5C

## 6 Test Instruments list

Radiated Emission:						
Item	Test Equipment	Manufacturer	Model No.	Serial No.	Cal.Date (mm-dd-yy)	Cal.Due date (mm-dd-yy)
1	3m SAC	SKET	9m*6 m*6m	966	06-10-2018	06-09-2023
2	Broadband Antenna	SCHWARZBECK	VULB9168	00836 P:00227	07-13-2019	07-12-2020
					07-13-2020	07-12-2021
3	Horn Antenna	SCHWARZBECK	9120D	01892 P:00331	07-13-2019	07-12-2020
					07-13-2020	07-12-2021
4	EMI Test Software	EZ	EZ	N/A	N/A	N/A
5	Pre-amplifier	SKET	N/A	N/A	07-13-2019	07-12-2020
					07-13-2020	07-12-2021
6	Spectrum analyzer	Rohde & Schwarz	FSP40	100817	07-13-2019	07-12-2020
					07-13-2020	07-12-2021
7	EMI Test Receiver	Rohde & Schwarz	ESR7	101199	07-13-2019	07-12-2020
					07-13-2020	07-12-2021
8	Controller	SKET	N/A	N/A	N/A	N/A
9	Vector Signal Generator	Agilent	E4438C	MY45092582	05-24-2020	05-23-2021
10	Signal Generator	Agilent	E8257D	MY44320250	05-24-2020	05-23-2021
11	Coaxial Cable	BlueAsia	BLA-XC-02	N/A	N/A	N/A
12	Coaxial Cable	BlueAsia	BLA-XC-03	N/A	N/A	N/A
13	Coaxial Cable	BlueAsia	BLA-XC-01	N/A	N/A	N/A



<b>Conducted Emission</b>						
Item	Test Equipment	Manufacturer	Model No.	Serial No.	Cal.Date (mm-dd-yy)	Cal.Due date (mm-dd-yy)
1	EMI Test Receiver	Rohde & Schwarz	ESPI3	101082	06-10-2020	06-09-2021
2	LISN	CHASE	MN2050D	1447	06-10-2020	06-09-2021
3	LISN	Rohde & Schwarz	ENV216	3560.6550.15	06-10-2020	06-09-2021
4	EMI Test Software	EZ	EZ	N/A	N/A	N/A
5	Temperature Humidity Chamber	Mingle	TH101B	N/A	07-19-2019	07-18-2020
					07-19-2020	07-18-2021
6	Coaxial Cable	BlueAsia	BLA-XC-05	N/A	N/A	N/A

<b>RF Conducted Test:</b>						
Item	Test Equipment	Manufacturer	Model No.	Serial No.	Cal.Date (mm-dd-yy)	Cal.Due date (mm-dd-yy)
1	Spectrum Analyzer	Agilent	N9030A	MY50510123	05-24-2020	05-23-2021
2	Spectrum analyzer	Rohde & Schwarz	FSP40	100817	05-24-2020	05-23-2021
3	MXA Signal Analyzer	Agilent	N9020A	MY49100060	12-18-2019	12-17-2020
4	Vector Signal Generator	Agilent	N5182A	MY49060650	12-18-2019	12-17-2020
5	Vector Signal Generator	Agilent	E4438C	MY45092582	05-24-2020	05-23-2021
6	Signal Generator	Agilent	E8257D	MY44320250	05-24-2020	05-23-2021
7	Power Sensor	D.A.R.E	RPR3006W	17100015SNO27	05-24-2020	05-23-2021
8	Power Sensor	D.A.R.E	RPR3006W	17100015SNO28	05-24-2020	05-23-2021
9	DC Power Supply	LODESTAR	LP305DE	N/A	07-19-2019	07-18-2020
					07-19-2020	07-18-2021
10	Temperature Humidity Chamber	Mingle	TH101B	N/A	07-19-2019	07-18-2020
					07-19-2020	07-18-2021

## 7 Test results and Measurement Data

### 7.1 Antenna requirement

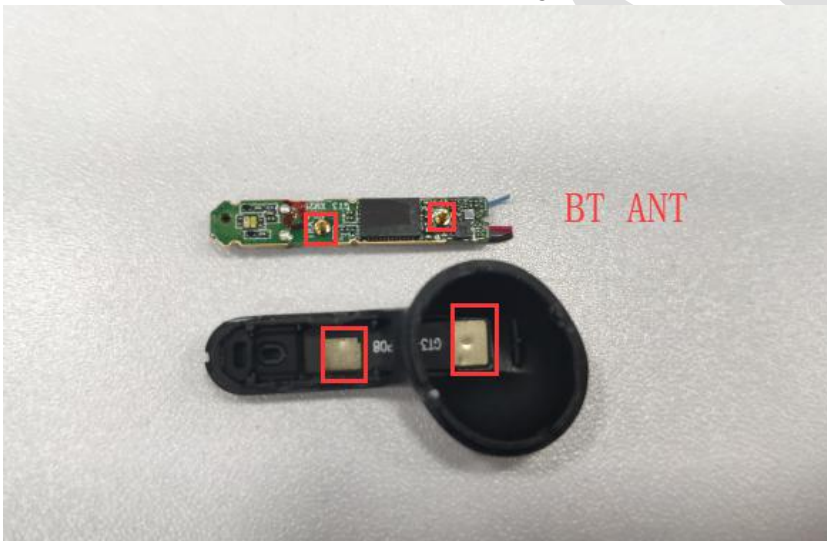
<b>Standard requirement:</b>	FCC Part15 C Section 15.203 /247(c)
<p><b>15.203 requirement:</b>            An intentional radiator shall be designed to ensure that no antenna other than that furnished by the responsible party shall be used with the device. The use of a permanently attached antenna or of an antenna that uses a unique coupling to the intentional radiator, the manufacturer may design the unit so that a broken antenna can be replaced by the user, but the use of a standard antenna jack or electrical connector is prohibited.</p> <p><b>15.247(c) (1)(i) requirement:</b>            (i) Systems operating in the 2400-2483.5 MHz band that is used exclusively for fixed. Point-to-point operations may employ transmitting antennas with directional gain greater than 6dBi provided the maximum conducted output power of the intentional radiator is reduced by 1 dB for every 3 dB that the directional gain of the antenna exceeds 6dBi.</p>	
<b>E.U.T Antenna:</b>	
<p><i>The antenna is PCB antenna, the best case gain of the antenna is 1.1dBi</i></p>  <p>The photograph shows a green PCB antenna with two gold-colored circular components highlighted by red boxes. Below it is a black device with two similar gold-colored components also highlighted by red boxes. The text 'BT ANT' is printed in red to the right of the PCB antenna.</p>	

## 7.2 Conducted Emissions

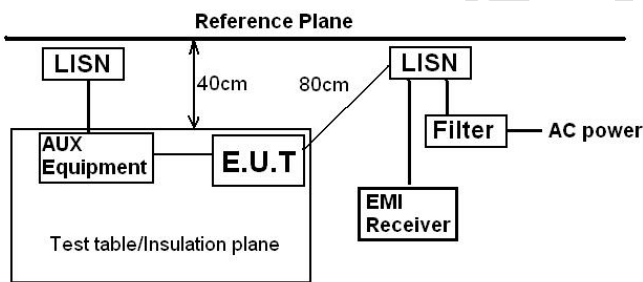
Test Requirement:	FCC Part15 C Section 15.207														
Test Method:	ANSI C63.10:2013														
Test Frequency Range:	150KHz to 30MHz														
Class / Severity:	Class B														
Receiver setup:	RBW=9KHz, VBW=30KHz, Sweep time=auto														
Limit:	<table border="1"> <thead> <tr> <th rowspan="2">Frequency range (MHz)</th> <th colspan="2">Limit (dBuV)</th> </tr> <tr> <th>Quasi-peak</th> <th>Average</th> </tr> </thead> <tbody> <tr> <td>0.15-0.5</td> <td>66 to 56*</td> <td>56 to 46*</td> </tr> <tr> <td>0.5-5</td> <td>56</td> <td>46</td> </tr> <tr> <td>5-30</td> <td>60</td> <td>50</td> </tr> </tbody> </table> <p>* Decreases with the logarithm of the frequency.</p>	Frequency range (MHz)	Limit (dBuV)		Quasi-peak	Average	0.15-0.5	66 to 56*	56 to 46*	0.5-5	56	46	5-30	60	50
Frequency range (MHz)	Limit (dBuV)														
	Quasi-peak	Average													
0.15-0.5	66 to 56*	56 to 46*													
0.5-5	56	46													
5-30	60	50													
Test setup:	 <p><i>Remark</i>        E.U.T: Equipment Under Test        LISN: Line Impedance Stabilization Network        Test table height=0.8m</p>														
Test procedure:	<ol style="list-style-type: none"> <li>1. The E.U.T and simulators are connected to the main power through a line impedance stabilization network (L.I.S.N.). This provides a 50ohm/50uH coupling impedance for the measuring equipment.</li> <li>2. The peripheral devices are also connected to the main power through a LISN that provides a 50ohm/50uH coupling impedance with 50ohm termination. (Please refer to the block diagram of the test setup and photographs).</li> <li>3. Both sides of A.C. line are checked for maximum conducted interference. In order to find the maximum emission, the relative positions of equipment and all of the interface cables must be changed according to ANSI C63.10:2013 on conducted measurement.</li> </ol>														
Test Instruments:	Refer to section 6.0 for details														
Test mode:	Refer to section 5.2 for details														
Test results:	Pass														

### Measurement data:

**Line:**

<b>EUT:</b>	Haylou Wireless Earbuds	<b>Probe:</b>	L1
<b>Model:</b>	GT3	<b>Power Source:</b>	AC120V/60Hz
<b>Mode:</b>	BT mode	<b>Test by:</b>	Eason
<b>Temp./Hum.(%RH):</b>	26°C/60%RH		

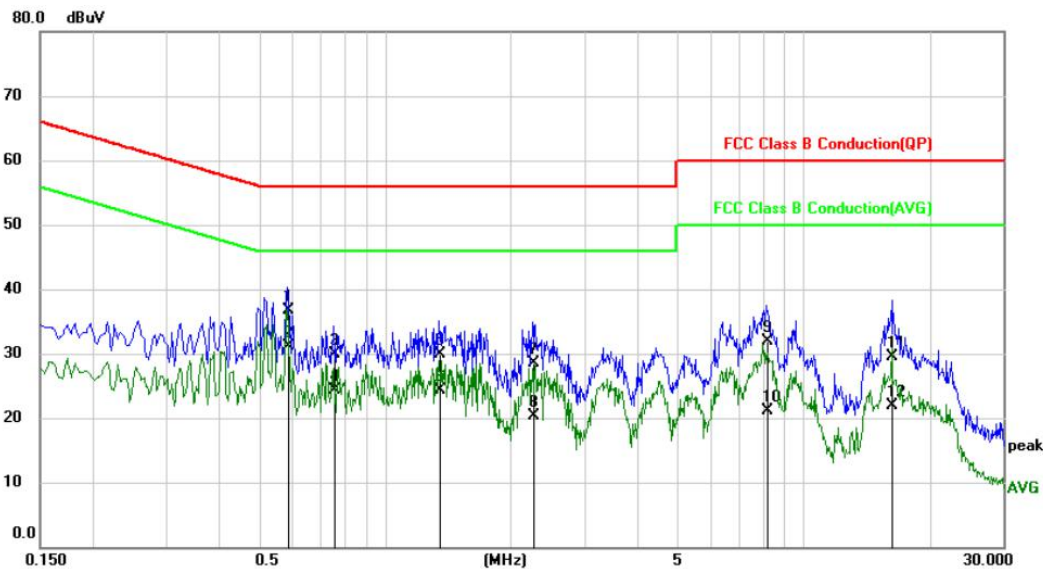

No.	Mk.	Freq. MHz	Reading Level dBuV	Correct Factor dB	Measure- ment dBuV	Limit dBuV	Over dB	Detector
1		0.5860	26.99	9.74	36.73	56.00	-19.27	QP
2	*	0.5860	21.31	9.74	31.05	46.00	-14.95	AVG
3		0.7580	20.18	9.70	29.88	56.00	-26.12	QP
4		0.7580	14.60	9.70	24.30	46.00	-21.70	AVG
5		1.3460	20.18	9.82	30.00	56.00	-26.00	QP
6		1.3460	14.48	9.82	24.30	46.00	-21.70	AVG
7		2.2500	18.72	9.81	28.53	56.00	-27.47	QP
8		2.2500	10.57	9.81	20.38	46.00	-25.62	AVG
9		8.1620	22.01	9.88	31.89	60.00	-28.11	QP
10		8.1620	11.13	9.88	21.01	50.00	-28.99	AVG
11		16.2300	19.60	9.96	29.56	60.00	-30.44	QP
12		16.2300	11.92	9.96	21.88	50.00	-28.12	AVG

**Neutral:**

<b>EUT:</b>	Haylou Wireless Earbuds	<b>Probe:</b>	N
<b>Model:</b>	GT3	<b>Power Source:</b>	AC120V/60Hz
<b>Mode:</b>	BT mode	<b>Test by:</b>	Eason
<b>Temp./Hum.(%RH):</b>	26°C/60%RH		

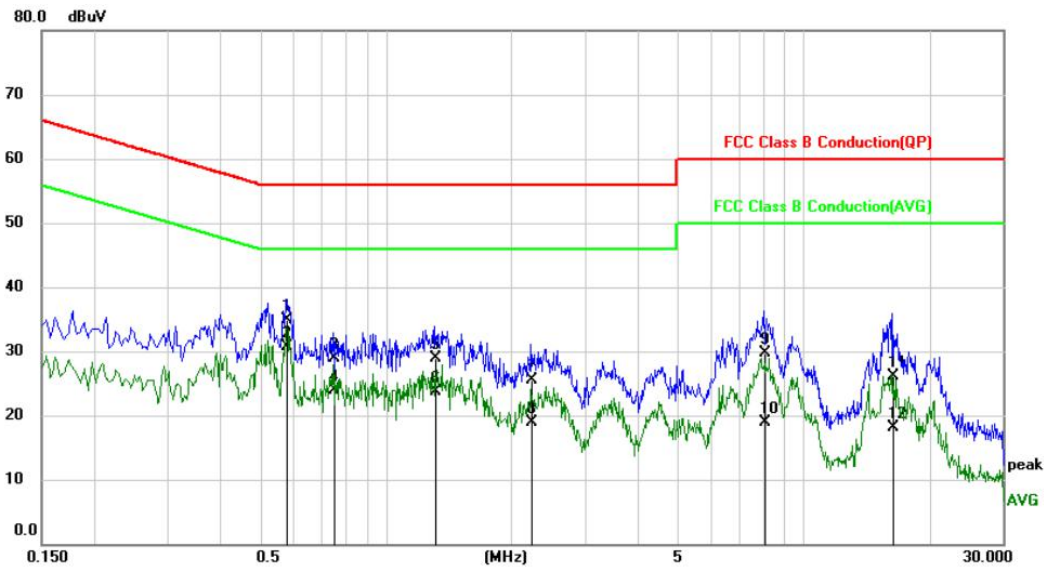

No.	Mk.	Freq.	Reading Level	Correct Factor	Measurement	Limit	Over	Detector
		MHz	dBuV	dB	dBuV	dBuV	dB	
1		0.5780	25.10	9.74	34.84	56.00	-21.16	QP
2	*	0.5780	20.95	9.74	30.69	46.00	-15.31	AVG
3		0.7500	19.16	9.74	28.90	56.00	-27.10	QP
4		0.7500	14.09	9.74	23.83	46.00	-22.17	AVG
5		1.3099	19.12	9.83	28.95	56.00	-27.05	QP
6		1.3099	13.79	9.83	23.62	46.00	-22.38	AVG
7		2.2300	15.68	9.86	25.54	56.00	-30.46	QP
8		2.2300	9.08	9.86	18.94	46.00	-27.06	AVG
9		8.0420	19.85	9.87	29.72	60.00	-30.28	QP
10		8.0420	8.95	9.87	18.82	50.00	-31.18	AVG
11		16.3420	16.07	10.01	26.08	60.00	-33.92	QP
12		16.3420	8.07	10.01	18.08	50.00	-31.92	AVG

**Notes:**

1. An initial pre-scan was performed on the line and neutral lines with peak detector.
2. Quasi-Peak and Average measurement were performed at the frequencies with maximized peak emission.

BlueAsia of Technical Services(Shenzhen) Co., Ltd.

 IOT Test Centre of BlueAsia, No. 448 Bulong Road, Bantian Street, Longgang District, Shenzhen, China  
 Telephone: TEL: +86-755-28682673 FAX: +86-755-28682673  
 Email: marketing@cblueasia.com

3. Final Level =Receiver Read level +Correct Factor
4. Correct Factor = LISN Factor + Cable Loss

### 7.3 Conducted Peak Output Power

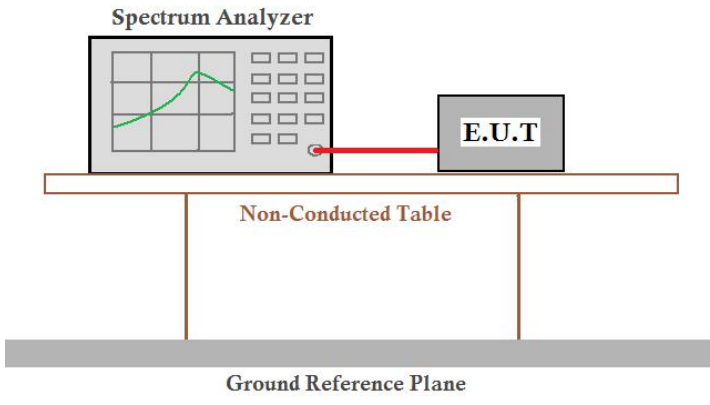
Test Requirement:	FCC Part15 C Section 15.247 (b)(3)
Test Method:	ANSI C63.10:2013
Limit:	21dBm(for GFSK),21dBm(for EDR)
Test setup:	 <p>The diagram illustrates the test setup. A Spectrum Analyzer is connected to an E.U.T. (Equipment Under Test) via a red cable. Both are placed on a Non-Conducted Table, which sits on a Ground Reference Plane.</p>
Test Instruments:	Refer to section 6.0 for details
Test mode:	Refer to section 5.2 for details
Test results:	Pass

#### Measurement Data

Reference to the AppendixC: Maximum conducted output power

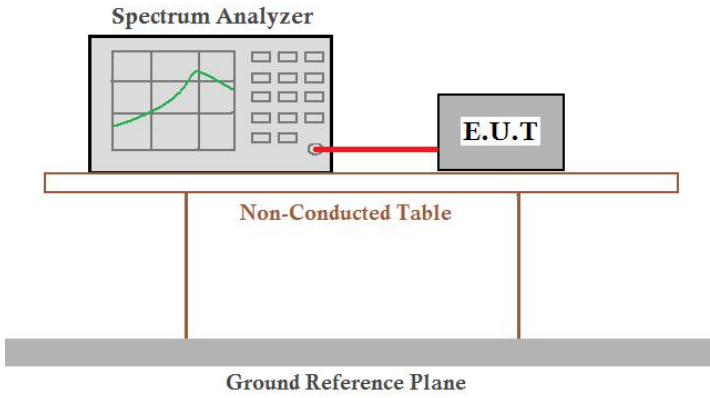

#### 7.4 20dB Emission Bandwidth

Test Requirement:	FCC Part15 C Section 15.247 (a)(2)
Test Method:	ANSI C63.10:2013
Limit:	N/A
Test setup:	 <p>The diagram illustrates the test setup. A Spectrum Analyzer is connected to an E.U.T. (Equipment Under Test) via a red cable. Both are placed on a Non-Conducted Table, which is supported by a Ground Reference Plane.</p>
Test Instruments:	Refer to section 6.0 for details
Test mode:	Refer to section 5.2 for details
Test results:	Pass

#### Measurement Data

Reference to the AppendixA: 20dBEmission Bandwidth

### 7.5 Carrier Frequencies Separation

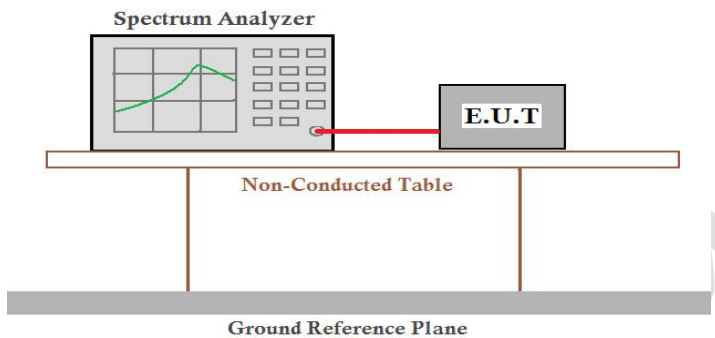
Test Requirement:	FCC Part15 C Section 15.247 (a)(1)
Test Method:	ANSI C63.10:2013
Receiver setup:	RBW=100KHz, VBW=300KHz, detector=Peak
Limit:	GFSK & Pi/4QPSK & 8-DPSK: 0.025MHz or 2/3 of the 20dB bandwidth (whichever is greater)
Test setup:	 <p>The diagram illustrates the test setup. A Spectrum Analyzer is connected to an E.U.T. (Equipment Under Test) via a red cable. Both the Spectrum Analyzer and the E.U.T. are placed on a Non-Conducted Table. The table is supported by a Ground Reference Plane.</p>
Test Instruments:	Refer to section 6.0 for details
Test mode:	Refer to section 5.2 for details
Test results:	Pass

#### Measurement Data

Reference to the AppendixD: Carrier frequency separation

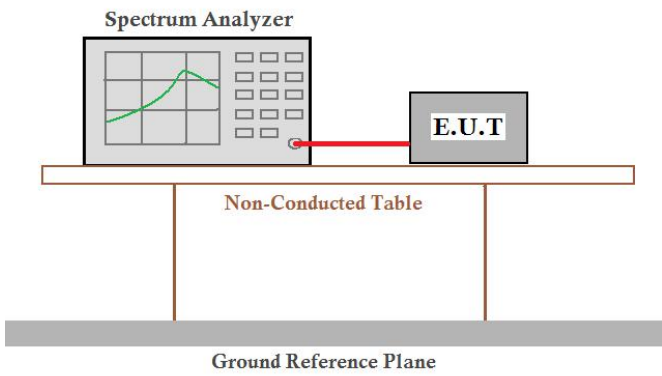

## 7.6 Hopping Channel Number

Test Requirement:	FCC Part15 C Section 15.247 (a)(1)
Test Method:	ANSI C63.10:2013
Receiver setup:	RBW=100kHz, VBW=300kHz, Frequency range=2400MHz-2483.5MHz, Detector=Peak
Limit:	15 channels
Test setup:	 <p>The diagram illustrates the test setup. A Spectrum Analyzer is connected to an E.U.T. (Equipment Under Test) via a red cable. Both are placed on a Non-Conducted Table, which is supported by a Ground Reference Plane.</p>
Test Instruments:	Refer to section 6.0 for details
Test mode:	Refer to section 5.2 for details
Test results:	Pass

### Measurement Data:

Reference to the AppendixF: Number of hopping channels

### 7.7 Dwell Time

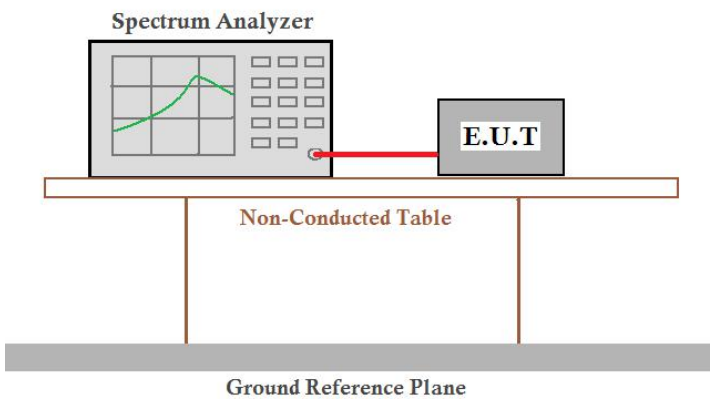
Test Requirement:	FCC Part15 C Section 15.247 (a)(1)
Test Method:	ANSI C63.10:2013
Receiver setup:	RBW=1MHz, VBW=1MHz, Span=0Hz, Detector=Peak
Limit:	0.4 Second
Test setup:	 <p>The diagram illustrates the test setup. A Spectrum Analyzer is connected to an E.U.T. (Equipment Under Test) via a red cable. Both are placed on a Non-Conducted Table, which is supported by a Ground Reference Plane.</p>
Test Instruments:	Refer to section 6.0 for details
Test mode:	Refer to section 5.2 for details
Test results:	Pass

#### Measurement Data

Reference to the AppendixE: Time of occupancy

### 7.8 Pseudorandom Frequency Hopping Sequence

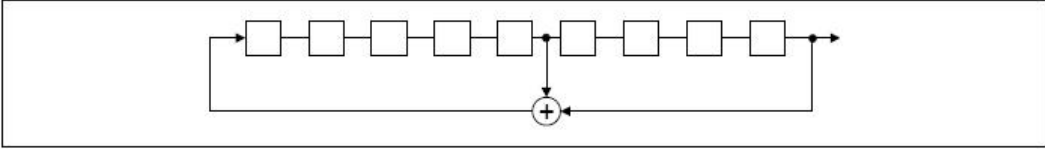
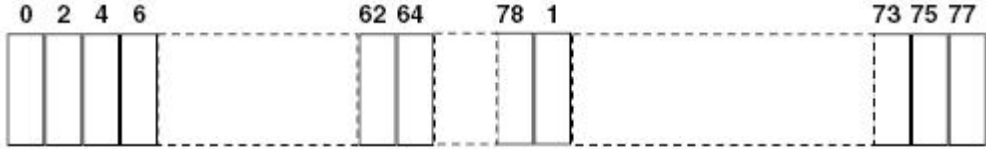
<b>Test Requirement:</b>	<b>FCC Part15 C Section 15.247 (a)(1) requirement:</b>
<p><i>Frequency hopping systems shall have hopping channel carrier frequencies separated by a minimum of 25 kHz or the 20 dB bandwidth of the hopping channel, whichever is greater.</i></p> <p><i>Alternatively. Frequency hopping systems operating in the 2400-2483.5 MHz band may have hopping channel carrier frequencies that are separated by 25 kHz or two-thirds of the 20 dB bandwidth of the hopping channel, whichever is greater, provided the systems operate with an output power no greater than 125 mW. The system shall hop to channel frequencies that are selected at the system hopping rate from a Pseudorandom ordered list of hopping frequencies. Each frequency must be used equally on the average by each transmitter. The system receivers shall have input bandwidths that match the hopping channel bandwidths of their corresponding transmitters and shall shift frequencies in synchronization with the transmitted signals.</i></p>	
<b>EUT Pseudorandom Frequency Hopping Sequence</b>	
<p><i>The pseudorandom sequence may be generated in a nine-stage shift register whose 5th and 9th stage outputs are added in a modulo-two addition stage. And the result is fed back to the input of the first stage. The sequence begins with the first ONE of 9 consecutive ONES; i.e. the shift register is initialized with nine ones.</i></p> <ul style="list-style-type: none"> <li>• Number of shift register stages: 9</li> <li>• Length of pseudo-random sequence: <math>2^9 - 1 = 511</math> bits</li> <li>• Longest sequence of zeros: 8 (non-inverted signal)</li> </ul>	
	
<p><i>Linear Feedback Shift Register for Generation of the PRBS sequence</i></p>	
<p><i>An example of Pseudorandom Frequency Hopping Sequence as follow:</i></p>	
	
<p><i>Each frequency used equally on the average by each transmitter.</i></p> <p><i>The system receivers have input bandwidths that match the hopping channel bandwidths of their corresponding transmitters and shift frequencies in synchronization with the transmitted signals.</i></p>	

## 7.9 Band Edge

### 7.9.1 Conducted Emission Method

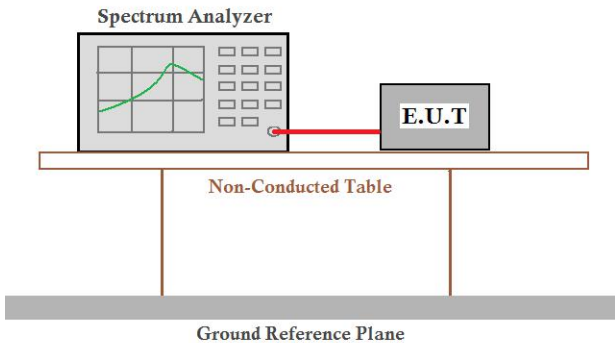
Test Requirement:	FCC Part15 C Section 15.247 (d)
Test Method:	ANSI C63.10:2013
Receiver setup:	RBW=100kHz, VBW=300kHz, Detector=Peak
Limit:	In any 100 kHz bandwidth outside the frequency band in which the spread spectrum intentional radiator is operating, the radio frequency power that is produced by the intentional radiator shall be at least 20 dB below that in the 100 kHz bandwidth within the band that contains the highest level of the desired power, based on either an RF conducted or a radiated measurement.
Test setup:	 <p>The diagram illustrates the test setup. A Spectrum Analyzer is connected to an E.U.T. (Equipment Under Test) via a red cable. Both are placed on a Non-Conducted Table, which is supported by a Ground Reference Plane.</p>
Test Instruments:	Refer to section 6.0 for details
Test mode:	Refer to section 5.2 for details
Test results:	Pass

#### Measurement Data

Reference to the AppendixG:Band edge measurements

### 7.9.2 Radiated Emission Method

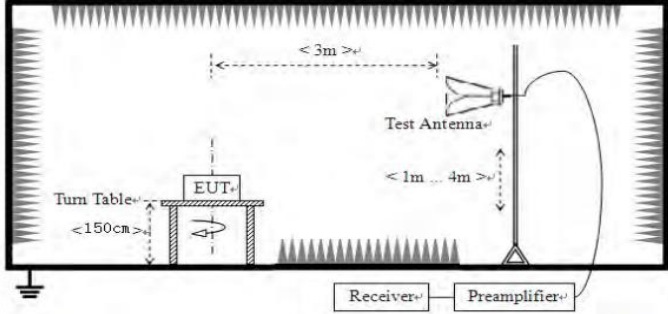
Test Requirement:	FCC Part15 C Section 15.209 and 15.205				
Test Method:	ANSI C63.10:2013				
Test Frequency Range:	All restriction band have been tested, and 2310MHz to 2390MHz, 2483.5MHz to 2500MHz band is the worse case				
Test site:	Measurement Distance: 3m				
Receiver setup:	Frequency	Detector	RBW	VBW	Remark
	Above 1GHz	Peak	1MHz	3MHz	Peak Value
		Peak	1MHz	10Hz	Average Value
Limit:	Frequency		Limit (dBuV/m @3m)		Remark
	Above 1GHz		54.00		Average Value
			74.00		Peak Value
Test setup:					
Test Procedure:	<ol style="list-style-type: none"> <li>1. The EUT was placed on the top of a rotating table 1.5 meters above the ground at a 3 meter camber. The table was rotated 360 degrees to determine the position of the highest radiation.</li> <li>2. The EUT was set 3 meters away from the interference-receiving antenna, which was mounted on the top of a variable-height antenna tower.</li> <li>3. The antenna height is varied from one meter to four meters above the ground to determine the maximum value of the field strength. Both horizontal and vertical polarizations of the antenna are set to make the measurement.</li> <li>4. For each suspected emission, the EUT was arranged to its worst case and then the antenna was tuned to heights from 1 meter to 4 meters and the rota table was turned from 0 degrees to 360 degrees to find the maximum reading.</li> <li>5. The test-receiver system was set to Peak Detect Function and Specified Bandwidth with Maximum Hold Mode.</li> <li>6. If the emission level of the EUT in peak mode was 10dB lower than the limit specified, then testing could be stopped and the peak values of the EUT would be reported. Otherwise the emissions that did not have 10dB margin would be re-tested one by one using peak, quasi-peak or average method as specified and then reported in a data sheet.</li> </ol>				
Test Instruments:	Refer to section 6.0 for details				
Test mode:	Refer to section 5.2 for details				
Test results:	Pass				

Remark:

1. During the test, pre-scan the GFSK, Pi/4QPSK, 8-DPSK modulation, and found the 8-DPSK modulation which it is worse case.

Test channel:	Lowest
---------------	--------

Peak value:

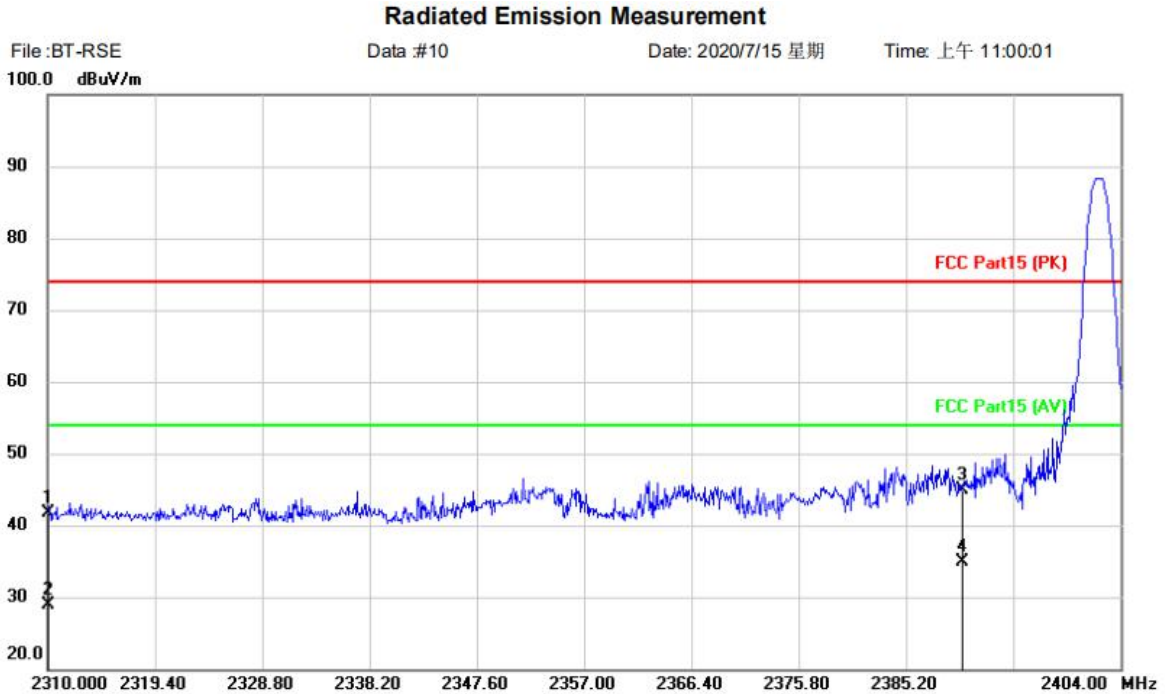

Site	Polarization: <b>Vertical</b>	Temperature:
Limit: FCC Part15 (PK)	Power:	Humidity: %
EUT: Haylou Wireless Earbuds	Distance: 3m	
M/N: GT3		
Mode: TX-L		
Note:		

No. Mk.	Freq. MHz	Reading Level dBuV	Correct Factor dB	Measurement dBuV/m	Limit dBuV/m	Over dB	Detector	Antenna Height cm	Table Degree	Comment
1	2310.000	55.93	-14.30	41.63	74.00	-32.37	peak			
2	2310.000	43.19	-14.30	28.89	54.00	-25.11	AVG			
3	2390.000	58.95	-13.95	45.00	74.00	-29.00	peak			
4 *	2390.000	48.87	-13.95	34.92	54.00	-19.08	AVG			

**Radiated Emission Measurement**

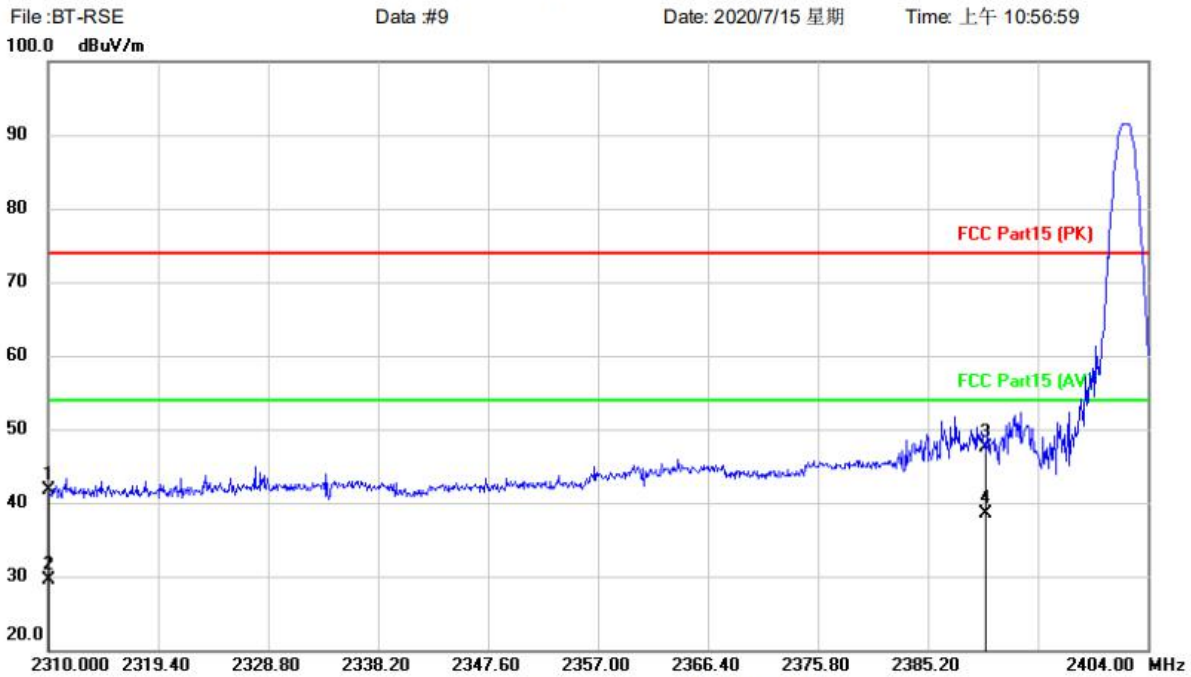

Site	Polarization: <b>Horizontal</b>	Temperature:
Limit: FCC Part15 (PK)	Power:	Humidity: %
EUT: Haylou Wireless Earbuds	Distance: 3m	
M/N: GT3		
Mode: TX-L		
Note:		

No.	Mk.	Freq.	Reading Level	Correct Factor	Measurement	Limit	Over	Antenna Height	Table Degree	
		MHz	dBuV	dB	dBuV/m	dBuV/m	dB	cm	degree	Comment
1		2310.000	55.68	-14.01	41.67	74.00	-32.33			peak
2		2310.000	43.47	-14.01	29.46	54.00	-24.54			AVG
3		2390.000	61.07	-13.62	47.45	74.00	-26.55			peak
4	*	2390.000	52.17	-13.62	38.55	54.00	-15.45			AVG



Test channel: Highest

Peak value:

**Radiated Emission Measurement**

File :BT-RSE      Data #8      Date: 2020/7/15 星期      Time: 上午 10:53:54  
 100.0 dBuV/m

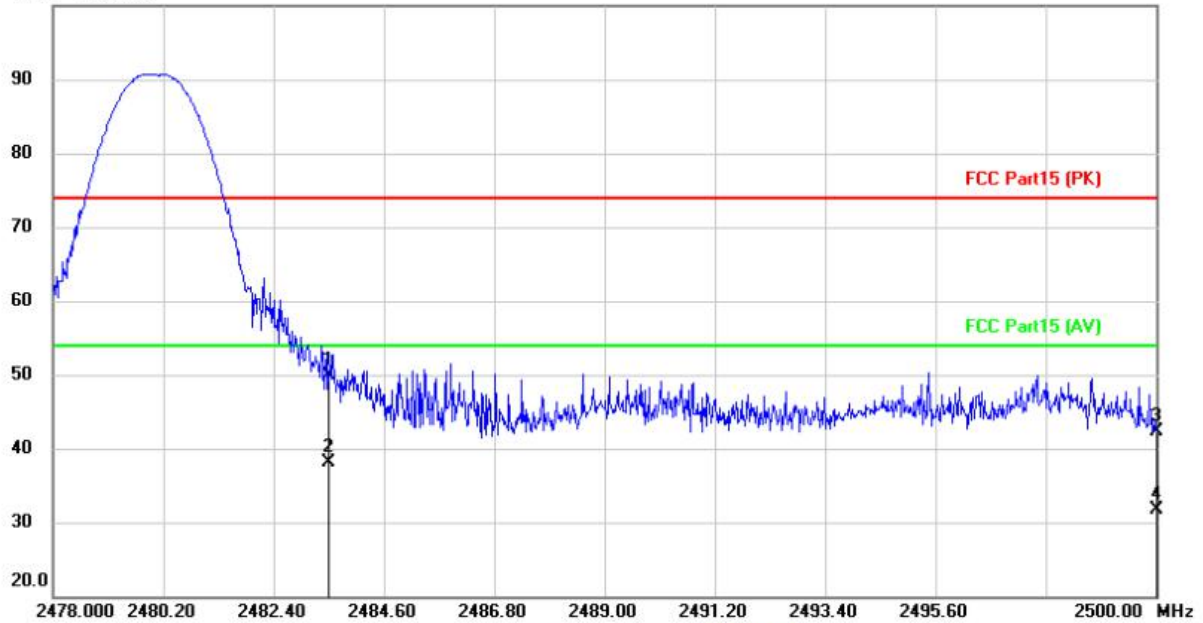

Site: Polarization: **Vertical**      Temperature:      Humidity: %  
 Limit: FCC Part15 (PK)      Power:      Distance: 3m  
 EUT: Haylou Wireless Earbuds  
 M/N: GT3  
 Mode: TX-H  
 Note:

No.	Mk.	Freq. MHz	Reading Level dBuV	Correct Factor dB	Measure- ment dBuV/m	Limit dBuV/m	Over dB	Detector	Antenna Height cm	Table Degree degree	Comment
1		2483.500	63.40	-13.50	49.90	74.00	-24.10	peak			
2	*	2483.500	51.66	-13.50	38.16	54.00	-15.84	AVG			
3		2500.000	55.71	-13.42	42.29	74.00	-31.71	peak			
4		2500.000	45.20	-13.42	31.78	54.00	-22.22	AVG			



**Radiated Emission Measurement**

File :BT-RSE                      Data #7                      Date: 2020/7/15 星期                      Time: 上午 10:51:43  
 100.0 dBuV/m

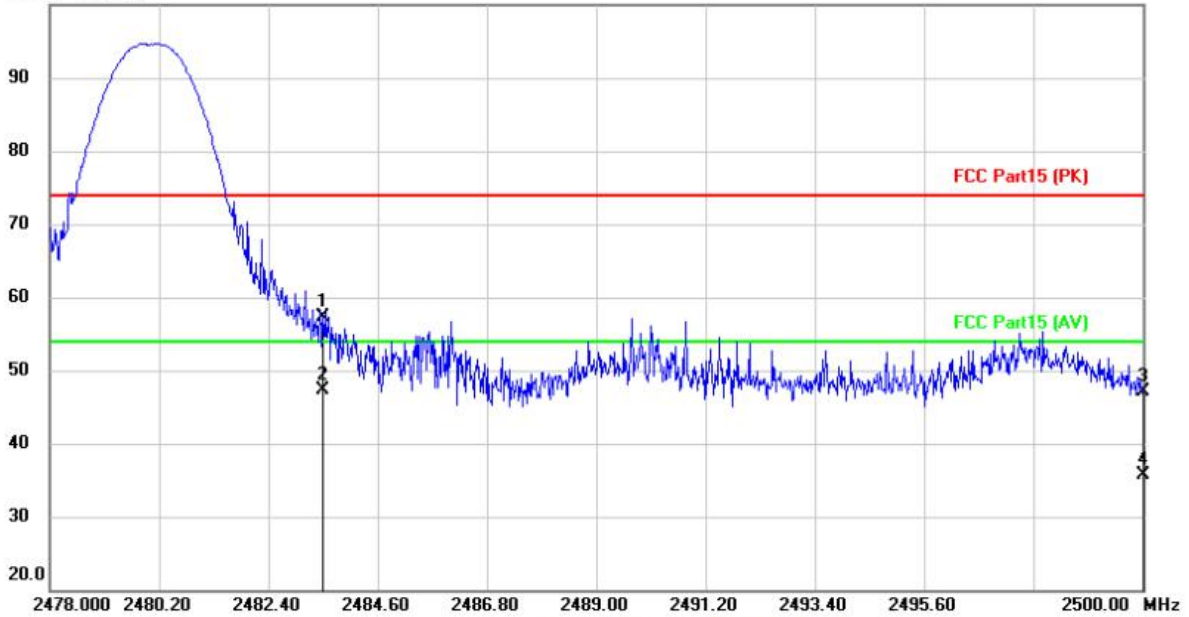

Site    Polarization: **Horizontal**                      Temperature:  
 Limit: FCC Part15 (PK)                      Power:    Humidity: %  
 EUT: Haylou Wireless Earbuds                      Distance: 3m  
 M/N: GT3  
 Mode: TX-H  
 Note:

No.	Mk.	Freq. MHz	Reading Level dBuV	Correct Factor dB	Measure- ment dBuV/m	Limit dBuV/m	Over dB	Detector	Antenna Height cm	Table Degree degree	Comment
1		2483.500	70.40	-13.11	57.29	74.00	-16.71	peak			
2	*	2483.500	60.36	-13.11	47.25	54.00	-6.75	AVG			
3		2500.000	60.12	-13.02	47.10	74.00	-26.90	peak			
4		2500.000	48.68	-13.02	35.66	54.00	-18.34	AVG			

Remark:

1. Final Level = Receiver Read level + Correct factor
2. The emission levels of other frequencies are very lower than the limit and not show in test report.
3. Correct factor = Antenna Factor + Cable Loss - Pre-amplifier Factor

## 7.10 Spurious Emission

### 7.10.1 Conducted Emission Method

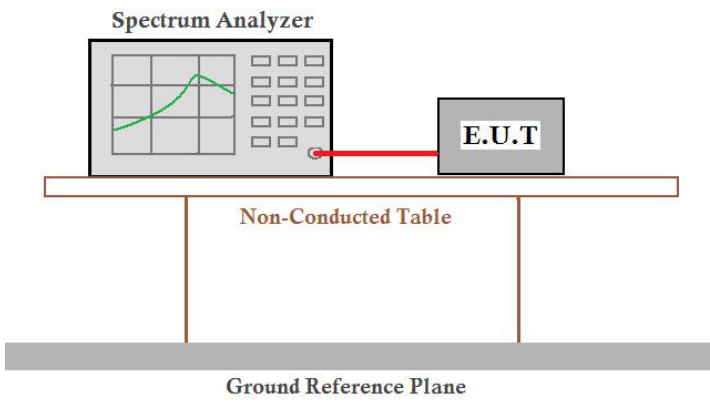
Test Requirement:	FCC Part15 C Section 15.247 (d)
Test Method:	ANSI C63.10:2013
Limit:	In any 100 kHz bandwidth outside the frequency band in which the spread spectrum intentional radiator is operating, the radio frequency power that is produced by the intentional radiator shall be at least 20 dB below that in the 100 kHz bandwidth within the band that contains the highest level of the desired power, based on either an RF conducted or a radiated measurement.
Test setup:	 <p>The diagram illustrates the test setup. A Spectrum Analyzer is connected to an E.U.T. (Equipment Under Test) via a red cable. Both are placed on a Non-Conducted Table, which is positioned above a Ground Reference Plane.</p>
Test Instruments:	Refer to section 6.0 for details
Test mode:	Refer to section 5.2 for details
Test results:	Pass

#### Measurement Data

Reference to the AppendixH:Conducted SpuriousEmission

**7.10.2 Radiated Emission Method**

Test Requirement:	FCC Part15 C Section 15.209				
Test Method:	ANSI C63.10:2013				
Test Frequency Range:	9kHz to 25GHz				
Test site:	Measurement Distance: 3m				
Receiver setup:	Frequency	Detector	RBW	VBW	Value
	9KHz-150KHz	Quasi-peak	200Hz	600Hz	Quasi-peak
	150KHz-30MHz	Quasi-peak	9KHz	30KHz	Quasi-peak
	30MHz-1GHz	Quasi-peak	120KHz	300KHz	Quasi-peak
	Above 1GHz	Peak	1MHz	3MHz	Peak
Peak		1MHz	10Hz	Average	
Limit: (Spurious Emissions)	Frequency	Limit (uV/m)	Value	Measurement Distance	
	0.009MHz-0.490MHz	2400/F(KHz)	QP	300m	
	0.490MHz-1.705MHz	24000/F(KHz)	QP	30m	
	1.705MHz-30MHz	30	QP	30m	
	30MHz-88MHz	100	QP	3m	
	88MHz-216MHz	150	QP		
	216MHz-960MHz	200	QP		
	960MHz-1GHz	500	QP		
	Above 1GHz	500	Average		
5000		Peak			
Limit: (band edge)	Emissions radiated outside of the specified frequency bands, except for harmonics, shall be attenuated by at least 50 dB below the level of the fundamental or to the general radiated emission limits in Section 15.209, whichever is the lesser attenuation.				

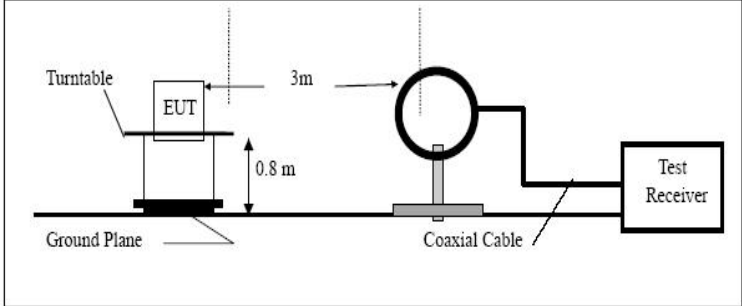
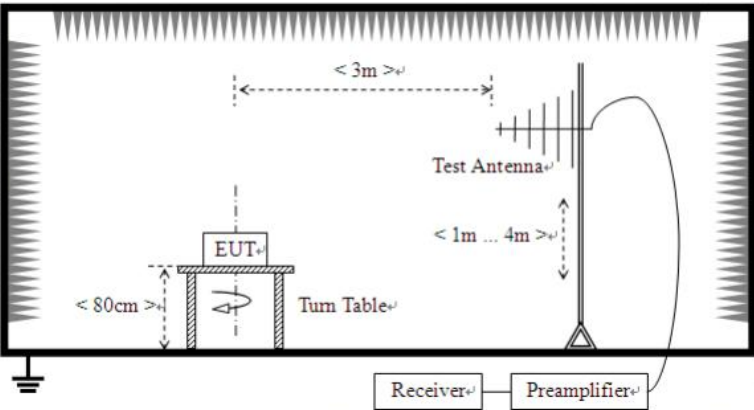
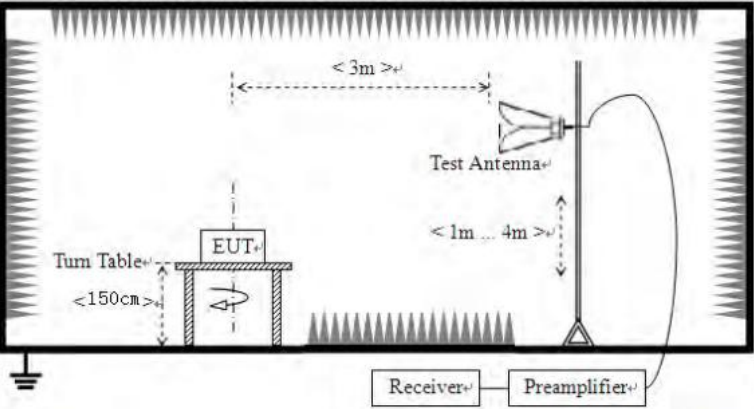
<p>Test setup:</p>	<p>Below 30MHz</p>  <p>Below 1GHz</p>  <p>Above 1GHz</p> 
<p>Test Procedure:</p>	<ol style="list-style-type: none"> <li>1. The EUT was placed on the top of a rotating table (0.8m for below 1G and 1.5m for above 1G) above the ground at a 3 meter camber. The table was rotated 360 degrees to determine the position of the highest radiation.</li> <li>2. The EUT was set 3 meters away from the interference-receiving antenna, which was mounted on the top of a variable-height antenna tower.</li> </ol>

	<ol style="list-style-type: none"> <li>3. The antenna height is varied from one meter to four meters above the ground to determine the maximum value of the field strength. Both horizontal and vertical polarizations of the antenna are set to make the measurement.</li> <li>4. For each suspected emission, the EUT was arranged to its worst case and then the antenna was tuned to heights from 1 meter to 4 meters and the rota table was turned from 0 degrees to 360 degrees to find the maximum reading.</li> <li>5. The test-receiver system was set to Peak Detect Function and Specified Bandwidth with Maximum Hold Mode.</li> <li>6. If the emission level of the EUT in peak mode was 10dB lower than the limit specified, then testing could be stopped and the peak values of the EUT would be reported. Otherwise the emissions that did not have 10dB margin would be re-tested one by one using peak, quasi-peak or average method as specified and then reported in a data sheet.</li> </ol>
Test Instruments:	Refer to section 6.0 for details
Test mode:	Refer to section 5.2 for details
Test results:	Pass

**Measurement data:**

*Remark:*

1. *During the test, pre-scan the GFSK, Pi/4QPSK, 8-DPSK modulation, and found the 8-DPSK modulation which it is worse case.*
2. *Pre-scan all kind of the place mode (X-axis, Y-axis, Z-axis), and found the Y-axis which it is worse case.*
3. *no emission found above 13G,so only show plots below13G*

■ **9 kHz ~ 30 MHz**

The low frequency, which started from 9 kHz to 30 MHz, was pre-scanned and the result which was 20 dB lower than the limit line per 15.31(o) was not reported.

■ Below 1GHz

<b>EUT:</b>	Haylou Wireless Earbuds	<b>Polarization:</b>	Horizontal
<b>Model:</b>	GT3	<b>Power Source:</b>	AC120V/60Hz
<b>Mode:</b>	BT mode	<b>Test by:</b>	Eason
<b>Temp./Hum.(%RH):</b>	26°C/60%RH		
<b>Note:</b>			

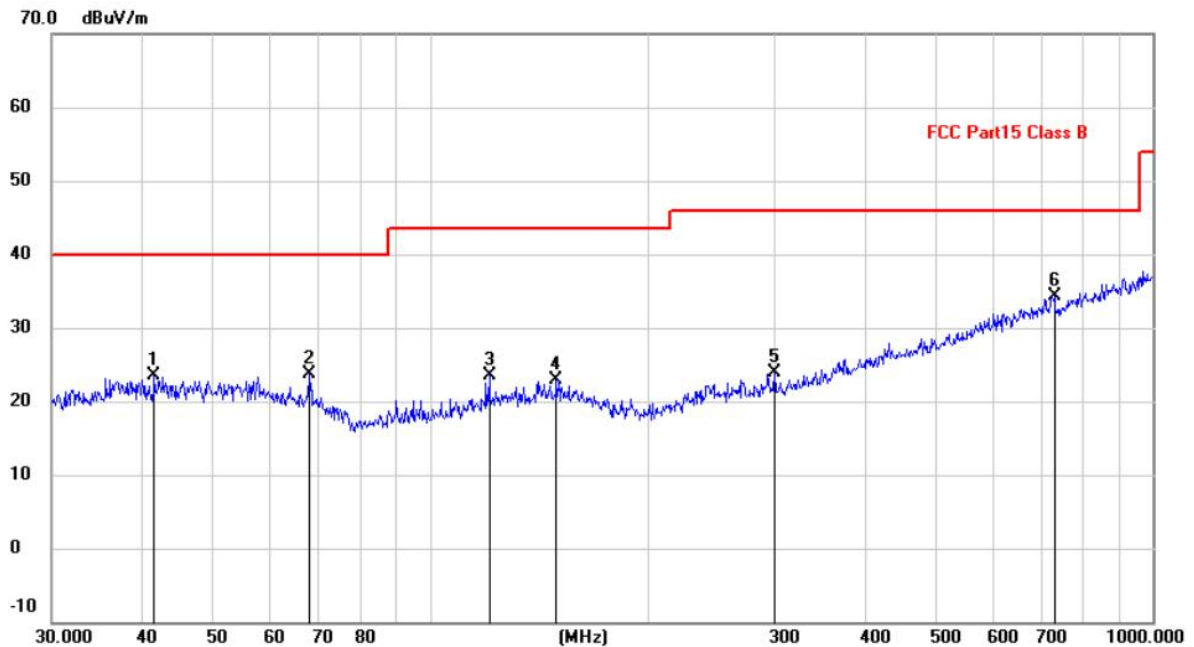

No.	Mk.	Freq. MHz	Reading Level dBuV	Correct Factor dB	Measure- ment dBuV/m	Limit dBuV/m	Over dB	Detector
1		41.5806	-0.63	24.07	23.44	40.00	-16.56	QP
2		68.2074	2.34	21.35	23.69	40.00	-16.31	QP
3		120.8674	0.96	22.50	23.46	43.50	-20.04	QP
4		149.7262	-0.17	23.06	22.89	43.50	-20.61	QP
5		300.0058	0.22	23.62	23.84	46.00	-22.16	QP
6	*	731.6917	1.00	33.34	34.34	46.00	-11.66	QP



<b>EUT:</b>	Haylou Wireless Earbuds	<b>Polarziation:</b>	Vertical
<b>Model:</b>	GT3	<b>Power Source:</b>	AC120V/60Hz
<b>Mode:</b>	BT mode	<b>Test by:</b>	Eason
<b>Temp./Hum.(%RH):</b>	26°C/60%RH		
<b>Note:</b>			

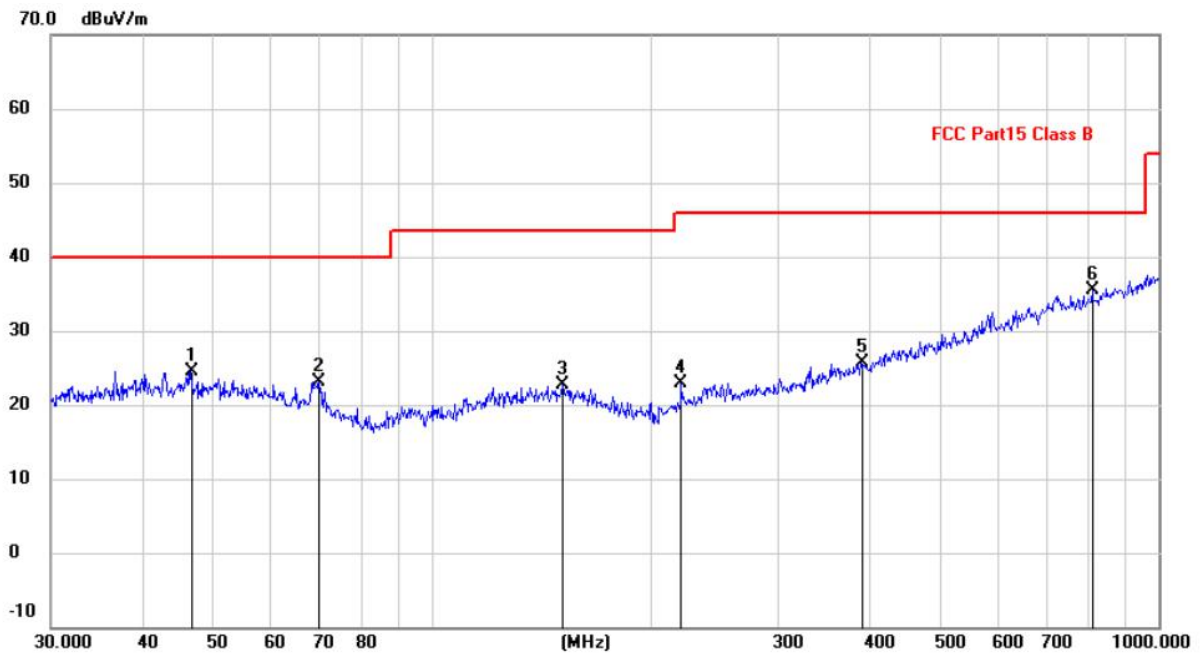

No.	Mk.	Freq. MHz	Reading Level dBuV	Correct Factor dB	Measure- ment dBuV/m	Limit dBuV/m	Over dB	Detector
1		46.6664	0.38	24.19	24.57	40.00	-15.43	QP
2		70.0903	2.23	20.94	23.17	40.00	-16.83	QP
3		151.5972	-0.34	23.05	22.71	43.50	-20.79	QP
4		220.6171	1.51	21.44	22.95	46.00	-23.05	QP
5		389.3549	-0.97	26.65	25.68	46.00	-20.32	QP
6	*	810.2654	0.84	34.59	35.43	46.00	-10.57	QP

■ Above 1GHz

Test channel:	Lowest
---------------	--------

Peak value:

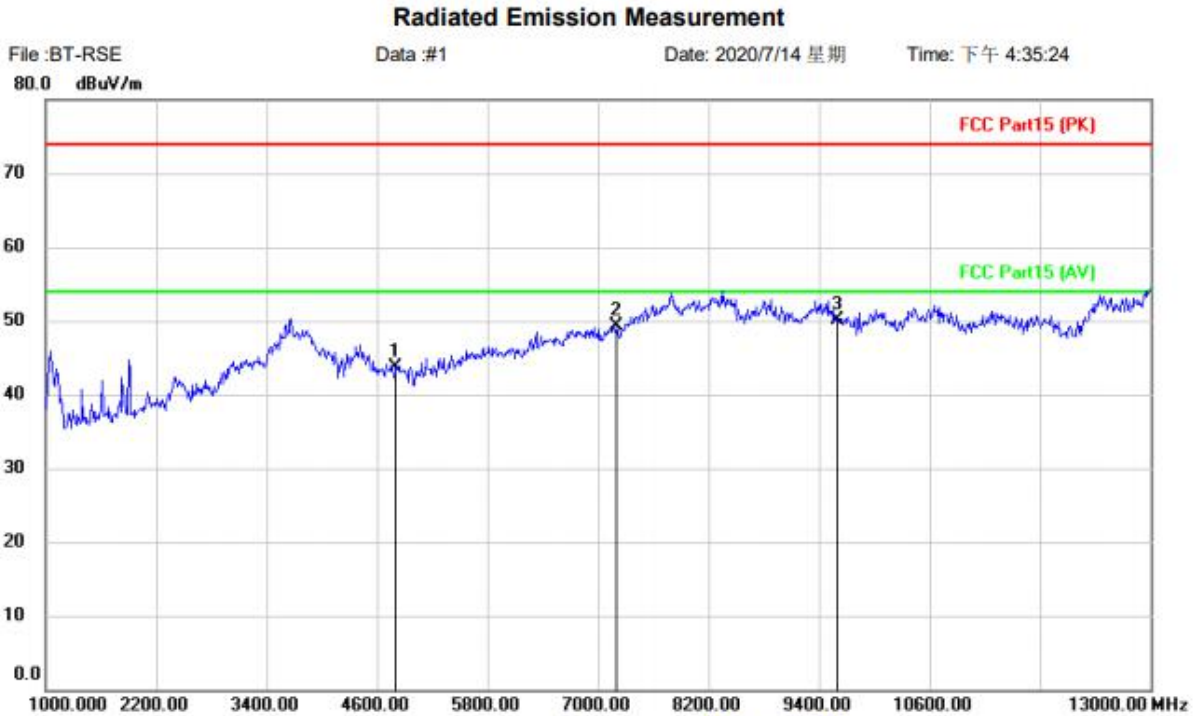

Site	Polarization: <b>Horizontal</b>	Temperature:
Limit: FCC Part15 (PK)	Power:	Humidity: %
EUT: Haylou Wireless Earbuds	Distance: 3m	
M/N: GT3		
Mode: TX-L		
Note:		

No.	Mk.	Freq.	Reading Level	Correct Factor	Measurement	Limit	Over	Antenna Height	Table Degree	
		MHz	dBuV	dB	dBuV/m	dBuV/m	dB	cm	degree	Comment
1		4804.000	50.02	-6.35	43.67	74.00	-30.33			peak
2		7204.000	50.02	-0.72	49.30	74.00	-24.70			peak
3	*	9604.000	47.62	2.43	50.05	74.00	-23.95			peak



**Radiated Emission Measurement**

File :BT-RSE      Data :#2      Date: 2020/7/14 星期      Time: 下午 4:39:19



Site:      Polarization: **Vertical**      Temperature:      Humidity: %  
 Limit: FCC Part15 (PK)      Power:      Distance: 3m  
 EUT: Haylou Wireless Earbuds  
 M/N: GT3  
 Mode: TX-L  
 Note:

No.	Mk.	Freq. MHz	Reading Level dBuV	Correct Factor dB	Measure- ment dBuV/m	Limit dBuV/m	Over dB	Detector	Antenna Height cm	Table Degree degree	Comment
1		4804.000	50.84	-6.35	44.49	74.00	-29.51	peak			
2		7204.000	49.75	-0.47	49.28	74.00	-24.72	peak			
3	*	9604.000	47.48	2.23	49.71	74.00	-24.29	peak			

Remark:

1. Final Level = Receiver Read level + Correct factor
2. Correct factor = Antenna Factor + Cable Loss – Preamplifier Factor
3. “\*”, means this data is the too weak instrument of signal is unable to test.
4. The emission levels of other frequencies are very lower than the limit and not show in test report.

Test channel:	Middle
---------------	--------

Peak value:

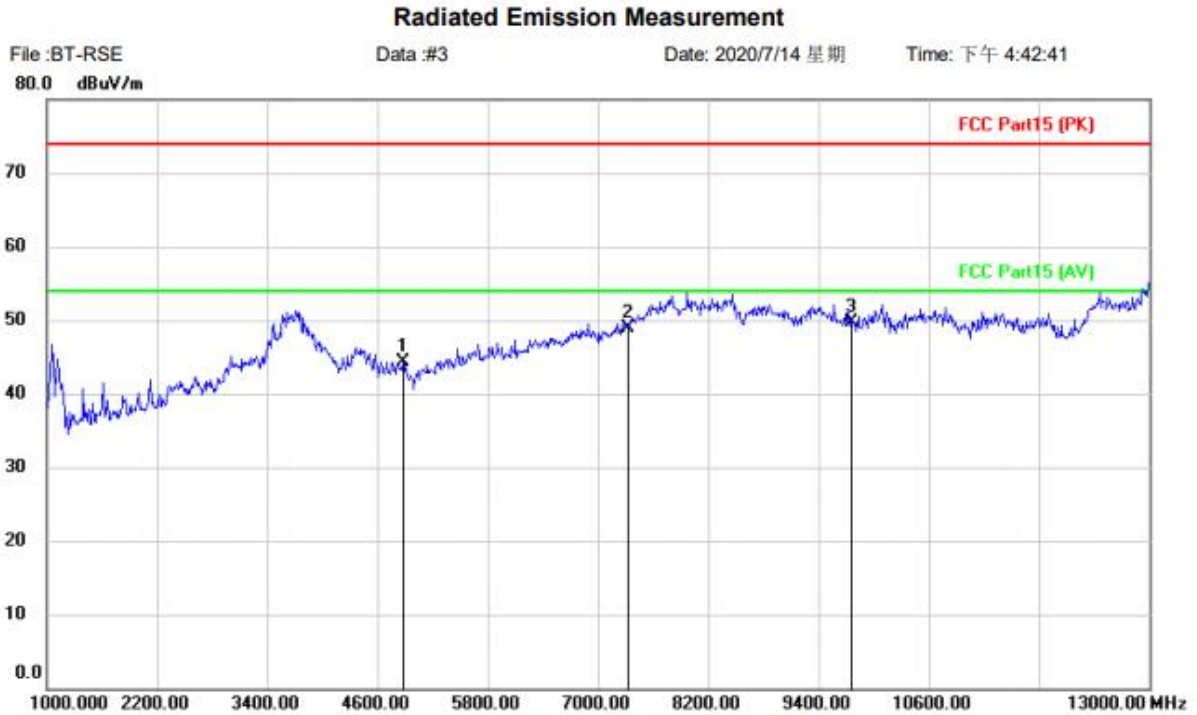

Site	Polarization: <b>Vertical</b>	Temperature:
Limit: FCC Part15 (PK)	Power:	Humidity: %
EUT: Haylou Wireless Earbuds	Distance: 3m	
M/N: GT3		
Mode: TX-M		
Note:		

No.	Mk.	Freq.	Reading Level	Correct Factor	Measurement	Limit	Over	Antenna Height	Table Degree	
		MHz	dBuV	dB	dBuV/m	dBuV/m	dB	cm	degree	Comment
1		4876.000	50.80	-6.51	44.29	74.00	-29.71			peak
2		7324.000	48.97	-0.02	48.95	74.00	-25.05			peak
3	*	9760.000	47.21	2.52	49.73	74.00	-24.27			peak

**Radiated Emission Measurement**

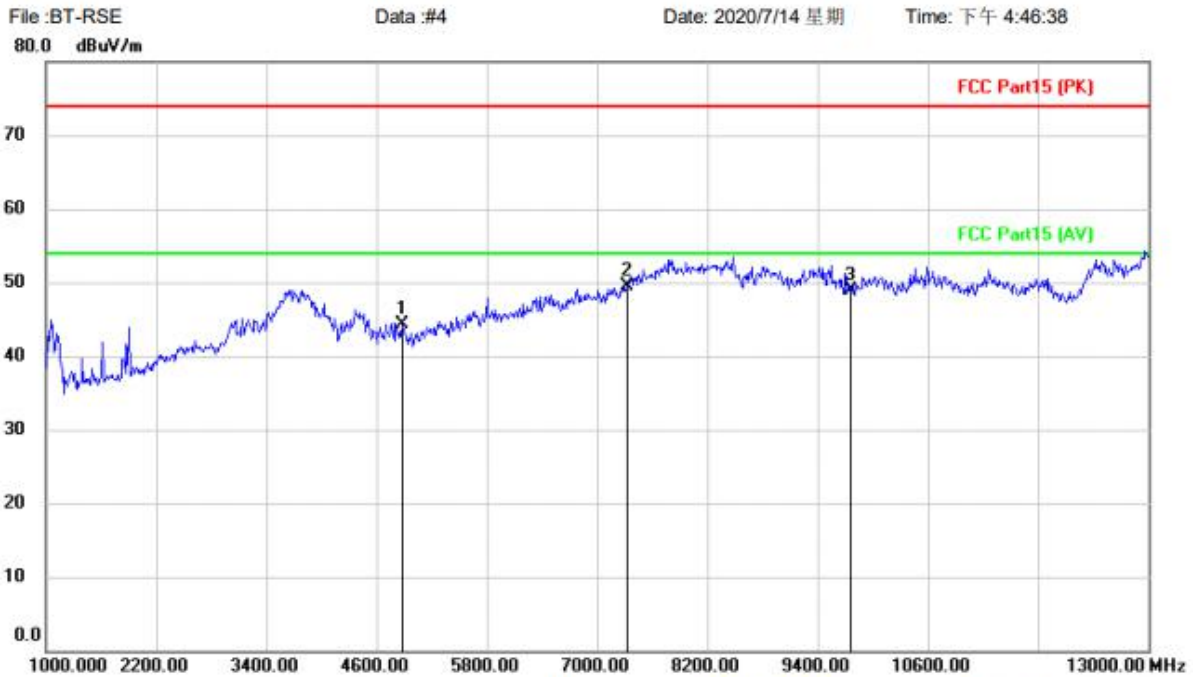

Site      Polarization: **Horizontal**      Temperature:

Limit: FCC Part15 (PK)      Power:      Humidity: %

EUT: Haylou Wireless Earbuds      Distance: 3m

M/N: GT3

Mode: TX-M

Note:

No.	Mk.	Freq.	Reading Level	Correct Factor	Measurement	Limit	Over	Antenna Height	Table Degree	
		MHz	dBuV	dB	dBuV/m	dBuV/m	dB	cm	degree	Comment
1		4876.000	50.88	-6.51	44.37	74.00	-29.63			peak
2	*	7324.000	49.35	0.12	49.47	74.00	-24.53			peak
3		9760.000	46.34	2.56	48.90	74.00	-25.10			peak

**Remark:**

1. Final Level =Receiver Read level + Correct facto
2. Correct factor = Antenna Factor + Cable Loss – Preamplifier Factor
3. “\*”, means this data is the too weak instrument of signal is unable to test.
4. The emission levels of other frequencies are very lower than the limit and not show in test report.

Test channel:	Highest
---------------	---------

Peak value:

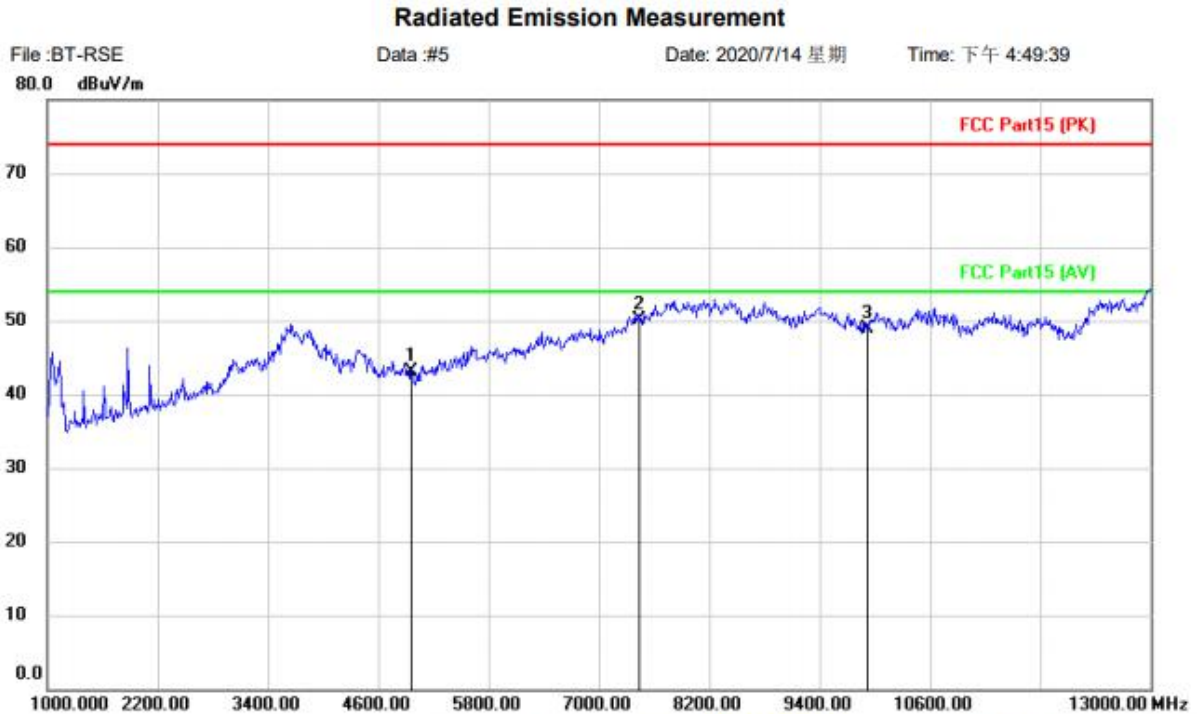

Site	Polarization: <b>Horizontal</b>	Temperature:
Limit: FCC Part15 (PK)	Power:	Humidity: %
EUT: Haylou Wireless Earbuds	Distance: 3m	
M/N: GT3		
Mode: TX-H		
Note:		

No.	Mk.	Freq.	Reading Level	Correct Factor	Measurement	Limit	Over	Antenna Height	Table Degree	
		MHz	dBuV	dB	dBuV/m	dBuV/m	dB	cm	degree	Comment
1		4960.000	49.97	-6.80	43.17	74.00	-30.83			peak
2	*	7444.000	49.27	0.89	50.16	74.00	-23.84			peak
3		9916.000	45.82	3.09	48.91	74.00	-25.09			peak

**Radiated Emission Measurement**

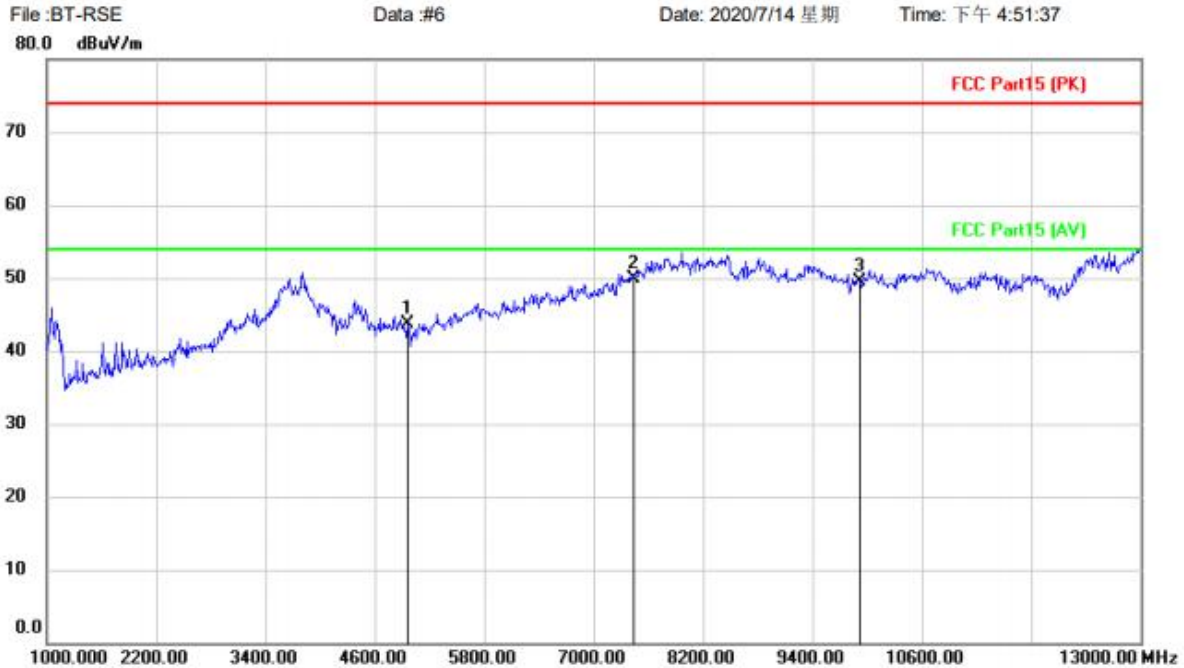

Site      Polarization: **Vertical**      Temperature:

Limit: FCC Part15 (PK)      Power:      Humidity: %

EUT: Haylou Wireless Earbuds      Distance: 3m

M/N: GT3

Mode: TX-H

Note:

No.	Mk.	Freq.	Reading Level	Correct Factor	Measurement	Limit	Over	Antenna Height	Table Degree	
		MHz	dBuV	dB	dBuV/m	dBuV/m	dB	cm	degree	Comment
1		4960.000	50.53	-6.80	43.73	74.00	-30.27			peak
2	*	7444.000	49.62	0.36	49.98	74.00	-24.02			peak
3		9916.000	46.22	3.20	49.42	74.00	-24.58			peak

Remark:

1. Final Level = Receiver Read level + Correct factor
2. Correct factor = Antenna Factor + Cable Loss – Preamplifier Factor
3. “\*”, means this data is the too weak instrument of signal is unable to test.
4. The emission levels of other frequencies are very lower than the limit and not show in test report.