

深圳市艾特诺通讯设备有限公司

SHENZHEN ATN COMMUNICATION TECHNOLOGY CO., LTD.

承 认 书

SPECIFICATION FOR APPROVAL

客户编号: GT1 (6973)
CUSTOMER P/N: _____

本厂编号: ATN1372
OUR MODEL NO: _____

规格: 2.4G Bluetooth Antenna
SPECIFICATIONS: _____

样品数: 1 PCS
Q' TY: _____

日期: 2022.12.30
DATE: _____

深圳市艾特诺通讯设备有限公司 A T N			客户 CUSTOMER		
结构 Structure	射频 RF	核准 Approver	结构 Structure	电子 Electronics	核准 Approver

地址：深圳市宝安区新安街道留仙二路美生创谷科技园夏谷 504-505 室

Address: 504-505, XiaGu, Wonderful life creative valley, Xinan, Baoan, ShenZhen.

Tel (电话)：0755-29308863

Fax (传真)：0755-29308861

目录

Contents

封面 Cover	1
目录 contents	2
一、测试设备 Test Equipment&Conditions	3
二、产品规格 Product Specification	4
三、匹配电路 Matching circuit	4
四、测试数据报告 Test Data Report	5
五、装配要求 Assembly requirements	7
六、工程图纸 Product Chart	8
七、样品尺寸检测报告 Size test report	9
八、盐雾测试报告 Salt spray test report	10
九、包装信息 Packaging Information	11

变更记录

发行/变更日期	变更原因	变更内容	版本	备注
2022. 12. 30	新版发行	新版发行	V1.0	

一、测试设备 Test Equipment&Conditions

1.1 网络分析仪 (Network Analyzers)

Agilent Technologies E5071B

1.2 综合测试仪 (Communications Test Set)

CMW500

1.3 3D 暗室测试系统 (3D Chamber Test System)

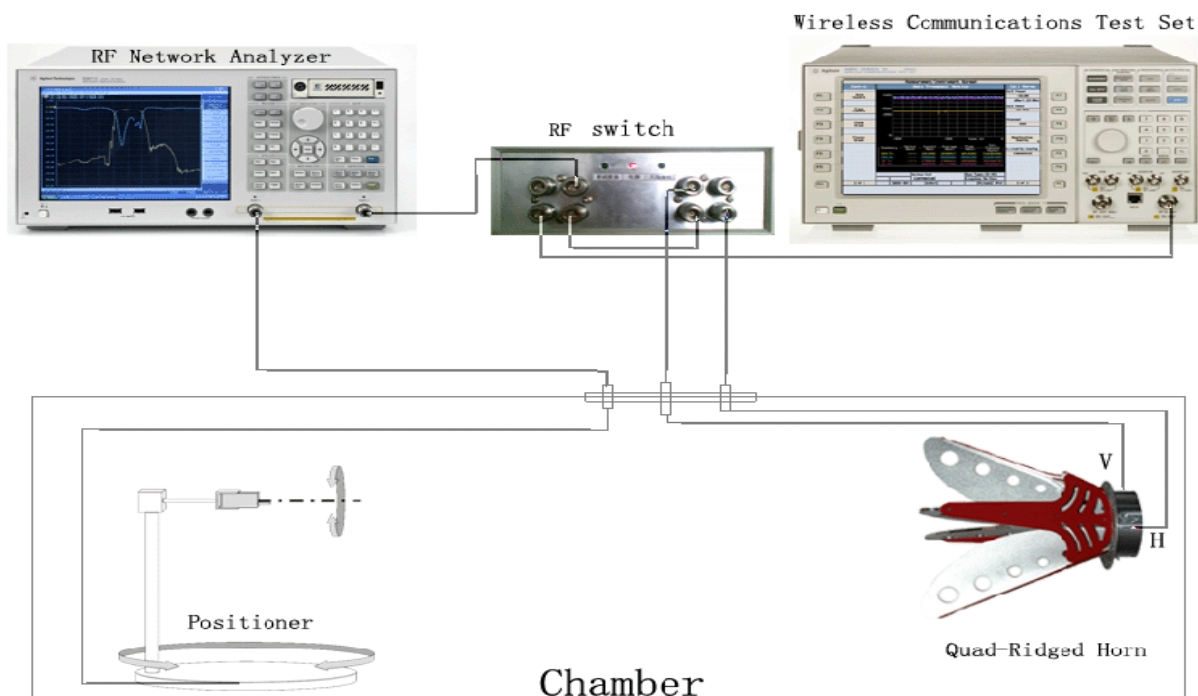

二、产品规格 Product Specification

2.1、Material&Mechanical Characteristics

材质 Material

FPC

Dimension: It is round, 10mm in diameter and 0.15mm in thickness.

尺寸 Dimension

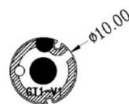

2.2、储存和使用温度 Environmental

使用温度 Operation Temperature $-20^{\circ}\text{C}\sim+80^{\circ}\text{C}$

储存温度 Storage Temperature $-20^{\circ}\text{C}\sim+80^{\circ}\text{C}$

三、匹配电路 Matching circuit

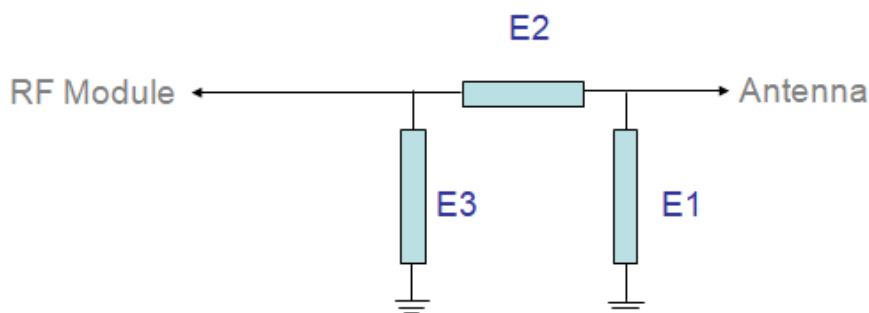

Element	Value
E1(0201)	NC
E2(0201)	1.0nH(LQP03TN1N0B02)
E3(0201)	2.0pF(GRM0335C1H2R0BA01D)
L/R匹配电路相同	

四、测试数据报告 Test Data Report

4.1 S11 Parameter

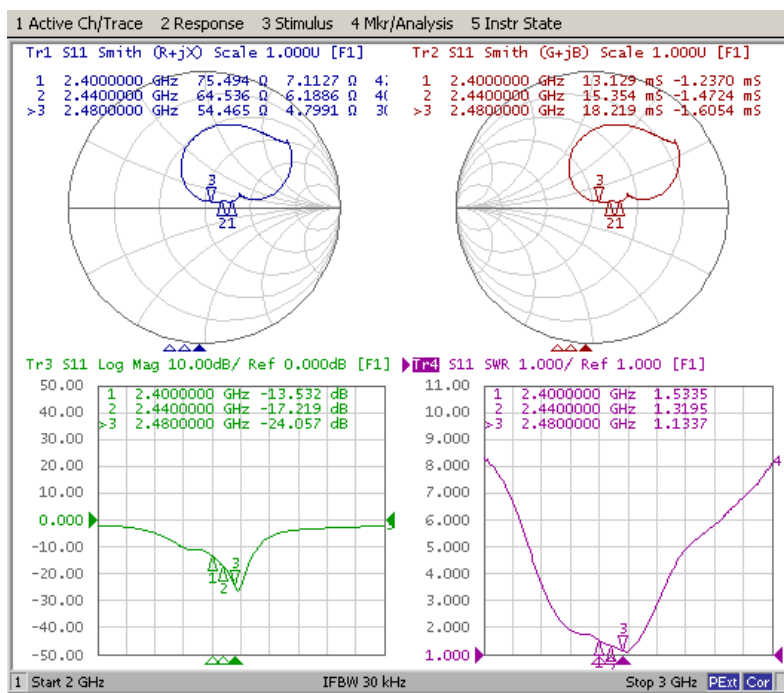

4.2 增益和效率 Gain & Efficiency

Freq (MHz)	Effi (%)	Effi (dB)	Gain (dBi)
2400	26.85	-5.71	-1.01
2410	27.39	-5.62	-0.75
2420	29.33	-5.33	-0.25
2430	31.76	-4.98	-0.45
2440	32.28	-4.91	-0.6
2450	34.4	-4.63	-0.25
2460	35.51	-4.5	-0.03
2470	35.58	-4.49	0.37
2480	35.21	-4.53	0.52

4.3 方向图 Radiation pattern

Horizontal

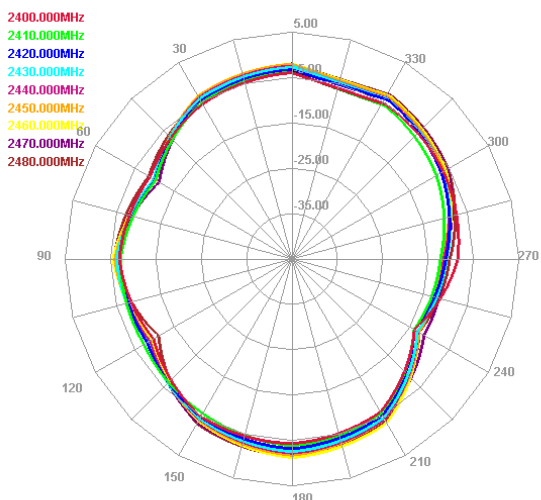

E1 Face

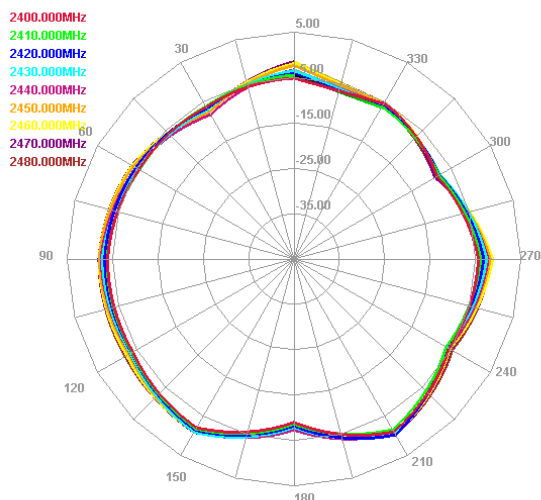

E2 Face

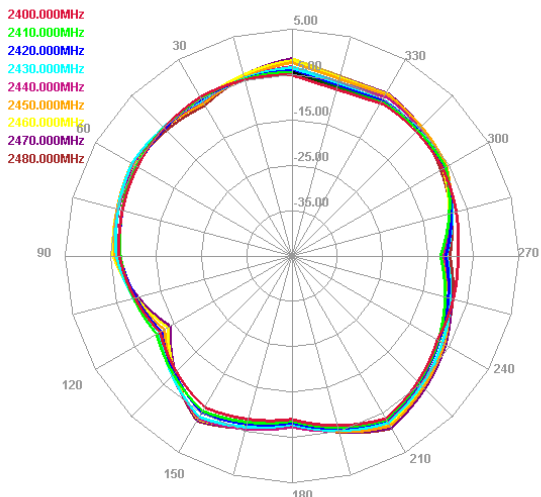

4.3 OTA 测试数据 OTA Test Data

band	channel	TRP (dBm)	TIS (dBm)
Bluetooth BR (L) 自由空间	0	1.4	-82.6
	39	3.1	-85.1
	78	4.7	-87.2

band	channel	TRP (dBm)	TIS (dBm)
Bluetooth BR (R) 自由空间	0	1.9	-83.4
	39	3.6	-85.9
	78	5.7	-88.1

band	channel	TRP (dBm)	TIS (dBm)
Bluetooth BR (L) 人耳	0	1.4	-82.2
	39	1.4	-83.3
	78	1.1	-83.5

band	channel	TRP (dBm)	TIS (dBm)
Bluetooth BR (R) 人耳	0	0.4	-82.1
	39	0.9	-83.5
	78	1.2	-83.6

五、装配要求 Assembly requirements

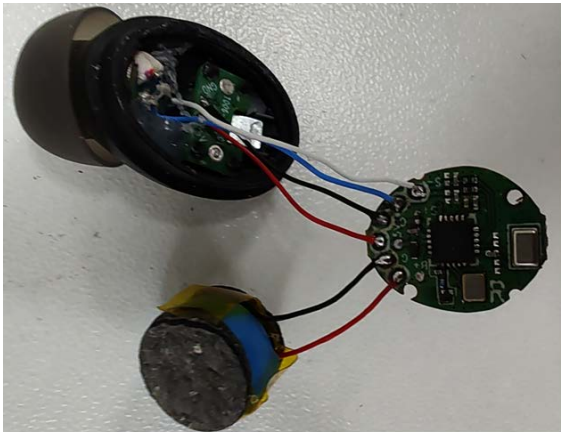
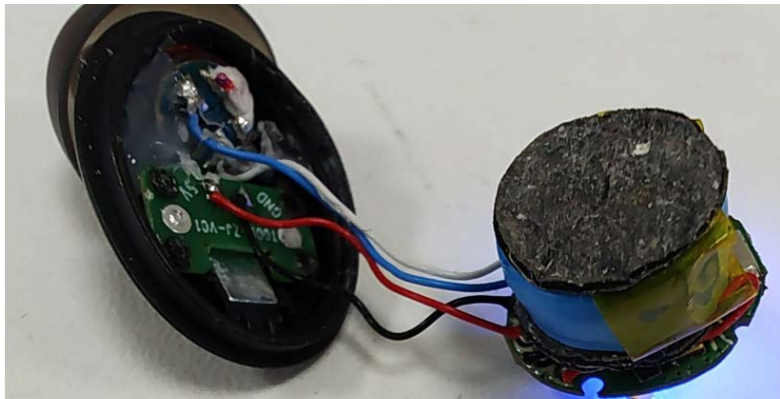
1	 <p>喇叭线长25mm，5v线长20mm，电池线长15mm</p>
2	 <p>电池极耳朝PCB, 电池线贴着PCB摆放</p>

七、样品尺寸检测报告 Size test report

尺寸检验报告 Dimension test report								
项目 project: GT1		品名 Product Name: 天线						
类别 category: FPC		数量 Quantity: 5 个			日期 Date: 2022.12.30			
检验依据标准: Inspection basis and standard		<input checked="" type="checkbox"/> 工程图纸 Engineering drawings <input type="checkbox"/> 标准样板 Standard template <input type="checkbox"/> 其它 Other _____						
检验项目 Inspection items		样品测验值 test value					判定结果 determine	
		1	2	3	4	5		
外观检验 Appearance inspectio	1.油污划痕、压伤等不良	√	√	√	√	√	OK	
	2、其它 Other							
尺寸检验 Dimensional inspection	1	10±0.15	10.02	10.08	10.08	10.04	10.06	ok
	2	/						
	3							
	4							
	5							
	6							
	7							
	8							

八、盐雾测试报告 Salt spray test report

项目 project	GT1	规格 SPECIFICATIONS	2.4G
试验情况 Test information	试验数量 Number of tests: 5 PCS		
	基材 base material: 单面/一对半/电解铜	镀层 Gold plating: 沉黄金≥1U"	
试验条件 Test conditions	盐溶液: 5%	PH:7.0	
	箱内温度 Box temperature: 35°C	相对湿度 relative humidity: 5%	
	喷雾方式: <input checked="" type="checkbox"/> 连续 <input type="checkbox"/> 间歇	压缩空气压力: 1kg/cm ²	
	盐雾沉降率:	雾液收集 Mist collection: PH7.0nac	
	试验周期: __1__个循环	喷雾时间 Spray time: 24 h	
试验结果 test result	试验后的外观: 外观完整无损, 无明显变化。 Appearance after test: the appearance is intact without obvious change		
	镀层: 无剥落、无锈蚀 Coating: no peeling and corrosion		
	表面喷涂、丝印: 无脱落、无气泡。 Surface spraying and silk screen printing: no falling off and bubble		
试验判定 Test judgment	OK		
<p>说明:</p> <p>1、盐雾试验作业标准依照中华人民共和国国家标准 GB/T2423.17-2008 执行</p> <p>1. The operation standard of salt spray test shall be in accordance with the national</p>			

standard of the people's Republic of China GB / t2423 17-2008 implementation

2、试件结果判定标准依照中华人民共和国国家标准 GB/T6461-02 执行

2. The judgment standard of test piece results shall be in accordance with the national standard of the people's Republic of China GB / t6461-02

九、包装信息 Manner of packing

深圳市艾特诺通讯设备有限公司

SHENZHEN ATN COMMUNICATION EQUIPMENT CO.LTD

产品包装 Product packaging

版本 edition: : V1.0	页码 Page: 1/1
1. 离型纸隔层摆放保护天线 Barrier paper protection products	2. 密封袋封装效果 Sealing bag packaging effect
	
3. 纸箱封箱效果 (贴出货标签和 ROHS 标签) Carton sealing effect	
	