

7.6.5. Test Result

Product	Wireless Speaker	Temperature	25°C
Test Engineer	Snake Ni	Relative Humidity	56%
Test Site	TR3	Test Date	2019/06/26

Test Mode	Channel No.	Frequency (MHz)	Hops Over Occupancy Time(Hops)	Packet Transfer Time (ms)	Time of Occupancy (ms)	Limit (ms)	Result
3DH1	39	2441	320	0.396	126.72	≤ 400	Pass
3DH3	39	2441	160	1.643	262.88	≤ 400	Pass
3DH5	39	2441	107	2.898	310.09	≤ 400	Pass

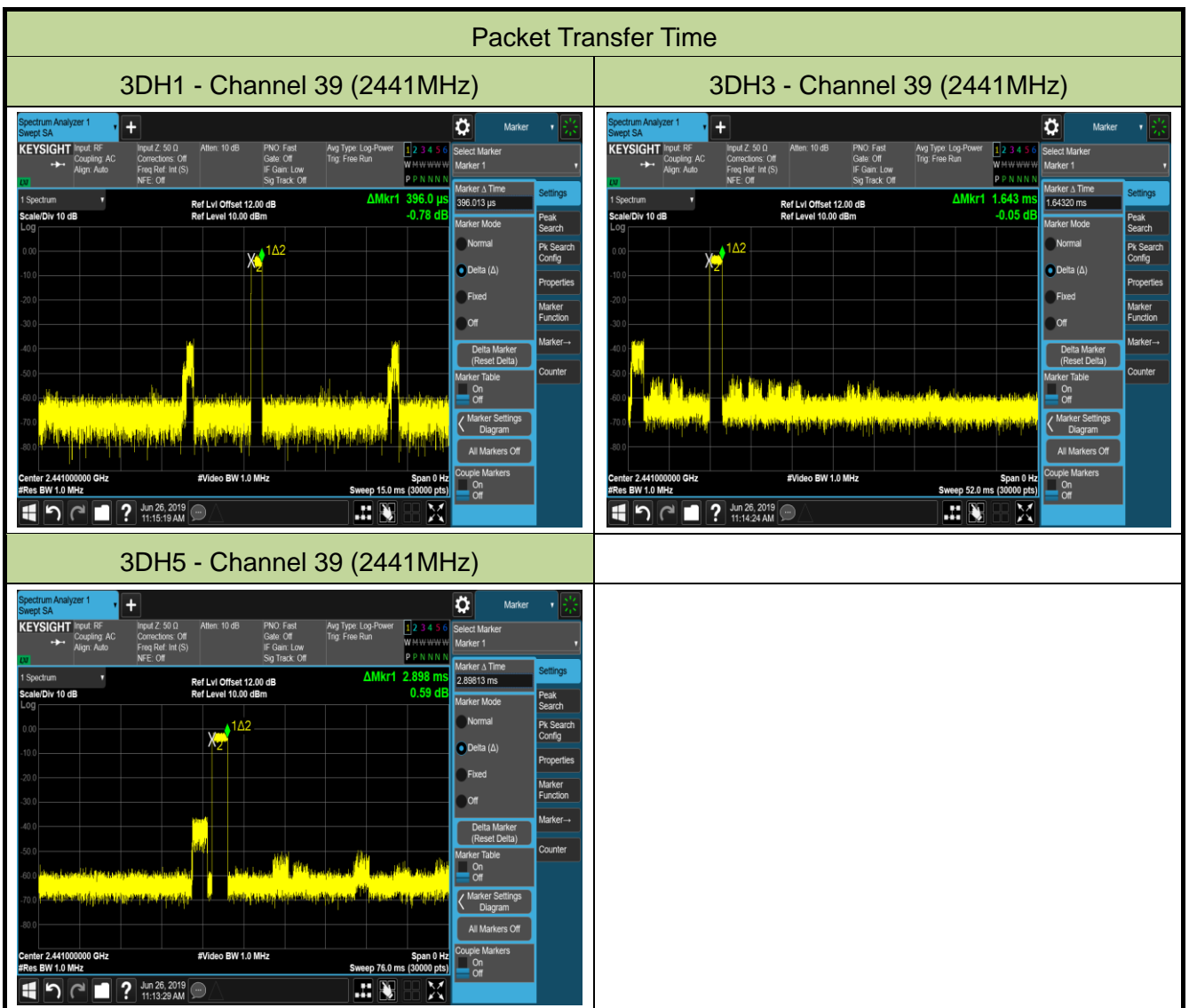

Note 1: According the Bluetooth Standard Specification, the nominal hop rate is 1600 hops/s. All Bluetooth unit participating in the piconet are time and hop synchronized to the channel.

Hops Over Occupancy Time in 31.6s for 3DH1 = $1600 / 2 / 79 * 31.6 = 320$.

Hops Over Occupancy Time in 31.6s for 3DH3 = $1600 / 4 / 79 * 31.6 = 160$.

Hops Over Occupancy Time in 31.6s for 3DH5 = $1600 / 6 / 79 * 31.6 = 107$.

Note 2: Time of Occupancy = Packet Transfer Time * Hops Over Occupancy Time in 31.6s.

7.7. Band-edge Compliance Measurement

7.7.1. Test Limit

The maximum permissible emission level is 20dBc. Any emissions were lying outside of the emission bandwidth and in authorized band edges to a field strength limit specified in Section 15.209 of the Title 47 CFR.

7.7.2. Test Procedure Used

ANSI C63.10-2013 - Section 6.10.4

7.7.3. Test Setting

1. Span = wide enough to capture the peak level of the emission operating on the channel closest to the band edge, as well as any modulation products which fall outside of the authorized band of operation.
2. RBW = 100kHz
3. VBW = 300kHz
4. Detector = peak
5. Sweep time = auto couple
6. Trace mode = max hold
7. Trace was allowed to stabilize
8. Allow the trace to stabilize. Set the marker on the emission at the band edge, or on the highest modulation product outside of the band, if this level is greater than that at the band edge. Enable the marker-delta function, then use the marker-to-peak function to move the marker to the peak of the in-band emission.

7.7.4. Test Setup

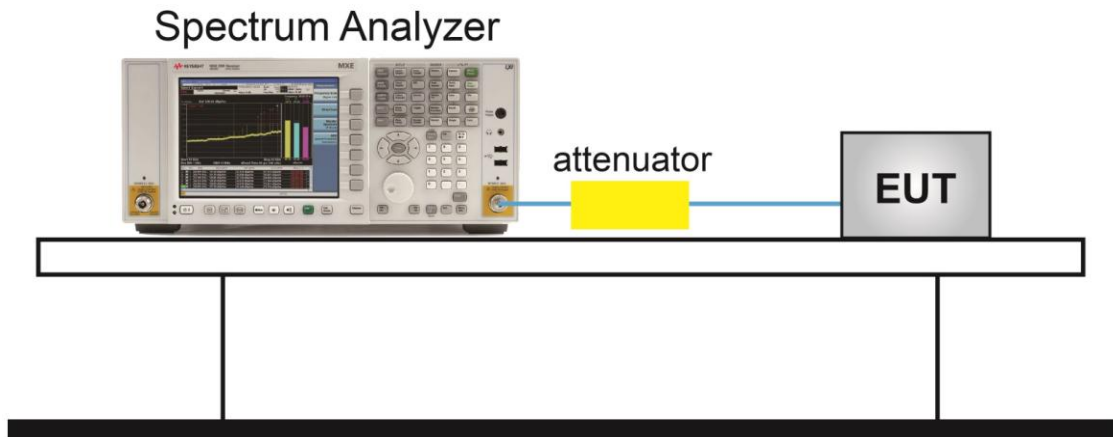

7.7.5. Test Result

Product	Wireless Speaker	Temperature	25°C
Test Engineer	Snake Ni	Relative Humidity	56%
Test Site	TR3	Test Date	2019/06/26

Test Mode	Channel No.	Frequency (MHz)	Limit	Result
DH5	00	2402	20dBc	Pass
DH5	78	2480	20dBc	Pass
2DH5	00	2402	20dBc	Pass
2DH5	78	2480	20dBc	Pass
3DH5	00	2402	20dBc	Pass
3DH5	78	2480	20dBc	Pass

Band-edge Compliance

DH5 - Channel 00 (2402MHz)



DH5 - Channel 78 (2480MHz)

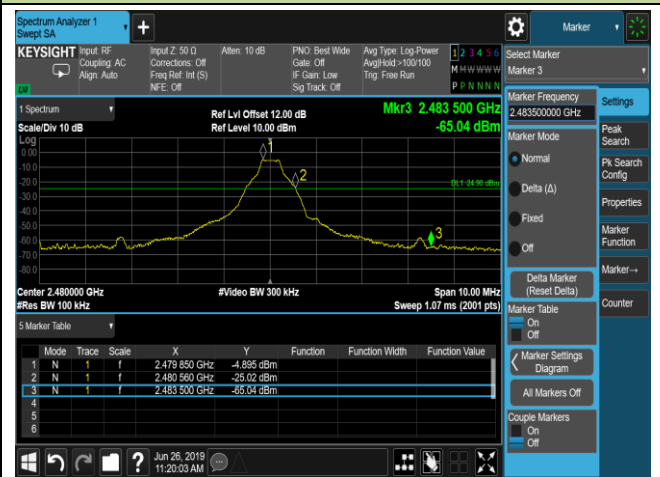

2DH5 - Channel 00 (2402MHz)

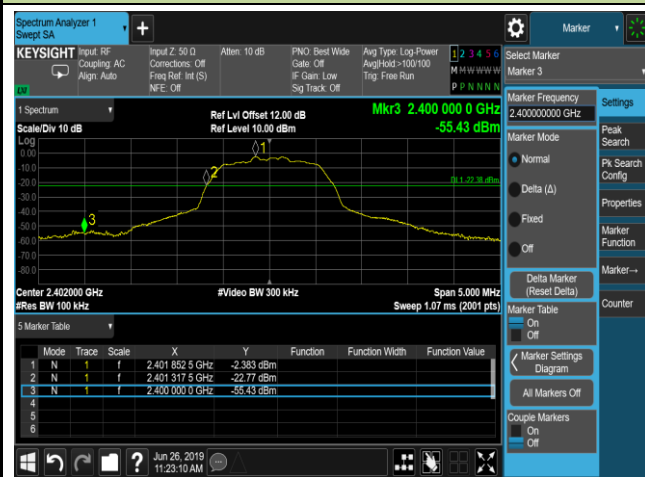

2DH5 - Channel 78 (2480MHz)

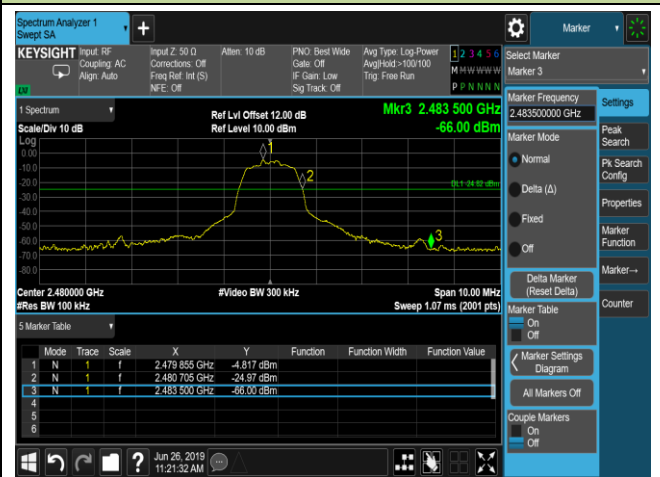

3DH5 - Channel 00 (2402MHz)

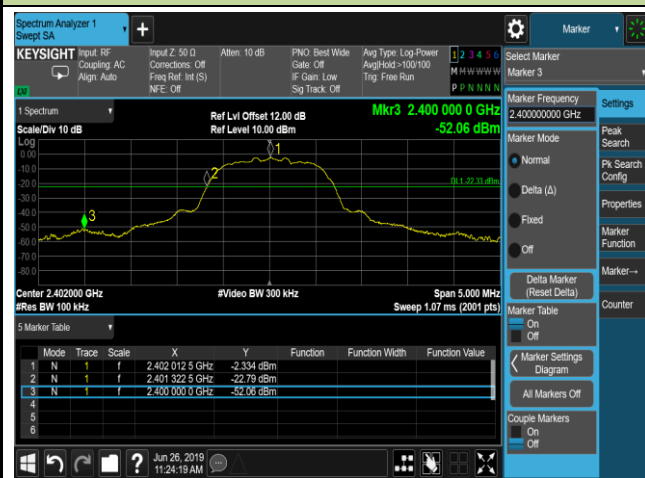

3DH5 - Channel 78 (2480MHz)

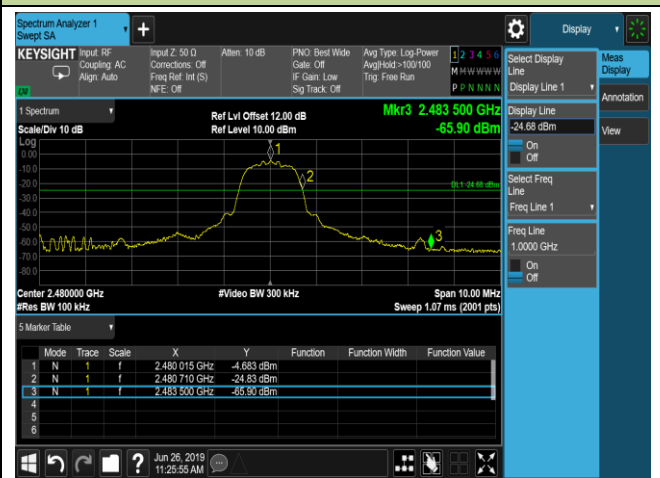

Operation Frequency Range of 20dB Bandwidth within Hopping Mode

DH5 - Channel 00 (2402MHz)

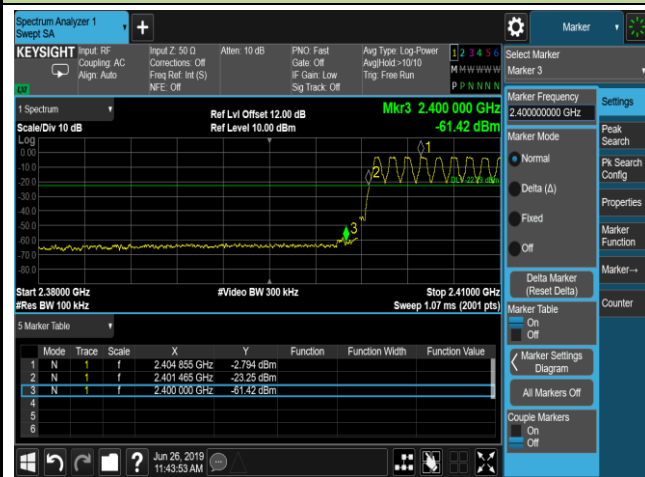

DH5 - Channel 78 (2480MHz)

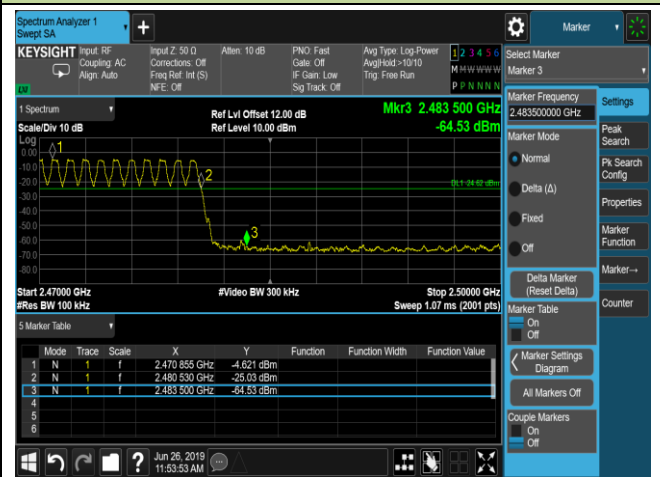

2DH5 - Channel 00 (2402MHz)

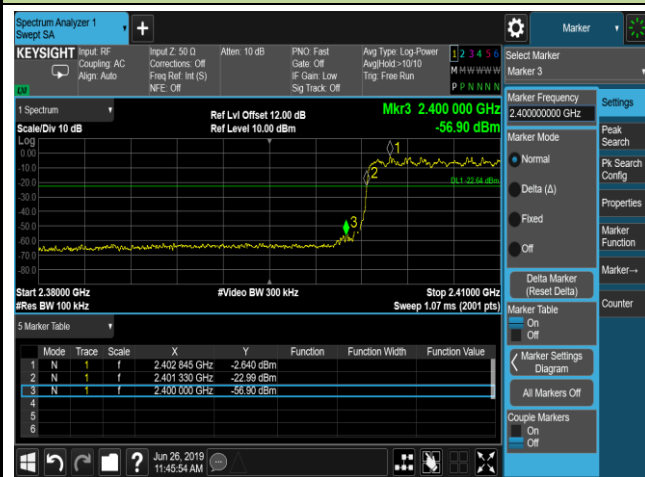

2DH5 - Channel 78 (2480MHz)



3DH5 - Channel 00 (2402MHz)

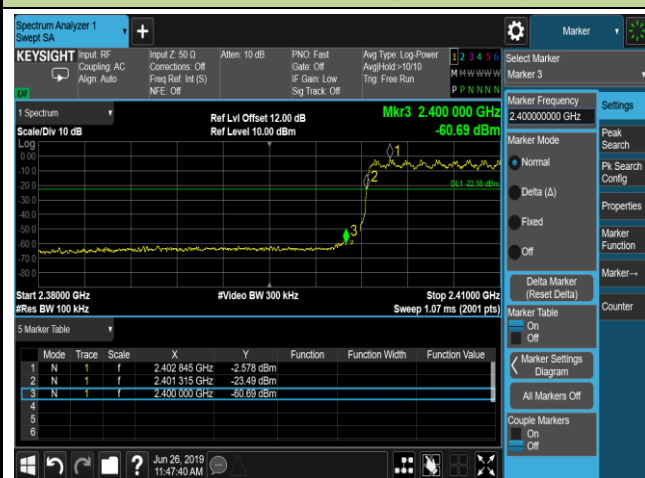

3DH5 - Channel 78 (2480MHz)

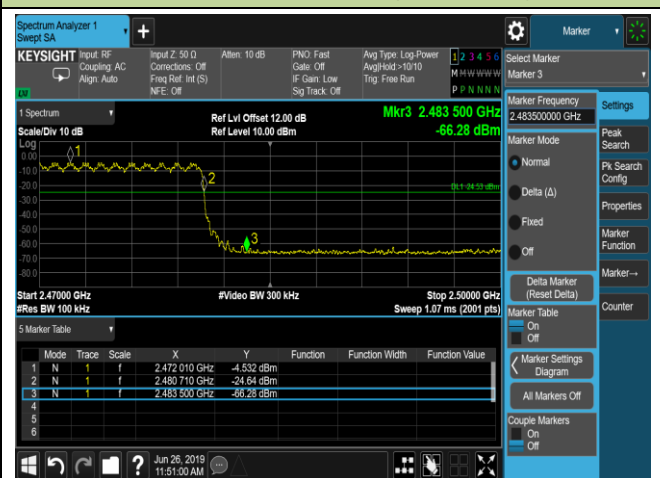

7.8. Conducted Spurious Emissions Measurement

7.8.1. Test Limit

In any 100 kHz bandwidth outside the frequency band in which the spread spectrum or digitally modulated intentional radiator is operating, the radio frequency power that is produced by the intentional radiator shall be at least 20 dB below that in the 100 kHz bandwidth within the band that contains the highest level of the desired power, based on either an RF conducted or a radiated measurement, provided the transmitter demonstrates compliance with the peak conducted or a radiated measurement, provided the transmitter demonstrates compliance with the peak conducted power limits.

7.8.2. Test Procedure Used

ANSI C63.10-2013 - Section 7.8.8

7.8.3. Test Setting

1. Span = wide enough to capture the peak level of the in-band emission and all spurious emissions (e.g., harmonics) from the lowest frequency generated in the EUT up through the 10th harmonic. Typically, several plots are required to cover this entire span.
2. RBW = 100 KHz
3. VBW \geq RBW
4. Detector = peak
5. Sweep time = auto couple
6. Trace mode = max hold
7. Trace was allowed to stabilize
8. Set the marker on the peak of any spurious emission recorded. The level displayed must comply with the limit specified in this section.

7.8.4. Test Setup

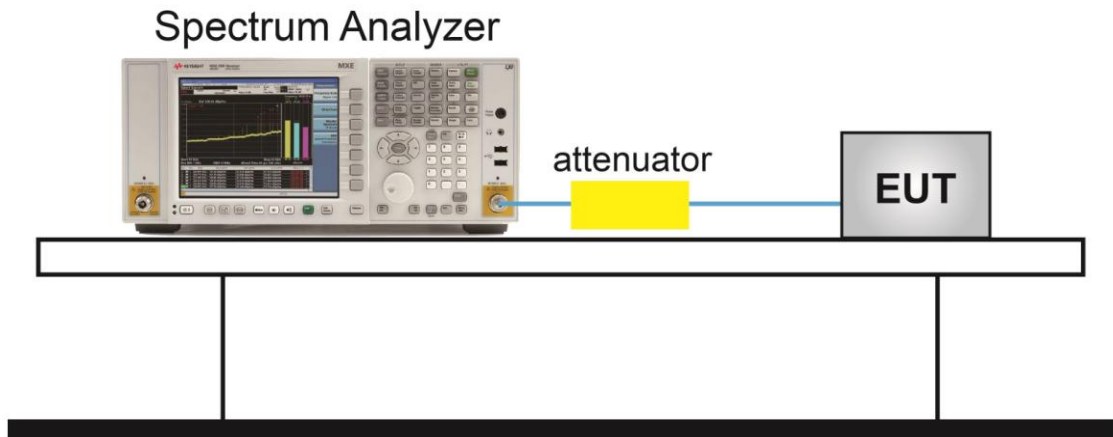

7.8.5. Test Result

Product	Wireless Speaker	Temperature	25°C
Test Engineer	Snake Ni	Relative Humidity	56%
Test Site	TR3	Test Date	2019/06/26

Test Mode	Channel No.	Frequency (MHz)	Limit (MHz)	Result
DH5	00	2402	20dBc	Pass
DH5	39	2441	20dBc	Pass
DH5	78	2480	20dBc	Pass
2DH5	00	2402	20dBc	Pass
2DH5	39	2441	20dBc	Pass
2DH5	78	2480	20dBc	Pass
3DH5	00	2402	20dBc	Pass
3DH5	39	2441	20dBc	Pass
3DH5	78	2480	20dBc	Pass

DH5 Conducted Spurious Emissions

Channel 00 (2402MHz)



Channel 39 (2441MHz)



Channel 78 (2480MHz)



2DH5 Conducted Spurious Emissions

Channel 00 (2402MHz)



Channel 39 (2441MHz)



Channel 78 (2480MHz)



3DH5 Conducted Spurious Emissions

Channel 00 (2402MHz)



Channel 39 (2441MHz)



Channel 78 (2480MHz)

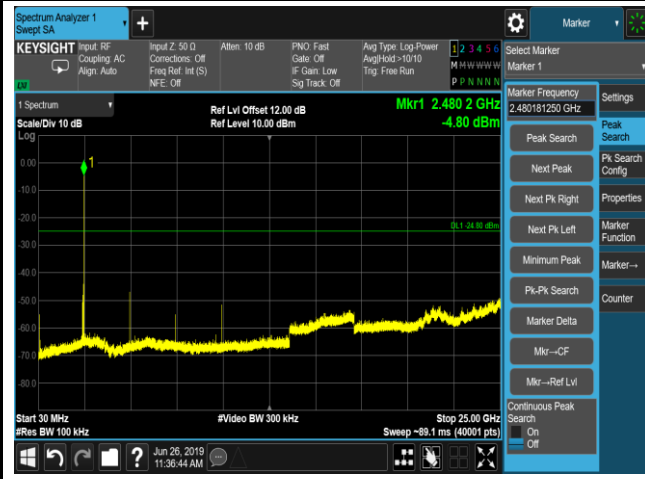

7.9. Radiated Spurious Emission Measurement

7.9.1. Test Limit

All out of band emissions appearing in a restricted band as specified in Section 15.205 of the Title 47 CFR must not exceed the limits shown in Table per Section 15.209.

FCC Part 15 Subpart C Paragraph 15.209		
Frequency [MHz]	Field Strength [$\mu\text{V}/\text{m}$]	Measured Distance [Meters]
0.009 - 0.490	2400/F (kHz)	300
0.490 - 1.705	24000/F (kHz)	30
1.705 - 30	30	30
30 - 88	100	3
88 - 216	150	3
216 - 960	200	3
Above 960	500	3

7.9.2. Test Procedure Used

ANSI C63.10 Section 6.3 (General Requirements)

ANSI C63.10 Section 6.4 (Standard test method below 30MHz)

ANSI C63.10 Section 6.5 (Standard test method above 30MHz to 1GHz)

ANSI C63.10 Section 6.6 (Standard test method above 1GHz)

7.9.3. Test Setting

Table 1 - RBW as a function of frequency

Frequency	RBW
9 ~ 150 kHz	200 ~ 300 Hz
0.15 ~ 30 MHz	9 ~ 10 kHz
30 ~ 1000 MHz	100 ~ 120 kHz
> 1000 MHz	1 MHz

Quasi-Peak Measurements below 1GHz

1. Analyzer center frequency was set to the frequency of the radiated spurious emission of interest
2. Span was set greater than 1MHz
3. RBW = as specified in Table 1
4. Detector = CISPR quasi-peak
5. Sweep time = auto couple
6. Trace was allowed to stabilize

Peak Measurements above 1GHz

1. Analyzer center frequency was set to the frequency of the radiated spurious emission of interest
2. RBW = 1MHz
3. VBW = 3MHz
4. Detector = peak
5. Sweep time = auto couple
6. Trace mode = max hold
7. Trace was allowed to stabilize

Average Measurements above 1GHz (Method VB)

1. Analyzer center frequency was set to the frequency of the radiated spurious emission of interest
2. RBW = 1MHz
3. VBW; If the EUT is configured to transmit with duty cycle $\geq 98\%$, set VBW = 10 Hz.

If the EUT duty cycle is $< 98\%$, set VBW $\geq 1/T$. T is the minimum transmission duration.
4. Detector = Peak
5. Sweep time = auto
6. Trace mode = max hold
7. Trace was allowed to stabilize

7.9.4. Test Setup

Below 1GHz Test Setup:

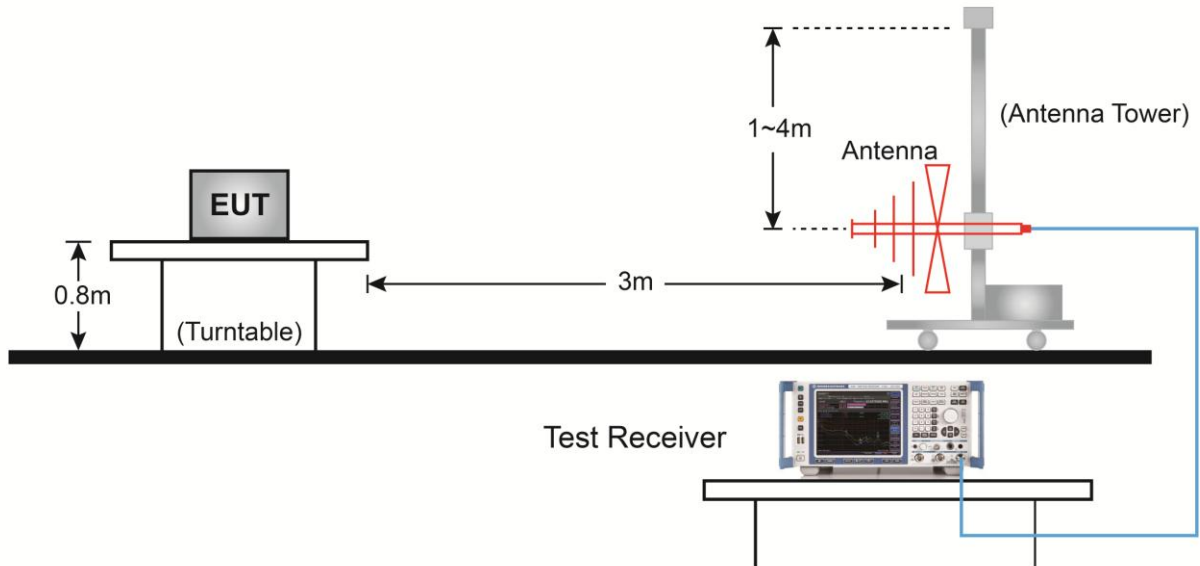

Above 1GHz Test Setup:

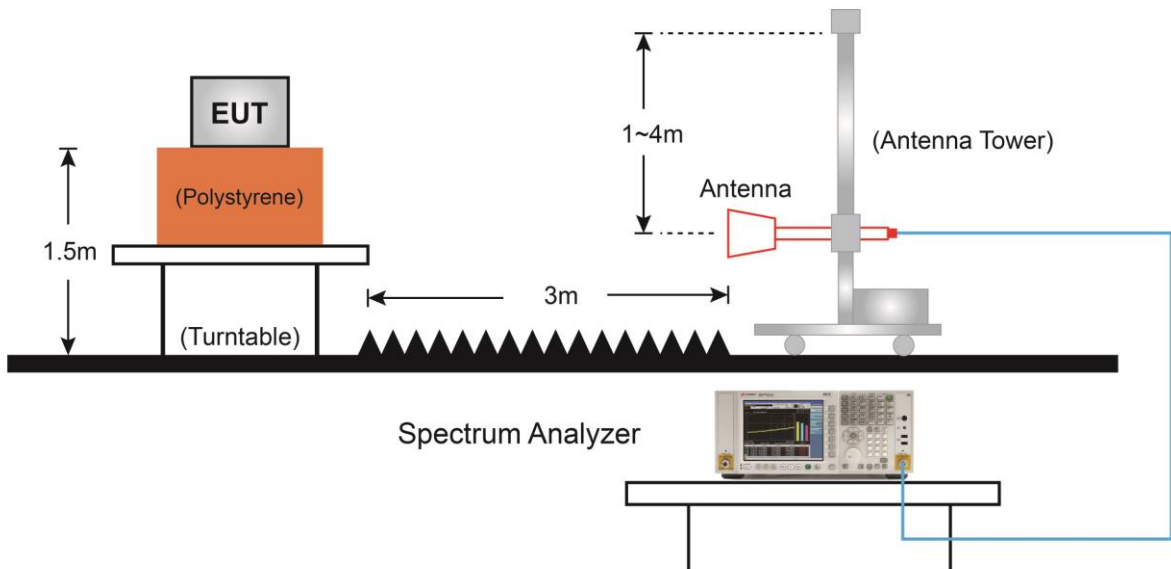

7.9.5. Test Result

Product	Wireless Speaker	Temperature	25°C
Test Engineer	Messiah Li	Relative Humidity	56%
Test Site	AC2	Test Date	2019/06/25
Test Mode:	DH5	Test Channel:	00
Remark:	1. Average measurement was not performed if peak level lower than average limit. 2. Other frequency was 20dB below limit line within 1-18GHz, there is not show in the report.		

Mark	Frequency (MHz)	Reading Level (dBμV)	Factor (dB)	Measure Level (dBμV/m)	Limit (dBμV/m)	Margin (dB)	Detector	Polarization
	4238.5	37.3	1.3	38.6	74.0	-35.4	Peak	Horizontal
	4808.0	40.1	3.5	43.6	74.0	-30.3	Peak	Horizontal
*	7094.5	35.0	11.1	46.1	74.0	-22.1	Peak	Horizontal
*	10239.5	33.5	15.4	48.9	74.0	-19.3	Peak	Horizontal
	4213.0	37.6	1.2	38.8	74.0	-35.1	Peak	Vertical
	4808.0	40.7	3.5	44.2	74.0	-29.8	Peak	Vertical
*	6907.5	35.4	9.8	45.2	74.0	-23.0	Peak	Vertical
*	9610.5	36.1	13.5	49.6	74.0	-18.6	Peak	Vertical

Note 1: "*" is not in restricted band, its limit is 20dBc of the fundamental emission level (89.9dBμV/m) or 15.209 which is higher.

Note 2: Measure Level (dBμV/m) = Reading Level (dBμV) + Factor (dB)

Factor (dB) = Cable Loss (dB) + Antenna Factor (dB/m) - Pre_Amplifier Gain (dB)

Product	Wireless Speaker	Temperature	25°C
Test Engineer	Messiah Li	Relative Humidity	56%
Test Site	AC2	Test Date	2019/06/25
Test Mode:	DH5	Test Channel:	39
Remark:	<ol style="list-style-type: none"> 1. Average measurement was not performed if peak level lower than average limit. 2. Other frequency was 20dB below limit line within 1-18GHz, there is not show in the report. 		

Mark	Frequency (MHz)	Reading Level (dBμV)	Factor (dB)	Measure Level (dBμV/m)	Limit (dBμV/m)	Margin (dB)	Detector	Polarization
	4196.0	37.2	1.3	38.5	74.0	-35.5	Peak	Horizontal
	4884.5	40.7	3.5	44.2	74.0	-29.8	Peak	Horizontal
*	7060.5	35.2	10.7	45.9	74.0	-22.3	Peak	Horizontal
*	9763.5	34.5	14.0	48.5	74.0	-19.6	Peak	Horizontal
	4884.5	42.6	3.5	46.1	74.0	-27.9	Peak	Vertical
	7324.0	35.6	12.0	47.6	74.0	-26.4	Peak	Vertical
*	9763.5	35.6	14.0	49.6	74.0	-18.6	Peak	Vertical
*	10282.0	34.0	15.6	49.6	74.0	-18.6	Peak	Vertical

Note 1: "*" is not in restricted band, its limit is 20dBc of the fundamental emission level (90.3dBμV/m) or 15.209 which is higher.

Note 2: Measure Level (dBμV/m) = Reading Level (dBμV) + Factor (dB)

Factor (dB) = Cable Loss (dB) + Antenna Factor (dB/m) - Pre_Amplifier Gain (dB)

Product	Wireless Speaker	Temperature	25°C
Test Engineer	Messiah Li	Relative Humidity	56%
Test Site	AC2	Test Date	2019/06/25
Test Mode:	DH5	Test Channel:	78
Remark:	1. Average measurement was not performed if peak level lower than average limit. 2. Other frequency was 20dB below limit line within 1-18GHz, there is not show in the report.		

Mark	Frequency (MHz)	Reading Level (dBμV)	Factor (dB)	Measure Level (dBμV/m)	Limit (dBμV/m)	Margin (dB)	Detector	Polarization
	4170.5	37.4	1.1	38.5	74.0	-35.5	Peak	Horizontal
	4961.0	39.8	3.5	43.3	74.0	-30.8	Peak	Horizontal
*	6958.5	35.2	10.1	45.3	74.0	-22.9	Peak	Horizontal
*	10316.0	34.2	15.6	49.8	74.0	-18.4	Peak	Horizontal
	4247.0	37.8	1.4	39.2	74.0	-34.8	Peak	Vertical
	4961.0	40.7	3.5	44.2	74.0	-29.8	Peak	Vertical
*	6227.5	36.7	6.8	43.5	74.0	-24.7	Peak	Vertical
*	10197.0	34.4	15.2	49.6	74.0	-18.6	Peak	Vertical

Note 1: "*" is not in restricted band, its limit is 20dBc of the fundamental emission level (90.7dBμV/m) or 15.209 which is higher.

Note 2: Measure Level (dBμV/m) = Reading Level (dBμV) + Factor (dB)

Factor (dB) = Cable Loss (dB) + Antenna Factor (dB/m) - Pre_Amplifier Gain (dB)

Product	Wireless Speaker	Temperature	25°C
Test Engineer	Messiah Li	Relative Humidity	56%
Test Site	AC2	Test Date	2019/06/25
Test Mode:	2DH5	Test Channel:	00
Remark:	1. Average measurement was not performed if peak level lower than average limit. 2. Other frequency was 20dB below limit line within 1-18GHz, there is not show in the report.		

Mark	Frequency (MHz)	Reading Level (dBμV)	Factor (dB)	Measure Level (dBμV/m)	Limit (dBμV/m)	Margin (dB)	Detector	Polarization
	4170.5	37.2	1.1	38.3	74.0	-35.7	Peak	Horizontal
	4808.0	41.1	3.5	44.6	74.0	-29.4	Peak	Horizontal
*	7026.5	35.5	10.6	46.1	74.0	-22.1	Peak	Horizontal
*	9610.5	34.9	13.5	48.4	74.0	-19.8	Peak	Horizontal
	4247.0	39.0	1.4	40.4	74.0	-33.6	Peak	Vertical
	4808.0	42.1	3.5	45.6	74.0	-28.3	Peak	Vertical
*	7205.0	34.8	11.7	46.5	74.0	-21.8	Peak	Vertical
*	9610.5	36.2	13.5	49.7	74.0	-18.5	Peak	Vertical

Note 1: "*" is not in restricted band, its limit is 20dBc of the fundamental emission level (91.8dBμV/m) or 15.209 which is higher.

Note 2: Measure Level (dBμV/m) = Reading Level (dBμV) + Factor (dB)

Factor (dB) = Cable Loss (dB) + Antenna Factor (dB/m) - Pre_Amplifier Gain (dB)

Product	Wireless Speaker	Temperature	25°C
Test Engineer	Messiah Li	Relative Humidity	56%
Test Site	AC2	Test Date	2019/06/25
Test Mode:	2DH5	Test Channel:	39
Remark:	1. Average measurement was not performed if peak level lower than average limit. 2. Other frequency was 20dB below limit line within 1-18GHz, there is not show in the report.		

Mark	Frequency (MHz)	Reading Level (dBμV)	Factor (dB)	Measure Level (dBμV/m)	Limit (dBμV/m)	Margin (dB)	Detector	Polarization
	4238.5	37.9	1.3	39.2	74.0	-34.8	Peak	Horizontal
	4884.5	41.4	3.5	44.9	74.0	-29.0	Peak	Horizontal
*	6550.5	34.8	8.4	43.2	74.0	-25.1	Peak	Horizontal
*	10375.5	34.4	16.1	50.5	74.0	-17.6	Peak	Horizontal
	4884.5	43.1	3.5	46.6	74.0	-27.3	Peak	Vertical
	7324.0	35.3	12.0	47.3	74.0	-26.8	Peak	Vertical
*	9763.5	35.3	14.0	49.3	74.0	-18.9	Peak	Vertical
*	10256.5	34.7	15.5	50.2	74.0	-18.1	Peak	Vertical

Note 1: "*" is not in restricted band, its limit is 20dBc of the fundamental emission level (92.5dBμV/m) or 15.209 which is higher.

Note 2: Measure Level (dBμV/m) = Reading Level (dBμV) + Factor (dB)

Factor (dB) = Cable Loss (dB) + Antenna Factor (dB/m) - Pre_Amplifier Gain (dB)

Product	Wireless Speaker	Temperature	25°C
Test Engineer	Messiah Li	Relative Humidity	56%
Test Site	AC2	Test Date	2019/06/25
Test Mode:	2DH5	Test Channel:	78
Remark:	1. Average measurement was not performed if peak level lower than average limit. 2. Other frequency was 20dB below limit line within 1-18GHz, there is not show in the report.		

Mark	Frequency (MHz)	Reading Level (dBμV)	Factor (dB)	Measure Level (dBμV/m)	Limit (dBμV/m)	Margin (dB)	Detector	Polarization
	4247.0	37.7	1.4	39.1	74.0	-35.0	Peak	Horizontal
	4961.0	38.5	3.5	42.0	74.0	-32.0	Peak	Horizontal
*	6542.0	34.8	8.5	43.3	74.0	-24.9	Peak	Horizontal
*	9993.0	33.1	14.3	47.4	74.0	-20.8	Peak	Horizontal
	4961.0	42.0	3.5	45.5	74.0	-28.5	Peak	Vertical
	7655.5	35.4	11.4	46.8	74.0	-27.2	Peak	Vertical
*	8658.5	31.6	12.3	43.9	74.0	-24.3	Peak	Vertical
*	10375.5	34.4	16.1	50.5	74.0	-17.6	Peak	Vertical

Note 1: "*" is not in restricted band, its limit is 20dBc of the fundamental emission level (93.1dBμV/m) or 15.209 which is higher.

Note 2: Measure Level (dBμV/m) = Reading Level (dBμV) + Factor (dB)

Factor (dB) = Cable Loss (dB) + Antenna Factor (dB/m) - Pre_Amplifier Gain (dB)

Product	Wireless Speaker	Temperature	25°C
Test Engineer	Messiah Li	Relative Humidity	56%
Test Site	AC2	Test Date	2019/06/25
Test Mode:	3DH5	Test Channel:	00
Remark:	1. Average measurement was not performed if peak level lower than average limit. 2. Other frequency was 20dB below limit line within 1-18GHz, there is not show in the report.		

Mark	Frequency (MHz)	Reading Level (dBμV)	Factor (dB)	Measure Level (dBμV/m)	Limit (dBμV/m)	Margin (dB)	Detector	Polarization
	4247.0	38.4	1.4	39.8	74.0	-34.3	Peak	Horizontal
	4808.0	40.6	3.5	44.1	74.0	-29.9	Peak	Horizontal
*	6984.0	34.8	10.4	45.2	74.0	-23.0	Peak	Horizontal
*	10392.5	33.5	16.3	49.8	74.0	-18.4	Peak	Horizontal
	4255.5	37.5	1.4	38.9	74.0	-35.1	Peak	Vertical
	4808.0	42.8	3.5	46.3	74.0	-27.7	Peak	Vertical
*	6533.5	35.5	8.5	44.0	74.0	-24.2	Peak	Vertical
*	9610.5	35.9	13.5	49.4	74.0	-18.8	Peak	Vertical

Note 1: "*" is not in restricted band, its limit is 20dBc of the fundamental emission level (92.3dBμV/m) or 15.209 which is higher.

Note 2: Measure Level (dBμV/m) = Reading Level (dBμV) + Factor (dB)

Factor (dB) = Cable Loss (dB) + Antenna Factor (dB/m) - Pre_Amplifier Gain (dB)

Product	Wireless Speaker	Temperature	25°C
Test Engineer	Messiah Li	Relative Humidity	56%
Test Site	AC2	Test Date	2019/06/25
Test Mode:	3DH5	Test Channel:	39
Remark:	1. Average measurement was not performed if peak level lower than average limit. 2. Other frequency was 20dB below limit line within 1-18GHz, there is not show in the report.		

Mark	Frequency (MHz)	Reading Level (dBμV)	Factor (dB)	Measure Level (dBμV/m)	Limit (dBμV/m)	Margin (dB)	Detector	Polarization
	4204.5	37.5	1.3	38.8	74.0	-35.2	Peak	Horizontal
	4884.5	41.3	3.5	44.8	74.0	-29.1	Peak	Horizontal
*	6584.5	36.0	8.2	44.2	74.0	-24.0	Peak	Horizontal
*	10392.5	34.0	16.3	50.3	74.0	-17.8	Peak	Horizontal
	4179.0	37.4	1.2	38.6	74.0	-35.4	Peak	Vertical
	4884.5	44.1	3.5	47.6	74.0	-26.4	Peak	Vertical
*	6729.0	36.1	8.5	44.6	74.0	-23.6	Peak	Vertical
*	9763.5	36.0	14.0	50.0	74.0	-18.2	Peak	Vertical

Note 1: "*" is not in restricted band, its limit is 20dBc of the fundamental emission level (92.9dBμV/m) or 15.209 which is higher.

Note 2: Measure Level (dBμV/m) = Reading Level (dBμV) + Factor (dB)

Factor (dB) = Cable Loss (dB) + Antenna Factor (dB/m) - Pre_Amplifier Gain (dB)

Product	Wireless Speaker	Temperature	25°C
Test Engineer	Messiah Li	Relative Humidity	56%
Test Site	AC2	Test Date	2019/06/25
Test Mode:	3DH5	Test Channel:	78
Remark:	1. Average measurement was not performed if peak level lower than average limit. 2. Other frequency was 20dB below limit line within 1-18GHz, there is not show in the report.		

Mark	Frequency (MHz)	Reading Level (dBμV)	Factor (dB)	Measure Level (dBμV/m)	Limit (dBμV/m)	Margin (dB)	Detector	Polarization
	4247.0	37.0	1.4	38.4	74.0	-35.7	Peak	Horizontal
	4961.0	39.9	3.5	43.4	74.0	-30.6	Peak	Horizontal
*	7222.0	34.7	11.5	46.2	74.0	-22.0	Peak	Horizontal
*	10392.5	33.8	16.3	50.1	74.0	-18.0	Peak	Horizontal
	4961.0	42.5	3.5	46.0	74.0	-28.0	Peak	Vertical
	7256.0	35.4	11.9	47.3	74.0	-26.8	Peak	Vertical
*	8667.0	34.1	12.3	46.4	74.0	-21.8	Peak	Vertical
*	10392.5	34.3	16.3	50.6	74.0	-17.5	Peak	Vertical

Note 1: "*" is not in restricted band, its limit is 20dBc of the fundamental emission level (93.5dBμV/m) or 15.209 which is higher.

Note 2: Measure Level (dBμV/m) = Reading Level (dBμV) + Factor (dB)

Factor (dB) = Cable Loss (dB) + Antenna Factor (dB/m) - Pre_Amplifier Gain (dB)

The Worst Case of Radiated Emission below 1GHz:

Site: AC2	Time: 2019/06/24 - 16:19
Limit: FCC_Part15.209_RSE(3m)	Engineer: Messiah Li
Probe: VULB9162_0.03-8GHz	Polarity: Horizontal
EUT: Wireless Speaker	Power: By Battery
Worst Case Mode: Transmit by DH5 at Channel 2441MHz	

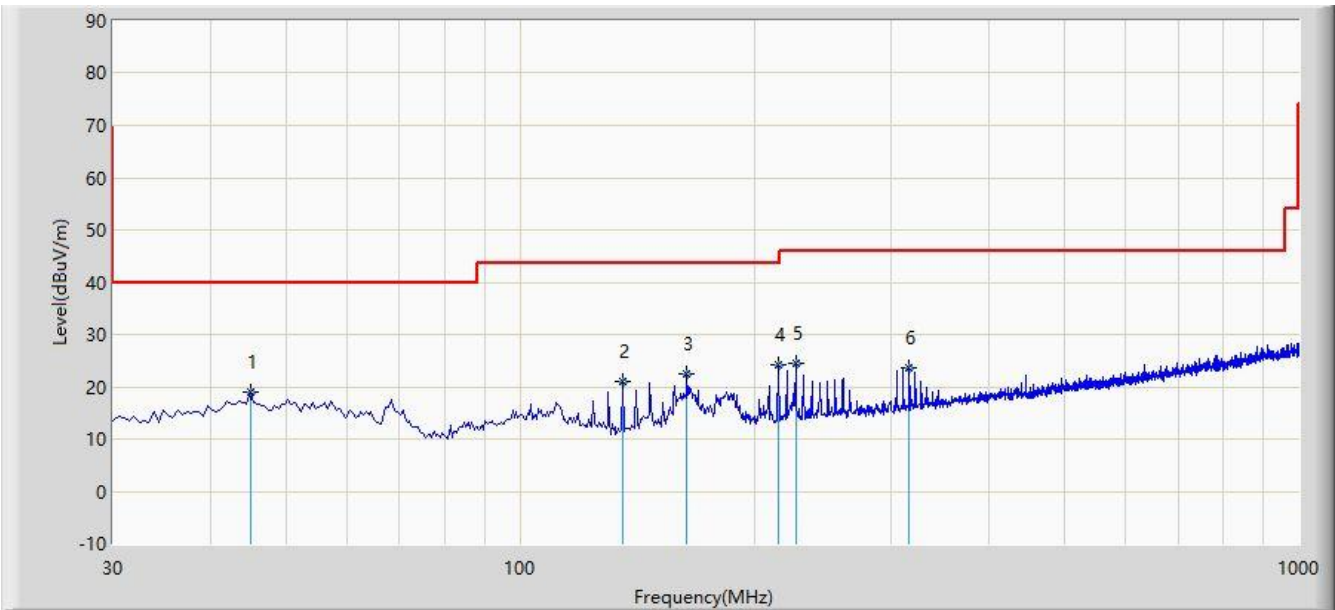

No	Flag	Mark	Frequency (MHz)	Measure Level (dBuV/m)	Reading Level (dBuV)	Margin (dB)	Limit (dBuV/m)	Factor (dB)	Type
1			45.035	18.904	4.171	-21.096	40.000	14.733	QP
2			135.730	20.918	11.388	-22.582	43.500	9.530	QP
3			163.860	22.488	12.669	-21.012	43.500	9.820	QP
4		*	214.300	24.079	11.769	-19.421	43.500	12.310	QP
5			225.940	24.380	11.690	-21.620	46.000	12.690	QP
6			316.150	23.566	8.863	-22.434	46.000	14.704	QP

Note 1: Measure Level (dB μ V/m) = Reading Level (dB μ V) + Factor (dB)

Factor (dB) = Cable Loss (dB) + Antenna Factor (dB/m)

Note 2: The test trace is same as the ambient noise and the amplitude of the emissions are attenuated more than 20dB below the permissible (the test frequency range: 9kHz ~ 30MHz, 18GHz ~ 25GHz), therefore no data appear in the report.

Site: AC2	Time: 2019/06/24 - 16:23
Limit: FCC_Part15.209_RSE(3m)	Engineer: Messiah Li
Probe: VULB9162_0.03-8GHz	Polarity: Vertical
EUT: Wireless Speaker	Power: By Battery
Worst Case Mode: Transmit by DH5 at Channel 2441MHz	

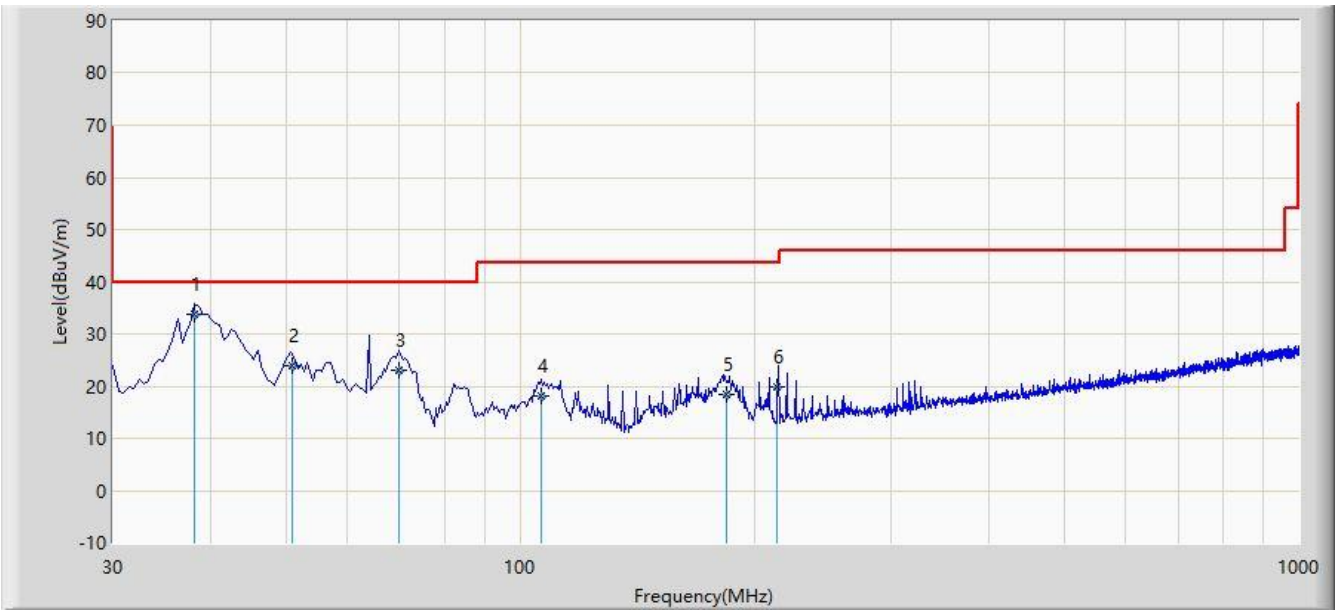

No	Flag	Mark	Frequency (MHz)	Measure Level (dBuV/m)	Reading Level (dBuV)	Margin (dB)	Limit (dBuV/m)	Factor (dB)	Type
1		*	38.245	33.692	20.236	-6.308	40.000	13.455	QP
2			50.894	23.974	9.146	-16.026	40.000	14.829	QP
3			69.756	22.982	12.126	-17.018	40.000	10.857	QP
4			106.698	18.075	5.156	-25.425	43.500	12.920	QP
5			183.789	18.327	7.256	-25.173	43.500	11.072	QP
6			214.125	19.902	7.596	-23.598	43.500	12.306	QP

Note 1: Measure Level (dBuV/m) = Reading Level (dBuV) + Factor (dB)

Factor (dB) = Cable Loss (dB) + Antenna Factor (dB/m)

Note 2: The test trace is same as the ambient noise and the amplitude of the emissions are attenuated more than 20dB below the permissible (the test frequency range: 9kHz ~ 30MHz, 18GHz ~ 25GHz), therefore no data appear in the report.

7.10. Radiated Restricted Band Edge Measurement

For 15.205 requirement:

Radiated emissions which fall in the restricted bands, as defined in Section 15.205(a) of FCC part 15, must also comply with the radiated emission limits specified in Section 15.209(a).

Frequency (MHz)	Frequency (MHz)	Frequency (MHz)	Frequency (GHz)
0.090 - 0.110	16.42 - 16.423	399.9 - 410	4.5 - 5.15
¹ 0.495 - 0.505	16.69475 - 16.69525	608 - 614	5.35 - 5.46
2.1735 - 2.1905	16.80425 - 16.80475	960 - 1240	7.25 - 7.75
4.125 - 4.128	25.5 - 25.67	1300 - 1427	8.025 - 8.5
4.17725 - 4.17775	37.5 - 38.25	1435 - 1626.5	9.0 - 9.2
4.20725 - 4.20775	73 - 74.6	1645.5 - 1646.5	9.3 - 9.5
6.215 - 6.218	74.8 - 75.2	1660 - 1710	10.6 - 12.7
6.26775 - 6.26825	108 - 121.94	1718.8 - 1722.2	13.25 - 13.4
6.31175 - 6.31225	123 - 138	2200 - 2300	14.47 - 14.5
8.291 - 8.294	149.9 - 150.05	2310 - 2390	15.35 - 16.2
8.362 - 8.366	156.52475 - 156.525	2483.5 - 2500	17.7 - 21.4
8.37625 - 8.38675	156.7 - 156.9	2690 - 2900	22.01 - 23.12
8.41425 - 8.41475	162.0125 - 167.17	3260 - 3267	23.6 - 24.0
12.29 - 12.293	167.72 - 173.2	3332 - 3339	31.2 - 31.8
12.51975 - 12.52025	240 - 285	3345.8 - 3358	36.43 - 36.5
12.57675 - 12.57725	322 - 335.4	3600 - 4400	(²)
13.36 - 13.41	--	--	--

All out of band emissions appearing in a restricted band as specified in Section 15.205 of the Title 47CFR must not exceed the limits shown in Table per Section 15.209.

FCC Part 15 Subpart C Paragraph 15.209		
Frequency [MHz]	Field Strength [uV/m]	Measured Distance [Meters]
0.009 - 0.490	2400/F (kHz)	300
0.490 - 1.705	24000/F (kHz)	30
1.705 - 30	30	30
30 - 88	100	3
88 - 216	150	3
216 - 960	200	3
Above 960	500	3

7.10.1. Test Procedure Used

ANSI C63.10 Section 6.3 (General Requirements)

ANSI C63.10 Section 6.6 (Standard test method above 1GHz)

7.10.2. Test Setting

Peak Field Strength Measurements

1. Analyzer center frequency was set to the frequency of the radiated spurious emission of interest
2. RBW = 1MHz
3. VBW = 3MHz
4. Detector = peak
5. Sweep time = auto couple
6. Trace mode = max hold
7. Trace was allowed to stabilize

Average Measurements above 1GHz (Method VB)

1. Analyzer center frequency was set to the frequency of the radiated spurious emission of interest
2. RBW = 1MHz
3. VBW; If the EUT is configured to transmit with duty cycle $\geq 98\%$, set VBW = 10 Hz.

If the EUT duty cycle is $< 98\%$, set VBW $\geq 1/T$. T is the minimum transmission duration.

4. Detector = Peak
5. Sweep time = auto
6. Trace mode = max hold
7. Trace was allowed to stabilize

7.10.3. Test Setup

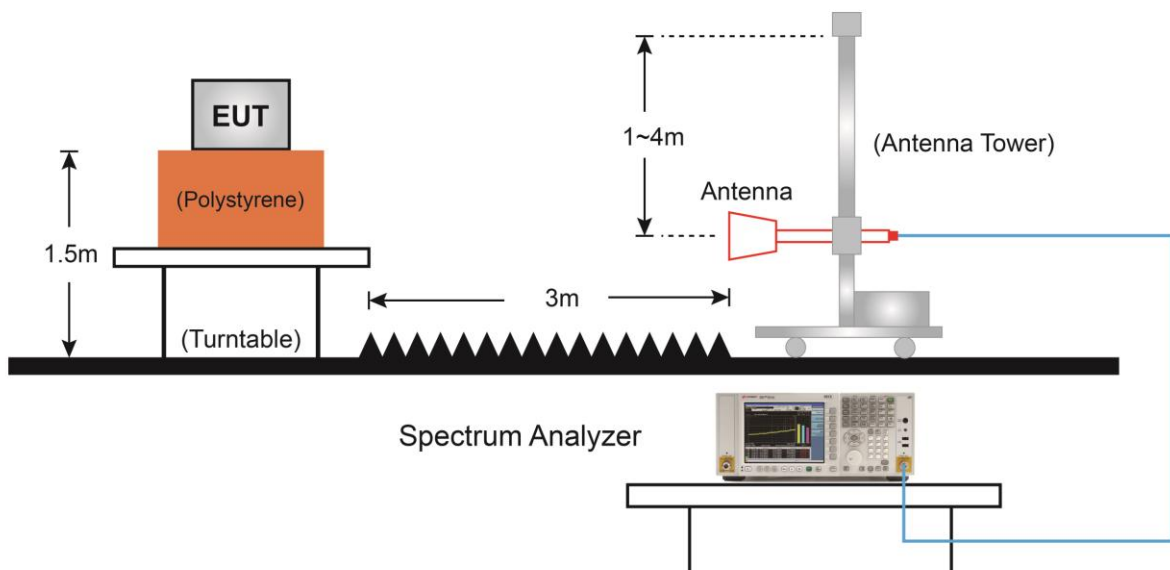

7.10.4. Test Result

Site: AC2	Time: 2019/06/25 - 07:51
Limit: FCC_Part15.209_RSE(3m)	Engineer: David Lv
Probe: BBHA9120D_1-18GHz	Polarity: Horizontal
EUT: Wireless Speaker	Power: By Battery
Test Mode: Transmit by DH5 at channel 2402MHz	

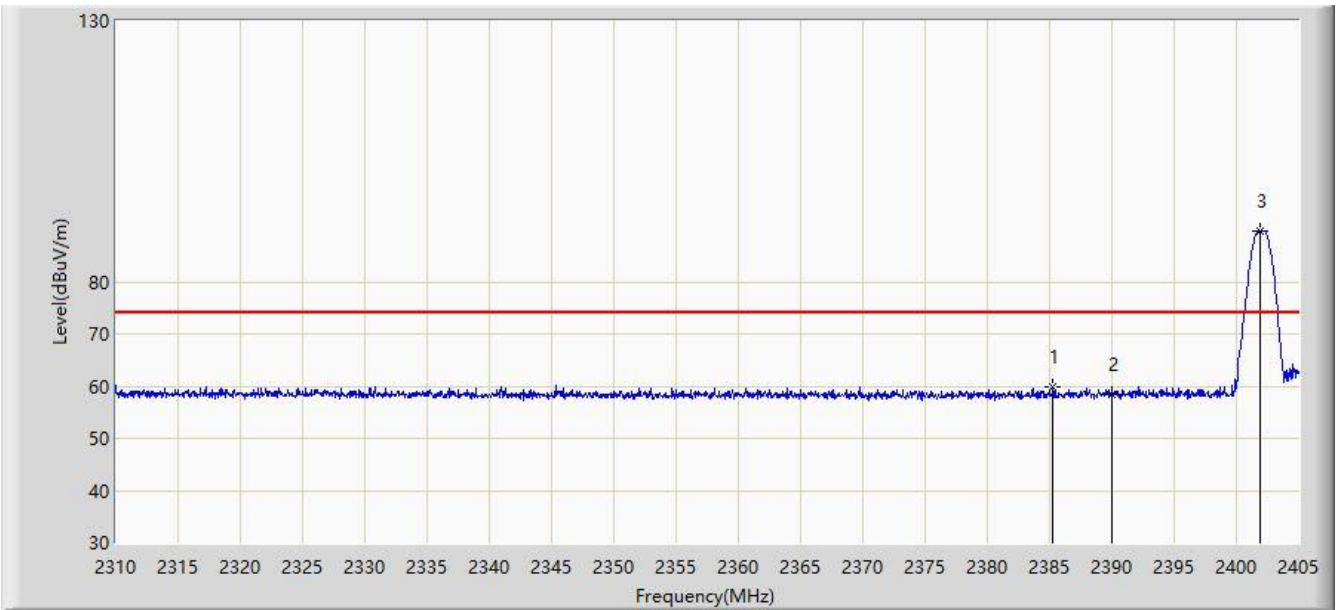

No	Flag	Mark	Frequency (MHz)	Measure Level (dBuV/m)	Reading Level (dBuV)	Margin (dB)	Limit (dBuV/m)	Factor (dB)	Type
1			2385.288	59.755	28.307	-14.245	74.000	31.448	PK
2			2390.000	58.317	26.868	-15.683	74.000	31.449	PK
3		*	2401.865	89.852	58.430	N/A	N/A	31.422	PK

Note: Measure Level (dB μ V/m) = Reading Level (dB μ V) + Factor (dB)

Factor (dB) = Cable Loss (dB) + Antenna Factor (dB/m).

Site: AC2	Time: 2019/06/25 - 07:55
Limit: FCC_Part15.209_RSE(3m)	Engineer: David Lv
Probe: BBHA9120D_1-18GHz	Polarity: Horizontal
EUT: Wireless Speaker	Power: By Battery
Test Mode: Transmit by DH5 at channel 2402MHz	

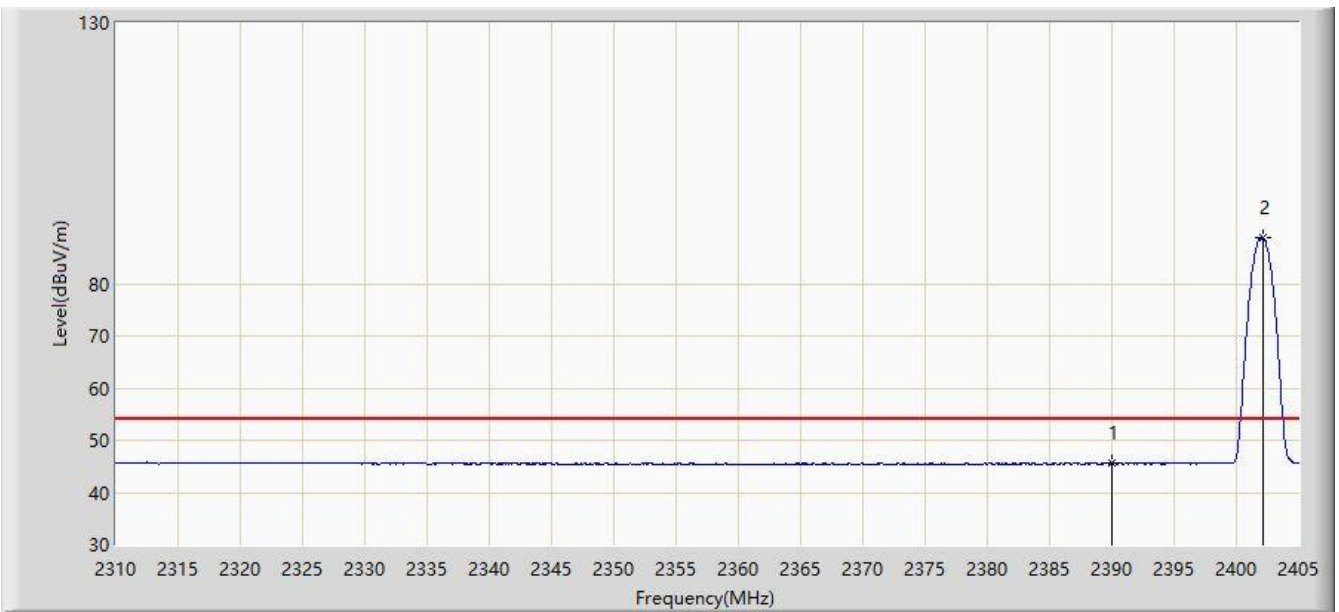

No	Flag	Mark	Frequency (MHz)	Measure Level (dBuV/m)	Reading Level (dBuV)	Margin (dB)	Limit (dBuV/m)	Factor (dB)	Type
1			2390.000	45.540	14.091	-8.460	54.000	31.449	AV
2		*	2402.150	88.868	57.447	N/A	N/A	31.421	AV

Note: Measure Level (dB μ V/m) = Reading Level (dB μ V) + Factor (dB)

Factor (dB) = Cable Loss (dB) + Antenna Factor (dB/m).

Site: AC2	Time: 2019/06/25 - 07:56
Limit: FCC_Part15.209_RSE(3m)	Engineer: David Lv
Probe: BBHA9120D_1-18GHz	Polarity: Vertical
EUT: Wireless Speaker	Power: By Battery
Test Mode: Transmit by DH5 at channel 2402MHz	

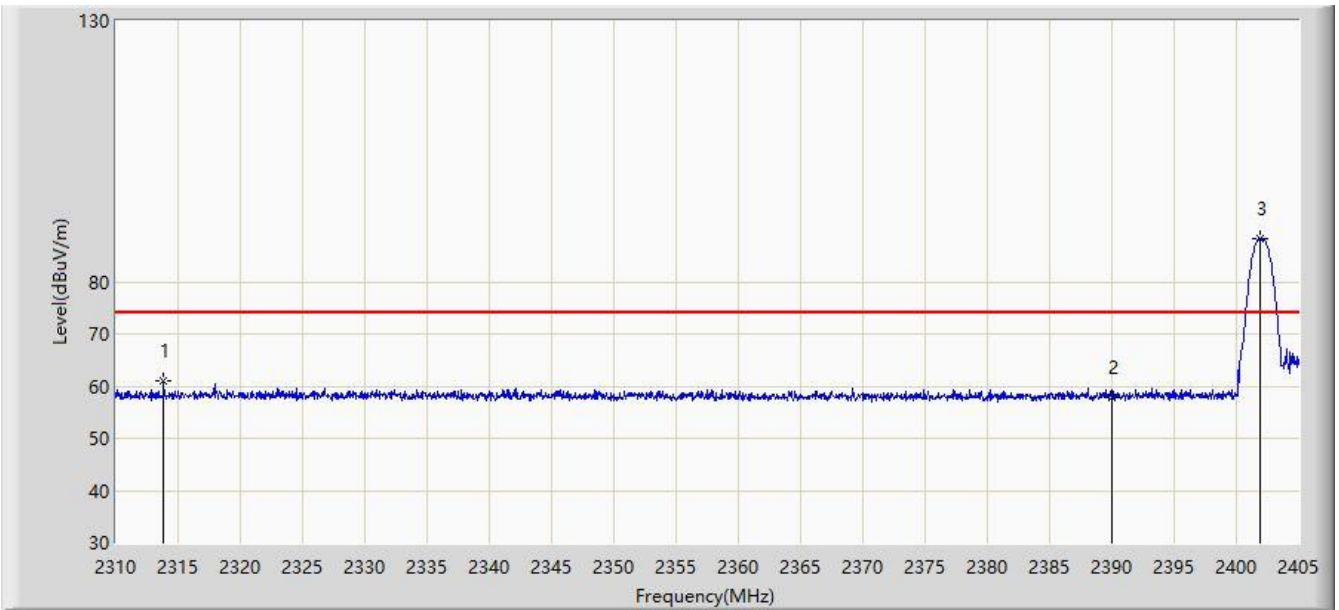

No	Flag	Mark	Frequency (MHz)	Measure Level (dBuV/m)	Reading Level (dBuV)	Margin (dB)	Limit (dBuV/m)	Factor (dB)	Type
1			2313.847	60.973	29.321	-13.027	74.000	31.652	PK
2			2390.000	57.863	26.414	-16.137	74.000	31.449	PK
3		*	2401.865	88.160	56.738	N/A	N/A	31.422	PK

Note: Measure Level (dB μ V/m) = Reading Level (dB μ V) + Factor (dB)

Factor (dB) = Cable Loss (dB) + Antenna Factor (dB/m).

Site: AC2	Time: 2019/06/25 - 07:58
Limit: FCC_Part15.209_RSE(3m)	Engineer: David Lv
Probe: BBHA9120D_1-18GHz	Polarity: Vertical
EUT: Wireless Speaker	Power: By Battery
Test Mode: Transmit by DH5 at channel 2402MHz	

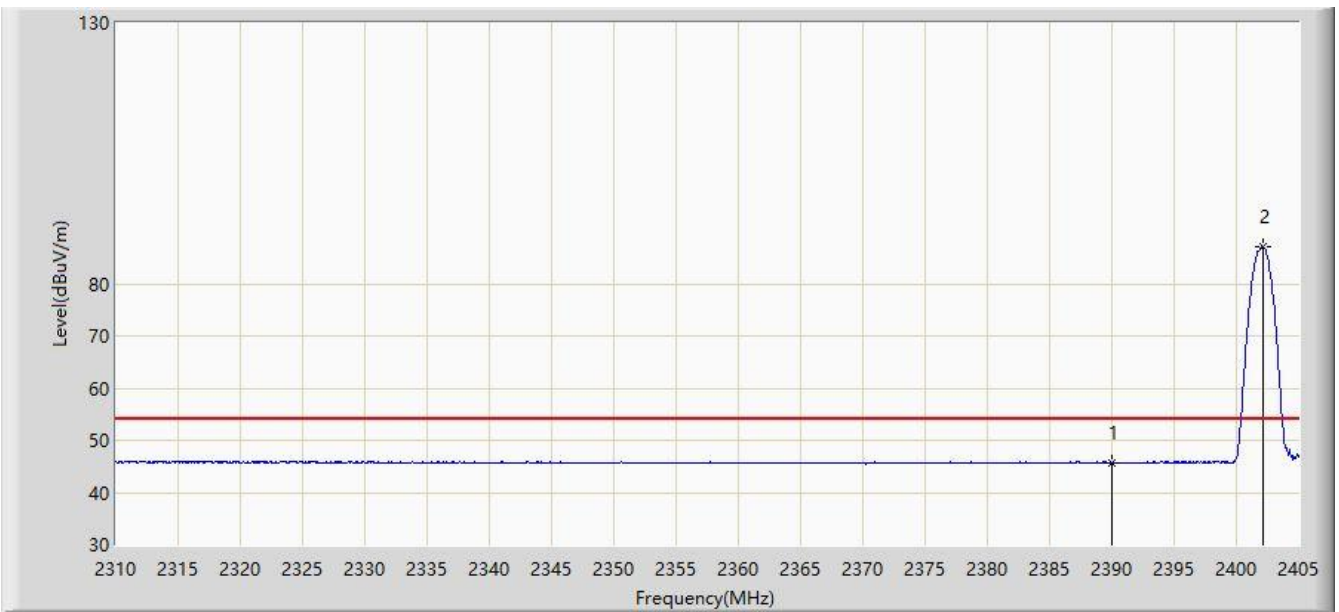

No	Flag	Mark	Frequency (MHz)	Measure Level (dBuV/m)	Reading Level (dBuV)	Margin (dB)	Limit (dBuV/m)	Factor (dB)	Type
1			2390.000	45.689	14.240	-8.311	54.000	31.449	AV
2		*	2402.103	87.062	55.641	N/A	N/A	31.421	AV

Note: Measure Level (dBμV/m) = Reading Level (dBμV) + Factor (dB)

Factor (dB) = Cable Loss (dB) + Antenna Factor (dB/m).

Site: AC2	Time: 2019/06/25 - 07:58
Limit: FCC_Part15.209_RSE(3m)	Engineer: David Lv
Probe: BBHA9120D_1-18GHz	Polarity: Horizontal
EUT: Wireless Speaker	Power: By Battery
Test Mode: Transmit by DH5 at channel 2480MHz	

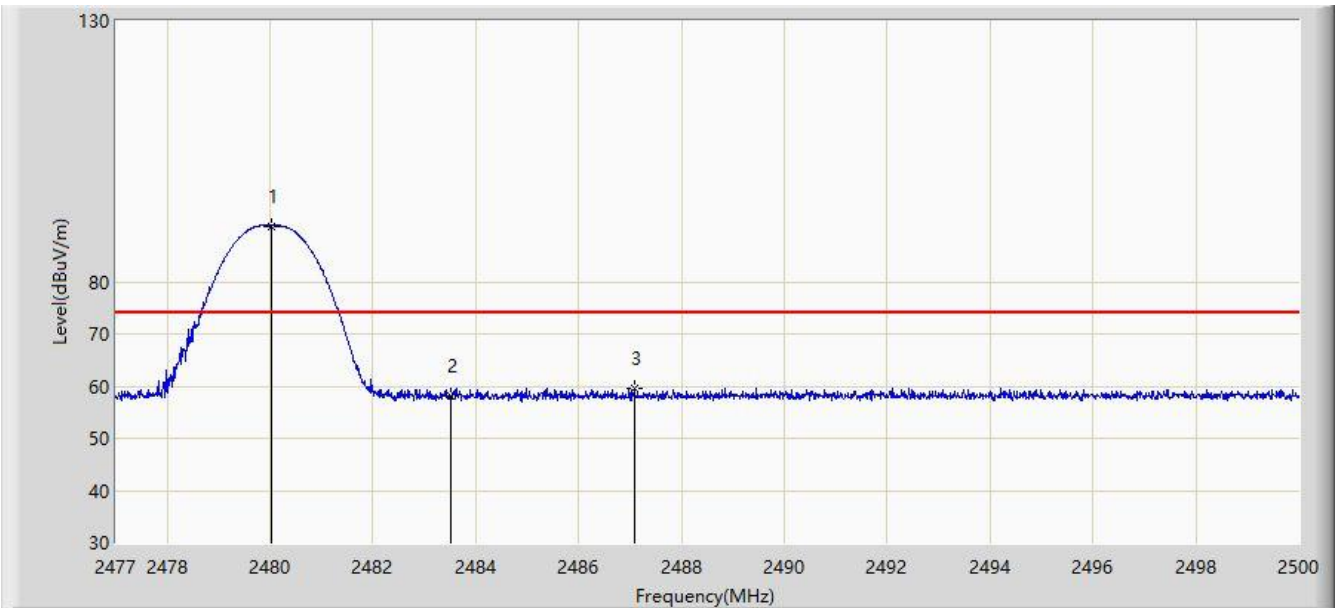

No	Flag	Mark	Frequency (MHz)	Measure Level (dBuV/m)	Reading Level (dBuV)	Margin (dB)	Limit (dBuV/m)	Factor (dB)	Type
1		*	2480.024	90.715	59.324	N/A	N/A	31.391	PK
2			2483.500	57.997	26.594	-16.003	74.000	31.403	PK
3			2487.074	59.434	28.019	-14.566	74.000	31.415	PK

Note: Measure Level (dB μ V/m) = Reading Level (dB μ V) + Factor (dB)

Factor (dB) = Cable Loss (dB) + Antenna Factor (dB/m).

Site: AC2	Time: 2019/06/25 - 08:00
Limit: FCC_Part15.209_RSE(3m)	Engineer: David Lv
Probe: BBHA9120D_1-18GHz	Polarity: Horizontal
EUT: Wireless Speaker	Power: By Battery
Test Mode: Transmit by DH5 at channel 2480MHz	

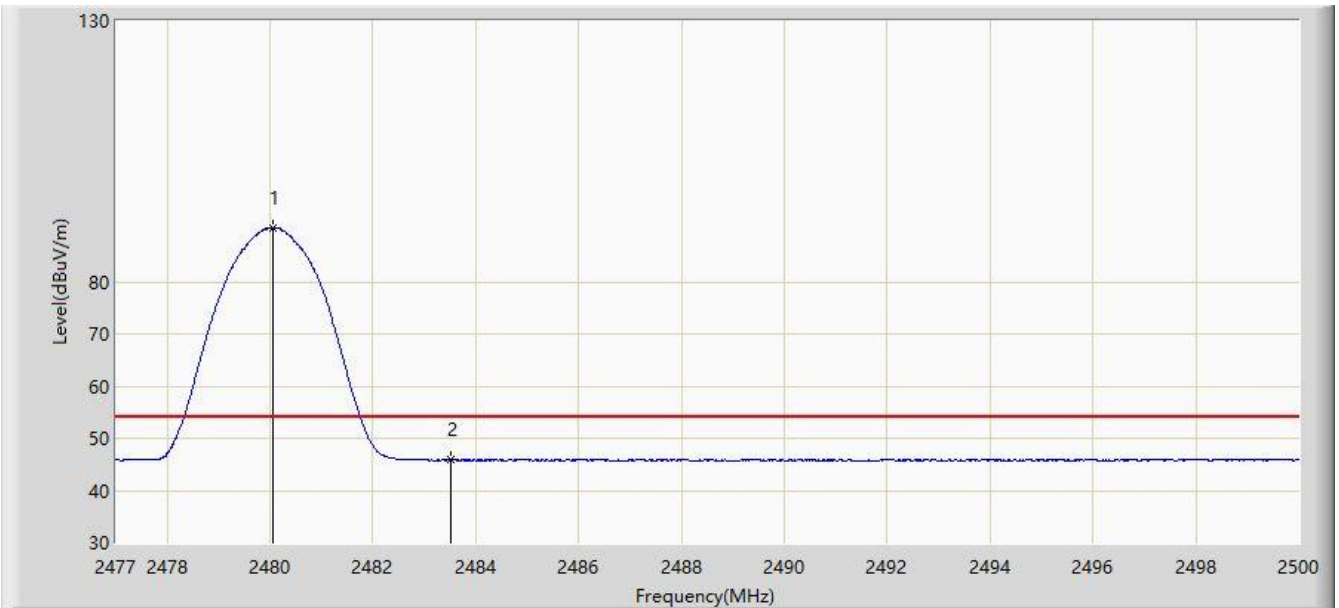

No	Flag	Mark	Frequency (MHz)	Measure Level (dBuV/m)	Reading Level (dBuV)	Margin (dB)	Limit (dBuV/m)	Factor (dB)	Type
1		*	2480.059	90.332	58.941	N/A	N/A	31.391	AV
2			2483.500	45.930	14.527	-8.070	54.000	31.403	AV

Note: Measure Level (dB μ V/m) = Reading Level (dB μ V) + Factor (dB)

Factor (dB) = Cable Loss (dB) + Antenna Factor (dB/m).

Site: AC2	Time: 2019/06/25 - 08:01
Limit: FCC_Part15.209_RSE(3m)	Engineer: David Lv
Probe: BBHA9120D_1-18GHz	Polarity: Vertical
EUT: Wireless Speaker	Power: By Battery
Test Mode: Transmit by DH5 at channel 2480MHz	

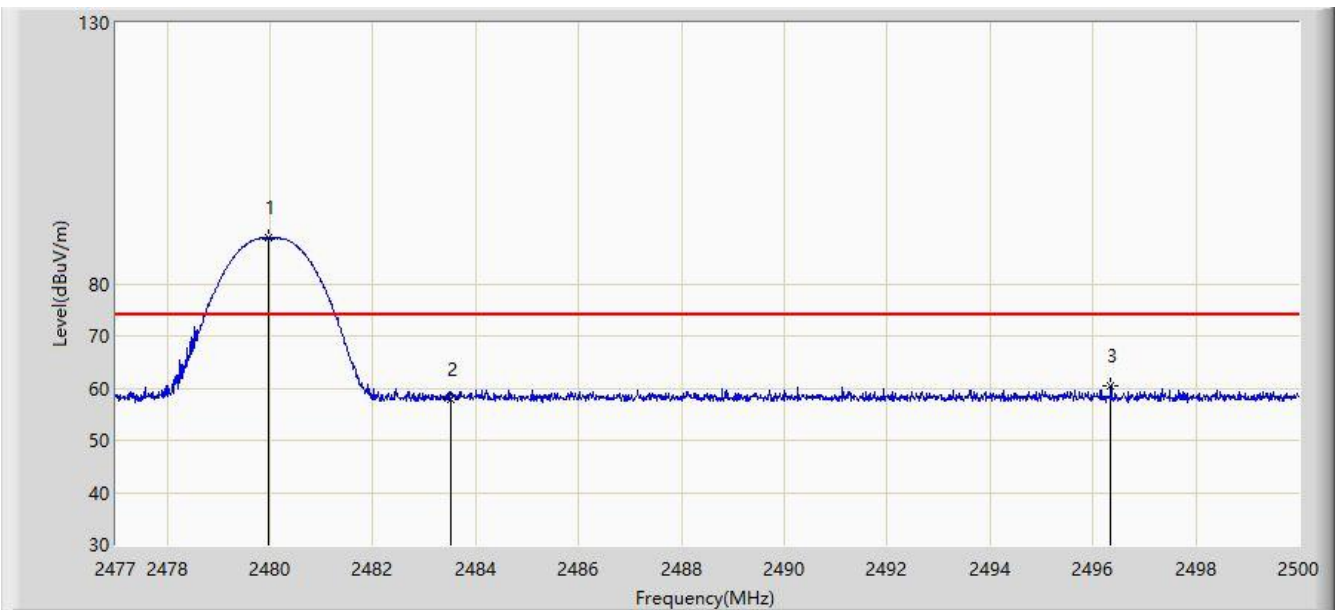

No	Flag	Mark	Frequency (MHz)	Measure Level (dBuV/m)	Reading Level (dBuV)	Margin (dB)	Limit (dBuV/m)	Factor (dB)	Type
1		*	2479.956	88.701	57.310	N/A	N/A	31.391	PK
2			2483.500	57.834	26.431	-16.166	74.000	31.403	PK
3			2496.354	60.303	28.857	-13.697	74.000	31.446	PK

Note: Measure Level (dB μ V/m) = Reading Level (dB μ V) + Factor (dB)

Factor (dB) = Cable Loss (dB) + Antenna Factor (dB/m).

Site: AC2	Time: 2019/06/25 - 08:03
Limit: FCC_Part15.209_RSE(3m)	Engineer: David Lv
Probe: BBHA9120D_1-18GHz	Polarity: Vertical
EUT: Wireless Speaker	Power: By Battery
Test Mode: Transmit by DH5 at channel 2480MHz	

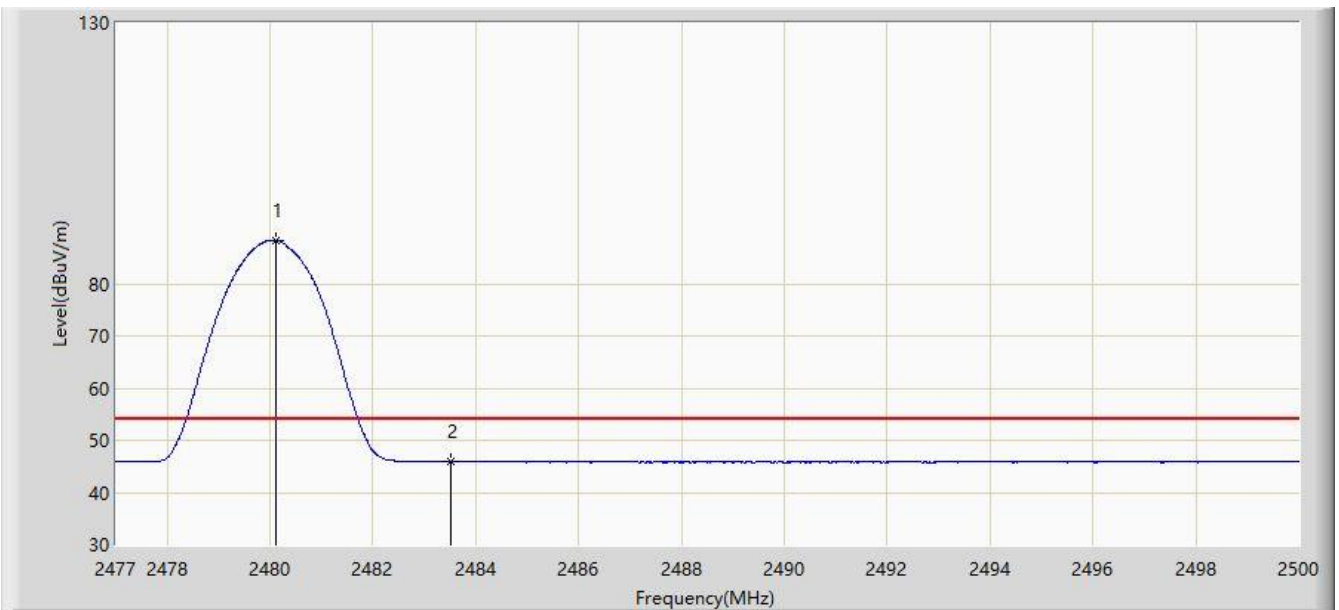

No	Flag	Mark	Frequency (MHz)	Measure Level (dBuV/m)	Reading Level (dBuV)	Margin (dB)	Limit (dBuV/m)	Factor (dB)	Type
1		*	2480.105	88.285	56.894	N/A	N/A	31.391	AV
2			2483.500	45.913	14.510	-8.087	54.000	31.403	AV

Note: Measure Level (dB μ V/m) = Reading Level (dB μ V) + Factor (dB)

Factor (dB) = Cable Loss (dB) + Antenna Factor (dB/m).

Site: AC2	Time: 2019/06/25 - 08:05
Limit: FCC_Part15.209_RSE(3m)	Engineer: David Lv
Probe: BBHA9120D_1-18GHz	Polarity: Horizontal
EUT: Wireless Speaker	Power: By Battery
Test Mode: Transmit by 2DH5 at channel 2402MHz	

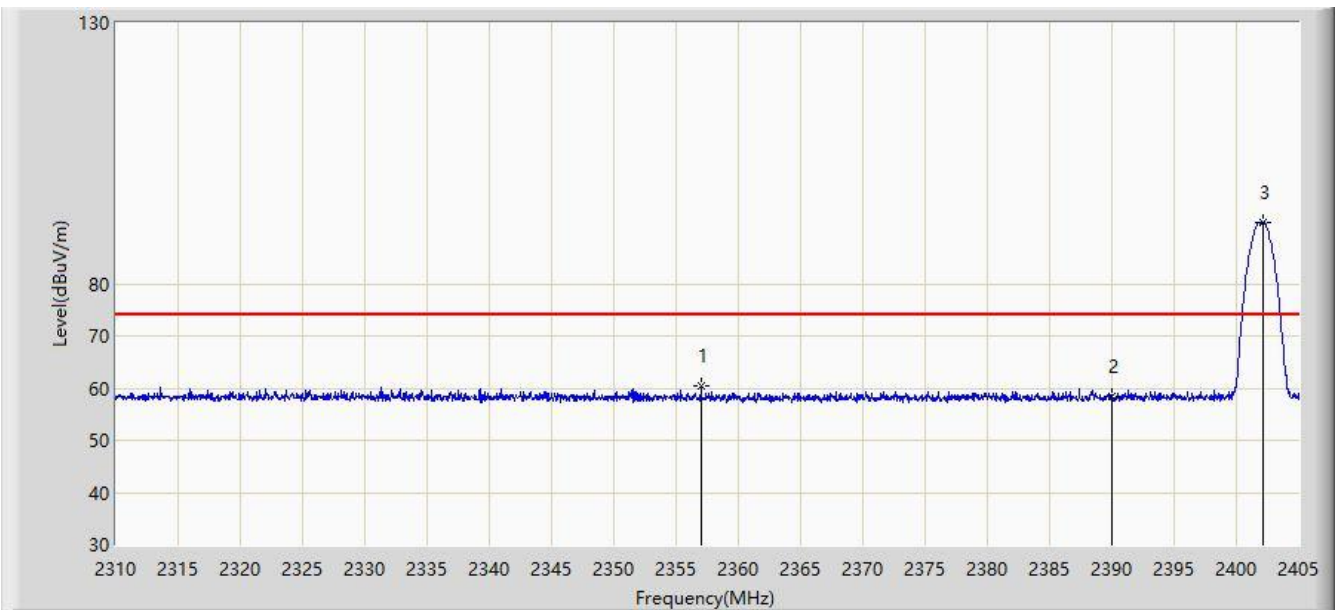

No	Flag	Mark	Frequency (MHz)	Measure Level (dBuV/m)	Reading Level (dBuV)	Margin (dB)	Limit (dBuV/m)	Factor (dB)	Type
1			2357.025	60.313	28.832	-13.687	74.000	31.481	PK
2			2390.000	58.443	26.994	-15.557	74.000	31.449	PK
3		*	2402.150	91.805	60.384	N/A	N/A	31.421	PK

Note: Measure Level (dB μ V/m) = Reading Level (dB μ V) + Factor (dB)

Factor (dB) = Cable Loss (dB) + Antenna Factor (dB/m).

Site: AC2	Time: 2019/06/25 - 08:08
Limit: FCC_Part15.209_RSE(3m)	Engineer: David Lv
Probe: BBHA9120D_1-18GHz	Polarity: Horizontal
EUT: Wireless Speaker	Power: By Battery
Test Mode: Transmit by 2DH5 at channel 2402MHz	

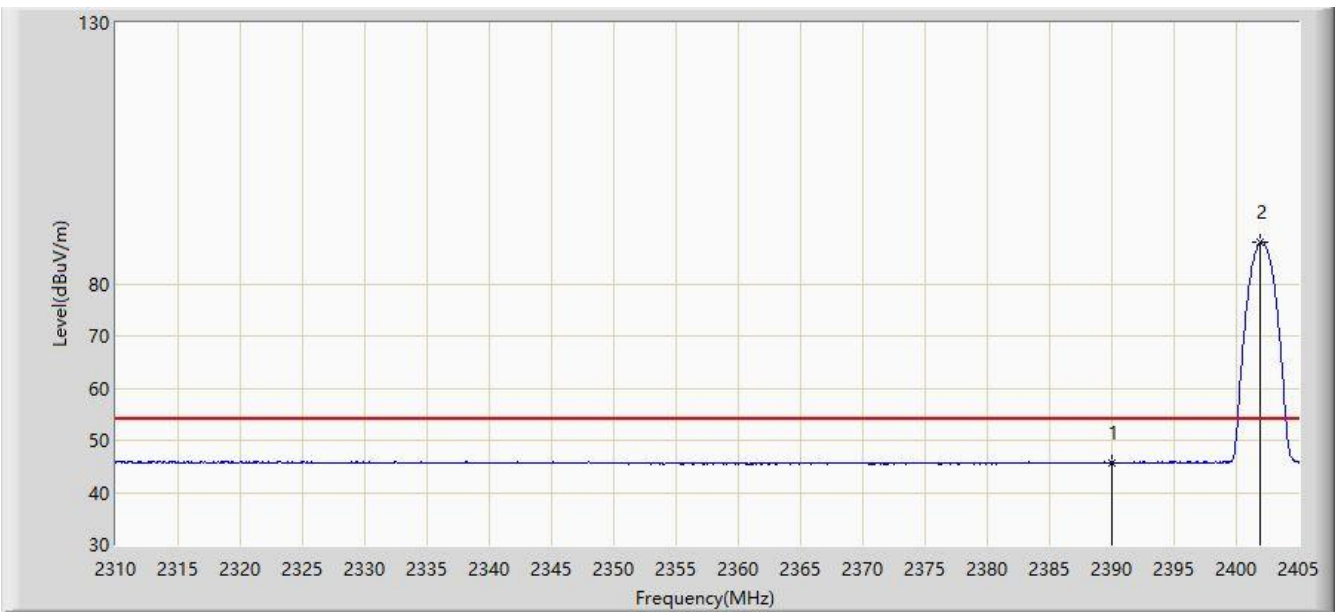

No	Flag	Mark	Frequency (MHz)	Measure Level (dBuV/m)	Reading Level (dBuV)	Margin (dB)	Limit (dBuV/m)	Factor (dB)	Type
1			2390.000	45.762	14.313	-8.238	54.000	31.449	AV
2		*	2401.913	87.928	56.506	N/A	N/A	31.422	AV

Note: Measure Level (dB μ V/m) = Reading Level (dB μ V) + Factor (dB)

Factor (dB) = Cable Loss (dB) + Antenna Factor (dB/m).

Site: AC2	Time: 2019/06/25 - 08:08
Limit: FCC_Part15.209_RSE(3m)	Engineer: David Lv
Probe: BBHA9120D_1-18GHz	Polarity: Vertical
EUT: Wireless Speaker	Power: By Battery
Test Mode: Transmit by 2DH5 at channel 2402MHz	

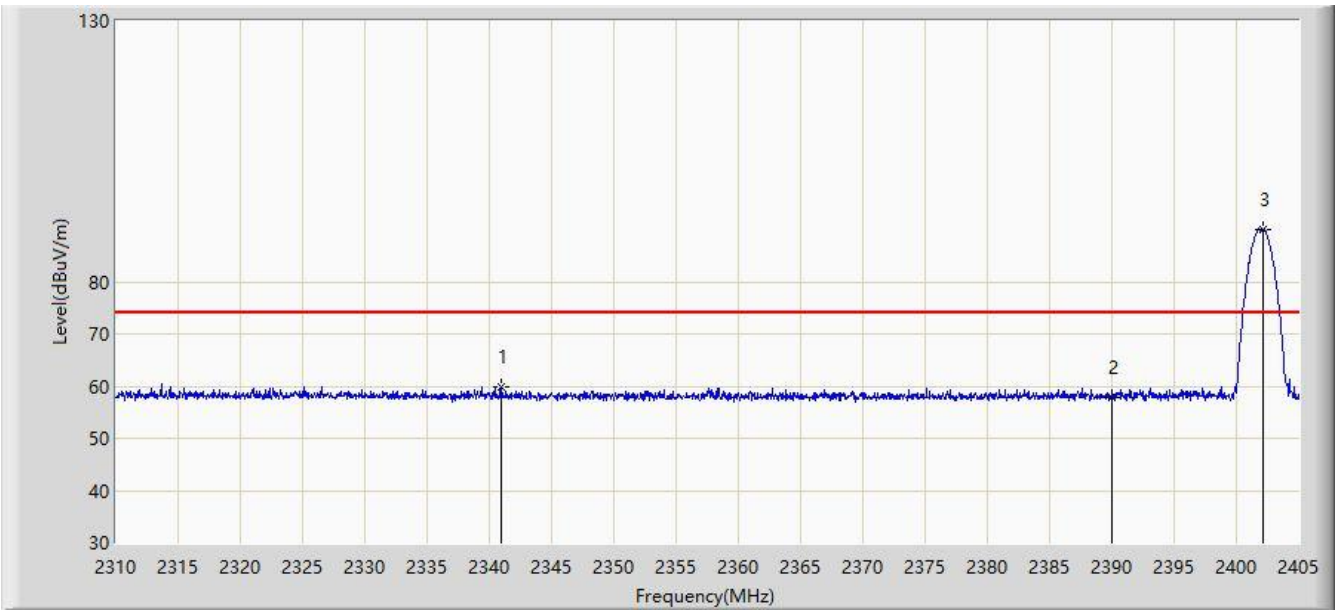

No	Flag	Mark	Frequency (MHz)	Measure Level (dBuV/m)	Reading Level (dBuV)	Margin (dB)	Limit (dBuV/m)	Factor (dB)	Type
1			2340.970	59.743	28.200	-14.257	74.000	31.542	PK
2			2390.000	57.821	26.372	-16.179	74.000	31.449	PK
3		*	2402.103	90.142	58.721	N/A	N/A	31.421	PK

Note: Measure Level (dB μ V/m) = Reading Level (dB μ V) + Factor (dB)

Factor (dB) = Cable Loss (dB) + Antenna Factor (dB/m).

Site: AC2	Time: 2019/06/25 - 08:10
Limit: FCC_Part15.209_RSE(3m)	Engineer: David Lv
Probe: BBHA9120D_1-18GHz	Polarity: Vertical
EUT: Wireless Speaker	Power: By Battery
Test Mode: Transmit by 2DH5 at channel 2402MHz	

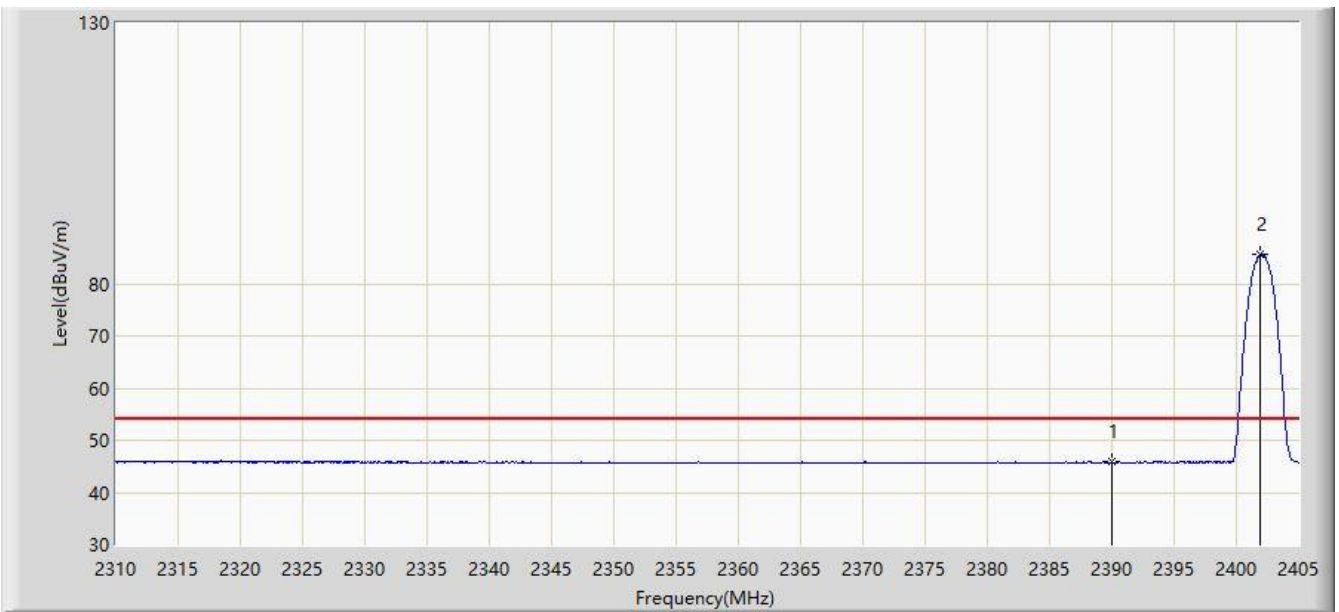

No	Flag	Mark	Frequency (MHz)	Measure Level (dBuV/m)	Reading Level (dBuV)	Margin (dB)	Limit (dBuV/m)	Factor (dB)	Type
1			2390.000	45.801	14.352	-8.199	54.000	31.449	AV
2		*	2401.913	85.762	54.340	N/A	N/A	31.422	AV

Note: Measure Level (dBμV/m) = Reading Level (dBμV) + Factor (dB)

Factor (dB) = Cable Loss (dB) + Antenna Factor (dB/m).

Site: AC2	Time: 2019/06/25 - 08:11
Limit: FCC_Part15.209_RSE(3m)	Engineer: David Lv
Probe: BBHA9120D_1-18GHz	Polarity: Horizontal
EUT: Wireless Speaker	Power: By Battery
Test Mode: Transmit by 2DH5 at channel 2480MHz	

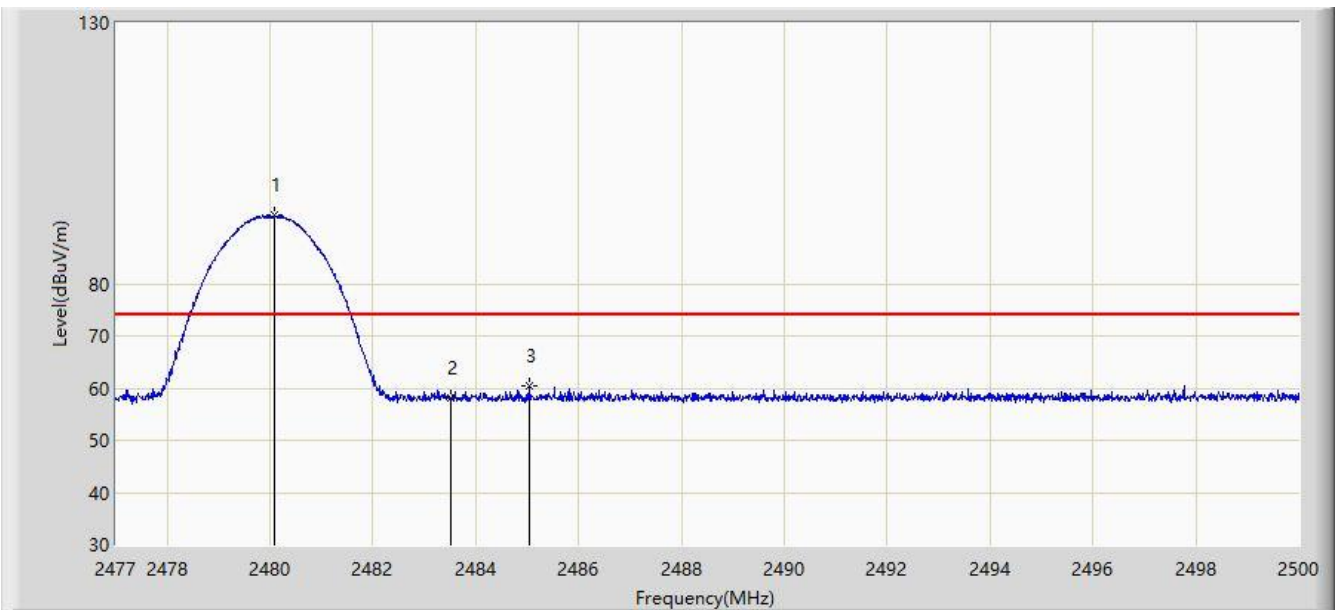

No	Flag	Mark	Frequency (MHz)	Measure Level (dBuV/m)	Reading Level (dBuV)	Margin (dB)	Limit (dBuV/m)	Factor (dB)	Type
1		*	2480.071	93.097	61.706	N/A	N/A	31.391	PK
2			2483.500	58.048	26.645	-15.952	74.000	31.403	PK
3			2485.027	60.351	28.943	-13.649	74.000	31.408	PK

Note: Measure Level (dB μ V/m) = Reading Level (dB μ V) + Factor (dB)

Factor (dB) = Cable Loss (dB) + Antenna Factor (dB/m).

Site: AC2	Time: 2019/06/25 - 08:12
Limit: FCC_Part15.209_RSE(3m)	Engineer: David Lv
Probe: BBHA9120D_1-18GHz	Polarity: Horizontal
EUT: Wireless Speaker	Power: By Battery
Test Mode: Transmit by 2DH5 at channel 2480MHz	

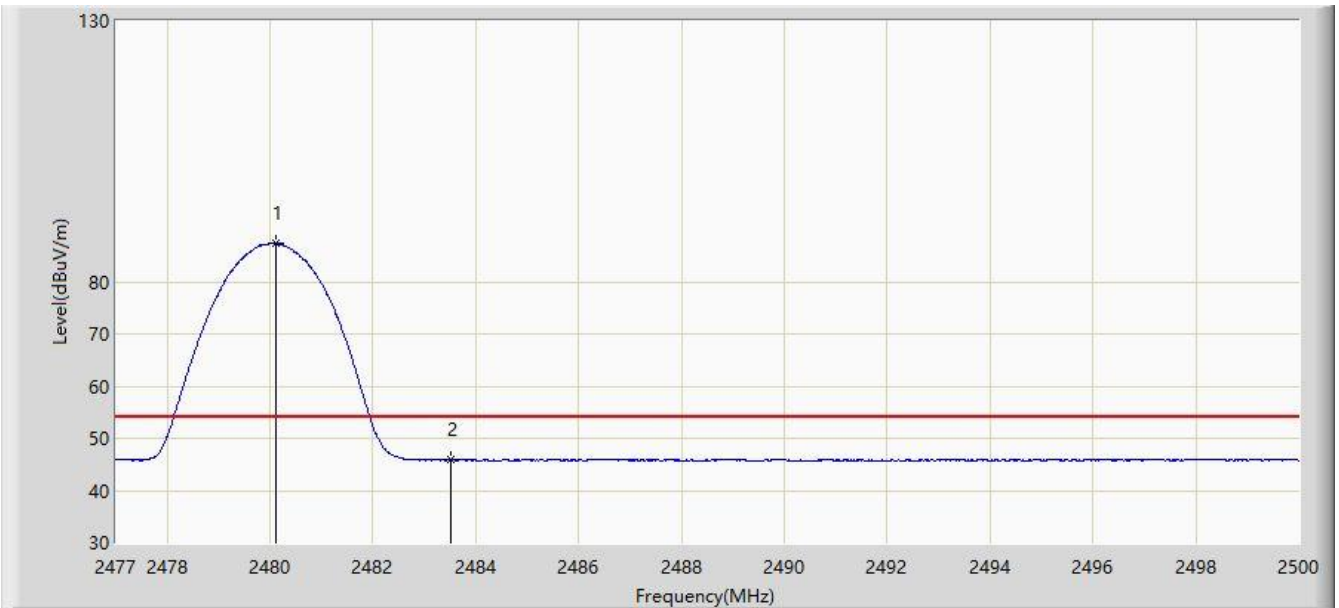

No	Flag	Mark	Frequency (MHz)	Measure Level (dBuV/m)	Reading Level (dBuV)	Margin (dB)	Limit (dBuV/m)	Factor (dB)	Type
1		*	2480.105	87.338	55.947	N/A	N/A	31.391	AV
2			2483.500	45.886	14.483	-8.114	54.000	31.403	AV

Note: Measure Level (dB μ V/m) = Reading Level (dB μ V) + Factor (dB)

Factor (dB) = Cable Loss (dB) + Antenna Factor (dB/m).

Site: AC2	Time: 2019/06/25 - 08:13
Limit: FCC_Part15.209_RSE(3m)	Engineer: David Lv
Probe: BBHA9120D_1-18GHz	Polarity: Vertical
EUT: Wireless Speaker	Power: By Battery
Test Mode: Transmit by 2DH5 at channel 2480MHz	

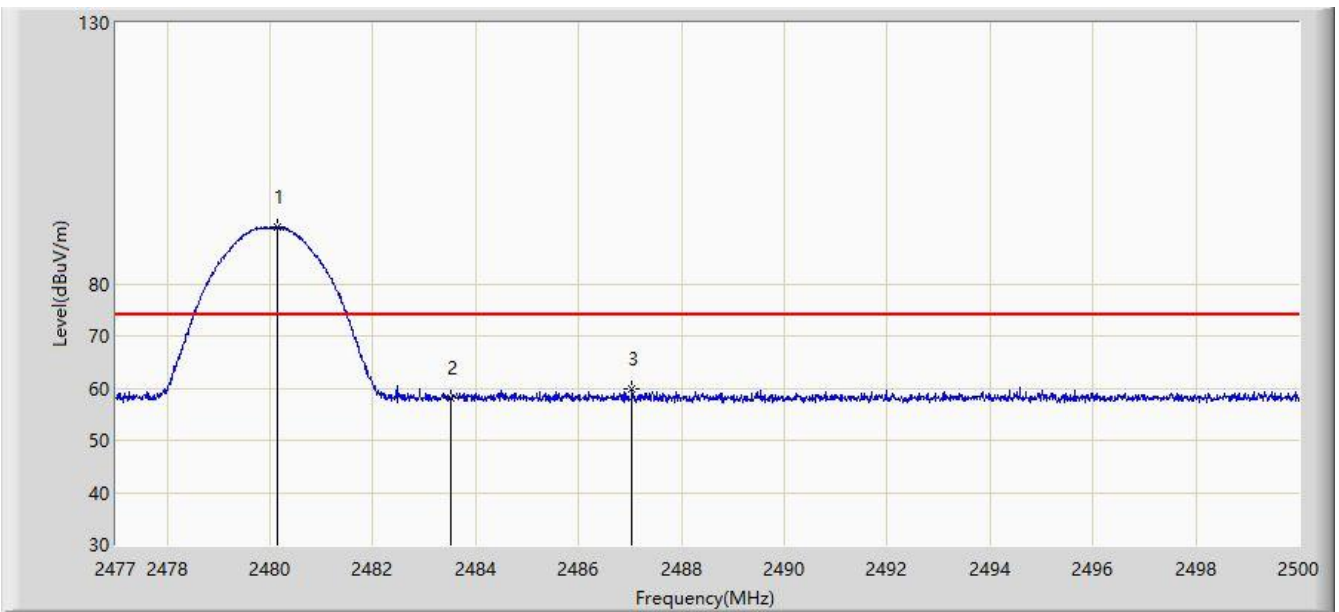

No	Flag	Mark	Frequency (MHz)	Measure Level (dBuV/m)	Reading Level (dBuV)	Margin (dB)	Limit (dBuV/m)	Factor (dB)	Type
1		*	2480.151	90.750	59.359	N/A	N/A	31.392	PK
2			2483.500	58.085	26.682	-15.915	74.000	31.403	PK
3			2487.040	59.751	28.336	-14.249	74.000	31.415	PK

Note: Measure Level (dB μ V/m) = Reading Level (dB μ V) + Factor (dB)

Factor (dB) = Cable Loss (dB) + Antenna Factor (dB/m).

Site: AC2	Time: 2019/06/25 - 08:15
Limit: FCC_Part15.209_RSE(3m)	Engineer: David Lv
Probe: BBHA9120D_1-18GHz	Polarity: Vertical
EUT: Wireless Speaker	Power: By Battery
Test Mode: Transmit by 2DH5 at channel 2480MHz	

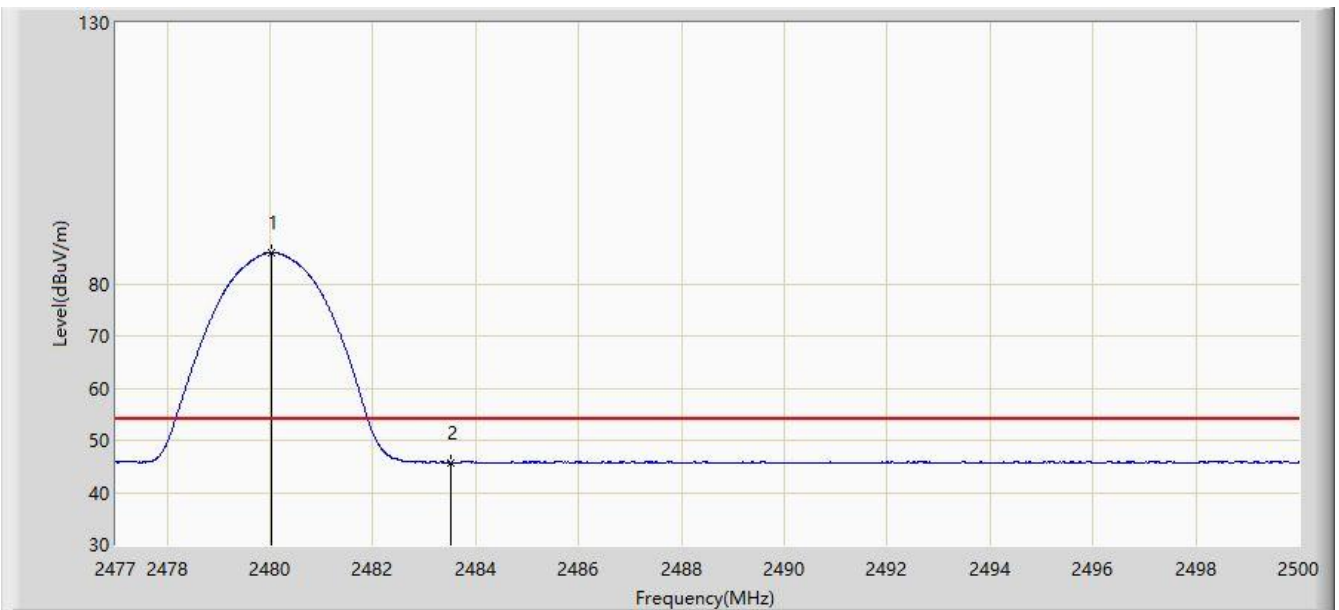

No	Flag	Mark	Frequency (MHz)	Measure Level (dBuV/m)	Reading Level (dBuV)	Margin (dB)	Limit (dBuV/m)	Factor (dB)	Type
1		*	2480.024	85.980	54.589	N/A	N/A	31.391	AV
2			2483.500	45.779	14.376	-8.221	54.000	31.403	AV

Note: Measure Level (dB μ V/m) = Reading Level (dB μ V) + Factor (dB)

Factor (dB) = Cable Loss (dB) + Antenna Factor (dB/m).

Site: AC2	Time: 2019/06/25 - 08:16
Limit: FCC_Part15.209_RSE(3m)	Engineer: David Lv
Probe: BBHA9120D_1-18GHz	Polarity: Horizontal
EUT: Wireless Speaker	Power: By Battery
Test Mode: Transmit by 3DH5 at channel 2402MHz	

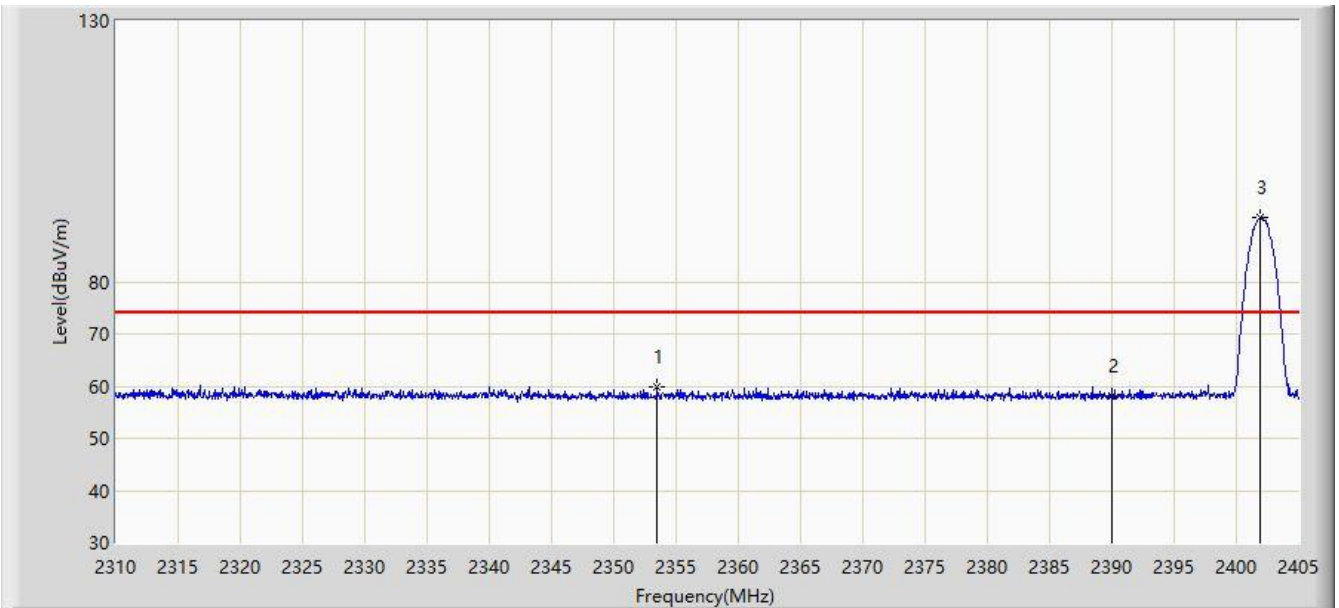

No	Flag	Mark	Frequency (MHz)	Measure Level (dBuV/m)	Reading Level (dBuV)	Margin (dB)	Limit (dBuV/m)	Factor (dB)	Type
1			2353.462	59.862	28.368	-14.138	74.000	31.495	PK
2			2390.000	58.056	26.607	-15.944	74.000	31.449	PK
3		*	2401.960	92.277	60.855	N/A	N/A	31.422	PK

Note: Measure Level (dB μ V/m) = Reading Level (dB μ V) + Factor (dB)

Factor (dB) = Cable Loss (dB) + Antenna Factor (dB/m).

Site: AC2	Time: 2019/06/25 - 08:19
Limit: FCC_Part15.209_RSE(3m)	Engineer: David Lv
Probe: BBHA9120D_1-18GHz	Polarity: Horizontal
EUT: Wireless Speaker	Power: By Battery
Test Mode: Transmit by 3DH5 at channel 2402MHz	

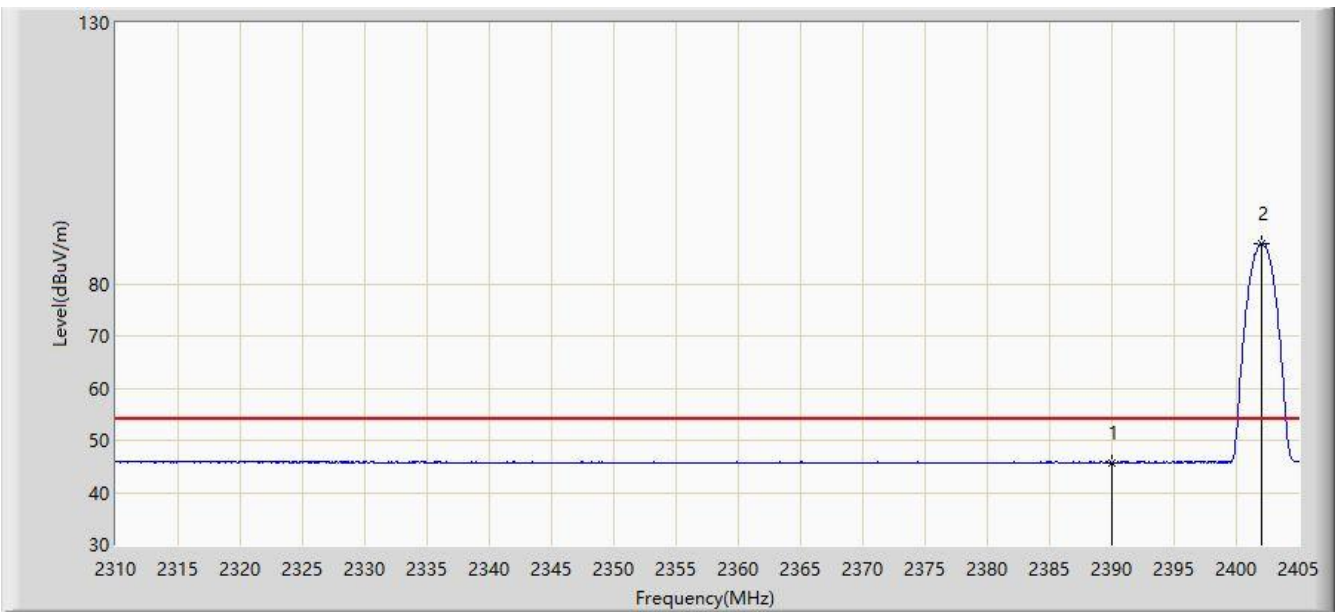

No	Flag	Mark	Frequency (MHz)	Measure Level (dBuV/m)	Reading Level (dBuV)	Margin (dB)	Limit (dBuV/m)	Factor (dB)	Type
1			2390.000	45.776	14.327	-8.224	54.000	31.449	AV
2		*	2402.008	87.821	56.399	N/A	N/A	31.422	AV

Note: Measure Level (dB μ V/m) = Reading Level (dB μ V) + Factor (dB)

Factor (dB) = Cable Loss (dB) + Antenna Factor (dB/m).

Site: AC2	Time: 2019/06/25 - 08:19
Limit: FCC_Part15.209_RSE(3m)	Engineer: David Lv
Probe: BBHA9120D_1-18GHz	Polarity: Vertical
EUT: Wireless Speaker	Power: By Battery
Test Mode: Transmit by 3DH5 at channel 2402MHz	

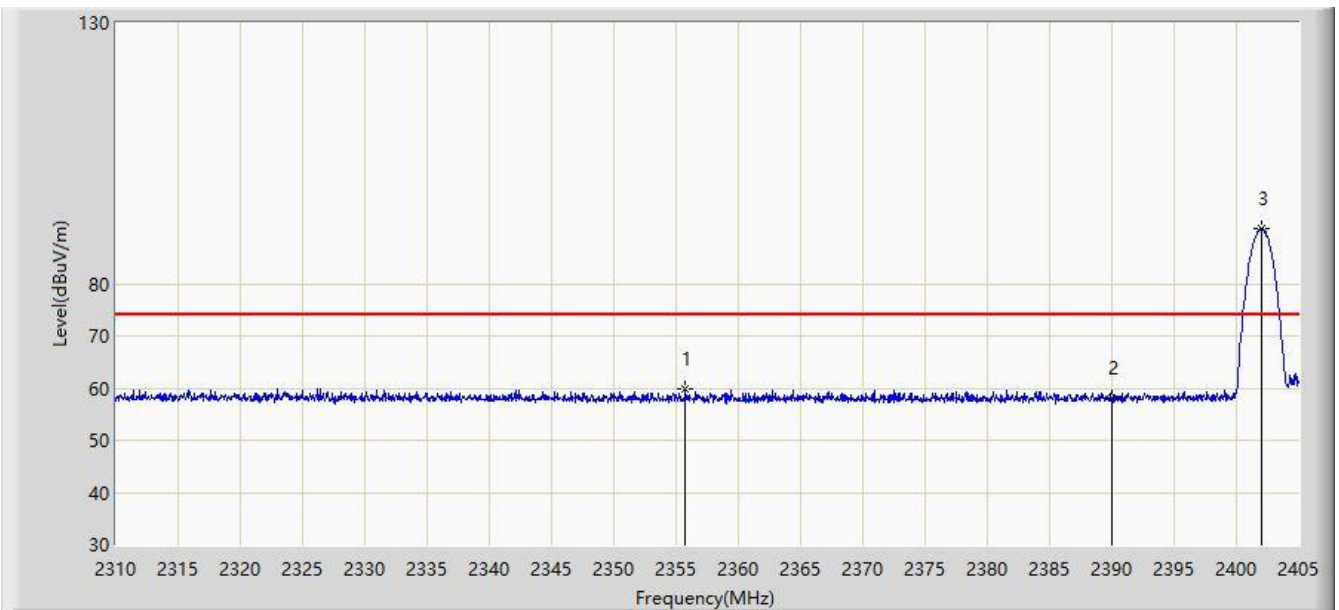

No	Flag	Mark	Frequency (MHz)	Measure Level (dBuV/m)	Reading Level (dBuV)	Margin (dB)	Limit (dBuV/m)	Factor (dB)	Type
1			2355.742	59.742	28.256	-14.258	74.000	31.486	PK
2			2390.000	58.027	26.578	-15.973	74.000	31.449	PK
3		*	2402.008	90.499	59.077	N/A	N/A	31.422	PK

Note: Measure Level (dB μ V/m) = Reading Level (dB μ V) + Factor (dB)

Factor (dB) = Cable Loss (dB) + Antenna Factor (dB/m).

Site: AC2	Time: 2019/06/25 - 08:21
Limit: FCC_Part15.209_RSE(3m)	Engineer: David Lv
Probe: BBHA9120D_1-18GHz	Polarity: Vertical
EUT: Wireless Speaker	Power: By Battery
Test Mode: Transmit by 3DH5 at channel 2402MHz	

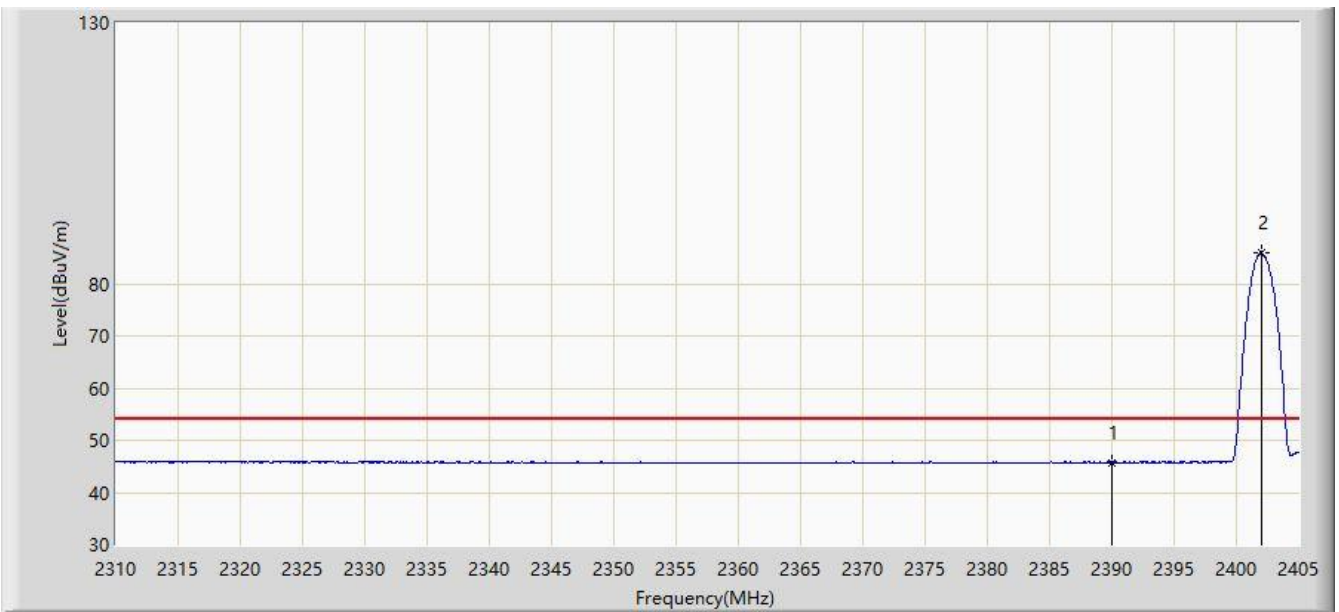

No	Flag	Mark	Frequency (MHz)	Measure Level (dBuV/m)	Reading Level (dBuV)	Margin (dB)	Limit (dBuV/m)	Factor (dB)	Type
1			2390.000	45.731	14.282	-8.269	54.000	31.449	AV
2		*	2402.008	86.076	54.654	N/A	N/A	31.422	AV

Note: Measure Level (dB μ V/m) = Reading Level (dB μ V) + Factor (dB)

Factor (dB) = Cable Loss (dB) + Antenna Factor (dB/m).

Site: AC2	Time: 2019/06/25 - 08:22
Limit: FCC_Part15.209_RSE(3m)	Engineer: David Lv
Probe: BBHA9120D_1-18GHz	Polarity: Horizontal
EUT: Wireless Speaker	Power: By Battery
Test Mode: Transmit by 3DH5 at channel 2480MHz	

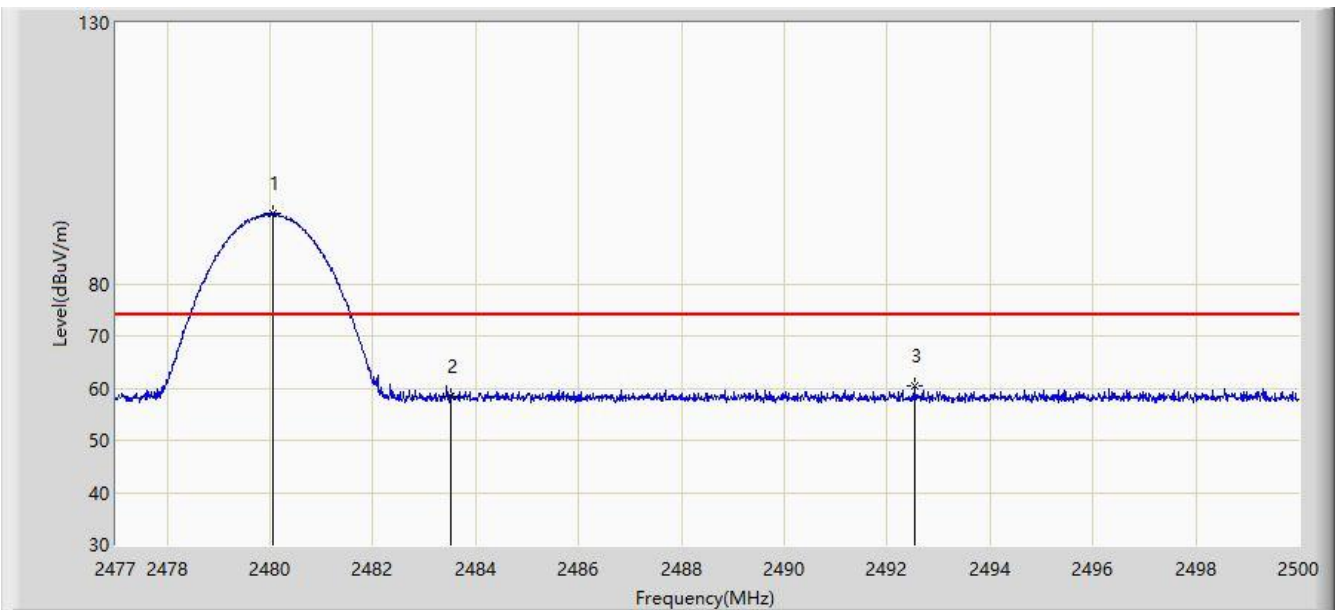

No	Flag	Mark	Frequency (MHz)	Measure Level (dBuV/m)	Reading Level (dBuV)	Margin (dB)	Limit (dBuV/m)	Factor (dB)	Type
1		*	2480.048	93.530	62.139	N/A	N/A	31.391	PK
2			2483.500	58.504	27.101	-15.496	74.000	31.403	PK
3			2492.525	60.487	29.054	-13.513	74.000	31.433	PK

Note: Measure Level (dB μ V/m) = Reading Level (dB μ V) + Factor (dB)

Factor (dB) = Cable Loss (dB) + Antenna Factor (dB/m).

Site: AC2	Time: 2019/06/25 - 08:23
Limit: FCC_Part15.209_RSE(3m)	Engineer: David Lv
Probe: BBHA9120D_1-18GHz	Polarity: Horizontal
EUT: Wireless Speaker	Power: By Battery
Test Mode: Transmit by 3DH5 at channel 2480MHz	

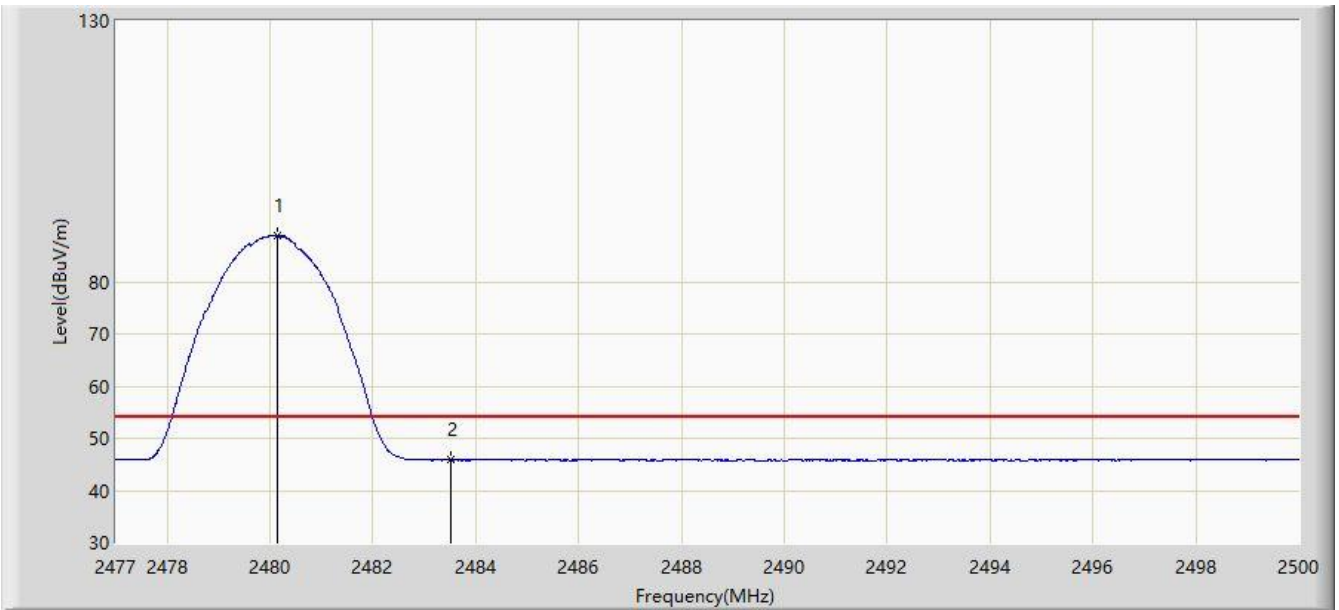

No	Flag	Mark	Frequency (MHz)	Measure Level (dBuV/m)	Reading Level (dBuV)	Margin (dB)	Limit (dBuV/m)	Factor (dB)	Type
1		*	2480.139	88.869	57.478	N/A	N/A	31.392	AV
2			2483.500	45.843	14.440	-8.157	54.000	31.403	AV

Note: Measure Level (dB μ V/m) = Reading Level (dB μ V) + Factor (dB)

Factor (dB) = Cable Loss (dB) + Antenna Factor (dB/m).

Site: AC2	Time: 2019/06/25 - 08:24
Limit: FCC_Part15.209_RSE(3m)	Engineer: David Lv
Probe: BBHA9120D_1-18GHz	Polarity: Vertical
EUT: Wireless Speaker	Power: By Battery
Test Mode: Transmit by 3DH5 at channel 2480MHz	

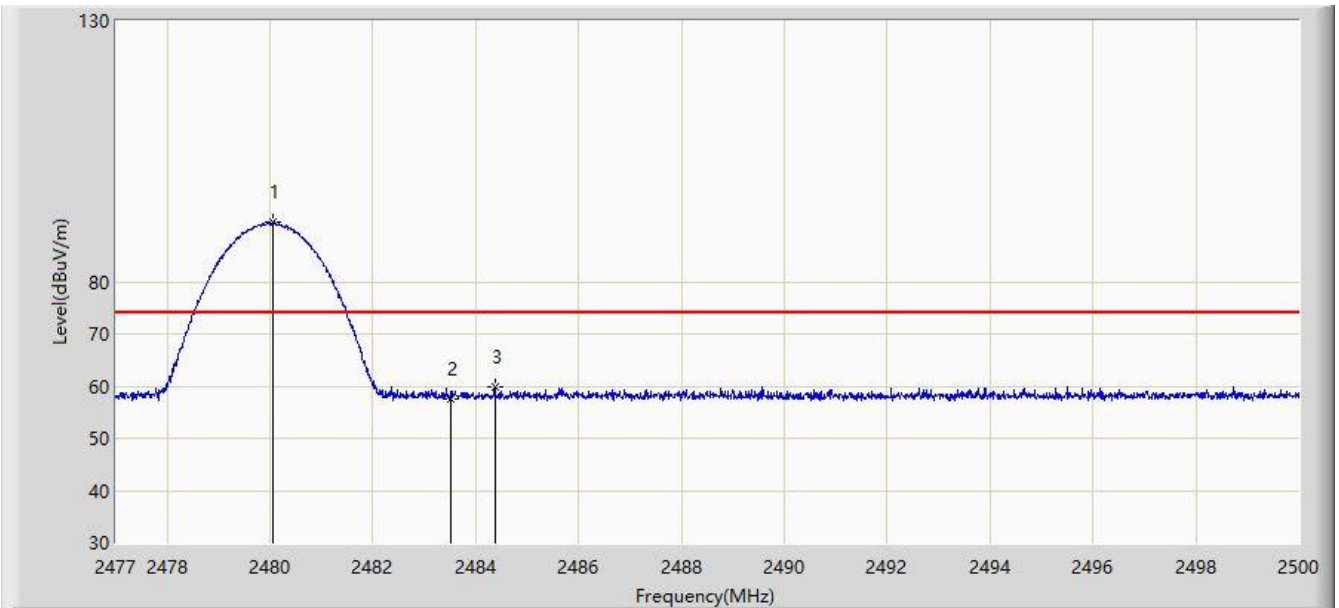

No	Flag	Mark	Frequency (MHz)	Measure Level (dBuV/m)	Reading Level (dBuV)	Margin (dB)	Limit (dBuV/m)	Factor (dB)	Type
1		*	2480.048	91.341	59.950	N/A	N/A	31.391	PK
2			2483.500	57.447	26.044	-16.553	74.000	31.403	PK
3			2484.372	59.756	28.350	-14.244	74.000	31.406	PK

Note: Measure Level (dB μ V/m) = Reading Level (dB μ V) + Factor (dB)

Factor (dB) = Cable Loss (dB) + Antenna Factor (dB/m).

Site: AC2	Time: 2019/06/25 - 08:25
Limit: FCC_Part15.209_RSE(3m)	Engineer: David Lv
Probe: BBHA9120D_1-18GHz	Polarity: Vertical
EUT: Wireless Speaker	Power: By Battery
Test Mode: Transmit by 3DH5 at channel 2480MHz	

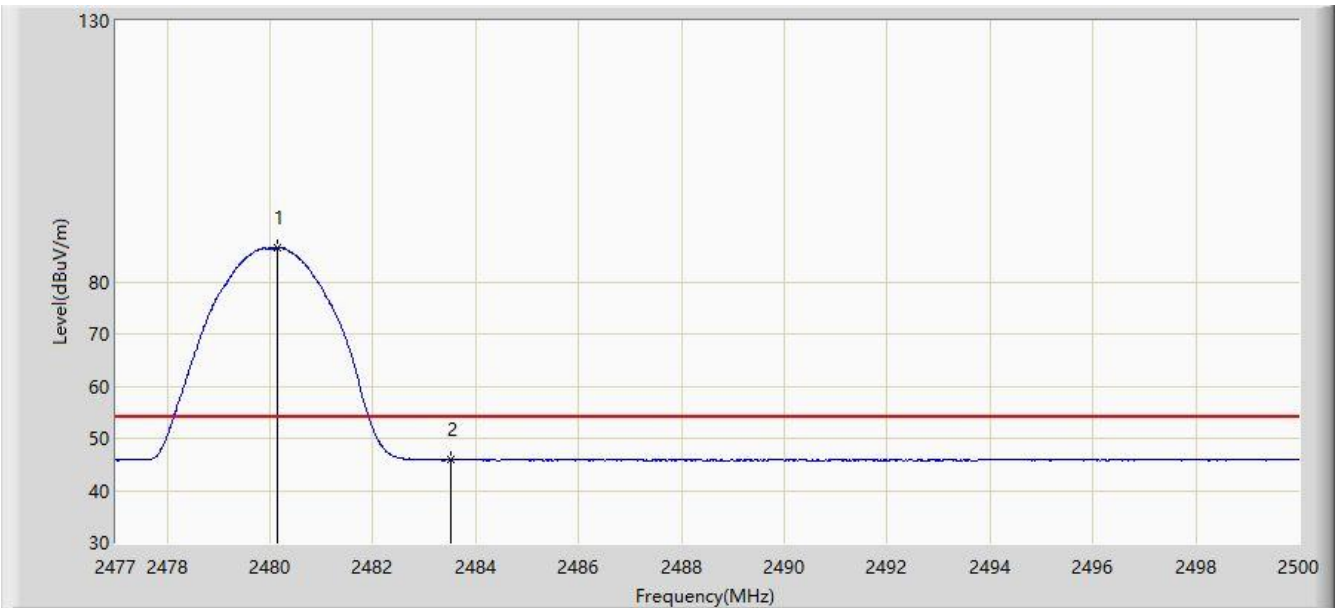

No	Flag	Mark	Frequency (MHz)	Measure Level (dBuV/m)	Reading Level (dBuV)	Margin (dB)	Limit (dBuV/m)	Factor (dB)	Type
1		*	2480.139	86.441	55.050	N/A	N/A	31.392	AV
2			2483.500	45.827	14.424	-8.173	54.000	31.403	AV

Note: Measure Level (dB μ V/m) = Reading Level (dB μ V) + Factor (dB)

Factor (dB) = Cable Loss (dB) + Antenna Factor (dB/m).

7.11. AC Conducted Emissions Measurement

7.11.1. Test Limit

FCC Part 15 Subpart C Paragraph 15.207 Limits		
Frequency (MHz)	QP (dB μ V)	Average (dB μ V)
0.15 - 0.50	66 - 56	56 - 46
0.50 - 5.0	56	46
5.0 - 30	60	50

Note 1: The lower limit shall apply at the transition frequencies.

Note 2: The limit decreases linearly with the logarithm of the frequency in the range 0.15MHz to 0.5MHz.

7.11.2. Test Setup

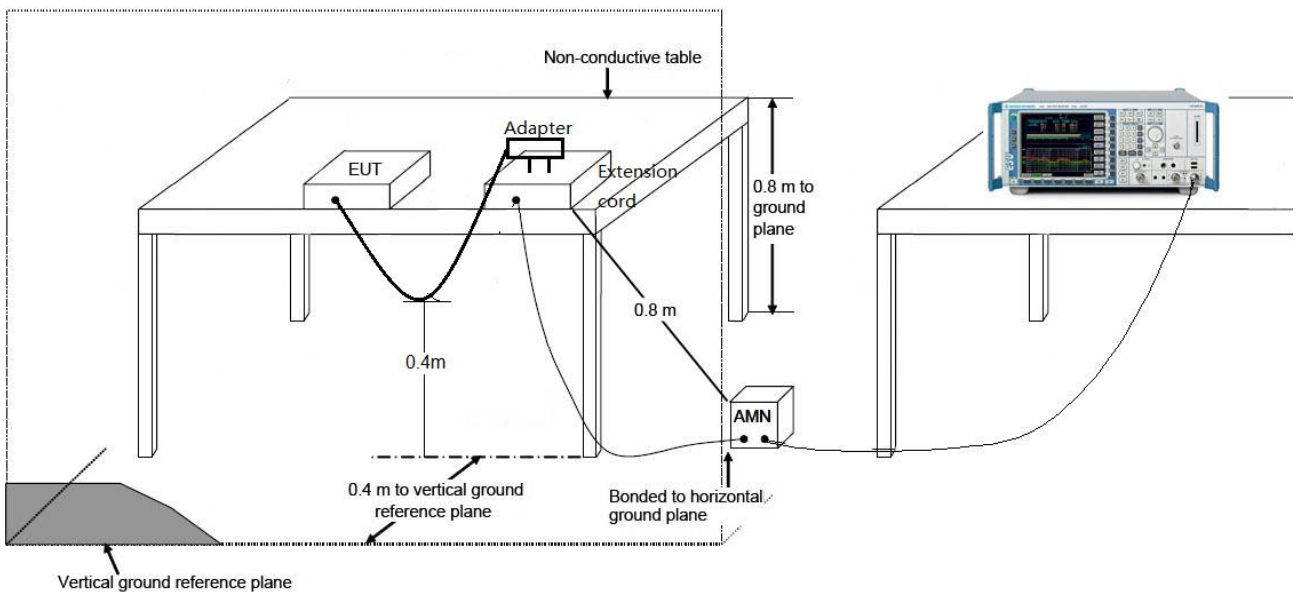

7.11.3. Test Result

Site: SR2	Time: 2019/06/25 - 14:14
Limit: FCC_Part15.207_CE_AC Power	Engineer: Liz Yuan
Probe: ENV216_101683_Filter On	Polarity: Line
EUT: Wireless Speaker	Power: AC 120V / 60Hz
Worst Case Mode: Transmit by DH5 at Channel 2441MHz	

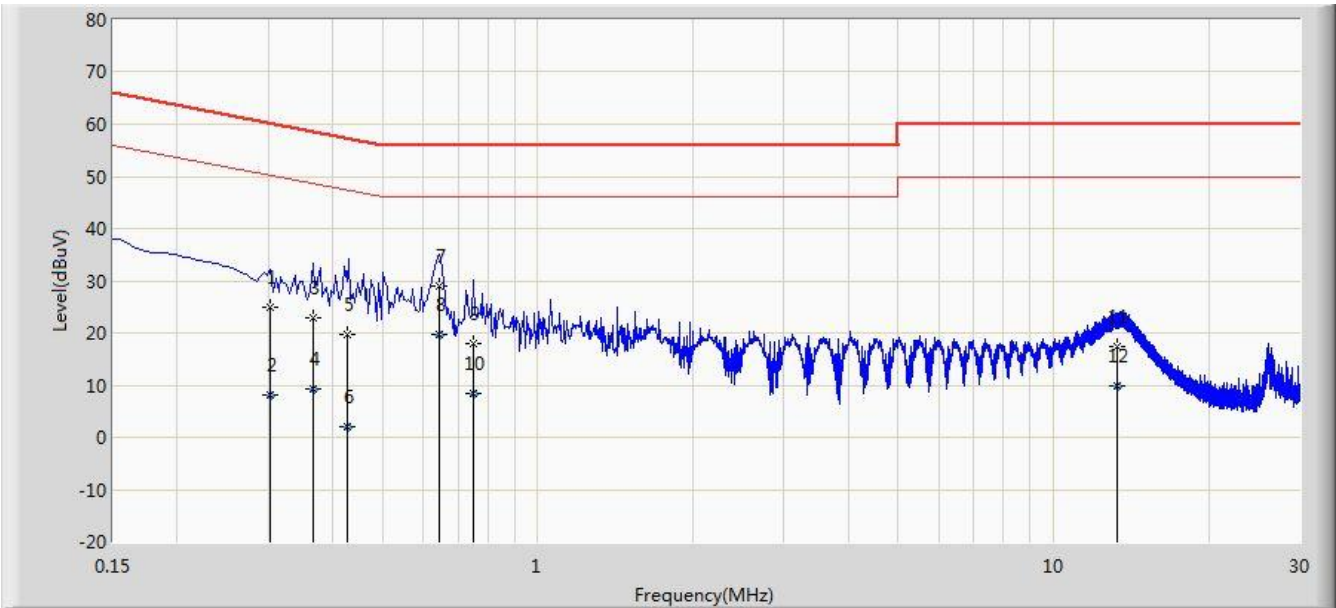

No	Flag	Mark	Frequency (MHz)	Measure Level (dBuV)	Reading Level (dBuV)	Margin (dB)	Limit (dBuV)	Factor (dB)	Type
1			0.302	24.889	14.883	-35.299	60.188	10.006	QP
2			0.302	8.254	-1.751	-41.933	50.188	10.006	AV
3			0.366	22.901	12.843	-35.690	58.591	10.058	QP
4			0.366	9.181	-0.877	-39.410	48.591	10.058	AV
5			0.428	19.808	9.700	-37.483	57.291	10.109	QP
6			0.428	2.008	-8.100	-45.283	47.291	10.109	AV
7			0.643	29.092	19.000	-26.908	56.000	10.092	QP
8		*	0.643	19.592	9.500	-26.408	46.000	10.092	AV
9			0.750	18.026	7.989	-37.974	56.000	10.037	QP
10			0.750	8.362	-1.675	-37.638	46.000	10.037	AV
11			13.266	17.507	7.445	-42.493	60.000	10.062	QP
12			13.266	9.914	-0.148	-40.086	50.000	10.062	AV

Note: Measure Level (dBμV) = Reading Level (dBμV) + Factor (dB)

Factor (dB) = Cable Loss (dB) + LISN Factor (dB)

Site: SR2	Time: 2019/06/25 - 14:23
Limit: FCC_Part15.207_CE_AC Power	Engineer: Liz Yuan
Probe: ENV216_101683_Filter On	Polarity: Neutral
EUT: Wireless Speaker	Power: AC 120V / 60Hz
Worst Case Mode: Transmit by DH5 at Channel 2441MHz	

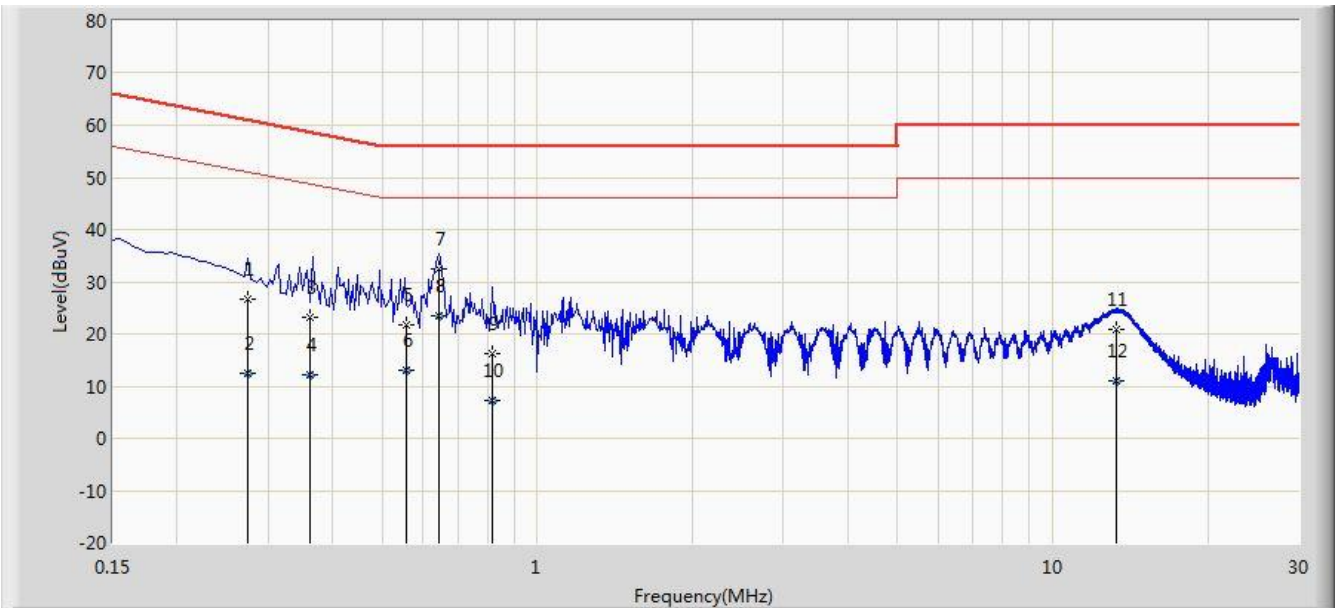

No	Flag	Mark	Frequency (MHz)	Measure Level (dBuV)	Reading Level (dBuV)	Margin (dB)	Limit (dBuV)	Factor (dB)	Type
1			0.274	26.700	16.681	-34.296	60.996	10.019	QP
2			0.274	12.410	2.391	-38.586	50.996	10.019	AV
3			0.363	23.085	13.000	-35.575	58.660	10.085	QP
4			0.363	12.185	2.100	-36.475	48.660	10.085	AV
5			0.555	21.756	11.600	-34.244	56.000	10.156	QP
6			0.555	13.056	2.900	-32.944	46.000	10.156	AV
7			0.643	32.507	22.400	-23.493	56.000	10.107	QP
8		*	0.643	23.607	13.500	-22.393	46.000	10.107	AV
9			0.818	16.283	6.274	-39.717	56.000	10.009	QP
10			0.818	7.236	-2.773	-38.764	46.000	10.009	AV
11			13.286	20.802	10.696	-39.198	60.000	10.105	QP
12			13.286	10.885	0.779	-39.115	50.000	10.105	AV

Note: Measure Level (dBμV) = Reading Level (dBμV) + Factor (dB)

Factor (dB) = Cable Loss (dB) + LISN Factor (dB)

8. CONCLUSION

The data collected relate only the item(s) tested and show that unit is in compliance with Part 15C of the FCC rules.

Appendix A - Test Setup Photograph

Refer to "1906RSU028-UT" file.

Appendix B - EUT Photograph

Refer to "1906RSU028-UE" file.

_____ The End _____