

REMOTE CONTROL SPORTS ITALIA CAR

AGES
6+

OPERATING INSTRUCTIONS

Carefully remove items from package.

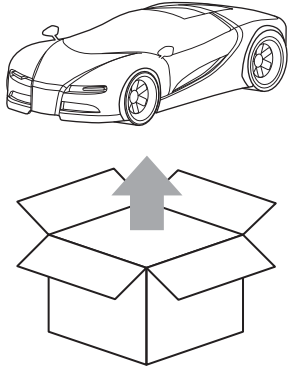

The car requires 1 "AAA" 1.5V battery (not included). Use a Phillips head or Cross screwdriver to loosen the screw securing the corresponding battery cover plate. Insert the batterie(s), ensuring the correct polarity per the diagrams below. Replace the battery cover and tighten the screw.

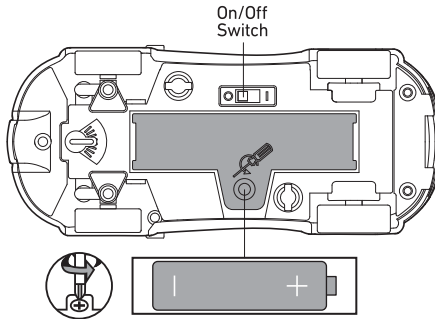

The remote requires 2 "AAA" 1.5V batteries (not included). Use a Phillips head or Cross screwdriver to loosen the screw securing the corresponding battery cover plate. Insert the batterie(s), ensuring the correct polarity per the diagrams below. Replace the battery cover and tighten the screw.

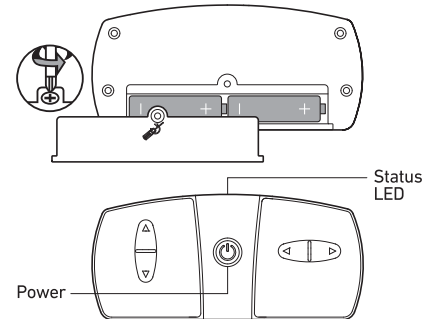

Slide the power switch on the underside of the car to the ON position.

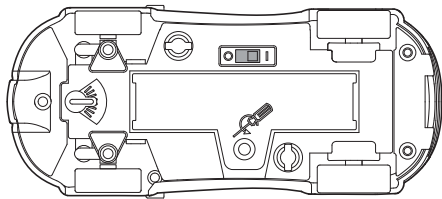

Press the power button on the remote. The LED at the top of the remote will turn ON.

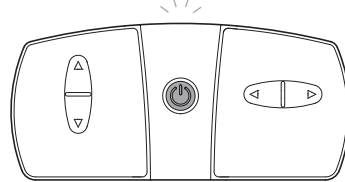

Forward

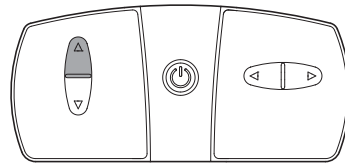
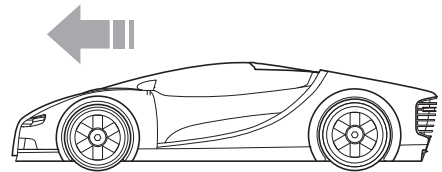

Reverse

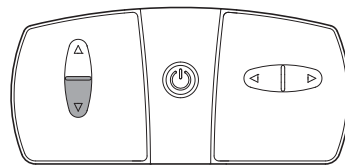
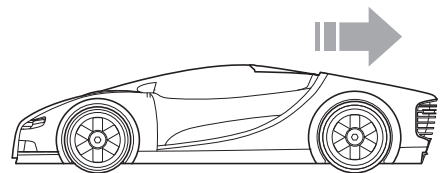

Turn Left

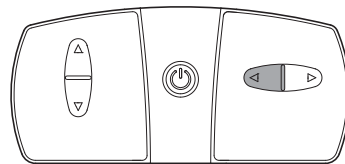
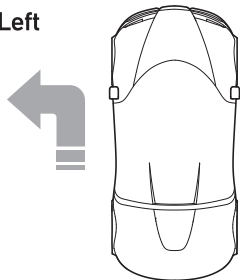

Turn Right

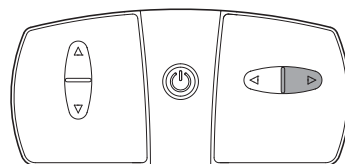
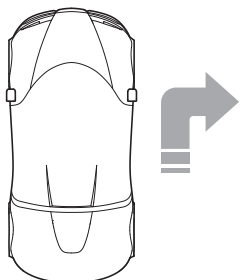

SAFETY PRECAUTIONS

- For indoor use only. Avoid water when operating.
- Do not submerge car or controller in water.
- Do not use people or animals as obstacles
- Do not run car into furniture objects or hard surfaces as this will cause damage to both the objects and car.
- Keep fingers, hair and loose clothing away from the tires, gears and motor while car is switched to "ON".
- Do not leave car or transmitter near sources of heat or under direct sunlight for long periods of time.
- Remove all batteries when not in use to avoid accidental operation.
- Adult supervision is recommended when operating car.
- Thoroughly inspect products before every use. If the product appears worn, frayed/splintered, cracked, or broken in any manner, discontinue use and discard immediately.

BATTERY WARNING:

- Do not mix old and new batteries.
- Do not mix alkaline, standard (carbon-zinc), or rechargeable batteries.
- Alkaline batteries are recommended. Use only the specified voltage.
- Insert batteries using the correct polarity. Always use, replace, and recharge (if applicable) batteries under adult supervision.
- Do not charge with non-rechargeable batteries.
- Do not short-circuit the battery supply terminals.
- Do not dispose of batteries in a fire, batteries may explode or leak.
- Remove batteries before storing.
- Recycle or dispose of batteries according to federal, state, and local laws.
- Keep these instructions for future reference.

Warning: Changes or modifications not expressly approved by the party responsible for compliance could void the user's authority to operate the equipment.

NOTE: This equipment has been tested and found to comply with the limits for a Class B digital device, pursuant to Part 15 of the FCC Rules. These limits are designed to provide reasonable protection against harmful interference in a residential installation. This equipment generates, uses and can radiate radio frequency energy and, if not installed and used in accordance with the instructions, may cause harmful interference to radio communications.

However, there is no guarantee that interference will not occur in a particular installation. If this equipment does cause harmful interference to radio or television reception, which can be determined by turning the equipment off and on, the user is encouraged to try to correct the interference by one or more of the following measures:

- Reorient or relocate the receiving antenna.
- Increase the separation between the equipment and receiver.
- Connect the equipment into an outlet on a circuit different from that to which the receiver is connected.
- Consult the dealer or an experienced radio/TV technician for help.

This device complies with Part 15 of the FCC Rules. Operation is subject to the following two conditions: (1) this device may not cause harmful interference, and (2) this device must accept any interference received, including interference that may cause undesired operation.

KEEP THIS INSTRUCTION MANUAL AS IT CONTAINS IMPORTANT INFORMATION FOR FUTURE REFERENCE.

Due to continuous product improvements, the pictures on the manual may differ slightly from the actual product.

The artwork and design of this manual are protected by US copyright law and may not be reproduced, distributed, displaced, published or used for any purpose without prior written permission. Altering, removing or reproducing any of the trademark or copyright notices on this package is not permitted.

FAO® and FAO Schwarz® names and logos are trademarks or registered trademarks. All rights reserved. www.fao.com

Distributed by and ©2018 MerchSource, LLC. Irvine, CA 92618.

For customer support please call 1-888-987-6533.

Printed in China

WARNING: CHOKING HAZARD - Small parts. Not for children under 3 years.