

<p>DO NOT MIX ALKALINE, STANDARD (CARBON ZINC) OR RECHARGEABLE (NICKEL CADMIUM) BATTERIES.</p> <p>DO NOT MIX OLD AND NEW BATTERIES.</p> <p>DO NOT DISPOSE OF BATTERIES IN FIRE, BATTERIES MAY EXPLODE OR LEAK.</p>	<p>WARNING: CHOKING HAZARD-Small parts, Not for children under 3 years.</p> <p>PLEASE DO NOT RETURN TO STORE For more information please email Consumer Services: help@hypertoys.com</p> <p>COLORS AND DECORATIONS MAY VARY, KEEP CONTENT DETAILS FOR FUTURE REFERENCE.</p>
---	---

This device complies with Industry Canada licence-exempt RSS 210 standard. Operation is subject to the following two conditions: (1) this device may not cause interference, and (2) this device must accept any interference, including interference that may cause undesired operation of the device.

Battery Safety Information:

- Ensure that battery polarity is correct.
- Use only batteries of the type recommended (or equivalent).
- Do not mix old and new batteries.
- Do not mix alkaline, standard (carbon-zinc), or rechargeable (nickel-cadmium) batteries.
- Rechargeable batteries are to be recharged by Adult only.
- Remove used-up batteries immediately.
- Do not recharge non-rechargeable batteries.
- Do not short-circuit terminals.
- Dispose of batteries safely. Do not dispose of batteries (or products containing non-rechargeable batteries) in fire, as batteries may explode or leak.



This device complies with the Part 15 of the FCC rules. Operation is subject to the following two conditions: (1) This device may not cause harmful interference, and (2) this device must accept any interference received, including interference that may cause undesired operation.

Caution: changes or modifications not expressly approved by the party responsible for compliance could void the user's authority to operate the equipment.

NOTE: This equipment has been tested and found to comply with the limits for a Class B digital device, pursuant to Part 15 of the FCC Rules. These limits are designed to provide reasonable protection against harmful interference in a residential installation. This equipment generates, uses and can radiate radio frequency energy and, if not installed and used in accordance with the instructions, may cause harmful interference to radio communications. However, there is no guarantee that interference will not occur in a particular installation. If this equipment does cause harmful interference to radio or television reception, which can be determined by turning the equipment off and on, the user is encouraged to try to correct the interference by one or more of the following measures: Reorient or relocate the receiving antenna. Increase the separation between the equipment and receiver. Connect the equipment into an outlet on a circuit different from that to which the receiver is connected. Consult the dealer or experienced radio/TV technician for help.



<p>DISTRIBUTED BY: HYPER TOY COMPANY 1-866-204-9737 Toll Free 177 Malaga Park Dr. Malaga, NJ 08328</p>		<p>DISTRIBUÉ PAR: HYPER TOY COMPANY 1-866-204-9737 Numéro de téléphone sans frais ou 177 Malaga Park Dr. Malaga, NJ 08328</p>
--	--	---

© Copyright 2021 HyperToys

©Tous droits réservés 2021. Hyper Toy Company

MADE IN CHINA

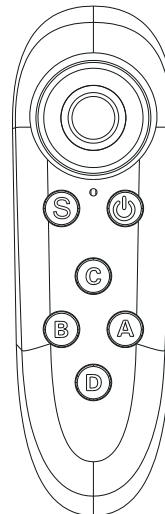
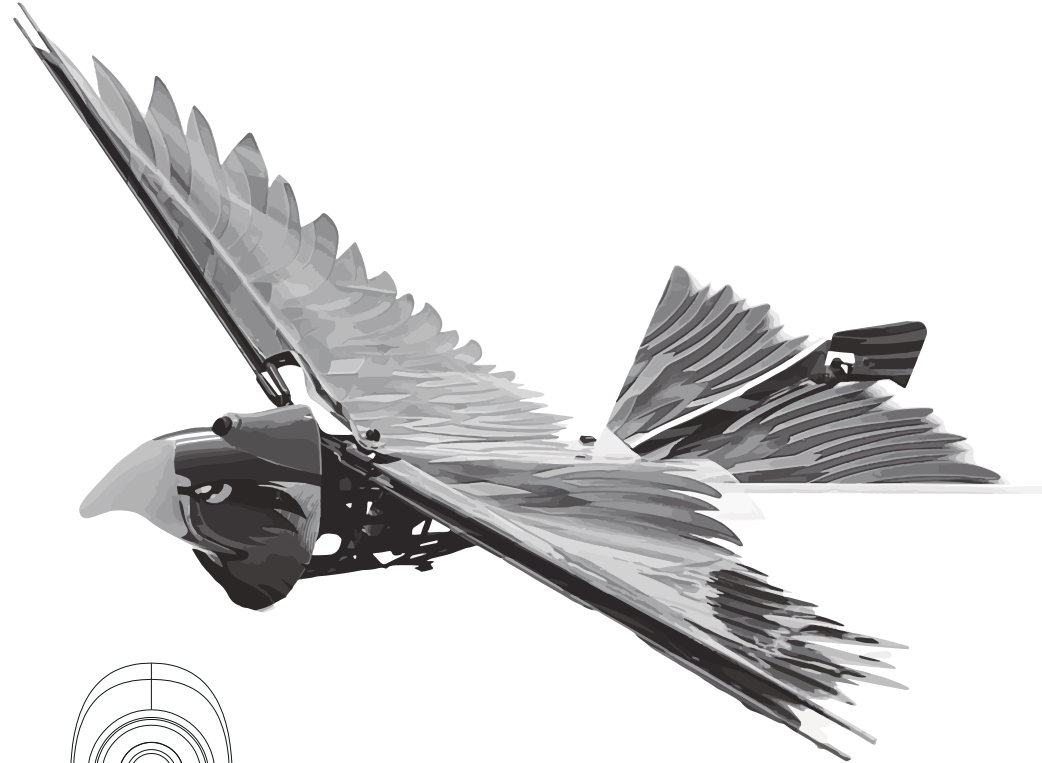

2.4 GHz



8+



**LITHIUM BATTERY
USB CHARGER**

CONTENTS

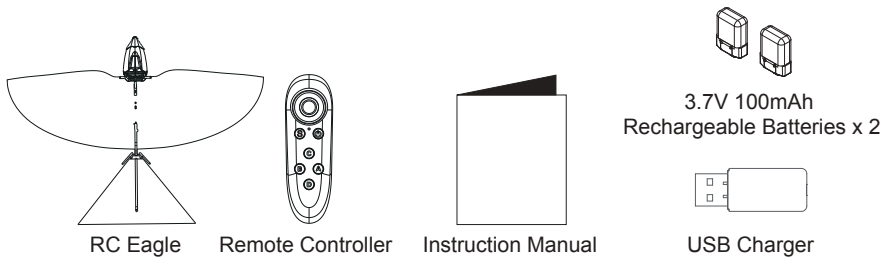

BATTERY INSTALLATION

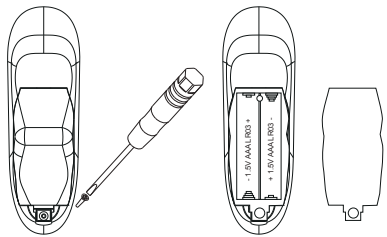

Back of Remote Controller

- 1) Unscrew on the battery cover by screwdriver and remove the battery cover.
- 2) Put 2 1.5V AAA batteries in the battery slots with correct polarity.
- 3) Slide the battery cover back to the remote controller and tighten the screw.

Charging Battery: 20 mins

- 1) Connect Battery to the USB charger.
- 2) Connect USB charger to power source.

Green Indicators light:
Flashing: Remote Controller Pairing.
Light On: Remote Controller Paired.

Installing Battery to RC Eagle:

- 1) Unscrew the Bolt on the bottom of the RC Eagle.
- 2) Slide the Battery in the battery slot and connect it to the RC Eagle.
- 3) Tighten the bolt until the battery cannot slide out.

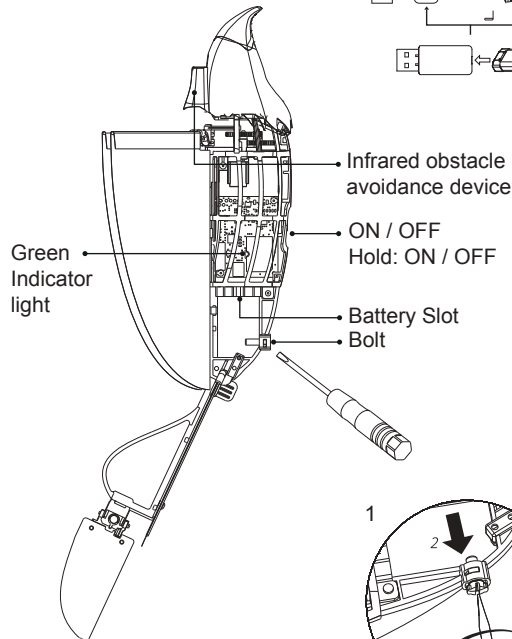

Side of RC Eagle

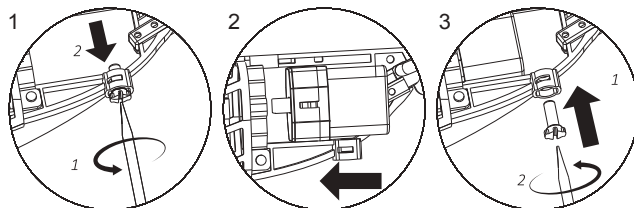

FUNCTIONS

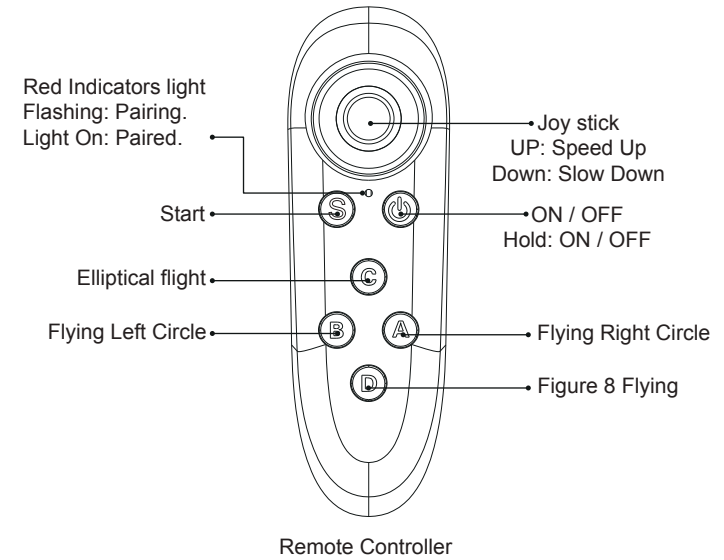

Remote controller and RC Eagle will turn OFF automatically when it idle over 12 minutes.

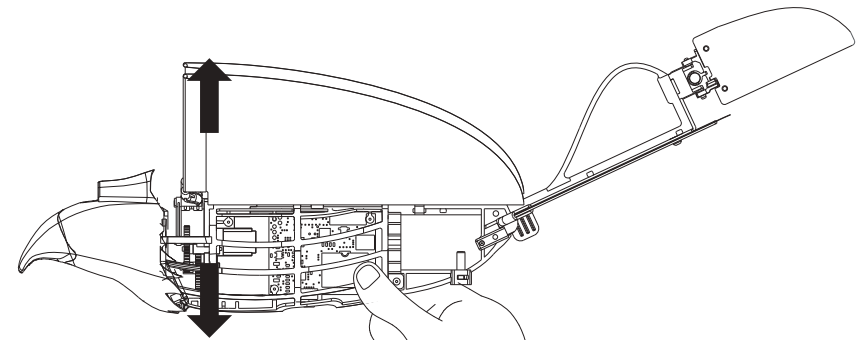

To Start Playing:

- 1) Turn on the remote controller and RC Eagle.
- 2) Push Joy stick UP and DOWN to pair.
- 3) Press Start button or gently move RC Eagle UP and DOWN by hand until wings start flapping.
- 4) Gently throw RC Eagle forward to begin Fly.

To End Playing:

- 1) Put RC Eagle up side down until wings stop flapping.
- 2) Turn off the remote controller and RC Eagle.

RC Eagle has altitude sensor, so it flies in the same altitude all the time.