

Battery Safety Information:

- Insure that battery polarity is correct.
- Use only batteries of the type recommended (or equivalent).
- Do not mix old and new batteries.
- Do not mix alkaline, standard (carbon-zinc), or rechargeable (nickel-cadmium) batteries.
- Rechargeable batteries are to be removed from the product before being charged.
- Rechargeable batteries are to be recharged by Adult only.
- Remove used-up batteries immediately.
- Do not recharge non-rechargeable batteries.
- Do not short-circuit terminals.
- Dispose of batteries safely. Do not dispose of batteries (or products containing non-rechargeable batteries) in fire, as batteries may explode or leak.

⚠ WARNING

There are small parts inside possibly causing a choking hazard, so the product isn't suitable for children 3 years old and below. When the product is being used, an adult must be on the scene for guardianship and guidance. These instructions have important information and thus shouldn't be discarded randomly. They should be kept properly for future inquiry.



This device complies with the Part 15 of the FCC rules. Operation is subject to the following two conditions: (1) This device may not cause harmful interference, and (2) this device must accept any interference received, including interference that may cause undesired operation.

Caution: changes or modifications not expressly approved by the party responsible for compliance could void the user's authority to operate the equipment.

NOTE: This equipment has been tested and found to comply with the limits for a Class B digital device, pursuant to Part 15 of the FCC Rules. These limits are designed to provide reasonable protection against harmful interference in a residential installation. This equipment generates, uses and can radiate radio frequency energy and, if not installed and used in accordance with the instructions, may cause harmful interference to radio communications. However, there is no guarantee that interference will not occur in a particular installation. If this equipment does cause harmful interference to radio or television reception, which can be determined by turning the equipment off and on, the user is encouraged to try to correct the interference by one or more of the following measures: Reorient or relocate the receiving antenna. Increase the separation between the equipment and receiver. Connect the equipment into an outlet on a circuit different from that to which the receiver is connected. Consult the dealer or experienced radio/TV technician for help.



Made in China

ITEM NO.: 579806691

HYPER TOY

DRIFT CLIMBING KING

BC



**HORIZONTAL
SLANT/DRIFTING**

2.4 GHz
FULL FUNCTION

Move forward, move backward, turn left,
turn right, body rise and fall, rotate at 360°
horizontal/slant drifting, dance, sound, fire
programming, cool light.



1 Batteries and Instructions for charging

- (1) The remote control unit is equipped with two 1.5V AA non-rechargeable batteries (Battery need additional purchase).

Battery loading:

- Loosen the screws on the battery door with cross screwdrivers. (Phillips screwdriver need additional purchase)
- Load the new 1.5V AA batteries corresponding the "+" and "-" in the battery case to the "+" and "-" of the batteries.
- Cover up the battery cover, and tighten the screws.

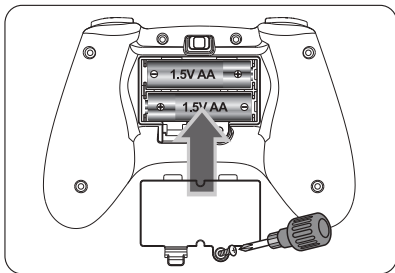

(2) Charging mode of USB cable

- Take out the rechargeable battery from the product as shown in the diagram. (Phillips screwdriver need additional purchase)
- Put the USB connector into the USB interface of the computer, after which the red charge lamp of the USB will be on; then, insert the lithium battery plug into the USB charging plug, after which the green charge indicator light of the USB will flicker; after full charging is completed within about 180 minutes, the green charge indicator light will be on long, which indicates charging complete and the product will work in 5 minutes. Overcharging may damage the batteries, cause burnings or catch a fire.

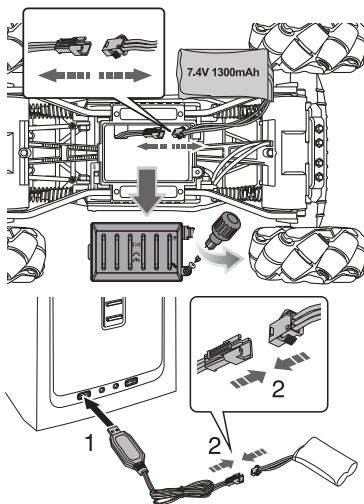

⚠ Notice:

When the product is idle, please push its power switch to "OFF", and take out the batteries in case the service life of the rechargeable batteries is affected.

c) Load the battery pack in the battery case by corresponding to the correct electrodes, and cover up the battery cover. (Phillips screwdriver need additional purchase)

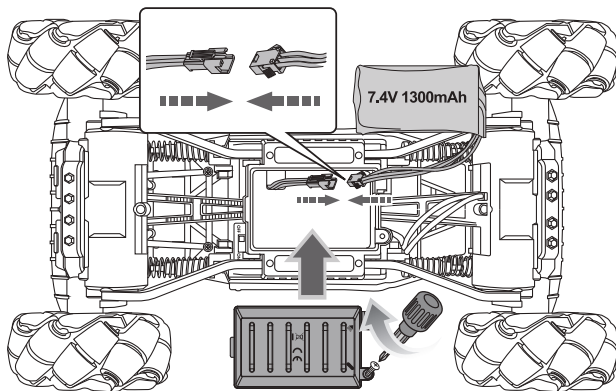

2 Battery Warning

- Do not mix alkaline, standard(carbon zinch), rechargeable(nickel hydride) batteries.
- Do not mix old and new batteries.
- Non-rechargeable batteries should not be recharged.
- Rechargeable batteries should be removed from the appliance before being charged.
- Rechargeable batteries should be charged under adult supervision only.
- Exhausted batteries should be removed.
- The supply terminals should not be short-circuited.
- Only batteries of the same or equivalent type are recommended to be used.
- Batteries should be inserted with the correct polarity.

Rechargeable batteries are to be removed from the toy before being charged; The packaging or instruction shall include a statement that the charger to be used with the sample should be regularly examined for potential hazard, such as damage to the cable or cord, plug, enclosure of other parts and that in the event of such damage, the sample must not be used until that damage had been properly removed.

3 Description of functions of remote controller

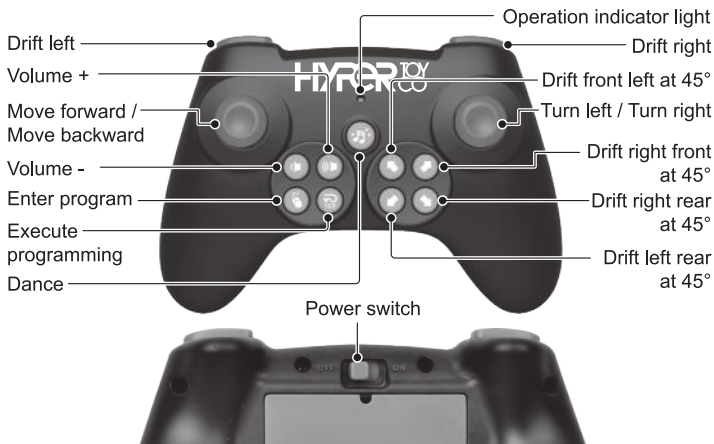

4 Demonstration and description of functions

Turn on the power: Turn the power switch of the remote controller and remote control car to the "ON" position, the power will be switched on, and the operation indicator light of the remote controller will be off, which means that the frequency pairing is completed.

Remote control distance: No less than 30m. Using time: Up to 25 to 35 minutes under a full charging state.

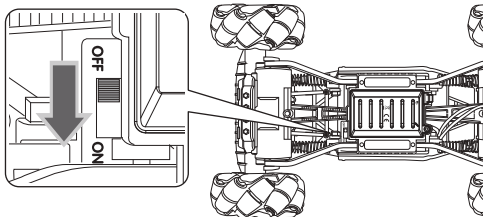

Notice:

The remote control car cannot be controlled, close remote control power supply first. Then, Power off the remote control car, and then power it on. Finally, pull the control lever of the remote controller to conduct frequency pairing again.

1. Move forward / Move backward

Push upwards/Pull backwards the left control lever, so the remote control car will move forwards/backwards; continually push upwards/pull backwards the left control lever, so the remote control car will continually move forwards/backwards.

Move forward / Move backward

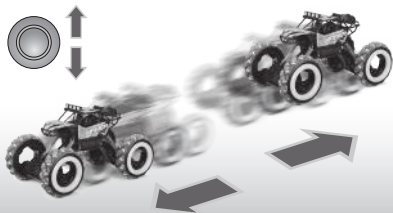

2. Turn left/Turn right

Push left/Push right the right control lever, so the remote control car will turn left/turn right; continually push left/push right the right control lever, so the remote control car will continually turn left/turn right.

Turn left/Turn right

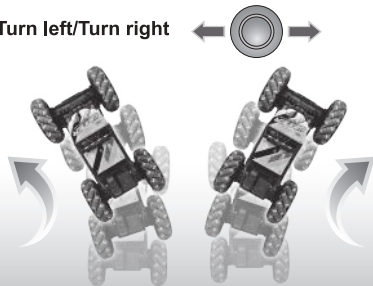

3. Dance

When the "🎵" key is pressed once, music will be played and at the same time the remote control car will start to automatically dance; when the "🎵" key is pressed again, the next dance music is switched to automatically. There is a total of 3-5 pieces of dance music

Dance



4. Drift front left at 45°

When the "  " key is pressed once, the remote control car will drift at 45° front left; when it is pressed and held, the remote control car will drift front left at 45° all the time.

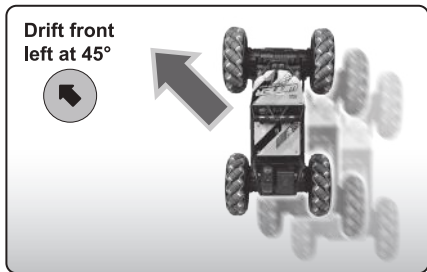

5. Drift right front at 45°

When the "  " key is pressed once, the remote control car will drift at 45° front right; when it is pressed and held, the remote control car will drift front right at 45° all the time.

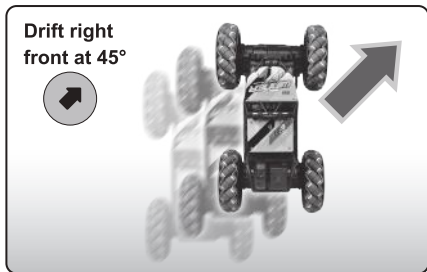

6. Drift left rear at 45°

When the "  " key is pressed once, the remote control car will drift at 45° left rear; when it is pressed and held, the remote control car will drift left rear at 45° all the time.

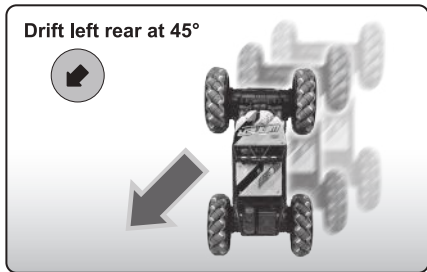

7. Drift right rear at 45°

When the "  " key is pressed once, the remote control car will drift at 45° right rear; when it is pressed and held, the remote control car will drift at 45° right rear all the time.

Drift right rear at 45°

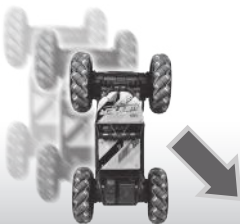

8. Drift left

When the "  " key is pressed once, the remote control car will drift left; when it is pressed and held, the remote control car will drift left all the time.

Drift left





9. Drift right

When the "  " key is pressed once, the remote control car will drift right; when it is pressed and held, the remote control car will drift right all the time.

Drift right



10. Enter program



When the "" key is pressed once, the remote control car will make a prompt sound, and the "Move forward, Move backward, Turn left, Turn right, Drift left, Drift right, Drift front left at 45°, Drift right front at 45°, Drift left rear at 45°, Drift right rear at 45°" keys on the remote controller can be input as commands. Press the "" key again to execute the programming action on the remote control car.

(16 commands can be input at most. Programming automatically starts after the actions are full.)



11. Execute programming

Press the "" key again to execute the programming action on the remote control car.

12. Volume +

Short press the "" key, the remote control vehicle sends out a reminder sound: "drop"; continuous press the "" button, the remote control vehicle sends out a reminder sound more and more loud.

13. Volume -

Short press the "" key, the remote control vehicle sends out a reminder sound: "drops"; continuous press the "" button, the remote control vehicle sends out a reminder sound more and more quiet.

WARNING

There are small parts inside possibly causing a choking hazard, so the product isn't suitable for children 3 years old and below. When the product is being used, an adult must be on the scene for guardianship and guidance. These instructions have important information and thus shouldn't be discarded randomly. They should be kept properly for future inquiry.

5 Solutions to problems

Problem	Cause	Processing Method
The remote control fails to function.	1. Make the on/off stay at the "OFF"position.	1. Make the on/off stay at the "ON" position.
	2. Fail to put the battery into the right electrodes.	2. Check and make sure that the battery is put in according to the signs of the electrodes on the battery box.
	3. Low battery.	3. Replace with new batteries.
	4. Out of the controllable distance.	4. Keep the remote control within 30 meter and point at the remote control car.
	5. No pairing frequency between the remote controller and remote control car	5. Close remote control power supply first. Then, power off the remote control car, and then power them on. Finally, pull the control lever of the remote controller to conduct frequency pairing again.
The remote control car cannot be controlled	1. Make the on/off stay at the "OFF"position.	1. Make the on/off stay at the "ON" position.
	2. The remote control car and rechargeable battery pack haven't been connected by correctly corresponding with the electrodes.	2. Check and make sure that the battery pack is connected to the remote control car according to the right electrodes.
	3. Low battery.	3. Recharge or replace the battery pack when it is running low.
	4. The remote control car has unclear voice and dark light.	4. Recharge or replace the battery pack when it is running low.
	5. The remote controller and remote control car haven't undergone frequency pairing	5. Close remote control power supply first. Then, power off the remote control car, and then power them on. Finally, pull the control lever of the remote controller to conduct frequency pairing again.